

SHIELD Tablet User Guide

Table of Contents

Introduction.....	1
NVIDIA Apps.....	1
DirectStylus Launcher	1
NVIDIA Dabblar	1
NVIDIA Lasso Capture	1
NVIDIA TegraZone.....	1
Additional Apps	2
Adobe Reader by Adobe.....	2
Camera Awesome by SmugMug	2
ES File Explorer by ES APP Group	2
Evernote by Evernote Corporation	2
JusWrite by Plackal Tech.....	2
Write by Stylus Labs.....	2
SHIELD Tablet with DirectStylus	3
Front View	3
Rear View	5
How to Charge Your SHIELD Device	7
How to Turn On Your Tablet.....	8
How to Use the Touchscreen	8
How to Complete NVIDIA Setup.....	8
How to Complete Android Setup.....	9
How to Turn Off Your Tablet.....	10

How to Restart Your Tablet.....	10
Manage Your Tablet	11
Navigation Overview	11
How to Connect to Wi-Fi.....	12
How to Connect Through Wi-Fi Protected Setup.....	13
How to Scan for Available Wi-Fi Networks.....	14
How to Remove a Wi-Fi Network Connection.....	14
Stylus Behavior.....	15
How to Enable Access to Stylus-Only Mode	15
How to Use Stylus-Only Mode.....	15
How to Optimize Palm Rejection for Your Writing Style.....	16
How to Adjust the Stylus for Left-Handed Use.....	17
How to Show or Hide the Draw Cursor.....	17
Stylus Apps	17
How to Use DirectStylus Launcher for Quick Access to Apps.....	17
How to Open DirectStylus Launcher Automatically When the Stylus Is Removed	18
How to Open an App Automatically When the Stylus Is Removed.....	18
How to Prevent Apps from Opening Automatically When the Stylus Is Removed.....	19
How to Open Settings	19
Sounds.....	20
How to Turn Touch Sounds On and Off.....	20
Display	20
How to Adjust Display Brightness	20

How to Change the Wallpaper	21
How to Change the System Font Size.....	21
How to Change the Color Correction Preset.....	22
Power Saving	22
How to Change the Sleep-Mode Interval.....	22
How to Manage Processor Performance.....	23
How to Reduce Background App Power Usage.....	23
Home Screen.....	24
How to Create Home Screen Pages	24
How to View Home Screen Pages	24
Apps and Widgets.....	25
How to Add Apps to the Home Screen.....	25
How to Move Apps Around the Home Screen	25
How to Add Apps to the Favorites Tray.....	25
How to Remove Apps from the Favorites Tray.....	26
How to Add Widgets to the Home Screen.....	26
Folders.....	26
How to Create Folders to Group Apps Together	26
How to Rename a Folder	27
How to Open Apps That Are in a Folder	27
SD Card.....	27
How to Change the Notification Sound	28
How to View or Hide Notification Details	28

How to Clear a Notification	29
How to Clear All Notifications	29
Google Keyboard (Alphabet).....	31
Google Keyboard (Numbers and Symbols).....	31
How to Insert Emoticons or Emoji Characters	32
How to Enter Letter Accents and Variations	33
How to Use Gesture Typing	33
How to Use Voice Typing	34
How to Disable Voice Typing	35
How to Allow Offensive Words	36
How to Add Languages	36
How to Use Offline Voice Typing.....	36
System Bar Status Icons.....	37
How to View Device Status Details.....	38
How to Lock Your Tablet.....	38
How to Unlock Your Tablet	39
How to Set a Screen Lock.....	39
Screen Lock Options.....	39
None.....	39
Slide	39
Face Unlock	40
Pattern	40
PIN	41

SHIELD Tablet User Guide

Password	42
How to Install Updates.....	43
Play Games	45
How to Open TegraZone	45
How to Turn On or Turn Off TegraZone Notifications.....	45
How to Connect a SHIELD Wireless Controller to Your Tablet	46
How to Find Controller Games.....	46
How to Add Controller Support to Touchscreen Games	47
How to Create a Custom Gamepad Mapper Profile	47
How to Connect Your Device to an HDTV	48
How to Record and Share Your Gameplay.....	49
How to Record Your Gameplay Without Sharing.....	50
How to Set the Video Quality.....	51
How to Find Your Gameplay Videos	51
How to Record Your Gameplay Automatically.....	51
How to Turn On Automatic Recording	52
How to Save and Share Automatically Recorded Video	52
How to Stop or Save Automatically Recorded Video Without Sharing.....	52
How to Set the Maximum Video Length for Automatic Recording.....	53
How to Mute the Microphone for Gameplay Videos	53
How to View Recording and Broadcasting Status.....	54
How to Create a Twitch Account.....	55
How to Connect Your Tablet to Twitch	56

How to Broadcast Your Gameplay to Twitch.....	56
How to Stop Broadcasting	57
How to Share Your Broadcast	57
How to Apply the Recommended Quality and Server Settings.....	57
How to Change the Twitch Server.....	58
How to Pause Broadcasting Automatically When You Switch Apps	59
Extend Your Tablet.....	61
Bluetooth Behavior	61
How to Turn Bluetooth On or Off	61
How to Set the Bluetooth Visibility Timeout	61
Bluetooth Accessories.....	62
How to Pair a Bluetooth Accessory with Your Device	62
How to Disconnect a Bluetooth Accessory from Your Device	63
How to Rename Your Bluetooth Accessory in the Paired Devices List.....	63
Recommended MicroSD Card Class	65
Required MicroSD Card Formats	65
How to Insert a MicroSD Card	65
How to Unmount and Eject a MicroSD Card	65
How to Move Content to a MicroSD Card	66
How to View MicroSD Card Storage	66
How to Install a Micro-SIM Card.....	67
How to Remove a Micro-SIM Card.....	67
How to Enable Access to Lasso Capture	69

SHIELD Tablet User Guide

How to Open Lasso Capture	69
Captures	69
How to Capture a Screenshot of the Whole Screen	70
How to Capture a Rectangular Region	70
How to Capture a Free-Hand Region.....	70
How to Share a Capture	71
How to Save a Capture to PDF	71
How to Take a Full-Screen Screenshot Without the Stylus.....	72
How to Open NVIDIA Dabblers	73
Learn the NVIDIA Dabblers Workspace	73
Manage.....	74
How to View the NVIDIA Dabblers Help Tips	74
How to Undo or Redo the Previous Action	75
How to Save Your Work.....	75
How to Show or Hide the Toolbar	75
How to Show or Hide the Tray and Palette	75
Create Artwork.....	76
NVIDIA Dabblers Painting Styles	76
NVIDIA Dabblers Tools	76
How to Adjust Brush Styles.....	77
How to Mix Colors	77
How to Select RGB Colors	78
How to Use Shape Recognition	78

How to Use Gravity 78

How to Dry Your Watercolor Instantly 79

How to Adjust the Water Level 79

How to Lock the Water Level..... 80

Background and Canvas 80

 How to Select a Background Image..... 80

 How to Select a Canvas Texture..... 81

 How to Clear the Canvas 81

NVIDIA 83

Regulatory..... 83

United States 85

 Federal Communications Commission (FCC)..... 85

 Underwriters Laboratories (UL) 86

 California Energy Commission (CEC) 86

Canada..... 87

 Industry Canada (IC)..... 87

INTRODUCTION

Thank you for choosing the NVIDIA® SHIELD™ Tablet.

Your NVIDIA device is powered by the NVIDIA Tegra K1 mobile processor and the Google Android operating system. The included apps take full advantage of the NVIDIA Tegra K1's Kepler graphics core.

Your device also comes with several additional apps so you can get started right away -- surf the web, check your e-mail, take pictures, play games, and more.

NVIDIA Apps

DirectStylus Launcher

The DirectStylus Launcher provides quick access to apps that work well with a stylus. For more information, see [How to Use the Stylus](#).

NVIDIA Dabblers

NVIDIA® Dabblers™ is a drawing and painting app that provides watercolor, oil painting, and sketching capabilities. For more information, see [How to Use NVIDIA Dabblers](#).

NVIDIA Lasso Capture

NVIDIA® Lasso Capture provides a quick and easy way to take screenshots of all or part of your screen. You can also annotate and share the captures.

For more information, see [How to Use NVIDIA Lasso Capture](#).

NVIDIA TegraZone

NVIDIA® TegraZone™ is the place to find Android and PC games that are optimized for Tegra-powered devices, providing a console-quality gaming experience wherever you are. Read professional game reviews and view high-resolution screenshots, HD

videos, and behind-the-scenes footage. For more information, see [How to Find Games and Gaming News](#).

Additional Apps

Adobe Reader by Adobe

Adobe Reader allows you to view and annotate PDF files on your device. To learn more, visit [Adobe Reader](#) in the Google Play store.

Camera Awesome by SmugMug

Camera Awesome provides slow-motion video, enhanced HDR, and integrated stylus support in addition to a number of shooting and editing features. To learn more, visit [Camera Awesome](#) in the Google Play store.

ES File Explorer by ES APP Group

ES File Explorer is a file and application manager. Kill tasks, manage downloads, and store files in the cloud. ES File Explorer also allows you to access your media on other Android devices and computers. To learn more, visit [es File Explorer](#) in the Google Play store.

Evernote by Evernote Corporation

Evernote helps you remember things across all of your devices. Your notes, images, voice reminders, and lists are all searchable wherever you are, from any device. To learn more, visit [Evernote](#) in the Google Play store.

JusWrite by Plackal Tech

JusWrite is a handwriting-friendly organizational app. Use your stylus to write lists by hand. You can categorize and prioritize your lists, mark list items complete, and more. To learn more, visit [JusWrite](#) in the Google Play store.

Write by Stylus Labs

Write is a word processor for handwriting. Use your stylus to write, edit, sketch, organize, and bookmark handwritten documents on your tablet. To learn more, visit [Write](#) in the Google Play store.

This guide includes instructions and information about the NVIDIA features and apps that come with your NVIDIA device. In cases where there are multiple ways to accomplish a task, this document describes the most common procedure.

For help with the Android OS, please visit Google's support website at <http://support.google.com/android/>.

Google provides help for Android OS features and for Google apps such as Gmail, Google Keyboard, Google Plus, Google Play, Chrome, and YouTube.

For help with pre-installed and third-party apps, please visit the app's support website. Most apps include a Help button or an About button that provides a link to the app's support website.

The box includes one SHIELD tablet with DirectStylus™, one USB charging cable, and one Safety Guide.

SHIELD Tablet with DirectStylus

Front View

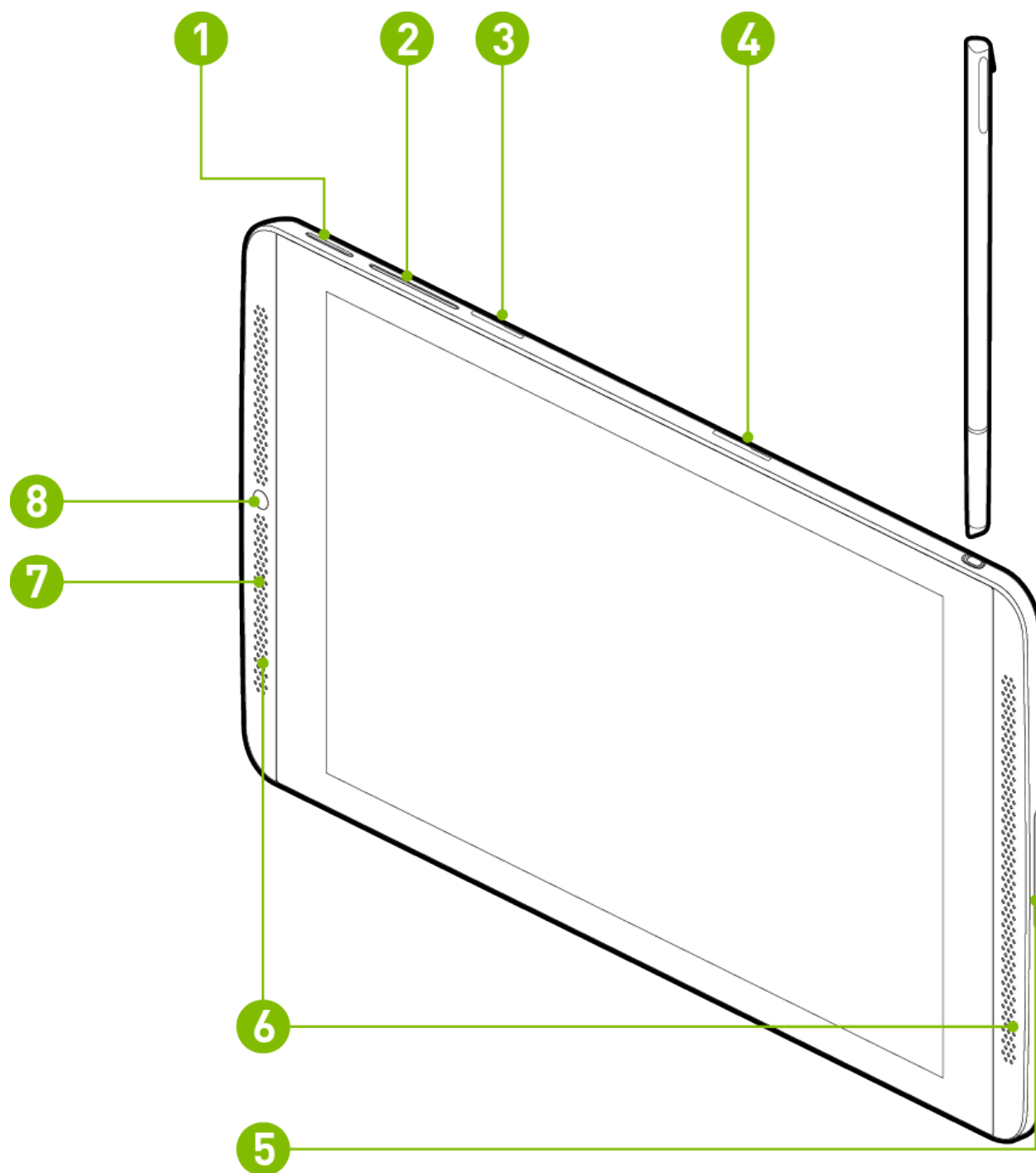

- 1 Power button
- 2 Volume button
- 3 MicroSD card slot
- 4 Micro-SIM card slot

- 5 Speaker
- 6 Speakers
- 7 Microphone (located behind the speaker grill)
- 8 Front camera

Rear View

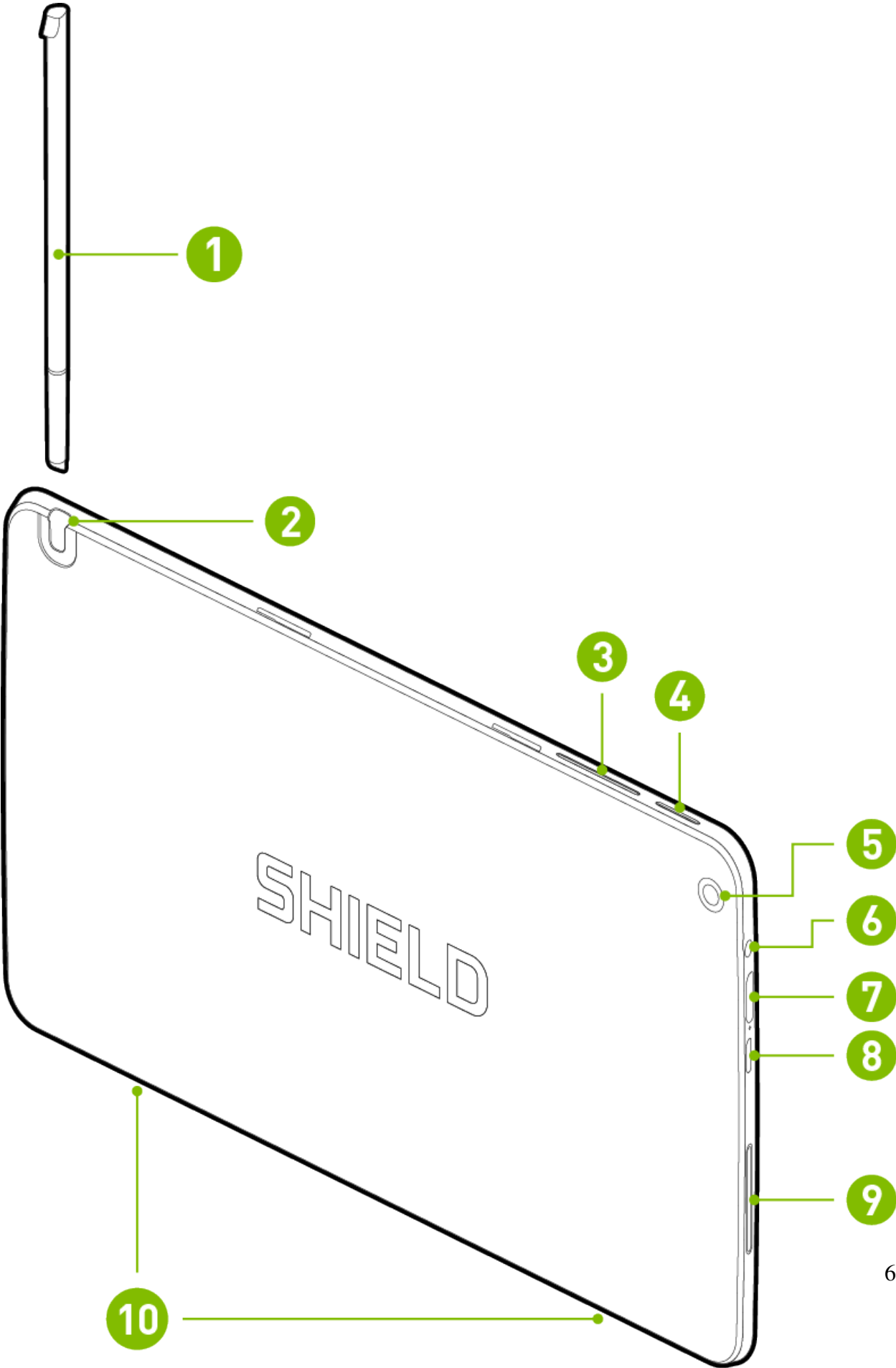

1	DirectStylus
2	Stylus holder
3	Volume button
4	Power button
5	Rear camera
6	Headphone jack (3.5 mm)
7	Mini-HDMI slot for connecting the tablet to an external display
8	Micro-USB slot for connecting the charger
9	Speaker
10	Magnetic slots for the snap-on cover. The cover is sold separately.

[Back to Top](#)

Your device should arrive with at least a 50 percent charge in the battery. However, if the battery levels are low or empty, we recommend that you charge your device for 2 hours before you begin the setup process.

How to Charge Your SHIELD Device

1. Plug the micro-USB end of the USB cable into the micro-USB slot of the device.
2. Plug the standard USB end of the USB cable into a USB power source, such as an AC adapter or a computer.

NOTE You may use the device while the device is plugged into your computer or a power outlet. However, when the device is in use, the charging time is extended.

[Back to Top](#)

How to Turn On Your Tablet

Press and hold the **Power** button until the screen turns on, and then release the button. It may take three or four seconds for the screen to turn on.

[Back to Top](#)

How to Use the Touchscreen

Use your fingertip or the stylus to perform these touchscreen gestures.

Tap	Tap an icon to perform an action. For example, tap the Maps icon to open Google Maps.
Double-tap	Tap twice quickly. Use double-tap to zoom a photo, webpage, map, or other content. Double-tap again to return to the original size. Not all apps support double-tap.
Tap and hold	Touch an icon and hold until the action occurs. For example, on the Home screen, touch an app icon until all of the icons begin to wiggle.
Drag	Touch and hold, and then move your finger to drag. For example, on the Home screen, touch an app icon until all of the icons begin to wiggle. Drag your finger to move the app icon to another area of the screen. When you lift your finger off the screen, the icon stays in its new position.
Swipe	Swipe your finger up, down, or across to move through lists, screens, photos, and other content. Do not pause while swiping. A pause may change the action from a swipe to a drag.
Pinch	Place two fingers on the screen, a few inches apart. Move the fingers together to zoom out. Not all apps support pinch.
Spread	Place two fingers on the screen, close together. Move the fingers apart to zoom in. Not all apps support spread.

How to Complete NVIDIA Setup

Turn on your device. Follow the prompts to select a language and to accept the NVIDIA Software License Agreement, Privacy Policy, and Tegra Experience Terms

of Service. For more information about these agreements and policies, see [SHIELD Legal](#).

[Back to Top](#)

How to Complete Android Setup

After you complete the NVIDIA setup process, the Android setup process begins automatically. Android prompts you to connect to Wi-Fi, enter your Google account, and set your initial preferences for location services and other features. You may change these preferences later in **Settings**. You must accept the Google terms of service.

NOTE If you do not already have a Google account, you can create one during the set up process. If you have multiple Google accounts, you can add other accounts later in **Settings**.

You may use your NVIDIA device without signing in to a Google account. However, you must have a Google account to use Google mobile services.

Your Google account is the e-mail address and password that you use to log into Gmail, YouTube, Google Drive, and other Google services.

Your Google account enables the following features:

- Synchronize and back up your e-mail, calendar events, contacts, messages, and other data across devices.
- Use Google Play to purchase and access movies, TV shows, books, music, magazines, and apps.
- Connect to Google Wallet.
- Secure your personal data.

[Back to Top](#)

How to Turn Off Your Tablet

1. Press and hold the **Power** button for three seconds. The device control panel opens.
2. Tap the **Power Off** icon.

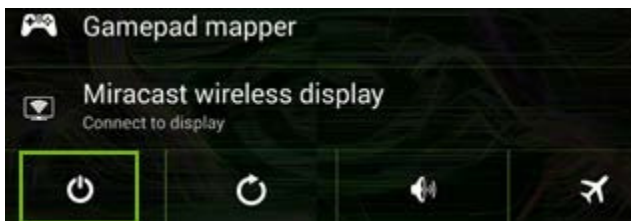

NOTE You can also hold the power button for 4 seconds to turn off the device.

[Back to Top](#)

How to Restart Your Tablet

1. Press and hold the **Power** button for three seconds. The device control panel opens.
2. Tap the **Restart** icon.

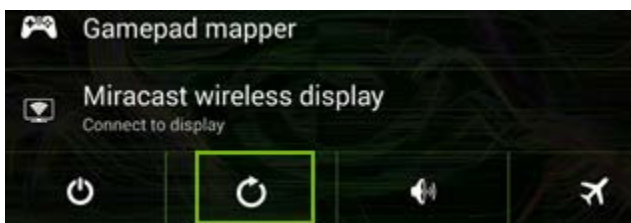

3. At the prompt, tap **Restart**.

NOTE You can also hold the power button for 12 seconds to restart the device.

[Back to Top](#)

MANAGE YOUR TABLET

Your NVIDIA device supports standard Android navigation, such as the Notification shade and the Favorites bar.

This guide includes instructions for the most common navigation elements. Most of the elements are standard with the Android operating system.

For help with the Android OS, please visit Google's support website at <http://support.google.com/android/>.

Navigation Overview

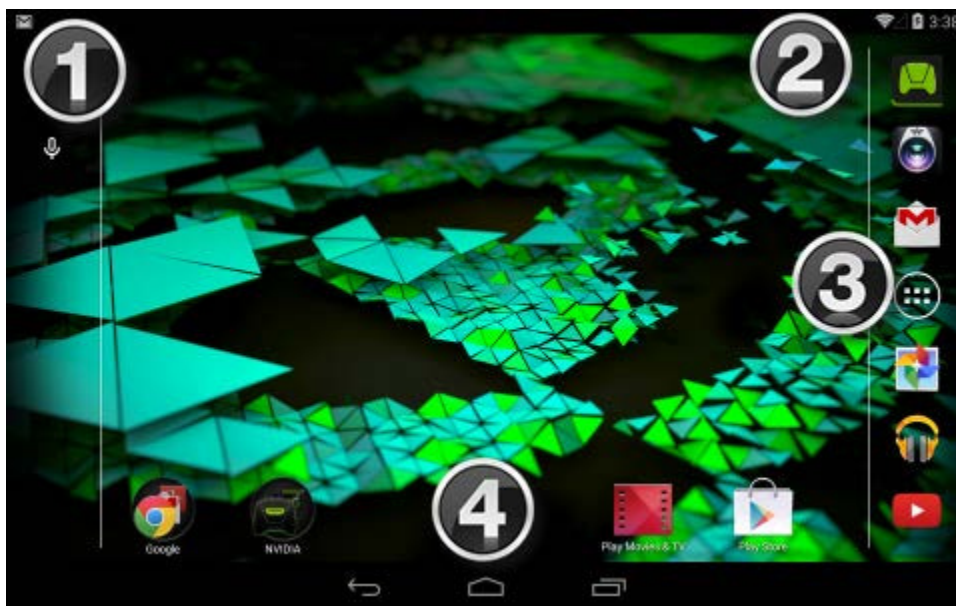



- | | |
|----------|---|
| 1 | Notification bar. Notification icons show that you have new e-mail, calendar events, alarms, and other notifications. Swipe down to view details in the Notification shade. |
| 2 | System bar. System icons show the battery level, Wi-Fi signal strength, battery level, Bluetooth connectivity, and other statuses. For more information, see How to View Device Status .

Swipe down from the System bar to view the Quick Settings shade. For more information, see How to Use Quick Settings . |

3 **Favorites.** The Favorites tray provides quick access to up to six apps. The Favorites tray is visible on all Home pages. For more information, see [Organizing Your Apps](#).

4 **Navigation bar.** These icons provide common navigation functions, such as return to the previous screen, open the main Home screen, and view recently opened apps.

 **Back.** Tap to return to the previous screen.

 **Home.** Tap to return to the main Home screen.

 **Recents.** Tap to view apps that are currently open, in order of recent use.

NOTE If the Navigation bar is hidden, swipe up from the bottom of the screen to open it. Some apps hide the Navigation bar to provide you with a full-screen experience. The Navigation bar also hides after a period of disuse.

Your device scans automatically for available Wi-Fi networks and connects to known networks when you are within range.

The Android operating system provides several options for connecting to Wi-Fi. This section describes the most common options.

For help with the Android OS, please visit Google's support website at <http://support.google.com/android/>.

How to Connect to Wi-Fi

1. Go to **Settings > Wireless & Networks > Wi-Fi**. Wi-Fi settings are also available on the Quick Settings shade. For more information, see [How to Use Quick Settings](#).



2. If Wi-Fi is set to **OFF**, tap the **ON/OFF**  switch to turn it on.

When Wi-Fi is on, the **ON/OFF** switch shows **ON** .

3. Tap **Wi-Fi**. The Wi-Fi control panel shows the wireless networks that are in range and indicates their signal strength. The control panel also shows any wireless networks that your device has connected to in the past. If you are already connected to Wi-Fi, the name and signal strength of the current Wi-Fi network are shown.
4. In the Wi-Fi control panel, select the network that you want to connect to.
5. If prompted, enter the password and tap **Connect**.



[Back to Top](#)

How to Connect Through Wi-Fi Protected Setup

1. Go to **Settings > Wireless & Networks > Wi-Fi**.
2. If Wi-Fi is set to **OFF**, tap the **ON/OFF**  switch to turn it on.
When Wi-Fi is on, the **ON/OFF** switch shows **ON** .
3. Tap **Wi-Fi**.
4. Tap the **Wi-Fi Protected Setup** icon .
5. When prompted, press the **Wi-Fi Protected Setup** button on your router.

[Back to Top](#)



How to Scan for Available Wi-Fi Networks

1. Go to **Settings > Wireless & Networks > Wi-Fi**.
2. If Wi-Fi is set to **OFF**, tap the **ON/OFF**  switch to turn it on.
When Wi-Fi is on, the **ON/OFF** switch shows **ON** .
3. Tap **Wi-Fi**.
4. In the Wi-Fi control panel, tap the menu  icon. The menu opens.
5. Tap **Scan**. A list of available networks appears.

[Back to Top](#)

How to Remove a Wi-Fi Network Connection

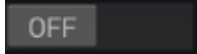
When you remove a Wi-Fi network connection, the network may still appear in the list if you are within signal range. To connect to the network again, tap the network.

1. Go to **Settings > Wireless & Networks > Wi-Fi**.
2. If Wi-Fi is set to **OFF**, tap the **ON/OFF**  switch to turn it on.
When Wi-Fi is on, the **ON/OFF** switch shows **ON** .
3. Tap **Wi-Fi**.
4. In the Wi-Fi control panel, tap the network that you want to remove. The network window opens.
5. Tap **Forget**.

[Back to Top](#)

Your tablet includes the NVIDIA DirectStylus™. This stylus enables precise control of handwriting, drawing, and touchscreen games that require pinpoint accuracy.

The stylus has a chisel tip, similar to the tip of a highlighter pen. For fine lines, touch with the pointed tip. For thick lines, touch with the full width of the chisel.

NOTE Some apps do not support variable line thickness. In those apps, the stylus produces the same line thickness, regardless of which part of the tip you use.

When the tablet is in stylus-only mode, the touchscreen only responds to input from the stylus. Touches from your finger or palm are ignored.

[Back to Top](#)

Stylus Behavior

How to Enable Access to Stylus-Only Mode

Before you can use stylus-only mode, you must enable access in the settings.

1. Go to **Settings > DirectStylus**.
2. Under Stylus-Only Mode and Lasso Capture, select the **Quick access via navigation bar** check box.

[Back to Top](#)

How to Use Stylus-Only Mode

Before you can use stylus-only mode, you must enable access in the settings. For more information, see [How to Enable Access to Stylus-Only Mode](#).

1. Remove the stylus from its holder.



2. In the Navigation bar, tap the **Stylus-Only Mode** icon.
3. To return to Touch Mode, tap the **Stylus-Only Mode** icon again.

NOTE Your NVIDIA device automatically disables stylus-only mode when you return the stylus to its holder. The device also disables stylus-only mode when you press the power button quickly to put the device to sleep. This allows you to continue using the touchscreen even if you left the device in stylus mode but do not have the stylus with you.

[Back to Top](#)

How to Optimize Palm Rejection for Your Writing Style

Your tablet includes good palm rejection technology. With palm rejection, the touchscreen responds only to the stylus while you are writing, even if you rest your hand on the screen while you write. When the stylus is not touching the screen, the touchscreen responds normally to your finger.

If your palm is sometimes misidentified when you reposition your hand on the screen, then you can change the DirectStylus pen-to-touch delay to optimize palm rejection for your writing style. Pen-to-touch delay temporarily suppresses non-stylus touches during and after stylus input. The default delay of 0.5 seconds works well for most users.

If you do a lot of stylus interactions with your palm on the screen, select a longer delay. If you do not put your palm on the screen and you switch quickly between stylus and finger inputs, select a shorter delay.

1. Go to **Settings > DirectStylus**.
2. Tap **Set timer to activate finger touch after pen use**.
 - To remove any delay, tap **Disable touch only during pen use**.
 - To add a delay, tap one of the delay options.

[Back to Top](#)

How to Adjust the Stylus for Left-Handed Use

Left-handed users tend to place their palm on the left side of the screen. In left-handed mode, the palm rejection algorithm rejects stray touch inputs from the left side of the screen.

1. Go to **Settings > DirectStylus**.
2. Under **Handedness**, tap **Left-handed** to select the check box. To return to right-handed mode, tap again to clear the check box.

[Back to Top](#)

How to Show or Hide the Draw Cursor

The draw cursor shows when the stylus touches the screen and provides precision visual feedback.

1. Go to **Settings > DirectStylus**.
2. Under **Cursor**, tap **Show draw cursor** to select the check box. To hide the draw cursor, tap again to clear the check box.

[Back to Top](#)

Stylus Apps

How to Use DirectStylus Launcher for Quick Access to Apps

The DirectStylus Launcher provides quick access to a subset of your apps. When DirectStylus Launcher opens, tap any app icon to open the app.

You may add or remove apps from the DirectStylus launcher at any time.

1. Open **DirectStylus Launcher**.

2. Tap the **App Selection** icon . The selection window opens.
3. Tap the app icons to select or clear the check boxes.
4. Tap **OK** to add selected apps and remove cleared apps.

[Back to Top](#)

How to Open DirectStylus Launcher Automatically When the Stylus Is Removed

1. Go to **Settings > DirectStylus**.
2. Tap **Default action when DirectStylus removed**.
3. Tap **Open DirectStylus Launcher**.
4. Tap **OK**.

[Back to Top](#)

How to Open an App Automatically When the Stylus Is Removed

You can select a single app to open automatically when the stylus is removed.

1. Go to **Settings > DirectStylus**.
2. Tap **Default action when DirectStylus removed**.
3. Tap **Launch App**.
4. Tap the app.
5. Tap **OK**.

[Back to Top](#)

How to Prevent Apps from Opening Automatically When the Stylus Is Removed

Follow these steps to prevent any app from opening when the stylus is removed.



1. Go to **Settings > DirectStylus**.
2. Tap **Default action when DirectStylus removed**.
3. Tap **None**.

[Back to Top](#)

You can customize what you see, what you hear, and how you interact with your device. Set your personal preferences for notification sounds, screen brightness, wallpaper images, font size, power saving mode, and other settings. Settings can be changed at any time.

The Android operating system provides several options for customizing your device. This section describes the most common options.

For help with the Android OS, please visit Google's support website at <http://support.google.com/android/>.

NOTE After you view or change any settings, tap **Back**  to return to the previous screen or tap **Home**  to return to the Home screen.

[Back to Top](#)

How to Open Settings

1. Tap **All Apps** .

2. Tap **Settings**  .

You can also use the Quick Settings. Swipe down from the System bar and then tap **Settings**. For more information, see [Use Quick Settings](#).

[Back to Top](#)

Sounds

How to Turn Touch Sounds On and Off

Touch sounds provide audio feedback when you use the touchscreen.

1. Go to **Settings > Device > Sound**.
2. Select the **Touch Sounds** check box to turn touch sounds on, or clear the check box to turn touch sounds off.

[Back to Top](#)

Display

How to Adjust Display Brightness

1. Go to **Settings > Device > Display**.
2. Tap **Brightness**. The Brightness control panel opens.
3. Swipe the slider to dim or brighten the display.

NOTE To adjust brightness automatically, tap **Auto**. Your device senses the amount of light in the immediate environment and adjusts the display brightness in response.

[Back to Top](#)

How to Change the Wallpaper

The wallpaper is an image or pattern that shows in the background of the Home screen pages.

1. Go to **Settings > Device > Display**.
2. Tap **Wallpaper**. The Wallpaper control panel opens.
3. Select the type of wallpaper that you want.
 - **Gallery**. Select from drawings, photos, or other images in the Gallery.
 - **Live Wallpapers**. Select from animated images.
 - **Photos**. Select from your photos.
 - **Wallpapers**. Select from still images.
4. Tap the image you want.
5. Tap **Set Wallpaper**.

[Back to Top](#)

How to Change the System Font Size

The font-size setting changes your device's system font size. However, apps may define their own font sizes. Fonts displayed in apps may not conform to the font-size setting.

1. Go to **Settings > Device > Display**.
2. Tap **Font Size**. The Font Size control panel opens.
3. Tap a font size. The control panel closes and the device applies the new font size immediately.

[Back to Top](#)

How to Change the Color Correction Preset

Your NVIDIA device supports sRGB and Native color presets. sRGB provides a more accurate color representation for photographs. Native provides brighter colors and a greater range of color.

1. Go to **Settings > Device > Display**.
2. Tap **Color Correction Preset**. The Color Correction Preset control panel opens.
3. Tap a color correction preset. The Color Correction Preset control panel closes and the device applies the preset immediately.

[Back to Top](#)

Power Saving

How to Change the Sleep-Mode Interval

Sleep mode conserves power by turning off the display after a period of inactivity. Sleep mode also activates the screen lock security, if any. For more information, see [Secure Your Device](#).

1. Go to **Settings > Device > Display**.
2. Tap **Sleep**. The Sleep control panel opens.
3. Tap the interval of time that you want the display to remain on when there is no activity. At the end of this interval, your device automatically enters sleep mode.

[Back to Top](#)



How to Manage Processor Performance

1. Go to **Settings > Power Saving**.
2. Tap **Processor**. The Processor status screen opens. This screen shows the selected power saving mode, the cores allowed by the mode, and whether a frequency limit is enabled.
3. Tap **Processor**. The Processor control panel opens.
4. Tap a power saving mode.
 - **Maximize Performance**. This mode increases processor performance. This option drains the battery faster than the other options.
 - **Optimized**. This mode provides a balance between performance and saving power.
 - **Save Battery**. This mode conserves power by limiting the number of processor cores and setting a frequency limit.

[Back to Top](#)

How to Reduce Background App Power Usage

Some apps use power even when your device is not in use. For example, a weather app might download information every 30 minutes even when the app is closed. You can conserve battery power by reducing app activity for apps you do not use often.

1. Go to **Settings > Power Saving**.
2. Tap **nSaver**.
3. In the list of apps, tap the **ON/OFF** switch to enable or disable nSaver for that app.
 - To turn nSaver on or off for all apps, tap .
 - To sort the app list, tap  and select a sort preference.

[Back to Top](#)

The Android operating system provides several options for organizing your apps and widgets. This section describes the most common options.

For help with the Android OS, please visit Google's support website at <http://support.google.com/android/>.

Home Screen

The Home screen is a place to organize apps and to display widgets. To return to the main Home screen at any time, tap the **Home** icon  in the Navigation bar.

NOTE If the Navigation Menu is not visible, swipe up from the bottom of the screen to open it.

Your NVIDIA device supports multiple Home screen pages. When you add more apps and widgets than can fit on the default Home screen page, additional pages are created automatically.

[Back to Top](#)

How to Create Home Screen Pages

Drag an app to the left or the right edge of the screen.

[Back to Top](#)

How to View Home Screen Pages

From any Home screen, swipe left or right.

[Back to Top](#)

Apps and Widgets

How to Add Apps to the Home Screen

1. Tap **All Apps** .
2. Tap and hold the app icon that you want to move. The Home screen appears behind the app icon.
3. Drag the icon to the page and location where you want to place the app.
4. Release.

[Back to Top](#)

How to Move Apps Around the Home Screen

1. Tap and hold the app icon that you want to move. The icon glows briefly and appears larger.
2. Drag the icon to the location where you want to place it. To move the app to another Home screen page, drag the icon to the right or left edge of the screen.
3. Release.

[Back to Top](#)

How to Add Apps to the Favorites Tray

The Favorites tray shows on all Home screen pages. If the Favorites tray already shows six apps, remove an app before you attempt to add another.

1. Tap and hold the app icon that you want to move. The icon glows briefly and appears larger.
2. Drag the icon to the Favorites tray.

3. Release.

[Back to Top](#)

How to Remove Apps from the Favorites Tray

1. Tap and hold the app icon that you want to move. The icon glows briefly and appears larger.
2. Drag the icon to the Home page.
3. Release

[Back to Top](#)

How to Add Widgets to the Home Screen

1. Tap **All Apps** .
2. Tap **Widgets**.
3. Tap and hold the widget. The Home screen appears behind the widget icon.
4. Drag the icon to the page and the location where you want to place it.
5. Release.

[Back to Top](#)

Folders

How to Create Folders to Group Apps Together

1. On the Home screen, tap and hold an app icon.
2. Drag and drop the icon onto another app icon. The folder is created.

3. Tap the folder.
4. Tap the text **Unnamed Folder**.
5. Enter a name.
6. Tap anywhere on the touchscreen to save the new name.

[Back to Top](#)

How to Rename a Folder

1. Tap the folder.
2. Tap the folder's name.
3. Enter the new name.
4. Tap anywhere on the touchscreen to save the new name.

[Back to Top](#)

How to Open Apps That Are in a Folder

1. Tap the folder. The folder opens to show the app icons inside.
2. Tap an app icon to open the app.

[Back to Top](#)

SD Card

You can add storage for apps and content with a microSD card. For more information, see [How to Add Storage with a microSD Card](#).

[Back to Top](#)

Notification indicate that you have new text messages, e-mail, calendar events, alarms, and many other events in progress.

[Back to Top](#)

How to Change the Notification Sound

The notification sound provides an audio alert when new notifications arrive.

1. Go to **Settings > Device > Sound**.
2. Tap **Default Notification Sound**. A list of available sounds opens.
 - Tap any sound to hear a preview.
 - To silence notifications, swipe to the top of the list and tap **None**.
3. To assign the selected sound, tap **OK**. To keep the previously assigned sound, tap **Cancel**.

[Back to Top](#)

How to View or Hide Notification Details

To view notification details, swipe your finger from the notification area toward the center of the touchscreen. The **Notification Shade** opens.

To expand or collapse the **Notification Shade**, tap and drag the bottom edge of the shade up or down.

To close the **Notification Shade**, swipe from the bottom of the shade up toward the notification area.

[Back to Top](#)

How to Clear a Notification

1. Open the **Notification Shade**.
2. Swipe the notification to the right or left.

NOTE Only the notification is cleared. The e-mail, text, download, or other event associated with the notification is not deleted.



[Back to Top](#)









How to Clear All Notifications

1. Open the **Notification Shade**.
2. Tap **Clear All** .

[Back to Top](#)

The Quick Settings shade provides one-touch access to important settings. To open the Quick Settings shade, swipe down from the System bar. To close Quick Settings, swipe up from the bottom of the shade or tap **Back** .

	Brightness. Tap to open the slider, and then use the slider to dim or brighten the touchscreen.
	Settings. Tap to open the device settings. For more information about settings, see Customize Your Device .
	Wi-Fi. Tap to open the Wi-Fi settings. If your device is connected to

	Wi-Fi, the network name and signal strength are shown.
	Rotation. Tap to switch between Auto Rotate , Portrait, or Landscape orientation.
	Battery. Tap to view the battery-usage history.
	Airplane Mode. Tap to turn on Airplane Mode. Airplane Mode turns off Wi-Fi, Bluetooth, Location services, GPS, and cellular voice and data.
	Bluetooth. Tap to open Bluetooth settings. For more information about Bluetooth, see Use Bluetooth Accessories .
	Location. Tap to open the Location settings.
	Power Management. Tap to open the power-management settings.
	Full Screen. Tap to switch between Full Screen and normal display mode. When the device is in Full Screen mode, the Navigation bar and System bar are hidden from the Home page.
	Miracast. Tap to open the Miracast settings and connect your tablet to a wireless display. For more information, see SHIELD Portable User Guide > Miracast .

[Back to Top](#)

The Google Keyboard appears automatically when you touch any text-input field. For example, open Chrome and tap in the Google Search box. The Google Keyboard opens.

NOTE If an external Bluetooth keyboard is connected, the Google Keyboard does not open.

This section describes common keyboard procedures. The Google Keyboard is part of the Android operating system.

For help with the Android OS, please visit Google's support website at <http://support.google.com/android/>.

[Back to Top](#)

Google Keyboard (Alphabet)



- ① **Shift key.** To capitalize one letter, tap once and then tap the letter. To capitalize all letters, double-tap to enter CAPS LOCK mode.
- ② **Numbers and symbols key.** Tap once to open the numbers and symbols keyboard.
- ③ **Microphone key.** Tap once to open Google voice typing. For more information, see [Using Voice Typing \(Speech Recognition\)](#).
- ④ **Backspace key.** Tap to erase the previous character.
- ⑤ **Enter key.** The label of this key changes depending on context. You may see **Done**, **Search**, **Enter**, or other labels in various apps and contexts.
- ⑥ **Shift key.** Same as ①.

[Back to Top](#)

Google Keyboard (Numbers and Symbols)



- 1 **Symbols.** Tap to open additional symbols.
- 2 **Alphabet.** Tap to return to the alphabet keyboard.

[Back to Top](#)

How to Insert Emoticons or Emoji Characters

NOTE Some text fields do not support keyboard emoticons or Emoji characters. In those cases, the emoticon key does not show on the keyboard.

1. Tap the Emoticon key.

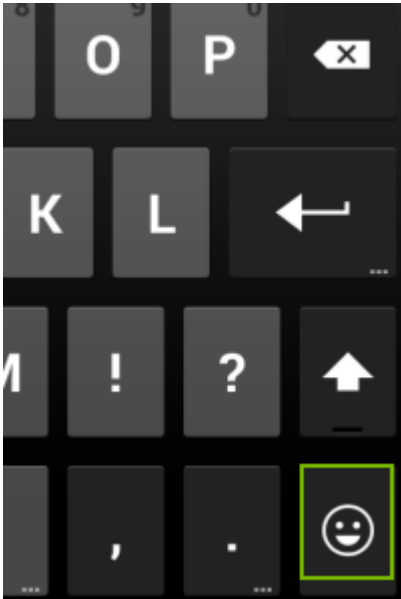

2. Swipe right or left to locate the character that you want.
3. Tap the character.

[Back to Top](#)

How to Enter Letter Accents and Variations

1. Tap and hold a letter. If the letter has accents or other variation, a pop-up box appears and shows the available options.
2. In the pop-up box, tap the character.

[Back to Top](#)

How to Use Gesture Typing

Gesture typing allows you to type by dragging from letter to letter instead of tapping each letter individually. Google Keyboard predicts the word you are typing and shows suggestions. When the word that you want is shown in the floating preview box or in the middle of the suggestion strip, release your finger. To select a different word from the suggestion strip, tap the word.

Turn gesture typing on or off in **Settings > Input > Google Keyboard > Advanced**.

NOTE Gesture typing is not available for all languages.

[Back to Top](#)

You can dictate text into email, notes, and other apps that accept text input. Google Voice Typing is available when the Google Keyboard shows the microphone key. If the microphone key is not visible, voice typing is not available for that text input field.

By default, voice typing is enabled and offensive words are blocked. Your device must be connected to the Internet for voice typing in most languages. However, Android supports offline voice typing for some languages. To customize voice typing, go to **Settings > Google Voice Typing**.

Voice typing is a standard Android feature.

For help with the Android OS, please visit Google's support website at <http://support.google.com/android/>.

[Back to Top](#)



How to Use Voice Typing

1. Tap any text input field to open the Google Keyboard.

2. Tap the microphone key.



3. At the prompt , speak. When you pause, your words are transcribed. Underlined words might have transcription errors. A **Delete** prompt also shows for a brief period of time.

- To delete the transcription, tap **Delete**.
- To view suggestions and replace an underlined word, tap the underlined word.
- To return to the keyboard, tap the prompt  to pause voice typing, and then tap the **Keyboard** icon .

NOTE In English, you can add punctuation by speaking. For example, as you speak, say "comma" or "period" to add the punctuation where you want it.

[Back to Top](#)

How to Disable Voice Typing

1. Go to **Settings > Personal > Language & Input**.
2. In Keyboard & Input Methods, tap the **Google Voice Typing** check box to clear it.

[Back to Top](#)

How to Allow Offensive Words

By default, Google Voice Typing does not transcribe or suggest some words.

1. Go to **Settings > Personal > Language & Input**.
2. In Keyboard & Input Methods, tap the **Google Voice Typing** slider



3. Tap the **Block Offensive Words** check box to clear it.

[Back to Top](#)

How to Add Languages

1. Go to **Settings > Personal > Language & Input**.
2. Under Keyboard & Input Methods, tap the **Google Voice Typing** slider



3. Under Google Voice Typing, tap the **Automatic** check box. The check box clears and the list of languages becomes available.
4. Under Active Input Methods, tap the languages that you want voice typing to recognize.

5. To return to Google Voice Settings, tap **Back**  .

[Back to Top](#)

How to Use Offline Voice Typing

Offline voice typing is available for some languages. Only words that are included in the language dictionary are available for voice typing.

1. Go to **Settings > Personal > Language & Input**.
2. Under Keyboard & Input Methods, tap the **Google Voice Typing** slider .
3. Tap **Offline Speech Recognition**.
4. Tap **All**. The list of supported languages opens.
5. Tap a language.
6. At the prompt, tap **Download**. The device downloads and installs the correct language dictionary.

[Back to Top](#)



This guide describes the most common status views. The status views are standard with the Android operating system.

For help with the Android OS, please visit Google's support website at <http://support.google.com/android/>.

[Back to Top](#)

System Bar Status Icons

The System bar shows information about wireless connection status, battery level, and whether Bluetooth is on. The System bar shows on Home screen pages.

	Bluetooth. This icon shows when Bluetooth is on, even if your device is not paired with a Bluetooth accessory.
	Alarm. This icon shows when an alarm is set in the default clock app.
	Wi-Fi. This icon shows when your device is connected to a wireless network. The number of bars indicates the Wi-Fi signal strength.



Battery. This icon shows the battery level.

[Back to Top](#)

How to View Device Status Details

The complete system status shows details such as the serial number and MAC address of your device.

Go to **Settings > About Tablet > Status**.

[Back to Top](#)

Your Nvidia device offers several types of security that are provided by the Android operating system.

For help with the Android OS, please visit Google's support website at <http://support.google.com/android/>.

[Back to Top](#)

How to Lock Your Tablet

Lock turns off the display and conserves power.

1. Press the **Power** button.
2. When the display turns off, release the button.

[Back to Top](#)

How to Unlock Your Tablet

1. Press the **Power** button and release. The display turns on.
2. If prompted, provide your screen lock option.

[Back to Top](#)

How to Set a Screen Lock

A screen lock requires you to provide an unlock option before you can access your device or change the screen lock.

1. Go to **Settings > Personal > Security**.
2. Tap **Screen Lock**.
3. Select the lock method that you want to use and follow the prompts on your device.

[Back to Top](#)

Screen Lock Options

None

This option removes any existing screen lock.

[Back to Top](#)

Slide

This option places a lock icon on the lock screen. To unlock the screen, swipe the lock icon in any direction.

[Back to Top](#)

Face Unlock

This option prompts you to point the device camera at your face. When you set up Face Unlock, you are also prompted to create a PIN or Pattern. The PIN or Pattern unlocks your device in situations where the camera cannot detect your face, such as in a dark room.

After you set up Face Unlock, additional options are available in the Screen Lock settings. Use these options to improve face recognition, enable widgets on the lock screen, and to require an eye blink while unlocking.

Pattern

This method prompts you to create a pattern. To unlock the screen, swipe your finger in the pattern you created.

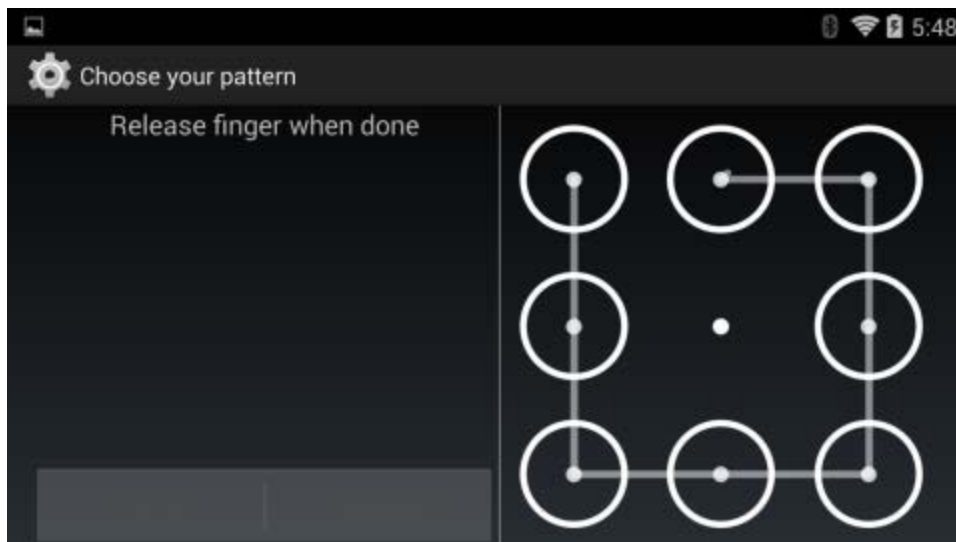

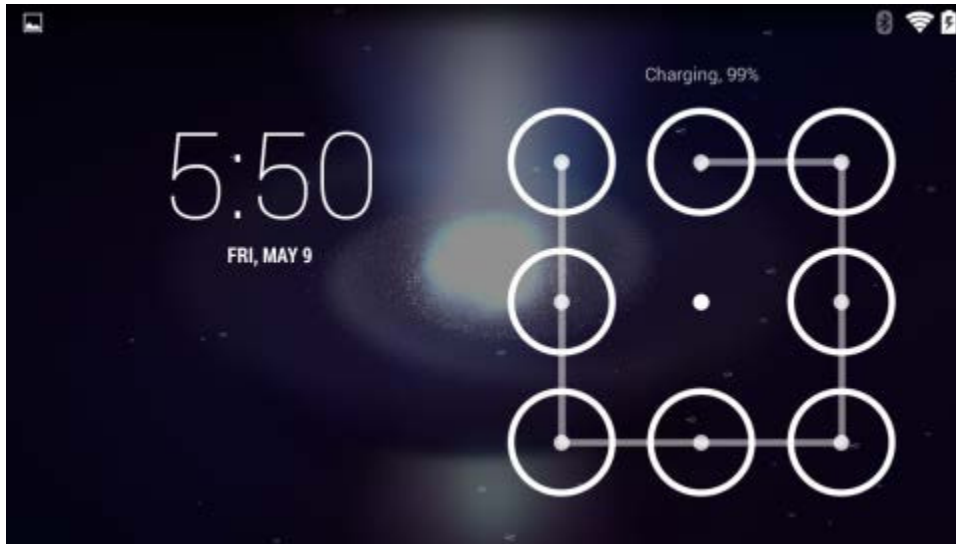

[Back to Top](#)

PIN

This method prompts you to create a 4-digit code (PIN).

To unlock the screen, tap your code and tap **Enter** .



[Back to Top](#)

Password

This method prompts you to create a password. Your password can include letters, numbers, and symbols.

To unlock the screen, tap the password box to open the keyboard. Enter your password and tap **Done**.





[Back to Top](#)

Your device periodically receives updates from NVIDIA and Google. These updates can include performance enhancements, new features, and bug fixes for your apps and the Android operating system.

[Back to Top](#)

How to Install Updates

1. Go to **Settings > System > About SHIELD**.
2. Tap **Status**.
3. Tap **System Updates**.
4. If an update is available, the version number and description are shown. Tap **Install** to update your device. If you do not want to update your device at this time, tap **Back**  or **Home**  to exit the update screen.

[Back to Top](#)

PLAY GAMES

NVIDIA® TegraZone™ makes it easy to find games that are optimized for your Tegra-powered device. Games are categorized by genre, controller support, release date, and other filters so that you can quickly find what you are looking for. Each game entry includes a brief description, the game's star rating, high-resolution screenshots and HD videos to help you make your choice.

For more information, visit the [TegraZone website](#) or see the [SHIELD Portable User Guide >Using TegraZone](#).

[Back to Top](#)

How to Open TegraZone

Tap TegraZone .

[Back to Top](#)

How to Turn On or Turn Off TegraZone Notifications

1. Open **TegraZone**.
2. Tap **Settings** .
3. Tap **On** or **Off** to toggle notifications on and off.

[Back to Top](#)

You can play controller-based games on your SHIELD tablet or use the tablet in Console Mode to play games on your HDTV. For more information, see [How to Use Your Tablet as a Game Console](#).

[Back to Top](#)

How to Connect a SHIELD Wireless Controller to Your Tablet

1. On your controller, touch the NVIDIA button to turn on the controller. The NVIDIA button blinks rapidly to signify that the controller is in connection mode.
2. On your SHIELD device, open the SHIELD Wireless Controller app .
3. Select **Connect Controller**. Your device searches for a wireless controller that is in range.
4. When the controller is connected, select **Done**.

OR

To connect another controller, select **Connect Another Controller**.

[Back to Top](#)

How to Find Controller Games

To find controller games that are optimized for SHIELD, open **TegraZone**  and filter for **Controller**. For more information, see the [SHIELD Portable User Guide > Using TezgraZone](#).

[Back to Top](#)

How to Add Controller Support to Touchscreen Games

The NVIDIA Gamepad Mapper app adds controller support to touchscreen games. NVIDIA provides default Gamepad Mapper profiles for hundreds of Android games. When you download one of these games, your device automatically downloads the Game Mapper profile. All you have to do is connect your controller, open the game, and start playing.

For a list of all Android games that Gamepad Mapper supports, please visit <http://shield.nvidia.com/android-game-list/>.

[Back to Top](#)

How to Create a Custom Gamepad Mapper Profile

You can create a custom Gamepad Mapper profile for any game that Gamepad Mapper supports.

For more information about creating custom profiles, please visit [SHIELD Portable User Guide > Gamepad Mapper](#).

For a list of Android games that Gamepad Mapper supports, please visit [SHIELD Portable User Guide > Game List](#)

[Back to Top](#)

NVIDIA® TegraZone™ makes it easy to find games that are optimized for your Tegra-powered device. Games are categorized by genre, controller support, release date, and other filters so that you can quickly find what you are looking for. Each game entry includes a brief description, the game's star rating, high-resolution screenshots and HD videos to help you make your choice.

For more information, visit the [TegraZone website](#) or see the [SHIELD Portable User Guide >Using TegraZone](#).

Console Mode transforms your SHIELD tablet into a full gaming and entertainment experience on your HDTV. In Console Mode, you can do everything that you would normally do on your device. Your TV provides the display, and you navigate with a keyboard and mouse or with a game controller. Play Android games, browse the web, check your e-mail, and watch your favorite movies.

NOTE When in Console Mode, the apps, menu, browser, and optimized Android games play back at native 1080p at up to 60 frames per second (fps). However, some Android games are not optimized for 1080p at 60fps playback.

Console Mode requires the following hardware:

- **Cable.** A Mini-HDMI to HDMI cable.
- **HDTV.** An HDTV with HDMI support.
- **Controller.** A Bluetooth wireless controller or keyboard and mouse. NVIDIA recommends the NVIDIA SHIELD Wireless Controller or the Nyko PlayPad Pro.

[Back to Top](#)

How to Connect Your Device to an HDTV

Console Mode opens automatically when you connect your device to an HDTV.

1. Connect a wireless controller or a Bluetooth keyboard and mouse. For more information, see [How to Use a SHIELD Wireless Controller with Your Tablet](#) or [Using Bluetooth Accessories](#).
2. Insert the cable's Mini-HDMI connector into the Mini-HDMI port of your device.
3. Insert the cable's HDMI connector into an HDMI port on your HDTV.
4. At the SHIELD Console Mode prompt, select **Enter Console Mode**.

[Back to Top](#)

You can record your gameplay to a video file and share the video through email, YouTube, and other sharing methods.

The video captures everything that you do on your tablet, including browsing incognito or logging into your mobile banking app. Pay attention to what you are doing while you record and do not share any video that shows information that you want to keep private.

For more information about broadcasting your gameplay to the internet, see [Broadcast Your Gameplay to Twitch TV](#).

[Back to Top](#)

How to Record and Share Your Gameplay

1. Open the game that you want to record.
2. Open the Quick Settings shade.
3. Tap **Shield Menu**.
4. Tap **Manual Record**.

5. Tap **Start**.
6. Play the game.
7. Open the Quick Settings shade.
8. Tap **Shield Menu**.
9. Tap **Manual Record**.
10. Tap **Stop and Share**.
11. Select a sharing method.
12. Follow the prompts to complete the share. The recording is also saved to the Gallery.

[Back to Top](#)



How to Record Your Gameplay Without Sharing

1. Open the game that you want to record.
2. Open the Quick Settings shade.
3. Tap **Shield Menu**.
4. Tap **Manual Record**.
5. Tap **Start**.
6. Play your game.
7. When you are ready to stop recording, open the Quick Settings shade.
8. Tap **Shield Menu**.
9. Tap **Manual Record**.
10. Tap **Stop**. The recording is saved to the Gallery.

[Back to Top](#)

How to Set the Video Quality

Video quality settings apply to record and share video and to broadcast video. For more information about broadcasting, see [Broadcast Your Gameplay to Twitch TV](#).

1. Open Quick Settings.
2. Tap **Shield Menu**.
3. At the bottom of the screen, tap the Record and Share settings  icon.
4. Tap the **Previous** and **Next** icons to scroll through the available quality levels. Lower qualities result in smaller file sizes for sharing and broadcasting. Higher qualities result in sharper images and smoother video.
5. When the quality level that you want is showing, tap **Back**  to return to the Record and Share settings.

[Back to Top](#)

How to Find Your Gameplay Videos

The first time that you record and save your gameplay, a Game Recordings album is created in the Gallery.

To view the saved recordings, open the Gallery and then open **Game Recordings**.

[Back to Top](#)

How to Record Your Gameplay Automatically

You can set your tablet to record your gameplay automatically with Auto Record. When Auto Record is turned on, your tablet records your gameplay continuously. You

can then save and share the last 1 to 20 minutes of the recorded video. For more information about video length, see [How to Set the Maximum Video Length](#)

[Back to Top](#)

How to Turn On Automatic Recording

1. Open Quick Settings.
2. Tap **Shield Menu**.
3. Tap **Auto Record**.
4. Tap **Start**.

[Back to Top](#)

How to Save and Share Automatically Recorded Video

1. Open Quick Settings.
2. Tap **Shield Menu**.
3. Tap **Auto Record**.
4. Tap **Save and Share**.
5. Select a sharing method.
6. Follow the prompts to complete the share. The recording is also saved to the Gallery.

[Back to Top](#)



How to Stop or Save Automatically Recorded Video Without Sharing

1. Open Quick Settings.

2. Tap **Shield Menu**.
3. Tap **Auto Record**.
4. To save the video to the Gallery, tap **Save**. To stop recording without saving the video, tap **Stop**.

[Back to Top](#)

How to Set the Maximum Video Length for Automatic Recording

1. Open Quick Settings.
2. Tap **Shield Menu**.
3. At the bottom of the screen, tap the Record and Share settings  icon.
4. Tap **Auto Record**.
5. Tap the **Previous** and **Next** icons to scroll through the available lengths.
6. When the length that you want is showing, tap **Back**  to return to the Record and Share settings.

[Back to Top](#)

How to Mute the Microphone for Gameplay Videos

The microphone captures audio from outside the game, such as your voice or sounds from your environment. Even with the microphone muted, the video includes the sound effects and music in the game unless you have muted the game's audio from within the game settings.

1. Open Quick Settings.

2. Tap **Shield Menu**.
3. At the bottom of the screen, tap the **Microphone** icon to toggle between mute and unmute.

[Back to Top](#)

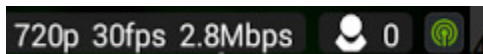

How to View Recording and Broadcasting Status

When your tablet is recording or broadcasting video, the following status information shows under the System bar.



Note The status icons show information only. You cannot modify recording or broadcasting settings from the status icons.

- **Broadcast quality.** For example, Low Quality is **360p**, Medium Quality is **480p**, and High Quality is **720p**. Ultra Quality is **1080p**. Ultra Quality is not available for broadcast, but you can record and share Ultra Quality video. For more information, see [Record and Share Your Gameplay](#).
- **Frame rate per second (fps).** For example, Medium and High Quality typically broadcast at about **30 fps**. Low Quality typically broadcasts at **25 fps**. Lower frame rates require less bandwidth.
- **Network speed (Mbps).** Many factors affect the network speed, including the strength of your local Wi-Fi connection and which Twitch server you are connected to. Network speed is shown when you are recording video even if you are not broadcasting.
- **Viewers.** The number next to the viewer icon  shows the number of people who are watching your broadcast.
- **Mute.** If your microphone is muted, a mute icon shows. If the microphone is not muted, no microphone icon shows.

- **Broadcast status.** The recording icon  shows when you are recording but not broadcasting. The broadcasting icon  shows when you are broadcasting live to Twitch.
- **Pause.** If your broadcast is paused, a pause icon shows.

[Back to Top](#)

You can broadcast your gameplay to Twitch TV for other people to watch as you play. You can also use the front-facing camera to include your face in a picture-in-picture window with your gameplay.

For more information about Twitch, please visit the Twitch support page at help.twitch.tv.

[Back to Top](#)

How to Create a Twitch Account

You must have a Twitch account to stream your gameplay to Twitch. You can create an account on the web at Twitch.tv or sign up through the Twitch control panel on your tablet.

1. Open Quick Settings.
2. Tap **Shield Menu**.
3. Tap **Twitch**.
4. Tap **Log In**.
5. Tap **Sign up for Twitch**. The browser opens.
6. Follow the prompts to create your Twitch account.

[Back to Top](#)

How to Connect Your Tablet to Twitch

1. Open Quick Settings.
2. Tap **Shield Menu**.
3. Tap **Twitch**.
4. Tap **Log In**.
5. Enter your Twitch user name and password. The Twitch Settings control panel opens.
 - To customize Twitch, change the Twitch settings.
 - To broadcast live, tap **Start Broadcasting**.
 - To return to your game, tap Recents  and open the game.

[Back to Top](#)

How to Broadcast Your Gameplay to Twitch

The broadcast shows everything that you do on your tablet, including browsing incognito or logging into your mobile banking app. Do not do anything on the tablet that reveals personal or private information while you are broadcasting.

1. Open the game you want to play.
2. Open Quick Settings.
3. Tap **Shield Menu**.
4. Tap **Twitch**.
5. Tap **Start Broadcasting**.

[Back to Top](#)

How to Stop Broadcasting

1. Open Quick Settings.
2. Tap **Shield Menu**.
3. Tap **Twitch**.
4. Tap **Stop**.

[Back to Top](#)

How to Share Your Broadcast

The Share option sends the direct link to your Twitch broadcast. Share is only available when you are broadcasting.

1. Start broadcasting.
2. Open Quick Settings.
3. Tap **Shield Menu**.
4. Tap **Twitch**.
5. Tap **Share**.
6. Select a sharing method.
7. Follow the prompts to complete the share.

[Back to Top](#)

How to Apply the Recommended Quality and Server Settings



1. Open Quick Settings.

2. Tap **Shield Menu**.
3. Tap **Twitch**. The Twitch Settings control panel opens.
4. Tap **Recommend Best Settings**.
5. Tap **OK**. Twitch analyzes your network connection to determine the server and the video quality to recommend. When analysis is complete, the results dialog box opens.
6. To close the dialog box without applying the settings, tap **OK**. To apply the recommended settings, tap **Use**.

[Back to Top](#)

How to Change the Twitch Server



Typically, a server that is closer to your location provides a faster connection speed. However, if you are experiencing server issues, you might want to connect to a different server.

1. Open Quick Settings.
2. Tap **Shield Menu**.
3. At the bottom of the screen, tap the Record and Share settings  icon.
4. In the Record and Share settings control panel, tap **Twitch**. The Twitch settings control panel opens.
5. Tap the **Previous** and **Next** icons to scroll through the available servers.
6. When server that you want is showing, tap **Back**  to return to the Record and Share settings.

[Back to Top](#)

How to Pause Broadcasting Automatically When You Switch Apps

This setting pauses the broadcast when you are switching apps. The broadcast resumes automatically when you are in an app, even if that app is not your game.

1. Open Quick Settings.
2. Tap **Shield Menu**.
3. At the bottom of the screen, tap the Record and Share settings  icon.
4. In the Record and Share settings control panel, tap **Twitch**. The Twitch settings control panel opens.
5. Tap **Pause broadcasting when switching apps**.
6. To return to your game, tap Recents  or Back .

[Back to Top](#)

EXTEND YOUR TABLET

Your NVIDIA device pairs with Bluetooth accessories such as keyboards, speakers, and headphones. You can also pair with other Bluetooth-enabled devices. Bluetooth functionality is a standard Android feature.

For help with the Android OS, please visit Google's support website at <http://support.google.com/android/>.

[Back to Top](#)

Bluetooth Behavior

How to Turn Bluetooth On or Off

When Bluetooth is on, the Bluetooth icon shows in the System bar.

1. Swipe down from the System bar. The Quick Settings shade opens.

2. Tap **Bluetooth** .
3. Tap the **ON/OFF** switch.

[Back to Top](#)

How to Set the Bluetooth Visibility Timeout

The Bluetooth visibility timeout is the interval of time that your device is visible to other Bluetooth devices. Longer timeouts provide you with more time to complete a Bluetooth pairing. However, long timeouts can increase your device's vulnerability to other Bluetooth users.

1. Open **Settings**.
2. Tap **Bluetooth**. The Bluetooth control panel opens.
3. Tap **Menu** .
4. Tap **Visibility Timeout**.
5. Tap an interval.

[Back to Top](#)

Bluetooth Accessories

How to Pair a Bluetooth Accessory with Your Device

The first time you use a Bluetooth accessory, you must pair the accessory and the device. You can also follow these steps to pair your NVIDIA device with another Bluetooth device such as a smart phone.

NOTE The Google Keyboard on the touchscreen is not active when a Bluetooth keyboard is paired with your device.

1. Follow the instructions from your accessory's manufacturer to put the accessory into Pair mode.
2. On your NVIDIA device, go to **Settings > Wireless & Networks**.
3. Tap **Bluetooth**. The Bluetooth control panel opens.
4. If Bluetooth is off, tap the **ON/OFF** switch to turn on Bluetooth.
5. If your NVIDIA device is visible only to paired devices, tap the device name to enable visibility. Your device searches for nearby Bluetooth accessories.
6. When the Bluetooth accessory appears in the list of **Available Devices**, tap the accessory's name to pair it. If the pairing is successful, the accessory now appears on the list of **Paired Devices**.

NOTE Some devices require a passkey before pairing. In these cases, your SHIELD device prompts you to verify that the passkey is appearing on your other device. Respond to any security prompt on that device. Then on your SHIELD device, tap **Pair** to complete the pairing or **Cancel** to cancel the pairing.

[Back to Top](#)

How to Disconnect a Bluetooth Accessory from Your Device

Disconnecting the Bluetooth accessory does not permanently cancel the pairing. The accessory remains on the list of Available Devices with a status of Disconnected.

1. Open **Settings**.
2. Tap **Bluetooth**. The Bluetooth control panel opens.
3. In the list of **Paired Devices**, tap the accessory's **Settings** icon . The accessory control panel opens.
4. Tap **Unpair**.

[Back to Top](#)

How to Rename Your Bluetooth Accessory in the Paired Devices List

Your Bluetooth accessories appear on the list with names that are assigned by the manufacturer. These names are often a product number or a brand name. You can rename the accessories so that when you look at the list of available or paired devices, you know exactly what your SHIELD device is connected to.

Renaming a Bluetooth accessory only changes the name in the Paired Devices list. Your accessory is not affected.

1. Open **Settings**.
2. Tap **Bluetooth**. The Bluetooth control panel opens.

3. In the list of **Paired Devices**, tap the accessory's **Settings** icon . The accessory control panel opens.
4. Tap **Rename**.
5. Enter the new name and tap **OK**.

[Back to Top](#)

Connect headphones or headsets to the 3.5 mm jack on the edge of the tablet.

Headphones provide audio output only and the built-in microphone is used for audio input. Headsets include a microphone and provide audio output and input. When you use a headset, the internal microphone automatically turns off.

You can also use Bluetooth headphones and headsets with your tablet. For more information, see [How to Use Bluetooth Accessories](#).

Your device includes a microSD slot so that you can add storage space for photos, music, and videos.

SD cards are available in different classes and capacities. Higher classes indicate faster speeds for performing actions such as displaying photos or saving videos. Higher capacities indicate greater storage space.

WARNING Always unmount the microSD card in the Settings before you physically eject the card from your device.

[Back to Top](#)

Recommended microSD Card Class

NVIDIA recommends using a class 6 or higher microSD card.

[Back to Top](#)

Required microSD Card Formats

For microSD cards up to 32 gigabytes in capacity, SHIELD supports the FAT32 data format. Most microSD cards that are 32-GB or less are already formatted as FAT32.

For microSD cards up to 64-GB in capacity, SHIELD supports the NTFS data format. Most microSD cards that are 64-GB or larger come formatted as exFAT and must be reformatted before you can use them with SHIELD. Android does not support the exFAT file system.

NOTE You can reformat microSD cards on your Windows PC or Mac computer.

[Back to Top](#)



How to Insert a microSD Card

1. Locate the microSD card slot on the edge of the tablet, near the volume control.
2. Position the microSD card with the connectors facing the back of the tablet.
3. Gently press the microSD card into the slot. When you feel the card secure itself in the slot, release.

[Back to Top](#)

How to Unmount and Eject a microSD Card

Always unmount the microSD card before you remove the microSD card from the device.

1. Tap **All Apps** .
2. Tap **Settings** .
3. Tap **Storage**.
4. Tap **Unmount SD Card**.
5. Press the microSD card deeper into the slot and then release. The microSD card disconnects from the slot.
6. Grasp the edge of the microSD card and remove the microSD card from the device.

[Back to Top](#)

How to Move Content to a microSD Card

Some apps do not support microSD card storage. If the app control panel does not have an option to **Move to SD Card**, the app must remain in your device's internal storage.

1. Go to **Settings > Apps**.
2. Tap the app that you want to move. The app control panel opens.
3. Tap **Move to SD Card**.
4. At the prompt, tap **OK** to confirm.

[Back to Top](#)

How to View microSD Card Storage

To view the status of internal storage and the microSD card, go to **Settings > Storage**.

[Back to Top](#)

You can connect your tablet with a cellular network by installing a SIM card and subscribing to a wireless data service.

How to Install a Micro-SIM Card

1. Hold the tablet with the touchscreen facing you.
2. Carefully open the micro-SIM card slot cover. Rotate the cover to the right.
3. Position the micro-SIM card with the gold contacts facing away from you and the notch on the bottom right of the card.
4. Push the micro-SIM card into the micro-SIM card slot until you feel a slight click. When you release, the micro-SIM card stays in the slot.
5. Close the slot cover.

[Back to Top](#)

How to Remove a Micro-SIM Card

1. Open the micro-SIM card slot cover.
2. Press the micro-SIM card deeper into the slot and then release. The micro-SIM card disconnects from the slot.
3. Grasp the edge of the micro-SIM card and remove the micro-SIM card from the device.

[Back to Top](#)

NVIDIA® Lasso Capture provides a quick and easy way to take screenshots of all or part of your screen. You can also annotate and share the captures.

Captures are stored in the Gallery with your other photos and images. View, edit, and share captures just like you would any other image.

HOW TO ENABLE ACCESS TO LASSO CAPTURE

1. Go to **Settings > DirectStylus**.
2. Under Stylus Mode and Lasso Capture, select the **Quick access via navigation bar** check box.

[Back to Top](#)



HOW TO OPEN LASSO CAPTURE

1. Remove the stylus from its holder.
2. In the Navigation bar, tap **Lasso Capture** .

[Back to Top](#)



CAPTURES

How to Capture a Screenshot of the Whole Screen

1. Remove the stylus from its holder.
2. In the Navigation bar, tap **Lasso Capture** .
3. Tap **Screenshot** .
4. To annotate the capture, tap the pen  and write a note on the captured area.
5. Tap **Save**. The capture is saved to the Gallery.



[Back to Top](#)

How to Capture a Rectangular Region

1. Remove the stylus from its holder.
2. In the Navigation bar, tap **Lasso Capture** .
3. Tap **Rectangular Region** .
4. Tap and drag the selector around the area you want to capture.
5. To annotate the capture, tap the pen  and write a note on the captured area.
6. Tap **Save**. The capture is saved to the Gallery.

[Back to Top](#)

How to Capture a Free-Hand Region

1. Remove the stylus from its holder.
2. In the Navigation bar, tap **Lasso Capture** .
3. Tap **Lasso** .
4. Tap and drag the selector around the area you want to capture.
5. To annotate the capture, tap the pen  and write a note on the captured area.
6. Tap **Save**. The capture is saved to the Gallery.

[Back to Top](#)

HOW TO SHARE A CAPTURE

Captures are saved to the gallery automatically when you share the capture.

1. Take a capture. Do not tap **Save**.
2. Tap **Share** .
3. Tap the sharing method that you want to use.
4. Follow the prompts to send the capture.

[Back to Top](#)

HOW TO SAVE A CAPTURE TO PDF

Use ES File Explorer to open the PDF for viewing and annotating.

1. Take a capture. Do not tap **Save**.
2. Tap **Share** .
3. Tap **Convert to PDF**.

[Back to Top](#)

HOW TO TAKE A FULL-SCREEN SCREENSHOT WITHOUT THE STYLUS



Press and hold the device's **Power** button and **Volume Down** button simultaneously for a few seconds. A snapshot sound indicates that the screen has been captured. The capture is saved to the Gallery.

[Back to Top](#)

NVIDIA® DabblTMer is a drawing and painting app that is optimized for use with your NVIDIA DirectStylus.

The first time you open NVIDIA DabblTMer, a tutorial shows you how to use all the features of the app. NVIDIA DabblTMer also includes help tips that you can show or hide as needed.

HOW TO OPEN NVIDIA DABBLER

1. Tap **All Apps** .
2. Tap **NVIDIA DabblTMer** .

[Back to Top](#)

LEARN THE NVIDIA DABBLER WORKSPACE



①	Toolbar. The Toolbar provides actions such as Undo , Redo , Share , and Save .
②	Workspace. The Workspace displays the paper texture or background image that you have chosen for your project.
③	Tray. The Tray provides background settings and several brushes and drawing tools.
④	Palette. The Palette provides color selections, the color mixer, the water level, and other options. The options depend on which tool you are using. For example, water level is only available when you select the Watercolor brush.

[Back to Top](#)

MANAGE

How to View the NVIDIA Dabblers Help Tips

1. In the Toolbar, tap **Help** .
2. Tap any icon, brush, or feature to view its description.

3. To hide help tips, tap **Help**  again.

How to Undo or Redo the Previous Action

In the Toolbar, tap **Undo**  or **Redo** .

[Back to Top](#)

How to Save Your Work

In the Toolbar, tap **Save** . A copy of your work is saved to the Gallery. You can keep working, but the saved image is not updated to reflect the changes. Save your work again before you clear the canvas.

[Back to Top](#)

How to Show or Hide the Toolbar

To show the Toolbar, tap .

To hide the Toolbar, tap .

[Back to Top](#)

How to Show or Hide the Tray and Palette

To show or hide the tray and palette, tap .



CREATE ARTWORK

NVIDIA Dabblers Painting Styles

In the Toolbar, tap  to select a painting style.



Sketch. Sketch includes the marker, pencil, and eraser tools. Shape recognition is only available in Sketch.









Watercolor. Watercolor includes all of the drawing and painting tools except the spatula. Gravity, instant dry, and water level features are only available in Watercolor.



Oil. Oil includes all of the drawing and painting tools. The spatula tool is only available in Oil.



NVIDIA Dabblers Tools

In the Tray, tap the tool that you want to use.

	Marker. The marker replicates the effect of a permanent ink pen.
	Pencil. The pencil replicates the effect of a graphite pencil.
	Eraser. The eraser replicates the effect of a rubber eraser. Keep moving the eraser until you achieve the effect that you want.
	Thin brush. The thin brush replicates the effect of a detail paint brush. Thin brush is not available in Sketch.
	Thick brush. The thick brush replicates the effect of a wide paint brush. Thick brush is not available in Sketch.
	Spatula. The spatula replicates the effect of a spatula or chisel on oil painting. Spatula is only available in Oil.

[Back to Top](#)

How to Adjust Brush Styles

In the Toolbar, use the sliders to adjust the brush fill strength  and the relative brush radius . The actual brush radius is controlled by the pressure and angle of the stylus tip on the touchscreen.

[Back to Top](#)

How to Mix Colors

1. On the Palette, tap a color.
2. Touch the color mixer and move your finger or stylus in a circle. The new color mixes with the previously selected color. Mix clockwise to add more of the new color or anti-clockwise to retain more of the previous color.

[Back to Top](#)

How to Select RGB Colors

1. On the Palette, tap the RGB color selector . The RGB color slider opens.
2. Tap the RGB color that you want.

[Back to Top](#)

How to Use Shape Recognition

Shape recognition mode detects when you are drawing a circle, square, or other geometric shape and automatically corrects the shape. Shape recognition is only available in Sketch.

In the Toolbar, tap **Shape Recognition** . Tap again to turn off shape recognition.

[Back to Top](#)

How to Use Gravity

Gravity replicates the effect of gravity on watercolor paint. The direction of the pull, or "down," is based on the orientation of your tablet. Gravity is only available in Watercolor.

In the Toolbar, tap . Tap again to turn off gravity.

[Back to Top](#)

How to Dry Your Watercolor Instantly

Dabblers replicates the feel of watercolors by allowing the colors to move slowly until the canvas is "dry." Instant dry is only available in Watercolor.

In the Toolbar, tap .

[Back to Top](#)

How to Adjust the Water Level

Dabblers replicates the feel of watercolors by providing adjustable water levels. Water level is only available in Watercolor.

To increase or decrease the "wetness" of the canvas, drag the water level up and down.



[Back to Top](#)

How to Lock the Water Level



To lock the water level so that the water does not deplete over time, adjust the water level and then tap the lock .

[Back to Top](#)

BACKGROUND AND CANVAS

How to Select a Background Image

In the Tray, tap the source of the image that you want to use for the background.

- To use an existing image, tap **Image** . Tap whether to select the image from the **Gallery** or **Photos**, and then tap the image that you want.
- To take a new picture, tap **Camera**  and then take the picture.

How to Select a Canvas Texture

In the Tray, swipe the canvas textures. The texture shown in full and outlined in blue is applied to the canvas.

How to Clear the Canvas

In the Toolbar, tap .

[Back to Top](#)

NVIDIA

[Notices and Trademarks](#)

[Tegra Experience Terms of Service](#)

[Warranty](#)

REGULATORY

[Health and Safety Information](#)

The NVIDIA SHIELD Tablet is compliant with the regulations that are listed in this section.

UNITED STATES

Federal Communications Commission (FCC)



FCC ID: VOB-P1761W (WiFi SKU)

FCC ID: VOB-P1761W CONTAINS FCC ID: VOB-P1729 (LTE SKU)

This device complies with part 15 of the FCC Rules. Operation is subject to the following two conditions: (1) this device may not cause harmful interference, and (2) this device must accept any interference received, including any interference that may cause undesired operation of the device.

This equipment has been tested and found to comply with the limits for a Class B digital device, pursuant to Part 15 of the FCC Rules. These limits are designed to provide reasonable protection against harmful interference in a residential installation. This equipment generates, uses and can radiate radio frequency energy and, if not installed and used in accordance with the instructions, may cause harmful interference to radio communications. However, there is no guarantee that interference will not occur in a particular installation.

If this equipment does cause harmful interference to radio or television reception, which can be determined by turning the equipment off and on, the user is encouraged to try to correct the interference by one or more of the following measures:

- Reorient or relocate the receiving antenna.
- Increase the separation between the equipment and receiver.
- Connect the equipment into an outlet on a circuit different from that to which the receiver is connected.

- Consult the dealer or an experienced radio/TV technician for help.

FCC Warning: The FCC requires that you be notified that any changes or modifications to this device not expressly approved by the manufacturer could void the user's authority to operate the equipment.

Caution: Within the 5.15 to 5.25 GHz band (5 GHz radio channels 34 to 48) this device is restricted to indoor operations to reduce any potential for harmful interference to co-channel Mobile Satellite System (MSS) operation

RF Radiation Exposure Statement:

SHIELD Tablet has been tested and complies with FCC RF radiation exposure limits set forth for an uncontrolled environment when used with the NVIDIA accessories supplied or designated for this product. During testing, the SHIELD Tablet was placed in positions that simulate use against the body. The use of any other accessories may not ensure compliance with FCC RF exposure guidelines.

Underwriters Laboratories (UL)



I.T.E E204896

California Energy Commission (CEC)



This product meets the applicable energy efficiency requirements for a battery charging system.

CANADA

Industry Canada (IC)

IC: 7361A-P1761W (WiFi SKU)

IC: 7361A-P1761W CONTAINS IC: 7361A-E1729 (LTE SKU)

CAN ICES-3(B)/NMB-3(B)

This device complies with RSS-210 of the Industry Canada Rules. Operation is subject to the following two conditions: (1) this device may not cause interference, and (2) this device must accept any interference, including interference that may cause undesired operation of the device.

Ce dispositif est conforme à la norme CNR-210 d'Industrie Canada applicable aux appareils radio exempts de licence. Son fonctionnement est sujet aux deux conditions suivantes: (1) le dispositif ne doit pas produire de brouillage préjudiciable, et (2) ce dispositif doit accepter tout brouillage reçu, y compris un brouillage susceptible de provoquer un fonctionnement indésirable.

RF Radiation Exposure Statement:

SHIELD Tablet has been tested and complies with IC RSS 102 RF radiation exposure limits set forth for an uncontrolled environment when used with the NVIDIA accessories supplied or designated for this product. During testing, the SHIELD Tablet was placed in positions that simulate use against the body. The use of any other accessories may not ensure compliance with IC RSS 102 RF exposure guidelines.

Déclaration d'exposition aux radiations:

La tablette SHIELD a été testée conformément aux normes d'exposition d'émission RF de la IC RSS 102 pour un environnement non contrôlé lors d'utilisation avec les accessoires fournis ou recommandés par NVIDIA. Pendant les tests, la tablette SHIELD a été positionnée afin de simuler la présence du corps humain. L'utilisation d'accessoires autres que ceux recommandés par NVIDIA ne garantit pas la compatibilité avec les normes d'émission RF de la IC RSS 102.