



# **FCC Part 15**

## **TEST REPORT**

*For*

**Bluetooth Headset (Class 2)**

**Model Name: A6**

**FCC ID: VO8A6**

**Report No.: GZAGC132080302E6**

**Date of Issue: Mar.31, 2008**

*Prepared For*

**GuangZhou LIWEI Electronics Co., Ltd.**

**No.33, Zhenzhongbei Road, Shenshan Industrial Park,**

**Baiyun District, Guangzhou 510460, P.R. China**

Tel: 86-020 8606 2626

Fax: 86-020 8606 2626

*Prepared By*

**Shenzhen Attestation of Global Compliance Science & Technology Co., Ltd.**

**Suite B11/B12, 4F, Huafeng Mall, Chuangye 2<sup>nd</sup> Road,**

**25 District, Bao'an, Shenzhen**

Tel: 86-755-2974 2358

Fax: 86-755-2600 8484

**VERIFICATION OF COMPLIANCE**

Applicant:	GuangZhou LIWEI Electronics Co., Ltd.
Manufacturer	GuangZhou LIWEI Electronics Co., Ltd.
Product Description:	Bluetooth Headset (Class 2)
Brand Name:	Bluedio
Model Number:	A6
FCC ID	VO8A6
Report Number:	GZAGC132080302E6
Date of Test:	Mar.25, 2008-Mar.31, 2008

**WE HEREBY CERTIFY THAT:**

The above equipment was tested by **Shenzhen Attestation of Global Compliance Science & Technology Co., Ltd.** The test data, data evaluation, test procedures, and equipment configurations shown in this report were made in accordance with the procedures given in ANSI C63.4 (2003) and the energy emitted by the sample EUT tested as described in this report is in compliance with radiated emission limits of FCC Rules Part 15.247.

Tested By: Tony Tian  
 Tony Tian Mar.31, 2008

Checked By: Randy He  
 Randy He Mar.31, 2008

Authorized By King Zhang  
 King Zhang Mar.31, 2008

## TABLE OF CONTENTS

<b>1. GENERAL INFORMATION.....</b>	<b>4</b>
1.1 PRODUCT DESCRIPTION.....	4
1.2 RELATED SUBMITTAL(S) / GRANT (S).....	4
1.3 TEST METHODOLOGY .....	4
1.4 TEST FACILITY.....	4
1.5 SPECIAL ACCESSORIES.....	4
1.6 EQUIPMENT MODIFICATIONS .....	4
<b>2. SYSTEM TEST CONFIGURATION .....</b>	<b>5</b>
2.1 CONFIGURATION OF TESTED SYSTEM.....	5
2.2 EQUIPMENT USED IN TESTED SYSTEM .....	5
<b>3. SUMMARY OF TEST RESULTS .....</b>	<b>6</b>
<b>4. DESCRIPTION OF TEST MODES.....</b>	<b>6</b>
<b>5. CONDUCTION EMISSIONS .....</b>	<b>7</b>
5.1 MEASUREMENT PROCEDURE: .....	7
5.2 TEST SET-UP (BLOCK DIAGRAM OF CONFIGURATION) .....	7
5.3 MEASUREMENT EQUIPMENT USED:.....	7
5.4 LIMITS AND MEASUREMENT RESULT:.....	8
<b>6. MAXIMUM OUTPUT POWER.....</b>	<b>9</b>
6.1 MEASUREMENT PROCEDURE: .....	9
6.2 TEST SET-UP (BLOCK DIAGRAM OF CONFIGURATION) .....	9
6.3 MEASUREMENT EQUIPMENT USED:.....	11
6.4 LIMITS AND MEASUREMENT RESULT:.....	12
<b>7. 20 DB BANDWIDTH .....</b>	<b>14</b>
7.1 MEASUREMENT PROCEDURE .....	14
7.2 TEST SET-UP (BLOCK DIAGRAM OF CONFIGURATION) .....	14
7.3 MEASUREMENT EQUIPMENT USED:.....	14
7.4 LIMITS AND MEASUREMENT RESULTS: .....	14
<b>8. MAXIMUM CONDUCTED OUTPUT POWER SPECTRAL DENSITY .....</b>	<b>16</b>
8.1 MEASUREMENT PROCEDURE: .....	16
8.2 TEST SET-UP (BLOCK DIAGRAM OF CONFIGURATION) .....	16
8.3 MEASUREMENT EQUIPMENT USED:.....	16
8.4 LIMITS AND MEASUREMENT RESULT:.....	16
<b>9. OUT OF BAND EMISSION .....</b>	<b>19</b>
9.1 MEASUREMENT PROCEDURE: .....	19
9.2 TEST SET-UP (BLOCK DIAGRAM OF CONFIGURATION) .....	19
9.3 MEASUREMENT EQUIPMENT USED:.....	19
9.4 LIMITS AND MEASUREMENT RESULT:.....	19

**10. NUMBER OF HOPPING FREQUENCY..... 26**

10.1 MEASUREMENT PROCEDURE ..... 26

10.2 TEST SETUP (BLOCK DIAGRAM OF CONFIGURATION)..... 26

10.3 MEASUREMENT EQUIPMENT USED..... 26

10.4 LIMITS AND MEASUREMENT RESULT:..... 26

**11. TIME OF OCCUPANCY (DWELL TIME)..... 27**

11.1 MEASUREMENT PROCEDURE ..... 27

11.2 TEST SETUP (BLOCK DIAGRAM OF CONFIGURATION)..... 27

11.3 MEASUREMENT EQUIPMENT USED..... 27

11.4 LIMITS AND MEASUREMENT RESULT ..... 27

**12. FREQUENCY SEPARATION..... 30**

12.1 MEASUREMENT PROCEDURE ..... 30

12.2 TEST SETUP (BLOCK DIAGRAM OF CONFIGURATION)..... 30

12.3 MEASUREMENT EQUIPMENT USED..... 30

12.4 LIMITS AND MEASUREMENT RESULT ..... 30

**APPENDIX 1 ..... 31**

**PHOTOGRAPHS OF SET UP ..... 31**

**APPENDIX 2..... 34**

**PHOTOGRAPHS OF EUT ..... 34**

## 1. GENERAL INFORMATION

### 1.1 PRODUCT DESCRIPTION

The EUT is a short range, lower power; **Bluetooth Headset (Class 2)** designed as an “Communication Device”. It is designed by way of utilizing the FHSS technology to achieve the system operation.

A major technical description of EUT is described as following:

Operation Frequency	2.402 GHz to 2.480 GHz
Rated Output Power	-6.87 dBm
Modulation	FHSS
Number of channels	79
Antenna Designation	Dedicated Antenna with Maximum 3 dBi
Power Supply	DC 3.7V Power by Battery

### 1.2 RELATED SUBMITTAL(S) / GRANT (S)

This submittal(s) (test report) is intended for FCC ID: **VO8A6** filing to comply with Section 15.247 of the FCC Part 15, Subpart C Rules.

### 1.3 TEST METHODOLOGY

Both conducted and radiated testing were performed according to the procedures in ANSI C63.4 (2003). Radiated testing was performed at an antenna to EUT distance 3 meters.

### 1.4 TEST FACILITY

All measurement facilities used to collect the measurement data are located at World Standardization Certification & Testing Co., Ltd.  
1-2/F, Dachong Keji Building, No.28 of Tonggu Road, Nanshan District,  
Shenzhen, China  
FCC Registration Number: 989301

Radiated emissions are measured with one or more of the following types of linearly polarized antennas: tuned dipole, biconical, log periodic, bi-log, and/or ridged waveguide, horn. Spectrum analyzers with preselectors and quasi-peak detectors are used to perform radiated measurements.

### 1.5 SPECIAL ACCESSORIES

Not available for this EUT intended for grant.

### 1.6 EQUIPMENT MODIFICATIONS

Not available for this EUT intended for grant.

## 2. SYSTEM TEST CONFIGURATION

### 2.1 CONFIGURATION OF TESTED SYSTEM

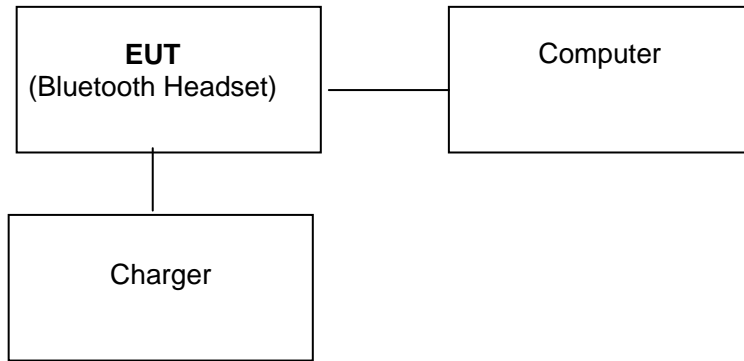

### 2.2 EQUIPMENT USED IN TESTED SYSTEM

Item	Equipment	Mfr/Brand	Model/Type No.	FCC ID	Series No.
1	Bluetooth Headset	Bluedio	A6	VO8A6	--
2	Computer	HP	520	--	--
3	Charger	--	--	--	--

### 3. SUMMARY OF TEST RESULTS

FCC RULES	DESCRIPTION OF TEST	RESULT
§15.207	Conduction Emission	Compliant
§15.209	Radiated Emission	Compliant
§15.247	Maximum Output Power	Compliant
§15.247	20 dB Bandwidth	Compliant
§15.247	Band Edges	Compliant
§15.247	Spurious Emission	Compliant
§15.247	Frequency Separation	Compliant
§15.247	Number of Hopping Frequency	Compliant
§15.247	Time of Occupancy	Compliant
§15.247	Peak Power Density	Compliant

### 4. DESCRIPTION OF TEST MODES

1. The EUT has been set to operate continuously on the lowest, the middle and the highest operation frequency individually.
2. The EUT stays in continuous transmitting mode on the operation frequency being set.
3. The EUT also be tested under charging Mode.

## 5. CONDUCTION EMISSIONS

### 5.1 MEASUREMENT PROCEDURE:

1. The equipment was set up as per the test configuration to simulate typical actual usage per the user's manual. The EUT is a tabletop system; a wooden table with a height of 0.8 meters is used and is placed on the ground plane as per ANSI C63.4.
2. Support equipment, if needed, was placed as per ANSI C63.4.
3. All I/O cables were positioned to simulate typical actual usage as per ANSI C63.4.
4. The EUT received AC120V/60Hz power through a Line Impedance Stabilization Network (LISN) which supplied power source and was grounded to the ground plane.
5. All support equipments received AC power from a second LISN, if any.
6. The EUT test program was started. Emissions were measured on each current carrying line of the EUT using a spectrum Analyzer / Receiver connected to the LISN powering the EUT. The LISN has two monitoring points: Line 1 (Hot Side) and Line 2 (Neutral Side). Two scans were taken: one with Line 1 connected to Analyzer / Receiver and Line 2 connected to a 50 ohm load; the second scan had Line 1 connected to a 50 ohm load and Line 2 connected to the Analyzer / Receiver.
7. Analyzer / Receiver scanned from 150 KHz to 30MHz for emissions in each of the test modes.
8. During the above scans, the emissions were maximized by cable manipulation.

### 5.2 TEST SET-UP (BLOCK DIAGRAM OF CONFIGURATION)

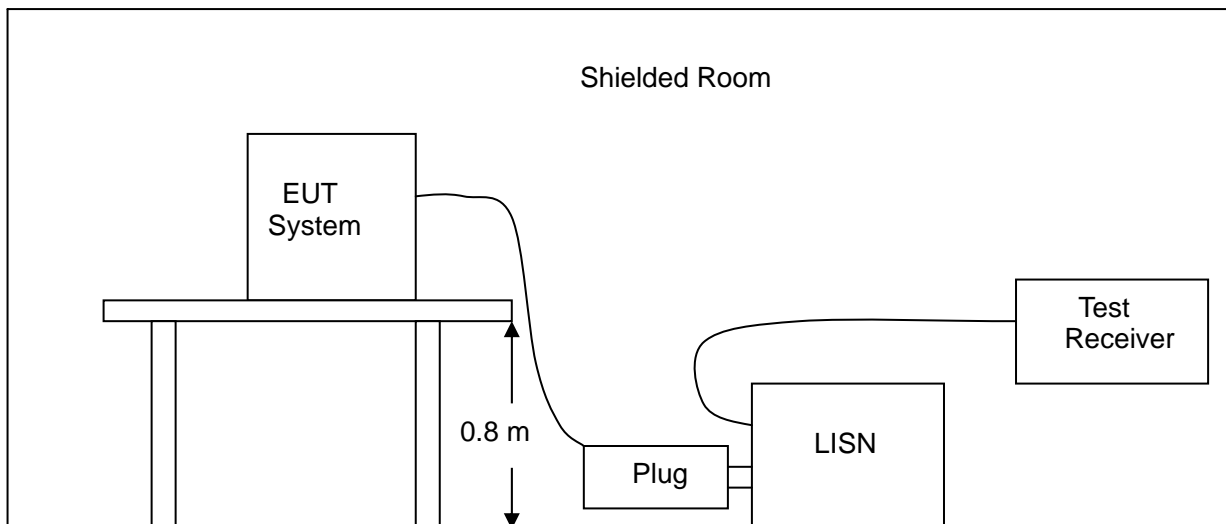

### 5.3 MEASUREMENT EQUIPMENT USED:

CONDUCTED EMISSION TEST SITE					
EQUIPMENT TYPE	MFR	MODEL NUMBER	SERIAL NUMBER	LAST CAL.	CAL DUE.
EMI TEST RECEIVER	HP	8546A/8546 0A	3625A00349 3448A00325	2007/10	2008/10
LISN	AFJ	LS16	16010222119	2007/04	2008/04



#### 5.4 LIMITS AND MEASUREMENT RESULT:

(The chart below shows the highest readings taken from the final data)

FREQ MHz	PEAK RAW dBuV	Q.P. RAW dBuV	AVG RAW dBuV	Q.P. Limit dBuV	AVG Limit dBuV	Q.P. Margin dB	AVG Margin dB	NOTE
0.210	41.80	---	---	64.28	54.28	-22.48	-12.48	L1
0.411	43.82	---	---	58.52	48.52	-14.70	-4.70	L1
0.825	40.66	---	---	56.00	46.00	-15.34	-5.34	L1
1.182	38.64	---	---	56.00	46.00	-17.36	-7.36	L1
1.394	39.55	---	---	56.00	46.00	-16.45	-6.45	L1
---	---	---	---	---	---	---	---	L1
0.259	45.33	---	---	62.88	52.88	-17.55	-7.55	L2
0.516	36.53	---	---	56.00	46.00	-19.47	-9.47	L2
0.774	37.81	---	---	56.00	46.00	-18.19	-8.19	L2
1.526	36.19	---	---	56.00	46.00	-19.81	-9.81	L2
1.758	40.11	---	---	56.00	46.00	-15.89	-5.89	L2
---	---	---	---	---	---	---	---	L2

L1 = Line One (Hot side) / L2 = Line Two (Neutral side)

**\*\*NOTE:**

“---” denotes the peak emission level was or more than 2dB below the Average limit, so no re-check anymore.

## 6. MAXIMUM OUTPUT POWER

### 6.1 MEASUREMENT PROCEDURE:

#### CONDUCTED METHOD

1. The EUT was placed on a turn table which is 0.8m above ground plane.
2. Connect EUT RF output port to the Spectrum Analyzer through an RF attenuator
3. Set the EUT Work on the top, the middle and the bottom operation frequency individually.
4. Set SPA Centre Frequency = Operation Frequency, RBW= 1 MHz, VBW= 1 MHz.
5. Set SPA Trace 1 Max hold, then View.

#### RADIATED METHOD

According to ANSI C63.4:2003

### 6.2 TEST SET-UP (BLOCK DIAGRAM OF CONFIGURATION)

#### CONDUCTED METHOD

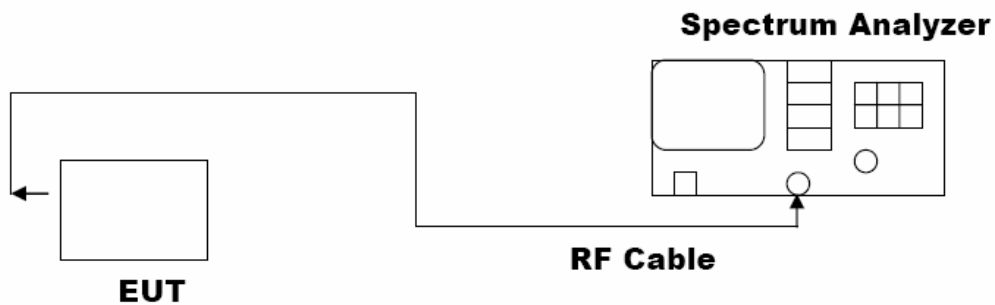

#### RADIATED METHOD

#### RADIATED MISSION TEST SETUP BELOW 1000MHz

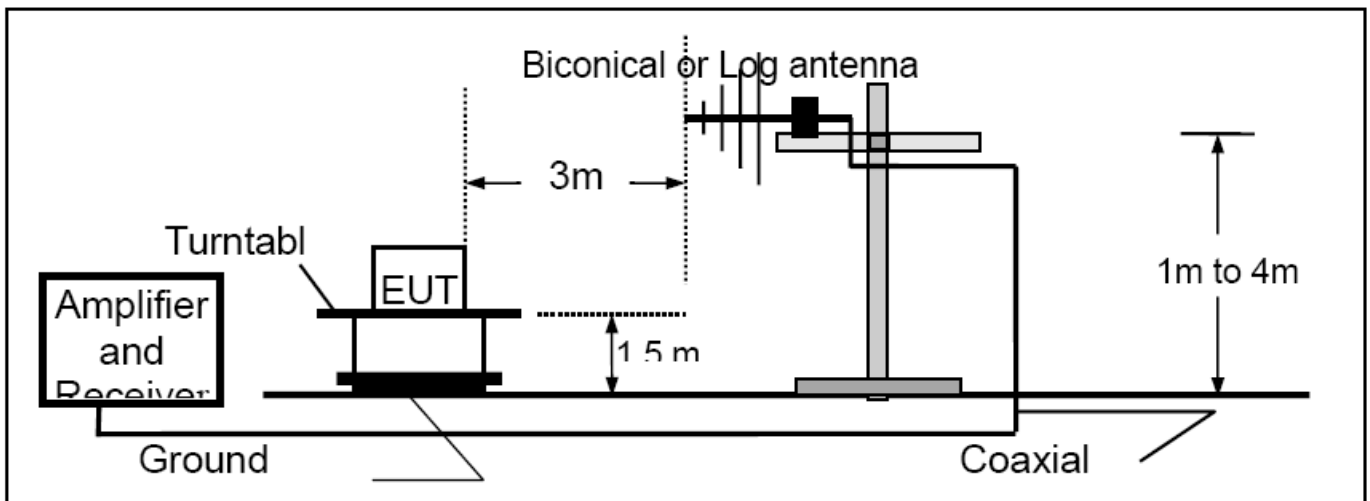

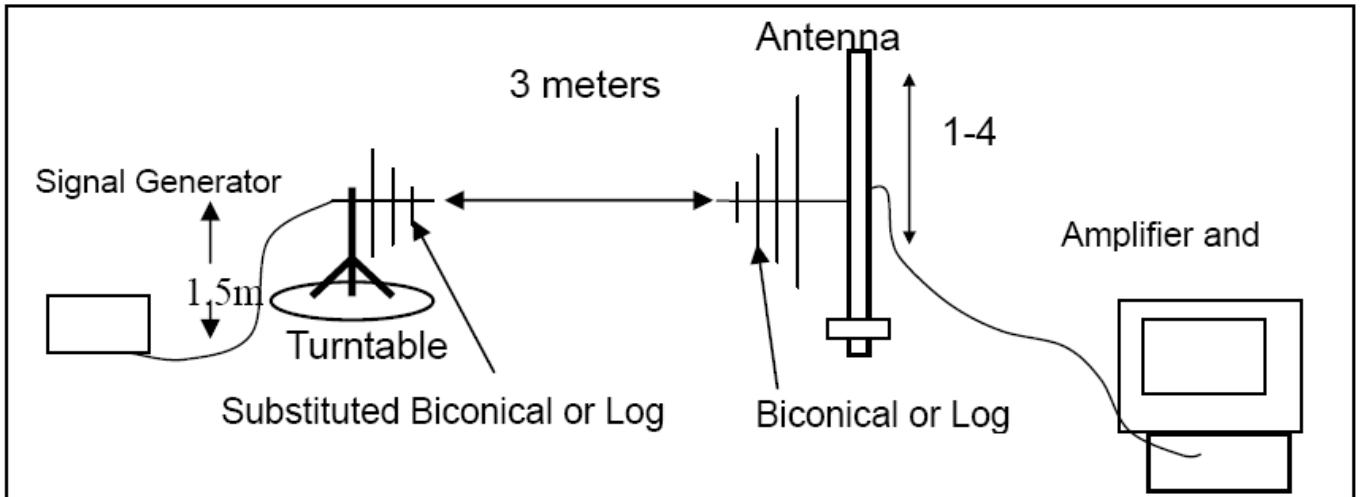

RADIATED EMISSION TEST SETUP UP ABOVE 1000MHz

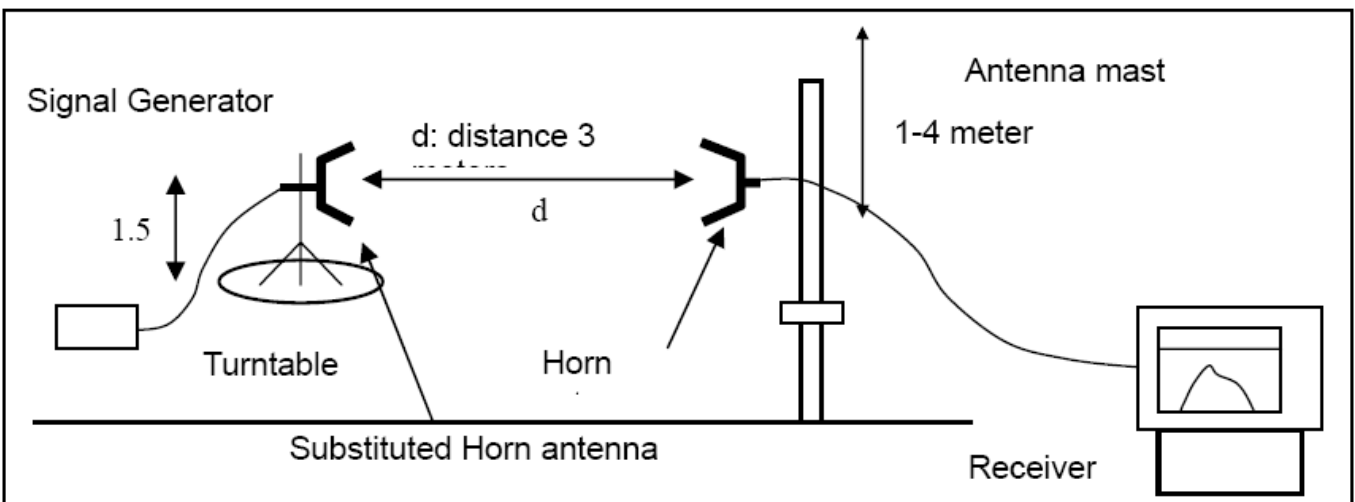
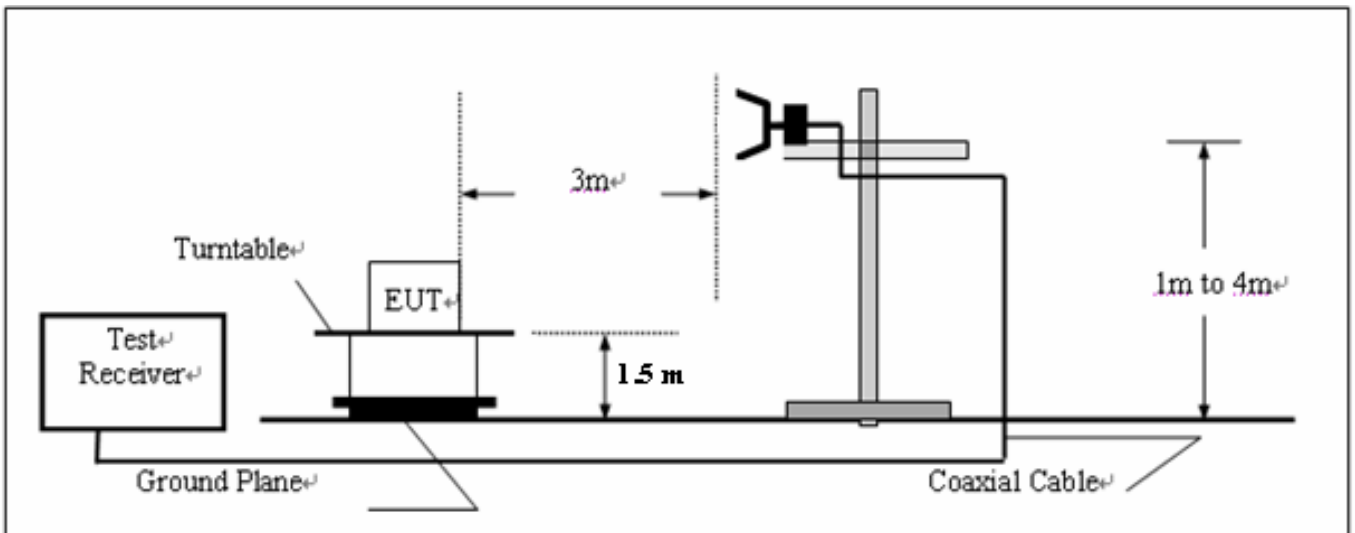

**6.3 MEASUREMENT EQUIPMENT USED:**

<b>3M ANECHOIC CHAMBER RADIATION TEST SITE</b>					
<b>EQUIPMENT TYPE</b>	<b>MFR</b>	<b>MODEL NUMBER</b>	<b>SERIAL NUMBER</b>	<b>LAST CAL.</b>	<b>CAL DUE.</b>
EMI Test Receiver	R&S	ESCS30	100343	04/16/2007	04/15/2008
AMPLIFIER	HP	HP8447E	2945A02715	04/16/2007	04/15/2008
ANTENNA	Sunol Sciences Corp.	JB3	A021907	04/16/2007	04/15/2008
ANTENNA	Sunol Sciences Corp.	JB3	A021907	04/16/2007	04/15/2008
Spectrum Analyzer	Agilent	E4440A	US41421290	04/16/2007	04/15/2008

6.4 LIMITS AND MEASUREMENT RESULT:

LIMITS AND MEASUREMENT RESULT				
Applicable Limits	Frequency	Measurement Result		
		EIRP (dBm)	Conducted (dBm)	Criteria
30 dBm	2.402GHz	-7.27	-9.80	PASS
30 dBm	2.441GHz	-6.87	-9.27	PASS
30 dBm	2.480GHz	-7.53	-10.04	PASS

TEST PLOT OF BOTTOM CHANNEL

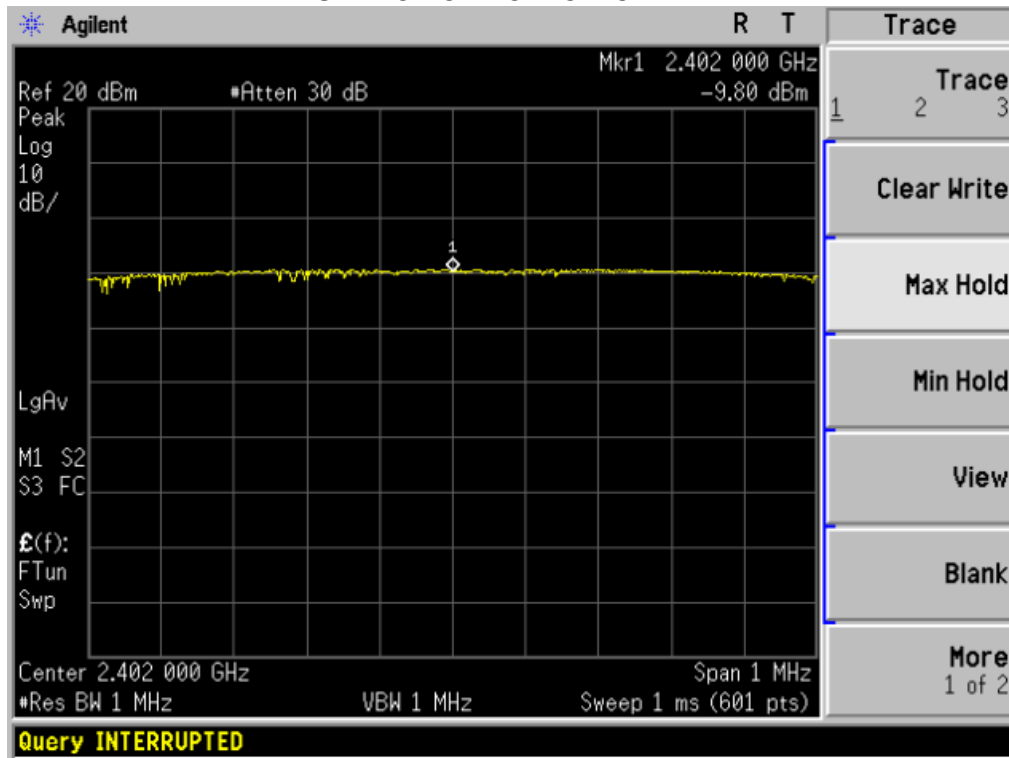

TEST PLOT OF MIDDLE CHANNEL

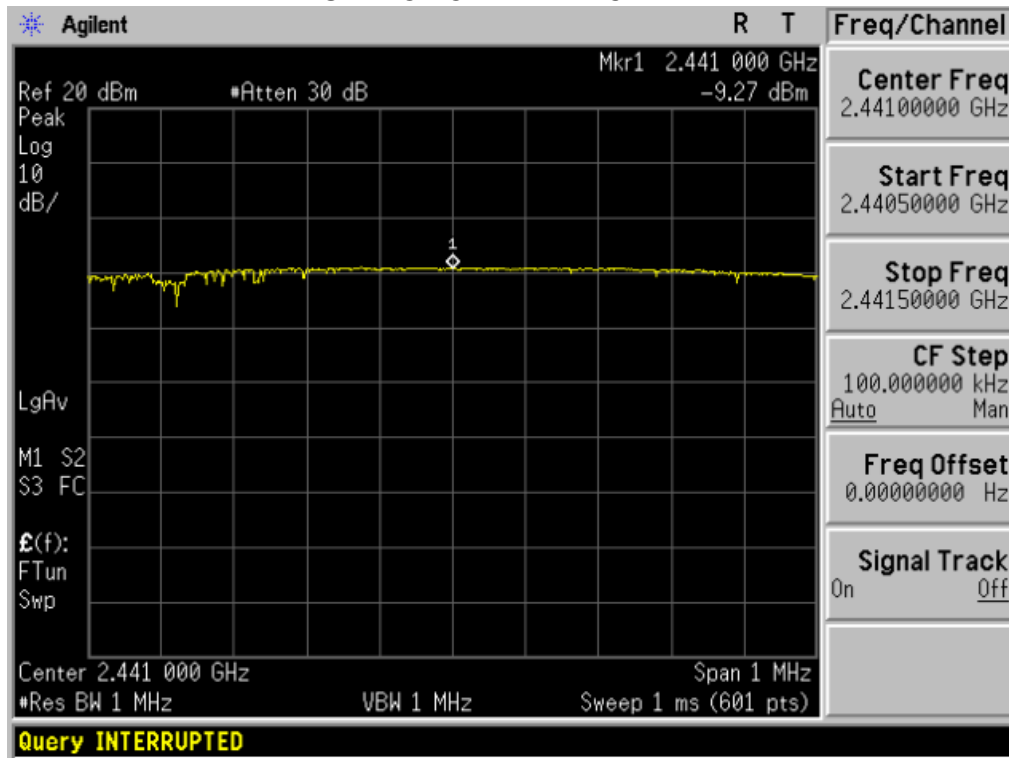

TEST PLOT OF TOP CHANNEL

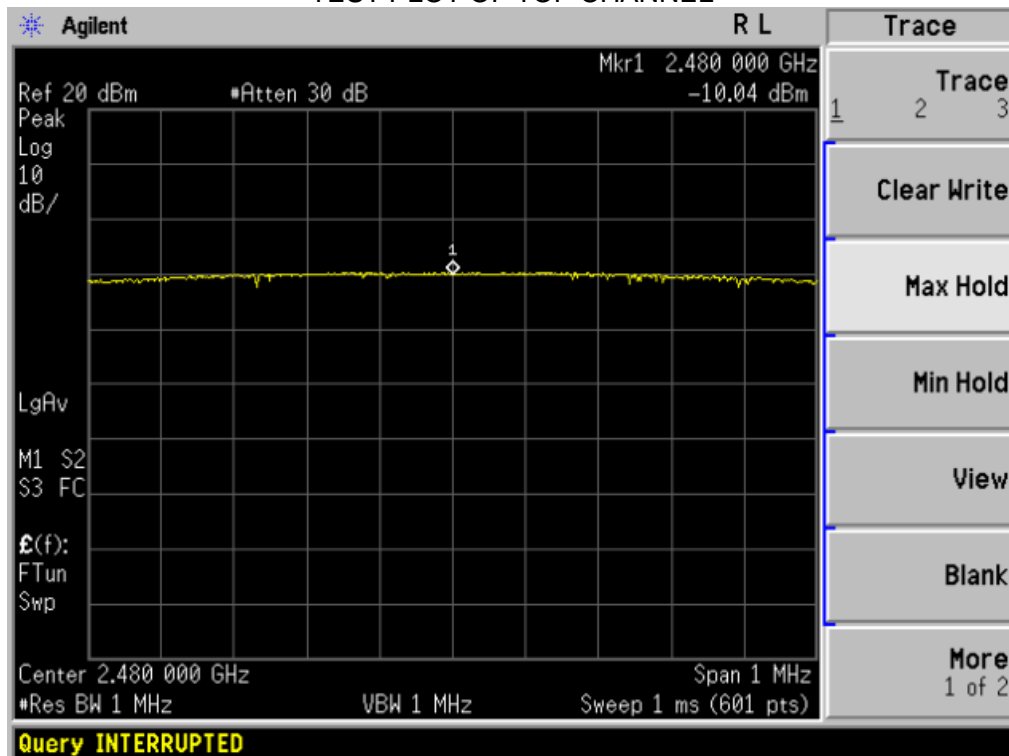

## 7. 20 DB BANDWIDTH

### 7.1 MEASUREMENT PROCEDURE

1. The EUT was placed on a turn table which is 0.8m above ground plane.
2. Connect EUT RF output port to the Spectrum Analyzer through an RF attenuator
3. Set the EUT Work on the top, the middle and the bottom operation frequency individually.
3. Set SPA Centre Frequency = Operation Frequency, RBW= 100 KHz, VBW= 100 KHz.
4. Set SPA Trace 1 Max hold, then View.

### 7.2 TEST SET-UP (BLOCK DIAGRAM OF CONFIGURATION)

The Same as described in Section 6.2

### 7.3 MEASUREMENT EQUIPMENT USED:

The same as described in Section 6.3

### 7.4 LIMITS AND MEASUREMENT RESULTS:

LIMITS AND MEASUREMENT RESULT			
Applicable Limits	Measurement Result		
	Test Data (MHz)		Criteria
--	Bottom Channel	1.013	PASS
	Middle Channel	1.014	PASS
	Top Channel	1.014	PASS

TEST PLOT OF BANDWIDTH FOR BOTTOM CHANNEL

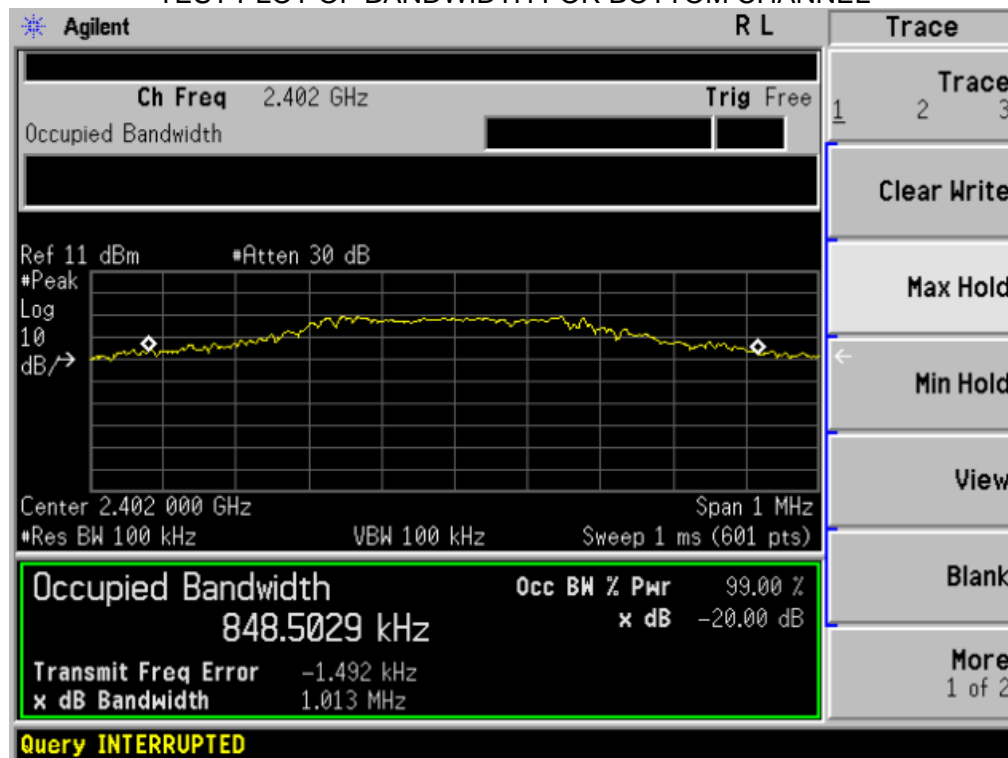

TEST PLOT OF BANDWIDTH FOR MIDDLE CHANNEL

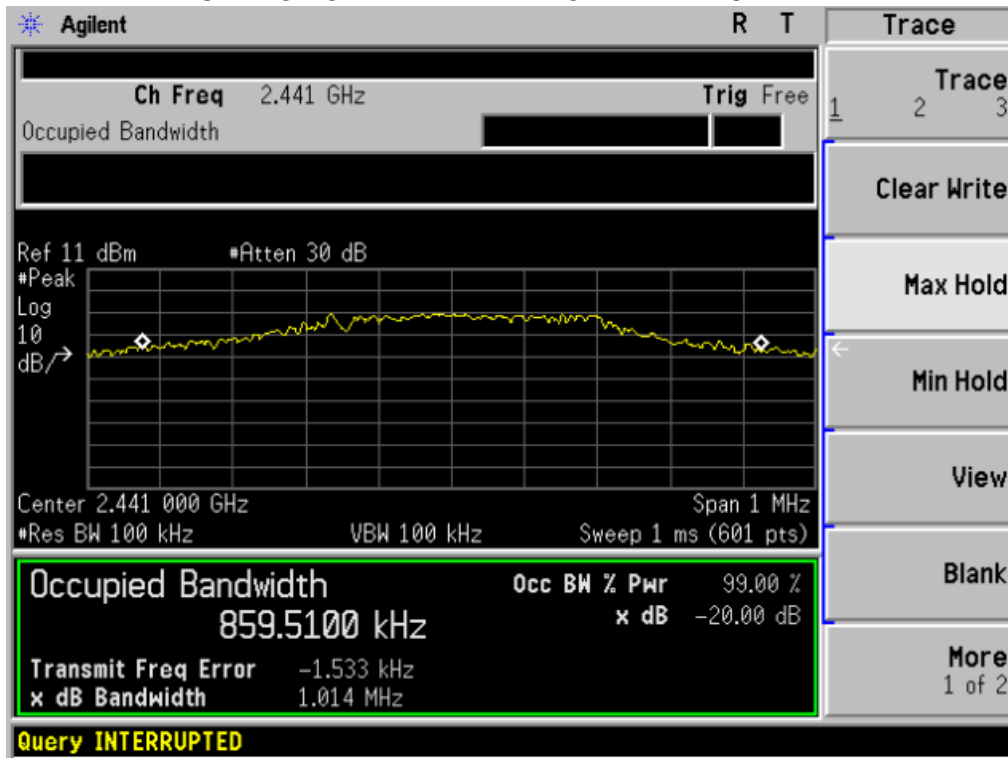

TEST PLOT OF BANDWIDTH FOR TOP CHANNEL

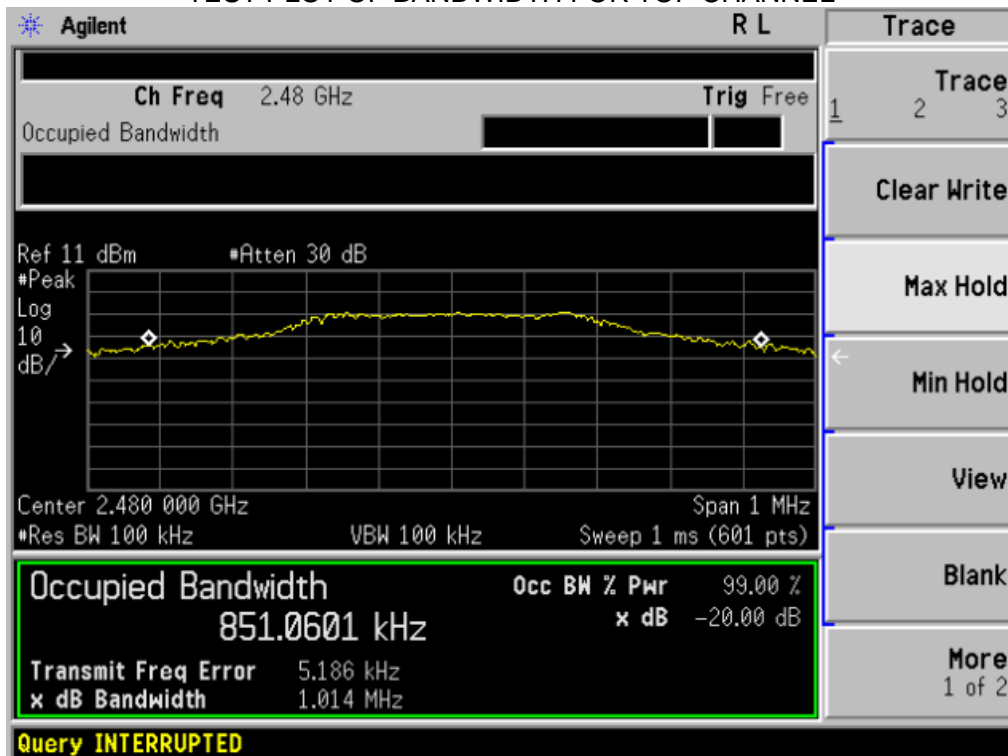



**8. MAXIMUM CONDUCTED OUTPUT POWER SPECTRAL DENSITY**

**8.1 MEASUREMENT PROCEDURE:**

- (1). The EUT was placed on a turn table which is 0.8m above ground plane.
- (2). Connect EUT RF output port to the Spectrum Analyzer through an RF attenuator
- (3). Set the EUT Work on the top, the middle and the bottom operation frequency individually.
- (4). Set SPA Centre Frequency = Operation Frequency, RBW= 3 KHz, VBW= 10 KHz., Sweep time= Auto
- (5). Set SPA Trace 1 Max hold, then View.

**8.2 TEST SET-UP (BLOCK DIAGRAM OF CONFIGURATION)**

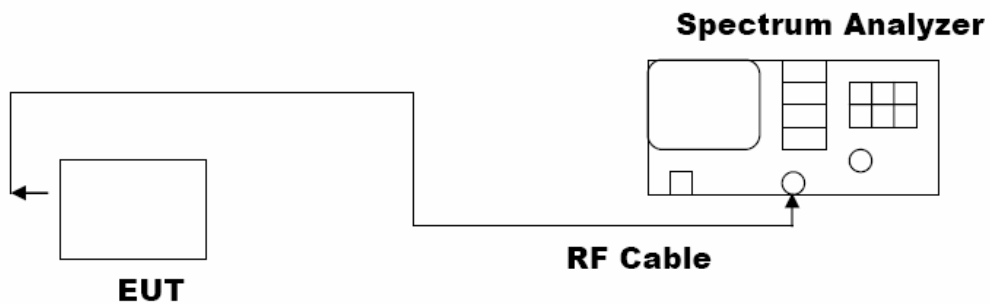

**8.3 MEASUREMENT EQUIPMENT USED:**

SHIELDING ROOM					
EQUIPMENT TYPE	MFR	MODEL NUMBER	SERIAL NUMBER	LAST CAL.	CAL DUE.
Spectrum Analyzer	Agilent	E4440A	US41421290	04/16/2007	04/15/2008

**8.4 LIMITS AND MEASUREMENT RESULT:**

LIMITS AND MEASUREMENT RESULT			
Applicable Limits	Measurement Result		
	Test Data (dBm/3KHz)		Criteria
8 dBm / 3KHz	Bottom Channel	-22.42	PASS
	Middle Channel	-22.88	PASS
	Top Channel	-23.82	PASS

TEST PLOT OF SPECTRAL DENSITY – BOTTOM CHANNEL

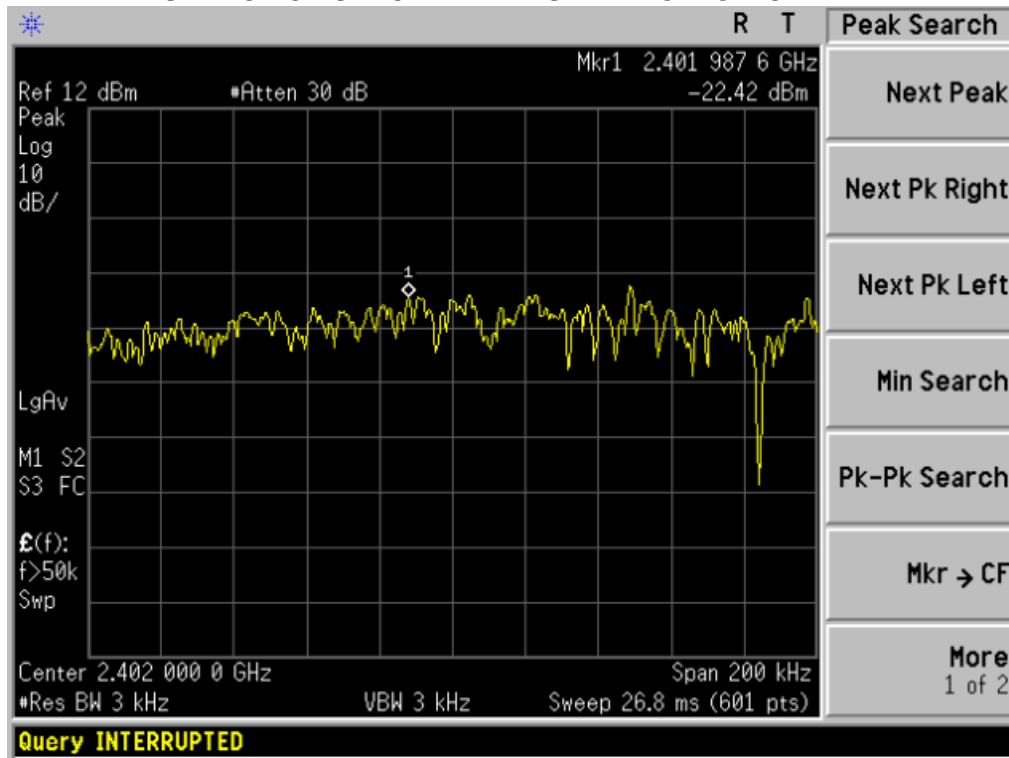

TEST PLOT OF SPECTRAL DENSITY – MIDDLE CHANNEL

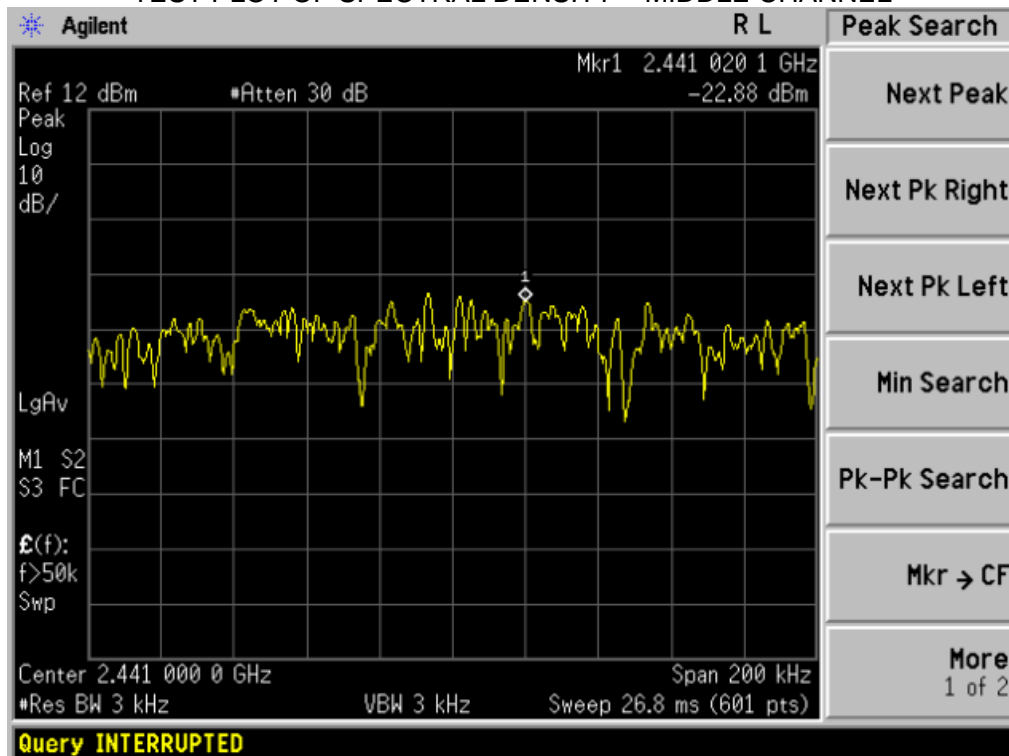

### TEST PLOT OF SPECTRAL DENSITY – TOP CHANNEL

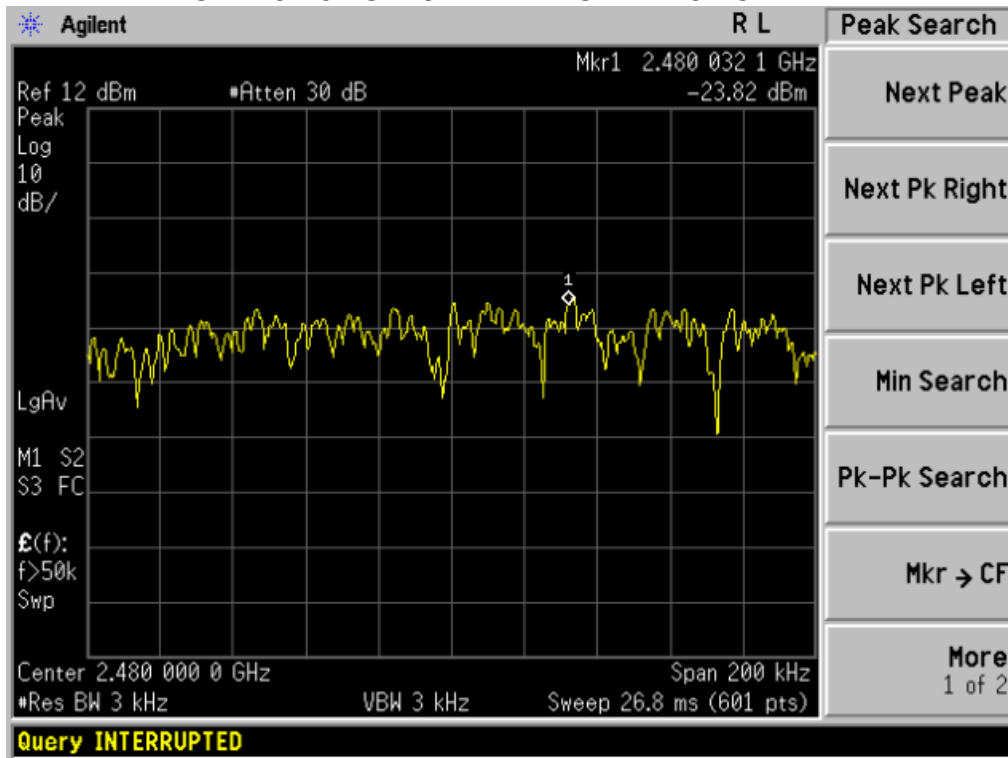

**9. OUT OF BAND EMISSION**

**9.1 MEASUREMENT PROCEDURE:**

1. The EUT was placed on a turn table which is 0.8m above ground plane.
2. Connect EUT RF output port to the Spectrum Analyzer through an RF attenuator
- 3, Set the EUT Work on the top, the middle and the bottom operation frequency individually.
3. Set SPA Centre Frequency = Operation Frequency, RBW= 100 KHz, VBW= 100 KHz.
4. Set SPA Trace 1 Max hold, then View.

**9.2 TEST SET-UP (BLOCK DIAGRAM OF CONFIGURATION)**

The Same as described in section 6.2

**9.3 MEASUREMENT EQUIPMENT USED:**

The Same as described in section 6.3

**9.4 LIMITS AND MEASUREMENT RESULT:**

<b>LIMITS AND MEASUREMENT RESULT</b>		
Applicable Limits	Measurement Result	
	Test Data	Criteria
In any 100 KHz bandwidth outside the frequency band in which the spread spectrum intentional radiator is operating, the radio frequency power that is produce by the intentional radiator shall be at least 20 dB below that in 100KHz bandwidth within the band that contains the highest level of the desired power.  In addition, radiation emissions which fall in the restricted bands, as defined in §15.205(a), must also comply with the radiated emission limits specified in§15.209(a))	At least -20dBc than the limit Specified on the BOTTOM Channel	PASS
	At least -20dBc than the limit Specified on the TOP Channel	PASS

TEST PLOT OF BAND ELDG FOR BOTTOM CHANNEL

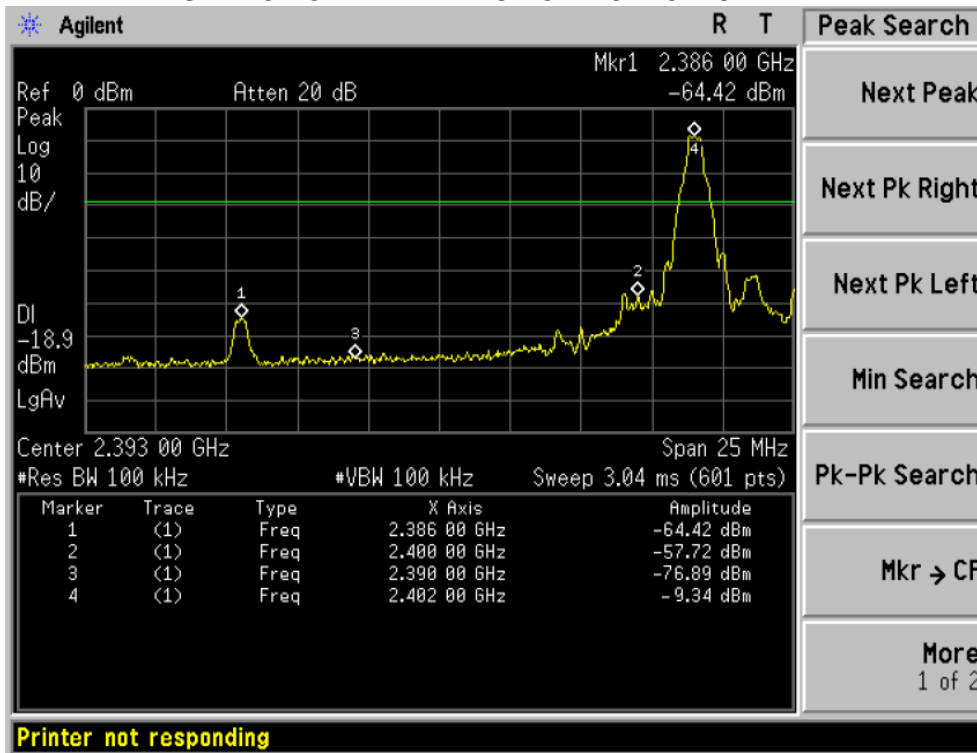

TEST PLOT OF BAND ELDG FOR TOP CHANNEL

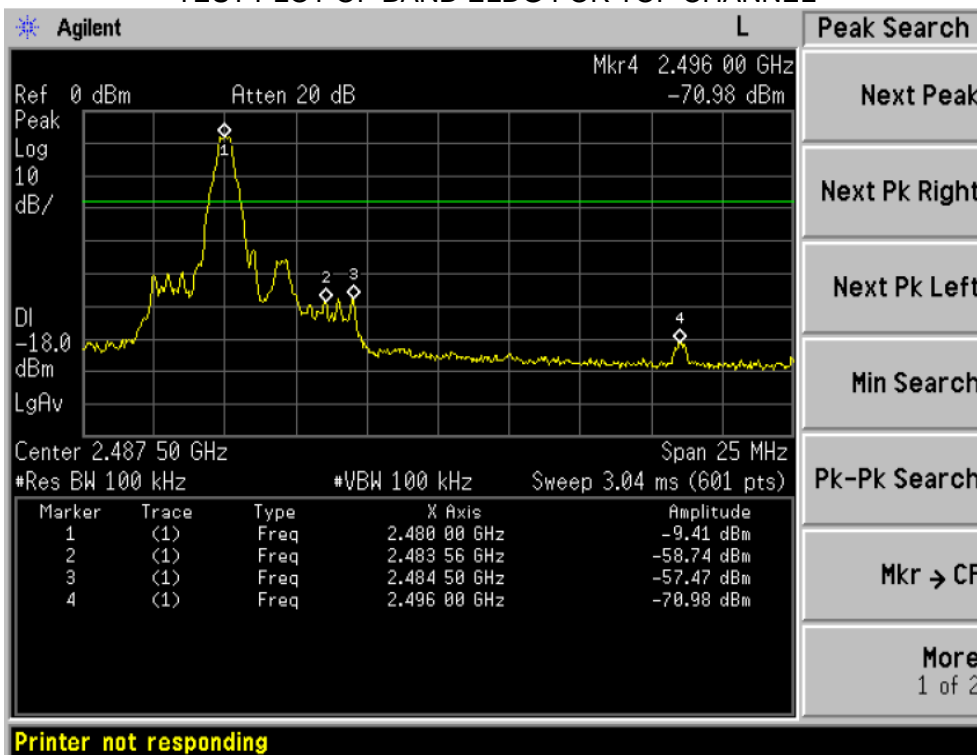

TEST PLOT OF OUT OF BAND EMISSIONS FOR BOTTOM CHANNEL - 1

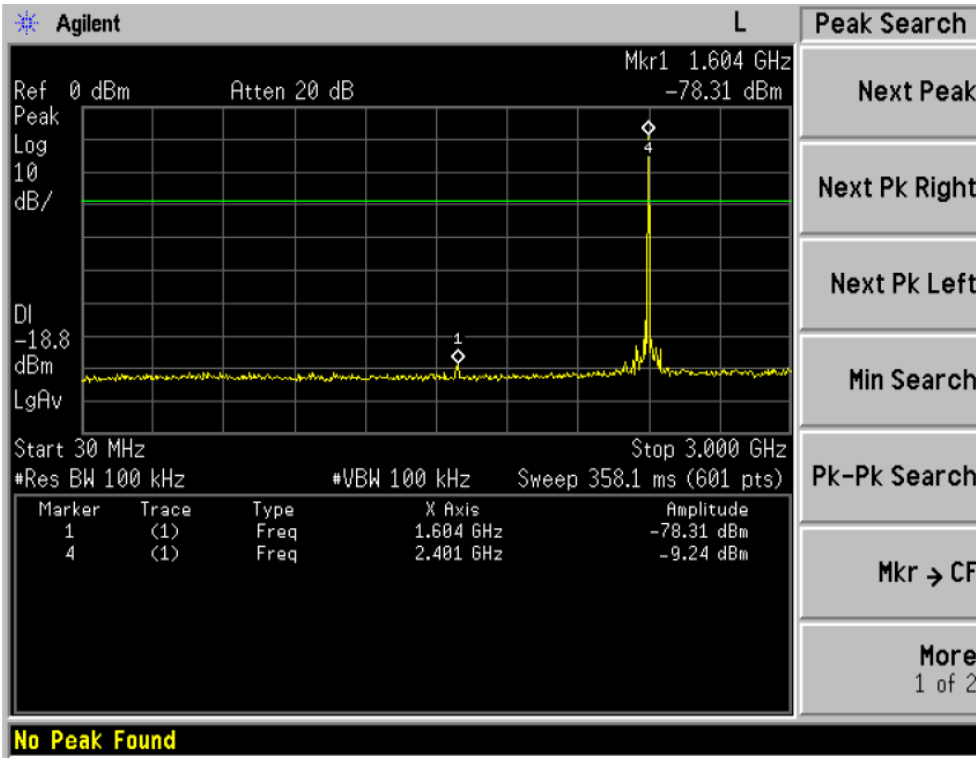

TEST PLOT OF OUT OF BAND EMISSIONS FOR BOTTOM CHANNEL - 2

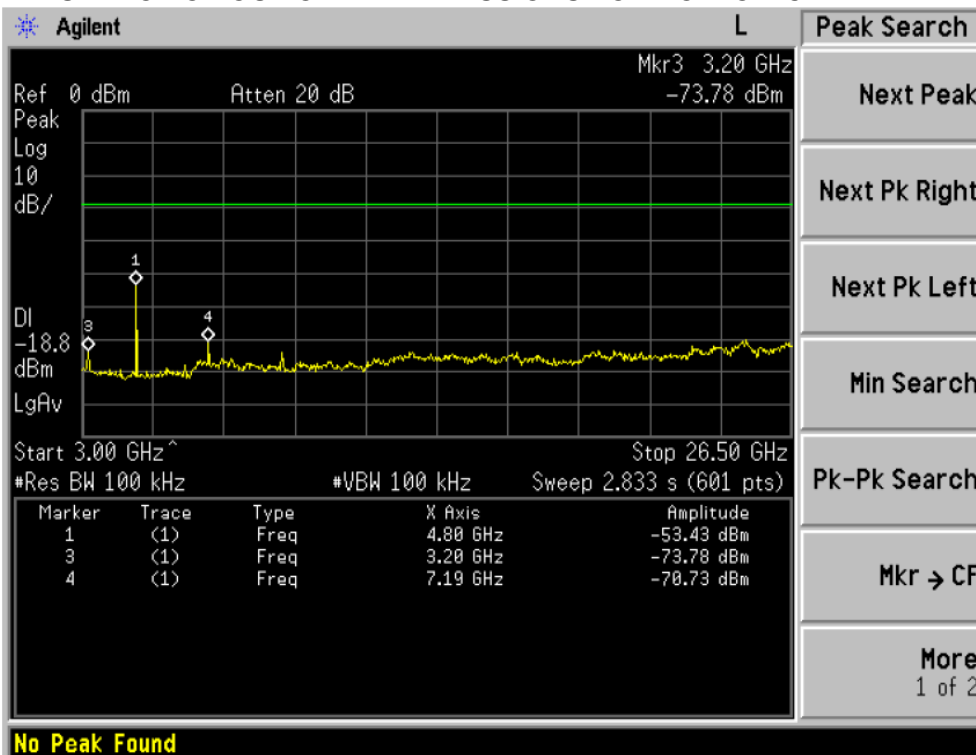

TEST PLOT OF OUT OF BAND EMISSIONS FOR MIDDLE CHANNEL – 1

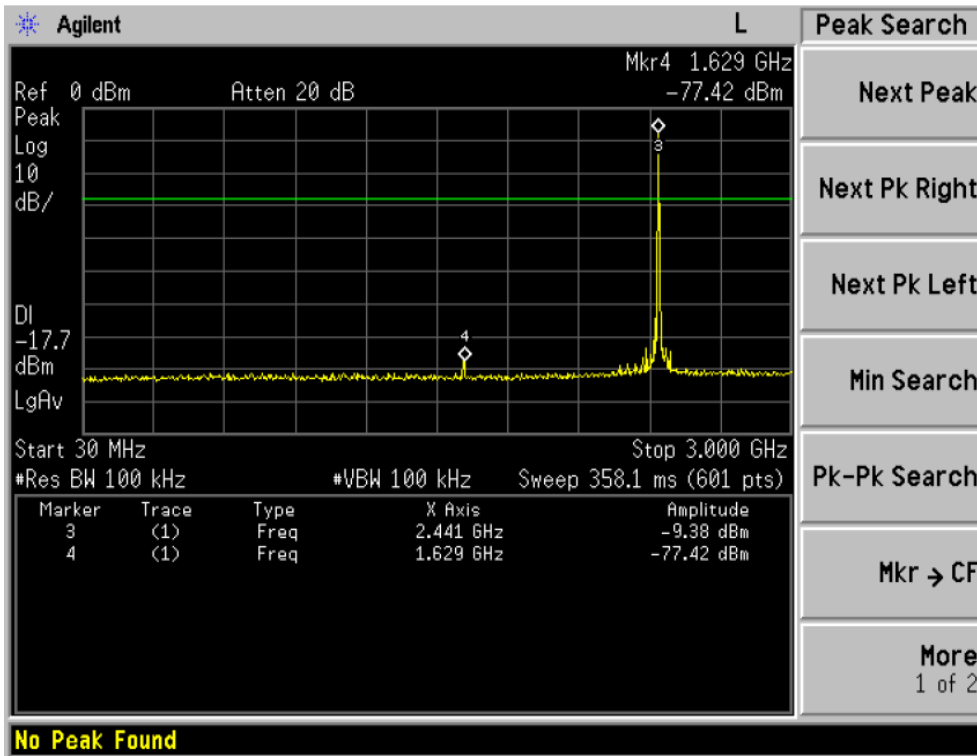

TEST PLOT OF OUT OF BAND EMISSIONS FOR MIDDLE CHANNEL – 2

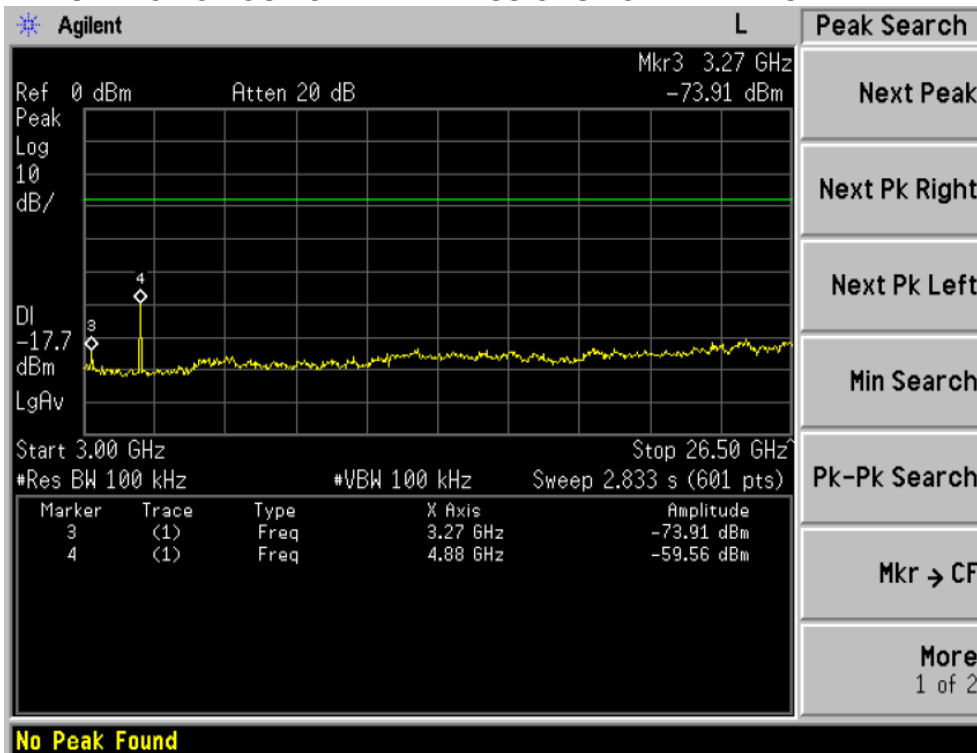

TEST PLOT OF OUT OF BAND EMISSIONS FOR TOP CHANNEL – 1

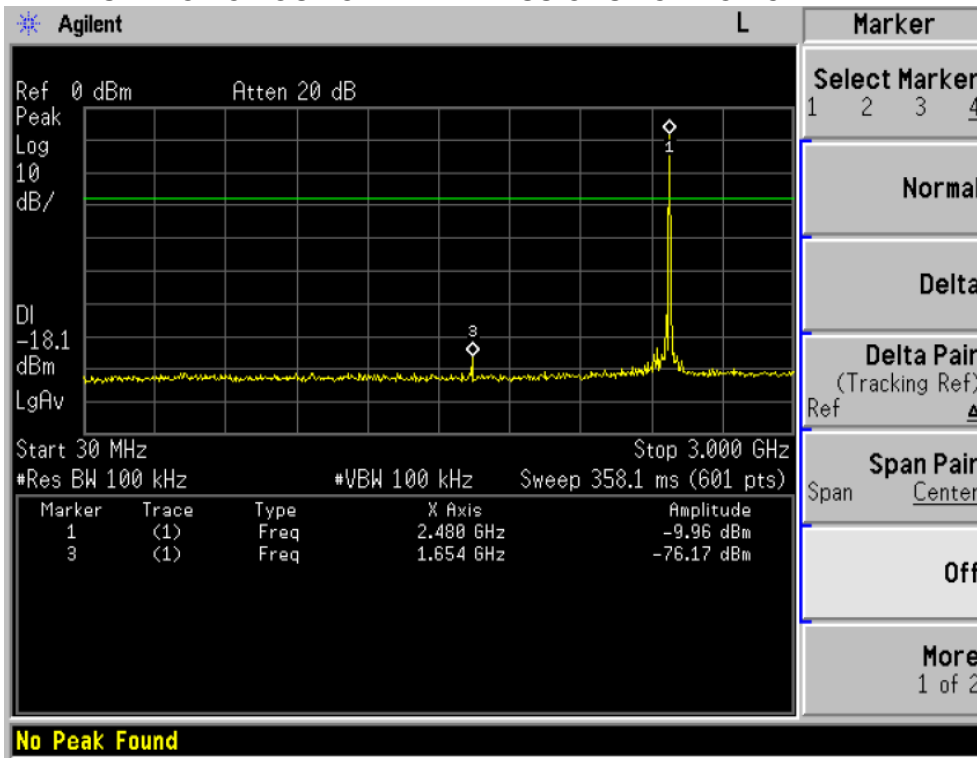

TEST PLOT OF OUT OF BAND EMISSIONS FOR TOP CHANNEL – 2

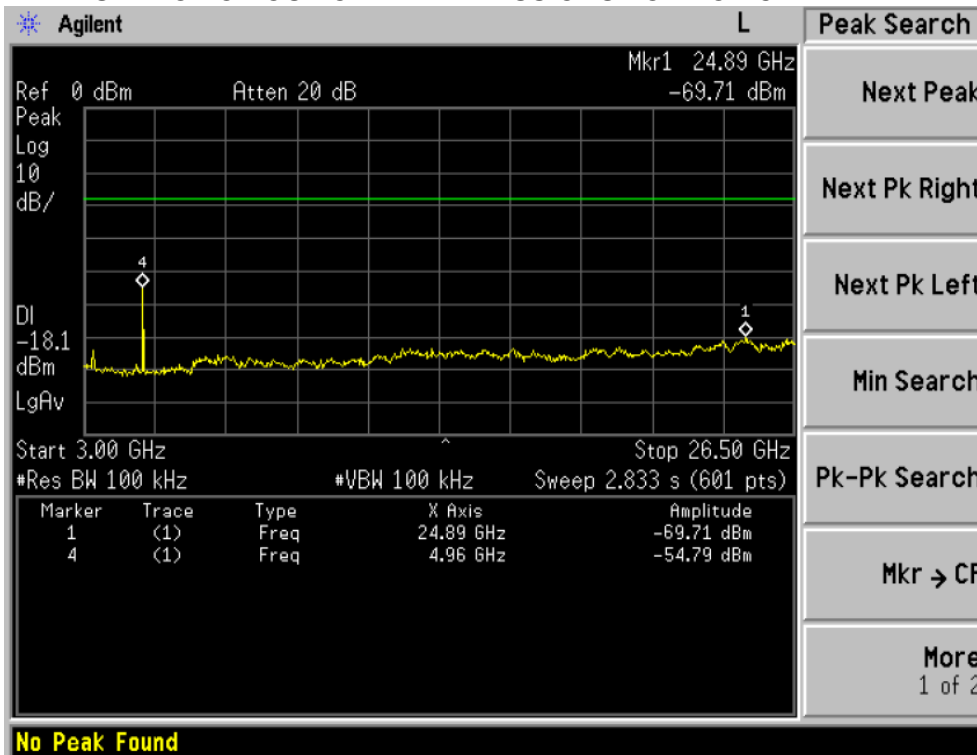



**RADIATED EMISSION TEST RESULT:**

Emission for Bottom/Middle/Top Channel Below 1GHz Charging mode & Transmitting						
Frequency	Antenna Pol.	Field Strength	Field Strength	Limit (PK)	Limit (AV)	Memo
MHz	H/V	dBuV/m (PK)	dBuV/m (AV)	dBuV/m	dBuV/m	
--	H/V	--	--	--	--	*
--	H/V	--	--	--	--	*
--	H/V	--	--	--	--	*
--	H/V	--	--	--	--	*

Band Edge Emission for Bottom Channel						
Frequency	Antenna Pol.	Field Strength	Field Strength	Limit (PK)	Limit (AV)	Memo
GHz	H/V	dBuV/m (PK)	dBuV/m (AV)	dBuV/m	dBuV/m	
2.386	H	46.33	40.19	74	54	*
2.400	H	54.19	47.14	74	54	*
2.386	V	45.19	39.88	74	54	*
2.400	V	52.28	45.17	74	54	*

Band Edge Emission for Top Channel						
Frequency	Antenna Pol.	Field Strength	Field Strength	Limit (PK)	Limit (AV)	Memo
GHz	H/V	dBuV/m (PK)	dBuV/m (AV)	dBuV/m	dBuV/m	
2.483	H	52.51	46.63	74	54	*
2.484	H	52.89	47.05	74	54	*
2.496	H	45.11	39.87	74	54	*
2.483	V	50.33	44.67	74	54	*
2.484	V	50.58	45.02	74	54	*
2.496	V	44.19	37.29	74	54	*

Restricted Band Emission for Bottom Channel						
Frequency	Antenna Pol.	Field Strength	Field Strength	Limit (PK)	Limit (AV)	Memo
GHz	H/V	dBuV/m (PK)	dBuV/m (AV)	dBuV/m	dBuV/m	
4.81	H	56.18	44.13	74	54	*
4.81	V	55.29	43.29	74	54	*
Above 4.81 GHz	H	--	--	74	54	*
	V	--	--	74	54	*

Restricted Band Emission for Middle Channel						
Frequency	Antenna Pol.	Field Strength	Field Strength	Limit (PK)	Limit (AV)	Memo
GHz	H/V	dBuV/m (PK)	dBuV/m (AV)	dBuV/m	dBuV/m	
4.88	H	52.29	41.29	74	54	*
4.88	V	51.18	40.29	74	54	*
Above 4.88 GHz	H	--	--	74	54	*
	V	--	--	74	54	*

Restricted Band Emission for Top Channel						
Frequency	Antenna Pol.	Field Strength	Field Strength	Limit (PK)	Limit (AV)	Memo
GHz	H/V	dBuV/m (PK)	dBuV/m (AV)	dBuV/m	dBuV/m	
4.95	H	55.53	43.77	74	54	*
4.95	V	53.49	41.87	74	54	*
Above 4.95GHz	H	--	--	74	54	*
	V	--	--	74	54	*

**Note:** "--" Indicated the test value is much lower to limit.

## 10. NUMBER OF HOPPING FREQUENCY

### 10.1 MEASUREMENT PROCEDURE

1. Place the EUT on the table and set it in transmitting mode.
2. Remove the antenna from the EUT and then connect a low RF cable from the antenna port to the spectrum analyzer.
3. Set the spectrum analyzer Start = 2.4GHz Stop = 2.4835GHz, Sweep = Auto
4. Set the Spectrum Analyzer as RBW = VBW = 1MHz

### 10.2 TEST SETUP (BLOCK DIAGRAM OF CONFIGURATION)

Same as described in section 6.2

### 10.3 MEASUREMENT EQUIPMENT USED

The Same as described in section 6.3

### 10.4 LIMITS AND MEASUREMENT RESULT:

TOTAL NO. OF HOPPING CHANNEL	LIMIT (NO. OF CH)	MEASUREMENT (NO. OF CH)	RESULT
	>=15	79	PASS

TEST PLOT FOR NO. OF TOTAL CHANNELS

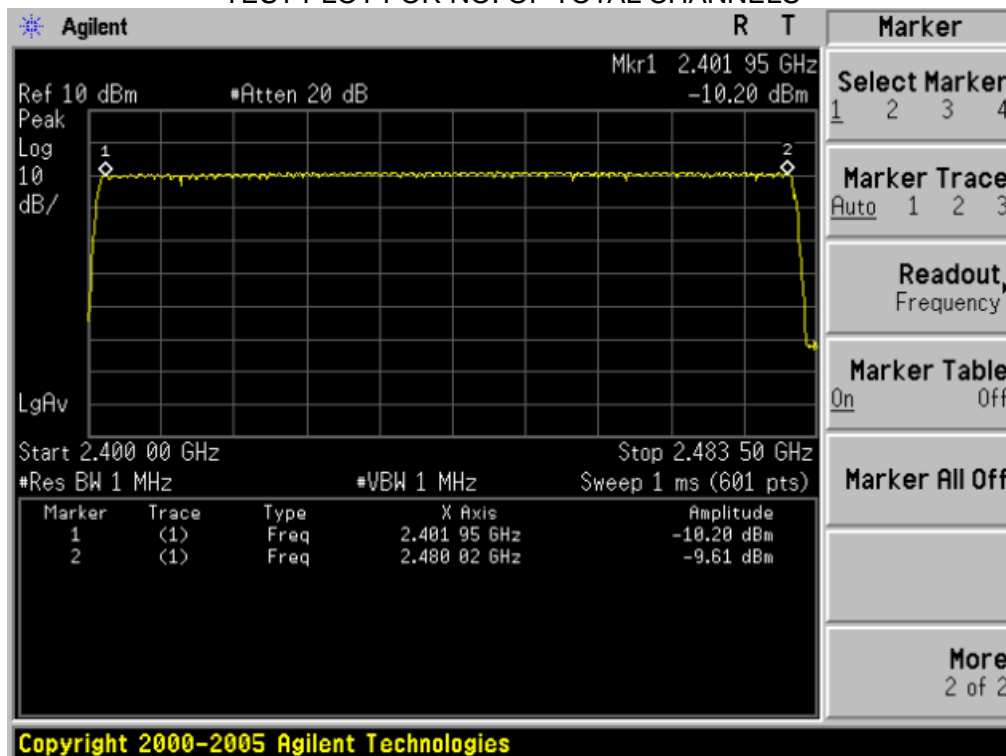

## 11. TIME OF OCCUPANCY (DWELL TIME)

### 11.1 MEASUREMENT PROCEDURE

1. Place the EUT on the table and set it in transmitting mode
2. Remove the antenna from the EUT and then connect a low RF cable from the antenna port to the spectrum analyzer
3. Set center frequency of spectrum analyzer = Operating frequency
4. Set the spectrum analyzer as RBW, VBW=1MHz, Span = 0 Hz,

### 11.2 TEST SETUP (BLOCK DIAGRAM OF CONFIGURATION)

Same as described in section 6.2

### 11.3 MEASUREMENT EQUIPMENT USED

The same as described in section 6.3

### 11.4 LIMITS AND MEASUREMENT RESULT

The dwell time = Time Slot Length \* Hop Rate / Number of Hopping Channels \* 0.4 \* 79

L-CH:

$$\text{DH1 Time Slot} = 0.365 \text{ (ms)} * (1600/(2*79))*31.6 = 116.8 \text{ (ms)}$$

M-CH:

$$\text{DH1 Time Slot} = 0.367 \text{ (ms)} * (1600/(2*79))*31.6 = 117.8 \text{ (ms)}$$

H-CH:

$$\text{DH1 Time Slot} = 0.371 \text{ (ms)} * (1600/(2*79))*31.6 = 118.7 \text{ (ms)}$$

DWELL TIME TEST PLOT OF BOTTOM CHANNEL

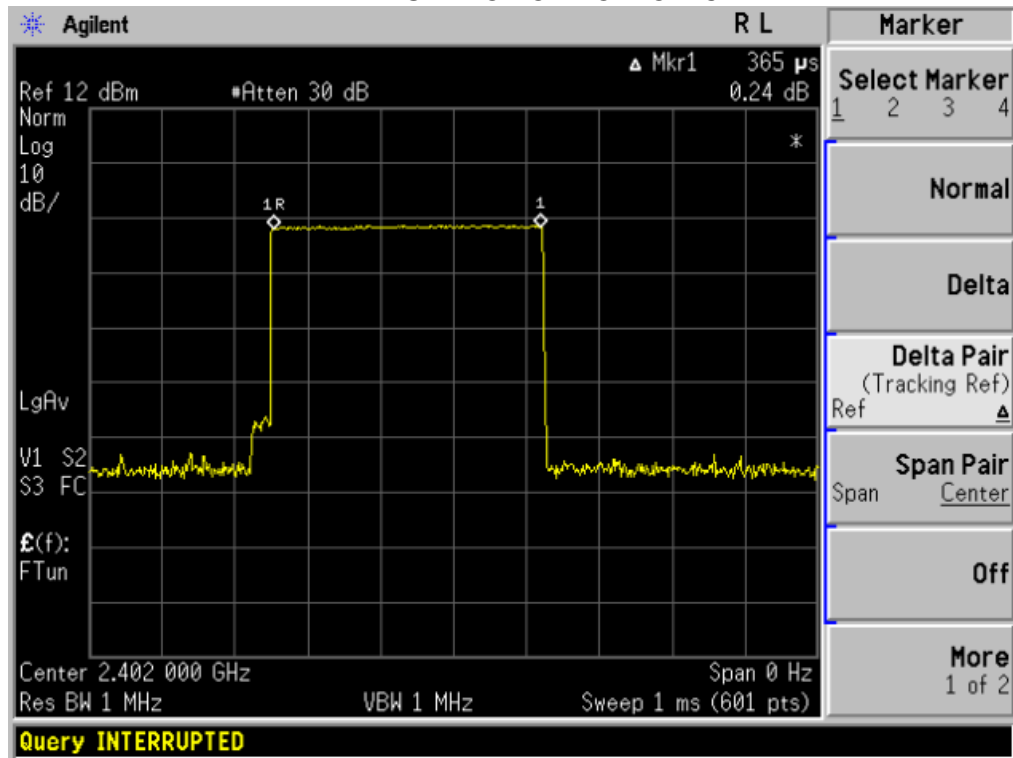

DWELL TIME TEST PLOT OF MIDDLE CHANNEL

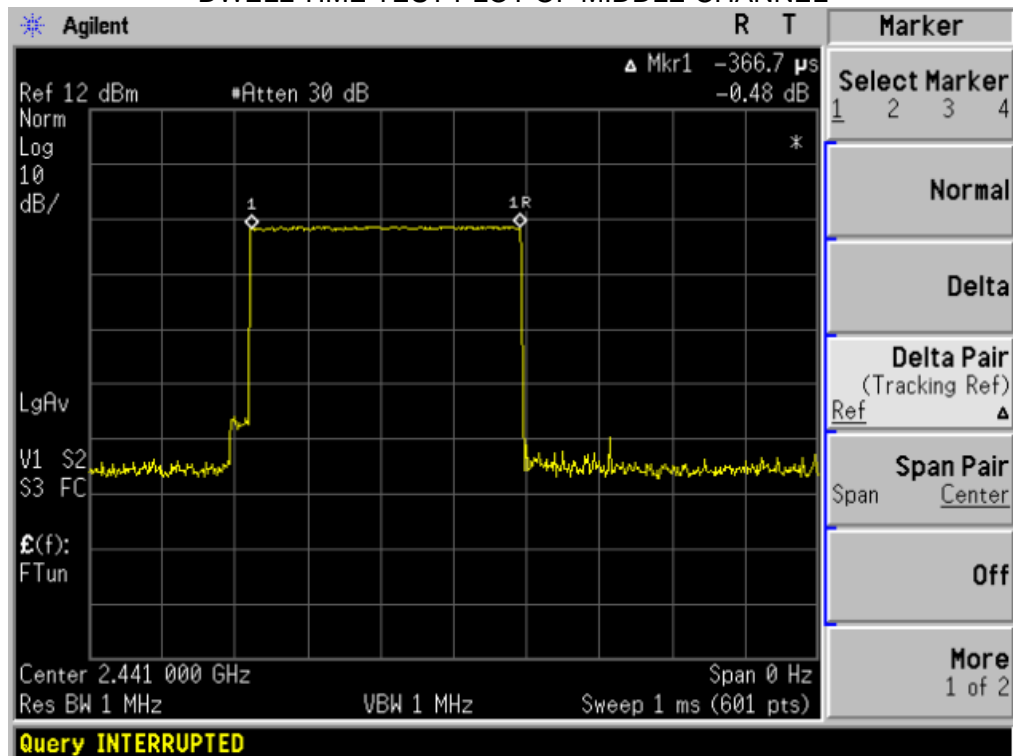

DWELL TIME TEST PLOT OF TOP CHANNEL

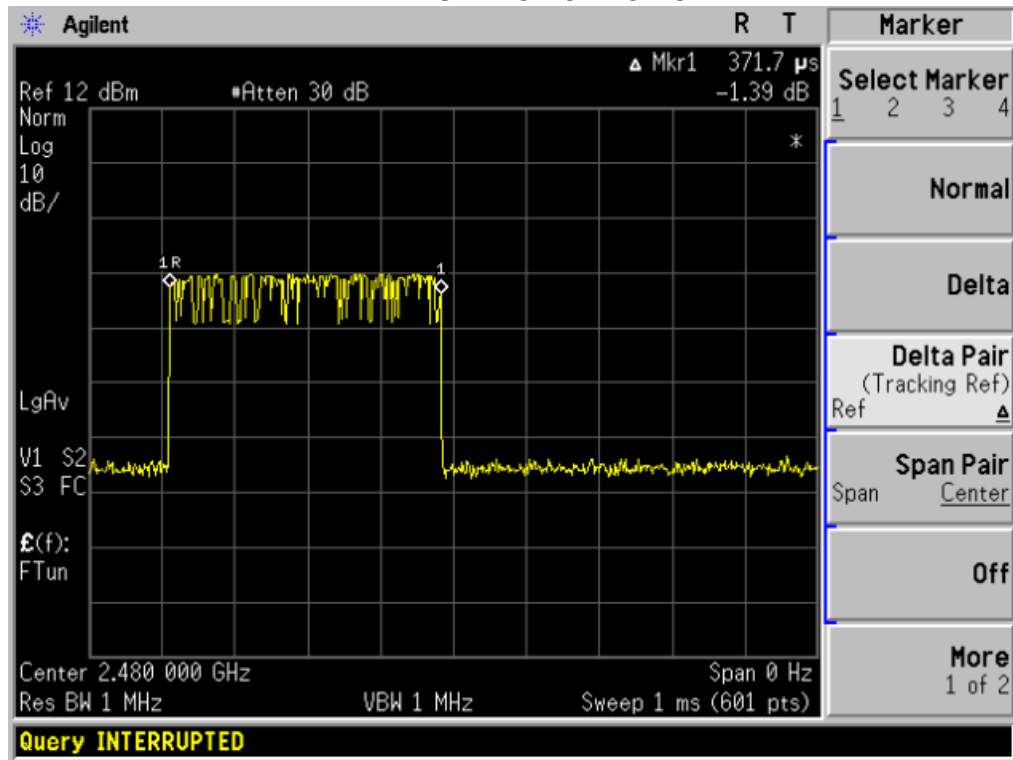

## 12. FREQUENCY SEPARATION

### 12.1 MEASUREMENT PROCEDURE

1. Place the EUT on the table and set it in transmitting mode
2. Remove the antenna from the EUT and then connect a low RF cable from the antenna port to the spectrum analyzer
3. Set center frequency of spectrum analyzer = Middle of Operating frequency
4. Set the spectrum analyzer as RBW, VBW=100KHz, Span = 5 MHz,

### 12.2 TEST SETUP (BLOCK DIAGRAM OF CONFIGURATION)

Same as described in section 6.2

### 12.3 MEASUREMENT EQUIPMENT USED

The same as described in section 6.3

### 12.4 LIMITS AND MEASUREMENT RESULT

CHANNEL SEPARATION	LIMIT	RESULT
KHz	KHz	Pass
1000	$\geq 25$ KHz or 2/3 20 dB BW	

TEST PLOT FOR FREQUENCY SEPARATION

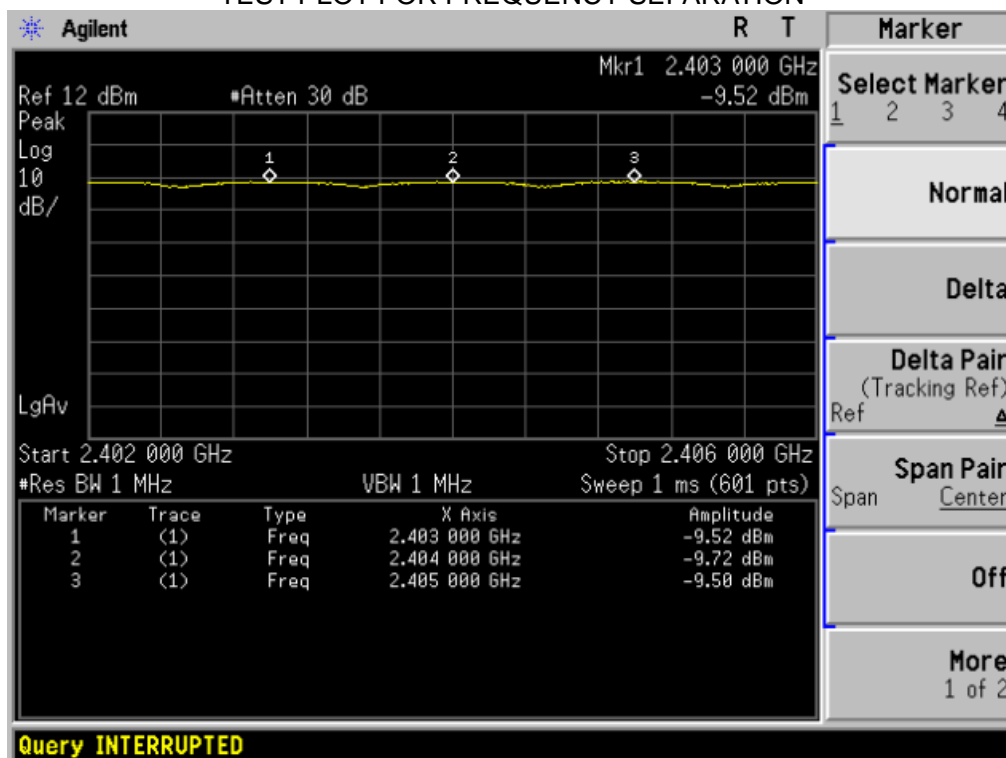

# **APPENDIX 1**

## **PHOTOGRAPHS OF SET UP**



RADIATED EMISSION TEST SETUP - TRANSMITTING

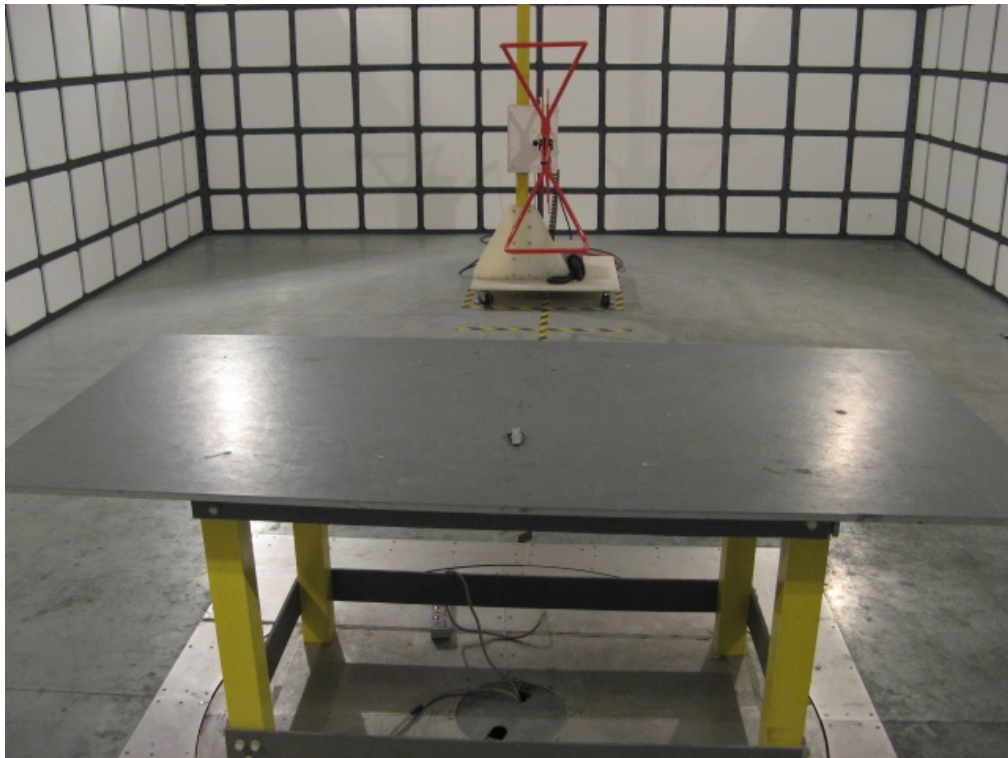

RADIATED EMISSION TEST SETUP – CHARGING



CONDUCTED EMISSION TEST – CHARGING



## **APPENDIX 2**

### **PHOTOGRAPHS OF EUT**

FRONT VIEW OF SAMPLE



BOTTOM VIEW OF EUT



LEFT VIEW OF SAMPLE



RIGHT VIEW OF SAMPLE





TOP VIEW OF SAMPLE



BOTTOM VIEW OF SAMPLE



INTERNAL VIEW OF SAMPLE – 1



INTERNAL VIEW OF SAMPLE – 2



----END OF REPORT----