



Thank you for purchasing RYOBI™ Phone Works™

If you need assistance
DO NOT RETURN TO THE STORE
Please contact us at 1-877-578-6736

This app is optimized for:

iOS versions 6.0 and higher • Android versions 4.0 and higher

For a full list of compatible phones please visit
www.ryobitools.com/phoneworks

ES3001 MOISTURE METER IMPORTANT SAFETY INSTRUCTIONS

⚠ WARNING!

READ AND UNDERSTAND ALL INSTRUCTIONS. Failure to follow all instructions listed below, may result in electric shock, fire and/or serious personal injury.

⚠ WARNING:

Changes or modifications to this unit not expressly approved by the party responsible for compliance could void the user's authority to operate the equipment.

⚠ WARNING:

Use of controls, adjustments, or performance of procedures other than those specified here can result in hazardous radiation exposure.

- **Read operator's manual carefully. Learn the applications and limitations, as well as the specific potential hazards, related to this device.** Following this rule will reduce the risk of electric shock, fire, or serious injury.
- **Do not operate battery devices in explosive atmospheres, such as in the presence of flammable liquids, gases or dust.** Battery devices create sparks which may ignite the dust or fumes.
- **Do not disassemble the device.** Contact with internal parts may increase the risk of electric shock or cause damage to the device.
- **Do not use on a ladder or unstable support.** Stable footing on a solid surface enables better control of the device in unexpected situations.
- **Do not store the device in an area of high heat or humidity. Do not expose the device to extended high heat from the sun (such as on a vehicle dashboard.) To reduce the risk of serious personal injury, do not store outside or in vehicles.** Damage to the device or the battery can result.

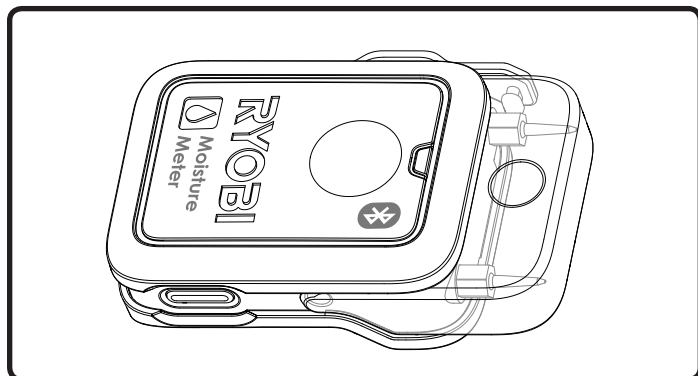



- **Do not expose device to rain or wet conditions.** Water entering a device will increase the risk of electric shock.
- **Use the device in accordance with these instructions and in the manner intended for the device, taking into account the environmental conditions and the work to be performed.** Use of the device for operations different from those intended could result in a hazardous situation.
- **The electrode measurement pins are extremely sharp.** Use care when handling this device. Cover the pins with the protective cap when the device is not in use.
- **Keep device away from children and do not allow them to handle.** Store in a secure area away from children.
- **Handle the device with care.** Treat it as you would any other optical device such as a camera or binoculars.
- **Avoid exposing the device to shock, continuous vibration, or extreme hot or cold temperatures.** Damage to the device and/or serious injury to the user could result.
- **Ensure the device is disconnected before inserting or changing batteries.**
- **Do not mix old and new batteries or different brands of batteries.**
- **Remove batteries from the device when not in use for an extended time.**

IMPORTANT SAFETY INSTRUCTIONS



- **Always replace the alkaline battery with the same type of alkaline battery.** Use of any other battery packs may create a risk of injury and fire.
- **This device should not be operated unless the battery compartment is closed.**
- **Do not place battery devices or their batteries near fire or heat.** This will reduce the risk of explosion and possibly injury.
- **Do not crush, drop or damage battery. Do not use batteries that have been dropped or received a sharp blow.** A damaged battery is subject to explosion. Properly dispose of a dropped or damaged battery immediately.
- **Batteries can explode in the presence of a source of ignition, such as a pilot light.** To reduce the risk of serious personal injury, never use any battery device in the presence of open flame. An exploded battery can propel debris and chemicals. If exposed, flush with water immediately.
- **Under extreme usage or temperature conditions, battery leakage may occur. If liquid comes in contact with your skin, wash immediately with soap and water. If liquid gets into your eyes, flush them with clean water for at least 10 minutes, then seek immediate medical attention.** Following this rule will reduce the risk of serious personal injury.
- **Save these instructions.** Refer to them frequently and use them to instruct others who may use this device. If you loan someone this device, loan them these instructions also.

SYMBOLS

The following signal words and meanings are intended to explain the levels of risk associated with this product.

SYMBOL	SIGNAL	MEANING
	DANGER:	Indicates a hazardous situation, which, if not avoided, will result in death or serious injury.
	WARNING:	Indicates a hazardous situation, which, if not avoided, could result in death or serious injury.
	CAUTION:	Indicates a hazardous situation, that, if not avoided, may result in minor or moderate injury.
	NOTICE:	(Without Safety Alert Symbol) Indicates information considered important, but not related to a potential injury (e.g. messages relating to property damage).

Some of the following symbols may be used on this product. Please study them and learn their meaning. Proper interpretation of these symbols will allow you to operate the product better and safer.

SYMBOL	NAME	DESIGNATION/EXPLANATION
	Safety Alert	Indicates a potential personal injury hazard.
	Read Operator's Manual	To reduce the risk of injury, user must read and understand operator's manual before using this product.
	Puncture Hazard	The electrode measurement pins are extremely sharp. Use care when handling this device. Cover the pins with the protective cap when the device is not in use.

FEATURES

YOU MAY USE THE MOISTURE METER FOR THE FOLLOWING PURPOSES:

- Measure approximate moisture levels in wood, concrete and other materials as designated by the app

- Capture, save, and share data images on your smartphone
- Chart moisture levels over time on specific projects
- Save and access previous projects
- Record a voice note in saved projects



ICON	DESCRIPTION/FUNCTION
	Main RYOBI™ Phone Works™ app home screen
PROJECT 1	Project name (displays current project name)
63% HUMIDITY	Current outdoor relative humidity in your area
16.0%	Measured moisture content
BEECH	Select material
	Turn camera on
	Turn camera off

ICON	DESCRIPTION/FUNCTION
	Save or access projects in file cabinet
	Notes
	Share
	Quick reference scale
	Take a picture
	Graph moisture levels
	Device battery level
	Settings

ASSEMBLY

⚠ WARNING:

Do not use this product if it is not completely assembled or if any parts appear to be missing or damaged. Use of a product that is not properly and completely assembled or with damaged or missing parts could result in serious personal injury.

⚠ WARNING:

Do not attempt to modify this product or create accessories not recommended for use with this product. Any such alteration or modification is misuse and could result in a hazardous condition leading to possible serious personal injury.

If any parts are damaged or missing, please call 1-877-578-6736 for assistance.

OPERATION

INSTALLING/REPLACING THE AAA BATTERY

See Figure 1.

One AAA battery is preinstalled in the unit. Before first use, locate and remove the red pull tab to activate the battery.

- Remove the battery cover by inserting the edge of a coin into the slot on the bottom and twisting.
- Install the battery according to the polarity indicators.
- Replace the battery cover, making sure the notches align, and press it securely into place.
- Do not use the product without the battery cover installed.

NOTE: Remove the battery for storage when device will not be used for long periods of time.

PAIRING THE DEVICE TO YOUR SMARTPHONE

- Select and open the RYOBI™ Phone Works™ app.
- Open the **MOISTURE METER** app segment.
- Press and hold the ON/OFF button until the LED light starts to flash.
- Select the moisture meter under the list of devices shown on the app.

NOTE: If you do not see the moisture meter listed, select scan in the app. Select the device.

USING THE MOISTURE METER

See Figure 2.

⚠ WARNING:

The electrode measurement pins are extremely sharp. Use care when handling this device. Cover the pins with the protective cap when the device is not in use.

- Select and open the RYOBI™ Phone Works™ app.
- Tap Material on the app screen and choose the applicable material from the list.
- **Remove the electrode cover.**
- Insert the electrode measurement pins into the material.

Fig. 1

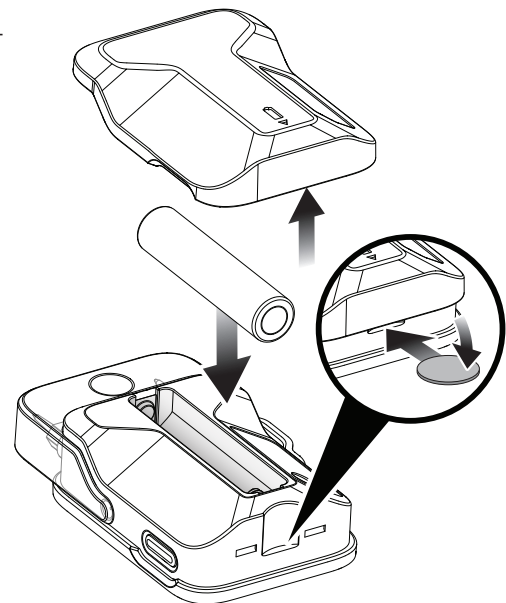



Fig. 2

BEECH	Select material
	Quick reference scale
	Graph moisture levels

- Allow a few seconds for the device to process the measurement.

QUICK REFERENCE SCALE

- Shows the moisture level at a glance:

GREEN: Selected material is suitably dry for its intended purpose.

YELLOW: Moisture content is higher than normal, but may be acceptable for use.

RED: Moisture content is too high for most purposes.

OPERATION

TAKING A PICTURE

The RYOBI™ Phone Works™ app allows you to take a picture of the screen to save for future reference or share via email or social media. This function captures all settings displayed on the current screen. It will work with or without activating the smartphone's built-in camera.

- Tap the appropriate camera icon in the lower left portion of the screen.
- Tap the large green button to take the picture on the screen.
- The picture just taken will appear on the screen.
- To save, swipe the picture toward the file cabinet.
- To delete, swipe to the right and the picture will be deleted.

NOTE: Pictures will be saved into the project name. To save into another project, see *Managing Your Projects* below.

- Multiple pictures can be saved into each project.

MANAGING YOUR PROJECTS

See Figure 3.

To edit, delete or share your images:

Tap the project name. A menu appears displaying **Add New**, **Edit**, **Use Existing** or **Cancel**.

Add New

- Tap **Add New** and enter the name of your new project.
- Tap **Done** to return to the screen. Any screen shots or images saved will be stored under this new project name.
- To review images, tap the file cabinet icon in the lower left corner of the screen. Tap the image to display the saved screenshot.

NOTE: If no images have been saved, you will receive a notice that no readings are available in this project. You must save an image before you can open to review.

Edit

- Delete or add characters in the open project name and type in a new or revised name for your project.

Use Existing

- Scroll through the list of project names and select the one you wish to access.
- Tap **Done** to load the project.

CREATING NOTES

Tap the notes icon. A menu appears displaying **Photos**, **Audio Memo**, **Location** and **Notes**.

- Tap plus (+) for **Photos** to take a picture in the selected project or to view current photos.

Fig. 3

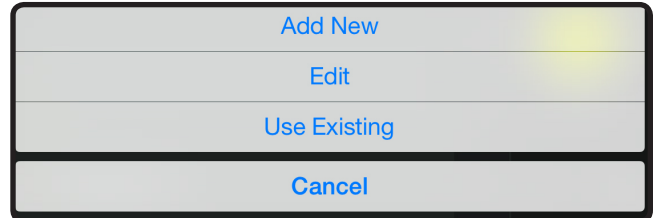
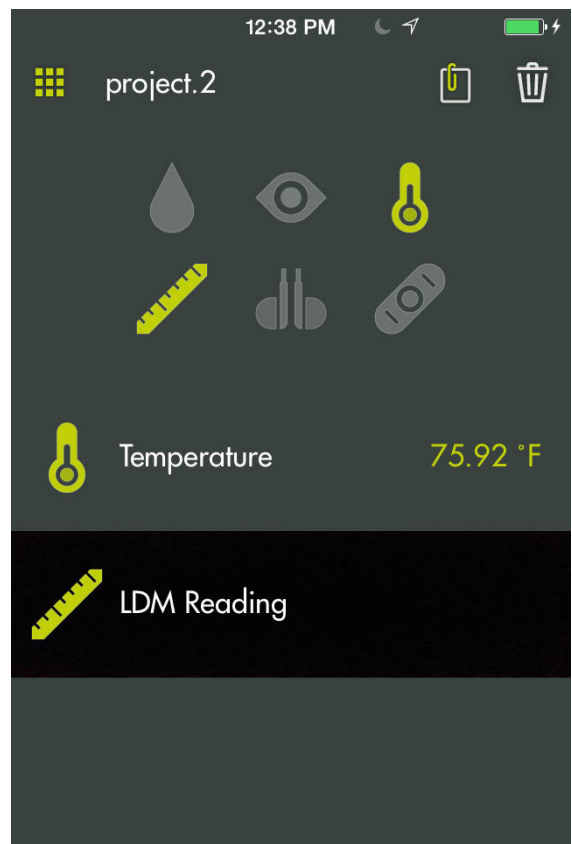

Fig. 4



- Tap plus (+) for **Audio Memo** to record a voice memo in the selected project. Tap the green button to begin recording. Tap again to stop.
- Tap plus (+) for **Location** and select **Use Current Location** to record your current location in the selected project. To edit or manually enter the location, tap plus (+) again to access the keyboard.
- Tap plus (+) for **Notes** to access the notes screen. Tap plus (+) again to access the keyboard.

OPERATION

Fig. 5

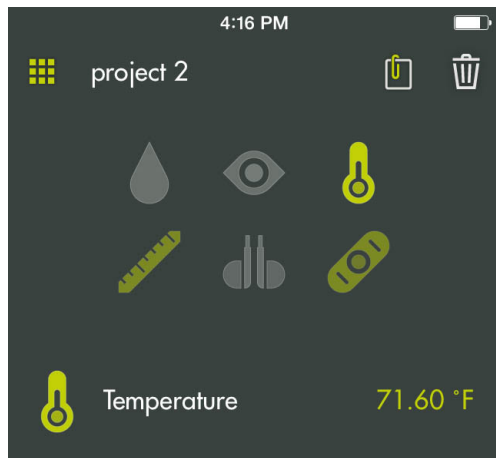

SHARING NOTES

- Select the share icon .
- Select the share icon on each piece of data you wish to share.
- Select the share method.

PROJECT FOLDER SUMMARY

See Figure 4.

- The file cabinet  may be accessed from the RYOBI™ Phone Works™ home screen or from any app segment.
- Accessing the file cabinet from the home screen will display all projects and icons representing the app segments used for each project.

PROJECT SUMMARY

See Figure 5.

- Accessing the file cabinet from within a project will display the app segments containing photos or data.
- Tap an icon to select or deselect an app segment within a project. When an app segment is selected, stored items will be visible.
- Tap a stored item to preview its details.

SHARING PROJECTS

See Figure 6.

- To share the picture, tap the share icon () to the right of **Preview**. A blank email opens with the image attached.
- Tap **Cancel** to save the email as a draft or delete the draft. Sending the email returns you to the **Preview** screen.
- To exit preview, tap the arrow to the left of **Preview**.

DELETING PROJECTS

See Figure 7.

- To delete a project view, tap the trash can icon. Tap the project view(s) you wish to delete. A red trash can appears next to each item you have selected to delete. Tap **DELETE** . Tap delete again to remove the item.

Fig. 6

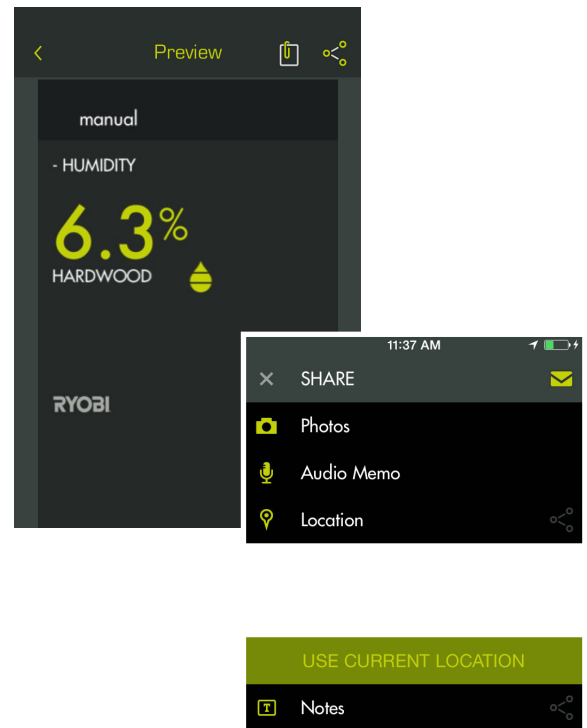
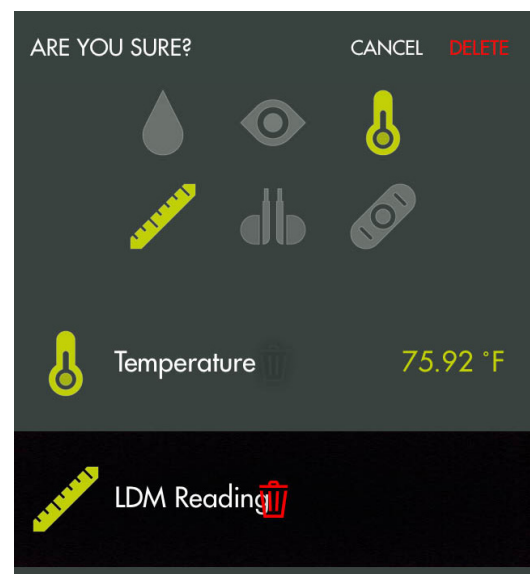

Fig. 7



- To delete an entire project across multiple devices, return to the RYOBI™ Phone Works™ home screen. Select the file cabinet icon and then select the project you wish to delete. Swipe to reveal the **DELETE** option and select **DELETE**.

OPERATION

CHART MOISTURE LEVELS

- Automatically chart recorded moisture levels within the selected project.

GLOBAL SETTINGS/SETTINGS

See Figure 8.

- Tap the **Settings**  icon on the RYOBI™ Phone Works™ home screen to make changes based on your preferences.
- Settings specific to some app segments can only be changed within the app segment.
- Tap **Save** to apply changes.
- You may also LOGOUT from this screen, view the Terms and Conditions, and view the Privacy Policy.

Fig. 8



MAINTENANCE

WARNING:

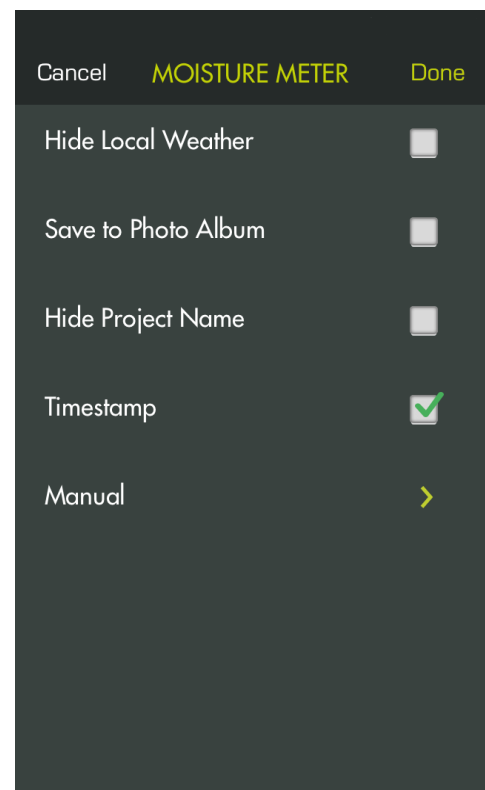
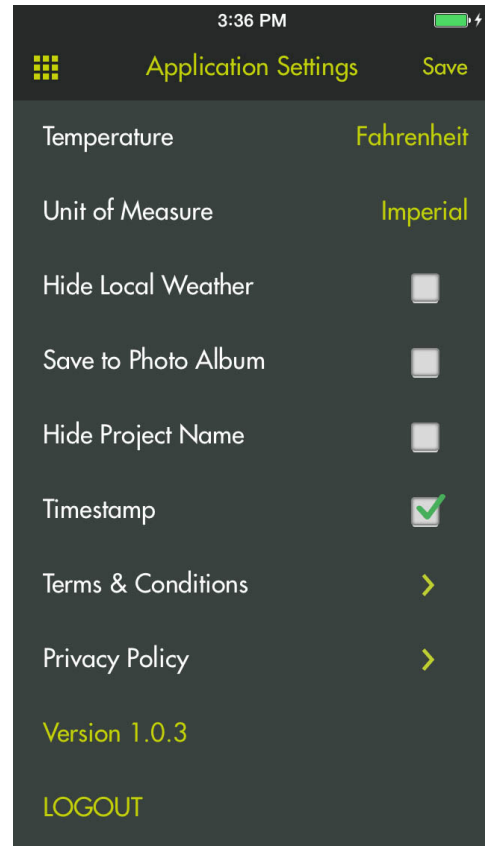
When servicing, use only identical replacement parts. Use of any other parts could create a hazard or cause product damage.

GENERAL MAINTENANCE

Avoid using solvents when cleaning plastic parts. Most plastics are susceptible to damage from various types of commercial solvents and may be damaged by their use. Use clean cloths to remove dirt, dust, oil, grease, etc.

STORAGE

Store in a cool, dry location to prevent condensation or mold from forming inside the product.

Do not store the device at temperatures greater than 122° F (such as on a dashboard or vehicle interior).

BATTERY RECYCLING

Consult the Earth 911 website (www.earth911.com) or your local waste authority for information regarding available recycling and/or disposal options.

WARNING:

Do not attempt to destroy or disassemble batteries or remove any of their components. All batteries must be recycled or disposed of properly. Do not discard large amounts of used batteries together. “Dead” batteries often have residual charge. When grouped together, these batteries can become “live” and pose a risk of possible serious injury.

BLUETOOTH® LICENSE STATEMENT

The BLUETOOTH® word mark and logos are registered trademarks owned by Bluetooth SIG, Inc. and any use of such marks by TECHTRONIC POWER TOOLS TECHNOLOGY LIMITED is under license. Other trademarks and trade names are those of their respective owners.

FCC COMPLIANCE

NOTE: This device complies with part 15 of the FCC RULES and Industry Canada license-exempt RSS standard(s). Operation is subject to the following two conditions: (1) this device may not cause harmful interference, and (2) this device must accept any interference received, including interference that may cause undesired operation.

The grantee is not responsible for any changes or modifications not expressly approved by the party responsible for compliance. Such modifications could void the user’s authority to operate the equipment.

This equipment has been tested and found to comply with the limits for a Class B digital device, pursuant to part 15 of the FCC Rules. These limits are designed to provide reasonable protection against harmful interference in a residential installation. This equipment generates, uses and can radiate radio frequency energy and, if not installed and used in accordance with the instructions, may cause harmful interference to radio communications. However, there is no guarantee that interference will not occur in a particular installation. If this equipment does cause harmful interference to radio or television reception, which can be determined by turning the equipment off and on, the user is encouraged to try to correct the interference by one or more of the following measures:

- Reorient or relocate the receiving antenna.
- Increase the separation between the equipment and receiver.
- Connect the equipment into an outlet on a circuit different from that to which the receiver is connected.
- Consult the dealer or an experienced radio/TV technician for help

Under Industry Canada regulations, this radio transmitter may only operate using an antenna of a type and maximum (or lesser) gain approved for the transmitter by Industry Canada. To reduce potential radio interference to other users, the antenna type and its gain should be so chosen that the equivalent isotropically radiated power (e.i.r.p.) is not more than that necessary for successful communication.

WARRANTY

RYOBI™ Phone Works™ – LIMITED 1 YEAR WARRANTY

One World Technologies, Inc., warrants its RYOBI™ Phone Works™ products with the following conditions:

WHAT THIS WARRANTY COVERS: This warranty covers all defects in workmanship or materials in your RYOBI™ Phone Works™ for a period of one year from the date of purchase.

WHAT'S NOT COVERED: This warranty applies only to the original purchaser at retail and may not be transferred. This warranty only covers defects arising under normal usage and does not cover wearable parts, malfunction, failure or defects resulting from misuse, abuse, neglect, alteration, modification or repairs by other than RYOBI™ Phone Works™ Service Department. One World Technologies, Inc. makes no warranties, representations or promises as to the quality or performance of its power tools other than those specifically stated in this warranty.

HOW TO GET SERVICE: Return the RYOBI™ Phone Works™ Item to RYOBI™ Phone Works™ Service Department at the address below, freight prepaid. Insurance is required.

RYOBI™ Phone Works™ Service Department
P.O. Box 1288,
Anderson, SC 29622

When you request warranty service, you must also present proof of purchase documentation, which includes the date of purchase (for example, a bill of sale). We will repair any faulty workmanship, and either repair or replace any defective part, at our option. We will do so without any charge to you. We will complete the work in a reasonable time, but, in any case, within ninety (90) days or less.

For any additional questions or customer service please contact RYOBI™ Phone Works™ at 1-877-578-6736 or by logging on to www.ryobitools.com/phoneworks.

ADDITIONAL LIMITATIONS: Any implied warranties granted under state law, including warranties of merchantability or fitness for a particular purpose, are limited to three years from the date of purchase. One World Technologies, Inc. is not responsible for direct, indirect, or incidental damages, so the above limitations and exclusions may not apply to you. This warranty gives you specific legal rights, and you may also have other rights which vary from state to state.