

FCC Part 15C

Measurement And Test Report For

Swann Communications Pty Ltd (Swann Global Limited - HK office)

Room 1601, Tung Ning Building 249-255 Des Voeux Road Central Hong Kong

FCC ID: VMISWO-SVC01K

Feb. 17, 2015

This Report Concerns: <input checked="" type="checkbox"/> Original Report	Equipment Type: IP Camera
Report Number:	MTI150104007RF
Test Engineer:	David Chen <i>David Chen</i>
Reviewed By:	Tim Zhang <i>Tim Zhang</i>
Approved & Authorized By:	Hebe Lee <i>Hebe Lee</i>
Test Date:	Feb. 01 - Feb. 17, 2015
Prepared By:	Shenzhen Microtest Technology Co.,Ltd 6F, Zhongbao Building, Gushu, Bao'an District, Shenzhen, P.R.China Tel: +86-755-8885 0135 Fax: +86-755-8885 0136



Note: This test report is limited to the above client company and the product model only. It may not be duplicated without prior written consent of Shenzhen Microtest Technology Co.,Ltd.

TEST RESULT CERTIFICATION

Applicant's name	Swann Communications Pty Ltd (Swann Global Limited - HK office)
Address	Room 1601, Tung Ning Building 249-255 Des Voeux Road Central Hong Kong
Manufacture's Name	Swann Communications Pty Ltd (Swann Global Limited - HK office)
Address	Room 1601, Tung Ning Building 249-255 Des Voeux Road Central Hong Kong
Product description	
Product name	IP Camera
Model and/or type reference	SWO-SVC01K
Serial Model	N/A
Standards	FCC Part15.247
Test procedure	ANSI C63.4-2003

Table of Contents

	Page
1 . SUMMARY OF TEST RESULTS	5
1.1 TEST FACILITY	6
1.2 MEASUREMENT UNCERTAINTY	6
2 . GENERAL INFORMATION	7
2.1 GENERAL DESCRIPTION OF EUT	7
2.2 DESCRIPTION OF TEST MODES	9
2.3 BLOCK DIGRAM SHOWING THE CONFIGURATION OF SYSTEM TESTED	10
2.4 DESCRIPTION OF SUPPORT UNITS(CONDUCTED MODE)	11
2.5 EQUIPMENTS LIST FOR ALL TEST ITEMS	12
3 . EMC EMISSION TEST	13
3.1 CONDUCTED EMISSION MEASUREMENT	13
3.1.1 POWER LINE CONDUCTED EMISSION LIMITS	13
3.1.2 TEST PROCEDURE	14
3.1.3 DEVIATION FROM TEST STANDARD	14
3.1.4 TEST SETUP	14
3.1.5 EUT OPERATING CONDITIONS	14
3.1.6 TEST RESULTS	15
3.2 RADIATED EMISSION MEASUREMENT	17
3.2.1 RADIATED EMISSION LIMITS	17
3.2.2 TEST PROCEDURE	17
3.2.3 DEVIATION FROM TEST STANDARD	18
3.2.4 TEST SETUP	19
3.2.5 EUT OPERATING CONDITIONS	20
3.2.6 TEST RESULTS (BETWEEN 9KHZ – 30 MHZ)	21
3.2.7 TEST RESULTS (BETWEEN 30MHZ – 1GHZ)	22
3.2.8 TEST RESULTS (ABOVE 1000 MHZ)	24
4 . POWER SPECTRAL DENSITY TEST	64
4.1 APPLIED PROCEDURES / LIMIT	64
4.1.1 TEST PROCEDURE	64
4.1.2 DEVIATION FROM STANDARD	64
4.1.3 TEST SETUP	64
4.1.4 EUT OPERATION CONDITIONS	64
4.1.5 TEST RESULTS	65
5 . BANDWIDTH TEST	73
5.1 APPLIED PROCEDURES / LIMIT	73
5.1.1 TEST PROCEDURE	73
5.1.2 DEVIATION FROM STANDARD	73

Table of Contents

	Page
5.1.3 TEST SETUP	73
5.1.4 EUT OPERATION CONDITIONS	73
5.1.5 TEST RESULTS	74
6 . PEAK OUTPUT POWER TEST	82
6.1 APPLIED PROCEDURES / LIMIT	82
6.1.1 TEST PROCEDURE	82
6.1.2 DEVIATION FROM STANDARD	82
6.1.3 TEST SETUP	82
6.1.4 EUT OPERATION CONDITIONS	82
6.1.5 TEST RESULTS	83
7 . ANTENNA REQUIREMENT	84
7.1 STANDARD REQUIREMENT	84
7.2 EUT ANTENNA	84
8 . EUT TEST PHOTO	85

1. SUMMARY OF TEST RESULTS

Test procedures according to the technical standards:

FCC Part15 (15.247) , Subpart C			
Standard Section	Test Item	Judgment	Remark
15.207	Conducted Emission	PASS	
15.247 (a)(2)	6dB Bandwidth	PASS	
15.247 (b)	Peak Output Power	PASS	
15.247 (c)	Radiated Spurious Emission	PASS	
15.247 (d)	Power Spectral Density	PASS	
15.205	Band Edge Emission	PASS	
15.203	Antenna Requirement	PASS	

NOTE:

(1) "N/A" denotes test is not applicable in this Test Report

1.1 TEST FACILITY

Shenzhen Toby Technology Co., Ltd.
Add.: 10/F.,A Block, Jiada R&D Bldg., No.5 Songpingshan, Road, Science&Technology Park,
Shenzhen, 518057
FCC Registration No.:811562

1.2 MEASUREMENT UNCERTAINTY

The reported uncertainty of measurement $y \pm U$, where expanded uncertainty U is based on a standard uncertainty multiplied by a coverage factor of $k=2$, providing a level of confidence of approximately 95%.

No.	Item	Uncertainty
1	Conducted Emission Test	$\pm 1.38\text{dB}$
2	RF power, conducted	$\pm 0.16\text{dB}$
3	Spurious emissions, conducted	$\pm 0.21\text{dB}$
4	All emissions, radiated (<1G)	$\pm 4.68\text{dB}$
5	All emissions, radiated (>1G)	$\pm 4.89\text{dB}$
6	Temperature	$\pm 0.5^\circ\text{C}$
7	Humidity	$\pm 2\%$

2. GENERAL INFORMATION

2.1 GENERAL DESCRIPTION OF EUT

Equipment	IP Camera	
Trade Name	Swann	
Model Name	SWO-SVC01K	
Serial Model	N/A	
Model Difference	N/A	
Product Description	The EUT is a IP Camera	
	Operation Frequency:	802.11b/g/n:2412~2462 MHz 802.11n(40):2422~2452MHz
	Modulation Type:	CCK/OFDM/ QPSK/ BPSK
	Bit Rate of Transmitter	802.11b:11/5.5/2/1 Mbps 802.11g:54/48/36/24/18/12/9/6Mbps 802.11n:MCS 0 to 7 for HT20MHz MCS 0 to 7 for HT40MHz
	Number Of Channel	802.11b/g/n20: 11CH 802.11n 40: 7CH
	Antenna Designation:	Please see Note 3.
	Output Power(AV):	802.11b: 12.33dBm (Max.) 802.11g: 11.46 dBm (Max.) 802.11n20: 11.85 dBm (Max.) 802.11n40: 10.32 dBm (Max.)
Based on the application, features, or specification exhibited in User's Manual, the EUT is considered as an ITE/Computing Device. More details of EUT technical specification, please refer to the User's Manual.		
Channel List	Please refer to the Note 2.	
Adapter	MODEL:ADS-10BA-06 05010GPCU Input:100~240V, 50/60Hz, max. 0.3A Output:DC 5V, 2.0A	
Battery	N/A	
Connecting I/O Port(s)	Please refer to the User's Manual	

Note:

1. For a more detailed features description, please refer to the manufacturer's specifications or the User's Manual.

2.

Channel List for 802.11b/g/n(20MHz)							
Channel	Frequency (MHz)	Channel	Frequency (MHz)	Channel	Frequency (MHz)	Channel	Frequency (MHz)
01	2412	04	2427	07	2442	10	2457
02	2417	05	2432	08	2447	11	2462
03	2422	06	2437	09	2452		

Channel List for 802.11n(40MHz)							
Channel	Frequency (MHz)	Channel	Frequency (MHz)	Channel	Frequency (MHz)	Channel	Frequency (MHz)
03	2422	06	2437	09	2452		
04	2427	07	2442				
05	2432	08	2447				

3.

Table for Filed Antenna

Ant	Brand	Model Name	Antenna Type	Connector	Gain (dBi)	NOTE
A	N/A	N/A	Internal antenna	N/A	2.0	N/A

2.2 DESCRIPTION OF TEST MODES

To investigate the maximum EMI emission characteristics generates from EUT, the test system was pre-scanning tested base on the consideration of following EUT operation mode or test configuration mode which possible have effect on EMI emission level. Each of these EUT operation mode(s) or test configuration mode(s) mentioned above was evaluated respectively.

Pretest Mode	Description
Mode 1	802.11b CH1/ CH6/ CH11
Mode 2	802.11g CH1/ CH6/ CH11
Mode 3	802.11n(20)CH1/ CH6/ CH11
Mode 4	802.11n(40) CH3/ CH6/ CH9
Mode 5	Link Mode

For Conducted Emission	
Final Test Mode	Description
Mode 5	Link Mode

For Radiated Emission	
Final Test Mode	Description
Mode 1	802.11b CH1/ CH6/ CH11
Mode 2	802.11g CH1/ CH6/ CH11
Mode 3	802.11n(20)CH1/ CH6/ CH11
Mode 4	802.11n(40) CH3/ CH6/ CH9

Note:

- (1) The measurements are performed at the highest, middle, lowest available channels.
- (2) The measurements are performed at all Bit Rate of Transmitter, the worst data was reported

2.3 BLOCK DIGRAM SHOWING THE CONFIGURATION OF SYSTEM TESTED

Conducted Emission Test



Radiated Spurious Emission Test

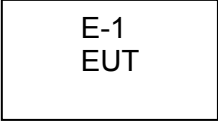

2.4 DESCRIPTION OF SUPPORT UNITS(CONDUCTED MODE)

The EUT has been tested as an independent unit together with other necessary accessories or support units. The following support units or accessories were used to form a representative test configuration during the tests.

Item	Equipment	Mfr/Brand	Model/Type No.	Series No.	Note
E-1	IP Camera	Swann	SWO-SVC01K	N/A	EUT
E-2	Adapter	N/A	ADS-10BA-06 05010GPCU	N/A	

Item	Shielded Type	Ferrite Core	Length	Note
C-1	NO	NO	1.0M	
C-2	NO	NO	0.8M	

Note:

- (1) The support equipment was authorized by Declaration of Confirmation.
- (2) For detachable type I/O cable should be specified the length in cm in 『Length』 column.

2.5 EQUIPMENTS LIST FOR ALL TEST ITEMS

Radiation Test equipment

Equipment	Manufacturer	Model No.	Serial No.	Last Cal.	Cal. Due Date
Spectrum Analyzer	Agilent	E4407B	MY45106456	Mar. 20, 2014	Mar. 19, 2015
Spectrum Analyzer	Rohde & Schwarz	FSP30	DE25181	Mar. 07, 2014	Mar.06, 2015
EMI Test Receiver	Rohde & Schwarz	ESCI	101165	Mar. 07, 2014	Mar.06, 2015
Bilog Antenna	ETS-LINDGREN	3142E	00117537	Mar. 07, 2014	Mar.06, 2015
Bilog Antenna	ETS-LINDGREN	3142E	00117542	Mar. 07, 2014	Mar.06, 2015
Horn Antenna	ETS-LINDGREN	3117	00143207	Mar. 07, 2014	Mar.06, 2015
Horn Antenna	ETS-LINDGREN	3117	00143209	Mar. 07, 2014	Mar.06, 2015
Pre-amplifier	HP	11909A	185903	Mar. 07, 2014	Mar.06, 2015
Pre-amplifier	HP	8447B	3008A00849	Mar. 07, 2014	Mar.06, 2015
Cable	HUBER+SUHNE R	100	SUCOFLEX	Mar. 07, 2014	Mar.06, 2015
Signal Generator	Rohde & Schwarz	SML03	IKW682-054	Feb. 11, 2014	Feb.10, 2015
Positioning Controller	ETS-LINDGREN	2090	N/A	N/A	N/A

Conduction Test equipment

Description	Manufacturer	Model No.	Serial No.	Cal. Date	Cal. Due Date
EMI Test Receiver	ROHDE& SCHWARZ	ESCI	100321	2014-08-10	2015-08-09
50ΩCoaxial Switch	Anritsu	MP59B	X10321	2014-08-10	2015-08-09
L.I.S.N	Rohde & Schwarz	ENV216	101131	2014-08-10	2015-08-09
L.I.S.N	SCHWARZBECK	NNBL 8226-2	8226-2/164	2014-08-10	2015-08-09

3. EMC EMISSION TEST

3.1 CONDUCTED EMISSION MEASUREMENT

3.1.1 POWER LINE CONDUCTED EMISSION Limits (Frequency Range 150KHz-30MHz)

FREQUENCY (MHz)	Class A (dBuV)		Class B (dBuV)		Standard
	Quasi-peak	Average	Quasi-peak	Average	
0.15 -0.5	79.00	66.00	66 - 56 *	56 - 46 *	CISPR
0.50 -5.0	73.00	60.00	56.00	46.00	CISPR
5.0 -30.0	73.00	60.00	60.00	50.00	CISPR

0.15 -0.5	79.00	66.00	66 - 56 *	56 - 46 *	FCC
0.50 -5.0	73.00	60.00	56.00	46.00	FCC
5.0 -30.0	73.00	60.00	60.00	50.00	FCC

Note:

- (1) The tighter limit applies at the band edges.
- (2) The limit of " * " marked band means the limitation decreases linearly with the logarithm of the frequency in the range.

The following table is the setting of the receiver

Receiver Parameters	Setting
Attenuation	10 dB
Start Frequency	0.15 MHz
Stop Frequency	30 MHz
IF Bandwidth	9 kHz

3.1.2 TEST PROCEDURE

- a. The EUT was placed 0.4 meters from the horizontal ground plane with EUT being connected to the power mains through a line impedance stabilization network (LISN). All other support equipments powered from additional LISN(s). The LISN provide 50 Ohm/ 50uH of coupling impedance for the measuring instrument.
- b. Interconnecting cables that hang closer than 40 cm to the ground plane shall be folded back and forth in the center forming a bundle 30 to 40 cm long.
- c. I/O cables that are not connected to a peripheral shall be bundled in the center. The end of the cable may be terminated, if required, using the correct terminating impedance. The overall length shall not exceed 1 m.
- d. LISN at least 80 cm from nearest part of EUT chassis.
- e. For the actual test configuration, please refer to the related Item –EUT Test Photos.

3.1.3 DEVIATION FROM TEST STANDARD

No deviation

3.1.4 TEST SETUP

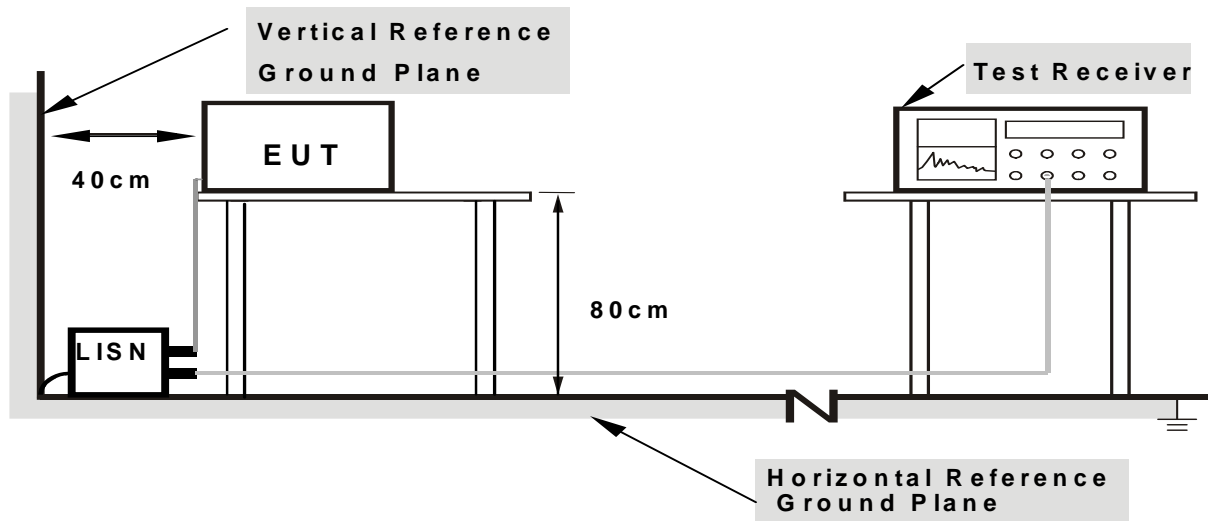

- Note: 1. Support units were connected to second LISN.**
2. Both of LISNs (AMN) are 80 cm from EUT and at least 80 from other units and other metal planes

3.1.5 EUT OPERATING CONDITIONS

The EUT was configured for testing in a typical fashion (as a customer would normally use it). The EUT has been programmed to continuously transmit during test. This operating condition was tested and used to collect the included data.

3.1.6 TEST RESULTS

EUT :	IP Camera	Model Name. :	SWO-SVC01K
Temperature :	26 °C	Relative Humidity :	54%
Pressure :	1010hPa	Phase :	L
Test Voltage :	DC 5Vfrom adapter AC 120V/60Hz	Test Mode :	Mode 5

Frequency (MHz)	Meter Reading (dBµV)	Factor (dB)	Emission Level (dBµV)	Limits (dBµV)	Margin (dB)	Detector Type
7.6980	32.81	10.41	43.22	60.00	-16.78	QP
0.5020	35.29	10.20	45.49	56.00	-10.51	QP
0.1860	39.69	9.79	49.48	64.21	-14.73	QP
0.1860	23.24	9.79	33.03	54.21	-21.18	AVG
0.5020	21.24	10.20	31.44	46.00	-14.56	AVG
7.6980	17.42	10.41	27.83	50.00	-22.17	AVG

Remark:

1. All readings are Quasi-Peak and Average values.
2. Factor = Insertion Loss + Cable Loss.

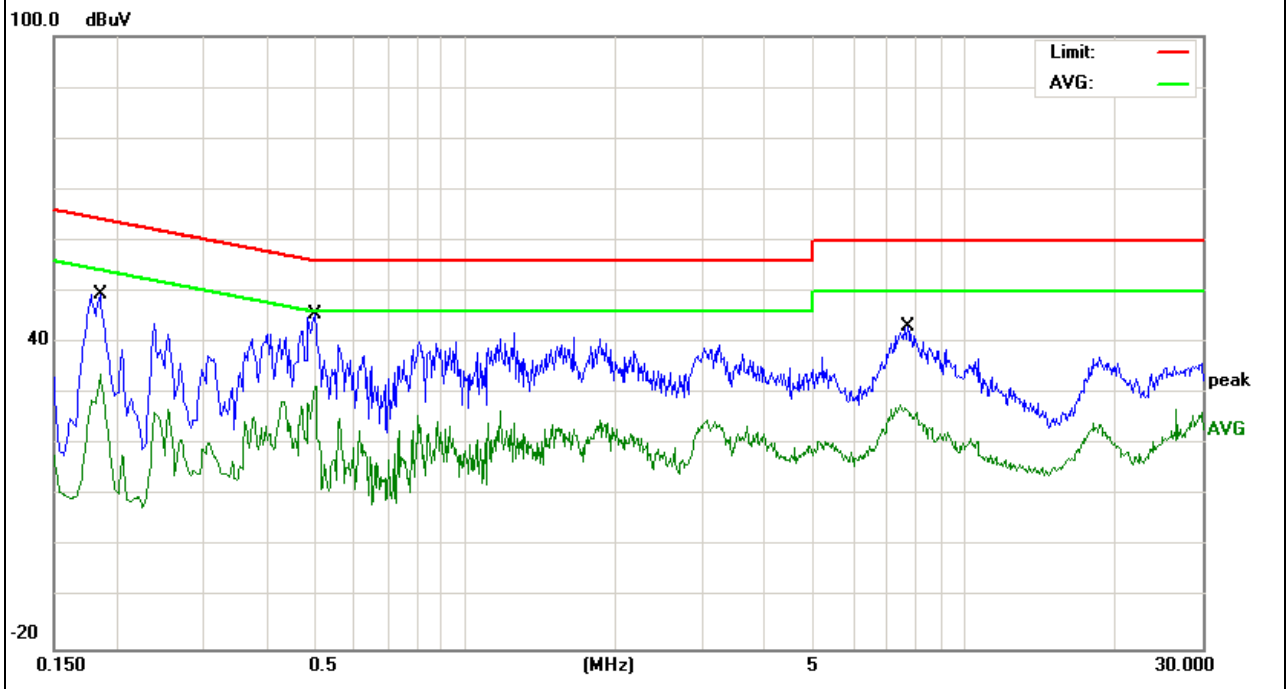

EUT :	IP Camera	Model Name. :	SWO-SVC01K
Temperature :	26 °C	Relative Humidity :	54%
Pressure :	1010hPa	Phase :	N
Test Voltage :	DC 5Vfrom adapter AC 120V/60Hz	Test Mode :	Mode 5

Frequency (MHz)	Meter Reading (dBµV)	Factor (dB)	Emission Level (dBµV)	Limits (dBµV)	Margin (dB)	Detector Type
0.4900	35.68	10.17	45.85	56.17	-10.32	QP
3.0100	29.63	10.32	39.95	56.00	-16.05	QP
0.1900	39.64	9.83	49.47	64.03	-14.56	QP
0.1900	19.83	9.83	29.66	54.03	-24.37	AVG
0.4900	19.31	10.17	29.48	46.17	-16.69	AVG
3.0100	12.00	10.32	22.32	46.00	-23.68	AVG

Remark:

1. All readings are Quasi-Peak and Average values.
2. Factor = Insertion Loss + Cable Loss.

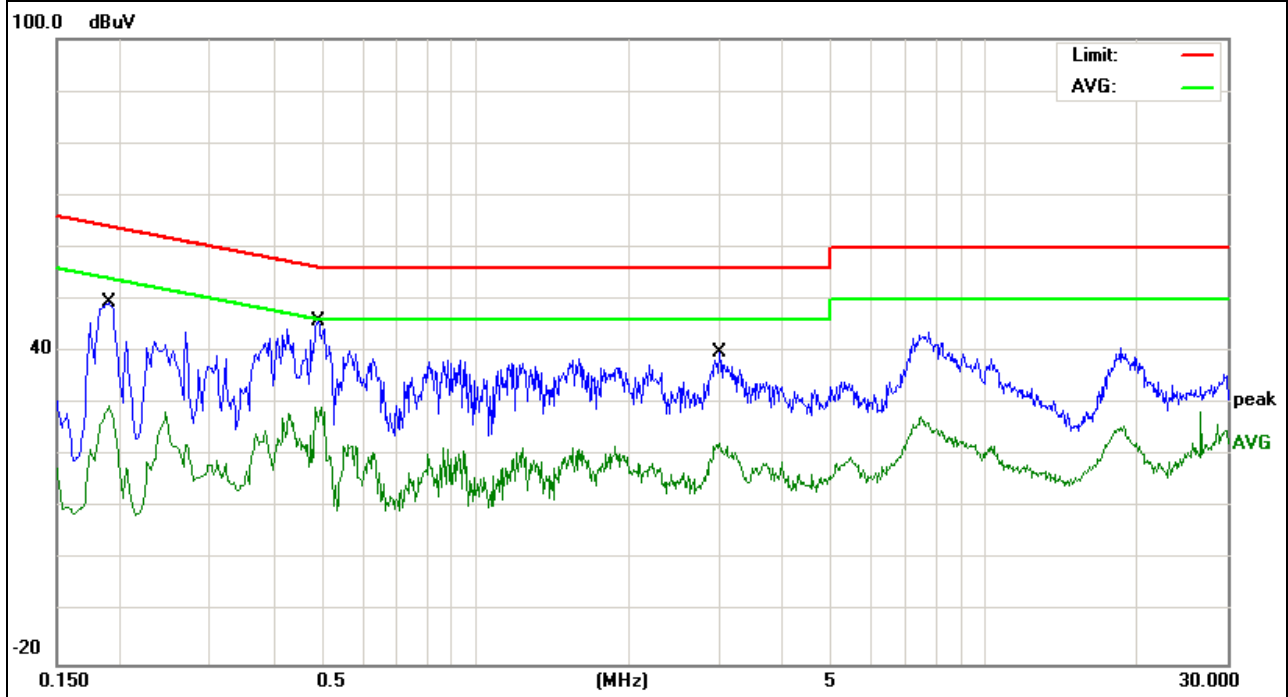

3.2 RADIATED EMISSION MEASUREMENT

3.2.1 RADIATED EMISSION LIMITS (Frequency Range 9kHz-1000MHz)

20dBc in any 100 kHz bandwidth outside the operating frequency band. In case the emission fall within the restricted band specified on 15.205(a), then the 15.209(a) limit in the table below has to be followed.

Frequencies (MHz)	Field Strength (micorvolts/meter)	Measurement Distance (meters)
0.009~0.490	2400/F(KHz)	300
0.490~1.705	24000/F(KHz)	30
1.705~30.0	30	30
30~88	100	3
88~216	150	3
216~960	200	3
Above 960	500	3

Spectrum Parameter	Setting
Attenuation	Auto
Start Frequency	1000 MHz
Stop Frequency	10th carrier harmonic
RB / VB (emission in restricted band)	1 MHz / 1 MHz for Peak, 1 MHz / 10Hz for Average

Receiver Parameter	Setting
Attenuation	Auto
Start ~ Stop Frequency	9kHz~150kHz / RB 200Hz for QP
Start ~ Stop Frequency	150kHz~30MHz / RB 9kHz for QP
Start ~ Stop Frequency	30MHz~1000MHz / RB 120kHz for QP

3.2.2 TEST PROCEDURE

- The measuring distance of at 3 m shall be used for measurements at frequency up to 1GHz. For frequencies above 1GHz, any suitable measuring distance may be used.
- The EUT was placed on the top of a rotating table 0.8 meters above the ground at a 3 meter open area test site. The table was rotated 360 degrees to determine the position of the highest radiation.
- The height of the equipment or of the substitution antenna shall be 0.8 m; the height of the test antenna shall vary between 1 m to 4 m. Both horizontal and vertical polarizations of the antenna are set to make the measurement.
- The initial step in collecting conducted emission data is a spectrum analyzer peak detector mode pre-scanning the measurement frequency range. Significant peaks are then marked and then Quasi Peak detector mode re-measured.

e. If the Peak Mode measured value compliance with and lower than Quasi Peak Mode Limit, the EUT shall be deemed to meet QP Limits and then no additional QP Mode measurement performed.

f. For the actual test configuration, please refer to the related Item –EUT Test Photos.

Note:

Both horizontal and vertical antenna polarities were tested and performed pretest to three orthogonal axis. The worst case emissions were reported

3.2.3 DEVIATION FROM TEST STANDARD

No deviation

3.2.4 TEST SETUP

(A) Radiated Emission Test-Up Frequency Below 30MHz

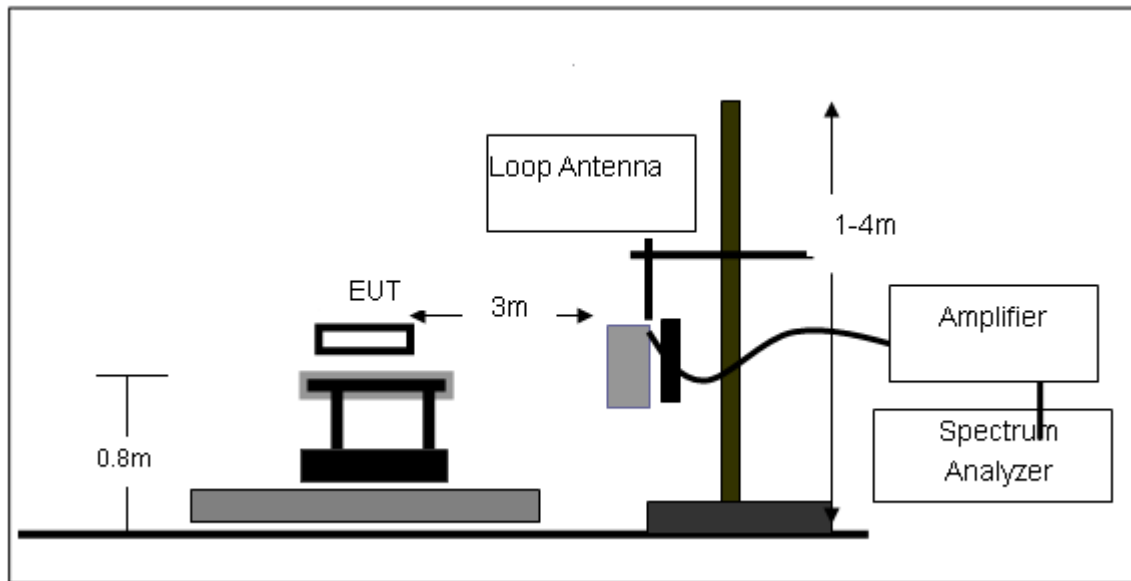

(B) Radiated Emission Test-Up Frequency 30MHz~1GHz

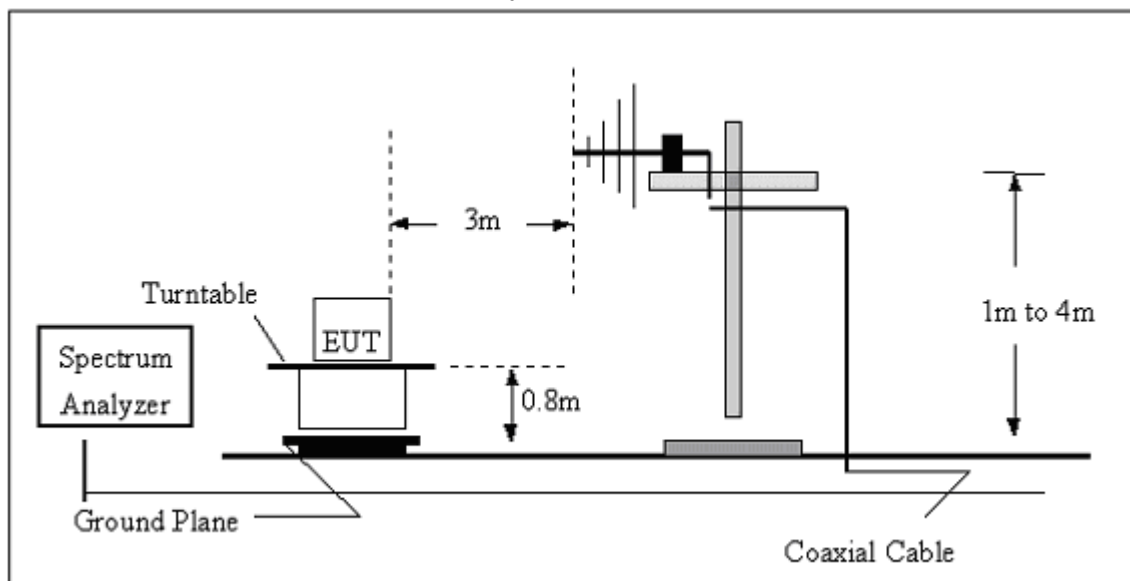

(C) Radiated Emission Test-Up Frequency Above 1GHz

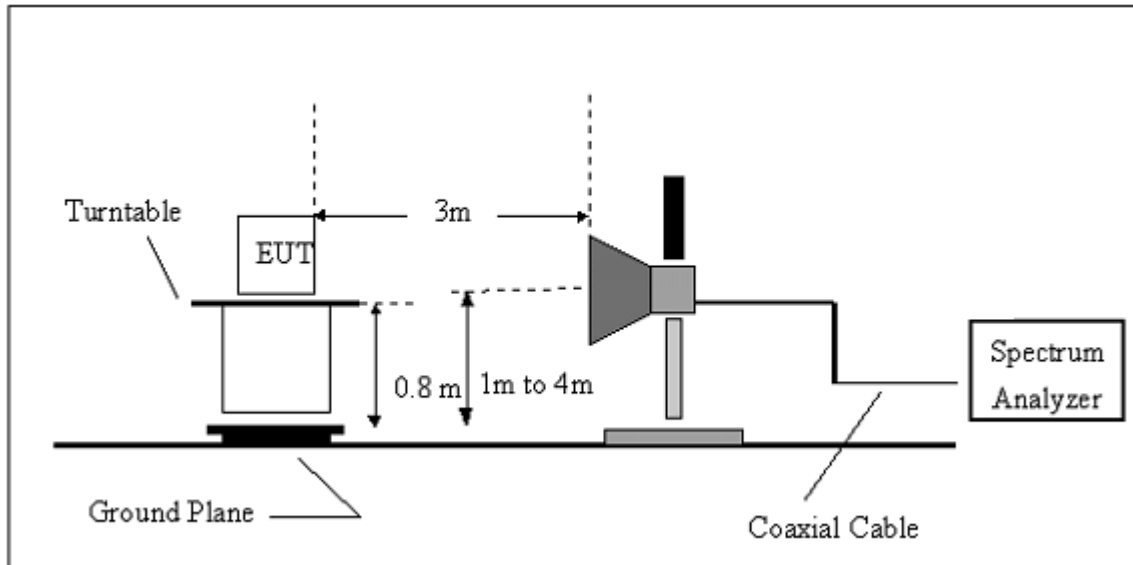

3.2.5 EUT OPERATING CONDITIONS

The EUT tested system was configured as the statements of 2.4 Unless otherwise a special operating condition is specified in the follows during the testing.

3.2.6 TEST RESULTS (BETWEEN 9KHZ – 30 MHZ)

EUT:	IP Camera	Model Name. :	SWO-SVC01K
Temperature:	20 °C	Relative Humidity:	48%
Pressure:	1010 hPa	Test Voltage :	DC 5Vfrom adapter AC 120V/60Hz
Test Mode :	TX	Polarization :	--

Freq.	Reading	Limit	Margin	State
(MHz)	(dBuV/m)	(dBuV/m)	(dB)	P/F
--	--	--	--	PASS
--	--	--	--	PASS

NOTE:

The amplitude of spurious emissions which are attenuated by more than 20dB below the permissible value has no need to be reported.

Distance extrapolation factor = $40 \log (\text{specific distance}/\text{test distance})(\text{dB})$;

Limit line = specific limits(dBuv) + distance extrapolation factor.

3.2.7 TEST RESULTS (BETWEEN 30MHZ – 1GHZ)

EUT :	IP Camera	Model Name :	SWO-SVC01K
Temperature :	20 °C	Relative Humidity :	48%
Pressure :	1010 hPa	Test Voltage :	DC 5Vfrom adapter AC 120V/60Hz
Test Mode :	Link	Polarization :	Horizontal

Frequency (MHz)	Meter Reading (dBμV)	Factor (dB)	Emission Level (dBμV/m)	Limits (dBμV/m)	Margin (dB)	Detector Type
131.7576	22.47	11.94	34.41	43.50	-9.09	QP
360.4476	24.71	15.57	40.28	46.00	-5.72	QP
760.7036	14.16	24.36	38.52	46.00	-7.48	QP

Remark:
Factor = Antenna Factor + Cable Loss – Pre-amplifier.

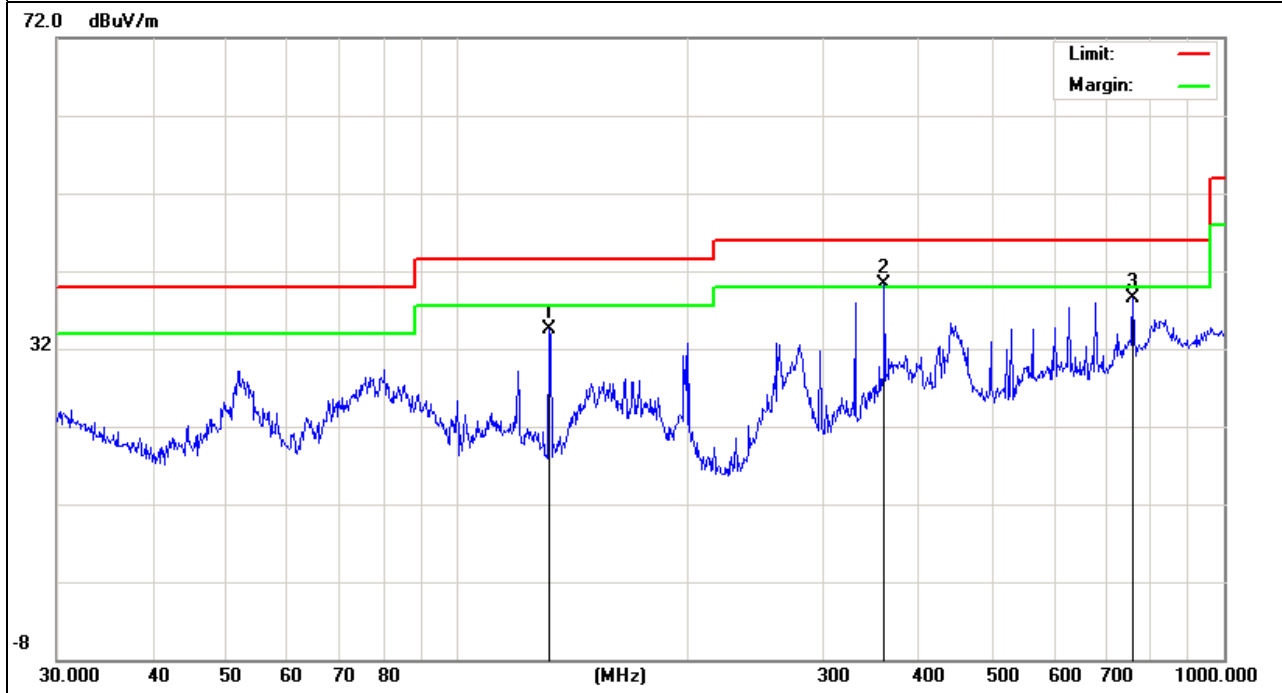

EUT :	IP Camera	Model Name :	SWO-SVC01K
Temperature :	20 °C	Relative Humidity :	48%
Pressure :	1010 hPa	Test Voltage :	DC 5Vfrom adapter AC 120V/60Hz
Test Mode :	Link	Polarization :	Vertical

Frequency (MHz)	Meter Reading (dBµV)	Factor (dB)	Emission Level (dBµV/m)	Limits (dBµV/m)	Margin (dB)	Detector Type
51.8430	23.29	7.31	30.60	40.00	-9.40	QP
151.0665	19.54	11.68	31.22	43.50	-12.28	QP
280.0237	23.97	13.35	37.32	46.00	-8.68	QP

Remark:
Factor = Antenna Factor + Cable Loss – Pre-amplifier.

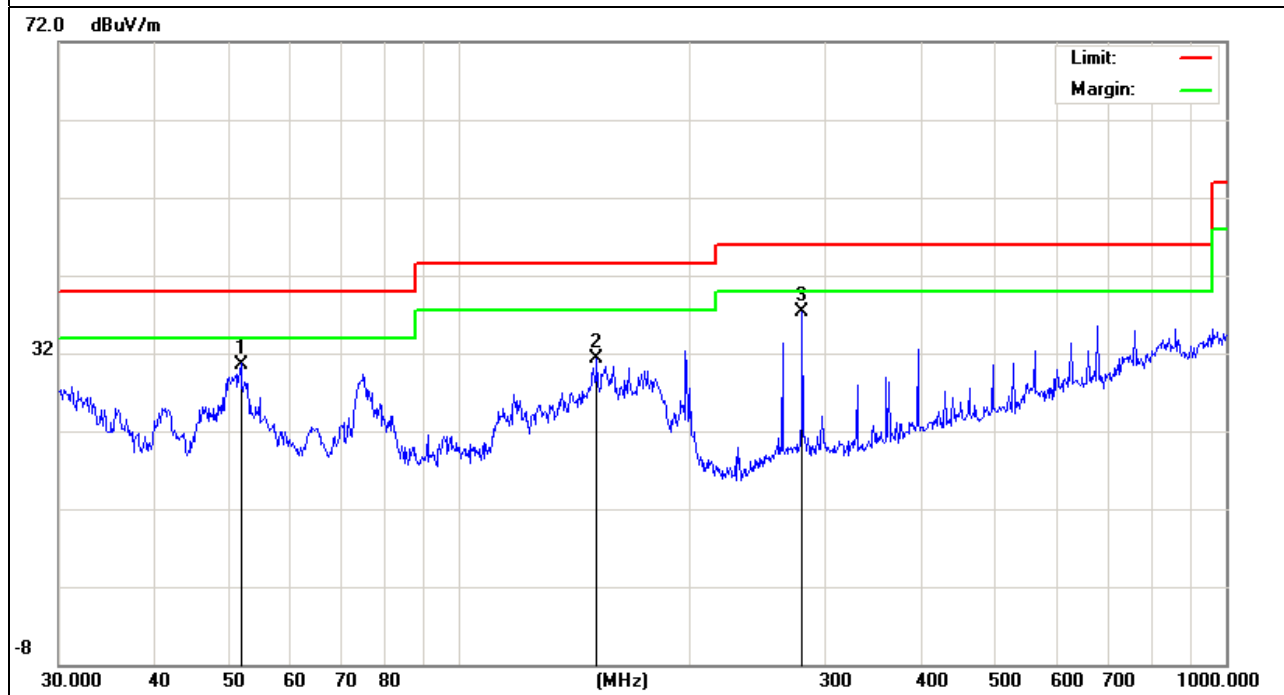

3.2.8 TEST RESULTS (ABOVE 1000 MHZ)

EUT :	IP Camera	Model Name :	SWO-SVC01K
Temperature :	20 °C	Relative Humidity :	48%
Pressure :	1010 hPa	Test Voltage :	DC 5Vfrom adapter AC 120V/60Hz
Test Mode :	CH1 (802.11b Mode)	Polarization :	Horizontal

Frequency (MHz)	Meter Reading (dBµV)	Factor (dB)	Emission Level (dBµV/m)	Limits (dBµV/m)	Margin (dB)	Detector Type
4803.945	41.49	10.40	51.89	74.00	-22.11	peak
7236.007	39.37	12.39	51.76	74.00	-22.24	peak

Remark:
Factor = Antenna Factor + Cable Loss – Pre-amplifier.

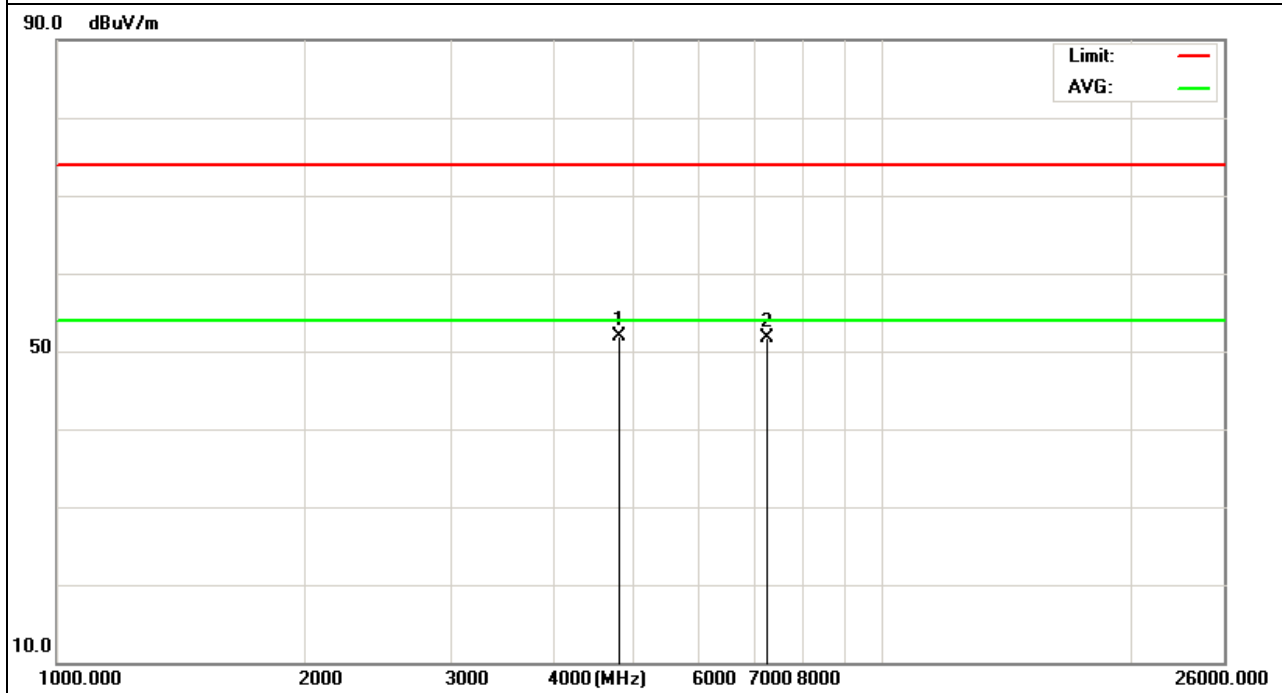

EUT :	IP Camera	Model Name :	SWO-SVC01K
Temperature :	20 °C	Relative Humidity :	48%
Pressure :	1010 hPa	Test Voltage :	DC 5Vfrom adapter AC 120V/60Hz
Test Mode :	CH1 (802.11b Mode)	Polarization :	Vertical

Frequency (MHz)	Meter Reading (dBµV)	Factor (dB)	Emission Level (dBµV/m)	Limits (dBµV/m)	Margin (dB)	Detector Type
4824.211	42.17	10.44	52.61	74.00	-21.39	peak
7236.192	37.26	12.39	49.65	74.00	-24.35	peak

Remark:
Factor = Antenna Factor + Cable Loss – Pre-amplifier.

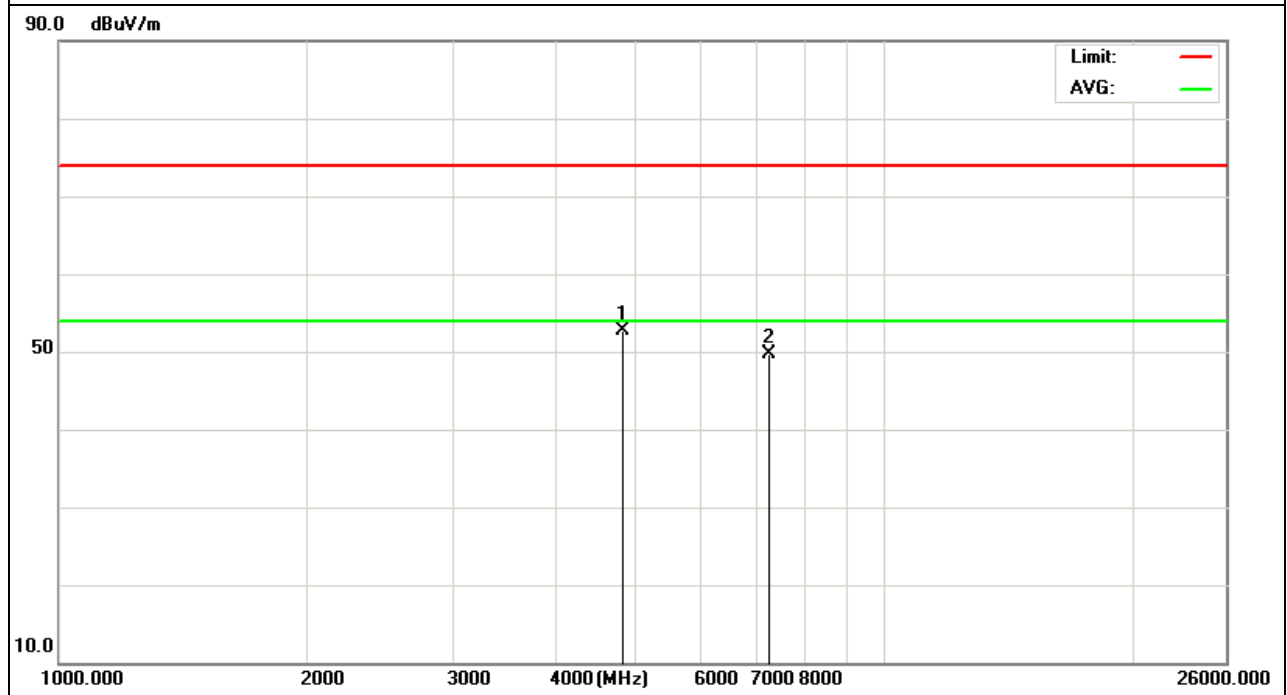

EUT :	IP Camera	Model Name :	SWO-SVC01K
Temperature :	20 °C	Relative Humidity :	48%
Pressure :	1010 hPa	Test Voltage :	DC 5Vfrom adapter AC 120V/60Hz
Test Mode :	CH6 (802.11b Mode)	Polarization :	Horizontal

Frequency (MHz)	Meter Reading (dBµV)	Factor (dB)	Emission Level (dBµV/m)	Limits (dBµV/m)	Margin (dB)	Detector Type
4876.467	41.84	10.39	52.23	74.00	-21.77	peak
7322.612	39.63	12.76	52.39	74.00	-21.61	peak

Remark:
Factor = Antenna Factor + Cable Loss – Pre-amplifier.

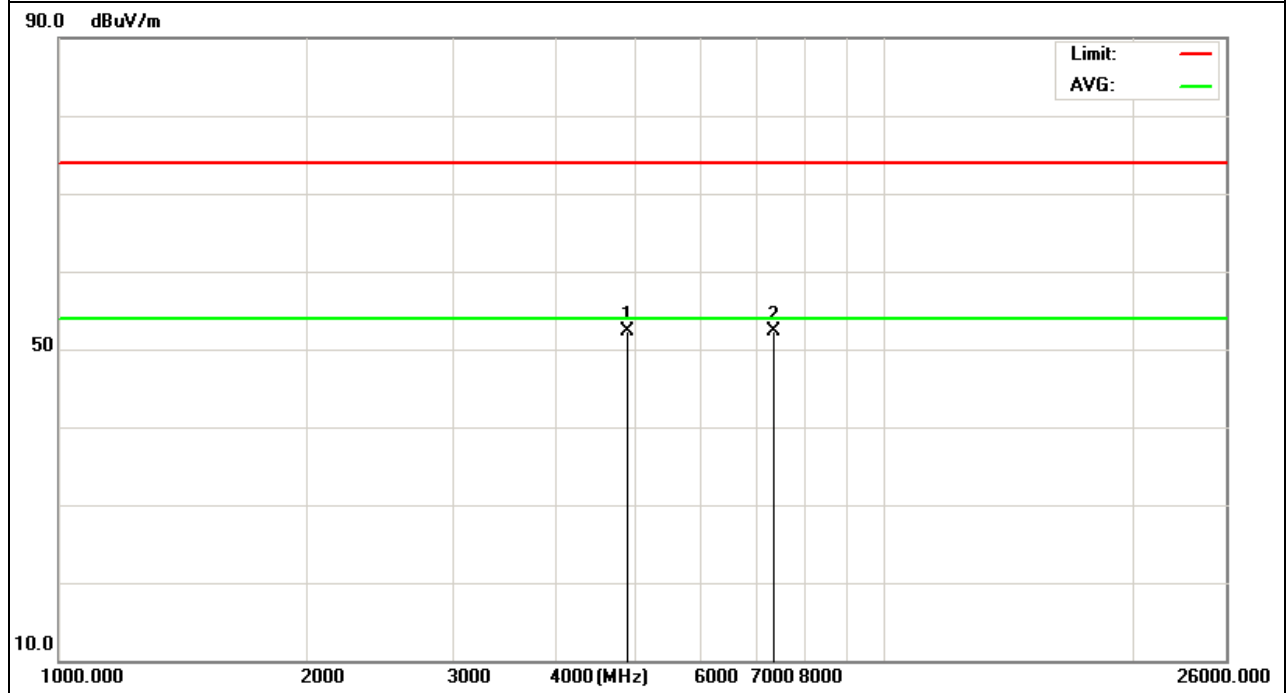

EUT :	IP Camera	Model Name :	SWO-SVC01K
Temperature :	20 °C	Relative Humidity :	48%
Pressure :	1010 hPa	Test Voltage :	DC 5Vfrom adapter AC 120V/60Hz
Test Mode :	CH6 (802.11b Mode)	Polarization :	Vertical

Frequency (MHz)	Meter Reading (dBμV)	Factor (dB)	Emission Level (dBμV/m)	Limits (dBμV/m)	Margin (dB)	Detector Type
4874.224	42.46	10.40	52.86	74.00	-21.14	peak
7331.765	36.63	12.78	49.41	74.00	-24.59	peak

Remark:

- Factor = Antenna Factor + Cable Loss – Pre-amplifier.
- No emission detected above 18GHz

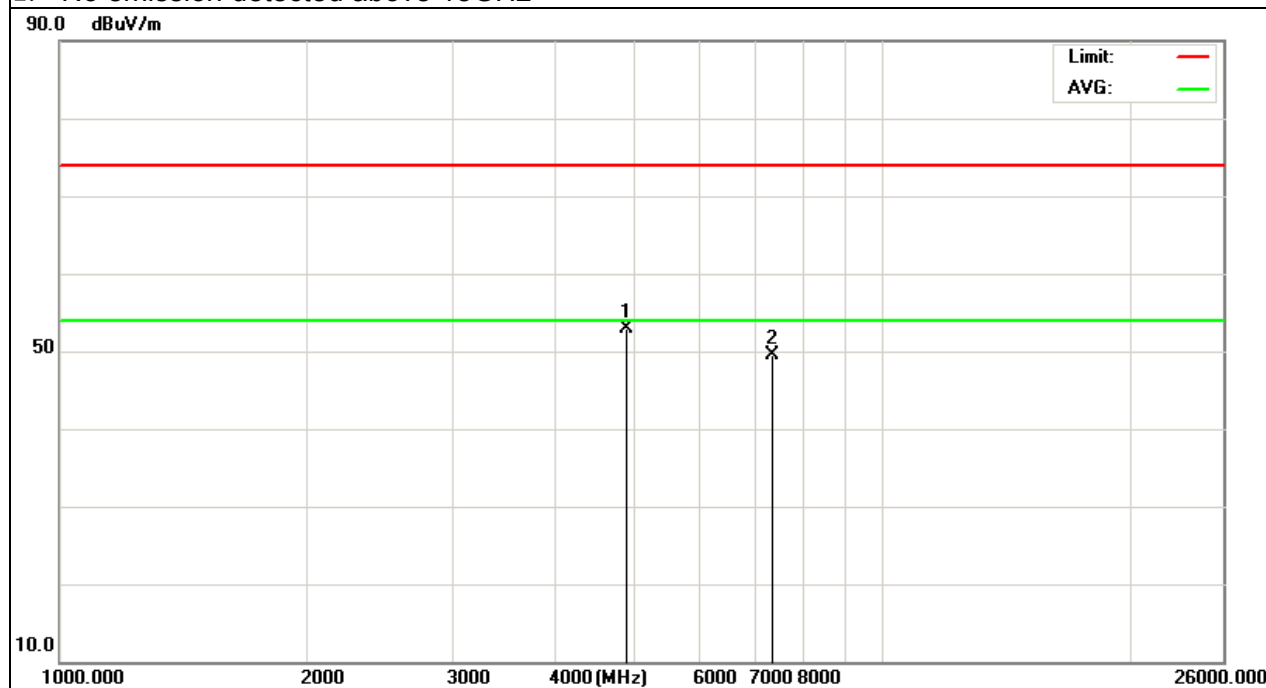

EUT :	IP Camera	Model Name :	SWO-SVC01K
Temperature :	20 °C	Relative Humidity :	48%
Pressure :	1010 hPa	Test Voltage :	DC 5Vfrom adapter AC 120V/60Hz
Test Mode :	CH11 (802.11b Mode)	Polarization :	Horizontal

Frequency (MHz)	Meter Reading (dBµV)	Factor (dB)	Emission Level (dBµV/m)	Limits (dBµV/m)	Margin (dB)	Detector Type
4924.006	42.57	10.39	52.96	74.00	-21.04	peak
7385.619	38.64	12.68	51.32	74.00	-22.68	peak

Remark:
1. Factor = Antenna Factor + Cable Loss – Pre-amplifier.
2. No emission detected above 18GHz

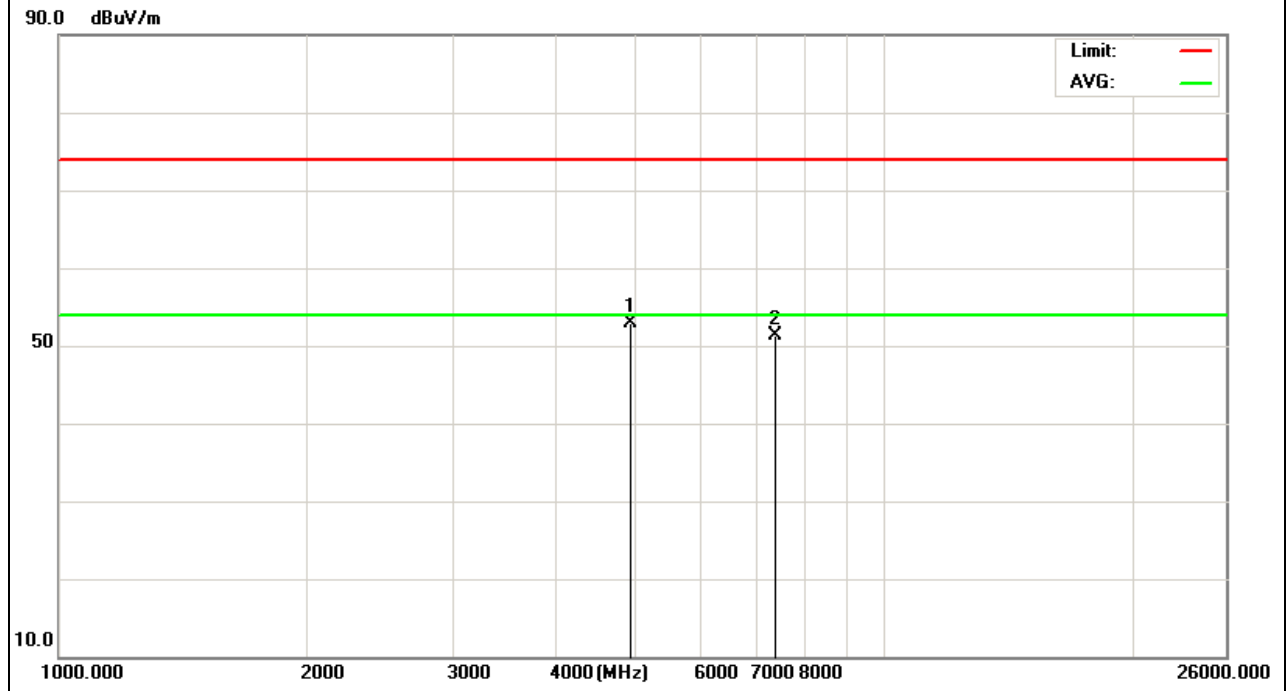

EUT :	IP Camera	Model Name :	SWO-SVC01K
Temperature :	20 °C	Relative Humidity :	48%
Pressure :	1010 hPa	Test Voltage :	DC 5Vfrom adapter AC 120V/60Hz
Test Mode :	CH11 (802.11b Mode)	Polarization :	Vertical

Frequency (MHz)	Meter Reading (dBμV)	Factor (dB)	Emission Level (dBμV/m)	Limits (dBμV/m)	Margin (dB)	Detector Type
4924.657	41.53	10.39	51.92	74.00	-22.08	peak
7386.662	38.90	12.68	51.58	74.00	-22.42	peak

Remark:
Factor = Antenna Factor + Cable Loss – Pre-amplifier.

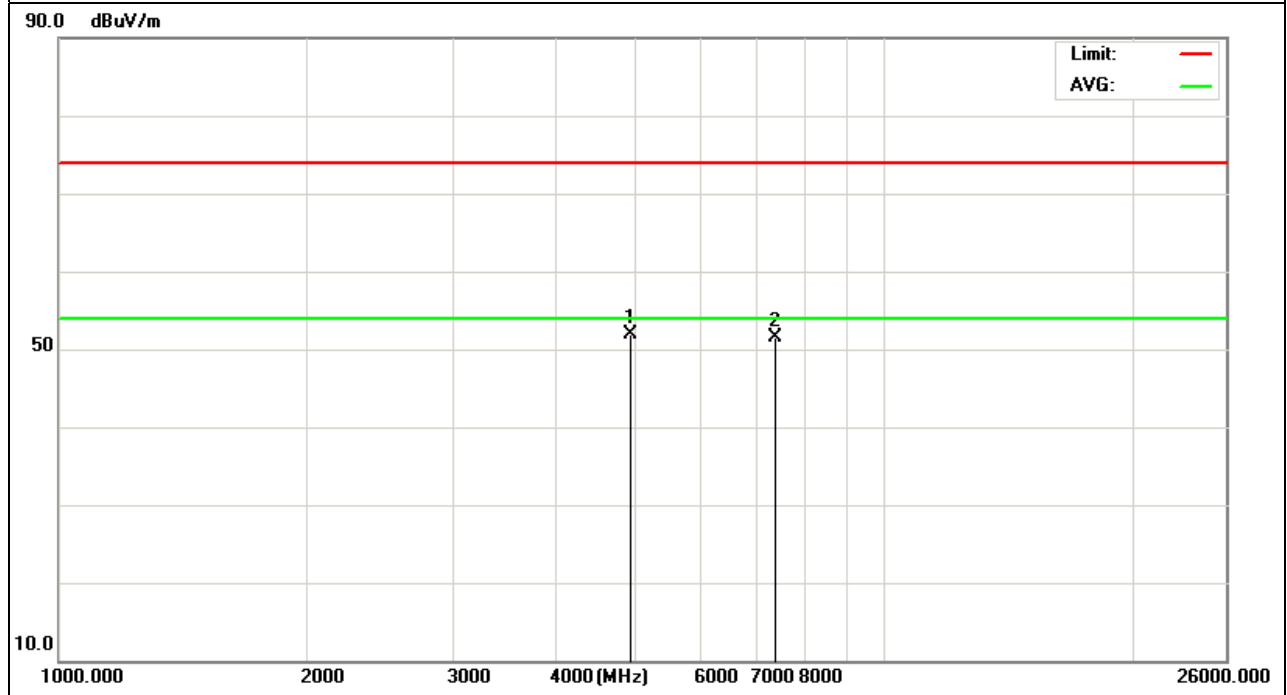

EUT :	IP Camera	Model Name :	SWO-SVC01K
Temperature :	20 °C	Relative Humidity :	48%
Pressure :	1010 hPa	Test Voltage :	DC 5Vfrom adapter AC 120V/60Hz
Test Mode :	CH1 (802.11g Mode)	Polarization :	Horizontal

Frequency (MHz)	Meter Reading (dBµV)	Factor (dB)	Emission Level (dBµV/m)	Limits (dBµV/m)	Margin (dB)	Detector Type
4823.617	42.48	10.44	52.92	74.00	-21.08	peak
7237.384	45.47	12.39	57.86	74.00	-16.14	peak
7237.384	22.64	12.39	35.03	54.00	-18.97	AVG

Remark:
Factor = Antenna Factor + Cable Loss – Pre-amplifier.

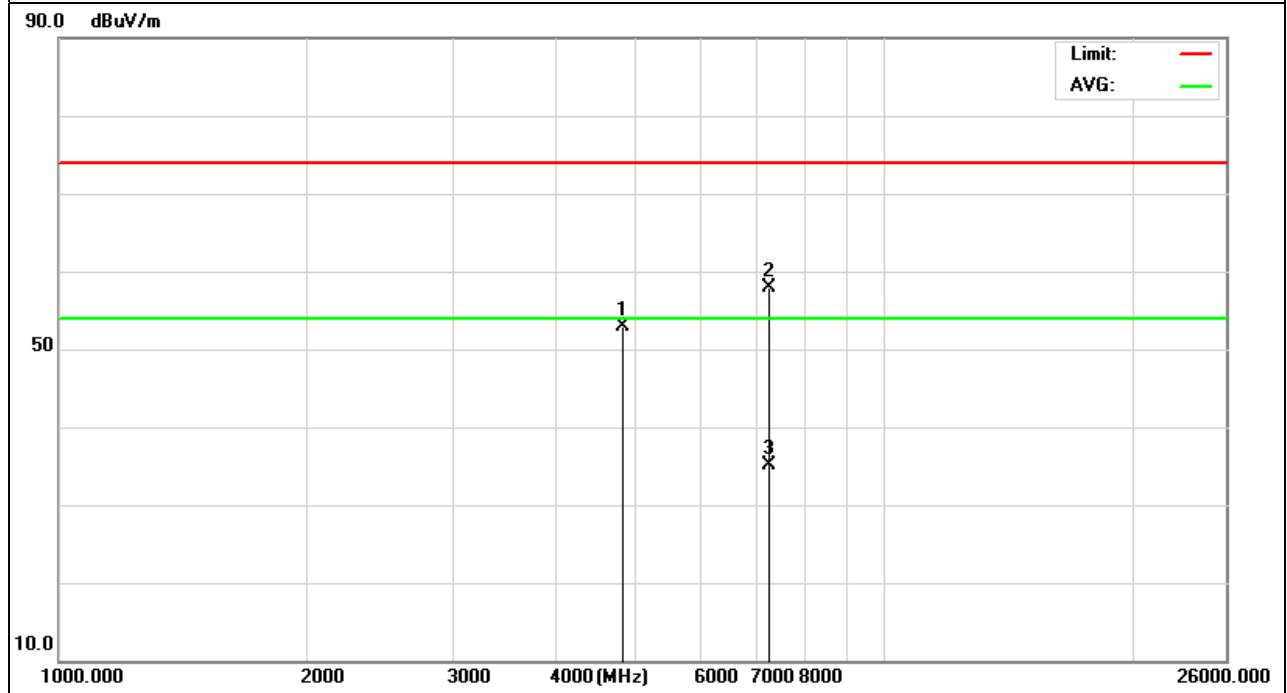

EUT :	IP Camera	Model Name :	SWO-SVC01K
Temperature :	20 °C	Relative Humidity :	48%
Pressure :	1010 hPa	Test Voltage :	DC 5Vfrom adapter AC 120V/60Hz
Test Mode :	CH1 (802.11g Mode)	Polarization :	Vertical

Frequency (MHz)	Meter Reading (dBμV)	Factor (dB)	Emission Level (dBμV/m)	Limits (dBμV/m)	Margin (dB)	Detector Type
4824.337	48.03	10.44	58.47	74.00	-15.53	peak
4824.337	25.62	10.44	36.06	54.00	-17.94	AVG
7235.242	39.23	12.39	51.62	74.00	-22.38	peak

Remark:
Factor = Antenna Factor + Cable Loss – Pre-amplifier.

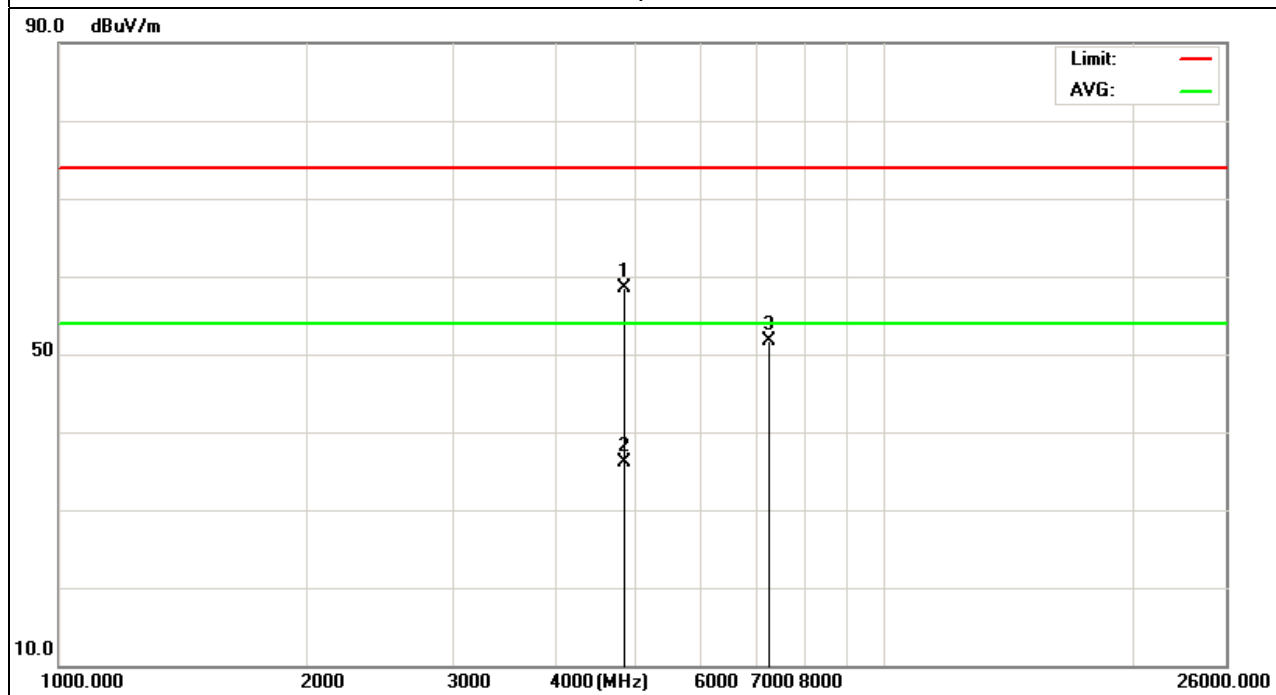

EUT :	IP Camera	Model Name :	SWO-SVC01K
Temperature :	20 °C	Relative Humidity :	48%
Pressure :	1010 hPa	Test Voltage :	DC 5Vfrom adapter AC 120V/60Hz
Test Mode :	CH6 (802.11g Mode)	Polarization :	Horizontal

Frequency (MHz)	Meter Reading (dBµV)	Factor (dB)	Emission Level (dBµV/m)	Limits (dBµV/m)	Margin (dB)	Detector Type
4875.220	43.16	10.39	53.55	74.00	-20.45	peak
7332.494	39.46	12.79	52.25	74.00	-21.75	peak

Remark:
Factor = Antenna Factor + Cable Loss – Pre-amplifier.

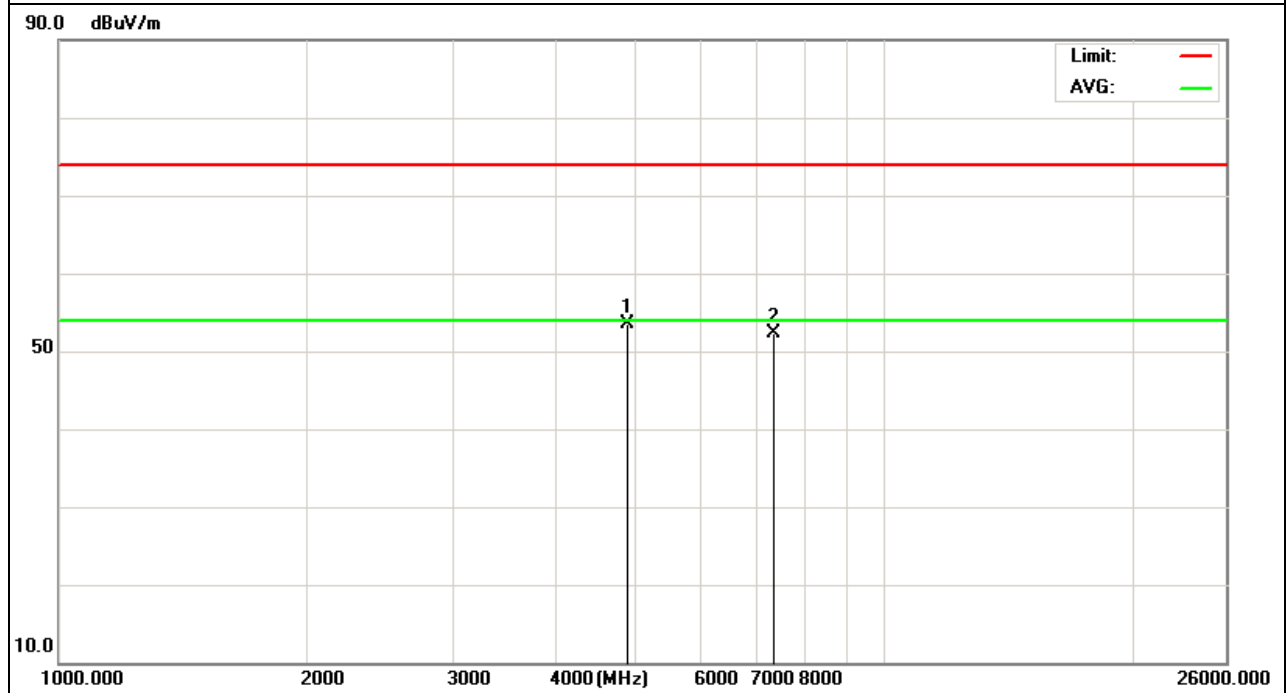

EUT :	IP Camera	Model Name :	SWO-SVC01K
Temperature :	20 °C	Relative Humidity :	48%
Pressure :	1010 hPa	Test Voltage :	DC 5Vfrom adapter AC 120V/60Hz
Test Mode :	CH6 (802.11g Mode)	Polarization :	Vertical

Frequency (MHz)	Meter Reading (dBμV)	Factor (dB)	Emission Level (dBμV/m)	Limits (dBμV/m)	Margin (dB)	Detector Type
4873.031	40.27	10.41	50.68	74.00	-23.32	peak
7333.465	39.06	12.79	51.85	74.00	-22.15	peak

Remark:
Factor = Antenna Factor + Cable Loss – Pre-amplifier.

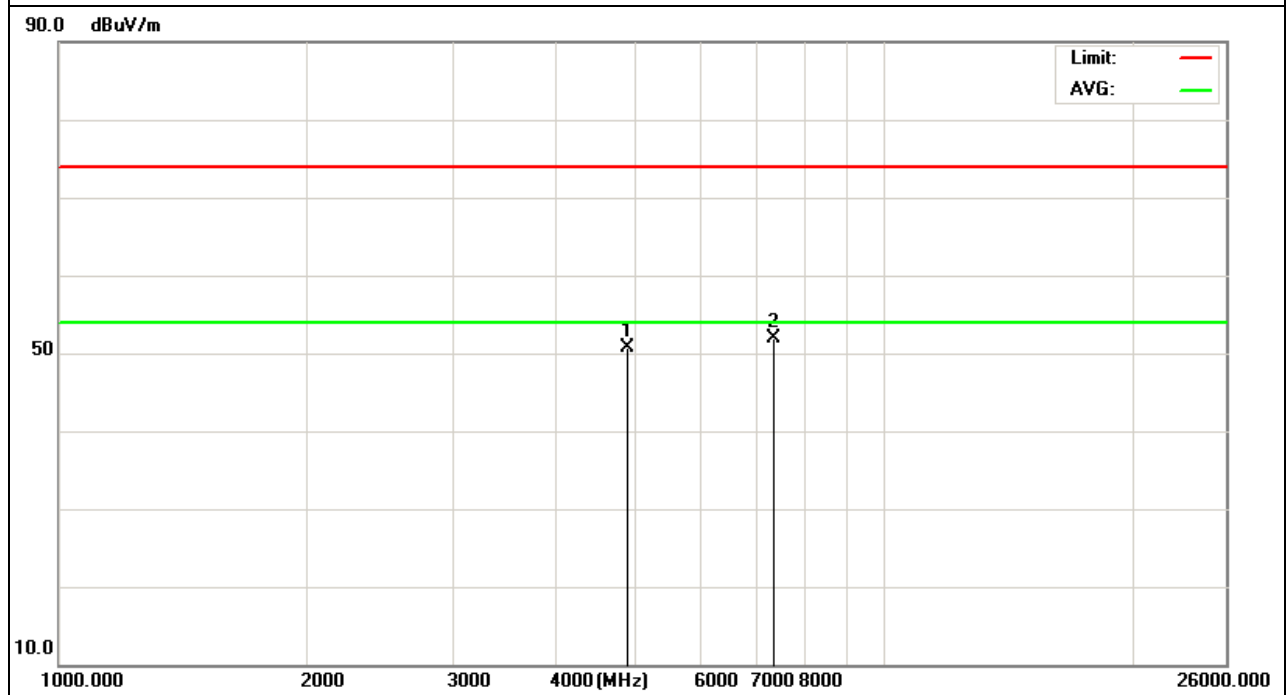

EUT :	IP Camera	Model Name :	SWO-SVC01K
Temperature :	20 °C	Relative Humidity :	48%
Pressure :	1010 hPa	Test Voltage :	DC 5Vfrom adapter AC 120V/60Hz
Test Mode :	CH11 (802.11g Mode)	Polarization :	Horizontal

Frequency (MHz)	Meter Reading (dBμV)	Factor (dB)	Emission Level (dBμV/m)	Limits (dBμV/m)	Margin (dB)	Detector Type
4923.391	42.03	10.39	52.42	74.00	-21.58	peak
7386.247	38.61	12.68	51.29	74.00	-22.71	peak

Remark:
Factor = Antenna Factor + Cable Loss – Pre-amplifier.

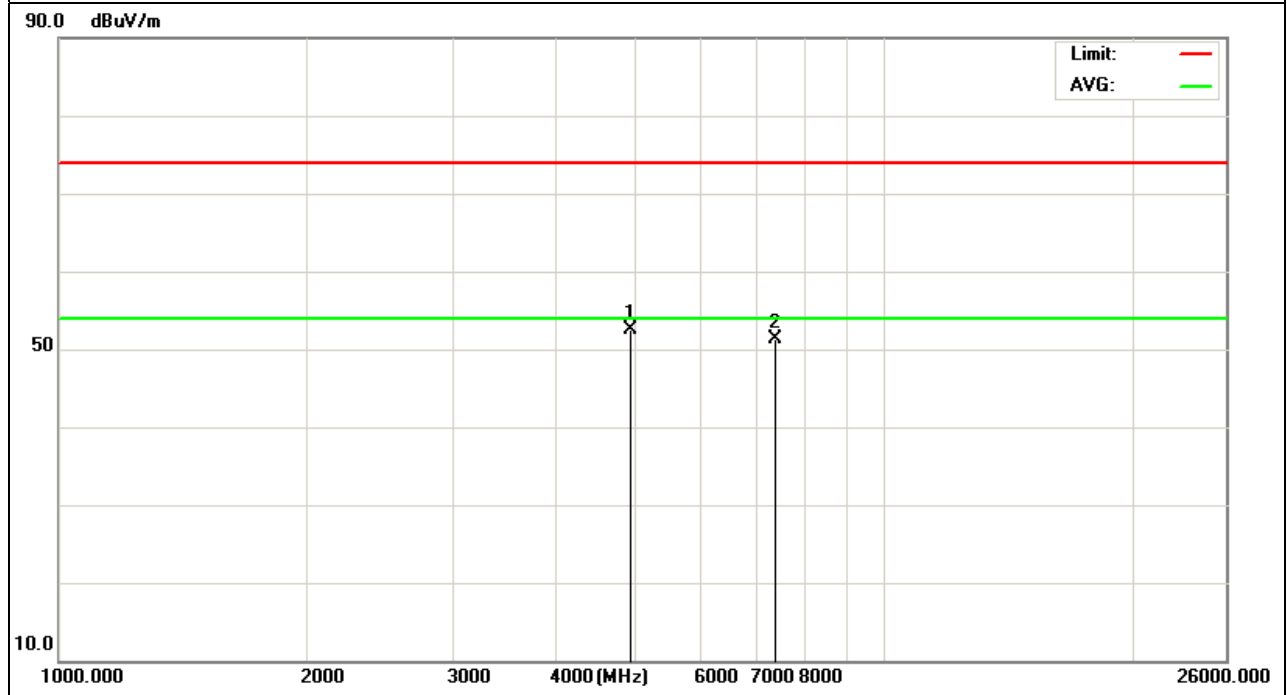

EUT :	IP Camera	Model Name :	SWO-SVC01K
Temperature :	20 °C	Relative Humidity :	48%
Pressure :	1010 hPa	Test Voltage :	DC 5Vfrom adapter AC 120V/60Hz
Test Mode :	CH11(802.11g Mode)	Polarization :	Vertical

Frequency (MHz)	Meter Reading (dBμV)	Factor (dB)	Emission Level (dBμV/m)	Limits (dBμV/m)	Margin (dB)	Detector Type
4925.257	41.92	10.40	52.32	74.00	-21.68	peak
7385.619	40.13	12.68	52.81	74.00	-21.19	peak

Remark:
Factor = Antenna Factor + Cable Loss – Pre-amplifier.

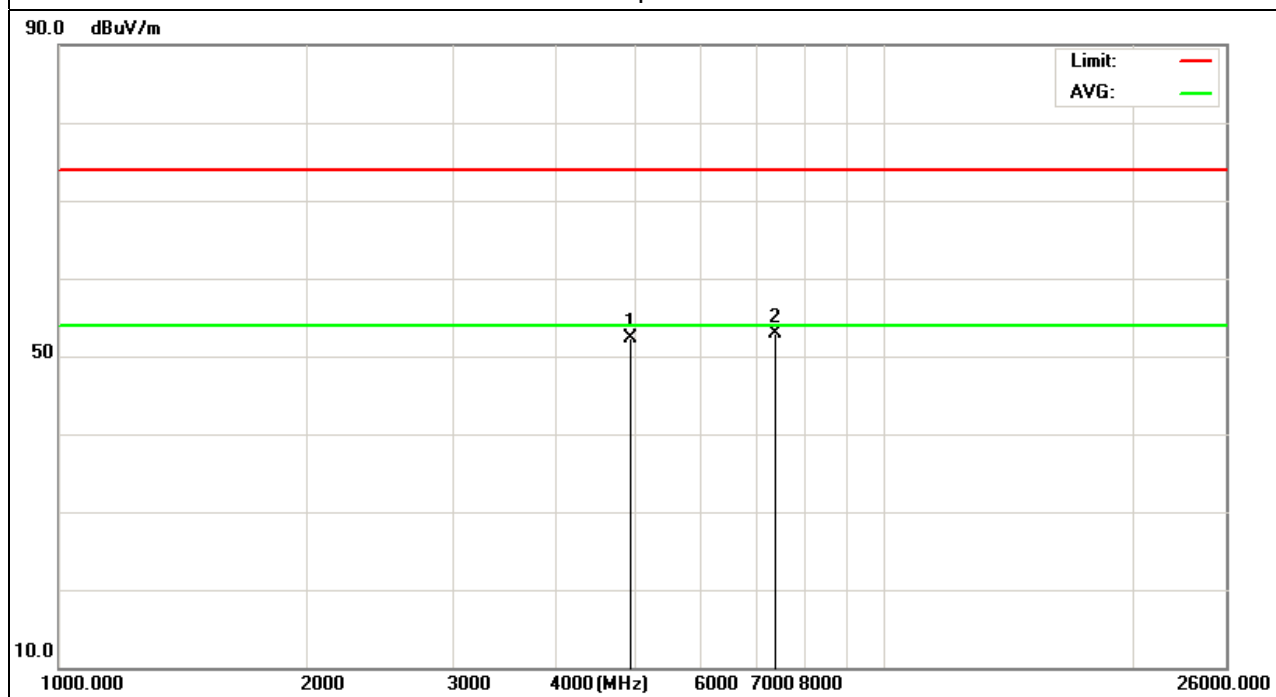

EUT :	IP Camera	Model Name :	SWO-SVC01K
Temperature :	20 °C	Relative Humidity :	48%
Pressure :	1010 hPa	Test Voltage :	DC 5Vfrom adapter AC 120V/60Hz
Test Mode :	CH1(802.11n Mode) /20MHz	Polarization :	Horizontal

Frequency (MHz)	Meter Reading (dBμV)	Factor (dB)	Emission Level (dBμV/m)	Limits (dBμV/m)	Margin (dB)	Detector Type
4824.924	42.19	10.45	52.64	74.00	-21.36	peak
7235.792	39.60	12.39	51.99	74.00	-22.01	peak

Remark:
Factor = Antenna Factor + Cable Loss – Pre-amplifier.

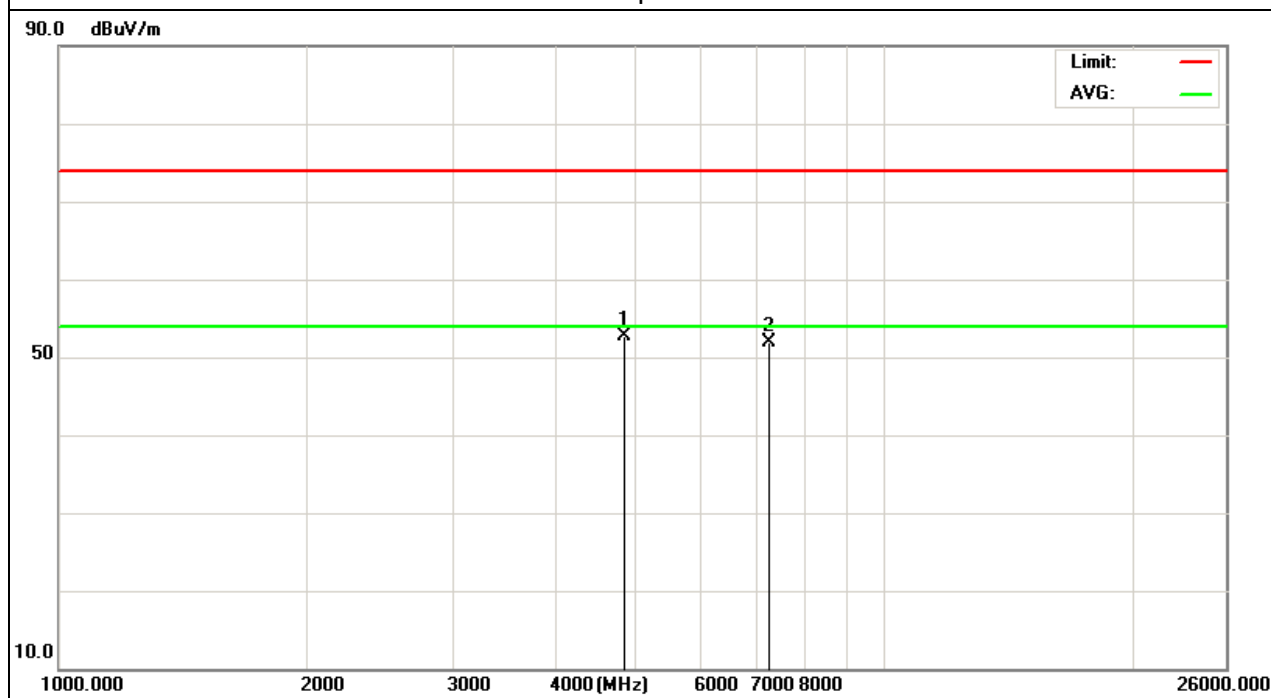

EUT :	IP Camera	Model Name :	SWO-SVC01K
Temperature :	20 °C	Relative Humidity :	48%
Pressure :	1010 hPa	Test Voltage :	DC 5Vfrom adapter AC 120V/60Hz
Test Mode :	CH1(802.11n Mode) /20MHz	Polarization :	Vertical

Frequency (MHz)	Meter Reading (dBμV)	Factor (dB)	Emission Level (dBμV/m)	Limits (dBμV/m)	Margin (dB)	Detector Type
4824.663	41.48	10.44	51.92	74.00	-22.08	peak
7236.719	37.15	12.39	49.54	74.00	-24.46	peak

Remark:
Factor = Antenna Factor + Cable Loss – Pre-amplifier.

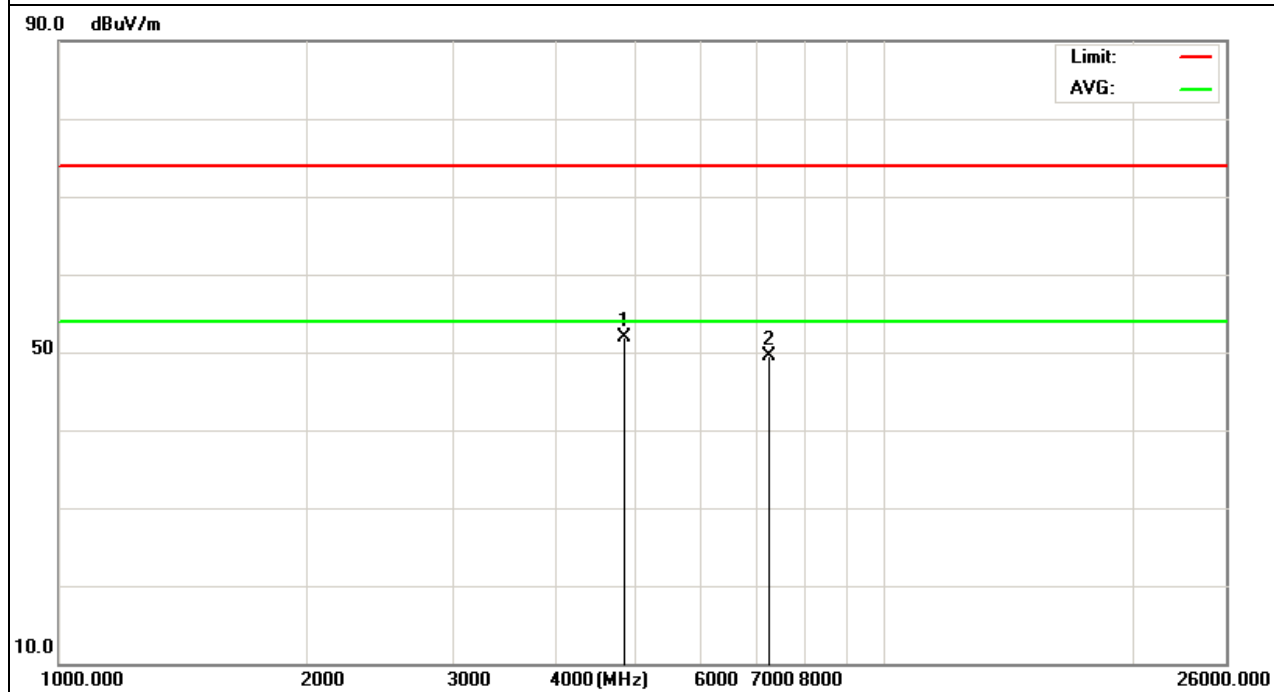

EUT :	IP Camera	Model Name :	SWO-SVC01K
Temperature :	20 °C	Relative Humidity :	48%
Pressure :	1010 hPa	Test Voltage :	DC 5Vfrom adapter AC 120V/60Hz
Test Mode :	CH6(802.11n Mode) /20MHz	Polarization :	Horizontal

Frequency (MHz)	Meter Reading (dBµV)	Factor (dB)	Emission Level (dBµV/m)	Limits (dBµV/m)	Margin (dB)	Detector Type
4875.399	41.68	10.39	52.07	74.00	-21.93	peak
7332.642	38.27	12.79	51.06	74.00	-22.94	peak

Remark:
Factor = Antenna Factor + Cable Loss – Pre-amplifier.

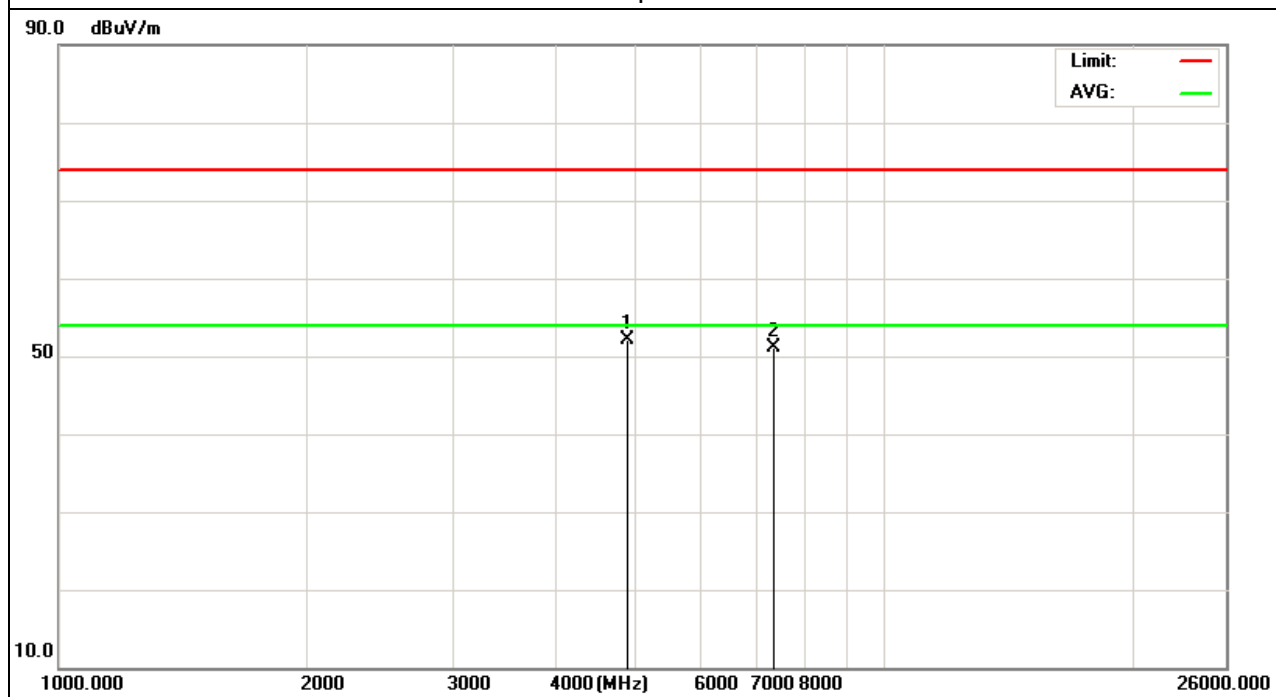

EUT :	IP Camera	Model Name :	SWO-SVC01K
Temperature :	20 °C	Relative Humidity :	48%
Pressure :	1010 hPa	Test Voltage :	DC 5Vfrom adapter AC 120V/60Hz
Test Mode :	CH6(802.11n Mode) /20MHz	Polarization :	Vertical

Frequency (MHz)	Meter Reading (dBµV)	Factor (dB)	Emission Level (dBµV/m)	Limits (dBµV/m)	Margin (dB)	Detector Type
4873.941	41.99	10.40	52.39	74.00	-21.61	peak
7334.093	39.48	12.79	52.27	74.00	-21.73	peak

Remark:
Factor = Antenna Factor + Cable Loss – Pre-amplifier.

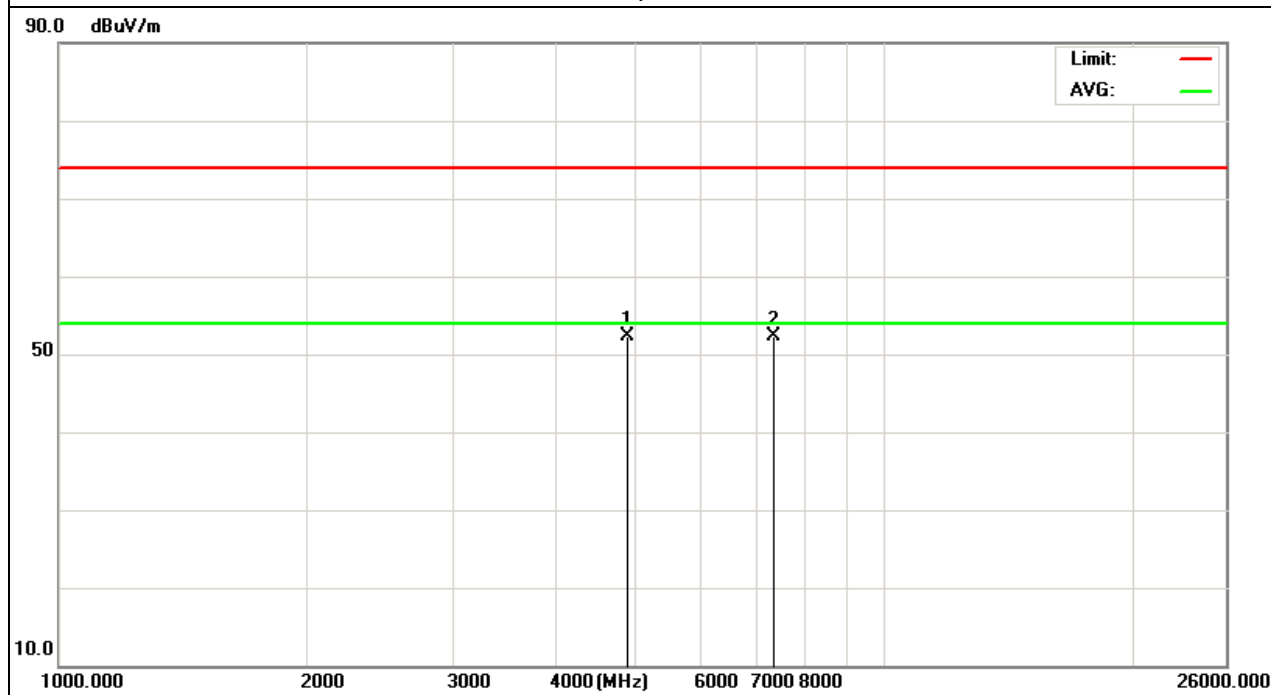

EUT :	IP Camera	Model Name :	SWO-SVC01K
Temperature :	20 °C	Relative Humidity :	48%
Pressure :	1010 hPa	Test Voltage :	DC 5Vfrom adapter AC 120V/60Hz
Test Mode :	CH11(802.11n Mode) /20MHz	Polarization :	Horizontal

Frequency (MHz)	Meter Reading (dBμV)	Factor (dB)	Emission Level (dBμV/m)	Limits (dBμV/m)	Margin (dB)	Detector Type
4923.957	41.93	10.39	52.32	74.00	-21.68	peak
7340.557	39.27	12.79	52.06	74.00	-21.94	peak

Remark:
Factor = Antenna Factor + Cable Loss – Pre-amplifier.

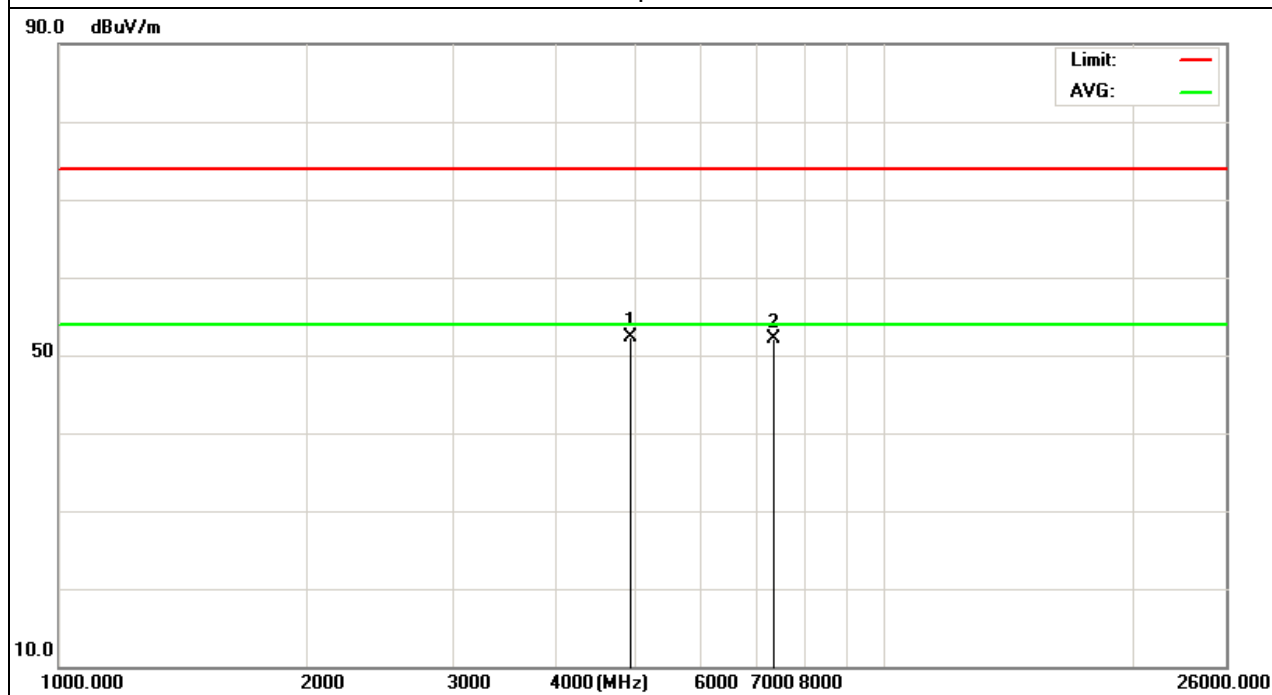

EUT :	IP Camera	Model Name :	SWO-SVC01K
Temperature :	20 °C	Relative Humidity :	48%
Pressure :	1010 hPa	Test Voltage :	DC 5Vfrom adapter AC 120V/60Hz
Test Mode :	CH11(802.11n Mode) /20MHz	Polarization :	Vertical

Frequency (MHz)	Meter Reading (dBμV)	Factor (dB)	Emission Level (dBμV/m)	Limits (dBμV/m)	Margin (dB)	Detector Type
4924.404	41.08	10.39	51.47	74.00	-22.53	peak
7387.457	39.26	12.68	51.94	74.00	-22.06	peak

Remark:
Factor = Antenna Factor + Cable Loss – Pre-amplifier.

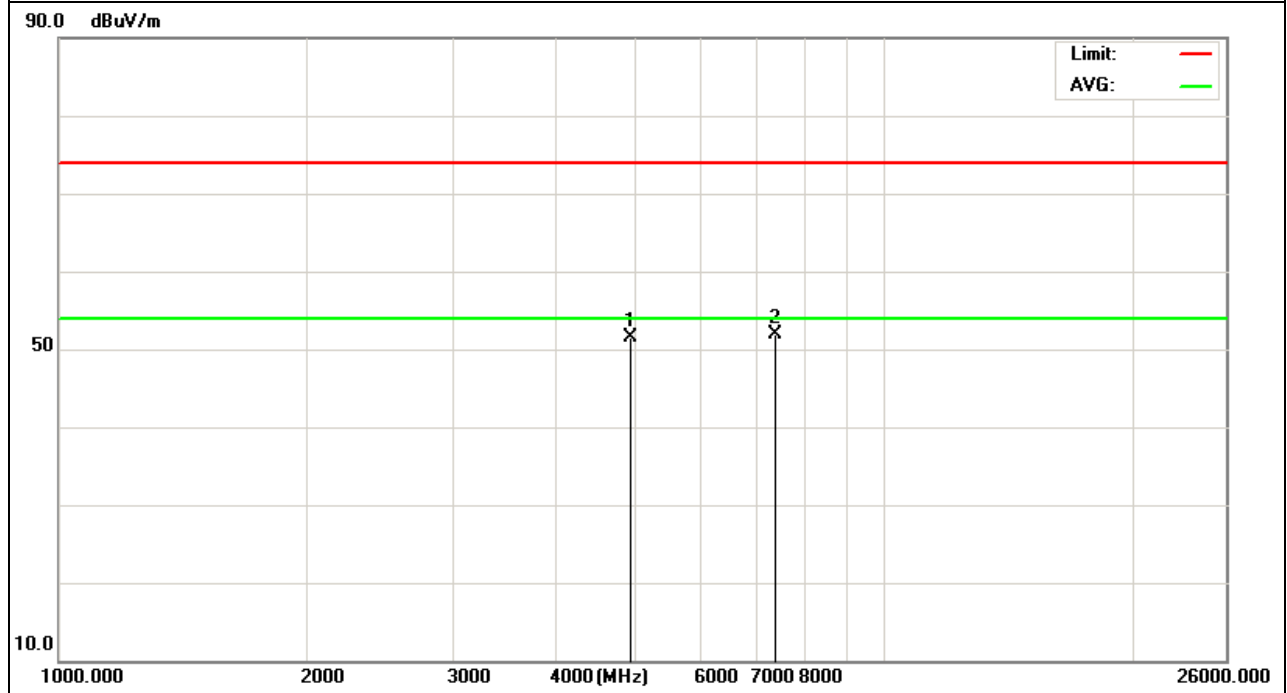

EUT :	IP Camera	Model Name :	SWO-SVC01K
Temperature :	20 °C	Relative Humidity :	48%
Pressure :	1010 hPa	Test Voltage :	DC 5Vfrom adapter AC 120V/60Hz
Test Mode :	CH3(802.11n Mode)/40MHz	Polarization :	Horizontal

Frequency (MHz)	Meter Reading (dBμV)	Factor (dB)	Emission Level (dBμV/m)	Limits (dBμV/m)	Margin (dB)	Detector Type
4845.167	46.03	10.50	56.53	74.00	-17.47	peak
4845.167	24.66	10.50	35.16	54.00	-18.84	AVG
7266.461	43.40	12.50	55.90	74.00	-18.10	peak
7266.461	22.16	12.50	34.66	54.00	-19.34	AVG

Remark:
Factor = Antenna Factor + Cable Loss – Pre-amplifier.

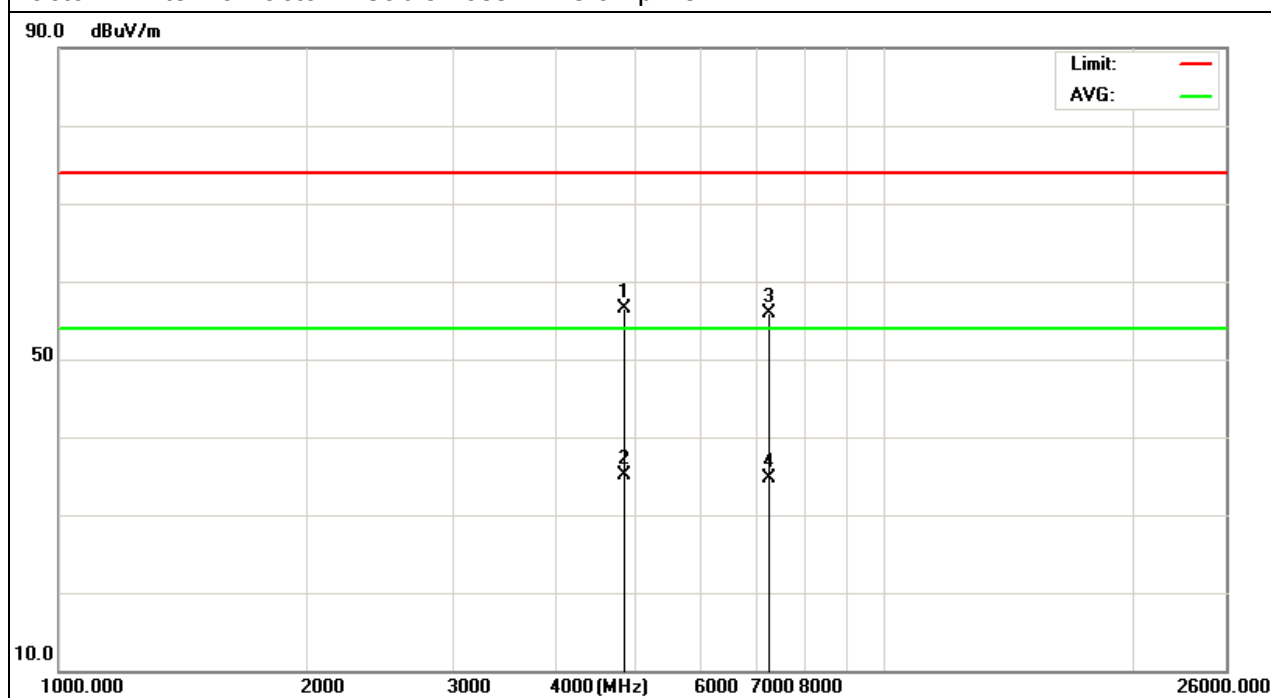

EUT :	IP Camera	Model Name :	SWO-SVC01K
Temperature :	20 °C	Relative Humidity :	48%
Pressure :	1010 hPa	Test Voltage :	DC 5Vfrom adapter AC 120V/60Hz
Test Mode :	CH3(802.11n Mode) /40MHz	Polarization :	Vertical

Frequency (MHz)	Meter Reading (dBμV)	Factor (dB)	Emission Level (dBμV/m)	Limits (dBμV/m)	Margin (dB)	Detector Type
4844.284	45.02	10.50	55.52	74.00	-18.48	peak
4844.284	25.49	10.50	35.99	54.00	-18.01	AVG
7265.590	26.19	12.50	38.69	54.00	-15.31	AVG
7265.599	44.58	12.50	57.08	74.00	-16.92	peak

Remark:
Factor = Antenna Factor + Cable Loss – Pre-amplifier.

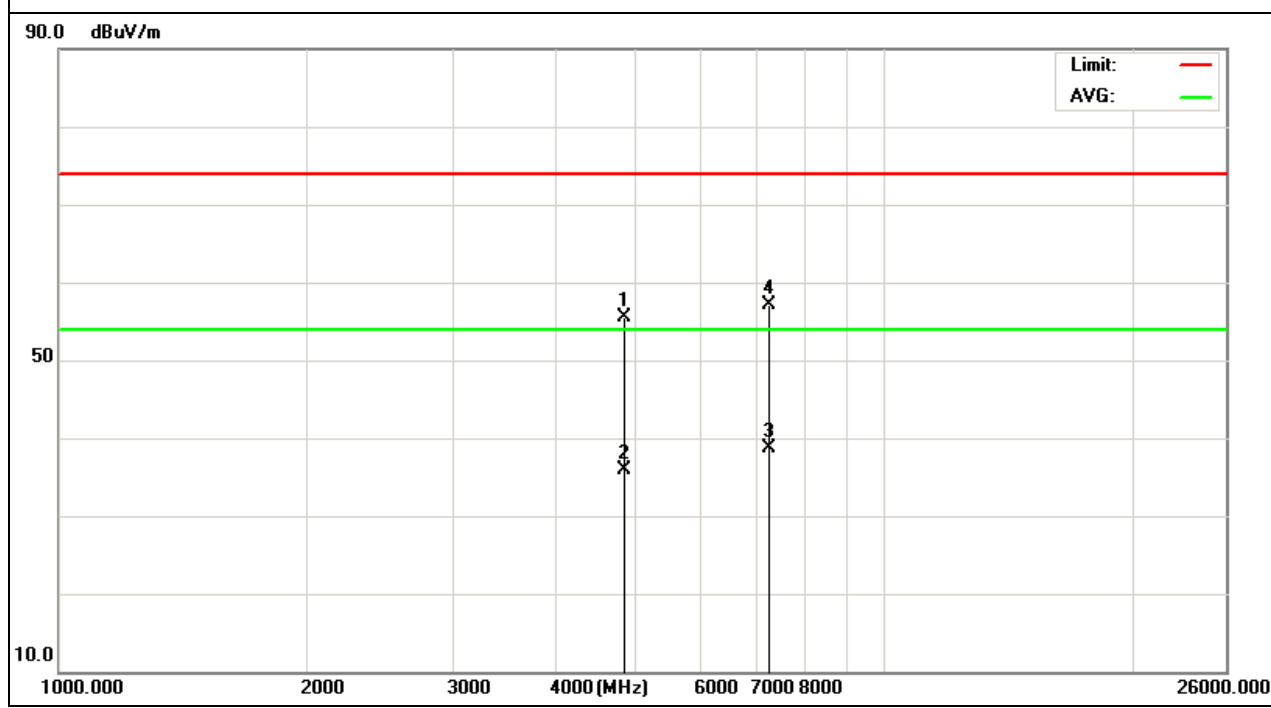

EUT :	IP Camera	Model Name :	SWO-SVC01K
Temperature :	20 °C	Relative Humidity :	48%
Pressure :	1010 hPa	Test Voltage :	DC 5Vfrom adapter AC 120V/60Hz
Test Mode :	CH6(802.11n Mode) /40MHz	Polarization :	Horizontal

Frequency (MHz)	Meter Reading (dBμV)	Factor (dB)	Emission Level (dBμV/m)	Limits (dBμV/m)	Margin (dB)	Detector Type
4873.427	41.20	10.40	51.60	74.00	-22.40	peak
7310.427	44.24	12.75	56.99	74.00	-17.01	peak
7310.517	23.97	12.75	36.72	54.00	-17.28	AVG

Remark:
Factor = Antenna Factor + Cable Loss – Pre-amplifier.

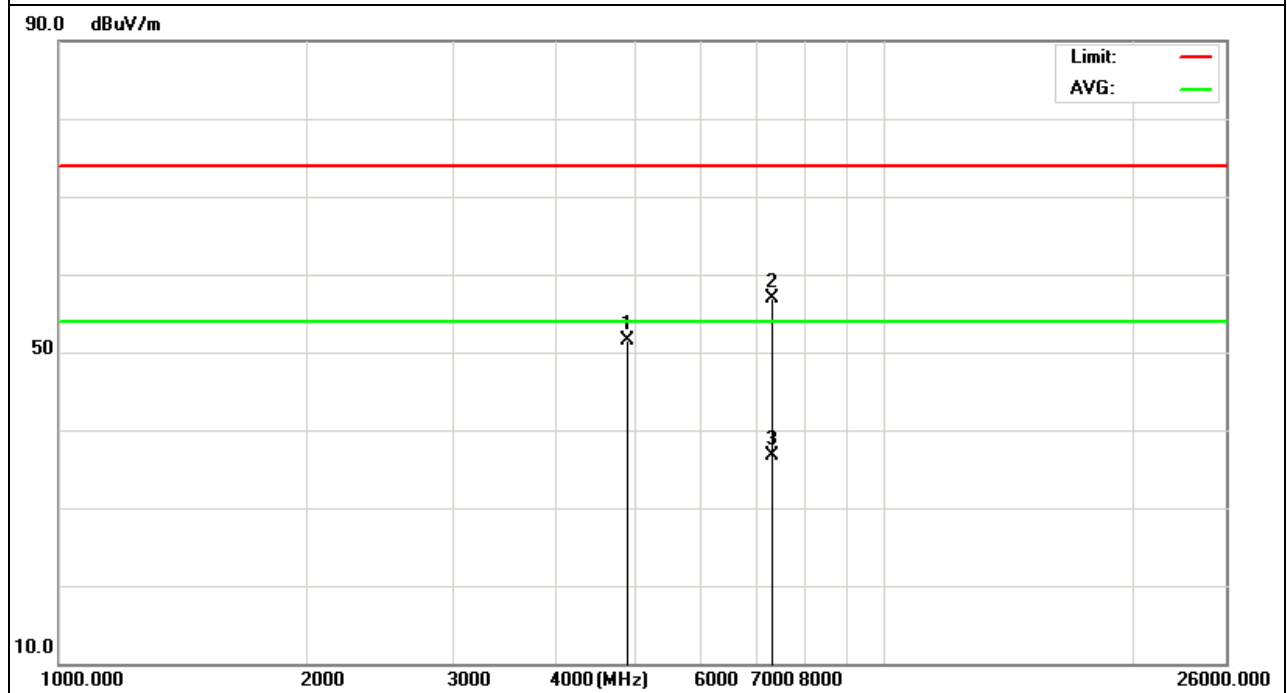

EUT :	IP Camera	Model Name :	SWO-SVC01K
Temperature :	20 °C	Relative Humidity :	48%
Pressure :	1010 hPa	Test Voltage :	DC 5Vfrom adapter AC 120V/60Hz
Test Mode :	CH6(802.11n Mode) /40MHz	Polarization :	Vertical

Frequency (MHz)	Meter Reading (dBμV)	Factor (dB)	Emission Level (dBμV/m)	Limits (dBμV/m)	Margin (dB)	Detector Type
4874.492	46.07	10.40	56.47	74.00	-17.53	peak
4874.492	26.34	10.40	36.74	54.00	-17.26	AVG
7312.590	39.14	12.75	51.89	74.00	-22.11	peak

Remark:
Factor = Antenna Factor + Cable Loss – Pre-amplifier.

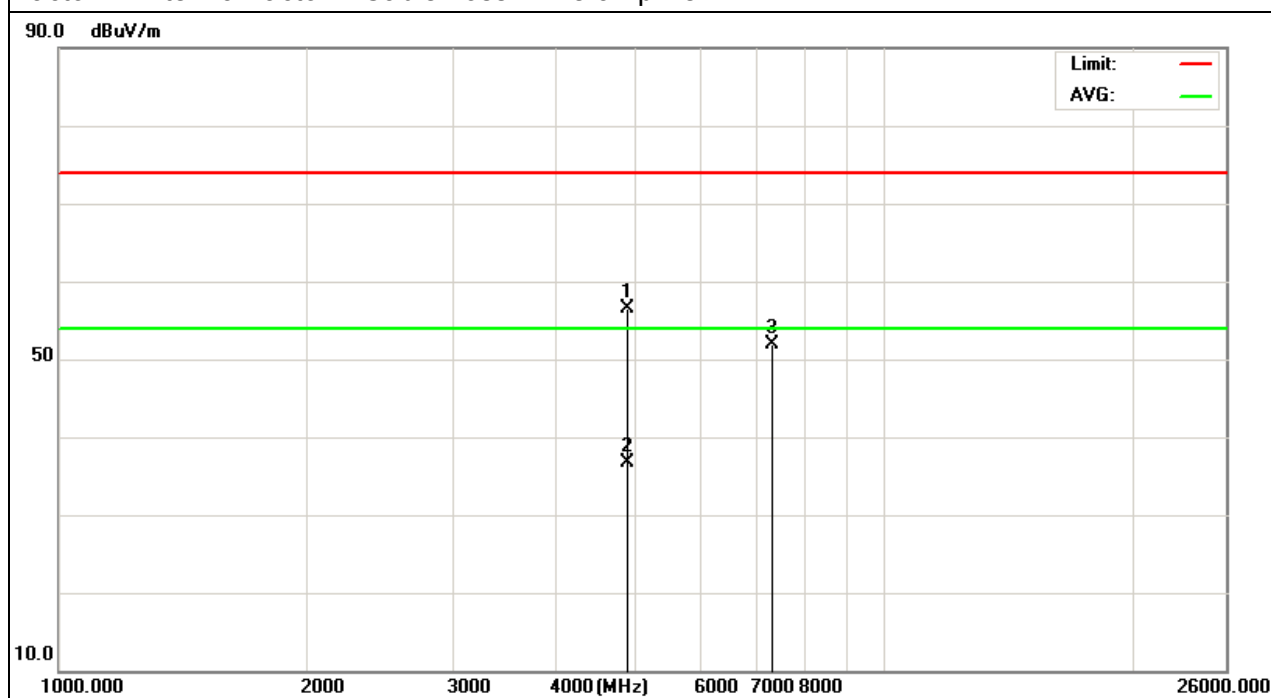

EUT :	IP Camera	Model Name :	SWO-SVC01K
Temperature :	20 °C	Relative Humidity :	48%
Pressure :	1010 hPa	Test Voltage :	DC 5Vfrom adapter AC 120V/60Hz
Test Mode :	CH9(802.11n Mode) /40MHz	Polarization :	Horizontal

Frequency (MHz)	Meter Reading (dBμV)	Factor (dB)	Emission Level (dBμV/m)	Limits (dBμV/m)	Margin (dB)	Detector Type
4905.467	41.71	10.30	52.01	74.00	-21.99	peak
7356.826	38.51	12.79	51.30	74.00	-22.70	peak

Remark:
Factor = Antenna Factor + Cable Loss – Pre-amplifier.

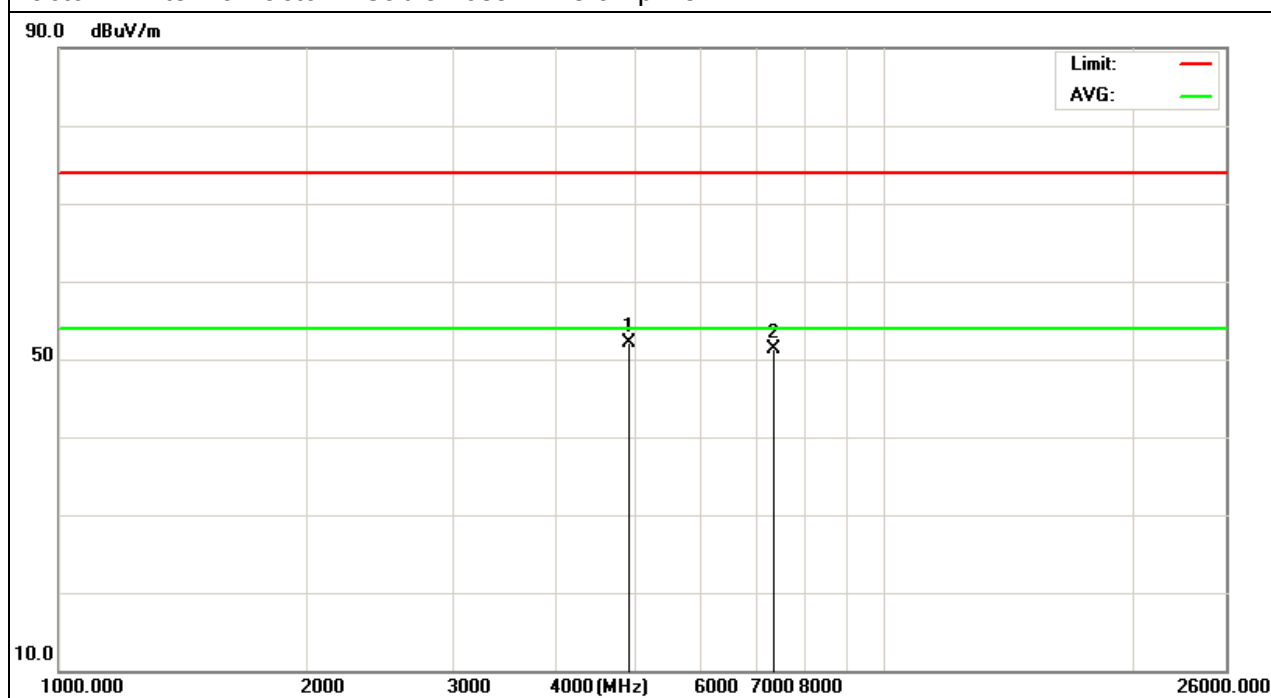

EUT :	IP Camera	Model Name :	SWO-SVC01K
Temperature :	20 °C	Relative Humidity :	48%
Pressure :	1010 hPa	Test Voltage :	DC 5Vfrom adapter AC 120V/60Hz
Test Mode :	CH9(802.11n Mode) /40MHz	Polarization :	Vertical

Frequency (MHz)	Meter Reading (dBμV)	Factor (dB)	Emission Level (dBμV/m)	Limits (dBμV/m)	Margin (dB)	Detector Type
4904.462	46.29	10.30	56.59	74.00	-17.41	peak
4904.462	24.38	10.30	34.68	54.00	-19.32	AVG
7357.239	45.49	12.79	58.28	74.00	-15.72	peak
7357.239	23.28	12.79	36.07	54.00	-17.93	AVG

Remark:
Factor = Antenna Factor + Cable Loss – Pre-amplifier.

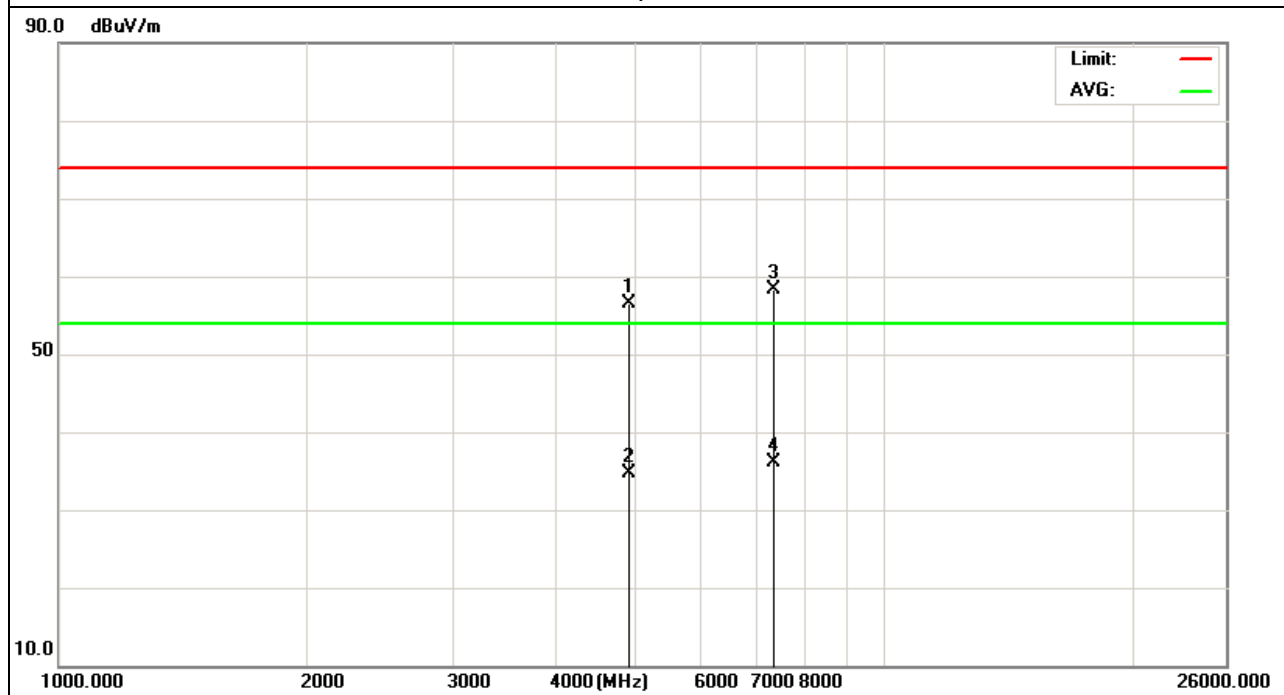

EUT :	IP Camera	Model Name :	SWO-SVC01K
Temperature :	20 °C	Relative Humidity :	48%
Pressure :	1010 hPa	Test Voltage :	DC 5Vfrom adapter AC 120V/60Hz
Test Mode :	CH1(802.11b Mode)	Polarization :	Horizontal

Frequency (MHz)	Meter Reading (dBμV)	Factor (dB)	Emission Level (dBμV/m)	Limits (dBμV/m)	Margin (dB)	Detector Type
2400.000	71.39	-12.99	58.40	74.00	-15.60	peak
2399.050	71.40	-13.00	58.40	74.00	-15.60	peak
2399.050	49.47	-13.00	36.47	54.00	-17.53	AVG
2400.000	48.23	-12.99	35.24	54.00	-18.76	AVG

Remark:
Factor = Antenna Factor + Cable Loss – Pre-amplifier.

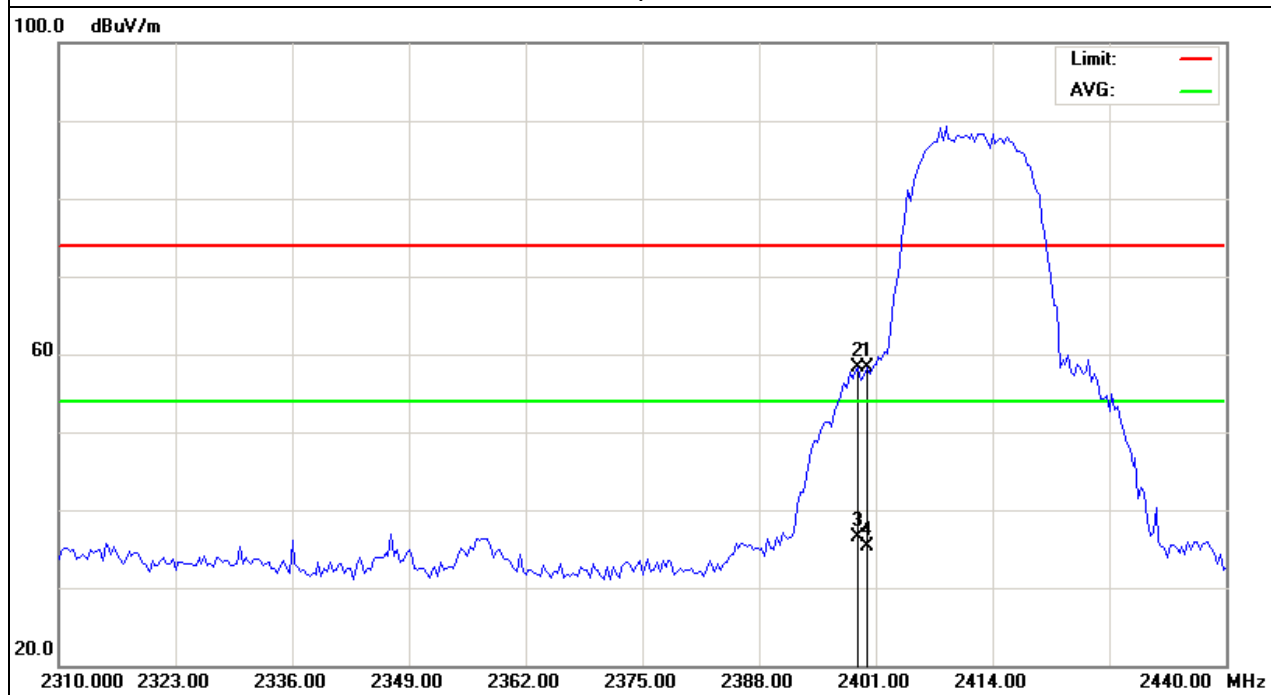

EUT :	IP Camera	Model Name :	SWO-SVC01K
Temperature :	20 °C	Relative Humidity :	48%
Pressure :	1010 hPa	Test Voltage :	DC 5Vfrom adapter AC 120V/60Hz
Test Mode :	CH1(802.11b Mode)	Polarization :	Vertical

Frequency (MHz)	Meter Reading (dBμV)	Factor (dB)	Emission Level (dBμV/m)	Limits (dBμV/m)	Margin (dB)	Detector Type
2399.375	75.89	-12.99	62.90	74.00	-11.10	peak
2399.375	52.16	-12.99	39.17	54.00	-14.83	AVG
2400.000	73.59	-12.99	60.60	74.00	-13.40	peak
2400.000	51.90	-12.99	38.91	54.00	-15.09	AVG

Remark:
Factor = Antenna Factor + Cable Loss – Pre-amplifier.

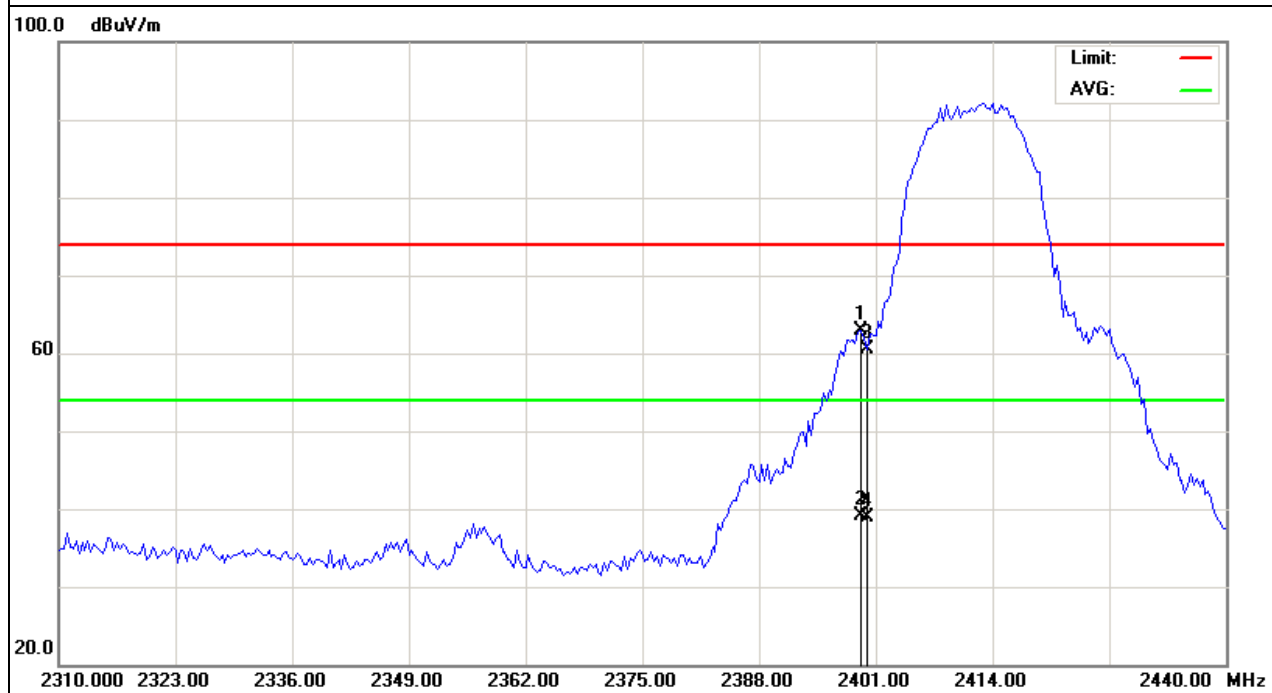

EUT :	IP Camera	Model Name :	SWO-SVC01K
Temperature :	20 °C	Relative Humidity :	48%
Pressure :	1010 hPa	Test Voltage :	DC 5Vfrom adapter AC 120V/60Hz
Test Mode :	CH11(802.11b Mode)	Polarization :	Horizontal

Frequency (MHz)	Meter Reading (dBμV)	Factor (dB)	Emission Level (dBμV/m)	Limits (dBμV/m)	Margin (dB)	Detector Type
2483.500	61.31	-12.78	48.53	74.00	-25.47	peak
2488.150	63.53	-12.77	50.76	74.00	-23.24	peak

Remark:
Factor = Antenna Factor + Cable Loss – Pre-amplifier.

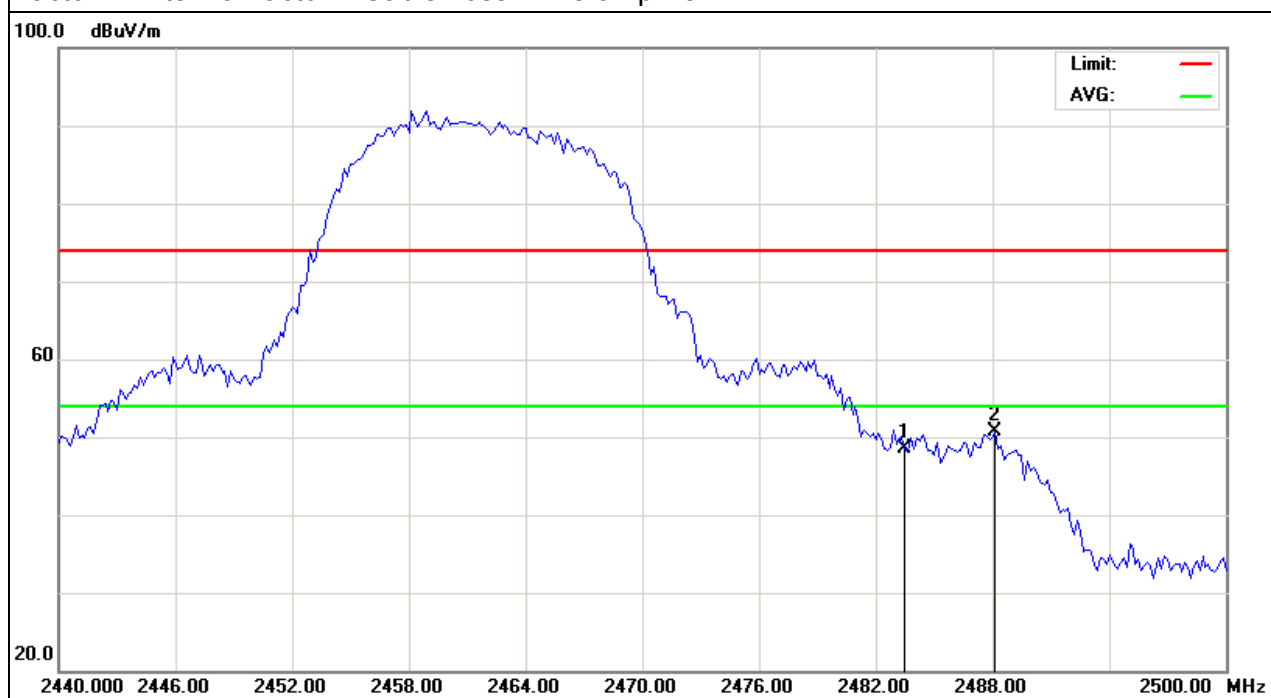

EUT :	IP Camera	Model Name :	SWO-SVC01K
Temperature :	20 °C	Relative Humidity :	48%
Pressure :	1010 hPa	Test Voltage :	DC 5Vfrom adapter AC 120V/60Hz
Test Mode :	CH11(802.11b Mode)	Polarization :	Vertical

Frequency (MHz)	Meter Reading (dBμV)	Factor (dB)	Emission Level (dBμV/m)	Limits (dBμV/m)	Margin (dB)	Detector Type
2483.500	64.18	-12.78	51.40	74.00	-22.60	peak
2483.650	65.88	-12.78	53.10	74.00	-20.90	peak

Remark:
Factor = Antenna Factor + Cable Loss – Pre-amplifier.

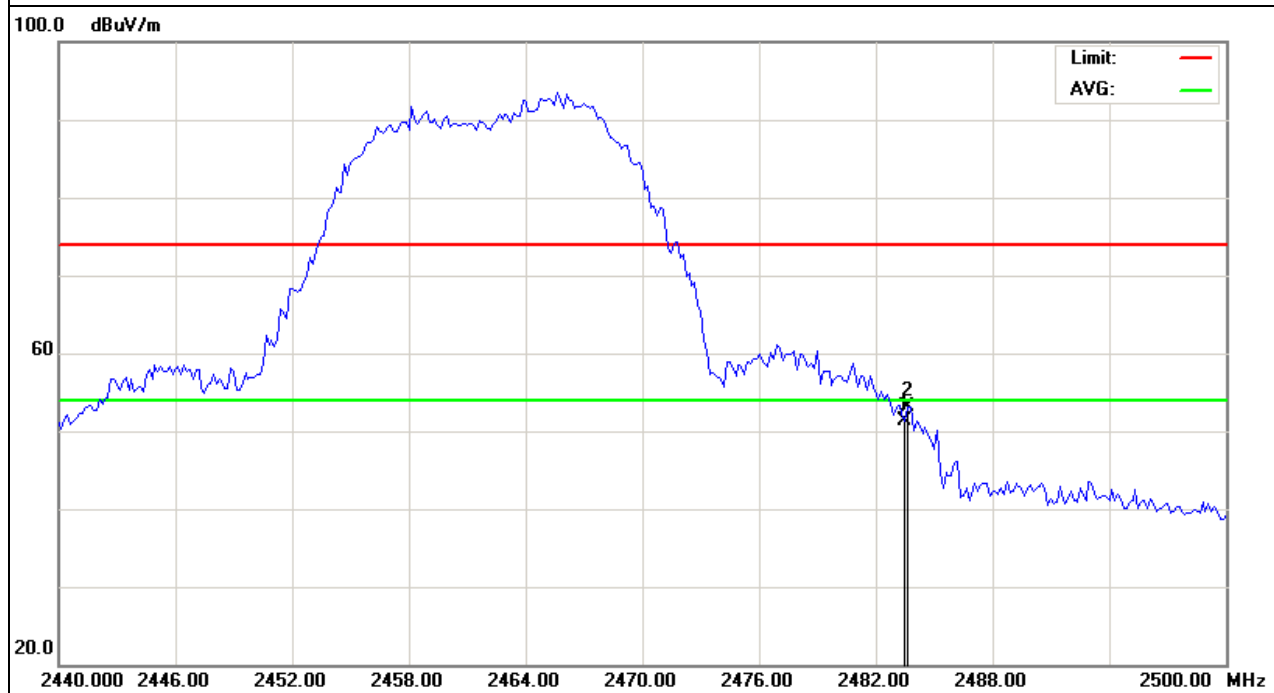

EUT :	IP Camera	Model Name :	SWO-SVC01K
Temperature :	20 °C	Relative Humidity :	48%
Pressure :	1010 hPa	Test Voltage :	DC 5Vfrom adapter AC 120V/60Hz
Test Mode :	CH1(802.11g Mode)	Polarization :	Horizontal

Frequency (MHz)	Meter Reading (dBμV)	Factor (dB)	Emission Level (dBμV/m)	Limits (dBμV/m)	Margin (dB)	Detector Type
2400.000	69.59	-12.99	56.60	74.00	-17.40	peak
2400.000	40.07	-12.99	27.08	54.00	-26.92	AVG

Remark:
Factor = Antenna Factor + Cable Loss – Pre-amplifier.

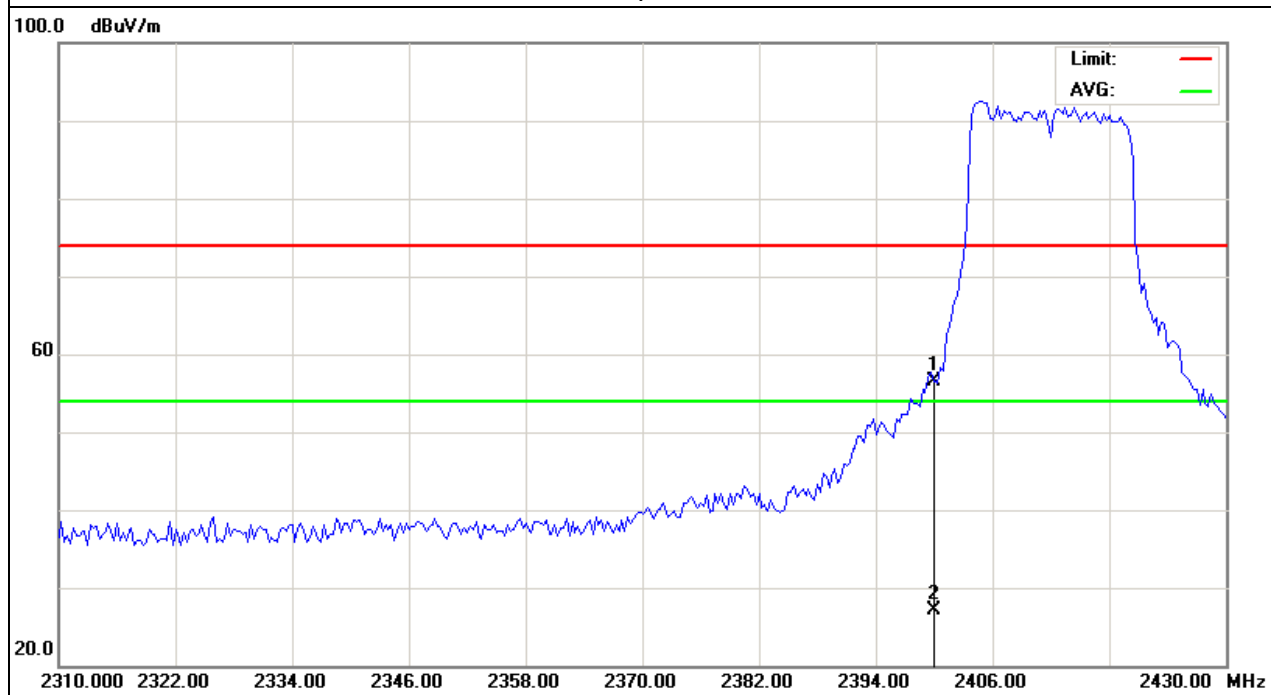

EUT :	IP Camera	Model Name :	SWO-SVC01K
Temperature :	20 °C	Relative Humidity :	48%
Pressure :	1010 hPa	Test Voltage :	DC 5Vfrom adapter AC 120V/60Hz
Test Mode :	CH1(802.11gMode)	Polarization :	Vertical

Frequency (MHz)	Meter Reading (dBμV)	Factor (dB)	Emission Level (dBμV/m)	Limits (dBμV/m)	Margin (dB)	Detector Type
2400.000	68.69	-12.99	55.70	74.00	-18.30	peak
2400.000	68.69	-12.99	55.70	54.00	1.70	AVG

Remark:
Factor = Antenna Factor + Cable Loss – Pre-amplifier.

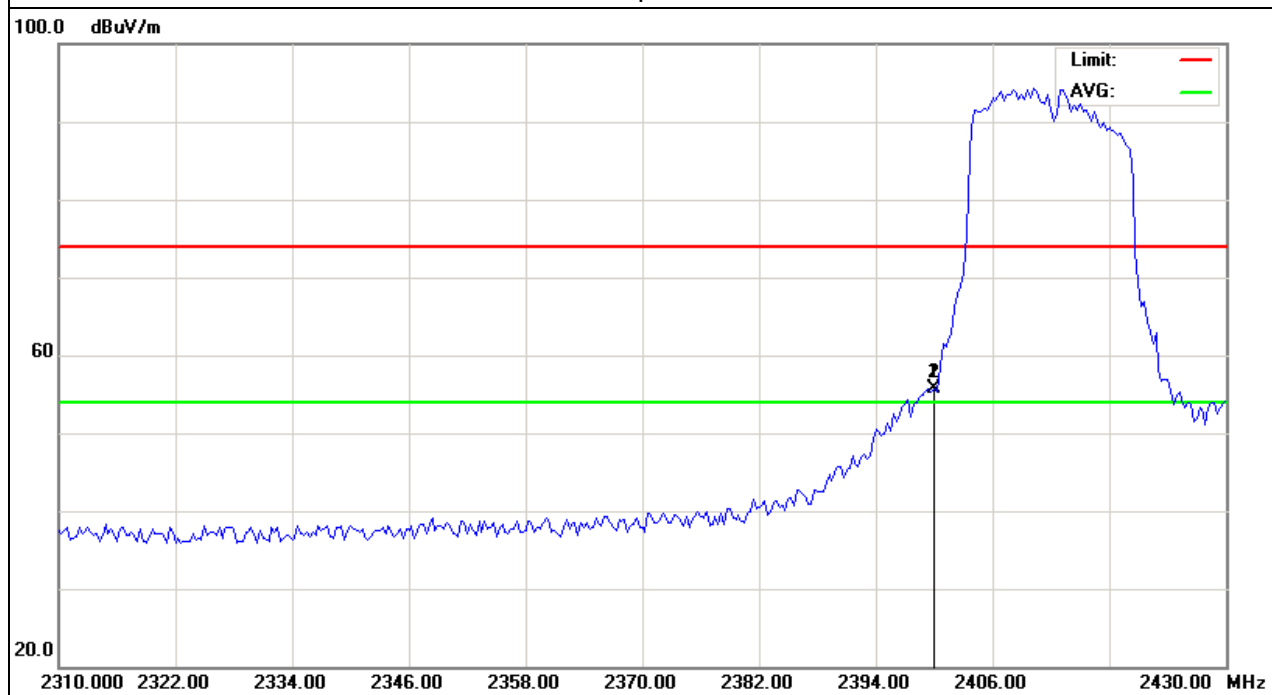

EUT :	IP Camera	Model Name :	SWO-SVC01K
Temperature :	20 °C	Relative Humidity :	48%
Pressure :	1010 hPa	Test Voltage :	DC 5Vfrom adapter AC 120V/60Hz
Test Mode :	CH11(802.11g Mode)	Polarization :	Horizontal

Frequency (MHz)	Meter Reading (dBμV)	Factor (dB)	Emission Level (dBμV/m)	Limits (dBμV/m)	Margin (dB)	Detector Type
2483.500	61.58	-12.78	48.80	74.00	-25.20	peak
2487.100	64.87	-12.77	52.10	74.00	-21.90	peak

Remark:
Factor = Antenna Factor + Cable Loss – Pre-amplifier.

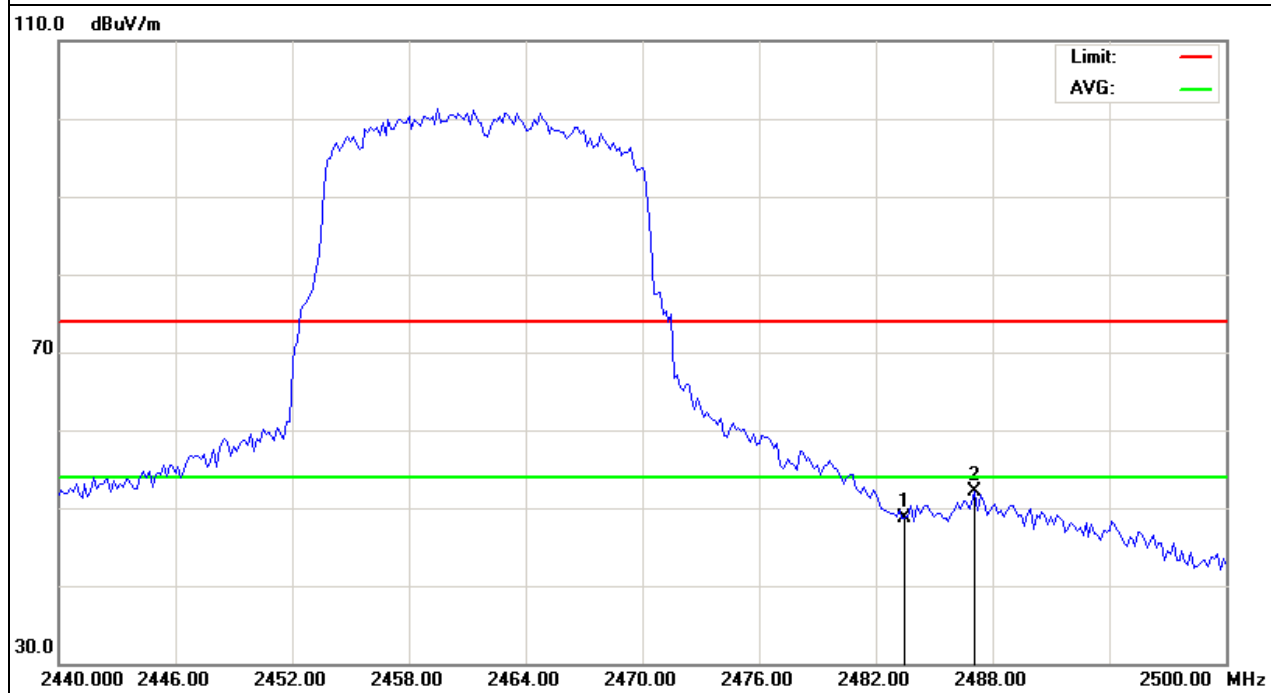

EUT :	IP Camera	Model Name :	SWO-SVC01K
Temperature :	20 °C	Relative Humidity :	48%
Pressure :	1010 hPa	Test Voltage :	DC 5Vfrom adapter AC 120V/60Hz
Test Mode :	CH11(802.11g Mode)	Polarization :	Vertical

Frequency (MHz)	Meter Reading (dBµV)	Factor (dB)	Emission Level (dBµV/m)	Limits (dBµV/m)	Margin (dB)	Detector Type
2483.500	61.85	-12.78	49.07	74.00	-24.93	peak
2485.000	64.68	-12.78	51.90	74.00	-22.10	peak

Remark:
Factor = Antenna Factor + Cable Loss – Pre-amplifier.

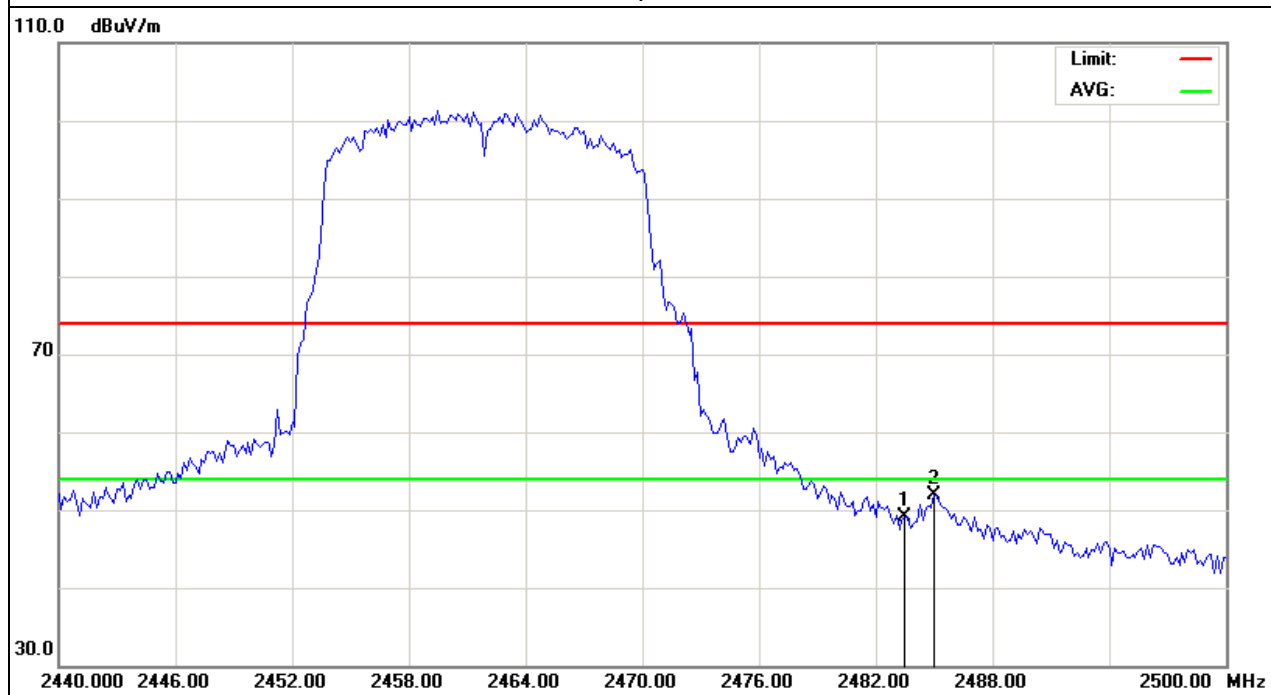

EUT :	IP Camera	Model Name :	SWO-SVC01K
Temperature :	20 °C	Relative Humidity :	48%
Pressure :	1010 hPa	Test Voltage :	DC 5Vfrom adapter AC 120V/60Hz
Test Mode :	CH1(802.11N Mode)	Polarization :	Horizontal

Frequency (MHz)	Meter Reading (dBμV)	Factor (dB)	Emission Level (dBμV/m)	Limits (dBμV/m)	Margin (dB)	Detector Type
2400.000	69.89	-12.99	56.90	74.00	-17.10	peak
2400.000	49.64	-12.99	36.65	54.00	-17.35	AVG

Remark:
Factor = Antenna Factor + Cable Loss – Pre-amplifier.

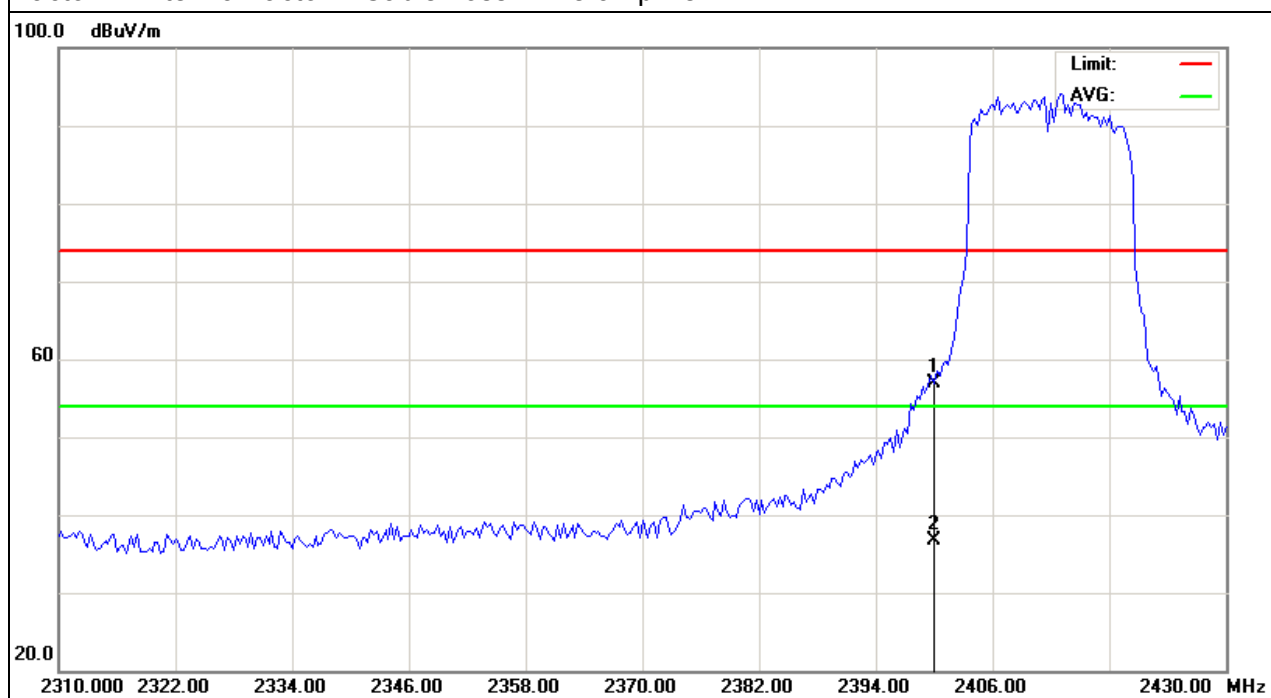

EUT :	IP Camera	Model Name :	SWO-SVC01K
Temperature :	20 °C	Relative Humidity :	48%
Pressure :	1010 hPa	Test Voltage :	DC 5Vfrom adapter AC 120V/60Hz
Test Mode :	CH1(802.11N Mode)	Polarization :	Vertical

Frequency (MHz)	Meter Reading (dBμV)	Factor (dB)	Emission Level (dBμV/m)	Limits (dBμV/m)	Margin (dB)	Detector Type
2400.000	71.39	-12.99	58.40	74.00	-15.60	peak
2400.000	49.16	-12.99	36.17	54.00	-17.83	AVG

Remark:
Factor = Antenna Factor + Cable Loss – Pre-amplifier.

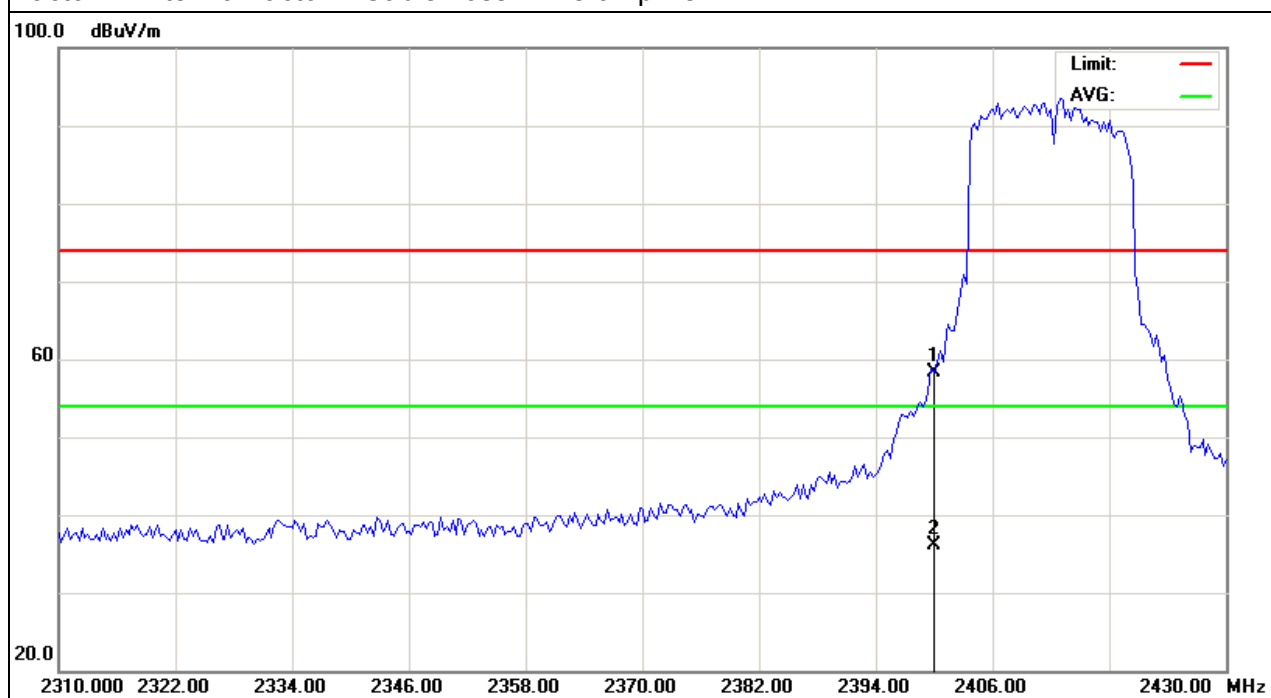

EUT :	IP Camera	Model Name :	SWO-SVC01K
Temperature :	20 °C	Relative Humidity :	48%
Pressure :	1010 hPa	Test Voltage :	DC 5Vfrom adapter AC 120V/60Hz
Test Mode :	CH11(802.11N Mode)	Polarization :	Horizontal

Frequency (MHz)	Meter Reading (dBµV)	Factor (dB)	Emission Level (dBµV/m)	Limits (dBµV/m)	Margin (dB)	Detector Type
2483.500	58.28	-12.78	45.50	74.00	-28.50	peak
2486.500	59.77	-12.77	47.00	74.00	-27.00	peak

Remark:
Factor = Antenna Factor + Cable Loss – Pre-amplifier.

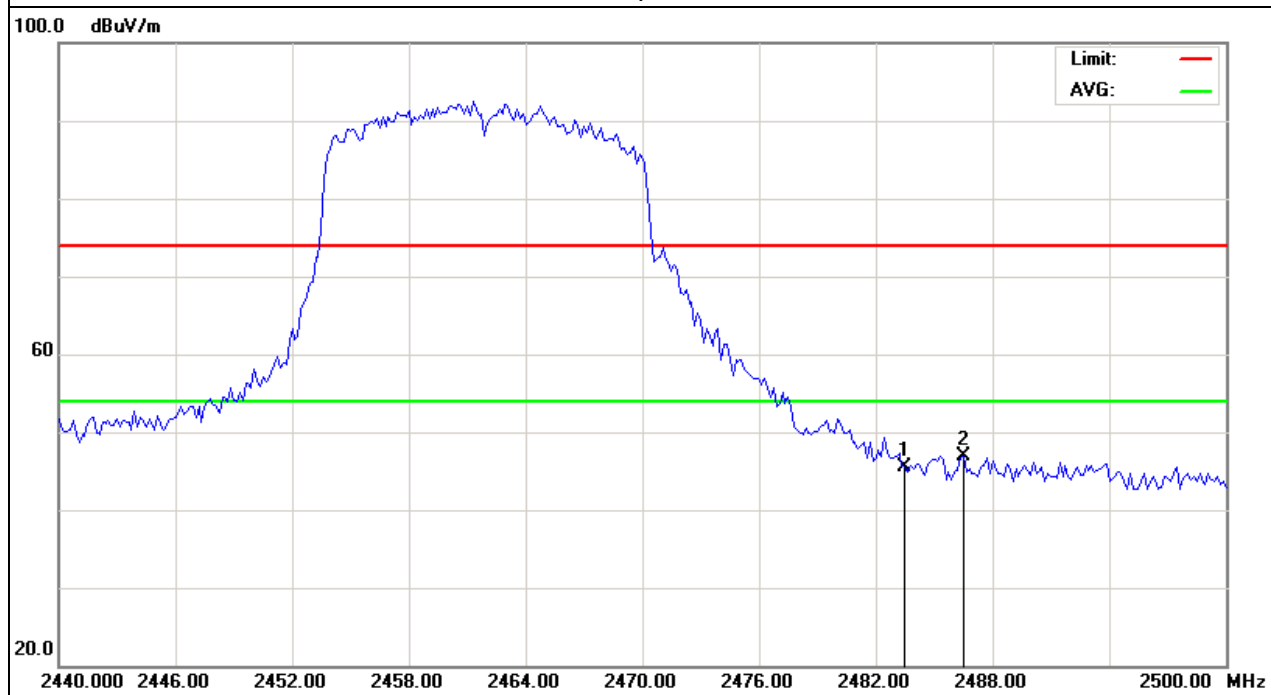

EUT :	IP Camera	Model Name :	SWO-SVC01K
Temperature :	20 °C	Relative Humidity :	48%
Pressure :	1010 hPa	Test Voltage :	DC 5Vfrom adapter AC 120V/60Hz
Test Mode :	CH11(802.11N Mode)	Polarization :	Vertical

Frequency (MHz)	Meter Reading (dBμV)	Factor (dB)	Emission Level (dBμV/m)	Limits (dBμV/m)	Margin (dB)	Detector Type
2483.500	61.78	-12.78	49.00	74.00	-25.00	peak

Remark:
Factor = Antenna Factor + Cable Loss – Pre-amplifier.

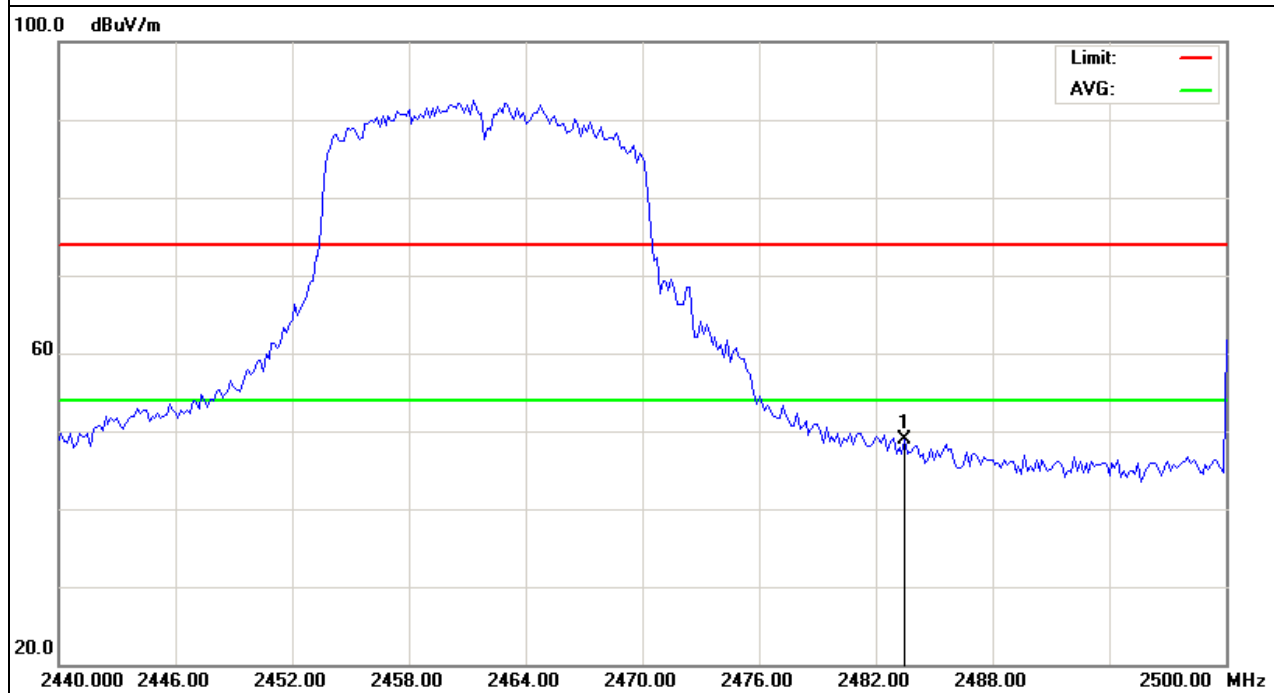

EUT :	IP Camera	Model Name :	SWO-SVC01K
Temperature :	20 °C	Relative Humidity :	48%
Pressure :	1010 hPa	Test Voltage :	DC 5Vfrom adapter AC 120V/60Hz
Test Mode :	CH9(802.11n Mode)/40MHz	Polarization :	Horizontal

Frequency (MHz)	Meter Reading (dBμV)	Factor (dB)	Emission Level (dBμV/m)	Limits (dBμV/m)	Margin (dB)	Detector Type
2483.500	66.08	-12.78	53.30	74.00	-20.70	peak

Remark:
Factor = Antenna Factor + Cable Loss – Pre-amplifier.

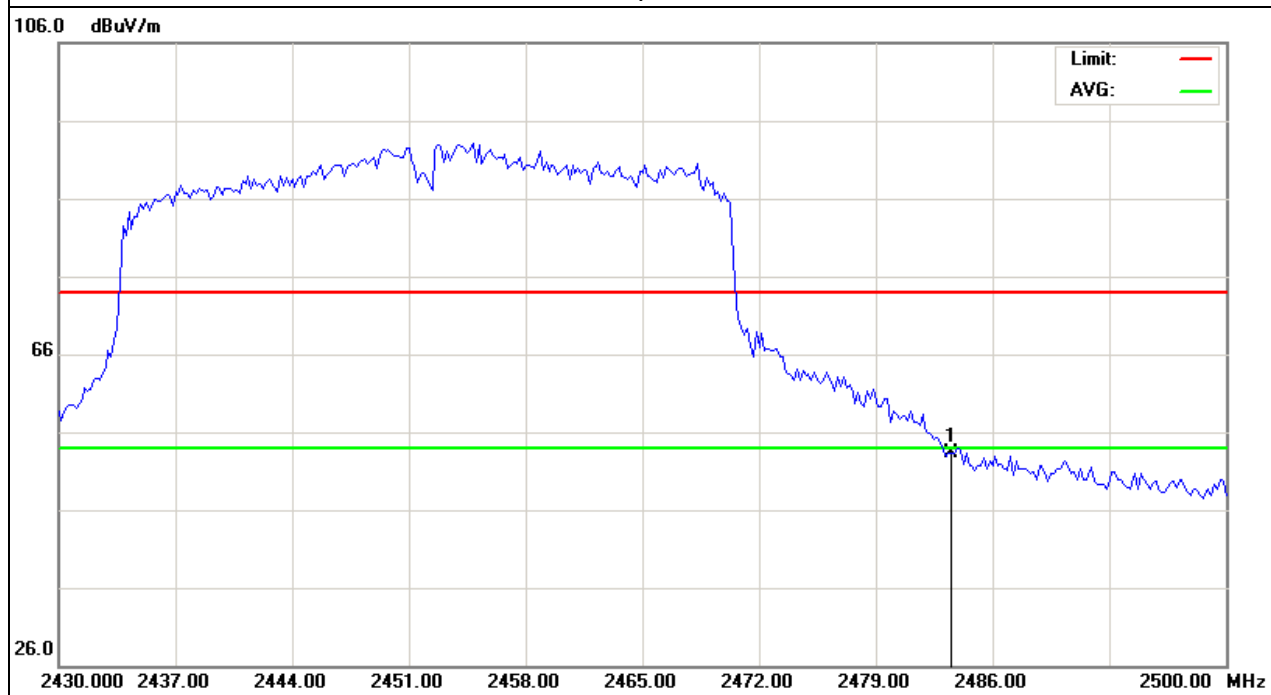

EUT :	IP Camera	Model Name :	SWO-SVC01K
Temperature :	20 °C	Relative Humidity :	48%
Pressure :	1010 hPa	Test Voltage :	DC 5Vfrom adapter AC 120V/60Hz
Test Mode :	CH9(802.11n Mode) /40MHz	Polarization :	Vertical

Frequency (MHz)	Meter Reading (dBμV)	Factor (dB)	Emission Level (dBμV/m)	Limits (dBμV/m)	Margin (dB)	Detector Type
2483.500	65.28	-12.78	52.50	74.00	-21.50	peak

Remark:
Factor = Antenna Factor + Cable Loss – Pre-amplifier.

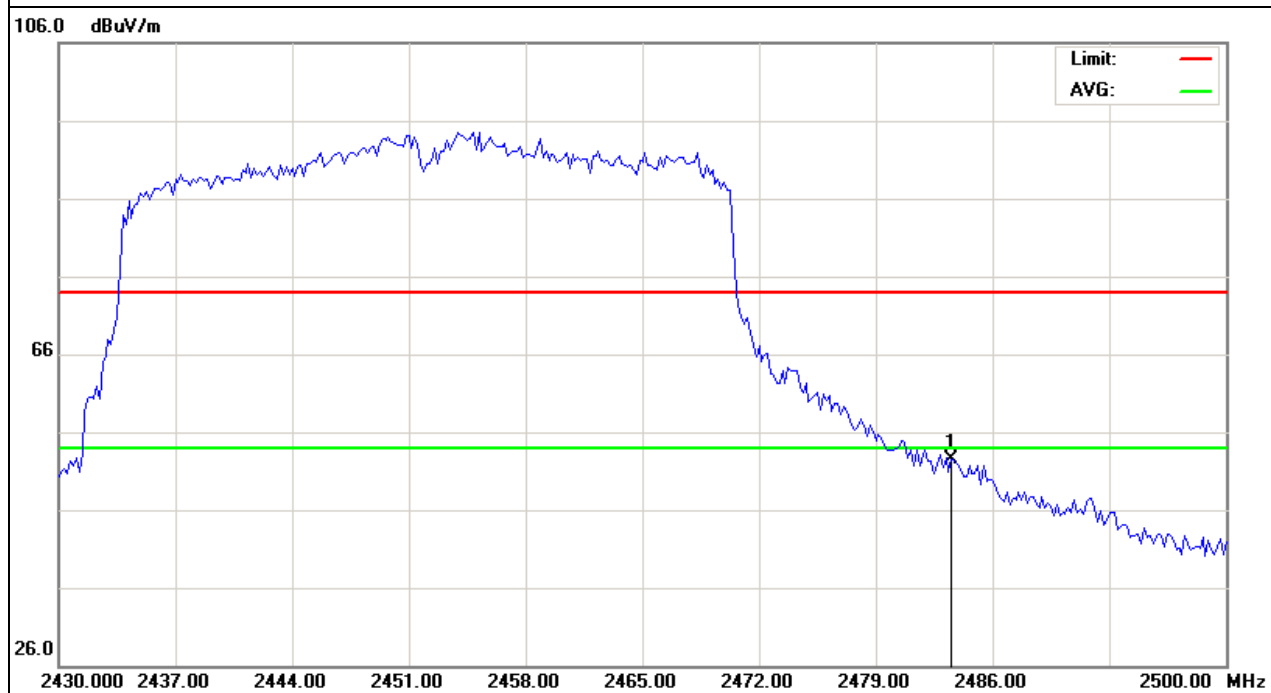

EUT :	IP Camera	Model Name :	SWO-SVC01K
Temperature :	20 °C	Relative Humidity :	48%
Pressure :	1010 hPa	Test Voltage :	DC 5Vfrom adapter AC 120V/60Hz
Test Mode :	CH3(802.11n Mode) /40MHz	Polarization :	Horizontal

Frequency (MHz)	Meter Reading (dBμV)	Factor (dB)	Emission Level (dBμV/m)	Limits (dBμV/m)	Margin (dB)	Detector Type
2400.000	74.39	-12.99	61.40	74.00	-12.60	peak
2400.000	48.57	-12.99	35.58	54.00	-18.42	AVG

Remark:
Factor = Antenna Factor + Cable Loss – Pre-amplifier.

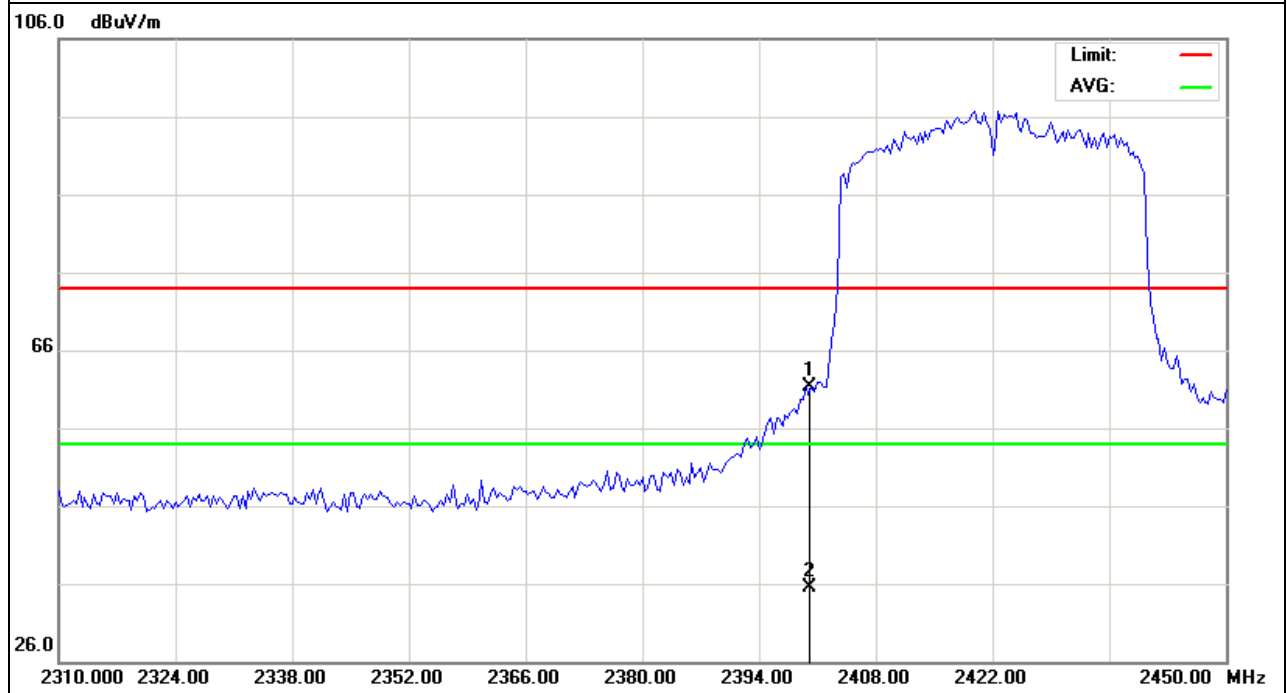

EUT :	IP Camera	Model Name :	SWO-SVC01K
Temperature :	20 °C	Relative Humidity :	48%
Pressure :	1010 hPa	Test Voltage :	DC 5Vfrom adapter AC 120V/60Hz
Test Mode :	CH3(802.11n Mode) /40MHz	Polarization :	Vertical

Frequency (MHz)	Meter Reading (dBμV)	Factor (dB)	Emission Level (dBμV/m)	Limits (dBμV/m)	Margin (dB)	Detector Type
2400.000	76.49	-12.99	63.50	74.00	-10.50	peak
2400.000	47.92	-12.99	34.93	54.00	-19.07	AVG

Remark:
Factor = Antenna Factor + Cable Loss – Pre-amplifier.

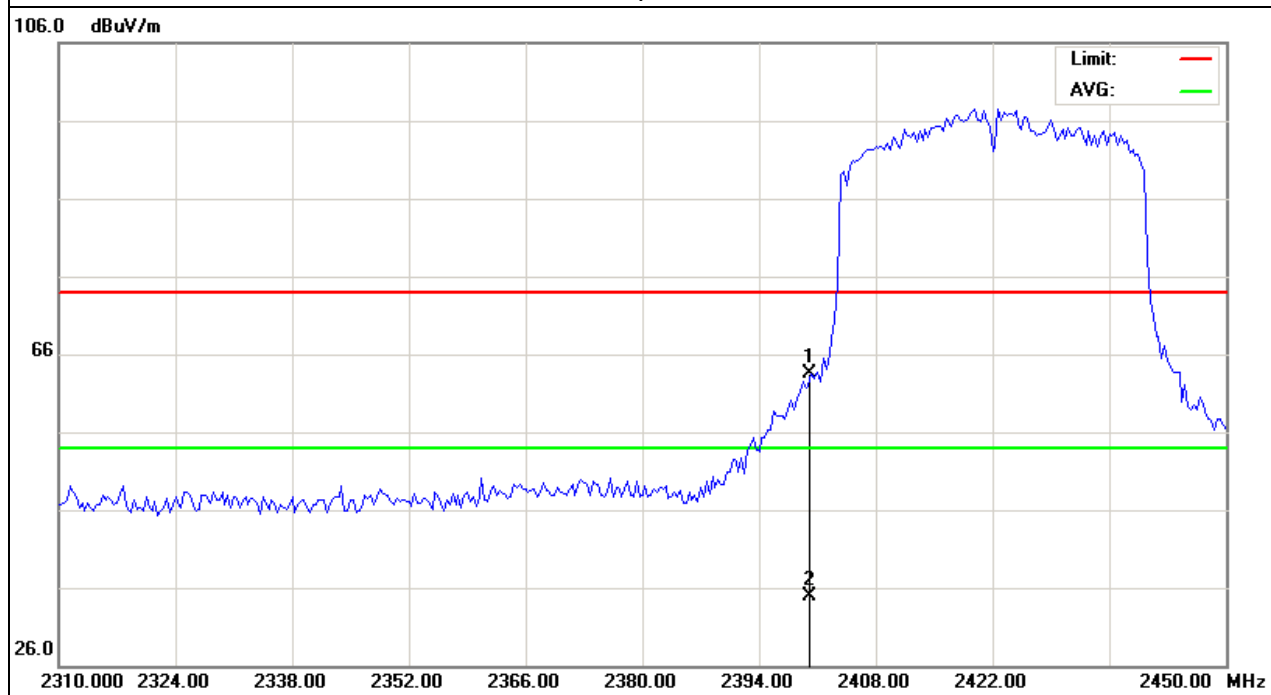

4. POWER SPECTRAL DENSITY TEST

4.1 APPLIED PROCEDURES / LIMIT

FCC Part15 (15.247) , Subpart C				
Section	Test Item	Limit	Frequency Range (MHz)	Result
15.247	Power Spectral Density	8 dBm (in any 3KHz)	2400-2483.5	PASS

4.1.1 TEST PROCEDURE

1. Set analyzer center frequency to DTS channel center frequency.
2. Set the span to 1.5 times the DTS channel bandwidth.
3. Set the RBW \geq 3 kHz.
4. Set the VBW \geq 3 x RBW.
5. Detector = peak.
6. Sweep time = auto couple.
7. Trace mode = max hold.
8. Allow trace to fully stabilize.
9. Use the peak marker function to determine the maximum amplitude level.
10. If measured value exceeds limit, reduce RBW (no less than 3 kHz) and repeat.

4.1.2 DEVIATION FROM STANDARD

No deviation.

4.1.3 TEST SETUP

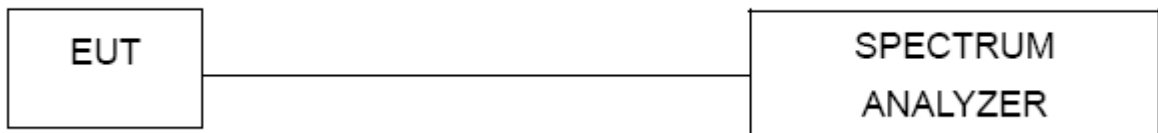

4.1.4 EUT OPERATION CONDITIONS

The EUT tested system was configured as the statements of 2.1 Unless otherwise a special operating condition is specified in the follows during the testing.

4.1.5 TEST RESULTS

EUT :	IP Camera	Model Name :	SWO-SVC01K
Temperature :	25 °C	Relative Humidity :	60%
Pressure :	1015 hPa	Test Voltage :	DC 5V from adapter AC 120V/60Hz
Test Mode :	TX b Mode /CH01, CH06, CH11		

Frequency	Power Density (dBm)	Limit (dBm)	Result
2412 MHz	-6.56	8	PASS
2437 MHz	-4.64	8	PASS
2462 MHz	-4.16	8	PASS

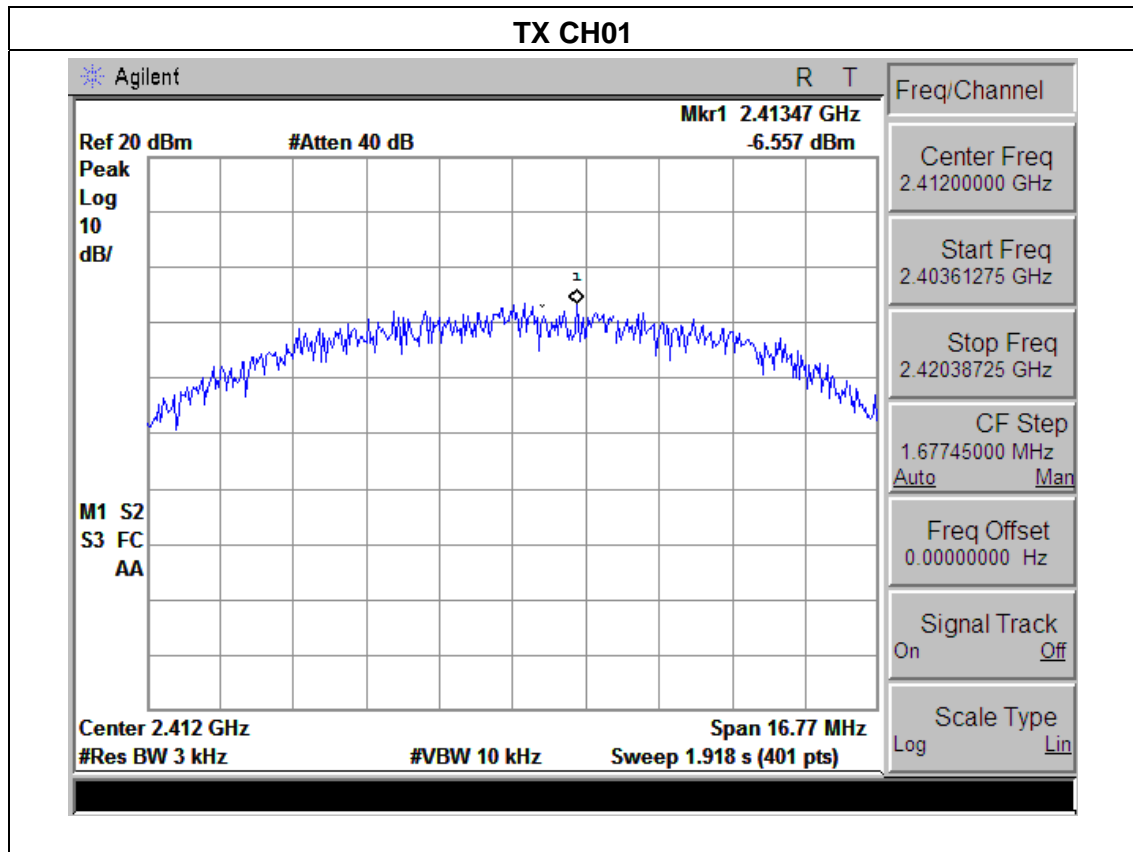

TX CH06

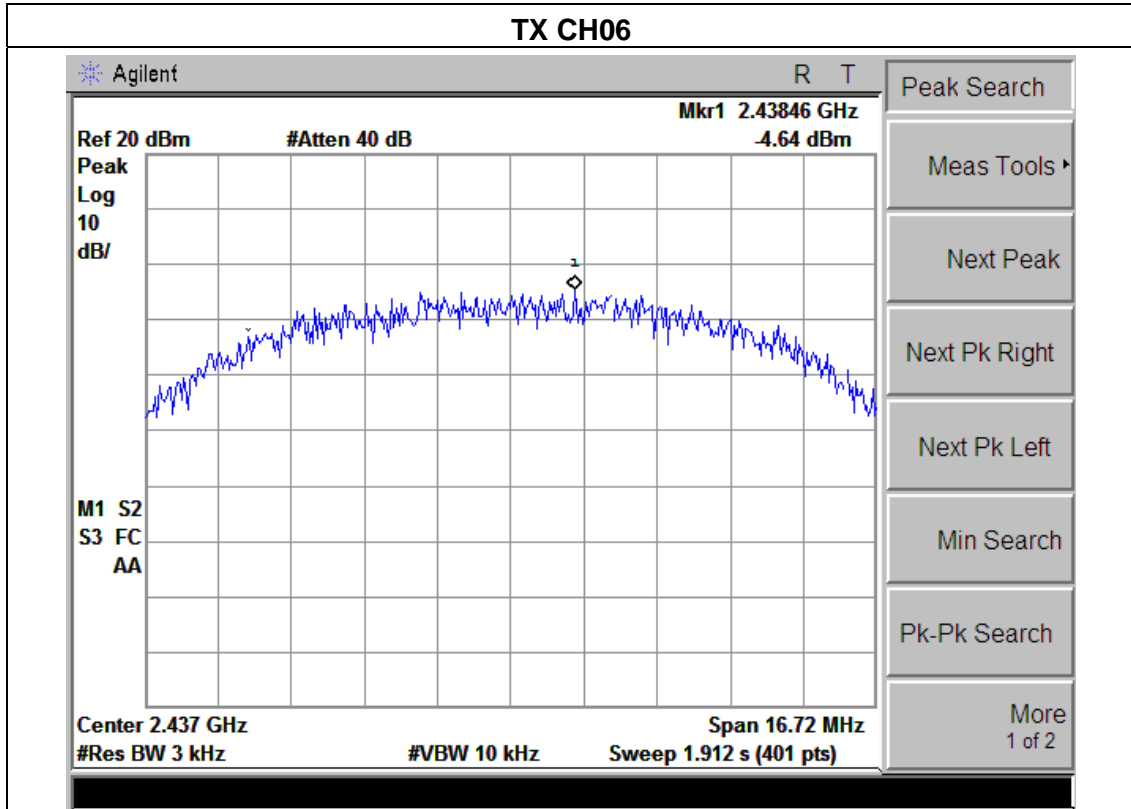

TX CH11

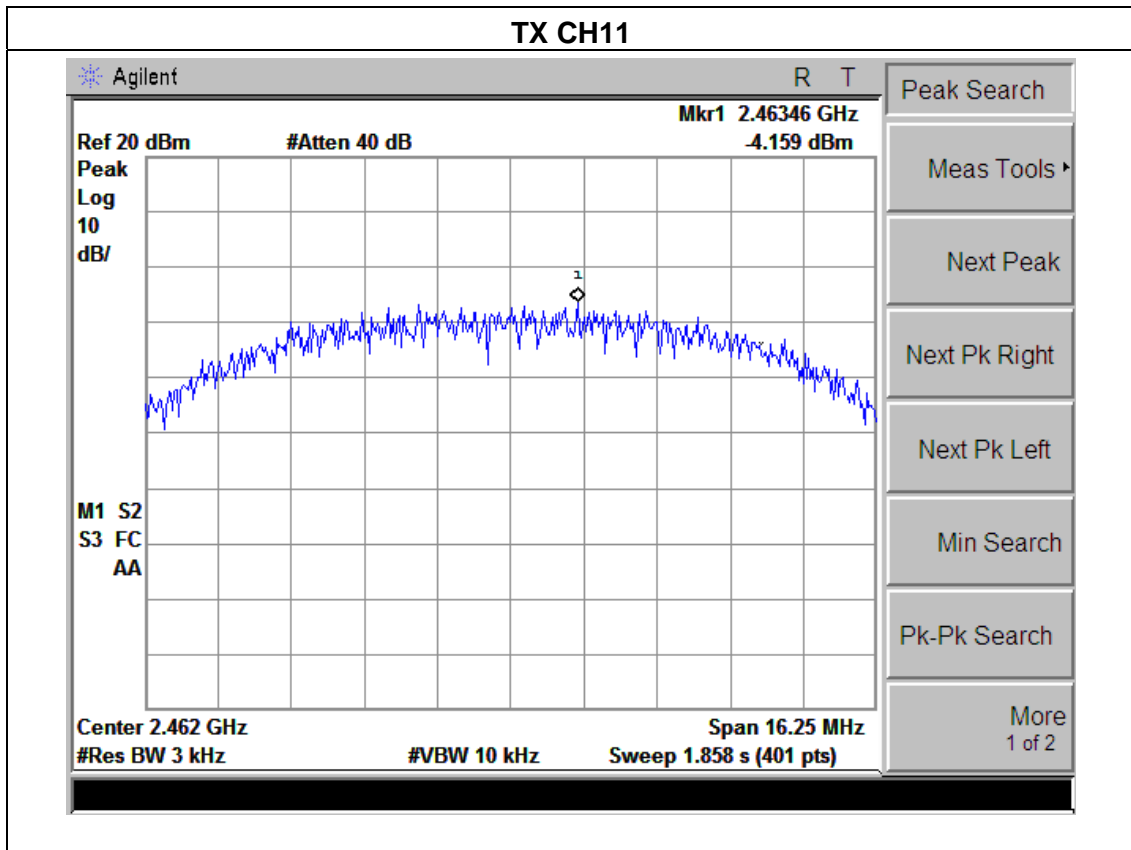

EUT :	IP Camera	Model Name :	SWO-SVC01K
Temperature :	25 °C	Relative Humidity :	60%
Pressure :	1015 hPa	Test Voltage :	DC 5V from adapter AC 120V/60Hz
Test Mode :	TX g Mode /CH01, CH06, CH11		

Frequency	Power Density (dBm)	Limit (dBm)	Result
2412 MHz	-9.56	8	PASS
2437 MHz	-12.65	8	PASS
2462 MHz	-11.76	8	PASS

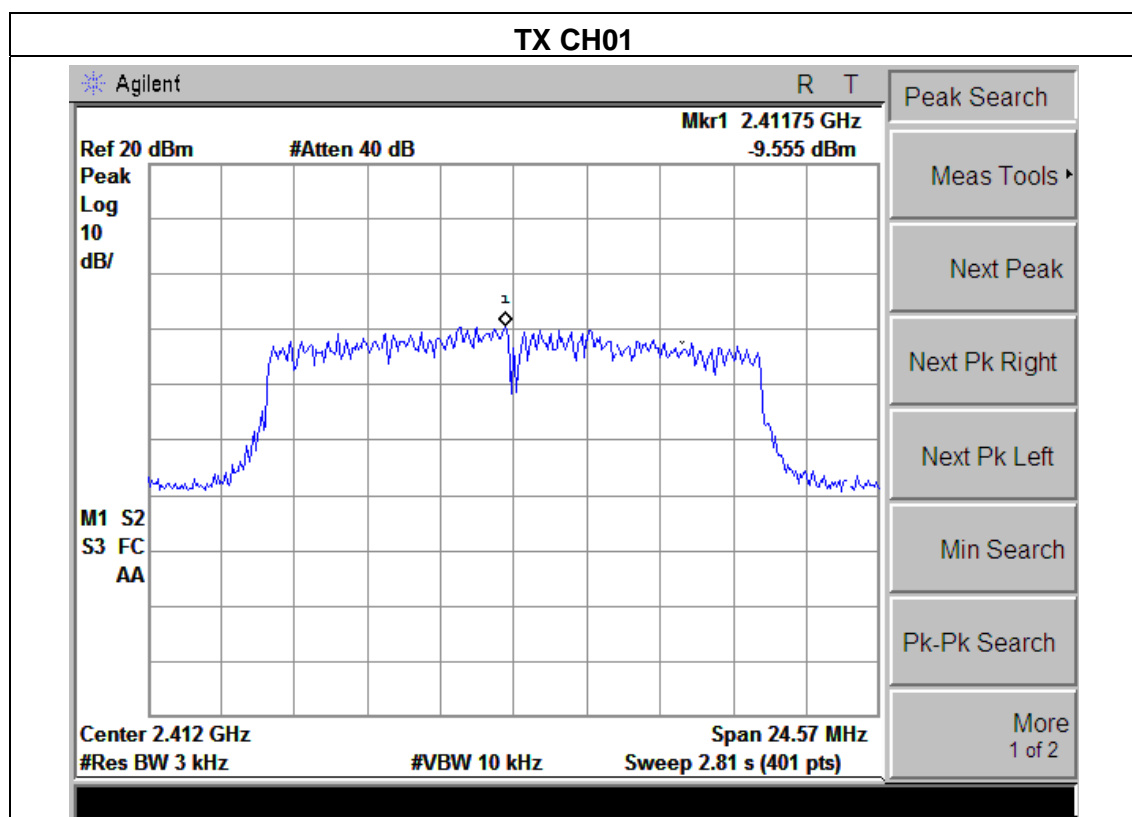

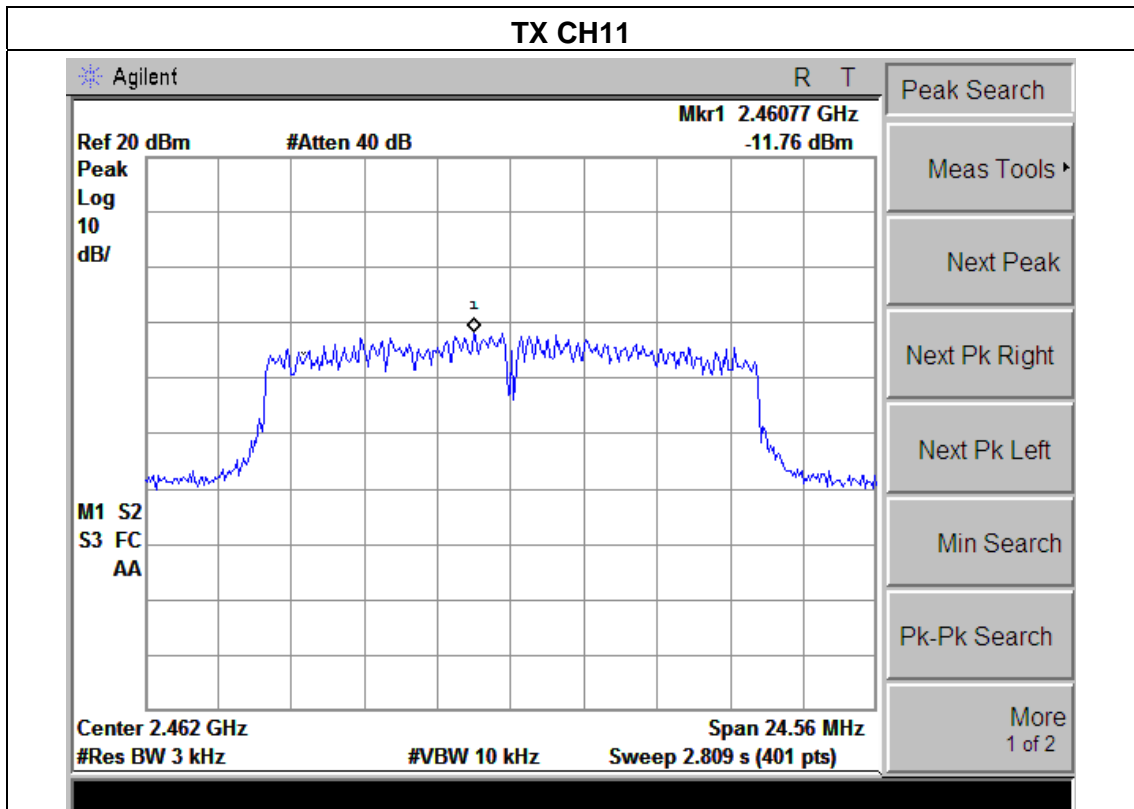
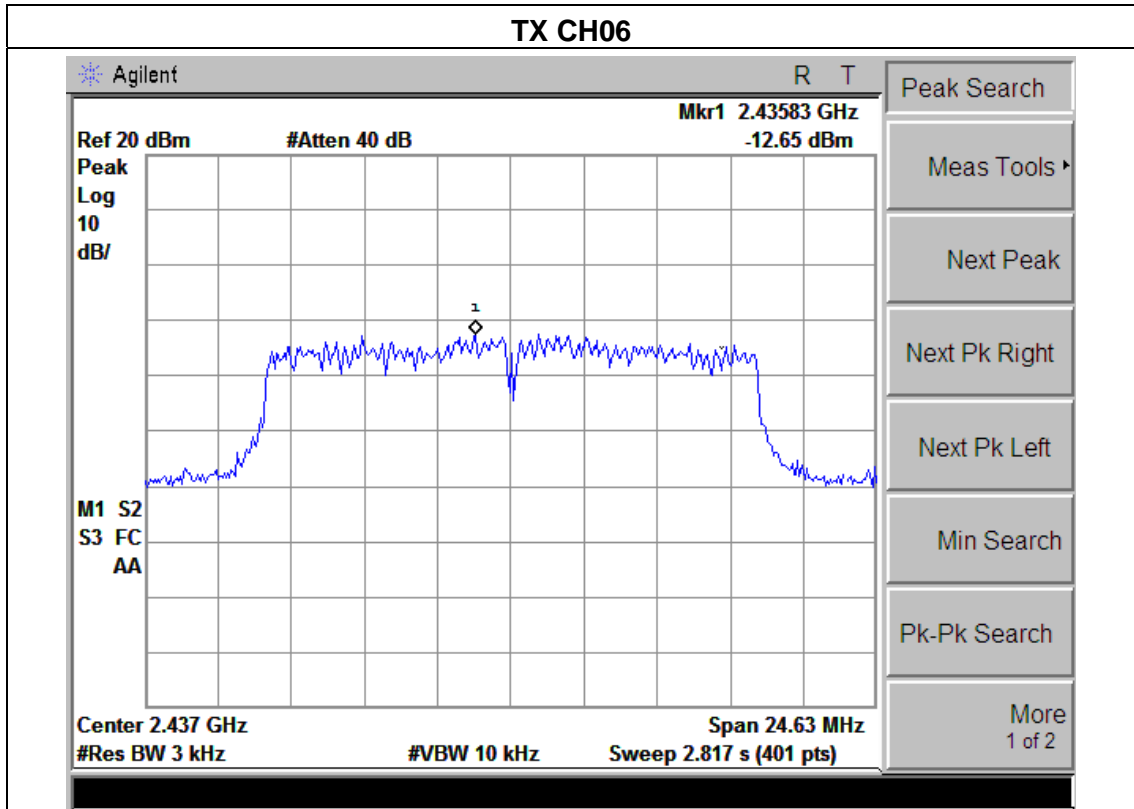

EUT :	IP Camera	Model Name :	SWO-SVC01K
Temperature :	25 °C	Relative Humidity :	60%
Pressure :	1015 hPa	Test Voltage :	DC 5V from adapter AC 120V/60Hz
Test Mode :	TX n(20) Mode /CH01, CH06, CH11		

Frequency	Power Density (dBm)	Limit (dBm)	Result
2412 MHz	-14.47	8	PASS
2437 MHz	-13.24	8	PASS
2462 MHz	-12.64	8	PASS

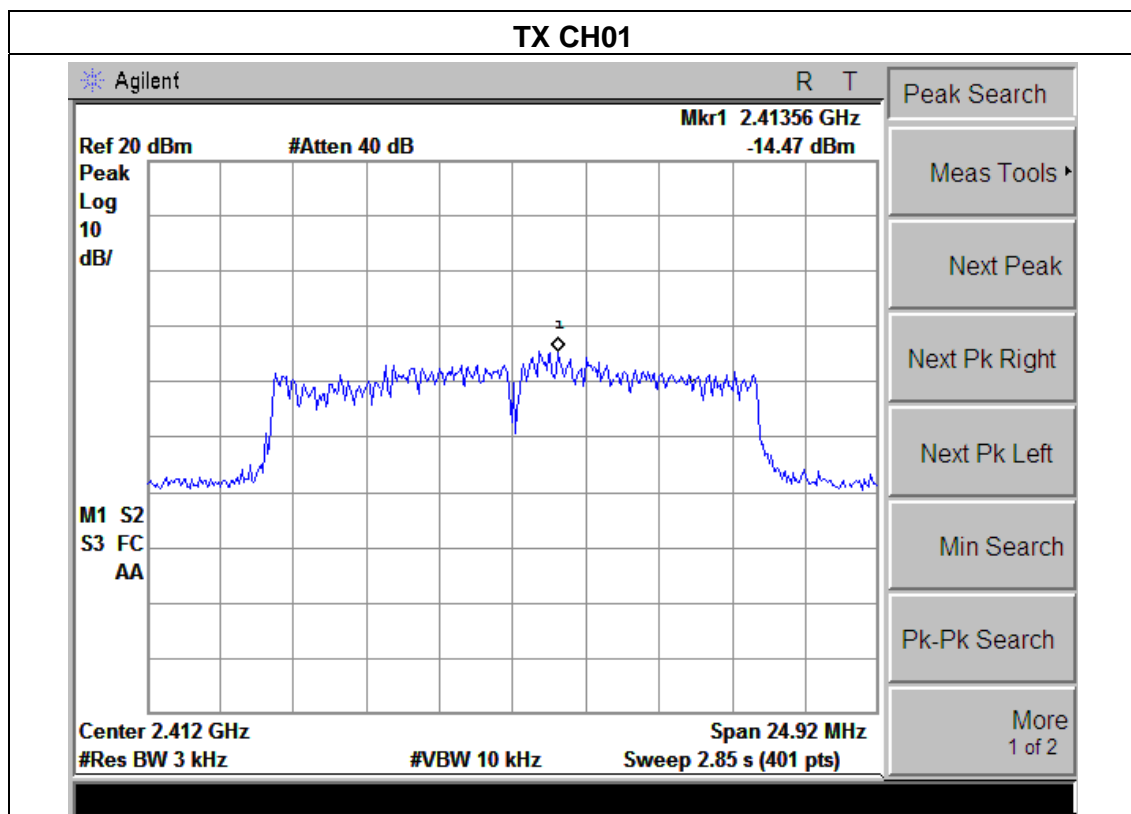

TX CH06

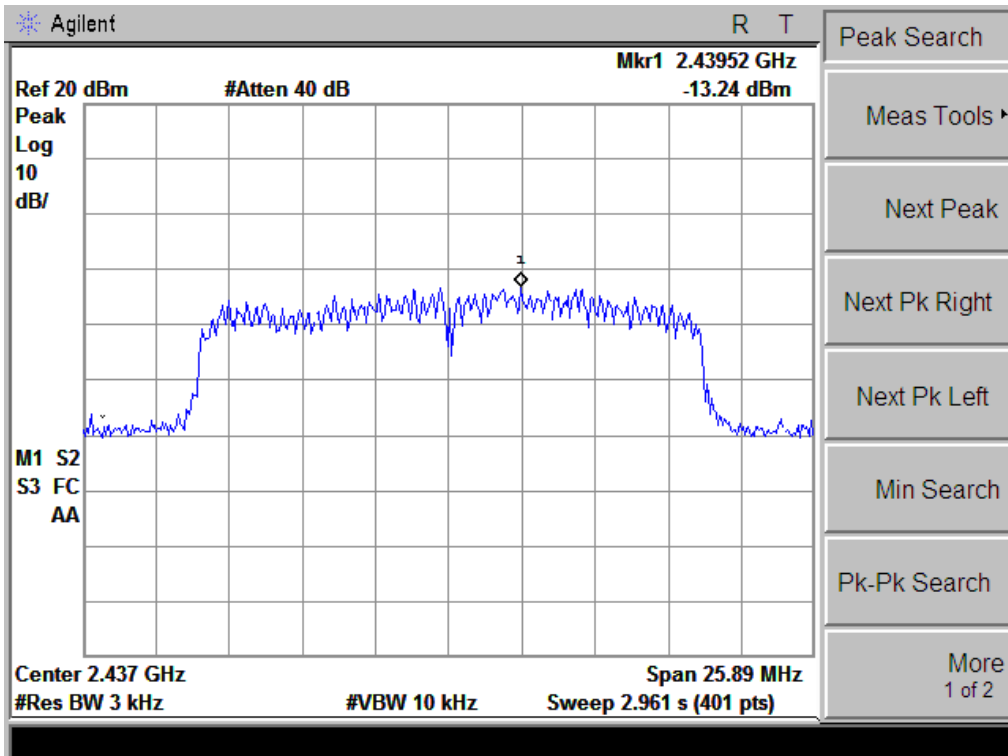

TX CH11

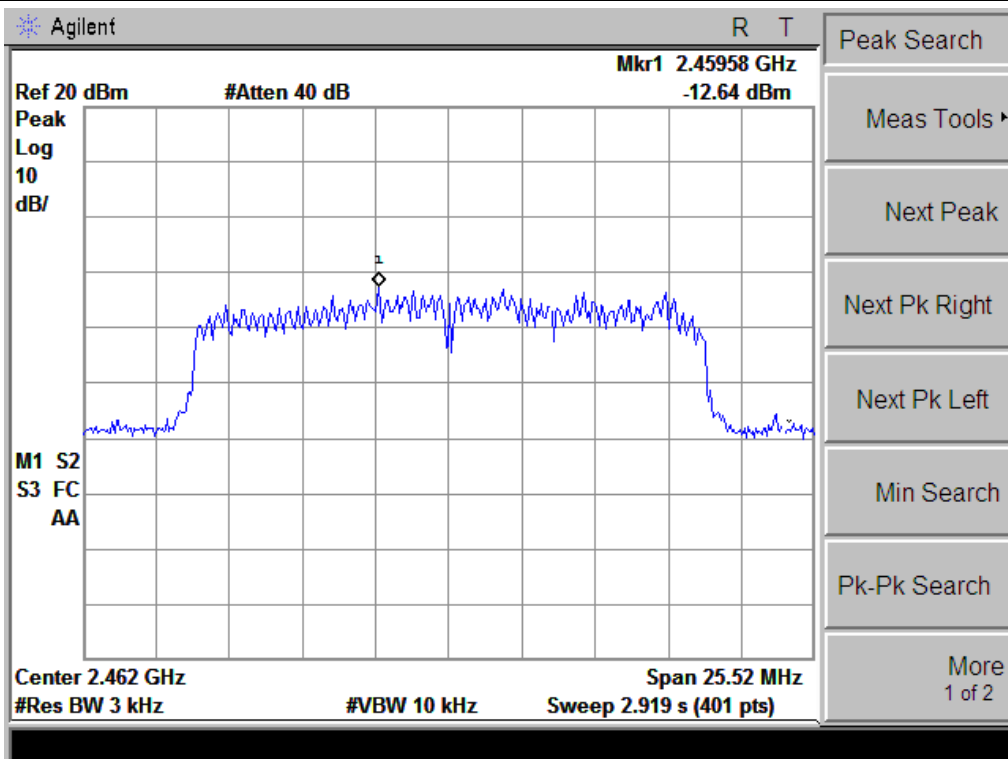

EUT :	IP Camera	Model Name :	SWO-SVC01K
Temperature :	25 °C	Relative Humidity :	60%
Pressure :	1015 hPa	Test Voltage :	DC 5Vfrom adapter AC 120V/60Hz
Test Mode :	TX n(40) Mode /CH03, CH06, CH09		

Frequency	Power Density (dBm)	Limit (dBm)	Result
2422 MHz	-15.49	8	PASS
2437 MHz	-15.43	8	PASS
2452 MHz	-15.06	8	PASS

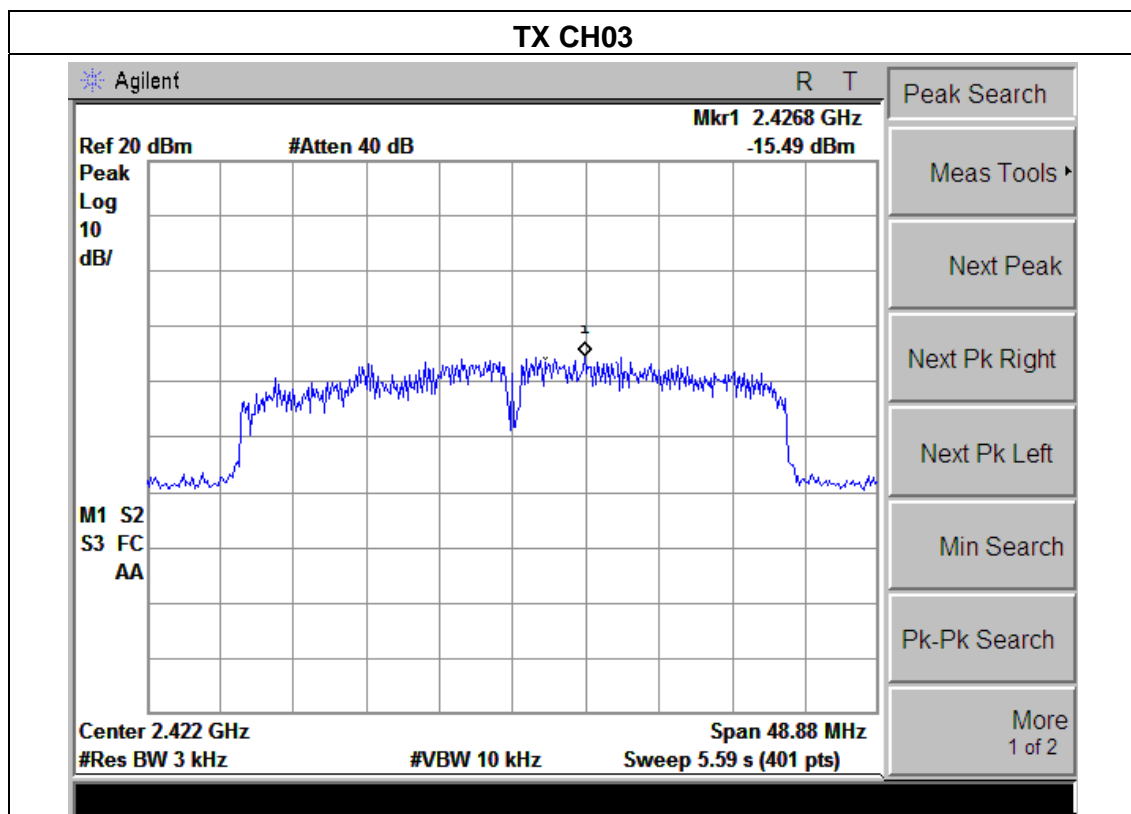

TX CH06

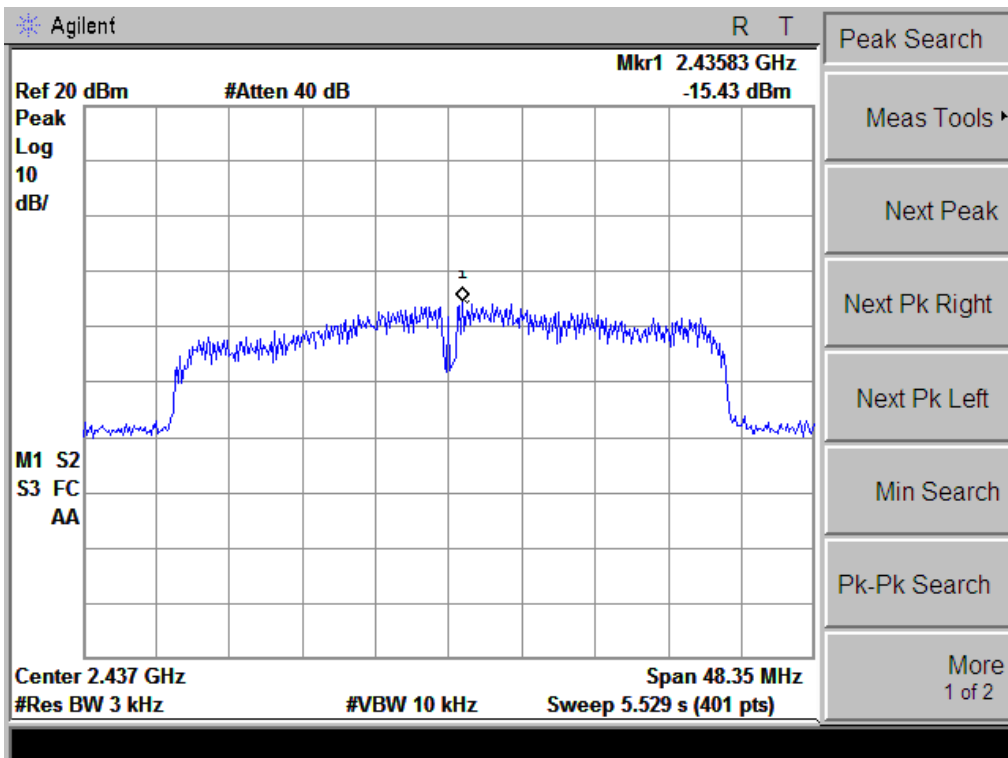

TX CH09

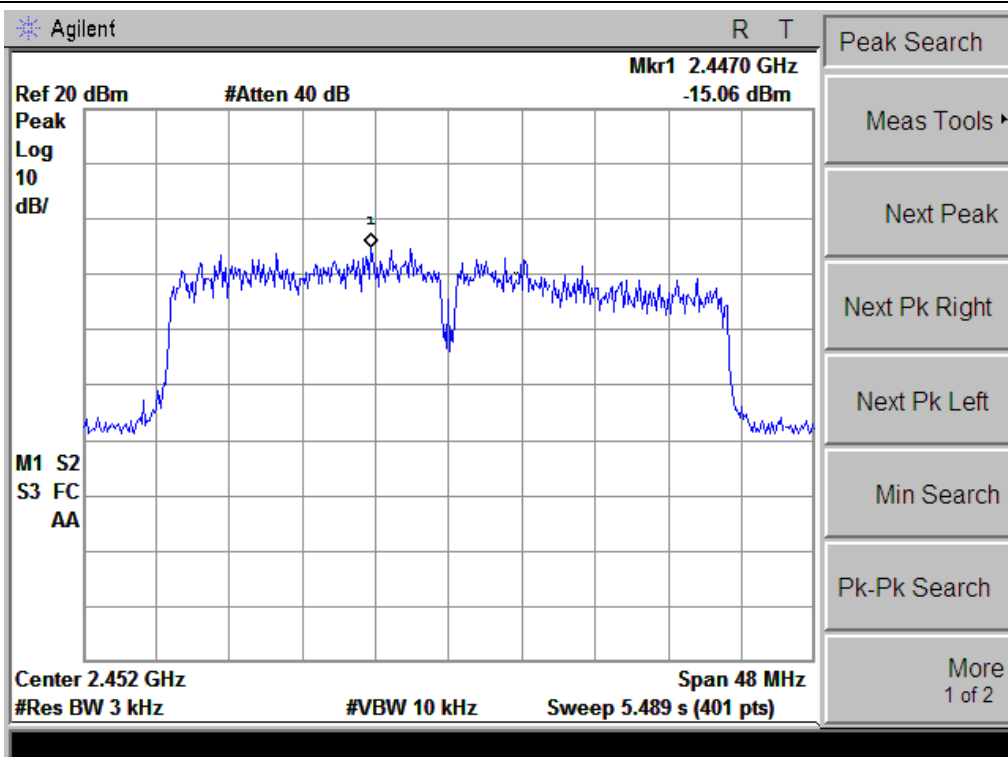

5. BANDWIDTH TEST

5.1 APPLIED PROCEDURES / LIMIT

FCC Part15 (15.247) , Subpart C				
Section	Test Item	Limit	Frequency Range (MHz)	Result
15.247(a)(2)	Bandwidth	$\geq 500\text{KHz}$ (6dB bandwidth)	2400-2483.5	PASS

5.1.1 TEST PROCEDURE

1. Set RBW= 100 kHz.
2. Set the video bandwidth (VBW) $\geq 3 \times$ RBW.
3. Detector = Peak.
4. Trace mode = max hold.
5. Sweep = auto couple.
6. Allow the trace to stabilize.
7. Measure the maximum width of the emission that is constrained by the frequencies associated with the two outermost amplitude points (upper and lower) that are attenuated by 6 dB relative to the maximum level measured in the fundamental emission.

5.1.2 DEVIATION FROM STANDARD

No deviation.

5.1.3 TEST SETUP



5.1.4 EUT OPERATION CONDITIONS

The EUT tested system was configured as the statements of 2.4 Unless otherwise a special operating condition is specified in the follows during the testing.

5.1.5 TEST RESULTS

EUT :	IP Camera	Model Name :	SWO-SVC01K
Temperature :	25 °C	Relative Humidity :	60%
Pressure :	1012 hPa	Test Voltage :	DC 5Vfrom adapter AC 120V/60Hz
Test Mode :	TX b Mode /CH01, CH06, CH11		

Frequency	6dB Bandwidth (MHz)	Channel Separation (MHz)	Result
2412 MHz	11.18	>=500KHz	PASS
2437 MHz	11.15	>=500KHz	PASS
2462 MHz	11.20	>=500KHz	PASS

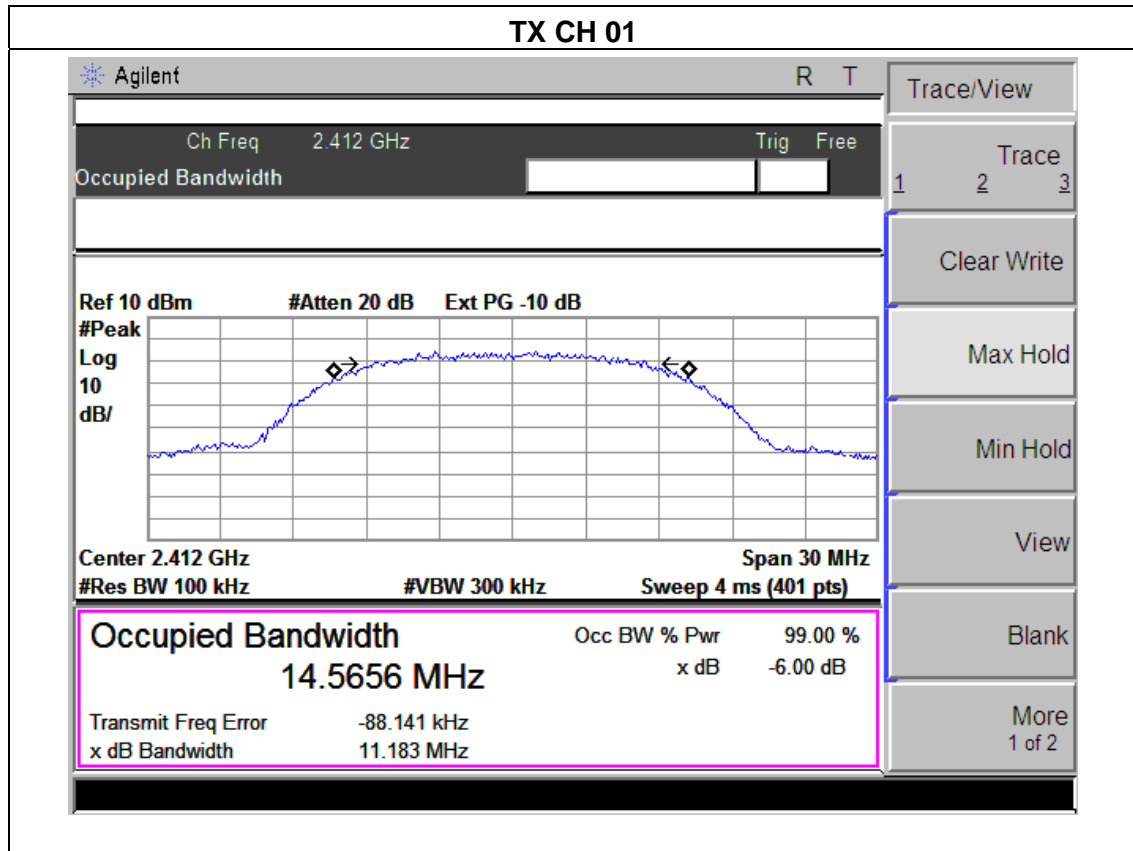

TX CH 06

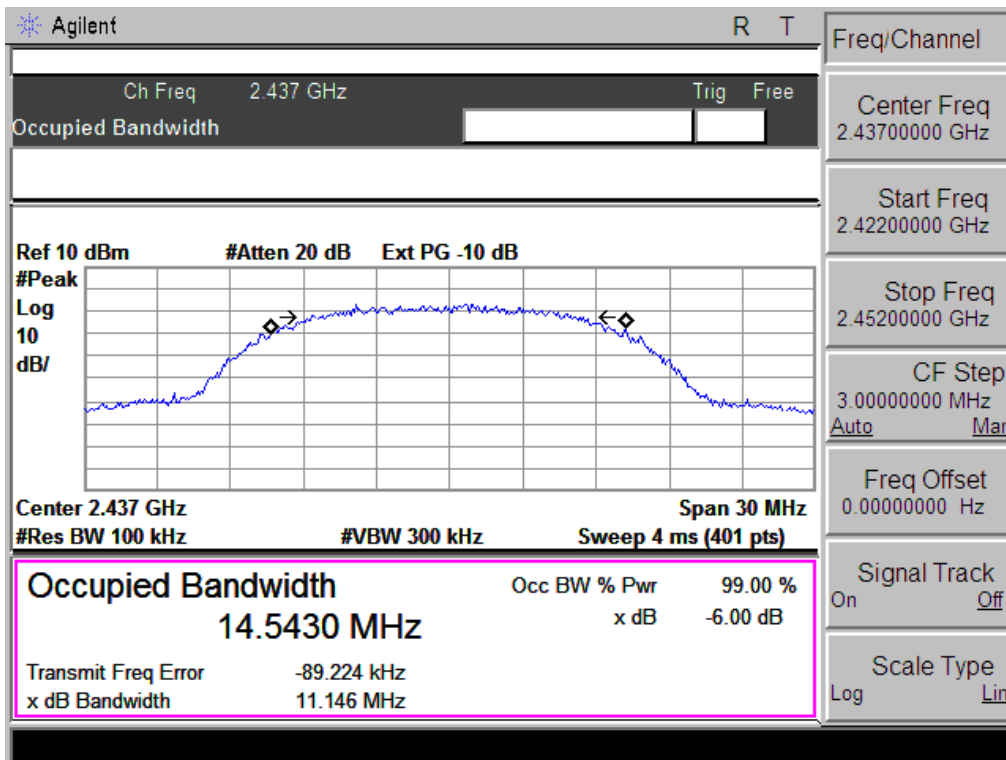

TX CH 11

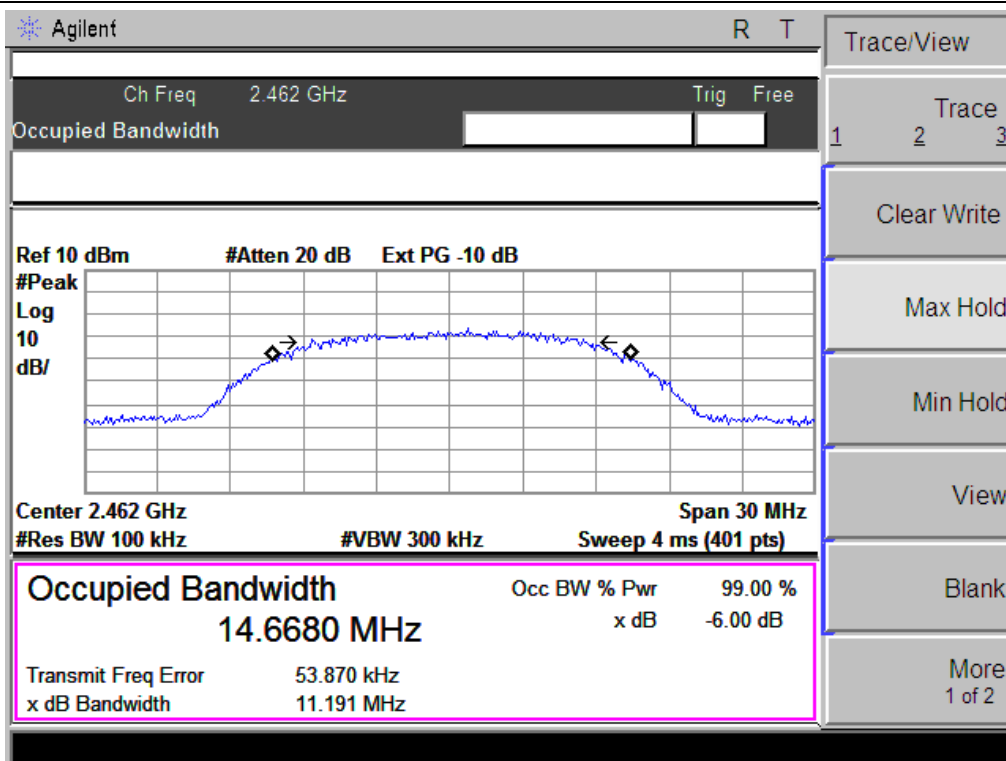

EUT :	IP Camera	Model Name :	SWO-SVC01K
Temperature :	25 °C	Relative Humidity :	60%
Pressure :	1012 hPa	Test Voltage :	DC 5Vfrom adapter AC 120V/60Hz
Test Mode :	TX g Mode /CH01, CH06, CH11		

Frequency	6dB Bandwidth (MHz)	Channel Separation (MHz)	Result
2412 MHz	16.48	>=500KHz	PASS
2437 MHz	16.42	>=500KHz	PASS
2462 MHz	16.37	>=500KHz	PASS

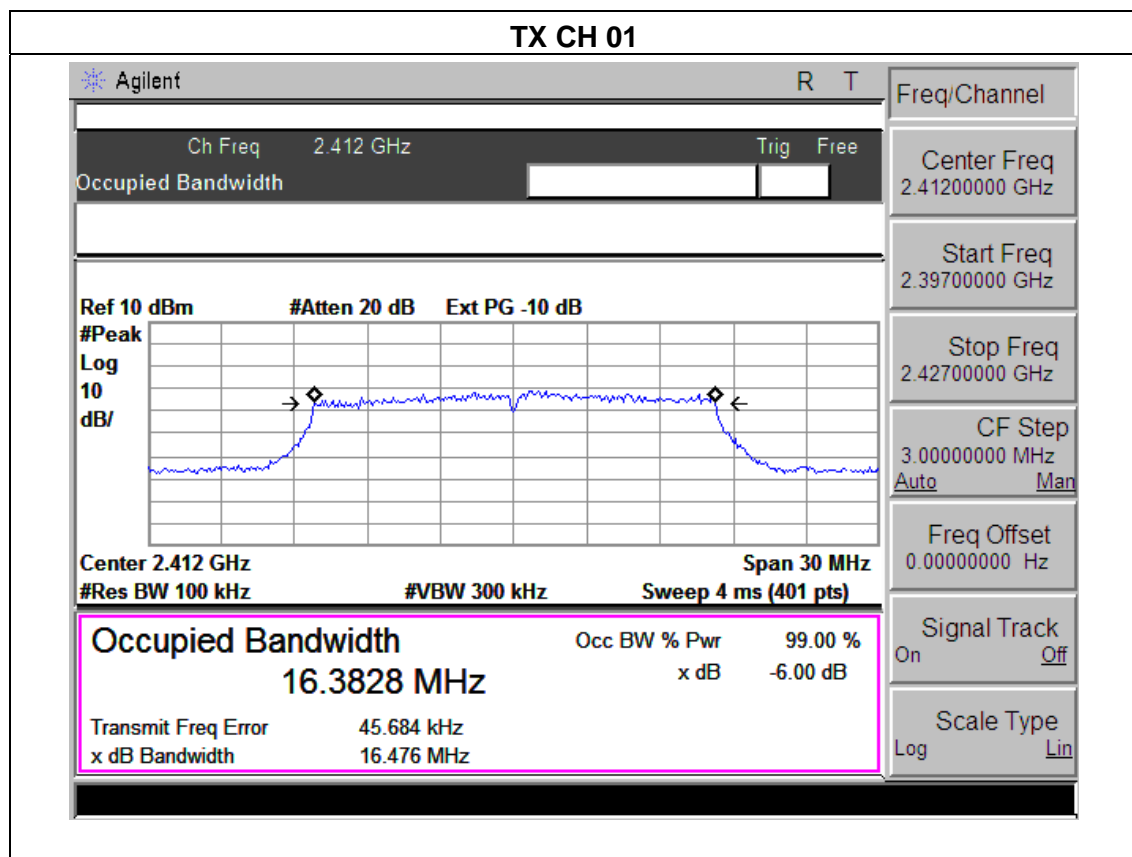

TX CH 06

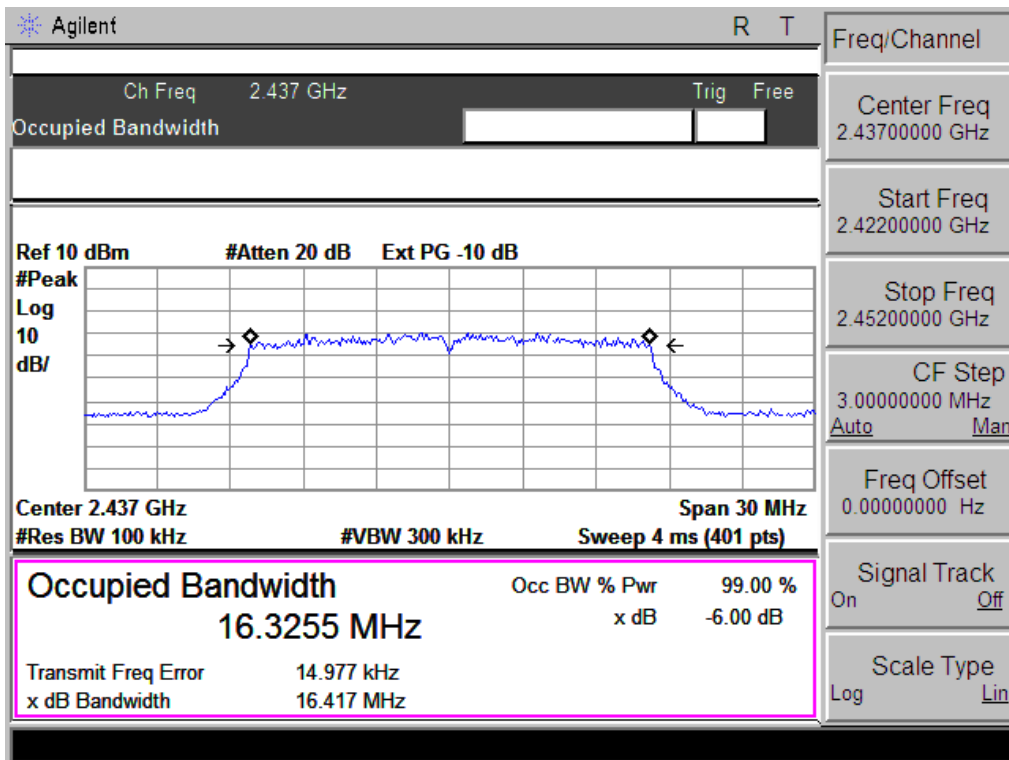

TX CH 11

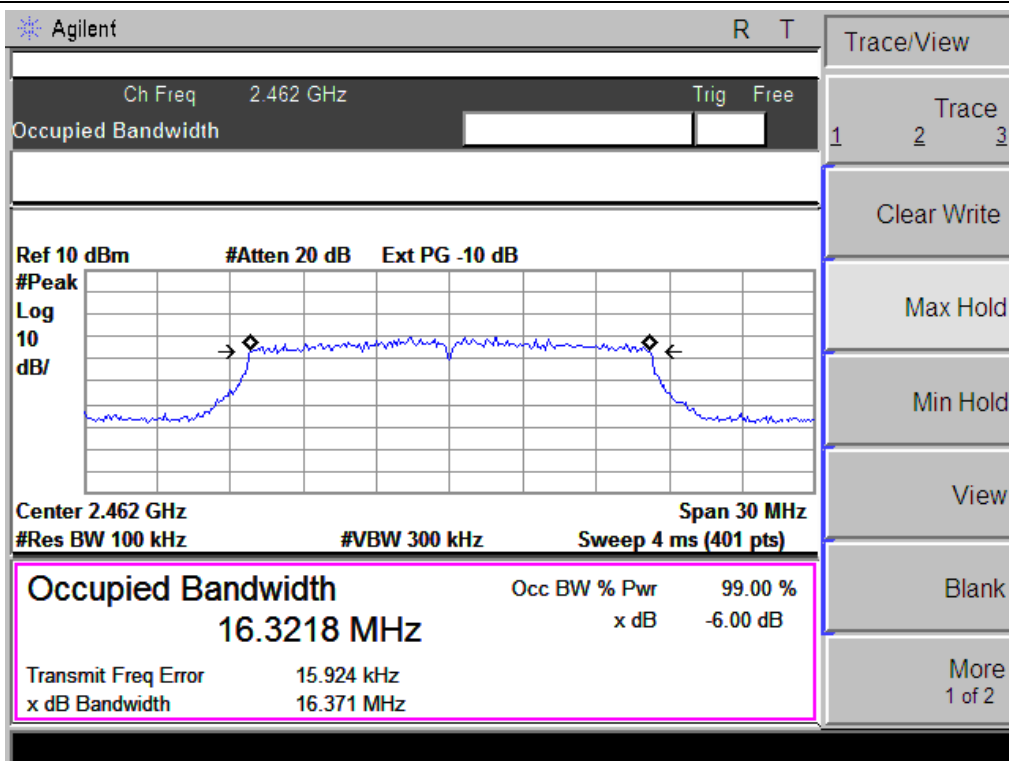

EUT :	IP Camera	Model Name :	SWO-SVC01K
Temperature :	25 °C	Relative Humidity :	60%
Pressure :	1012 hPa	Test Voltage :	DC 5Vfrom adapter AC 120V/60Hz
Test Mode :	TX n(20) Mode /CH01, CH06, CH11		

Frequency	6dB Bandwidth (MHz)	Channel Separation (MHz)	Result
2412 MHz	17.03	>=500KHz	PASS
2437 MHz	17.26	>=500KHz	PASS
2462 MHz	17.01	>=500KHz	PASS

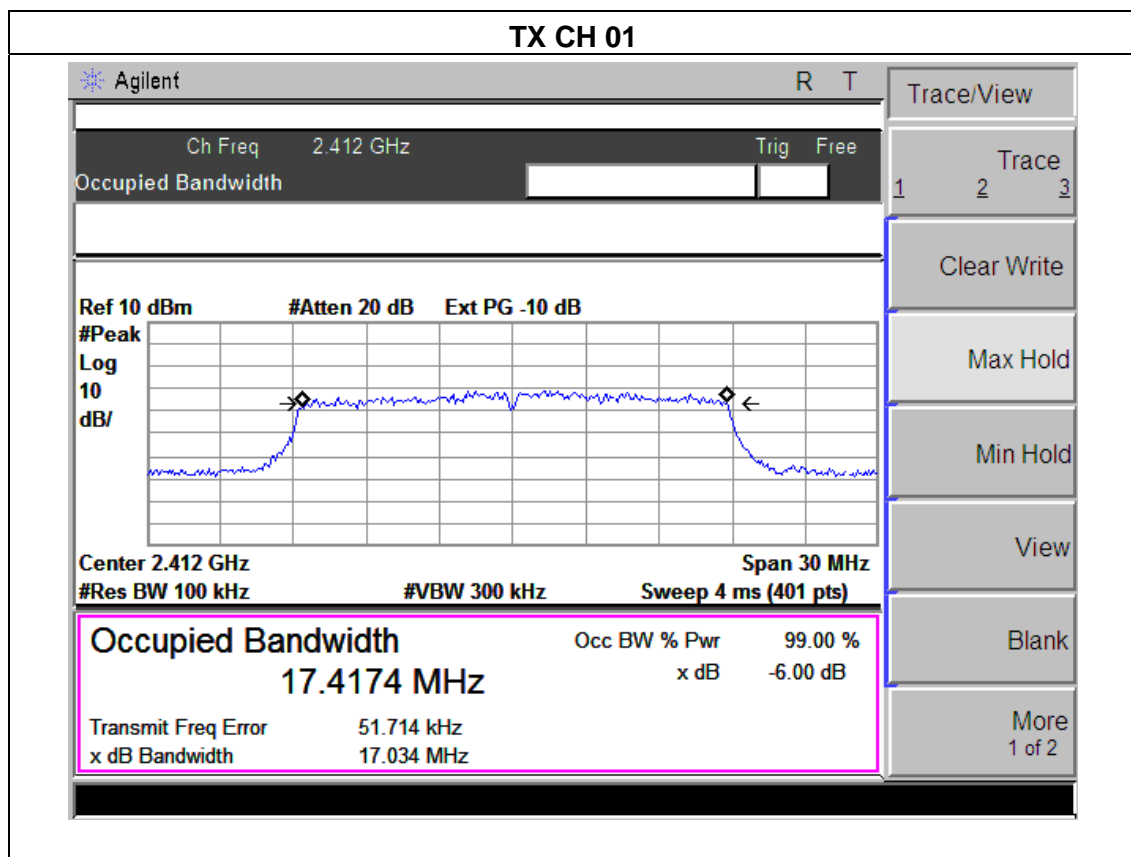

TX CH 06

Agilent
R T

Ch Freq 2.437 GHz
Trig Free

Occupied Bandwidth

Ref 10 dBm
#Atten 20 dB
Ext PG -10 dB

#Peak
Log
10
dB/

Center 2.437 GHz

#Res BW 100 kHz

#VBW 300 kHz

Sweep 4 ms (401 pts)

Span 30 MHz

Occupied Bandwidth	Occ BW % Pwr	99.00 %
17.4357 MHz	x dB	-6.00 dB
Transmit Freq Error	15.469 Hz	
x dB Bandwidth	17.258 MHz	

Freq/Channel

Center Freq
2.43700000 GHz

Start Freq
2.42200000 GHz

Stop Freq
2.45200000 GHz

CF Step
3.00000000 MHz
Auto Man

Freq Offset
0.00000000 Hz

Signal Track
On Off

Scale Type
Log Lin

TX CH 11

Agilent
R T

Ch Freq 2.462 GHz
Trig Free

Occupied Bandwidth

Ref 10 dBm
#Atten 20 dB
Ext PG -10 dB

#Peak
Log
10
dB/

Center 2.462 GHz

#Res BW 100 kHz

#VBW 300 kHz

Sweep 4 ms (401 pts)

Span 30 MHz

Occupied Bandwidth	Occ BW % Pwr	99.00 %
17.3991 MHz	x dB	-6.00 dB
Transmit Freq Error	3.501 kHz	
x dB Bandwidth	17.012 MHz	

Freq/Channel

Center Freq
2.46200000 GHz

Start Freq
2.44700000 GHz

Stop Freq
2.47700000 GHz

CF Step
3.00000000 MHz
Auto Man

Freq Offset
0.00000000 Hz

Signal Track
On Off

Scale Type
Log Lin

EUT :	IP Camera	Model Name :	SWO-SVC01K
Temperature :	25 °C	Relative Humidity :	60%
Pressure :	1012 hPa	Test Voltage :	DC 5Vfrom adapter AC 120V/60Hz
Test Mode :	TX n(40) Mode /CH03, CH06, CH09		

Frequency	6dB Bandwidth (MHz)	Channel Separation (MHz)	Result
2422 MHz	32.57	>=500KHz	PASS
2437 MHz	32.81	>=500KHz	PASS
2452 MHz	32.57	>=500KHz	PASS

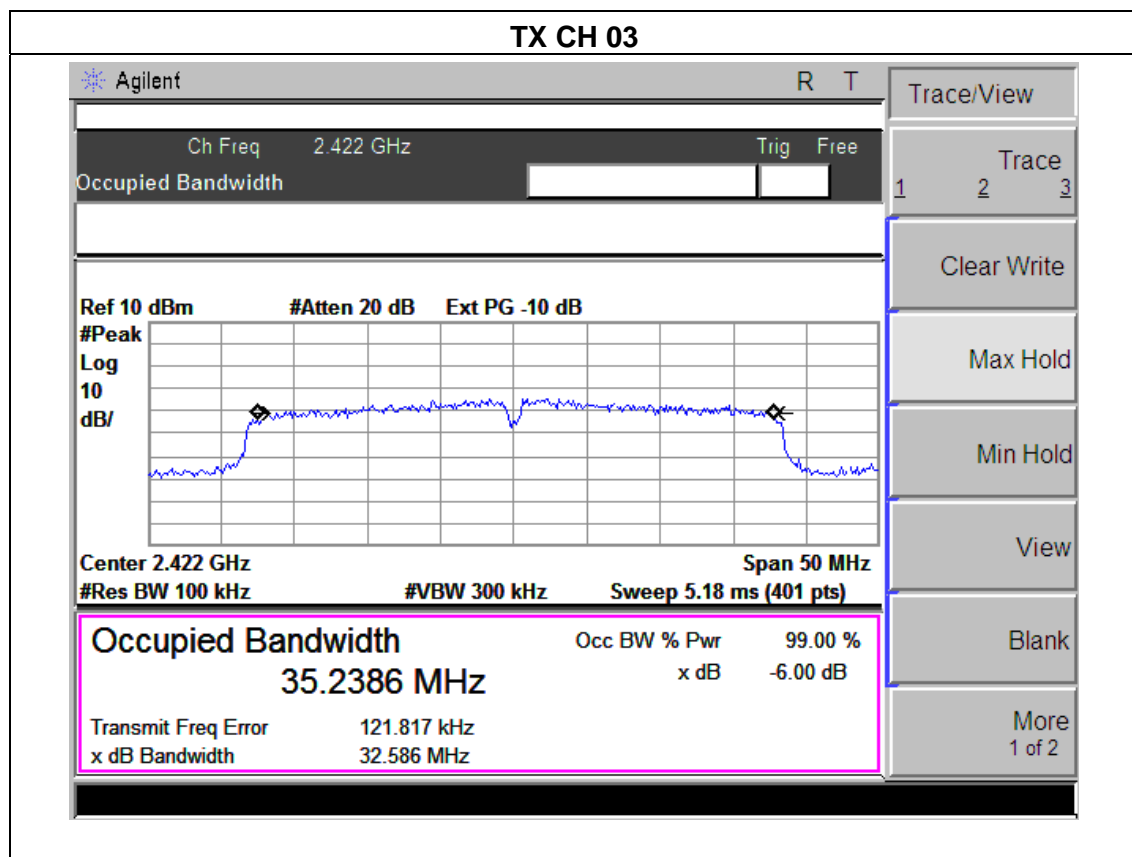

TX CH 06

Agilent
R T

Ch Freq 2.437 GHz
Trig Free

Occupied Bandwidth

Ref 10 dBm
#Atten 20 dB
Ext PG -10 dB

#Peak
Log
10
dB/

Center 2.437 GHz Span 50 MHz

#Res BW 100 kHz #VBW 300 kHz Sweep 5.18 ms (401 pts)

Occupied Bandwidth

35.1691 MHz

Transmit Freq Error	58.519 kHz
x dB Bandwidth	32.813 MHz

Trace/View

Trace 1 2 3

Clear Write

Max Hold

Min Hold

View

Blank

More 1 of 2

TX CH 09

Agilent
R T

Ch Freq 2.452 GHz
Trig Free

Occupied Bandwidth

Ref 10 dBm
#Atten 20 dB
Ext PG -10 dB

#Peak
Log
10
dB/

Center 2.452 GHz Span 50 MHz

#Res BW 100 kHz #VBW 300 kHz Sweep 5.18 ms (401 pts)

Occupied Bandwidth

35.3179 MHz

Transmit Freq Error	-77.094 kHz
x dB Bandwidth	32.567 MHz

Freq/Channel

Center Freq 2.45200000 GHz

Start Freq 2.42700000 GHz

Stop Freq 2.47700000 GHz

CF Step 5.00000000 MHz
Auto Man

Freq Offset 0.00000000 Hz

Signal Track On Off

Scale Type Log Lin

6. PEAK OUTPUT POWER TEST

6.1 APPLIED PROCEDURES / LIMIT

FCC Part15 (15.247) , Subpart C				
Section	Test Item	Limit	Frequency Range (MHz)	Result
15.247(b)(3)	Peak Output Power	1 watt or 30dBm	2400-2483.5	PASS

6.1.1 TEST PROCEDURE

- a. The EUT was directly connected to the Power meter

6.1.2 DEVIATION FROM STANDARD

No deviation.

6.1.3 TEST SETUP



6.1.4 EUT OPERATION CONDITIONS

The EUT tested system was configured as the statements of 2.4 Unless otherwise a special operating condition is specified in the follows during the testing.

6.1.5 TEST RESULTS

EUT :	IP Camera	Model Name :	SWO-SVC01K
Temperature :	25 °C	Relative Humidity :	60%
Pressure :	1012 hPa	Test Voltage :	DC 5Vfrom adapter AC 120V/60Hz
Test Mode :	TX b/g/n Mode /CH01, CH06, CH11		

TX 802.11b Mode			
Test Channe	Frequency	Maximum Peak Conducted Output Power	LIMIT
	(MHz)	(dBm)	dBm
CH01	2412	12.01	30
CH06	2437	12.23	30
CH11	2462	12.33	30
TX 802.11g Mode			
CH01	2412	11.23	30
CH06	2437	11.46	30
CH11	2462	11.67	30
TX 802.11n(20) Mode			
CH01	2412	11.17	30
CH06	2437	11.85	30
CH11	2462	11.37	30
TX 802.11n(40) Mode			
CH03	2422	10.54	30
CH06	2437	10.32	30
CH09	2452	10.52	30

7. ANTENNA REQUIREMENT

7.1 STANDARD REQUIREMENT

15.203 requirement: For intentional device, according to 15.203: an intentional radiator shall be designed to ensure that no antenna other than that furnished by the responsible party shall be used with the device.

7.2 EUT ANTENNA

The EUT antenna is Integrated antenna. It comply with the standard requirement.

8. EUT TEST PHOTO

Radiated Measurement Photos

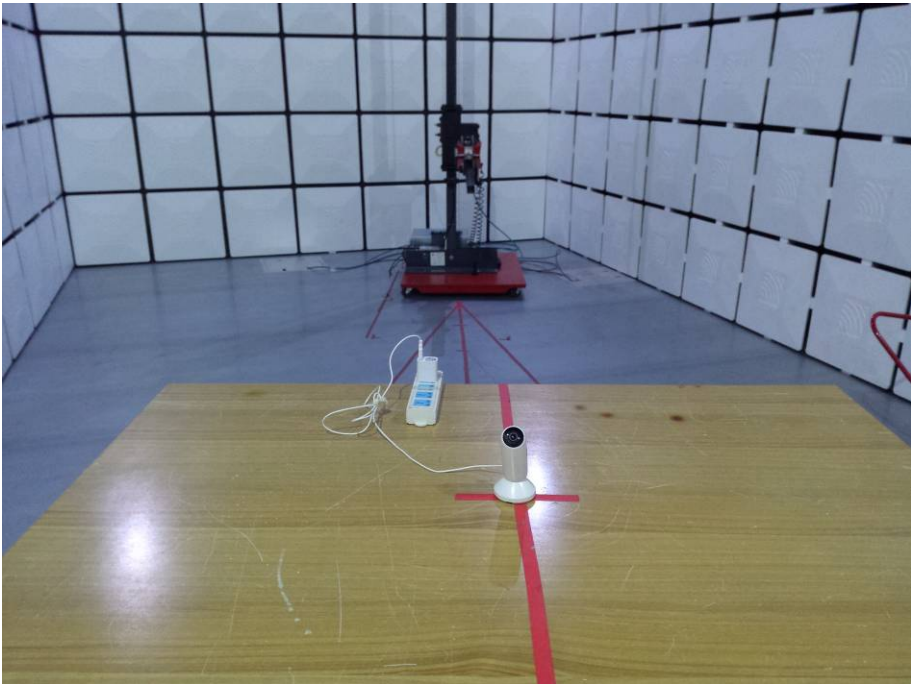
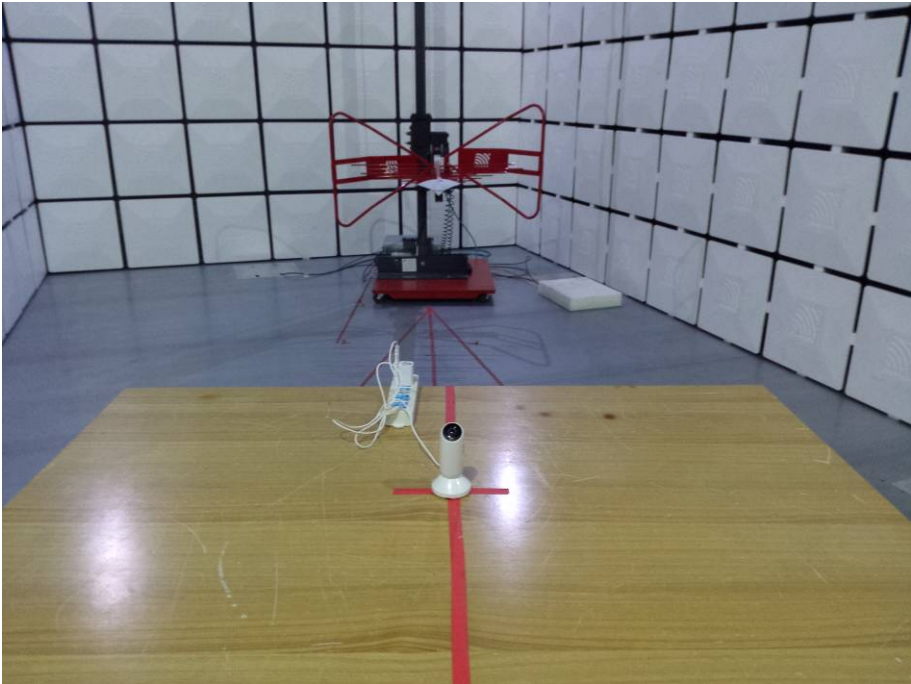

Conducted Measurement Photo

