

RF Test Report

Applicant : Swann Communications Pty Ltd
Product Type : Swann Wire-Free Video Doorbell
Trade Name : Swann
Model Number : SWIFI-DOORBELL
Applicable Standard : FCC 47 CFR PART 15 SUBPART C
ANSI C63.10:2013
Receive Date : May 24, 2019
Test Period : Jun. 10 ~ Jul. 04, 2019
Issue Date : Jul. 17, 2019

Issue by

A Test Lab Techno Corp.
No. 140-1, Changan Street, Bade District,
Taoyuan City 33465, Taiwan (R.O.C.)
Tel : +886-3-2710188 / Fax : +886-3-2710190



Taiwan Accreditation Foundation accreditation number: 1330

Test Firm MRA designation number: TW0010

Note:

- 1.The test results are valid only for samples provided by customers and under the test conditions described in this report.
- 2.This report shall not be reproduced except in full, without the written approval of A Test Lab Technology Corporation.
- 3.The relevant information is provided by customers in this test report. According to the correctness, appropriateness or completeness of the information provided by the customer, if there is any doubt or error in the information which affects the validity of the test results, the laboratory does not take the responsibility.



Revision History

Rev.	Issue Date	Revisions	Revised By
00	Jul. 17, 2019	Initial Issue	Tobey Cheng

Verification of Compliance

Issued Date: Jul. 17, 2019

Applicant : Swann Communications Pty Ltd
Product Type : Swann Wire-Free Video Doorbell
Trade Name : Swann
Model Number : SWIFI-DOORBELL
FCC ID : VMISWIFIDOOBELL
EUT Rated Voltage : DC 5 V, 2.1 A ; 12-24 Vac, 50/60 Hz, 0.5 A
Test Voltage : 12 Vac / 120 Vac, 60 Hz
Applicable Standard : FCC 47 CFR PART 15 SUBPART C
ANSI C63.10:2013
Test Result : Complied

Performing Lab. : A Test Lab Techno Corp.
No. 140-1, Changan Street, Bade District,
Taoyuan City 33465, Taiwan (R.O.C.)
Tel : +886-3-2710188 / Fax : +886-3-2710190



Taiwan Accreditation Foundation accreditation number: 1330
<http://www.atl-lab.com.tw/e-index.htm>

A Test Lab Techno Corp. tested the above equipment in accordance with the requirements set forth in the above standards. All indications of Pass/Fail in this report are opinions expressed by A Test Lab Techno Corp. based on interpretations and/or observations of test results. The test results show that the equipment tested is capable of demonstrating compliance with the requirements as documented in this report.

Approved By : Fly Lu Reviewed By : Eric Ou Yang
(Manager) (Fly Lu) (Testing Engineer) (Eric Ou Yang)



TABLE OF CONTENTS

1	General Information	5
1.1.	Summary of Test Result.....	5
1.2.	Measurement Uncertainty.....	6
2	EUT Description	7
3	Test Methodology	8
3.1.	Mode of Operation.....	8
3.2.	EUT Test Step	11
3.3.	Configuration of Test System Details	12
3.4.	Test Instruments	14
3.5.	Test Site Environment.....	15
4	Measurement Procedure	16
4.1.	AC Power Line Conducted Emission Measurement.....	16
4.2.	Radiated Emission Measurement.....	18
4.3.	Maximum Conducted Output Power Measurement.....	23
4.4.	6 dB RF Bandwidth Measurement	24
4.5.	Maximum Power Spectral Density Measurement.....	25
4.6.	Out of Band Conducted Emissions Measurement.....	26
4.7.	Antenna Measurement	27
5	Test Results.....	28
	Annex A. Conducted Emission	28
	Annex B. Conducted Test Results	32
	Annex C. Radiated Emission Test Results.....	55



1 General Information

1.1. Summary of Test Result

Standard	Item	Result	Remark
15.207	AC Power Conducted Emission	PASS	----
15.247(d)	Transmitter Radiated Emissions	PASS	----
15.247(b)(3)	Max. Output Power	PASS	----
15.247(a)(2)	6 dB RF Bandwidth	PASS	----
15.247(e)	Maximum Power Spectral Density	PASS	----
15.247(d)	Out of Band Conducted Spurious Emission	PASS	----
15.203	Antenna Requirement	PASS	----

Standard	Description
CFR47, Part 15, Subpart C	Intentional Radiators
ANSI C63. 10: 2013	American National Standard of Procedures for Compliance Testing of Unlicensed Wireless Devices
KDB 558074 D01 15.247 Meas Guidance v05r02	GUIDANCE FOR COMPLIANCE MEASUREMENTS ON DIGITAL TRANSMISSION SYSTEM, FREQUENCY HOPPING SPREAD SPECTRUM SYSTEM, AND HYBRID SYSTEM DEVICES OPERATING UNDER SECTION 15.247 OF THE FCC RULES



1.2. Measurement Uncertainty

Test Item	Frequency Range	Uncertainty (dB)
Conducted Emission	150 kHz ~ 30 MHz	2.8
Radiated Emission	9 kHz ~ 30 MHz	1.7
	30 MHz ~ 1000 MHz	5.7
	1000 MHz ~ 18000 MHz	5.6
	18000 MHz ~ 26500 MHz	4.9
	26500 MHz ~ 40000 MHz	4.8
Conducted Output Power	+0.27 dB / -0.28 dB	
RF Bandwidth	4.96 %	
Power Spectral Density	+0.71 dB / -0.77 dB	

Decision Rule

- Uncertainty is not included.
- Uncertainty is included.



2 EUT Description

Applicant	Swann Communications Pty Ltd Unit 5B 706 Lorimer Street, Port Melbourne 3207, Australia			
Manufacturer	Chicony Electronics (Dong Guan) Co.,Ltd. San Zhong Guan Li Qu, Qingxi Town, Dongguan City Guangdong 523651 China			
Product Type	Swann Wire-Free Video Doorbell			
Trade Name	Swann			
Model Number	SWIFI-DOORBELL			
FCC ID	VMISWIFIDOORBELL			
Operate Freq. Band	Frequency Range (MHz)	Modulation	Channel Bandwidth	Data Rate 400 / 800 GI (ns)
IEEE 802.11b	2412 ~ 2462	DSSS	20 MHz	Up to 11 Mbps
IEEE 802.11g	2412 ~ 2462	OFDM	20 MHz	Up to 54 Mbps
IEEE 802.11n 2.4 GHz 20 MHz	2412 ~ 2462	OFDM	20 MHz	Up to 72.2 Mbps
IEEE 802.11n 2.4 GHz 40 MHz	2422 ~ 2452	OFDM	40 MHz	Up to 150 Mbps
Antenna information	Type		Max. Gain (dBi)	
	PIFA Antenna		0.44	
Antenna Delivery	See section 3.1			
Operate Temp. Range	-20 ~ +50 °C			

Frequency Band	Max. RF Output Power (W)
IEEE 802.11b	0.098
IEEE 802.11g	0.078
IEEE 802.11n 2.4 GHz 20 MHz	0.063
IEEE 802.11n 2.4 GHz 40 MHz	0.049

3 Test Methodology

3.1. Mode of Operation

Decision of Test ATL has verified the construction and function in typical operation. All the test modes were carried out with the EUT in normal operation, which was shown in this test report and defined as:

Test Mode
Mode 1: Transmit mode
Mode 2: IEEE 802.11b Continuous TX mode
Mode 3: IEEE 802.11g Continuous TX mode
Mode 4: IEEE 802.11n 2.4 GHz 20 MHz Continuous TX mode
Mode 5: IEEE 802.11n 2.4 GHz 40 MHz Continuous TX mode

Software used to control the EUT for staying in continuous transmitting mode was programmed.

After verification, all tests were carried out with the worst case test modes.

Note : The test voltage of AC 120 V and AC 12 V were both tested. After our evaluation from AC Power Conducted Emission, the worst case is AC120 V.

Test Mode	ANT-0
Mode 2	V
Mode 3	V
Mode 4	V
Mode 5	V

Test Mode	Antenna Delivery	Data Rate (Mbps)	Test Channel
Mode 2	1TX	1	1, 6, 11
Mode 3	1TX	6	1, 6, 11
Mode 4	1TX	6.5	1, 6, 11
Mode 5	1TX	13.5	3, 6, 9



Duty cycle

Test Mode	Frequency (MHz)	on time (ms)	on+off time (ms)	Duty cycle	Duty Factor (dB)	1/T Minimum VBW (kHz)
Mode 2	2412	10.000	10.000	1.000	0.000	0.010
Mode 3	2412	10.000	10.000	1.000	0.000	0.010
Mode 4	2412	10.000	10.000	1.000	0.000	0.010
Mode 5	2422	10.000	10.000	1.000	0.000	0.010

Duty Cycle Graphs

Mode 2: IEEE 802.11b Continuous TX mode



Mode 3: IEEE 802.11g Continuous TX mode

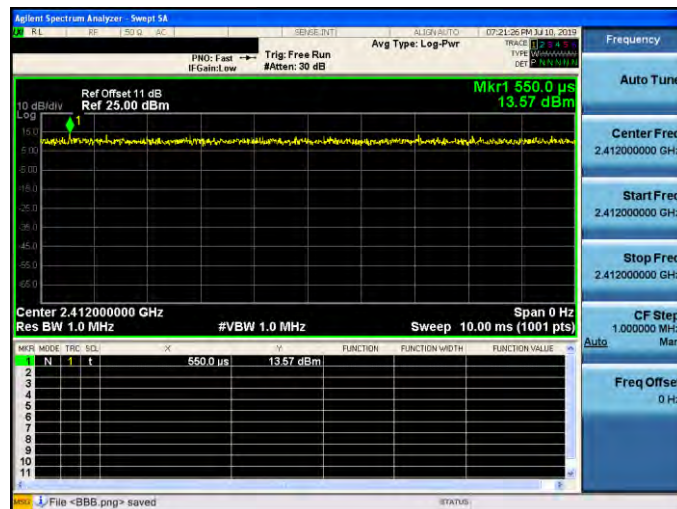

Mode 4: IEEE 802.11n 2.4 GHz 20 MHz Continuous TX mode

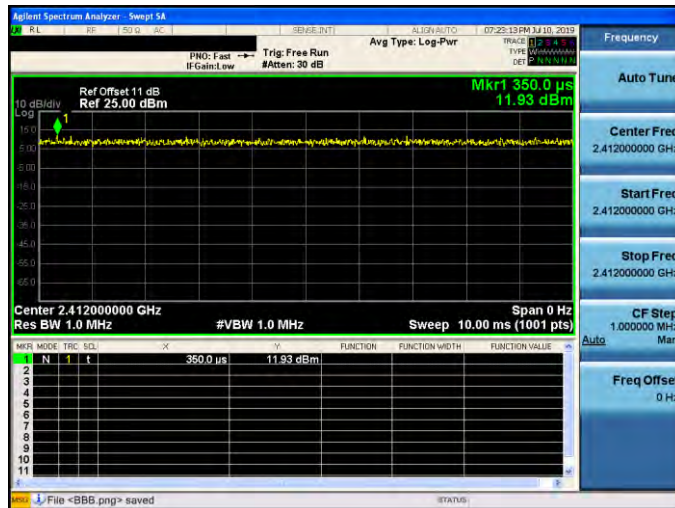

Mode 5: IEEE 802.11n 2.4 GHz 40 MHz Continuous TX mode

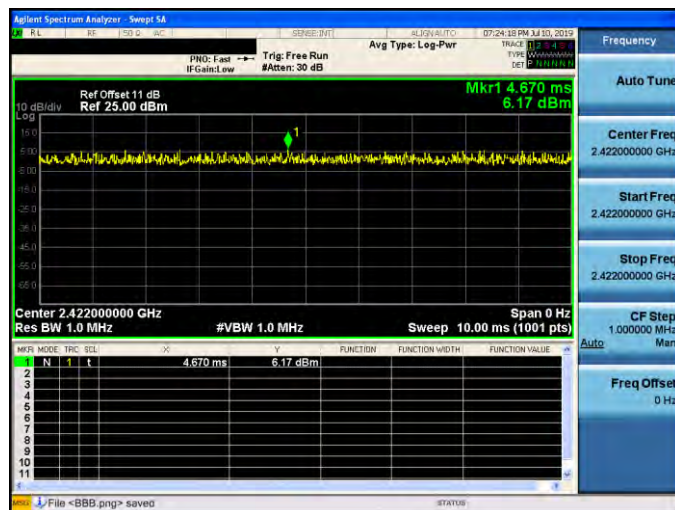



3.2. EUT Test Step

1.	Setup the EUT shown on "Configuration of Test System Details".
2.	Turn on the power of all equipment.
3.	Turn on TX function
4.	EUT run test program.

Measurement Software			
No.	Description	Software	Version
1	Conducted Emission	EZ EMC	1.1.4.3
2	Radiated Emission	EZ EMC	1.1.4.4

3.3. Configuration of Test System Details

Conducted Emissions

for AC 12 V

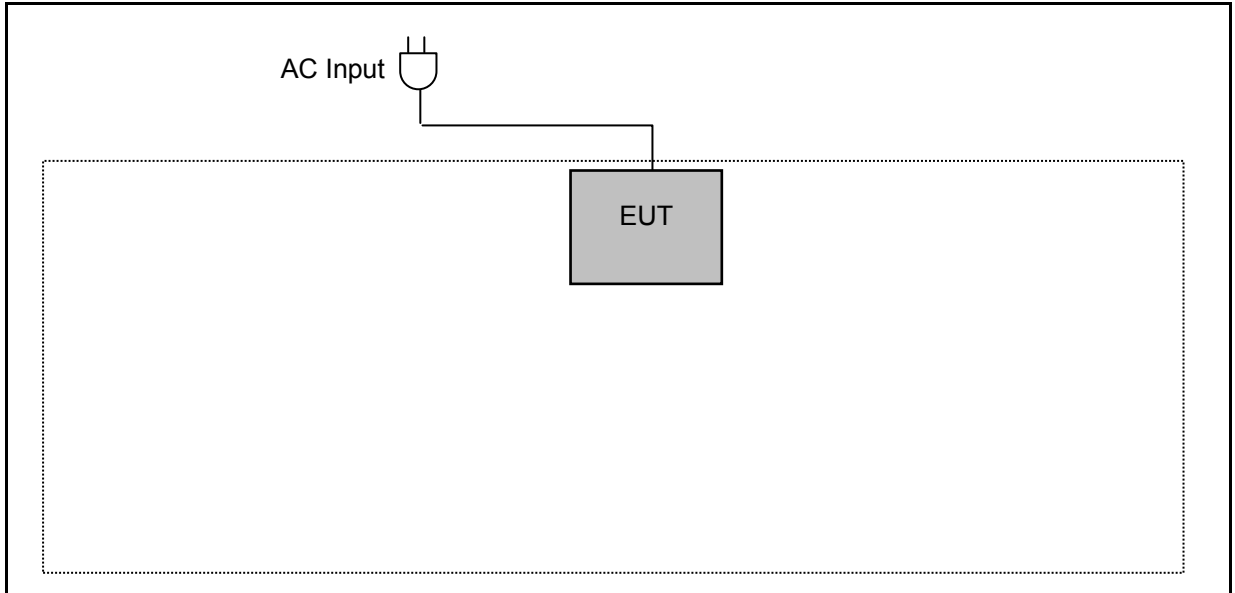

for AC 120 V

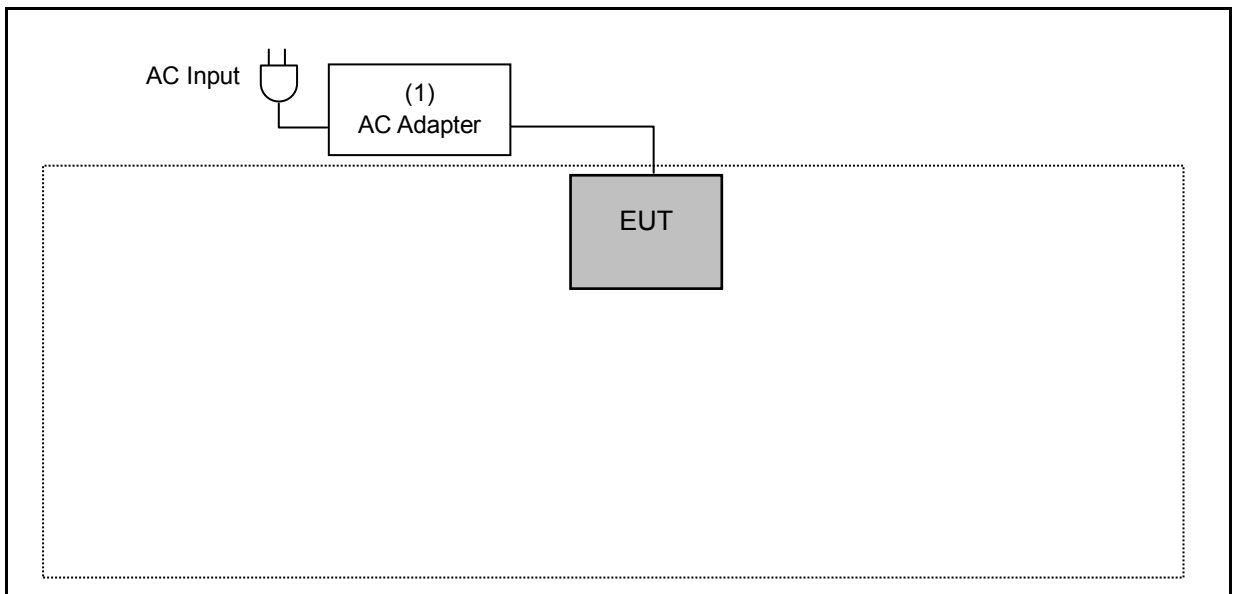

Radiated Emission

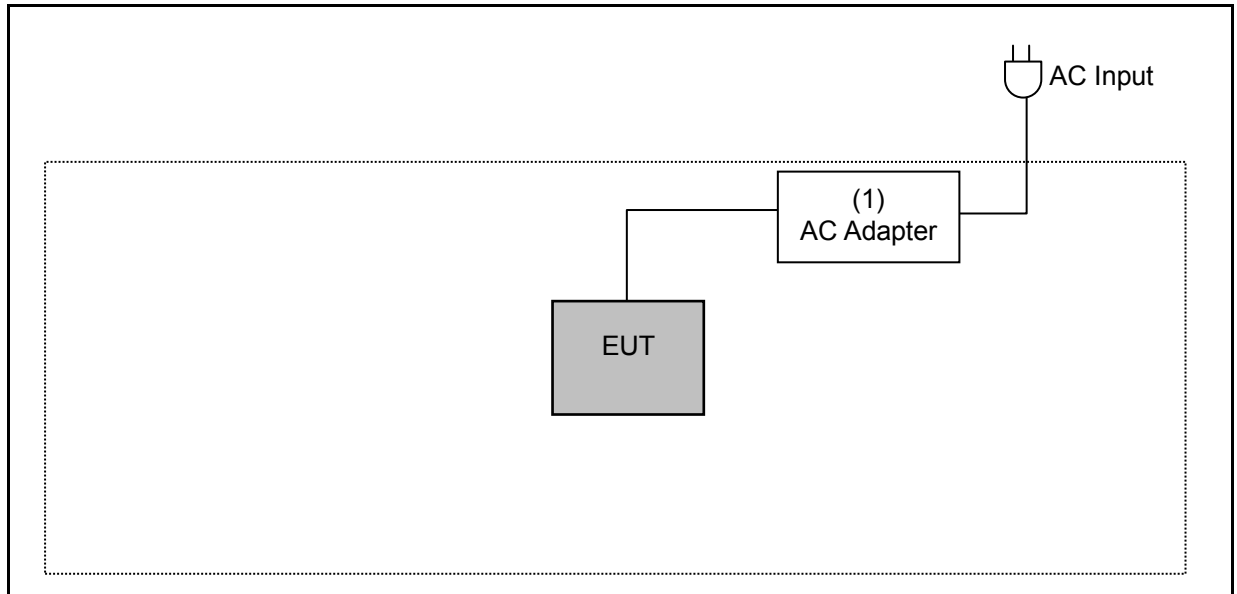

Devices Description					
	Product	Manufacturer	Model Number	Serial Number	Power Cord
(1)	AC Adapter	HUAWEI	HW-050450U00	---	---



3.4. Test Instruments

For Conducted Emission

Test Period: Jul. 04, 2019

Equipment	Manufacturer	Model Number	Serial Number	Cal. Date	Cal. Period
Test Receiver	R&S	ESCI	100367	05/21/2019	1 year
LISN	R&S	ENV216	101040	04/03/2019	1 year
RF Cable	Woken	00100D1380194M	TE-02-03	05/23/2019	1 year

For Radiated Emissions

Test Period: Jun. 10 ~ Jul. 01, 2019

Equipment	Manufacturer	Model Number	Serial Number	Cal. Date	Cal. Period
Spectrum Analyzer (10 Hz~44 GHz)	Keysight	N9010A	MY52221312	01/14/2019	1 year
Pre Amplifier (1~26.5 GHz)	Agilent	8449B	3008A02237	10/16/2018	1 year
Pre Amplifier (100 kHz~1.3 GHz)	Agilent	8447D	2944A11119	01/14/2019	1 year
Pre Amplifier (26.5~40 GHz)	EMCI	EMC2654045	980028	08/23/2018	1 year
Broadband Antenna	Schwarzbeck	VULB9168	416	10/19/2018	1 year
Horn Antenna (1~18 GHz)	SCHWARZBECK MESS-ELEKTRONIK	BBHA9120D	9120D-550	08/23/2018	1 year
Horn Antenna (18~40 GHz)	SCHWARZBECK MESS-ELEKTRONIK	BBHA9170	9170-320	08/07/2018	1 year
Loop Antenna	COM-POWER CORPORATION	AL-130	121014	03/29/2019	1 year
RF Cable	EMCI	EMC104-N-N-6000	TE01-1	02/20/2019	1 year
Microwave Cable	EMCI	EMC104-SM -SM-13000	170814	10/30/2018	1 year
Microwave Cable	EMCI	EMC102-KM -KM-14000	151001	02/20/2019	1 year

For Conducted

Test Period: Jun. 13, 2019

Equipment	Manufacturer	Model Number	Serial Number	Cal. Date	Cal. Period
Spectrum Analyzer (20 Hz~26.5 GHz)	Agilent	N9020A	US47520902	09/25/2018	1 year
Power Sensor	Anritsu	MA2411B	1126022	08/29/2018	1 year
Power Meter	Anritsu	ML2495A	1135009	08/29/2018	1 year
Spectrum Analyzer (3 Hz~50 GHz)	Agilent	N9030A	MY53120541	01/22/2019	1 year

Note: N.C.R. = No Calibration Request.



3.5. Test Site Environment

Items	Required (IEC 60068-1)	Actual
Temperature (°C)	15-35	26
Humidity (%RH)	25-75	60
Barometric pressure (mbar)	860-1060	990

4 Measurement Procedure

4.1. AC Power Line Conducted Emission Measurement

■ Limit

Frequency (MHz)	Quasi-peak	Average
0.15 - 0.5	66 to 56	56 to 46
0.50 - 5.0	56	46
5.0 - 30.0	60	50

■ Test Setup

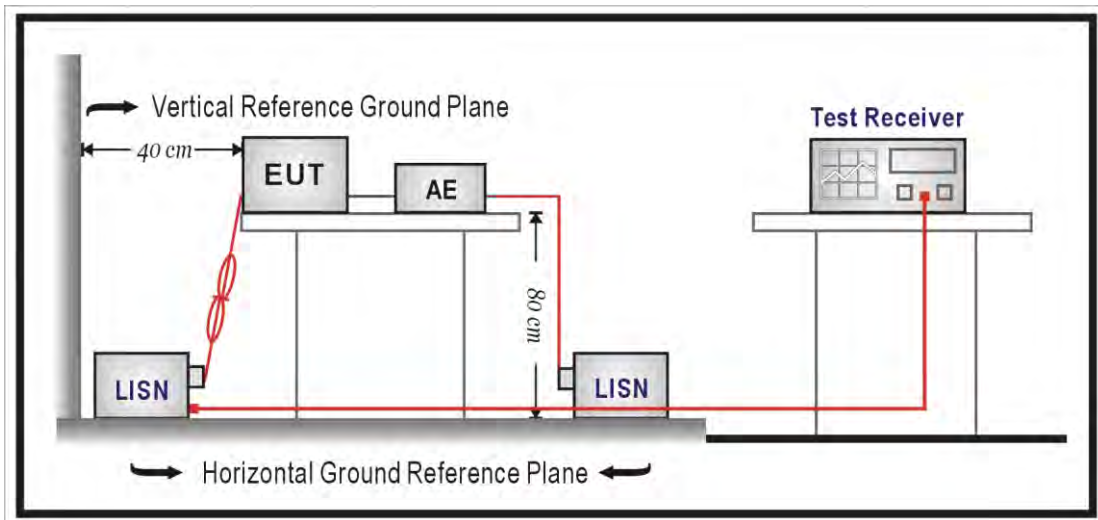

■ Test Procedure

The EUT and simulators are connected to the main power through a line impedance stabilization network (L.I.S.N.). This provides a $50 \Omega // 50 \mu\text{H}$ coupling impedance for the measuring equipment. The peripheral devices are also connected to the main power through a LISN that provides a $50 \Omega // 50 \mu\text{H}$ coupling impedance with 50 ohm termination.

Tabletop device shall be placed on a non-conducting platform, of nominal size 1 m by 1.5 m, raised 80 cm above the reference ground plane. The wall of screened room shall be located 40 cm to the rear of the EUT. Other surfaces of tabletop or floor standing EUT shall be at least 80 cm from any other ground conducting surface including one or more LISNs. For floor-standing device shall be placed under the EUT with a 12 mm insulating material.

Conducted emissions were investigated over the frequency range from 0.15 MHz to 30 MHz using a resolution bandwidth of 9 kHz. The equipment under test (EUT) shall be meet the limits in section 4.1, as applicable, including the average limit and the quasi-peak limit when using respectively, an average detector and quasi-peak detector measured in accordance with the methods described of related standard. When all of peak value were complied with quasi-peak and average limit from 150 kHz to 30 MHz then quasi-peak and average measurement was unnecessary.

The AMN shall be placed 0.8 m from the boundary of the unit under test and bonded to a ground reference plane for AMNs mounted on top of the ground reference plane. This distance is between the closest points of the AMN and the EUT. All other units of the EUT and associated equipment shall be at least 0.8 m from the AMN. If the mains power cable is longer than 1 m then the cable shall be folded back and forth at the centre of the lead to form a bundle no longer than 0.4 m. All of interconnecting cables that hang closer than 40 cm to the ground plane shall be folded back and forth in the center forming a bundle 30 cm to 40 cm long. All of EUT and AE shall be separate place more than 0.1 m. All 50Ω ports of the LISN shall be resistively terminated into 50Ω loads when not connected to the measuring instrument.

If the reading of the measuring receiver shows fluctuations close to the limit, the reading shall be observed for at least 15 s at each measurement frequency; the higher reading shall be recorded with the exception of any brief isolated high reading which shall be ignored.



4.2. Radiated Emission Measurement

■ Limit

According to §15.209(a), except as provided elsewhere in this subpart, the emissions from an intentional radiator shall not exceed the field strength levels specified in the following table:

Frequency (MHz)	Field Strength ($\mu\text{V}/\text{m}$ at meter)	Measurement Distance (meters)
0.009 – 0.490	2400 / F (kHz)	300
0.490 – 1.705	24000 / F (kHz)	30
1.705 – 30.0	30	30
30 - 88	100**	3
88-216	150**	3
216-960	200**	3
Above 960	500	3

** Except as provided in paragraph (g), fundamental emissions from intentional radiators operating under this Section shall not be located in the frequency bands 54-72 MHz, 76-88 MHz, 174-216 MHz or 470-806 MHz. However, operation within these frequency bands is permitted under other sections of this Part, e.g., Sections 15.231 and 15.241.

■ Setup

9 kHz ~ 30 MHz

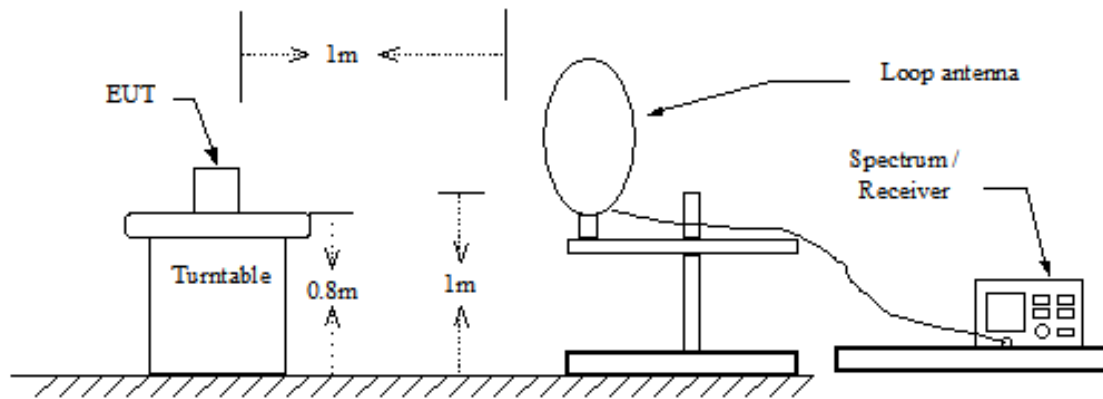

Below 1 GHz

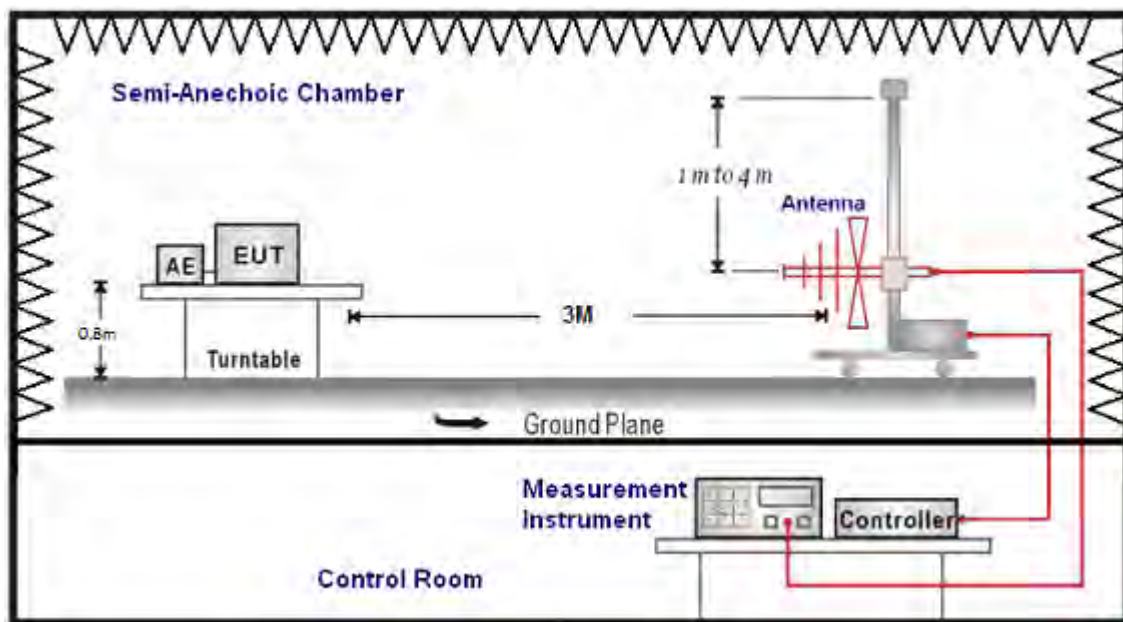

Above 1 GHz

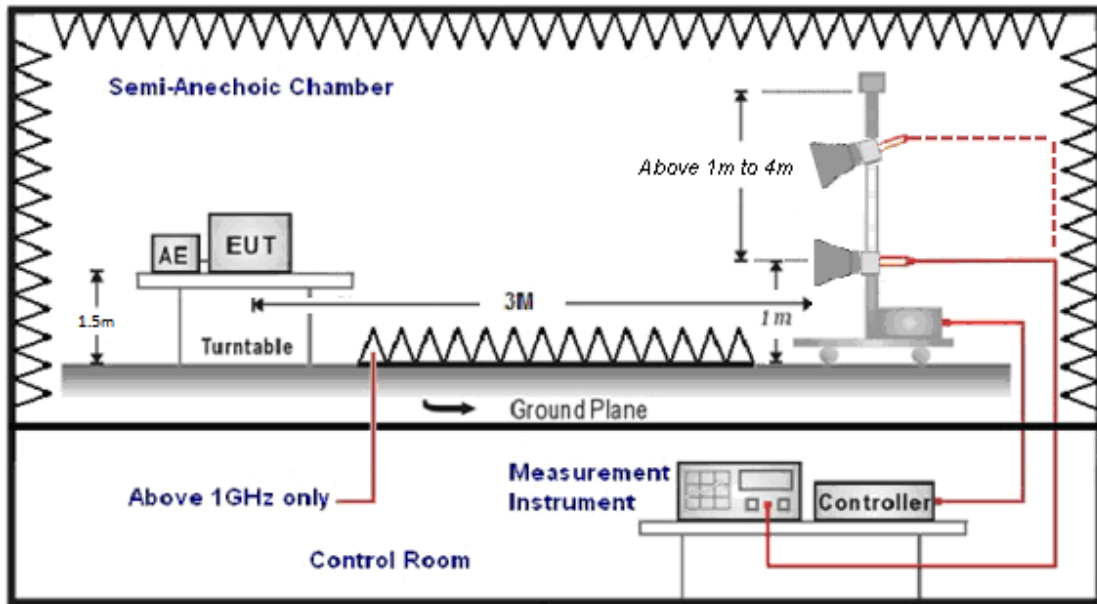

■ Test Procedure

Final radiation measurements were made on a three-meter, Semi Anechoic Chamber. The EUT system was placed on a nonconductive turntable which is 0.8 or 1.5 meters height, top surface 1.0 x 1.5 meter. The spectrum was examined from 250 MHz to 2.5 GHz in order to cover the whole spectrum below 10th harmonic which could generate from the EUT. During the test, EUT was set to transmit continuously & Measurements spectrum range from 9 kHz to 26.5 GHz is investigated.

For measurements below 1 GHz the resolution bandwidth is set to 100 kHz for peak detection measurements or 120 kHz for quasi-peak detection measurements. Peak detection is used unless otherwise noted as quasi-peak.

For measurements above 1 GHz the resolution bandwidth is set to 1 MHz, and then the video bandwidth is set to 3 MHz for peak measurements and 10 Hz for average measurements when Duty cycle >0.98 / $1/T$ for average measurements when Duty cycle <0.98 . A nonconductive material surrounded the EUT to supporting the EUT for standing on three orthogonal planes. At each condition, the EUT was rotated 360 degrees, and the antenna was raised and lowered from one to four meters to find the maximum emission levels. Measurements were taken using both horizontal and vertical antenna polarization.

SCHWARZBECK MESS-ELEKTRONIK Biconilog Antenna at 3 Meter and the SCHWARZBECK Double Ridged Guide Antenna was used in frequencies 1 –26.5 GHz at a distance of 3 meter. The antenna at an angle toward the source of the emission. All test results were extrapolated to equivalent signal at 3 meters utilizing an inverse linear distance extrapolation Factor (20 dB/decade).

For testing above 1 GHz, the emission level of the EUT in peak mode was 20 dB lower than average limit (that means the emission level in peak mode also complies with the limit in average mode), then testing will be stopped and peak values of EUT will be reported, otherwise, the emissions will be measured in average mode again and reported.

Appropriate preamplifiers were used for improving sensitivity and precautions were taken to avoid overloading or desensitizing the spectrum analyzer. No post – detector video filters were used in the test.

The spectrum analyzer's 6 dB bandwidth was set to 1 MHz, and the analyzer was operated in the peak detection mode, for frequencies both below and up 1 GHz. The average levels were obtained by subtracting the duty cycle correction factor from the peak readings.

The following procedures were used to convert the emission levels measured in decibels referenced to 1 microvolt (dBuV) into field intensity in micro volts pre meter (uV/m).

The actual field intensity in decibels referenced to 1 microvolt in to field intensity in micro volts per meter (dBuV/m).



The actual field intensity in referenced to 1 microvolt per meter (dBuV/m) is determined by algebraically adding the measured reading in dBuV, the antenna factor (dB), and cable loss (dB) and Subtracting the gain of preamplifier (dB) is auto calculate in spectrum analyzer.

$$(1) \text{ Amplitude (dBuV/m) = FI (dBuV) +AF (dBuV) +CL (dBuV)-Gain (dB)}$$

FI= Reading of the field intensity.

AF= Antenna factor.

CL= Cable loss.

P.S Amplitude is auto calculate in spectrum analyzer.

$$(2) \text{ Actual Amplitude (dBuV/m) = Amplitude (dBuV)-Dis(dB)}$$

The FCC specified emission limits were calculated according the EUT operating frequency and by following linear interpolation equations:

(a) For fundamental frequency : Transmitter Output < +30 dBm

(b) For spurious frequency : Spurious emission limits = fundamental emission limit /10

Data of measurement within this frequency range without mark in the table above means the reading of emissions are attenuated more than 20 dB below the permissible limits or the field strength is too small to be measured.

4.3. Maximum Conducted Output Power Measurement

■ Limit

For systems using digital modulation in the 2400-2483.5 MHz, the limit for maximum output power is 30 dBm.

And According to 15.247 (b), if transmitting antennas of directional gain greater than 6 dBi are used, the power shall be reduced by the amount in dB that the directional gain of the antenna exceeds 6 dBi.

■ Test Setup

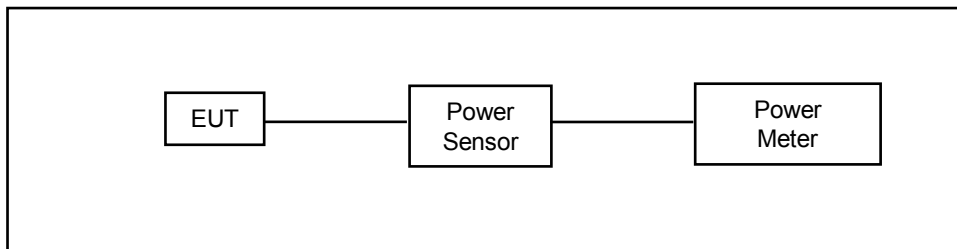

■ Test Procedure

The testing follows the Measurement Procedure of ANSI C63.10:2013 section 11.9.2.3.2 Method AVGPM.

The tests below are run with the EUT's transmitter set at high power in TX mode. The EUT is needed to force selection of output power level and channel number. While testing, EUT was set to transmit continuously. Remove the Subjective device's antenna and connect the RF output port to power sensor.

4.4. 6 dB RF Bandwidth Measurement

■ Limit

6 dB RF Bandwidth: Systems using digital modulation techniques may operate in the 2400–2483.5 MHz bands. The minimum 6 dB band-width shall be at least 500 kHz.

■ Test Setup

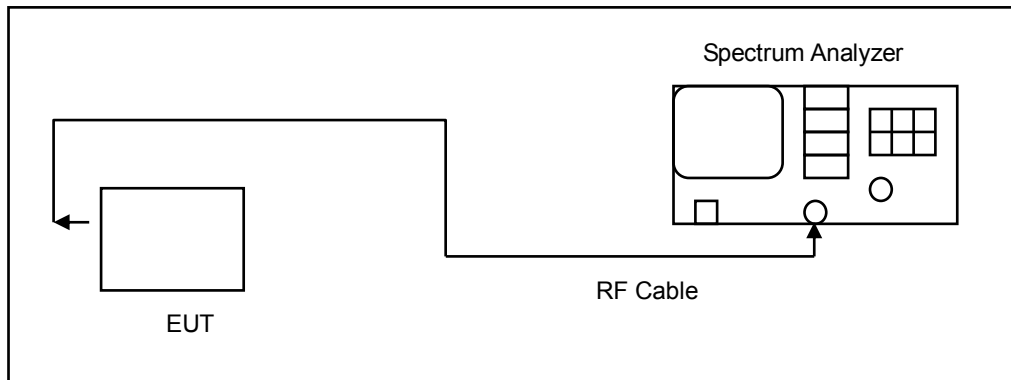

■ Test Procedure

The EUT tested to DTS test procedure of ANSI C63.10:2013 section 11.8.2 option2 for compliance to FCC 47CFR 15.247 requirements.

6 dB RF Bandwidth: The antenna port of the EUT was connected to the input of a spectrum analyzer. Analyzer RBW was set to 100 kHz. For each RF output channel investigated, the spectrum analyzer center frequency was set to the channel carrier. A peak output reading was taken, a DISPLAY line was drawn 6 dB lower than peak level. The 6 dB bandwidth was determined from where the channel output spectrum intersected the display line.

The test was performed at 3 channels (Channel low, middle, high)

4.5. Maximum Power Spectral Density Measurement

■ Limit

For digitally modulated systems, the power spectral density conducted from the intentional radiator to the antenna shall not be greater than 8 dBm in any 3 kHz band during any time interval of continuous transmission.

■ Test Setup

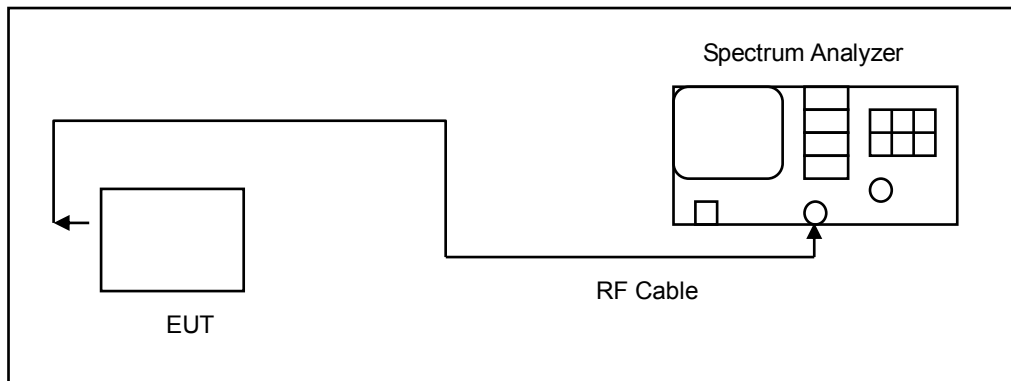

■ Test Procedure

The EUT tested to DTS test procedure of ANSI C63.10:2013 section 11.10.2 Method PKPSD for compliance to FCC 47CFR 15.247 requirements.

1. Set analyzer center frequency to DTS channel center frequency.
2. Set the span to 1.5 times the DTS bandwidth.
3. Set the RBW to: $3 \text{ kHz} \leq \text{RBW} \leq 100 \text{ kHz}$.
4. Set the VBW $\geq 3 \times \text{RBW}$.
5. Detector = peak.
6. Sweep time = auto couple.
7. Trace mode = max hold.
8. Allow trace to fully stabilize.
9. Use the peak marker function to determine the maximum amplitude level within the RBW.
10. If measured value exceeds limit, reduce RBW (no less than 3 kHz) and repeat.

4.6. Out of Band Conducted Emissions Measurement

■ **Limit**

In any 100 kHz bandwidth outside the frequency band in which the spread spectrum or digitally modulated intentional radiator is operating, the radio frequency power that is produced by the intentional radiator shall be at least 30 dB below that in the 100 kHz bandwidth within the band that contains the highest level of the desired power

■ **Test Setup**

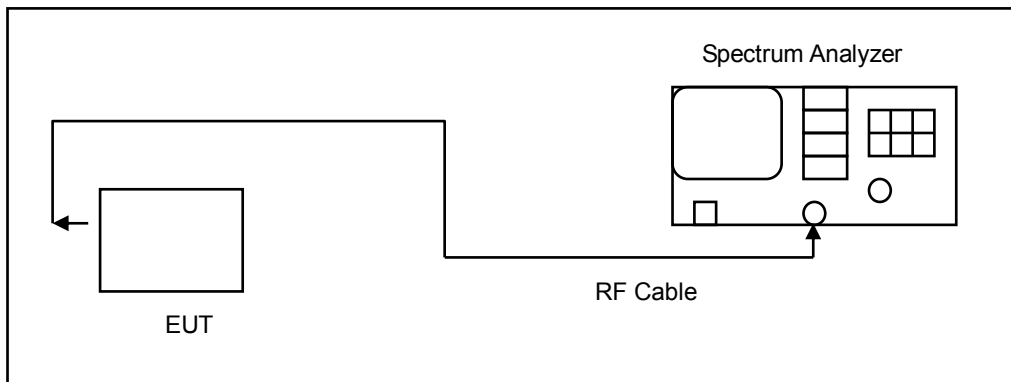

■ **Test Procedure**

In any 100 kHz bandwidth outside the EUT pass band, the RF power produced by the modulation products of the spreading sequence, the information sequence, and the carrier frequency shall be at least 30 dB below that of the maximum in-band 100 kHz emission, antenna output of the EUT was coupled directly to spectrum analyzer; if an external attenuator and/or cable was used, these losses are compensated for with the analyzer OFFSET function.

All other types of emissions from the EUT shall meet the general limits for radiated frequencies outside the pass band. The test was performed at 3 channels.



4.7. Antenna Measurement

■ Limit

For intentional device, according to 15.203, an intentional radiator shall be designed to ensure that no antenna other than that furnished by the responsible party shall be used with the device.

And According to 15.247 (b), if transmitting antennas of directional gain greater than 6 dBi are used, the power shall be reduced by the amount in dB that the directional gain of the antenna exceeds 6 dBi.

■ Antenna Description

See section 2 – antenna information.



5 Test Results

Annex A. Conducted Emission

Standard:	FCC Part 15.247	Line:	L1
Test item:	Conducted Emission	Power:	AC 12 V/60 Hz
Test Mode:	Mode 1	Temp.(°C)/Hum.(%RH):	26(°C)/60 %RH
Description:			

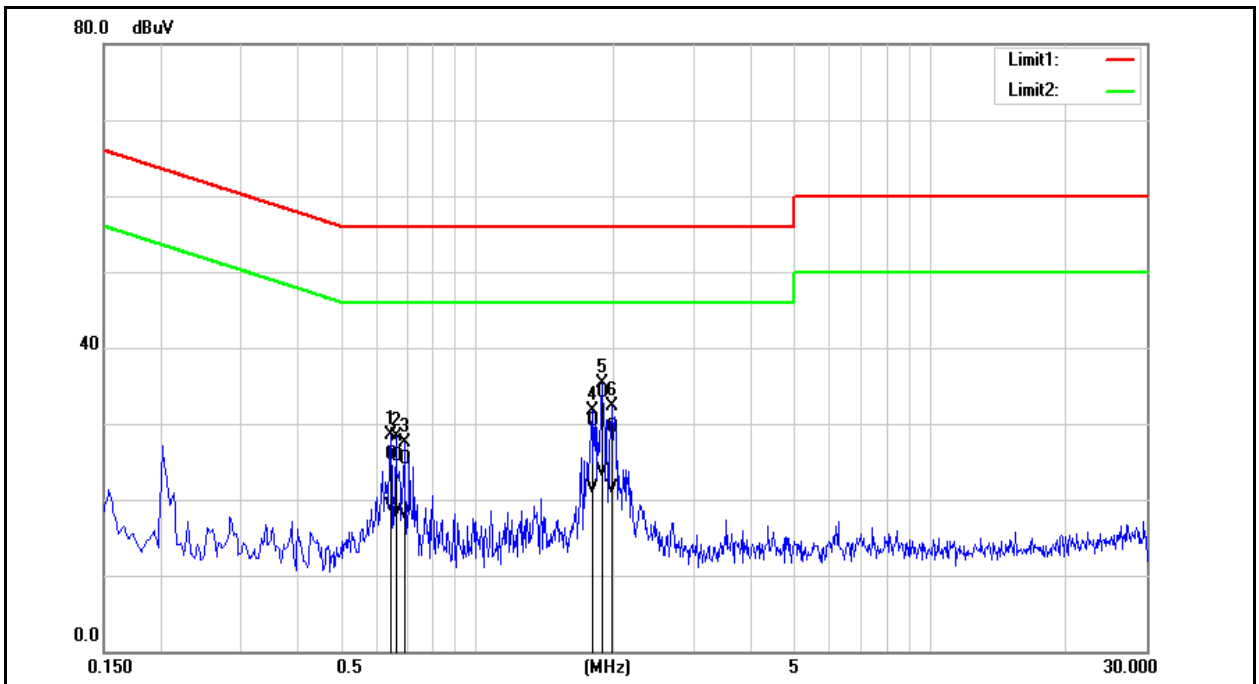

No.	Frequency (MHz)	QP reading (dBuV)	AVG reading (dBuV)	Correction factor (dB)	QP result (dBuV)	AVG result (dBuV)	QP limit (dBuV)	AVG limit (dBuV)	QP margin (dB)	AVG margin (dB)	Remark
1	0.6460	16.26	9.37	9.66	25.92	19.03	56.00	46.00	-30.08	-26.97	Pass
2	0.6620	16.13	8.66	9.66	25.79	18.32	56.00	46.00	-30.21	-27.68	Pass
3	0.6900	15.63	8.42	9.66	25.29	18.08	56.00	46.00	-30.71	-27.92	Pass
4	1.7980	20.50	11.86	9.71	30.21	21.57	56.00	46.00	-25.79	-24.43	Pass
5	1.8900	24.42	13.92	9.72	34.14	23.64	56.00	46.00	-21.86	-22.36	Pass
6	1.9820	19.87	11.78	9.72	29.59	21.50	56.00	46.00	-26.41	-24.50	Pass

Note: 1. Result (dBuV) = Correction factor (dB) + Reading(dBuV).
2. Correction factor (dB) = Cable loss (dB) + L.I.S.N. factor (dB).



Standard:	FCC Part 15.247	Line:	N
Test item:	Conducted Emission	Power:	AC 12 V/60 Hz
Test Mode:	Mode 1	Temp.(°C)/Hum.(%RH):	26(°C)/60 %RH
Description:			

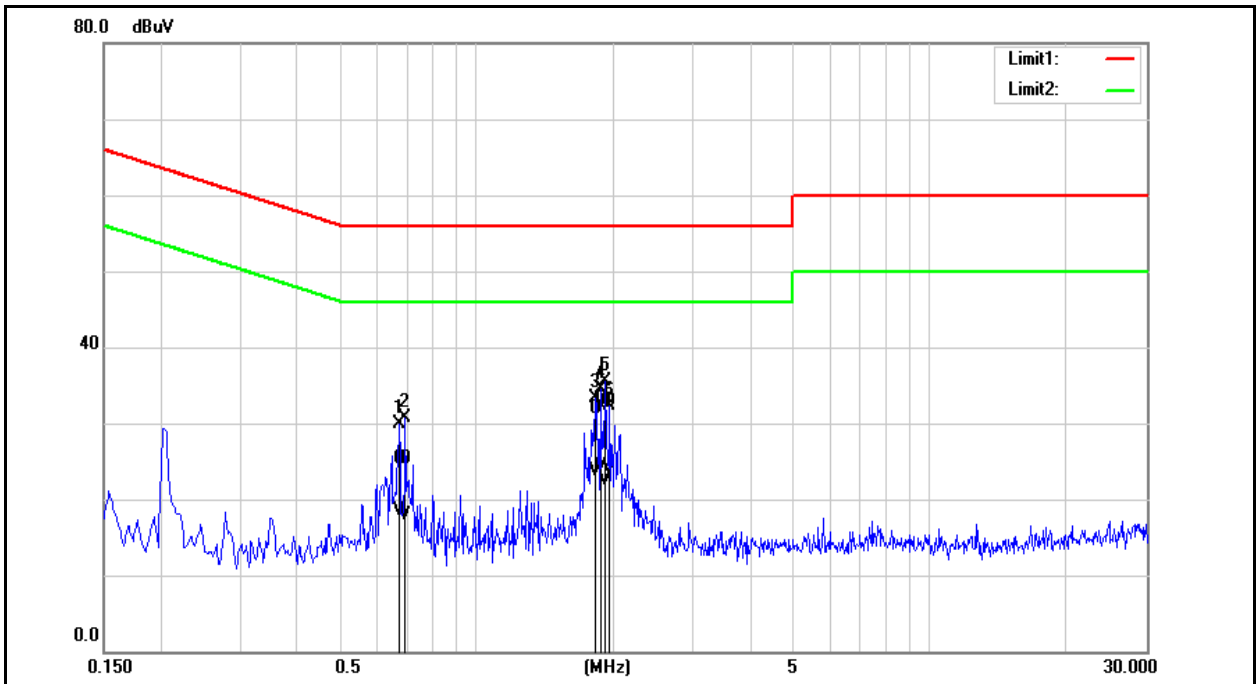

No.	Frequency (MHz)	QP reading (dBuV)	AVG reading (dBuV)	Correction factor (dB)	QP result (dBuV)	AVG result (dBuV)	QP limit (dBuV)	AVG limit (dBuV)	QP margin (dB)	AVG margin (dB)	Remark
1	0.6740	15.55	8.89	9.69	25.24	18.58	56.00	46.00	-30.76	-27.42	Pass
2	0.6940	15.63	8.26	9.69	25.32	17.95	56.00	46.00	-30.68	-28.05	Pass
3	1.8260	22.10	14.03	9.74	31.84	23.77	56.00	46.00	-24.16	-22.23	Pass
4	1.8740	23.44	14.58	9.74	33.18	24.32	56.00	46.00	-22.82	-21.68	Pass
5	1.9220	23.01	12.81	9.75	32.76	22.56	56.00	46.00	-23.24	-23.44	Pass
6	1.9660	23.15	14.06	9.75	32.90	23.81	56.00	46.00	-23.10	-22.19	Pass

Note: 1. Result (dBuV) = Correction factor (dB) + Reading(dBuV).
2. Correction factor (dB) = Cable loss (dB) + L.I.S.N. factor (dB).



Standard:	FCC Part 15.247	Line:	L1
Test item:	Conducted Emission	Power:	AC 120 V/60 Hz
Test Mode:	Mode 1	Temp.(°C)/Hum.(%RH):	26(°C)/60 %RH
Description:			

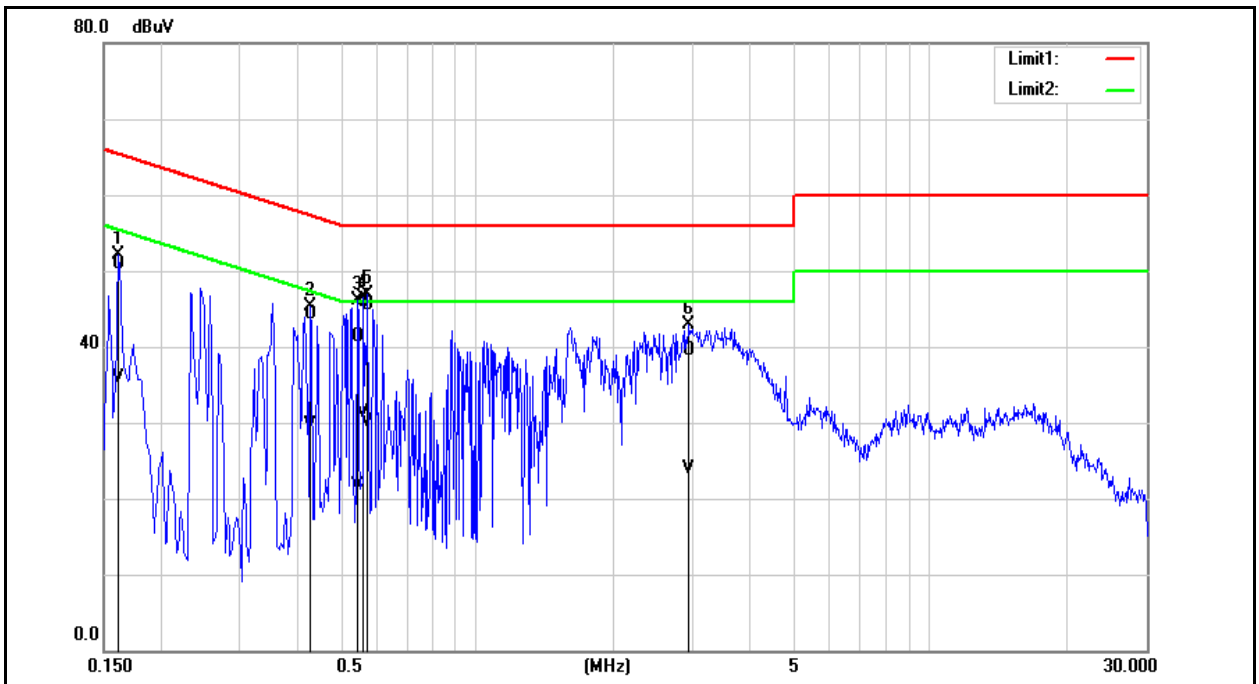

No.	Frequency (MHz)	QP reading (dBuV)	AVG reading (dBuV)	Correction factor (dB)	QP result (dBuV)	AVG result (dBuV)	QP limit (dBuV)	AVG limit (dBuV)	QP margin (dB)	AVG margin (dB)	Remark
1	0.1620	41.16	26.24	9.65	50.81	35.89	65.36	55.36	-14.55	-19.47	Pass
2	0.4300	34.65	20.09	9.66	44.31	29.75	57.25	47.25	-12.94	-17.50	Pass
3	0.5460	31.61	12.03	9.66	41.27	21.69	56.00	46.00	-14.73	-24.31	Pass
4	0.5620	36.34	21.59	9.66	46.00	31.25	56.00	46.00	-10.00	-14.75	Pass
5	0.5740	35.76	20.48	9.66	45.42	30.14	56.00	46.00	-10.58	-15.86	Pass
6	2.9380	29.81	14.08	9.75	39.56	23.83	56.00	46.00	-16.44	-22.17	Pass

Note: 1. Result (dBuV) = Correction factor (dB) + Reading(dBuV).
2. Correction factor (dB) = Cable loss (dB) + L.I.S.N. factor (dB).

Standard:	FCC Part 15.247	Line:	N
Test item:	Conducted Emission	Power:	AC 120 V/60 Hz
Test Mode:	Mode 1	Temp.(°C)/Hum.(%RH):	26(°C)/60 %RH
Description:			

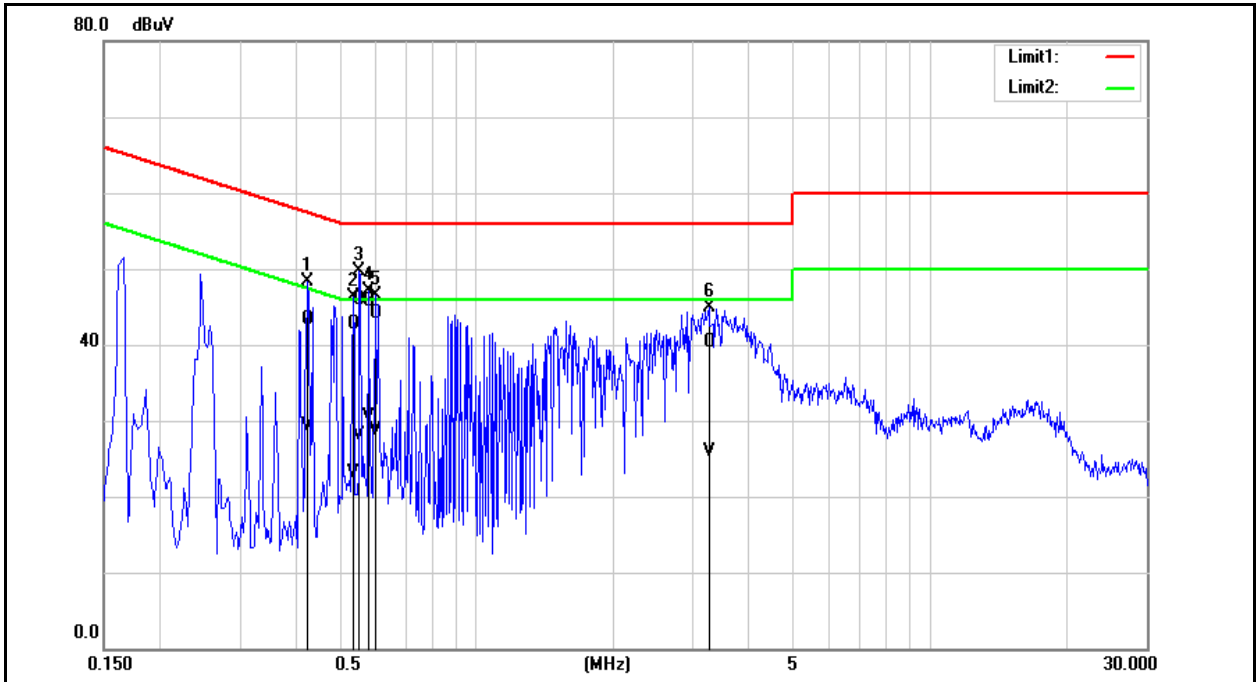

No.	Frequency (MHz)	QP reading (dBuV)	AVG reading (dBuV)	Correction factor (dB)	QP result (dBuV)	AVG result (dBuV)	QP limit (dBuV)	AVG limit (dBuV)	QP margin (dB)	AVG margin (dB)	Remark
1	0.4220	33.53	19.70	9.68	43.21	29.38	57.41	47.41	-14.20	-18.03	Pass
2	0.5340	33.09	13.47	9.69	42.78	23.16	56.00	46.00	-13.22	-22.84	Pass
3	0.5500	36.18	18.35	9.69	45.87	28.04	56.00	46.00	-10.13	-17.96	Pass
4	0.5780	35.96	20.73	9.69	45.65	30.42	56.00	46.00	-10.35	-15.58	Pass
5	0.5980	34.45	18.98	9.69	44.14	28.67	56.00	46.00	-11.86	-17.33	Pass
6	3.2420	30.59	16.16	9.78	40.37	25.94	56.00	46.00	-15.63	-20.06	Pass

Note: 1. Result (dBuV) = Correction factor (dB) + Reading(dBuV).

2. Correction factor (dB) = Cable loss (dB) + L.I.S.N. factor (dB).



Annex B. Conducted Test Results

Maximum Conducted Output Power Measurement

Test Mode	Data Rate (Mbps)	Frequency (MHz)	Average Output Power		
			Measurement Results		Limit
			dBm	W	dBm
Mode 2	1	2412	19.93	0.098	≤ 30
		2437	19.45	0.088	≤ 30
		2462	19.09	0.081	≤ 30
Mode 3	6	2412	18.92	0.078	≤ 30
		2437	18.67	0.074	≤ 30
		2462	17.78	0.060	≤ 30
Mode 4	6.5	2412	17.99	0.063	≤ 30
		2437	17.84	0.061	≤ 30
		2462	16.78	0.048	≤ 30
Mode 5	13.5	2422	16.86	0.049	≤ 30
		2437	16.61	0.046	≤ 30
		2452	16.18	0.041	≤ 30

Note: The relevant measured result has the offset with cable loss already.



6 dB RF Bandwidth Measurement

Test Mode	Frequency (MHz)	Measurement (kHz)	Limit (kHz)
Mode 2	2412	10050	≥ 500
	2437	10060	≥ 500
	2462	10050	≥ 500
Mode 3	2412	16350	≥ 500
	2437	16340	≥ 500
	2462	16090	≥ 500
Mode 4	2412	17600	≥ 500
	2437	17580	≥ 500
	2462	17560	≥ 500
Mode 5	2422	35860	≥ 500
	2437	36060	≥ 500
	2452	36030	≥ 500



■ Test Graphs

Mode 2: IEEE 802.11b Continuous TX mode

<p>2412 MHz</p>	<p>Agilent Spectrum Analyzer - Occupied BW</p> <p>Center Freq: 2.412000000 GHz Trig: Free Run #IF Gain: Low #Atten: 20 dB Avg/Hold: > 1/1 Radio Std: None Radio Device: BTS</p> <p>Ref Offset 11 dB Ref 20.00 dBm</p> <p>Center 2.412 GHz #Res BW 100 kHz #VBW 300 kHz Span 30 MHz Sweep 2.933 ms</p> <p>Occupied Bandwidth 14.470 MHz Total Power 25.7 dBm Transmit Freq Error -20.549 kHz OBW Power 99.00 % x dB Bandwidth 10.05 MHz x dB -6.00 dB</p> <p>File <BB6.png> saved</p>
<p>2437 MHz</p>	<p>Agilent Spectrum Analyzer - Occupied BW</p> <p>Center Freq: 2.437000000 GHz Trig: Free Run #IF Gain: Low #Atten: 20 dB Avg/Hold: > 1/1 Radio Std: None Radio Device: BTS</p> <p>Ref Offset 11 dB Ref 20.00 dBm</p> <p>Center 2.437 GHz #Res BW 100 kHz #VBW 300 kHz Span 30 MHz Sweep 2.933 ms</p> <p>Occupied Bandwidth 14.424 MHz Total Power 25.3 dBm Transmit Freq Error -34.111 kHz OBW Power 99.00 % x dB Bandwidth 10.06 MHz x dB -6.00 dB</p> <p>File <BB6.png> saved</p>
<p>2462 MHz</p>	<p>Agilent Spectrum Analyzer - Occupied BW</p> <p>Center Freq: 2.462000000 GHz Trig: Free Run #IF Gain: Low #Atten: 20 dB Avg/Hold: > 1/1 Radio Std: None Radio Device: BTS</p> <p>Ref Offset 11 dB Ref 20.00 dBm</p> <p>Center 2.462 GHz #Res BW 100 kHz #VBW 300 kHz Span 30 MHz Sweep 2.933 ms</p> <p>Occupied Bandwidth 14.391 MHz Total Power 24.7 dBm Transmit Freq Error -43.957 kHz OBW Power 99.00 % x dB Bandwidth 10.05 MHz x dB -6.00 dB</p> <p>File <BB6.png> saved</p>



Mode 3: IEEE 802.11g Continuous TX mode

2412 MHz

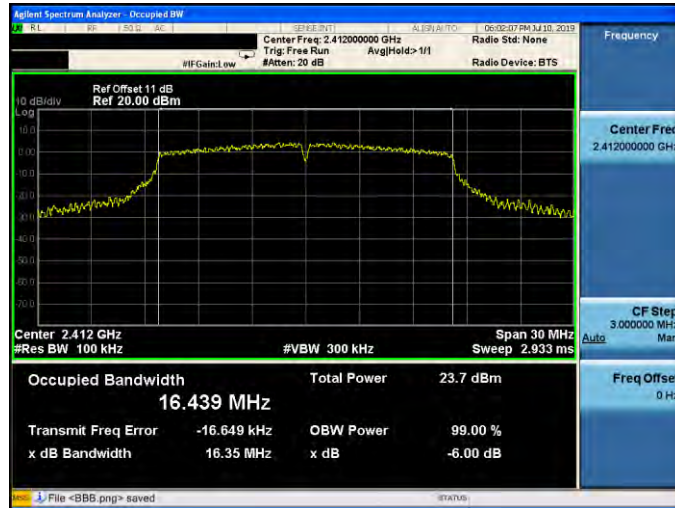

2437 MHz



2462 MHz





Mode 4: IEEE 802.11n 2.4 GHz 20 MHz Continuous TX mode

2412 MHz



2437 MHz



2462 MHz





Mode 5: IEEE 802.11n 2.4 GHz 40 MHz Continuous TX mode

2422 MHz



2437 MHz



2452 MHz





Maximum Power Spectral Density Measurement

Test Mode	Frequency (MHz)	Measurement (dBm/3 kHz)	Limit (dBm/3 kHz)
Mode 2	2412	-4.046	≤ 8
	2437	-4.322	≤ 8
	2462	-4.769	≤ 8
Mode 3	2412	-6.946	≤ 8
	2437	-7.548	≤ 8
	2462	-7.935	≤ 8
Mode 4	2412	-7.770	≤ 8
	2437	-8.461	≤ 8
	2462	-8.674	≤ 8
Mode 5	2422	-11.855	≤ 8
	2437	-12.753	≤ 8
	2452	-12.955	≤ 8

■ Test Graphs

Mode 2: IEEE 802.11b Continuous TX mode	
2412 MHz	
2437 MHz	
2462 MHz	



Mode 3: IEEE 802.11g Continuous TX mode

2412 MHz



2437 MHz



2462 MHz

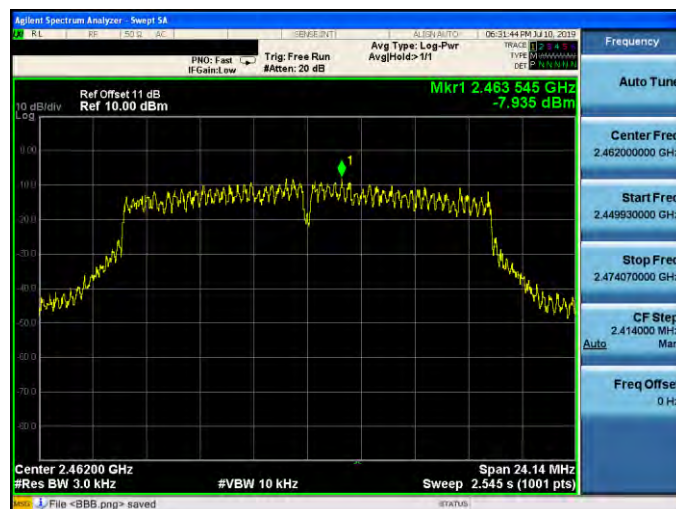



Mode 4: IEEE 802.11n 2.4 GHz 20 MHz Continuous TX mode

2412 MHz

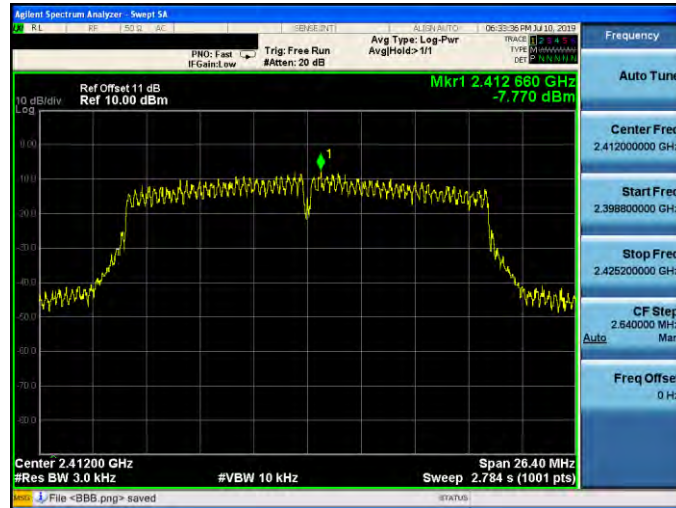

2437 MHz



2462 MHz





Mode 5: IEEE 802.11n 2.4 GHz 40 MHz Continuous TX mode

2422 MHz

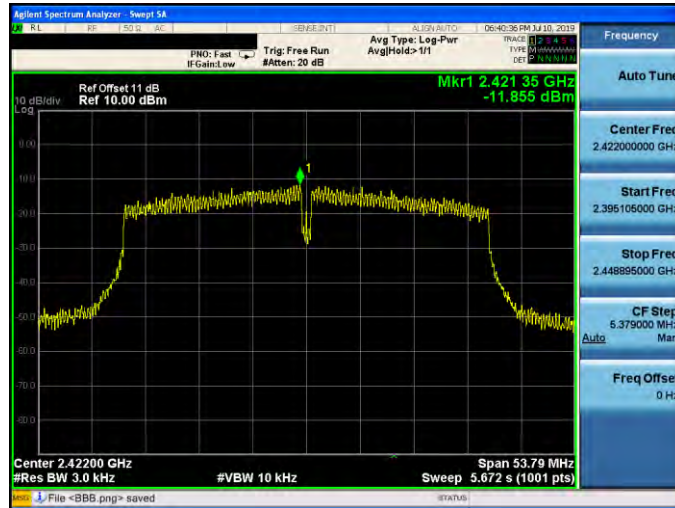

2437 MHz



2452 MHz



Out of Band Conducted Emissions Measurement

■ Test Graphs

Reference level

Mode 2: IEEE 802.11b Continuous TX mode

<p>2412 MHz</p>	
<p>2437 MHz</p>	
<p>2462 MHz</p>	



Mode 3: IEEE 802.11g Continuous TX mode

2412 MHz



2437 MHz



2462 MHz





Mode 4: IEEE 802.11n 2.4 GHz 20 MHz Continuous TX mode

2412 MHz



2437 MHz



2462 MHz





Mode 5: IEEE 802.11n 2.4 GHz 40 MHz Continuous TX mode

2422 MHz



2437 MHz



2452 MHz





Out of Band Conducted Emissions

Mode 2: IEEE 802.11b Continuous TX mode

2412 MHz

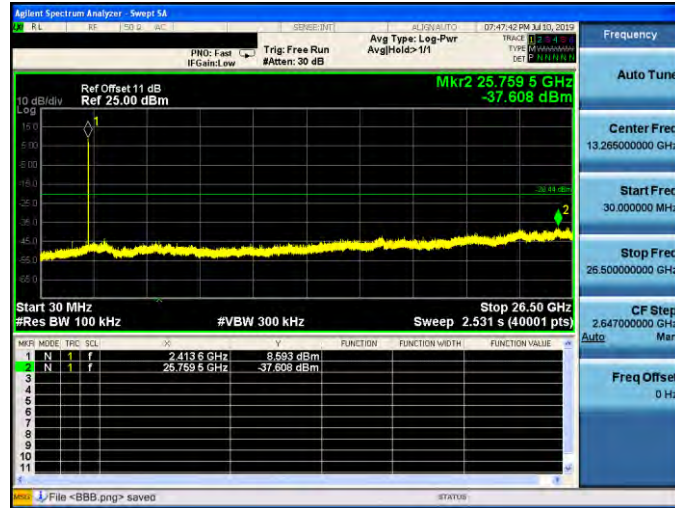

2437 MHz

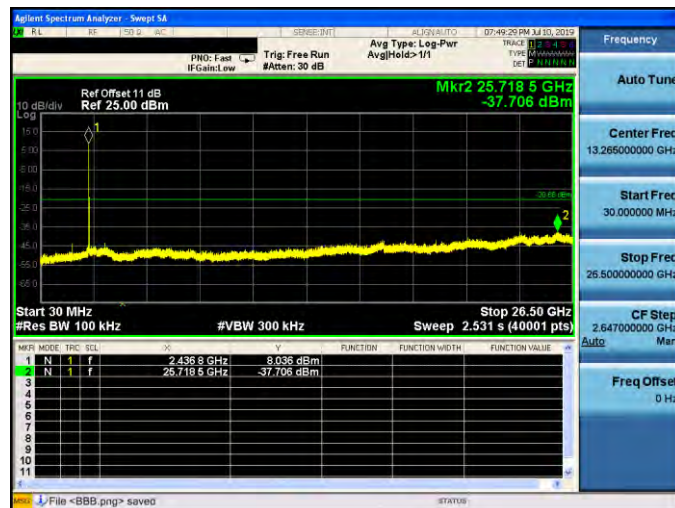

2462 MHz

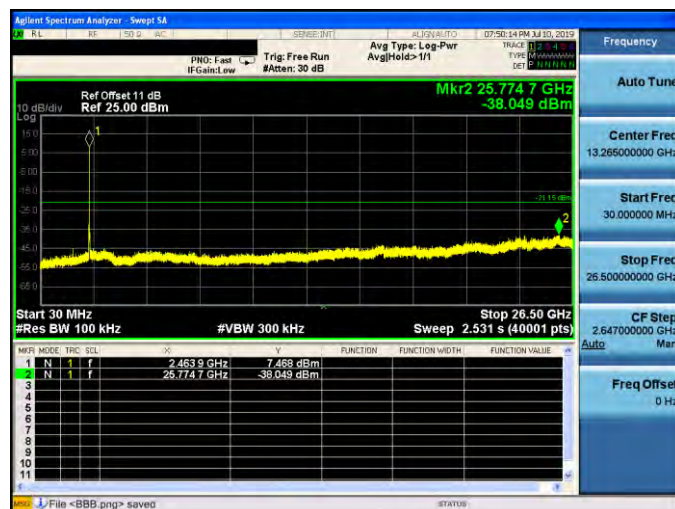



Mode 3: IEEE 802.11g Continuous TX mode

2412 MHz

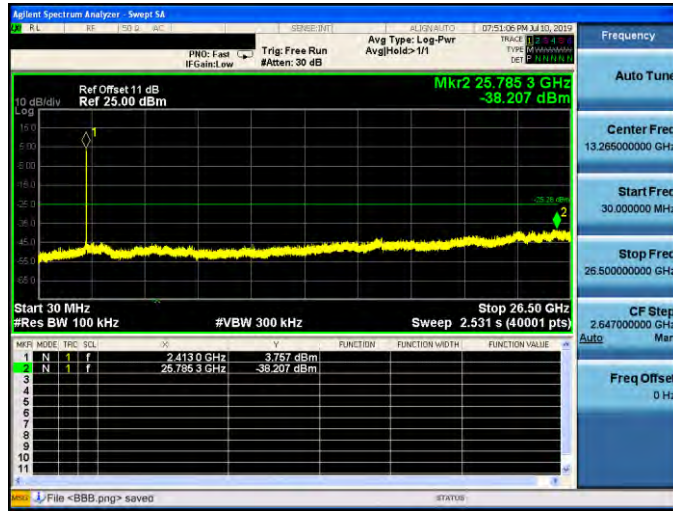

2437 MHz

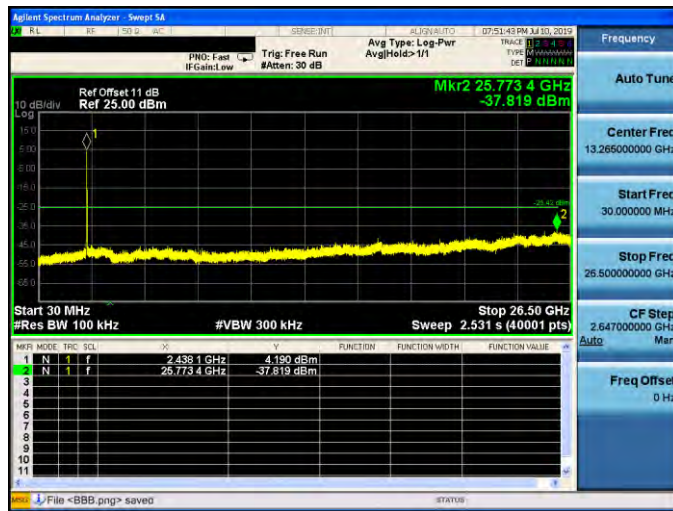

2462 MHz

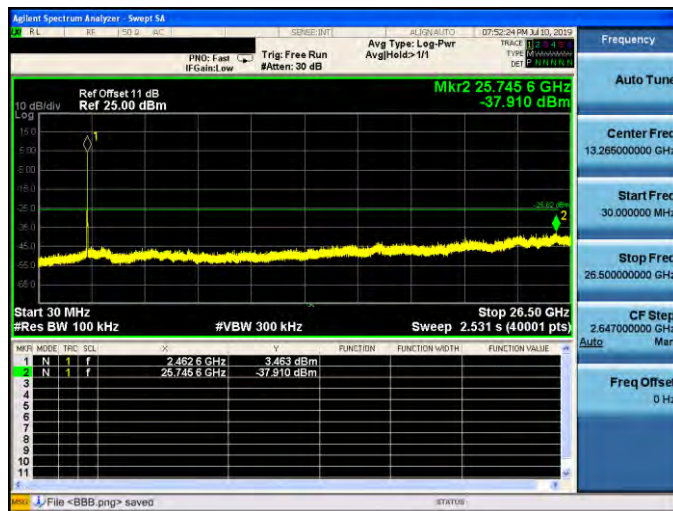



Mode 4: IEEE 802.11n 2.4 GHz 20 MHz Continuous TX mode

2412 MHz

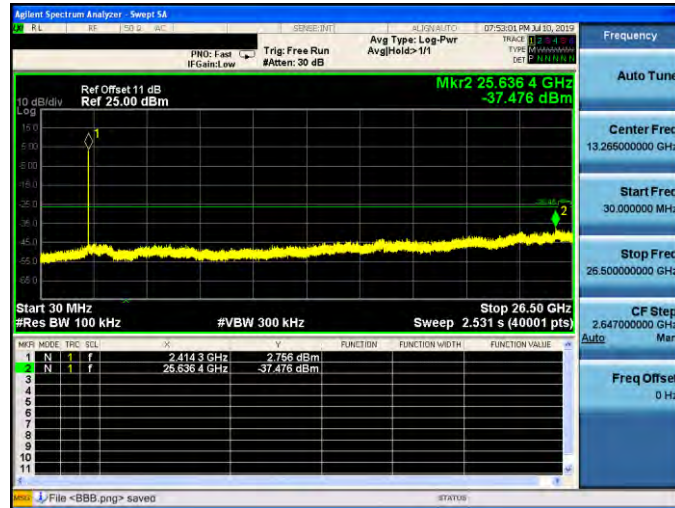

2437 MHz

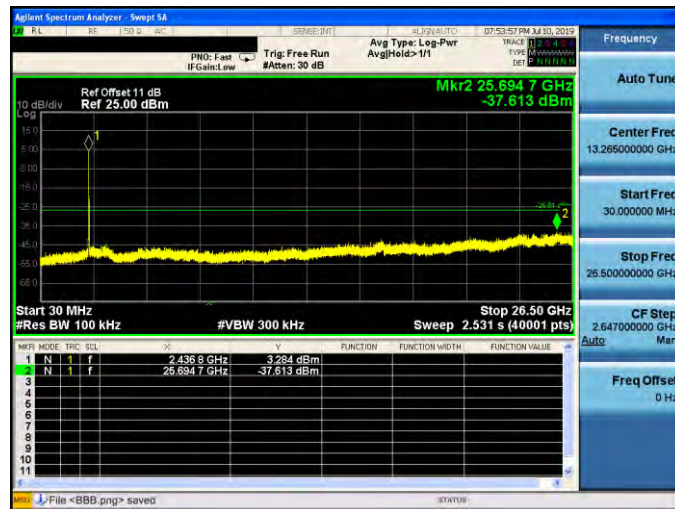

2462 MHz

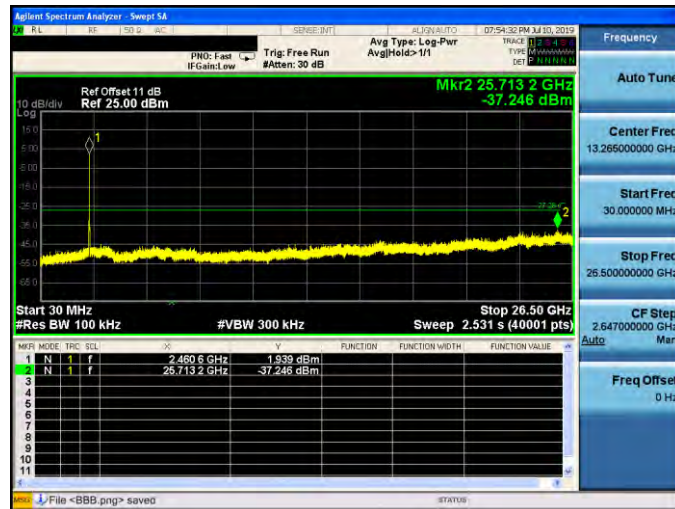



Mode 5: IEEE 802.11n 2.4 GHz 40 MHz Continuous TX mode

2422 MHz

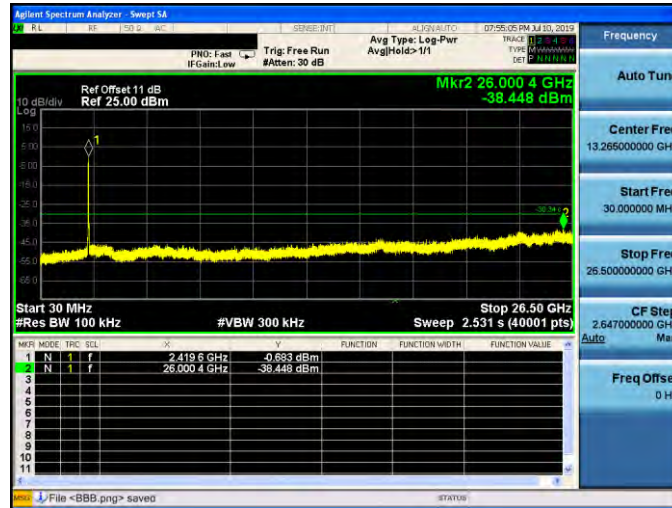

2437 MHz

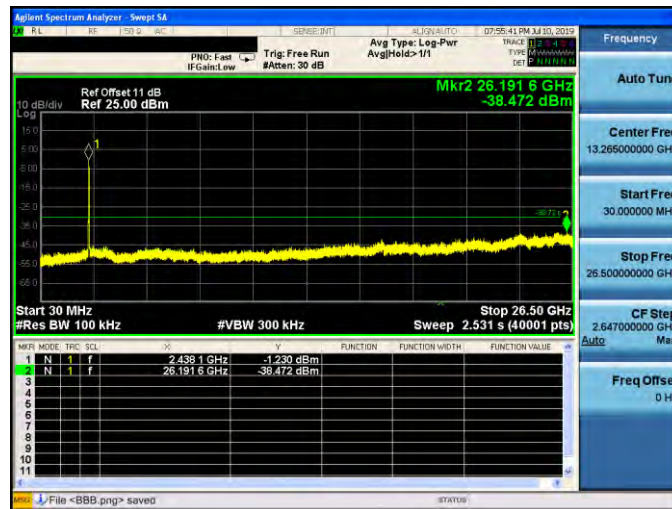

2452 MHz

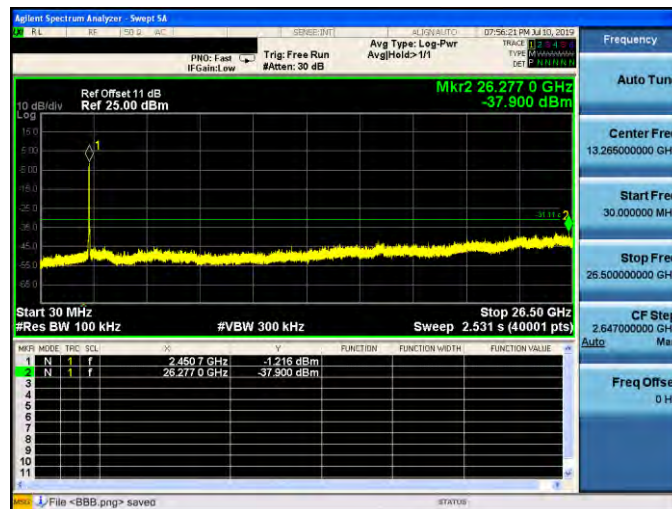

Conducted Band Edge

Mode 2: IEEE 802.11b Continuous TX mode

2412 MHz

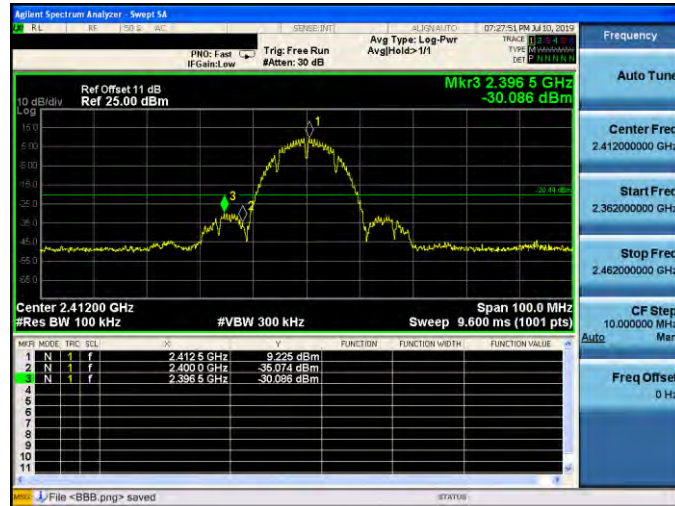

2462 MHz

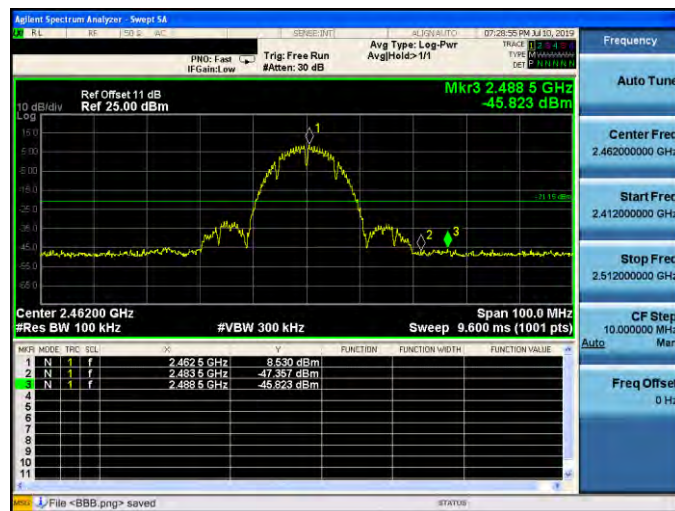



Mode 3: IEEE 802.11g Continuous TX mode

2412 MHz

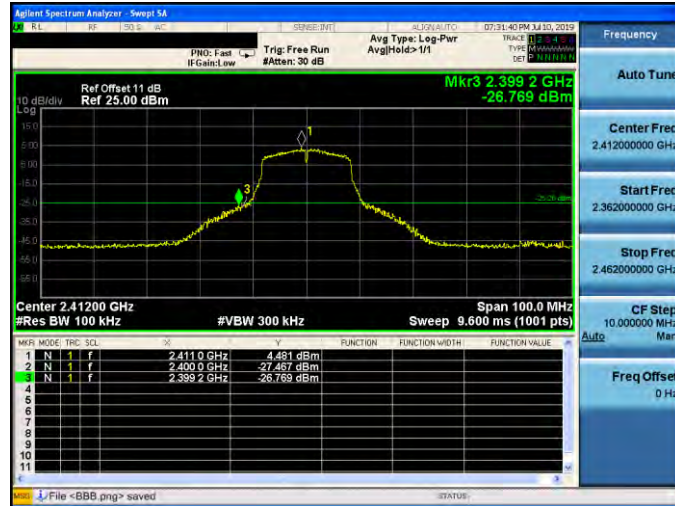

2462 MHz

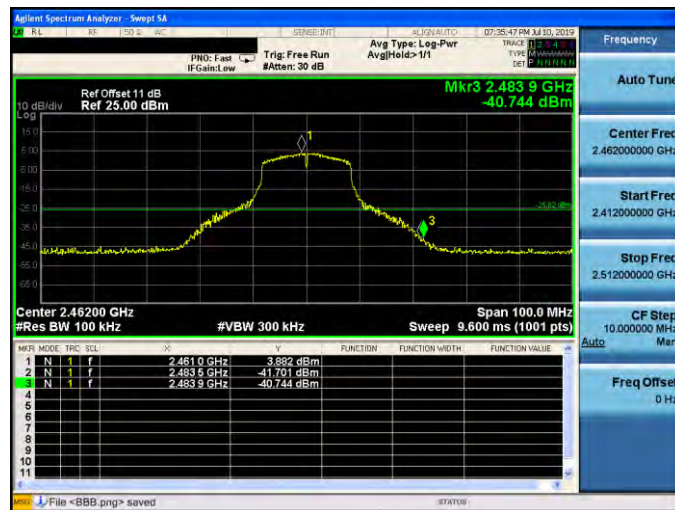

Mode 4: IEEE 802.11n 2.4 GHz 20 MHz Continuous TX mode

2412 MHz

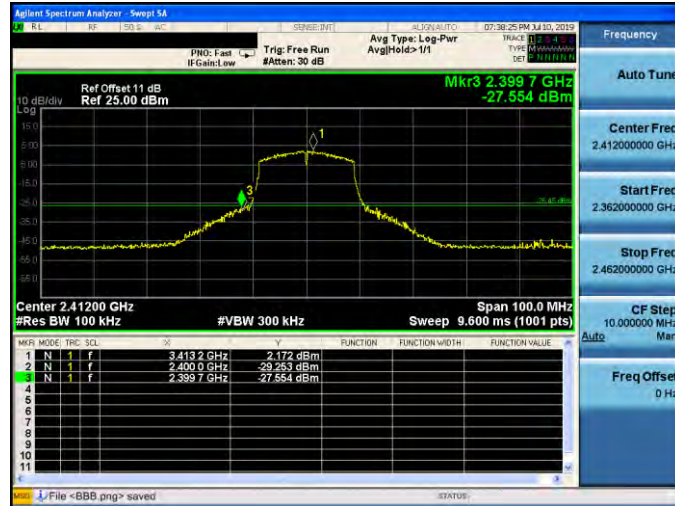

2462 MHz

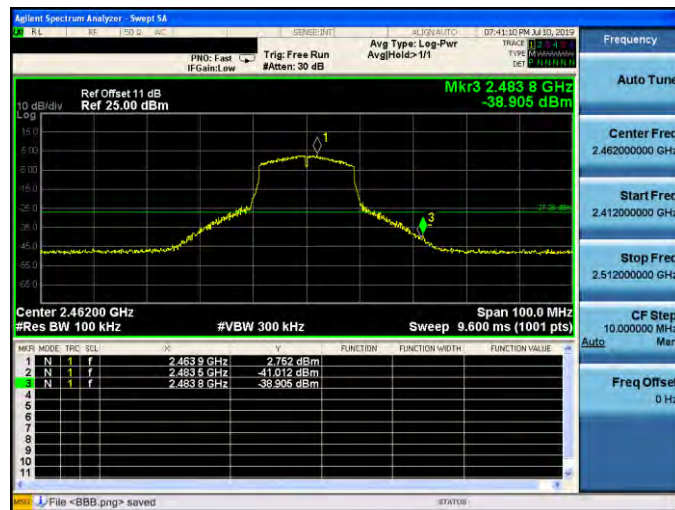

Mode 5: IEEE 802.11n 2.4 GHz 40 MHz Continuous TX mode

2422 MHz

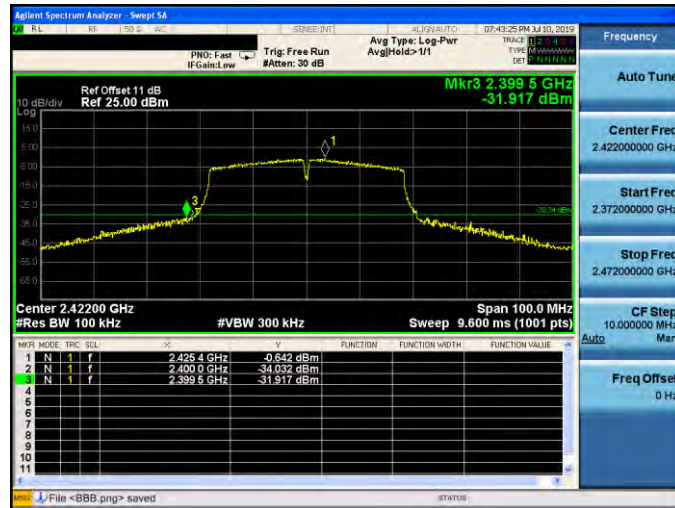

2452 MHz

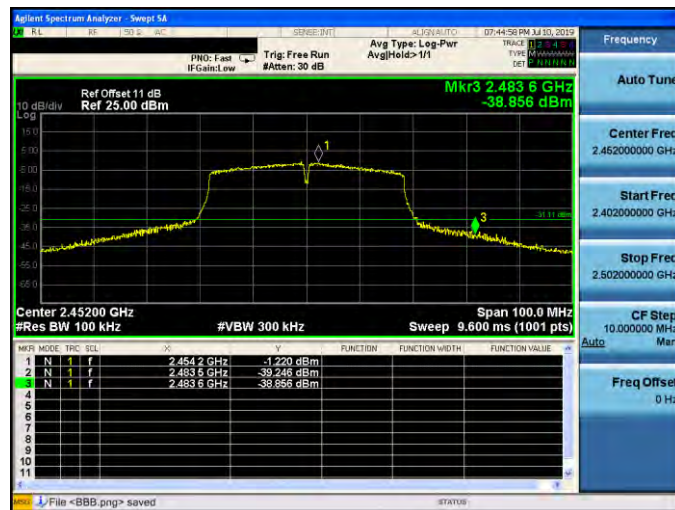

Annex C. Radiated Emission Test Results

Harmonic

Below 1 GHz

Standard:	FCC Part 15.247	Test Distance:	3 m
Test item:	Harmonic	Power:	AC 120 V/60 Hz
Frequency:	2412 MHz	Temp.(°C)/Hum.(%RH):	26(°C)/60 %RH
Test Mode:	Mode 1		

Frequency (MHz)	Reading (dBuV)	Correct Factor (dB/m)	Result (dBuV/m)	Limit (dBuV/m)	Margin (dB)	Remark	Ant.Polar. H / V
78.5000	49.72	-10.68	39.04	40.00	-0.96	QP	H
90.1400	47.75	-12.29	35.46	43.50	-8.04	QP	H
180.3500	46.10	-7.01	39.09	43.50	-4.41	QP	H
240.4900	49.69	-6.39	43.30	46.00	-2.70	QP	H
252.1300	48.76	-6.07	42.69	46.00	-3.31	QP	H
642.0700	39.17	2.72	41.89	46.00	-4.11	QP	H
72.6800	44.63	-9.29	35.34	40.00	-4.66	QP	V
133.7900	38.34	-7.08	31.26	43.50	-12.24	QP	V
232.7300	37.47	-7.02	30.45	46.00	-15.55	QP	V
419.9400	35.68	-1.73	33.95	46.00	-12.05	QP	V
485.9000	39.50	-0.51	38.99	46.00	-7.01	QP	V
631.4000	35.35	2.59	37.94	46.00	-8.06	QP	V

Note:1.Result (dBuV/m) = Correct Factor (dB/m) + Reading(dBuV).

Example: 39.04 = -10.68 + 49.72

2.Correction factor (dB/m) = Antenna Factor (dB/m) + Cable loss (dB) – Pre-Amplifier gain (dB).

3.When the peak results are less than average limit, so not need to evaluate the average.



Above 1 GHz

Standard:	FCC Part 15.247	Test Distance:	3 m
Test item:	Harmonic	Power:	AC 120 V/60 Hz
Frequency:	2412 MHz	Temp.(°C)/Hum.(%RH):	26(°C)/60 %RH
Mode:	Mode 2		
Ant.Polar.:	Horizontal		

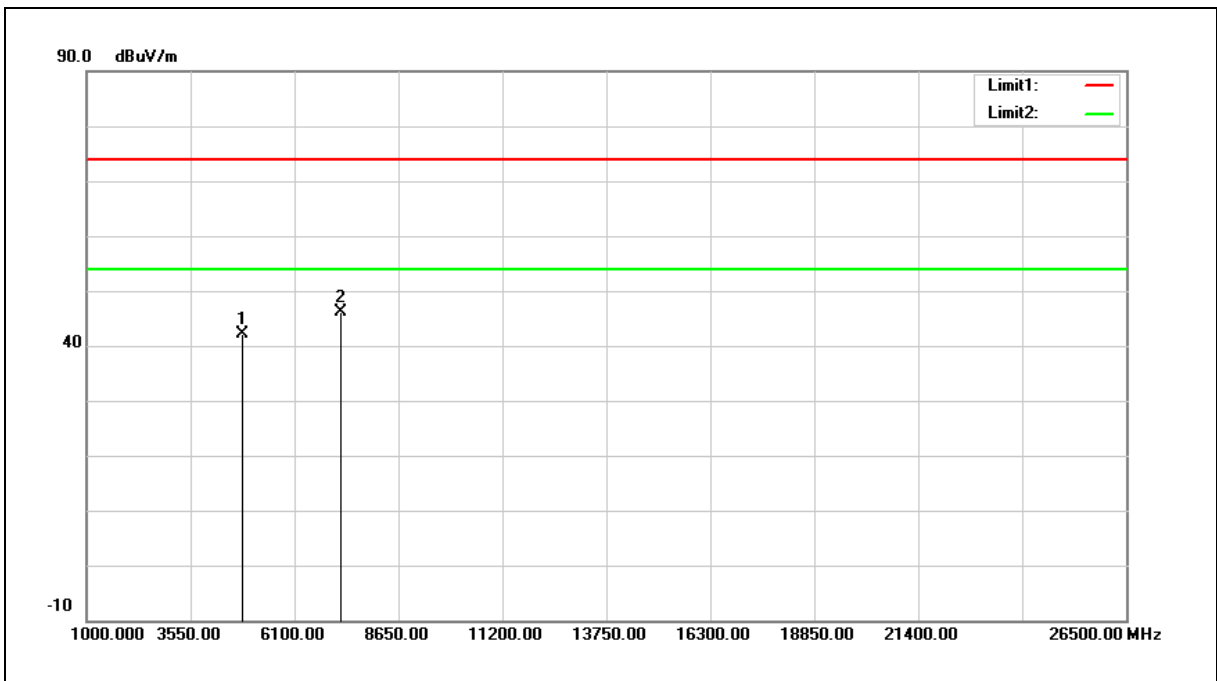

No.	Frequency (MHz)	Reading (dBuV)	Correct Factor (dB/m)	Result (dBuV/m)	Limit (dBuV/m)	Margin (dB)	Remark
1	4824.000	36.45	5.57	42.02	74.00	-31.98	peak
2	7236.000	34.03	11.98	46.01	74.00	-27.99	peak

Note:1.Result (dBuV/m) = Correct Factor (dB/m) + Reading(dBuV).

Example: 42.02 = 5.57 + 36.45

2.Correction factor (dB/m) = Antenna Factor (dB/m) + Cable loss (dB) – Pre-Amplifier gain (dB).

3. When the peak results are less than average limit, so not need to evaluate the average.



Standard:	FCC Part 15.247	Test Distance:	3 m
Test item:	Harmonic	Power:	AC 120 V/60 Hz
Frequency:	2412 MHz	Temp.(°C)/Hum.(%RH):	26(°C)/60 %RH
Mode:	Mode 2		
Ant.Polar.:	Vertical		

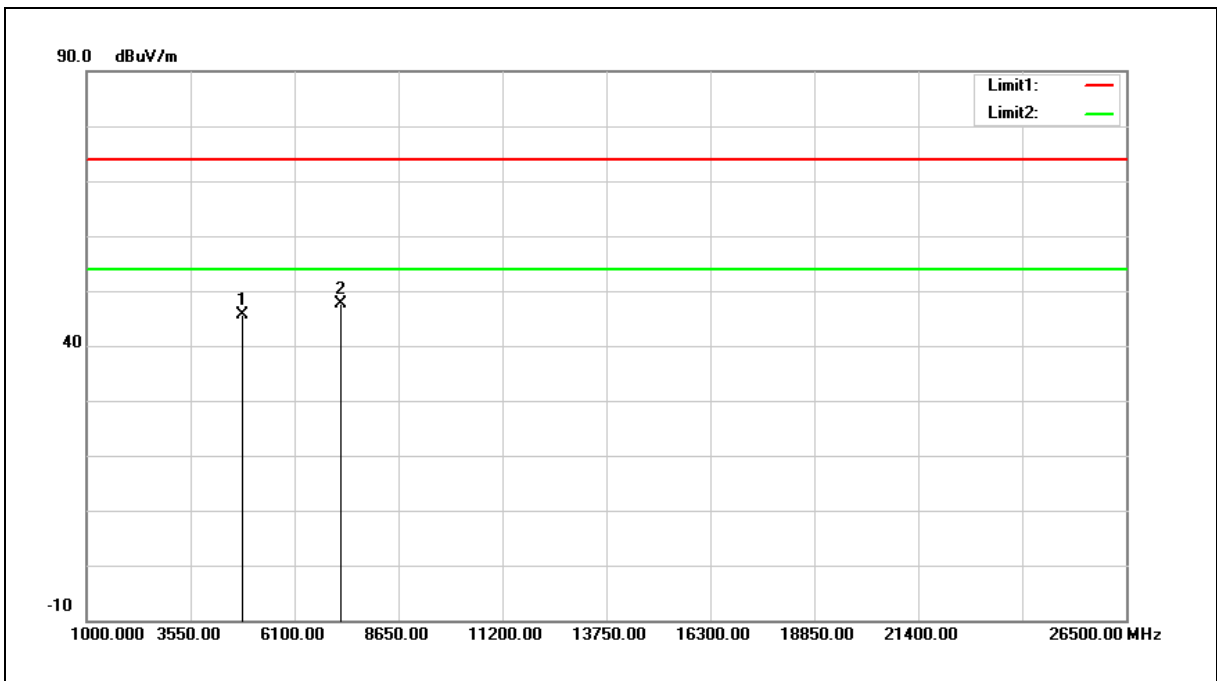

No.	Frequency (MHz)	Reading (dBuV)	Correct Factor (dB/m)	Result (dBuV/m)	Limit (dBuV/m)	Margin (dB)	Remark
1	4824.000	40.17	5.57	45.74	74.00	-28.26	peak
2	7236.000	35.68	11.98	47.66	74.00	-26.34	peak

Note:1.Result (dBuV/m) = Correct Factor (dB/m) + Reading(dBuV).

Example: 45.75 = 5.57 + 40.17

2.Correction factor (dB/m) = Antenna Factor (dB/m) + Cable loss (dB) – Pre-Amplifier gain (dB).

3. When the peak results are less than average limit, so not need to evaluate the average.



Standard:	FCC Part 15.247	Test Distance:	3 m
Test item:	Harmonic	Power:	AC 120 V/60 Hz
Frequency:	2437 MHz	Temp.(°C)/Hum.(%RH):	26(°C)/60 %RH
Mode:	Mode 2		
Ant.Polar.:	Horizontal		

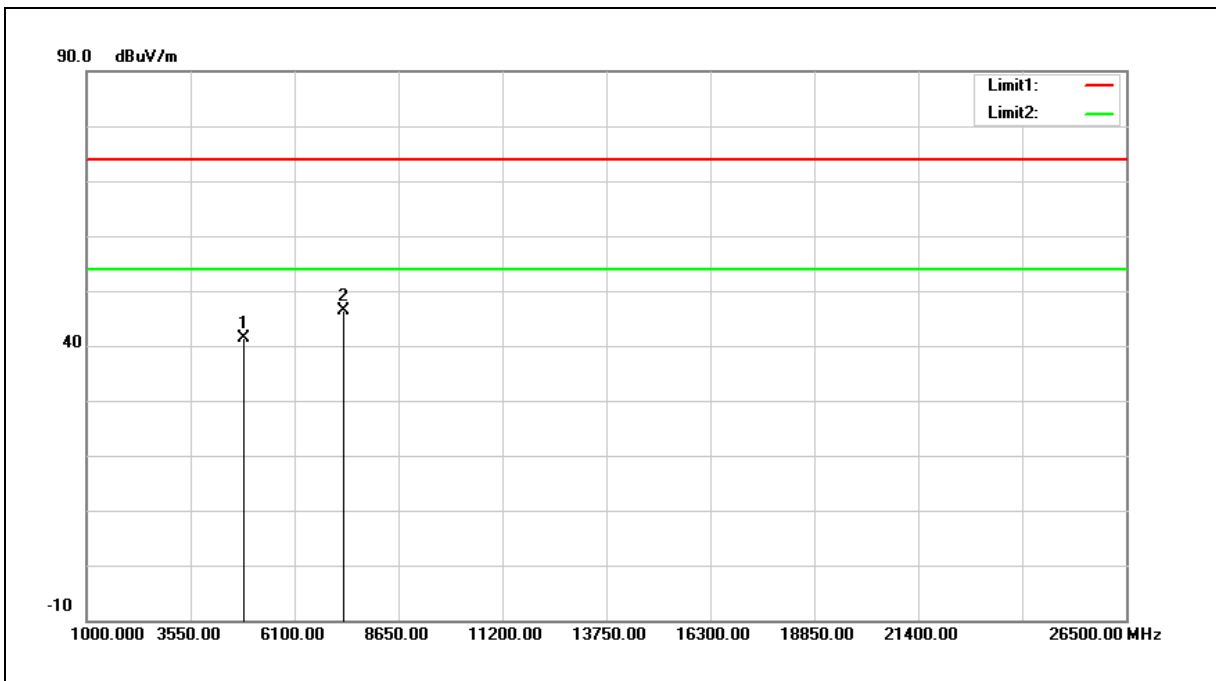

No.	Frequency (MHz)	Reading (dBuV)	Correct Factor (dB/m)	Result (dBuV/m)	Limit (dBuV/m)	Margin (dB)	Remark
1	4874.000	35.59	5.67	41.26	74.00	-32.74	peak
2	7311.000	34.31	12.15	46.46	74.00	-27.54	peak

Note:1.Result (dBuV/m) = Correct Factor (dB/m) + Reading(dBuV).

2.Correction factor (dB/m) = Antenna Factor (dB/m) + Cable loss (dB) – Pre-Amplifier gain (dB).

3. When the peak results are less than average limit, so not need to evaluate the average.



Standard:	FCC Part 15.247	Test Distance:	3 m
Test item:	Harmonic	Power:	AC 120 V/60 Hz
Frequency:	2437 MHz	Temp.(°C)/Hum.(%RH):	26(°C)/60 %RH
Mode:	Mode 2		
Ant.Polar.:	Vertical		

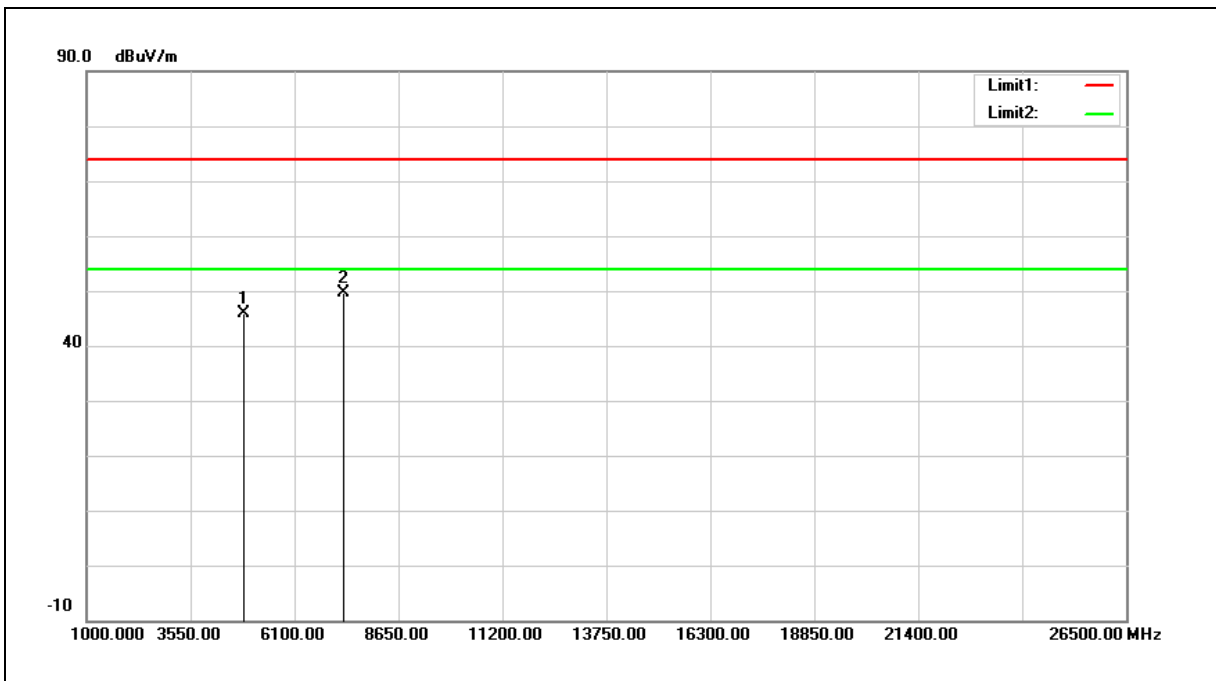

No.	Frequency (MHz)	Reading (dBuV)	Correct Factor (dB/m)	Result (dBuV/m)	Limit (dBuV/m)	Margin (dB)	Remark
1	4874.000	40.20	5.67	45.87	74.00	-28.13	peak
2	7311.000	37.50	12.15	49.65	74.00	-24.35	peak

Note:1.Result (dBuV/m) = Correct Factor (dB/m) + Reading(dBuV).

2.Correction factor (dB/m) = Antenna Factor (dB/m) + Cable loss (dB) – Pre-Amplifier gain (dB).

3. When the peak results are less than average limit, so not need to evaluate the average.



Standard:	FCC Part 15.247	Test Distance:	3 m
Test item:	Harmonic	Power:	AC 120 V/60 Hz
Frequency:	2462 MHz	Temp.(°C)/Hum.(%RH):	26(°C)/60 %RH
Mode:	Mode 2		
Ant.Polar.:	Horizontal		

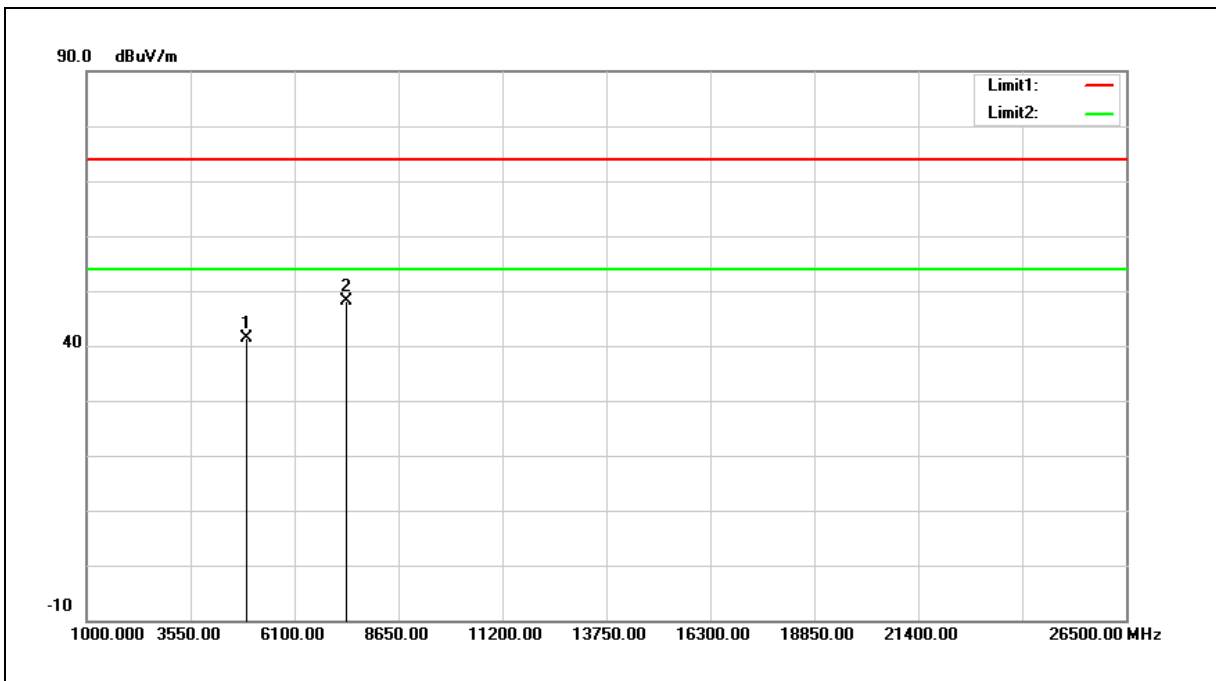

No.	Frequency (MHz)	Reading (dBuV)	Correct Factor (dB/m)	Result (dBuV/m)	Limit (dBuV/m)	Margin (dB)	Remark
1	4924.000	35.63	5.77	41.40	74.00	-32.60	peak
2	7386.000	35.68	12.33	48.01	74.00	-25.99	peak

- Note:1.Result (dBuV/m) = Correct Factor (dB/m) + Reading(dBuV).
 2.Correction factor (dB/m) = Antenna Factor (dB/m) + Cable loss (dB) – Pre-Amplifier gain (dB).
 3. When the peak results are less than average limit, so not need to evaluate the average.



Standard:	FCC Part 15.247	Test Distance:	3 m
Test item:	Harmonic	Power:	AC 120 V/60 Hz
Frequency:	2462 MHz	Temp.(°C)/Hum.(%RH):	26(°C)/60 %RH
Mode:	Mode 2		
Ant.Polar.:	Vertical		

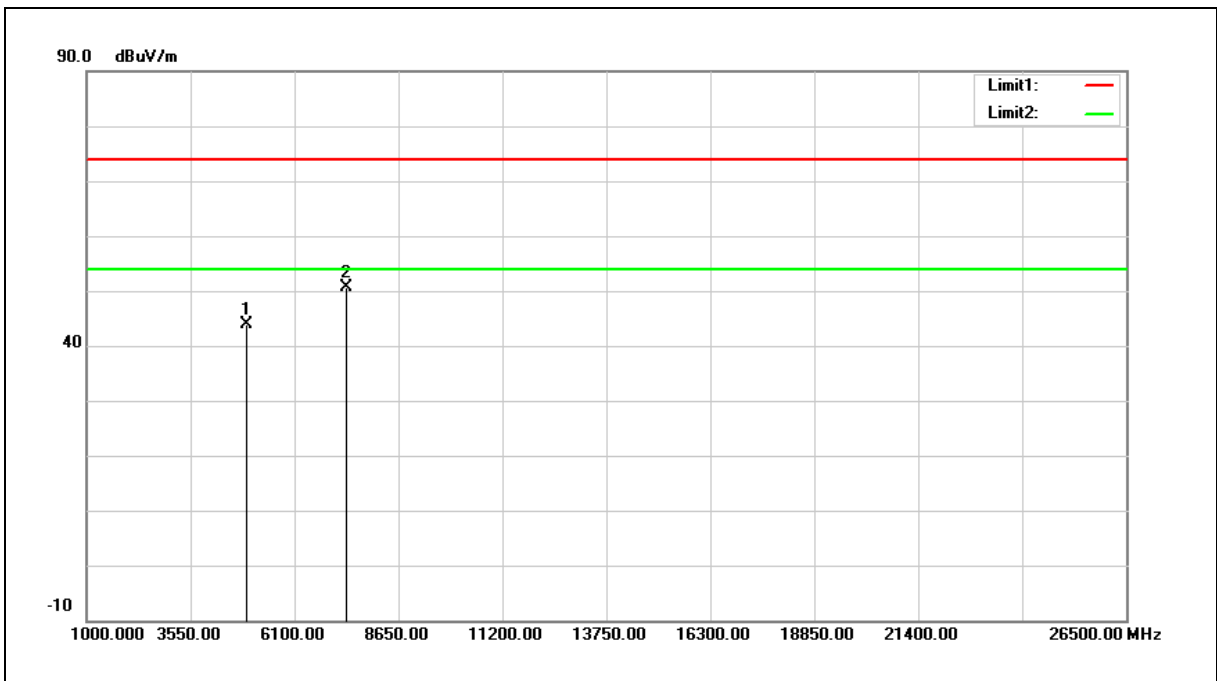

No.	Frequency (MHz)	Reading (dBuV)	Correct Factor (dB/m)	Result (dBuV/m)	Limit (dBuV/m)	Margin (dB)	Remark
1	4924.000	38.02	5.77	43.79	74.00	-30.21	peak
2	7386.000	38.37	12.33	50.70	74.00	-23.30	peak

Note:1.Result (dBuV/m) = Correct Factor (dB/m) + Reading(dBuV).

2.Correction factor (dB/m) = Antenna Factor (dB/m) + Cable loss (dB) – Pre-Amplifier gain (dB).

3. When the peak results are less than average limit, so not need to evaluate the average.



Standard:	FCC Part 15.247	Test Distance:	3 m
Test item:	Harmonic	Power:	AC 120 V/60 Hz
Frequency:	2412 MHz	Temp.(°C)/Hum.(%RH):	26(°C)/60 %RH
Mode:	Mode 3		
Ant.Polar.:	Horizontal		

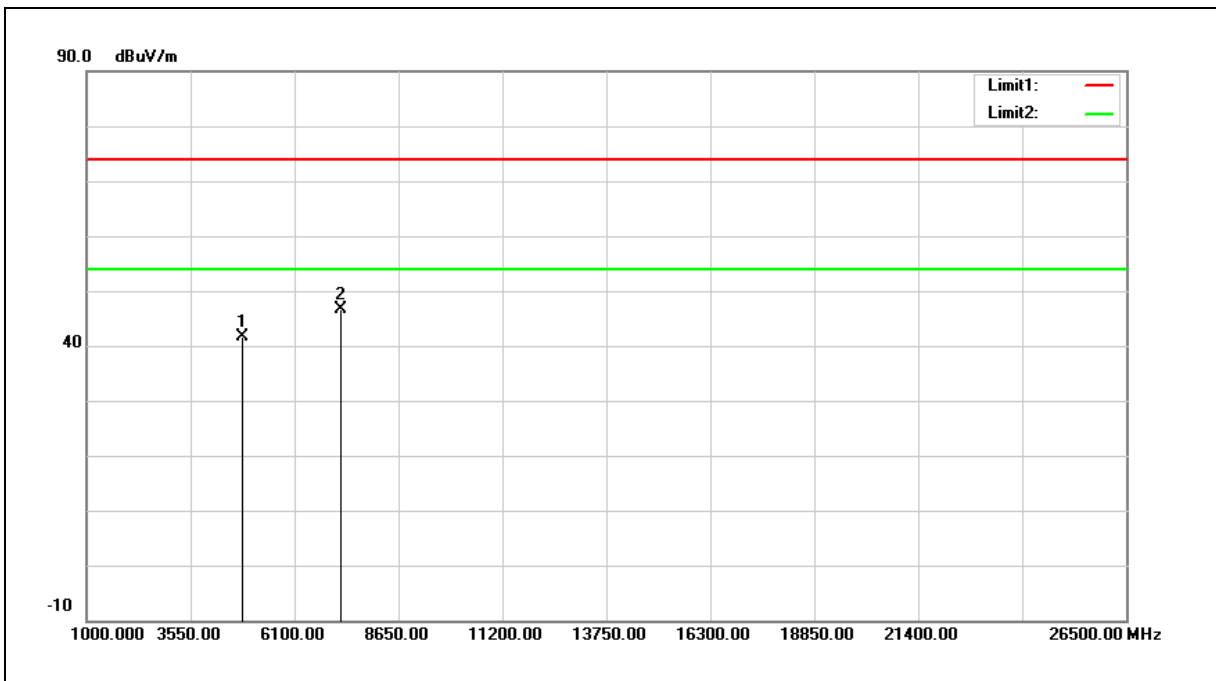

No.	Frequency (MHz)	Reading (dBuV)	Correct Factor (dB/m)	Result (dBuV/m)	Limit (dBuV/m)	Margin (dB)	Remark
1	4824.000	35.95	5.57	41.52	74.00	-32.48	peak
2	7236.000	34.55	11.98	46.53	74.00	-27.47	peak

- Note:1.Result (dBuV/m) = Correct Factor (dB/m) + Reading(dBuV).
 2.Correction factor (dB/m) = Antenna Factor (dB/m) + Cable loss (dB) – Pre-Amplifier gain (dB).
 3. When the peak results are less than average limit, so not need to evaluate the average.



Standard:	FCC Part 15.247	Test Distance:	3 m
Test item:	Harmonic	Power:	AC 120 V/60 Hz
Frequency:	2412 MHz	Temp.(°C)/Hum.(%RH):	26(°C)/60 %RH
Mode:	Mode 3		
Ant.Polar.:	Vertical		

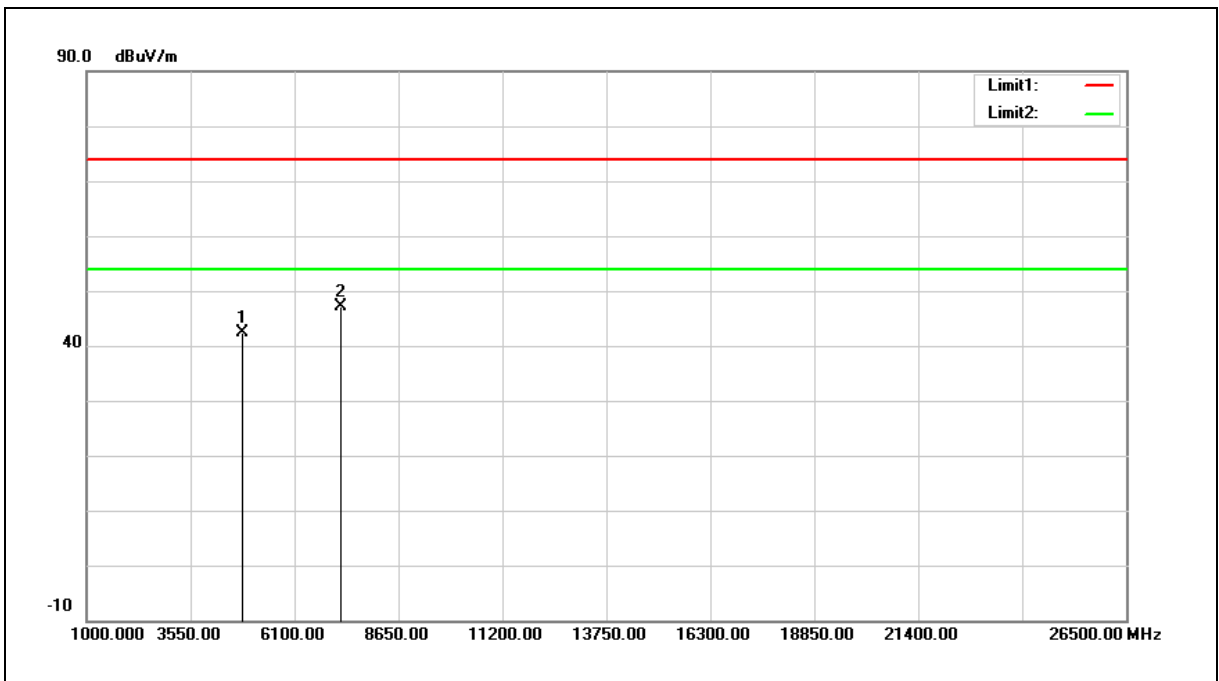

No.	Frequency (MHz)	Reading (dBuV)	Correct Factor (dB/m)	Result (dBuV/m)	Limit (dBuV/m)	Margin (dB)	Remark
1	4824.000	36.90	5.57	42.47	74.00	-31.53	peak
2	7236.000	35.21	11.98	47.19	74.00	-26.81	peak

Note:1.Result (dBuV/m) = Correct Factor (dB/m) + Reading(dBuV).

2.Correction factor (dB/m) = Antenna Factor (dB/m) + Cable loss (dB) – Pre-Amplifier gain (dB).

3. When the peak results are less than average limit, so not need to evaluate the average.



Standard:	FCC Part 15.247	Test Distance:	3 m
Test item:	Harmonic	Power:	AC 120 V/60 Hz
Frequency:	2437 MHz	Temp.(°C)/Hum.(%RH):	26(°C)/60 %RH
Mode:	Mode 3		
Ant.Polar.:	Horizontal		

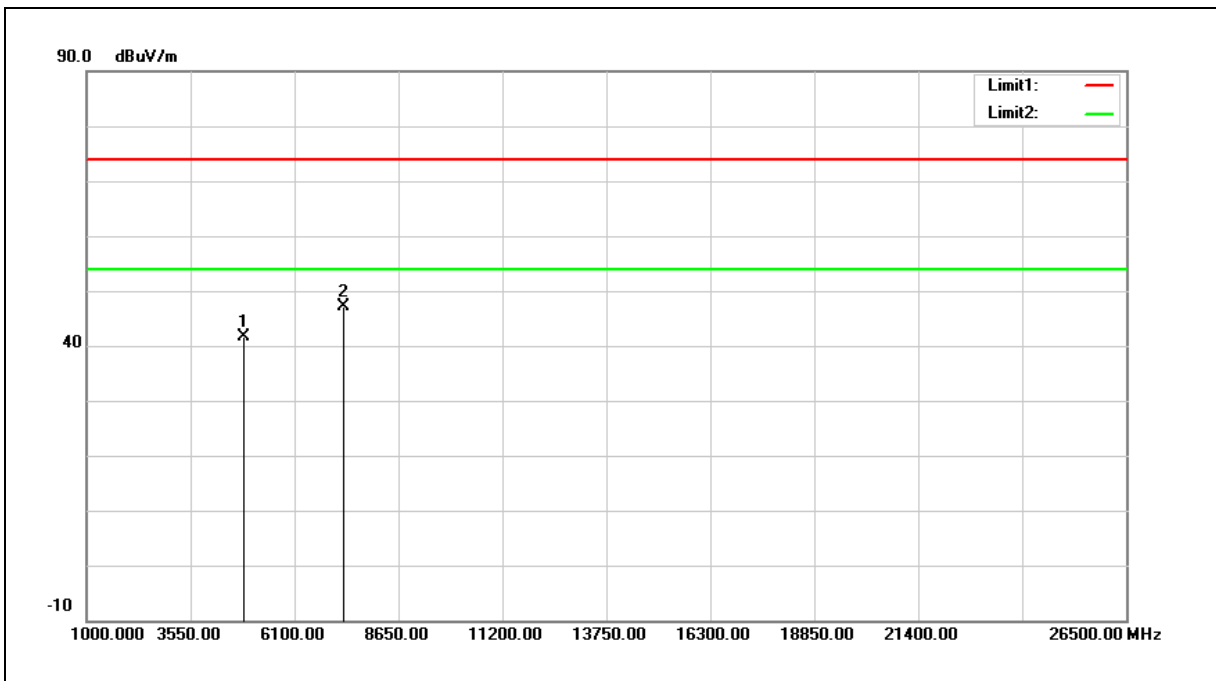

No.	Frequency (MHz)	Reading (dBuV)	Correct Factor (dB/m)	Result (dBuV/m)	Limit (dBuV/m)	Margin (dB)	Remark
1	4874.000	35.92	5.67	41.59	74.00	-32.41	peak
2	7311.000	34.99	12.15	47.14	74.00	-26.86	peak

- Note:1.Result (dBuV/m) = Correct Factor (dB/m) + Reading(dBuV).
 2.Correction factor (dB/m) = Antenna Factor (dB/m) + Cable loss (dB) – Pre-Amplifier gain (dB).
 3. When the peak results are less than average limit, so not need to evaluate the average.



Standard:	FCC Part 15.247	Test Distance:	3 m
Test item:	Harmonic	Power:	AC 120 V/60 Hz
Frequency:	2437 MHz	Temp.(°C)/Hum.(%RH):	26(°C)/60 %RH
Mode:	Mode 3		
Ant.Polar.:	Vertical		

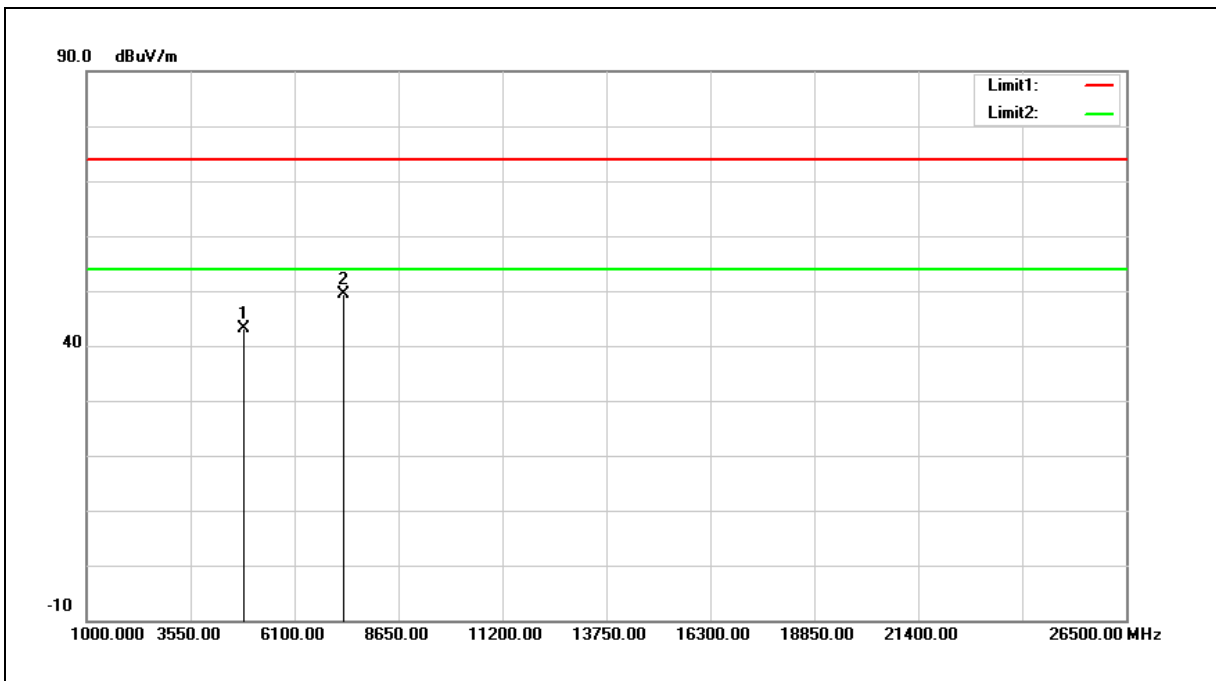

No.	Frequency (MHz)	Reading (dBuV)	Correct Factor (dB/m)	Result (dBuV/m)	Limit (dBuV/m)	Margin (dB)	Remark
1	4874.000	37.56	5.67	43.23	74.00	-30.77	peak
2	7311.000	37.26	12.15	49.41	74.00	-24.59	peak

- Note:1.Result (dBuV/m) = Correct Factor (dB/m) + Reading(dBuV).
 2.Correction factor (dB/m) = Antenna Factor (dB/m) + Cable loss (dB) – Pre-Amplifier gain (dB).
 3. When the peak results are less than average limit, so not need to evaluate the average.



Standard:	FCC Part 15.247	Test Distance:	3 m
Test item:	Harmonic	Power:	AC 120 V/60 Hz
Frequency:	2462 MHz	Temp.(°C)/Hum.(%RH):	26(°C)/60 %RH
Mode:	Mode 3		
Ant.Polar.:	Horizontal		

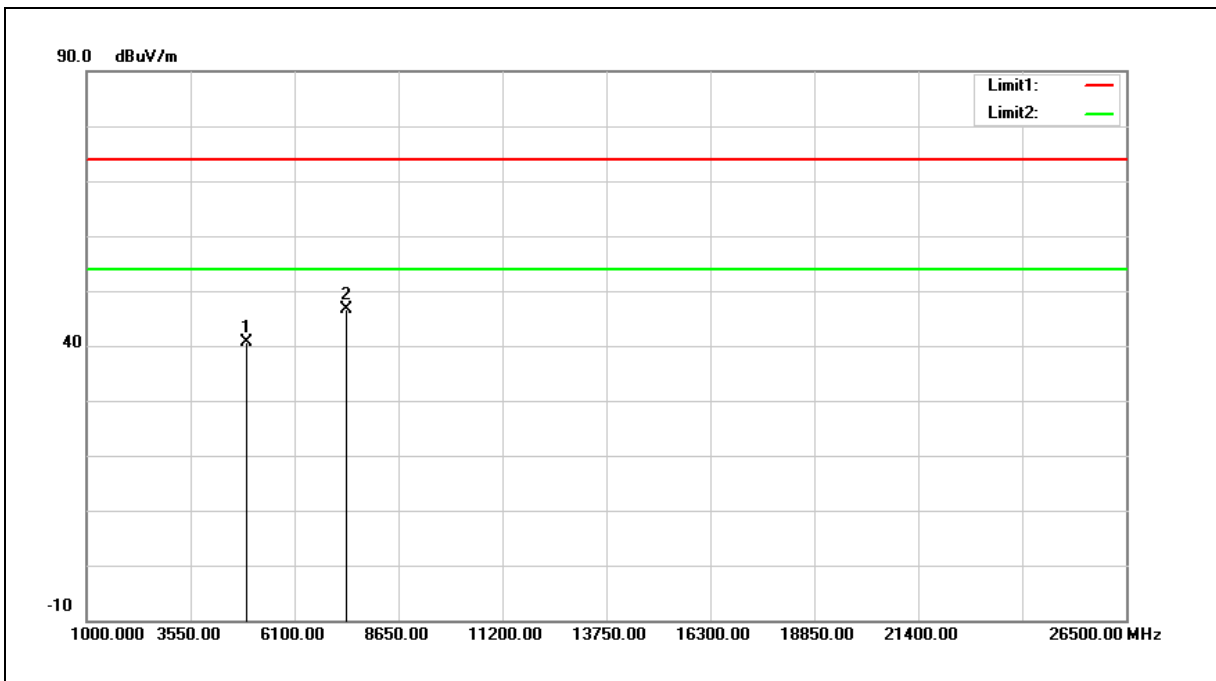

No.	Frequency (MHz)	Reading (dBuV)	Correct Factor (dB/m)	Result (dBuV/m)	Limit (dBuV/m)	Margin (dB)	Remark
1	4924.000	34.74	5.77	40.51	74.00	-33.49	peak
2	7386.000	34.29	12.33	46.62	74.00	-27.38	peak

- Note:1.Result (dBuV/m) = Correct Factor (dB/m) + Reading(dBuV).
 2.Correction factor (dB/m) = Antenna Factor (dB/m) + Cable loss (dB) – Pre-Amplifier gain (dB).
 3. When the peak results are less than average limit, so not need to evaluate the average.



Standard:	FCC Part 15.247	Test Distance:	3 m
Test item:	Harmonic	Power:	AC 120 V/60 Hz
Frequency:	2462 MHz	Temp.(°C)/Hum.(%RH):	26(°C)/60 %RH
Mode:	Mode 3		
Ant.Polar.:	Vertical		

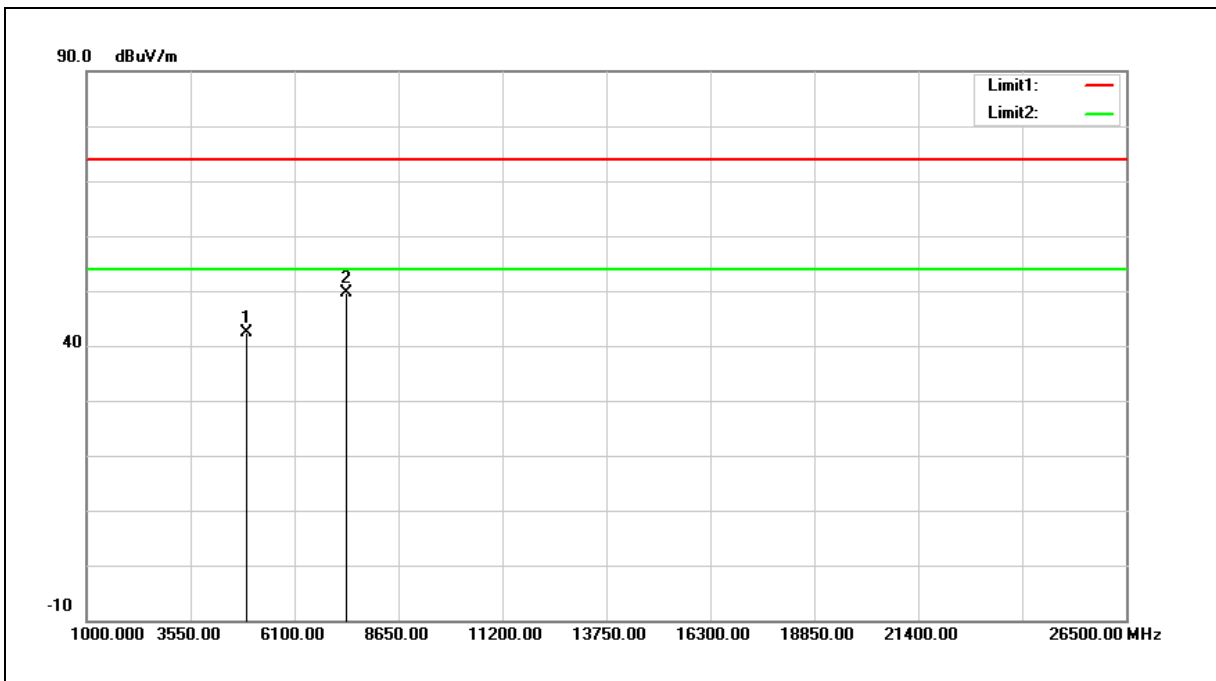

No.	Frequency (MHz)	Reading (dBuV)	Correct Factor (dB/m)	Result (dBuV/m)	Limit (dBuV/m)	Margin (dB)	Remark
1	4924.000	36.61	5.77	42.38	74.00	-31.62	peak
2	7386.000	37.19	12.33	49.52	74.00	-24.48	peak

Note:1.Result (dBuV/m) = Correct Factor (dB/m) + Reading(dBuV).

2.Correction factor (dB/m) = Antenna Factor (dB/m) + Cable loss (dB) – Pre-Amplifier gain (dB).

3. When the peak results are less than average limit, so not need to evaluate the average.



Standard:	FCC Part 15.247	Test Distance:	3 m
Test item:	Harmonic	Power:	AC 120 V/60 Hz
Frequency:	2412 MHz	Temp.(°C)/Hum.(%RH):	26(°C)/60 %RH
Mode:	Mode 4		
Ant.Polar.:	Horizontal		

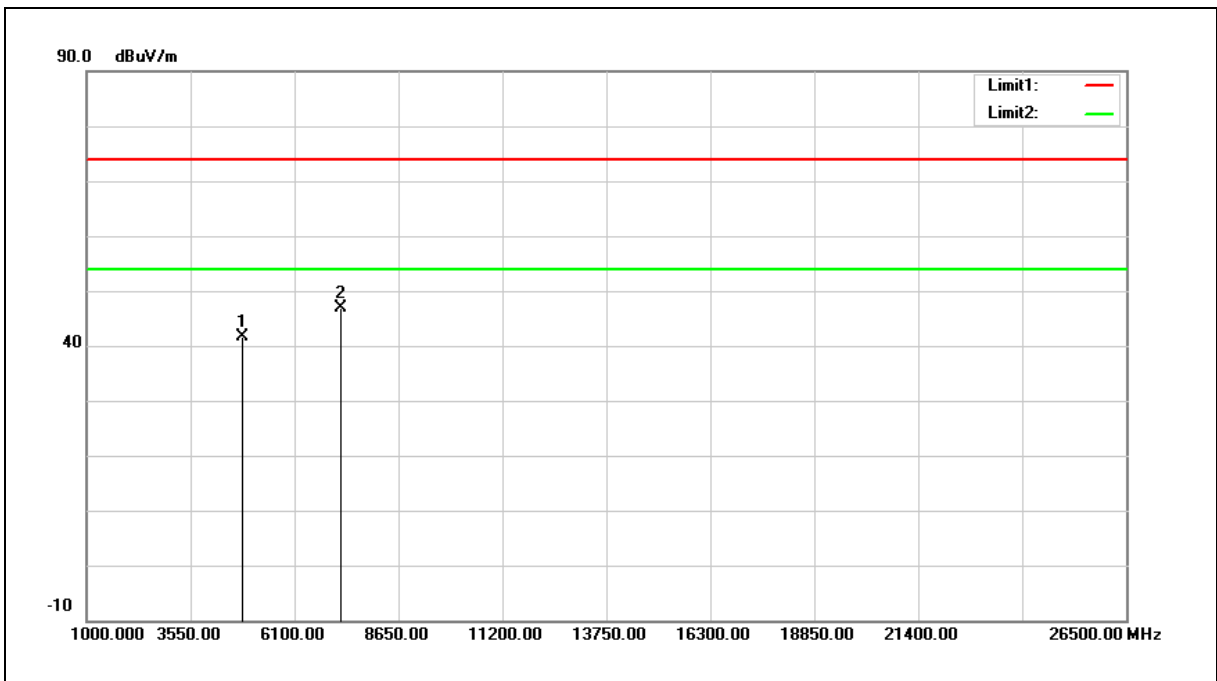

No.	Frequency (MHz)	Reading (dBuV)	Correct Factor (dB/m)	Result (dBuV/m)	Limit (dBuV/m)	Margin (dB)	Remark
1	4824.000	35.97	5.57	41.54	74.00	-32.46	peak
2	7236.000	34.88	11.98	46.86	74.00	-27.14	peak

Note:1.Result (dBuV/m) = Correct Factor (dB/m) + Reading(dBuV).

2.Correction factor (dB/m) = Antenna Factor (dB/m) + Cable loss (dB) – Pre-Amplifier gain (dB).

3. When the peak results are less than average limit, so not need to evaluate the average.



Standard:	FCC Part 15.247	Test Distance:	3 m
Test item:	Harmonic	Power:	AC 120 V/60 Hz
Frequency:	2412 MHz	Temp.(°C)/Hum.(%RH):	26(°C)/60 %RH
Mode:	Mode 4		
Ant.Polar.:	Vertical		

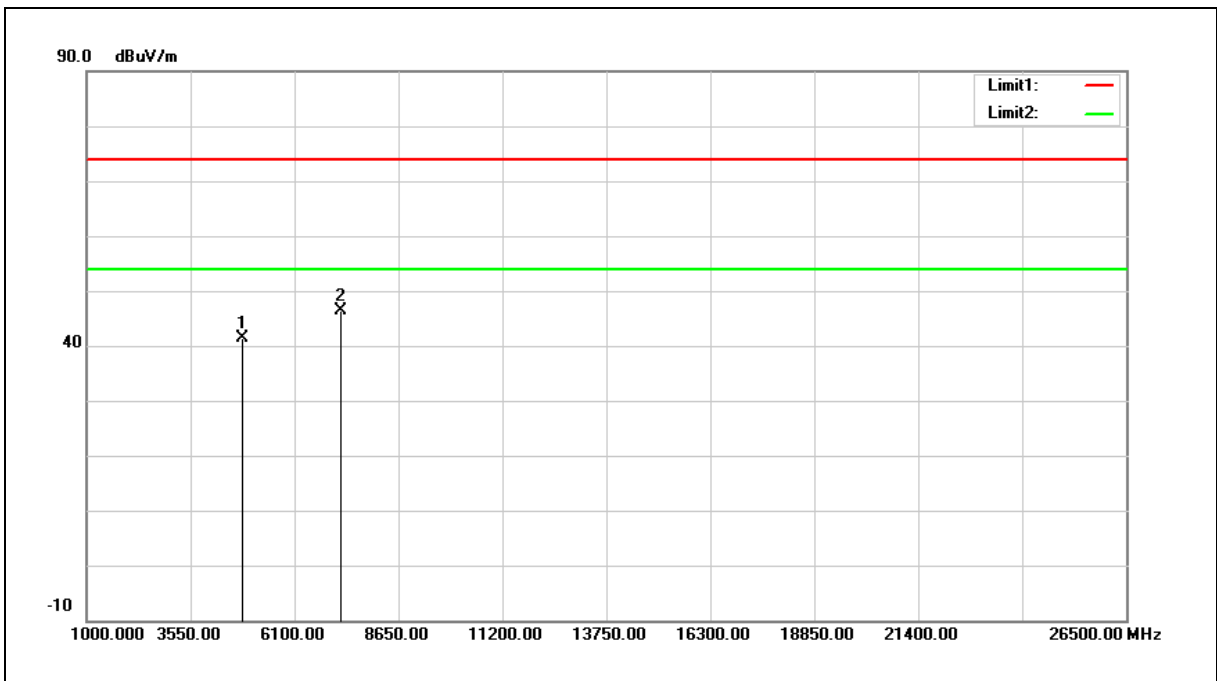

No.	Frequency (MHz)	Reading (dBuV)	Correct Factor (dB/m)	Result (dBuV/m)	Limit (dBuV/m)	Margin (dB)	Remark
1	4824.000	35.79	5.57	41.36	74.00	-32.64	peak
2	7236.000	34.52	11.98	46.50	74.00	-27.50	peak

Note:1.Result (dBuV/m) = Correct Factor (dB/m) + Reading(dBuV).

2.Correction factor (dB/m) = Antenna Factor (dB/m) + Cable loss (dB) – Pre-Amplifier gain (dB).

3. When the peak results are less than average limit, so not need to evaluate the average.



Standard:	FCC Part 15.247	Test Distance:	3 m
Test item:	Harmonic	Power:	AC 120 V/60 Hz
Frequency:	2437 MHz	Temp.(°C)/Hum.(%RH):	26(°C)/60 %RH
Mode:	Mode 4		
Ant.Polar.:	Horizontal		

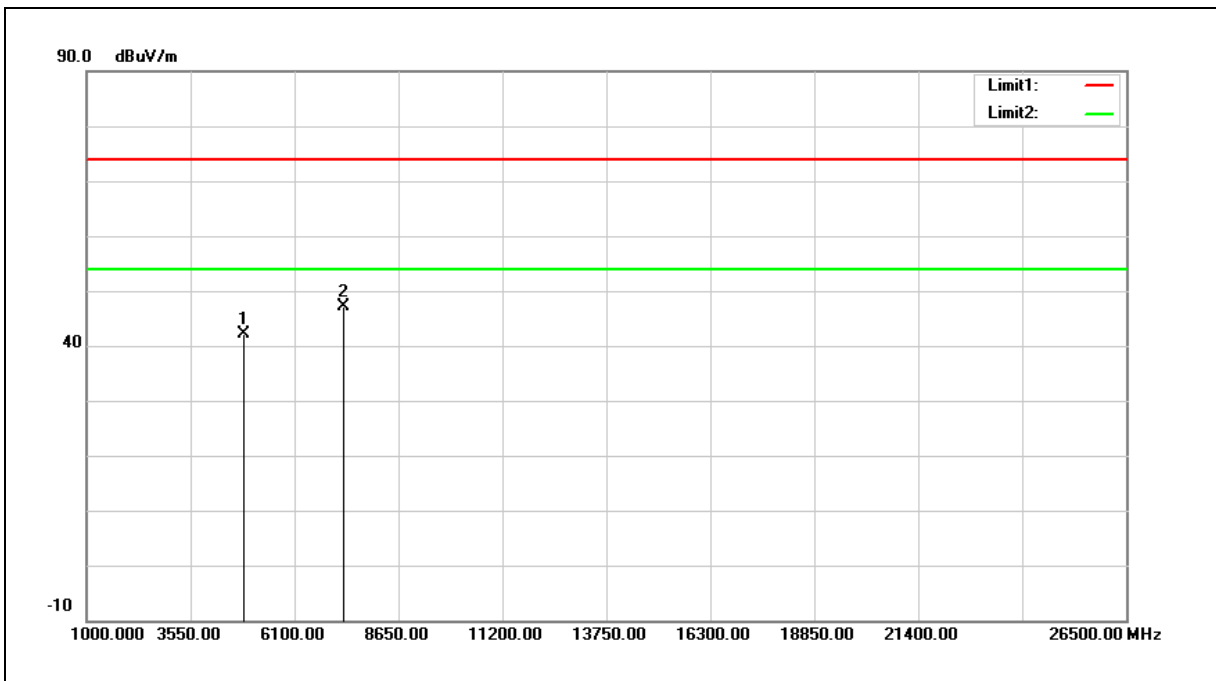

No.	Frequency (MHz)	Reading (dBuV)	Correct Factor (dB/m)	Result (dBuV/m)	Limit (dBuV/m)	Margin (dB)	Remark
1	4874.000	36.58	5.67	42.25	74.00	-31.75	peak
2	7311.000	34.95	12.15	47.10	74.00	-26.90	peak

Note:1.Result (dBuV/m) = Correct Factor (dB/m) + Reading(dBuV).

2.Correction factor (dB/m) = Antenna Factor (dB/m) + Cable loss (dB) – Pre-Amplifier gain (dB).

3. When the peak results are less than average limit, so not need to evaluate the average.



Standard:	FCC Part 15.247	Test Distance:	3 m
Test item:	Harmonic	Power:	AC 120 V/60 Hz
Frequency:	2437 MHz	Temp.(°C)/Hum.(%RH):	26(°C)/60 %RH
Mode:	Mode 4		
Ant.Polar.:	Vertical		

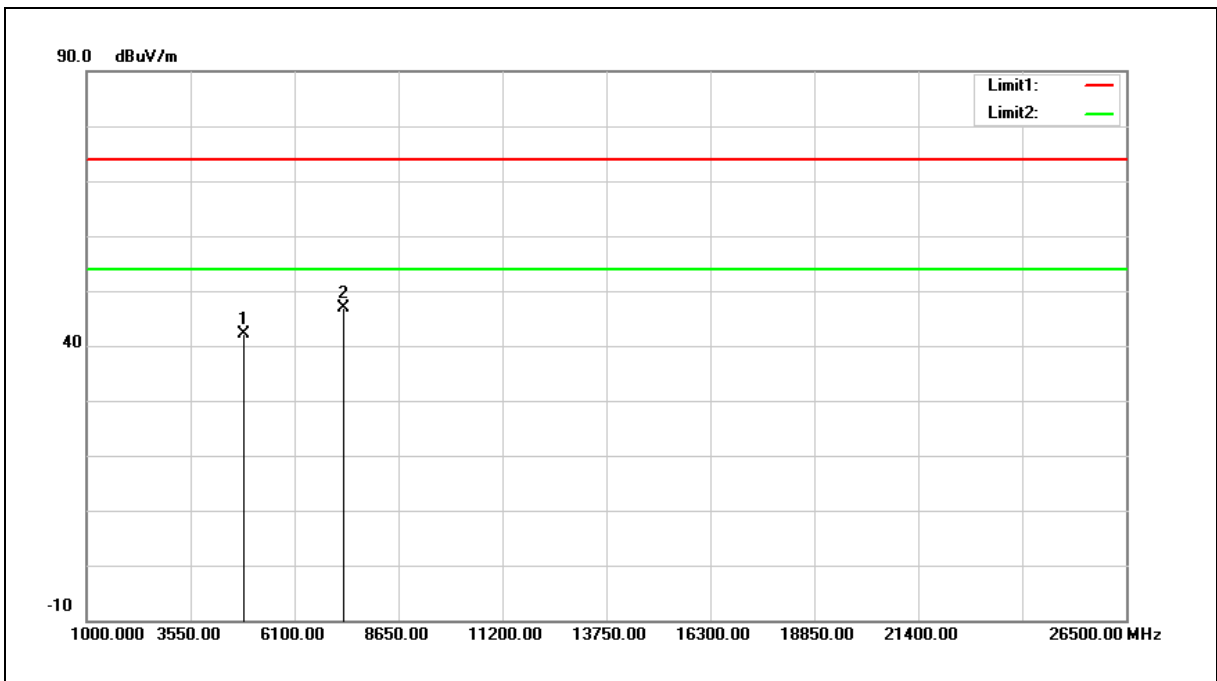

No.	Frequency (MHz)	Reading (dBuV)	Correct Factor (dB/m)	Result (dBuV/m)	Limit (dBuV/m)	Margin (dB)	Remark
1	4874.000	36.44	5.67	42.11	74.00	-31.89	peak
2	7311.000	34.84	12.15	46.99	74.00	-27.01	peak

Note:1.Result (dBuV/m) = Correct Factor (dB/m) + Reading(dBuV).

2.Correction factor (dB/m) = Antenna Factor (dB/m) + Cable loss (dB) – Pre-Amplifier gain (dB).

3. When the peak results are less than average limit, so not need to evaluate the average.



Standard:	FCC Part 15.247	Test Distance:	3 m
Test item:	Harmonic	Power:	AC 120 V/60 Hz
Frequency:	2462 MHz	Temp.(°C)/Hum.(%RH):	26(°C)/60 %RH
Mode:	Mode 4		
Ant.Polar.:	Horizontal		

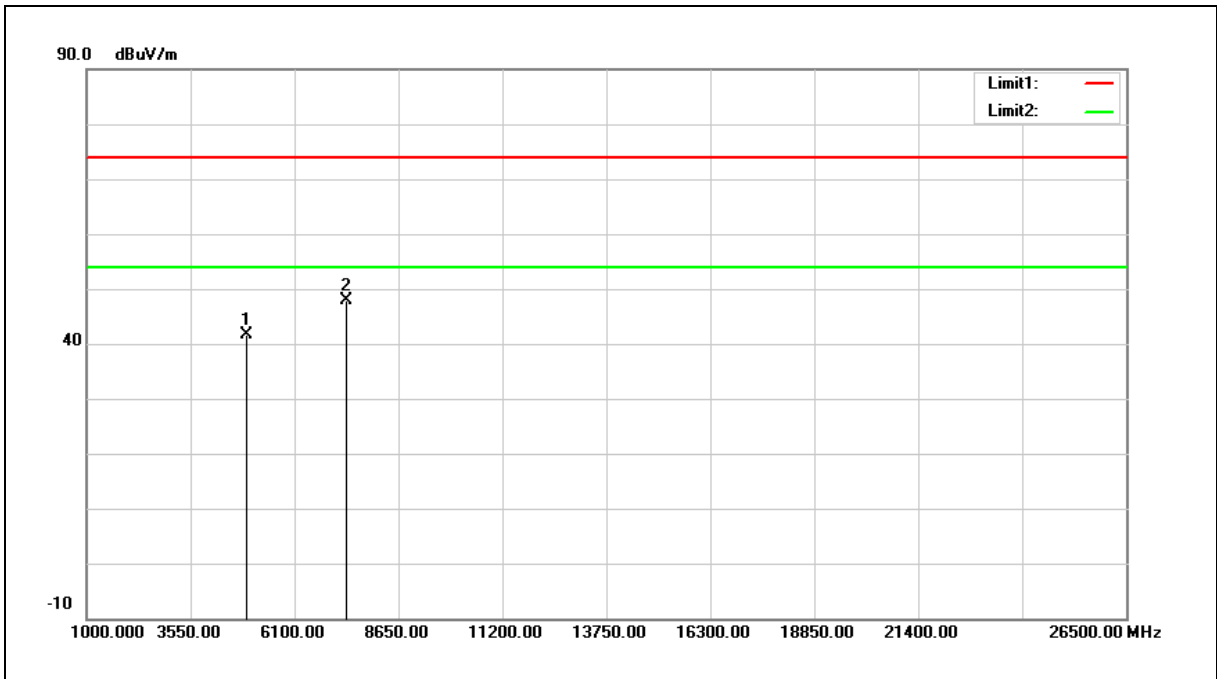

No.	Frequency (MHz)	Reading (dBuV)	Correct Factor (dB/m)	Result (dBuV/m)	Limit (dBuV/m)	Margin (dB)	Remark
1	4924.000	35.96	5.77	41.73	74.00	-32.27	peak
2	7386.000	35.63	12.33	47.96	74.00	-26.04	peak

Note:1.Result (dBuV/m) = Correct Factor (dB/m) + Reading(dBuV).

2.Correction factor (dB/m) = Antenna Factor (dB/m) + Cable loss (dB) – Pre-Amplifier gain (dB).

3. When the peak results are less than average limit, so not need to evaluate the average.



Standard:	FCC Part 15.247	Test Distance:	3 m
Test item:	Harmonic	Power:	AC 120 V/60 Hz
Frequency:	2462 MHz	Temp.(°C)/Hum.(%RH):	26(°C)/60 %RH
Mode:	Mode 4		
Ant.Polar.:	Vertical		

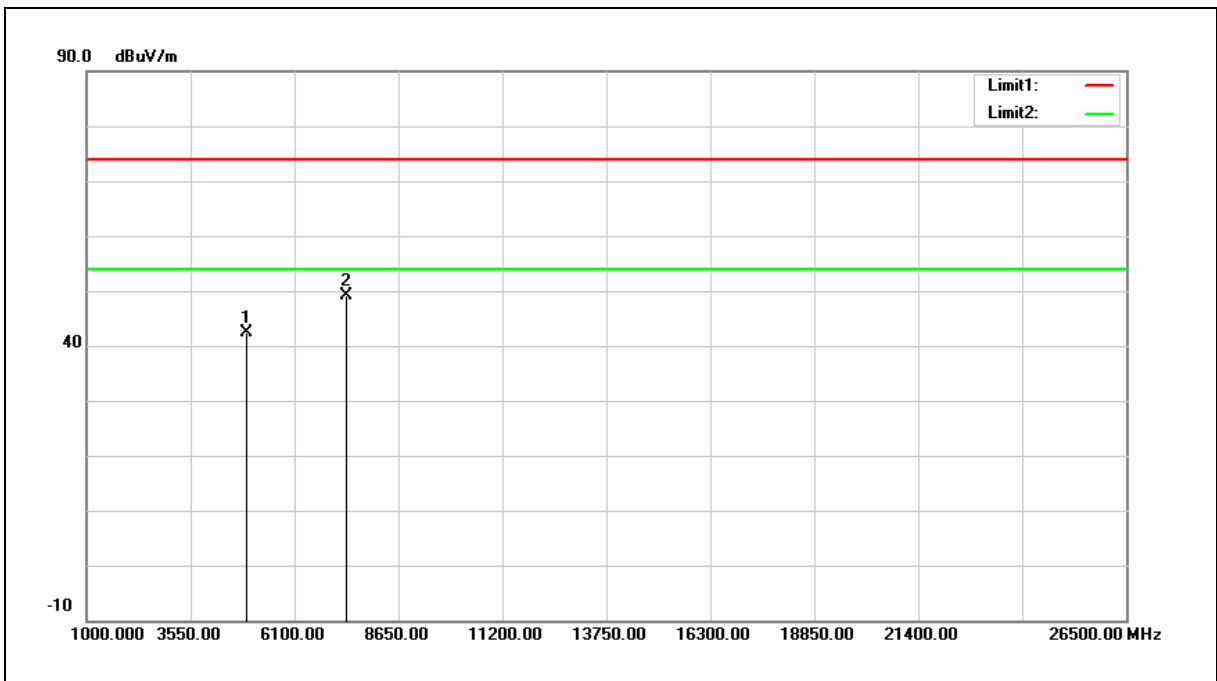

No.	Frequency (MHz)	Reading (dBuV)	Correct Factor (dB/m)	Result (dBuV/m)	Limit (dBuV/m)	Margin (dB)	Remark
1	4924.000	36.64	5.77	42.41	74.00	-31.59	peak
2	7386.000	36.89	12.33	49.22	74.00	-24.78	peak

Note:1.Result (dBuV/m) = Correct Factor (dB/m) + Reading(dBuV).

2.Correction factor (dB/m) = Antenna Factor (dB/m) + Cable loss (dB) – Pre-Amplifier gain (dB).

3. When the peak results are less than average limit, so not need to evaluate the average.



Standard:	FCC Part 15.247	Test Distance:	3 m
Test item:	Harmonic	Power:	AC 120 V/60 Hz
Frequency:	2422 MHz	Temp.(°C)/Hum.(%RH):	26(°C)/60 %RH
Mode:	Mode 5		
Ant.Polar.:	Horizontal		

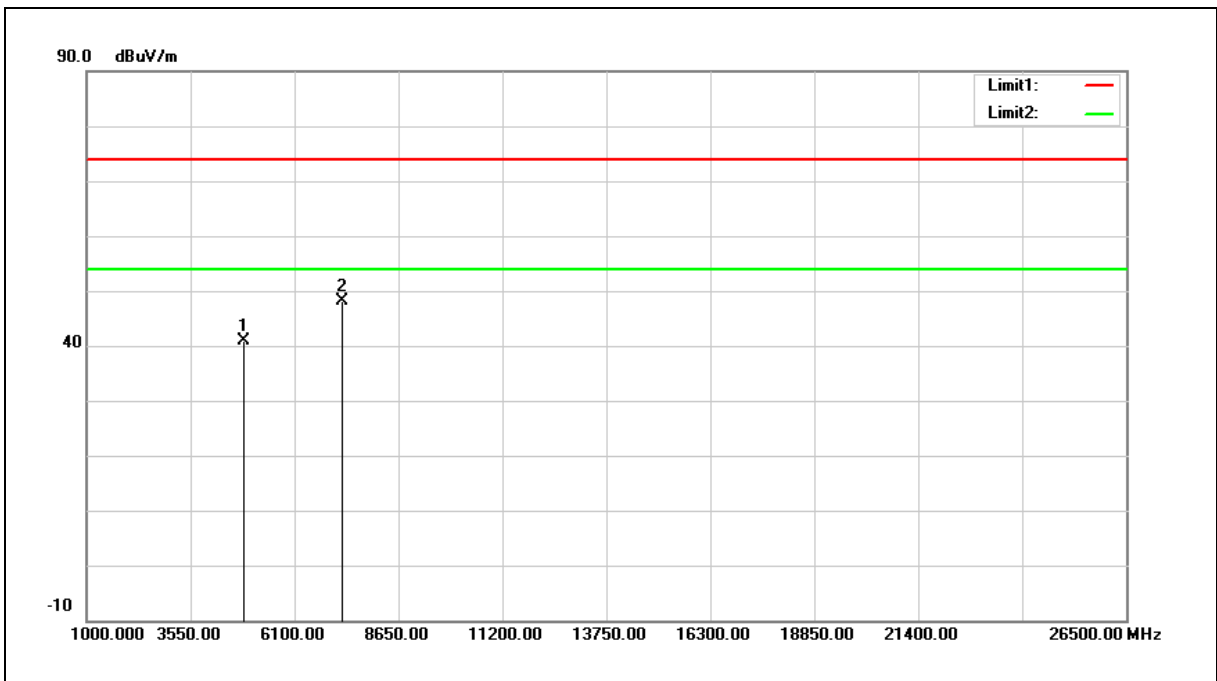

No.	Frequency (MHz)	Reading (dBuV)	Correct Factor (dB/m)	Result (dBuV/m)	Limit (dBuV/m)	Margin (dB)	Remark
1	4844.000	35.28	5.62	40.90	74.00	-33.10	peak
2	7266.000	36.01	12.04	48.05	74.00	-25.95	peak

Note:1.Result (dBuV/m) = Correct Factor (dB/m) + Reading(dBuV).

2.Correction factor (dB/m) = Antenna Factor (dB/m) + Cable loss (dB) – Pre-Amplifier gain (dB).

3. When the peak results are less than average limit, so not need to evaluate the average.



Standard:	FCC Part 15.247	Test Distance:	3 m
Test item:	Harmonic	Power:	AC 120 V/60 Hz
Frequency:	2422 MHz	Temp.(°C)/Hum.(%RH):	26(°C)/60 %RH
Mode:	Mode 5		
Ant.Polar.:	Vertical		

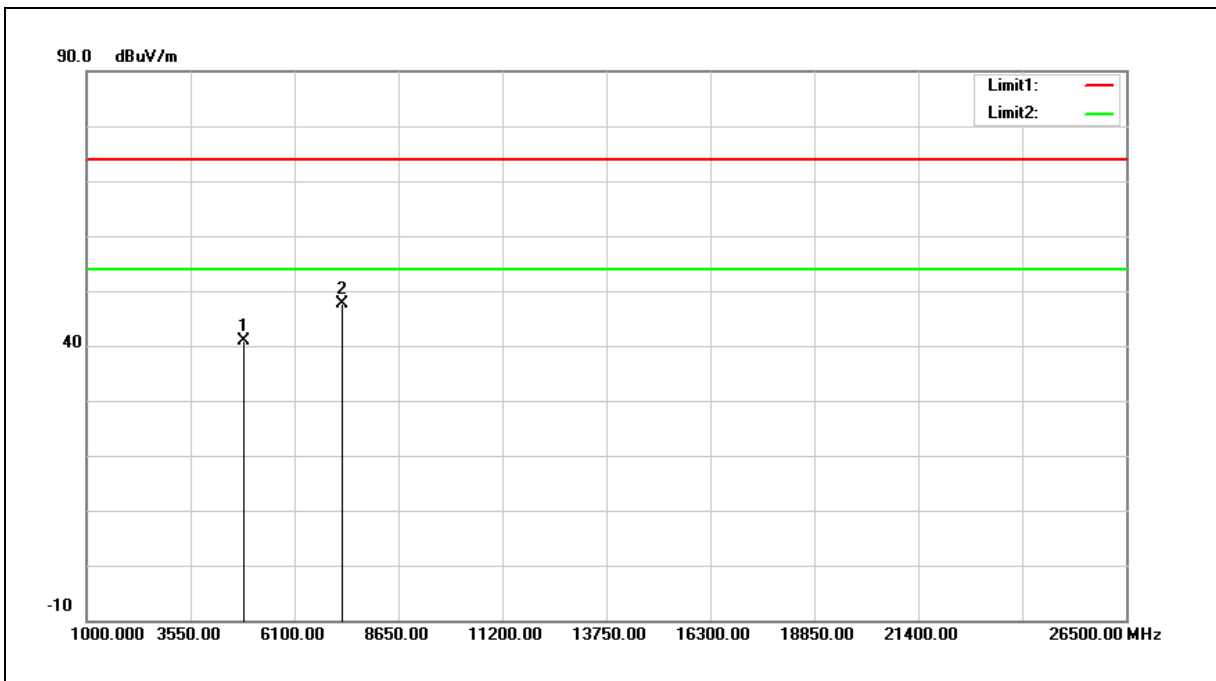

No.	Frequency (MHz)	Reading (dBuV)	Correct Factor (dB/m)	Result (dBuV/m)	Limit (dBuV/m)	Margin (dB)	Remark
1	4844.000	35.38	5.62	41.00	74.00	-33.00	peak
2	7266.000	35.59	12.04	47.63	74.00	-26.37	peak

- Note:1.Result (dBuV/m) = Correct Factor (dB/m) + Reading(dBuV).
 2.Correction factor (dB/m) = Antenna Factor (dB/m) + Cable loss (dB) – Pre-Amplifier gain (dB).
 3. When the peak results are less than average limit, so not need to evaluate the average.



Standard:	FCC Part 15.247	Test Distance:	3 m
Test item:	Harmonic	Power:	AC 120 V/60 Hz
Frequency:	2437 MHz	Temp.(°C)/Hum.(%RH):	26(°C)/60 %RH
Mode:	Mode 5		
Ant.Polar.:	Horizontal		

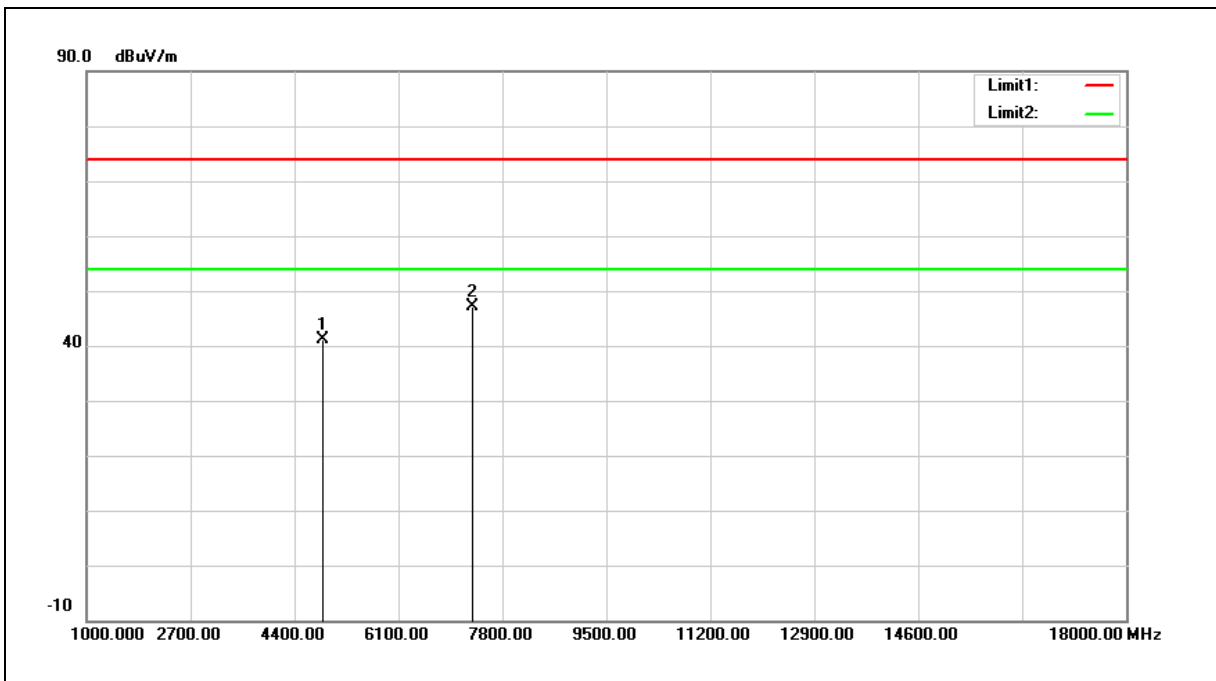

No.	Frequency (MHz)	Reading (dBuV)	Correct Factor (dB/m)	Result (dBuV/m)	Limit (dBuV/m)	Margin (dB)	Remark
1	4874.000	35.50	5.67	41.17	74.00	-32.83	peak
2	7311.000	34.96	12.15	47.11	74.00	-26.89	peak

Note:1.Result (dBuV/m) = Correct Factor (dB/m) + Reading(dBuV).

2.Correction factor (dB/m) = Antenna Factor (dB/m) + Cable loss (dB) – Pre-Amplifier gain (dB).

3. When the peak results are less than average limit, so not need to evaluate the average.



Standard:	FCC Part 15.247	Test Distance:	3 m
Test item:	Harmonic	Power:	AC 120 V/60 Hz
Frequency:	2437 MHz	Temp.(°C)/Hum.(%RH):	26(°C)/60 %RH
Mode:	Mode 5		
Ant.Polar.:	Vertical		

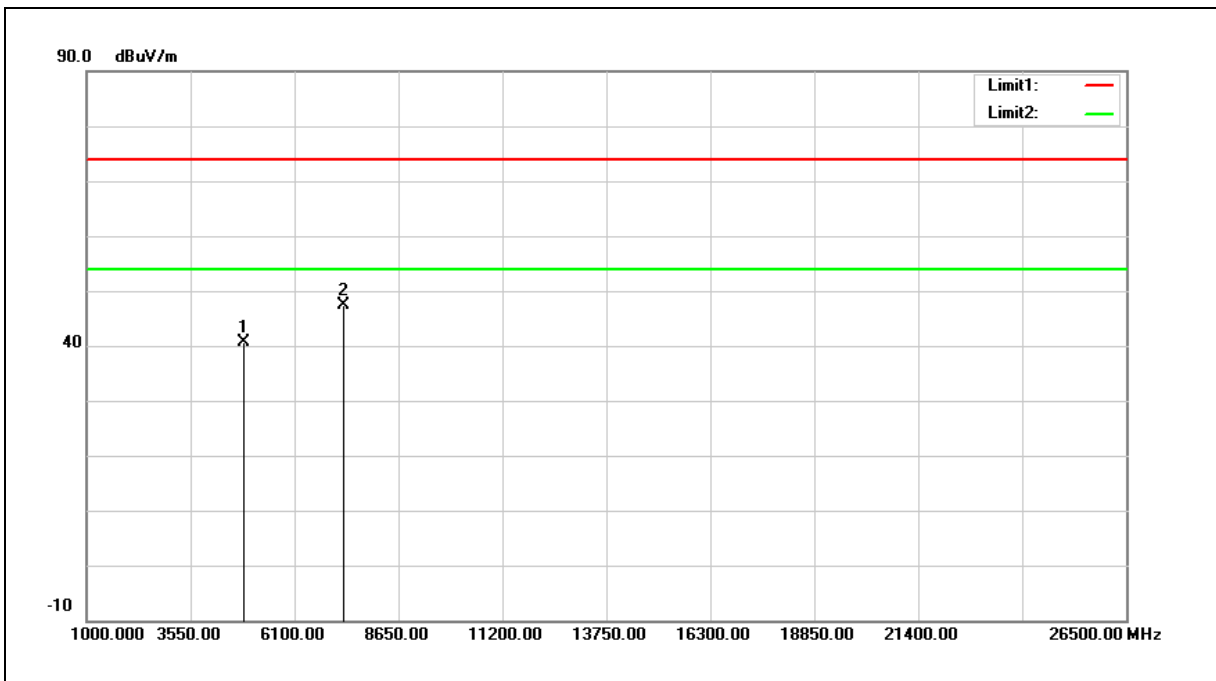

No.	Frequency (MHz)	Reading (dBuV)	Correct Factor (dB/m)	Result (dBuV/m)	Limit (dBuV/m)	Margin (dB)	Remark
1	4874.000	35.00	5.67	40.67	74.00	-33.33	peak
2	7311.000	35.20	12.15	47.35	74.00	-26.65	peak

- Note:1.Result (dBuV/m) = Correct Factor (dB/m) + Reading(dBuV).
 2.Correction factor (dB/m) = Antenna Factor (dB/m) + Cable loss (dB) – Pre-Amplifier gain (dB).
 3. When the peak results are less than average limit, so not need to evaluate the average.



Standard:	FCC Part 15.247	Test Distance:	3 m
Test item:	Harmonic	Power:	AC 120 V/60 Hz
Frequency:	2452 MHz	Temp.(°C)/Hum.(%RH):	26(°C)/60 %RH
Mode:	Mode 5		
Ant.Polar.:	Horizontal		

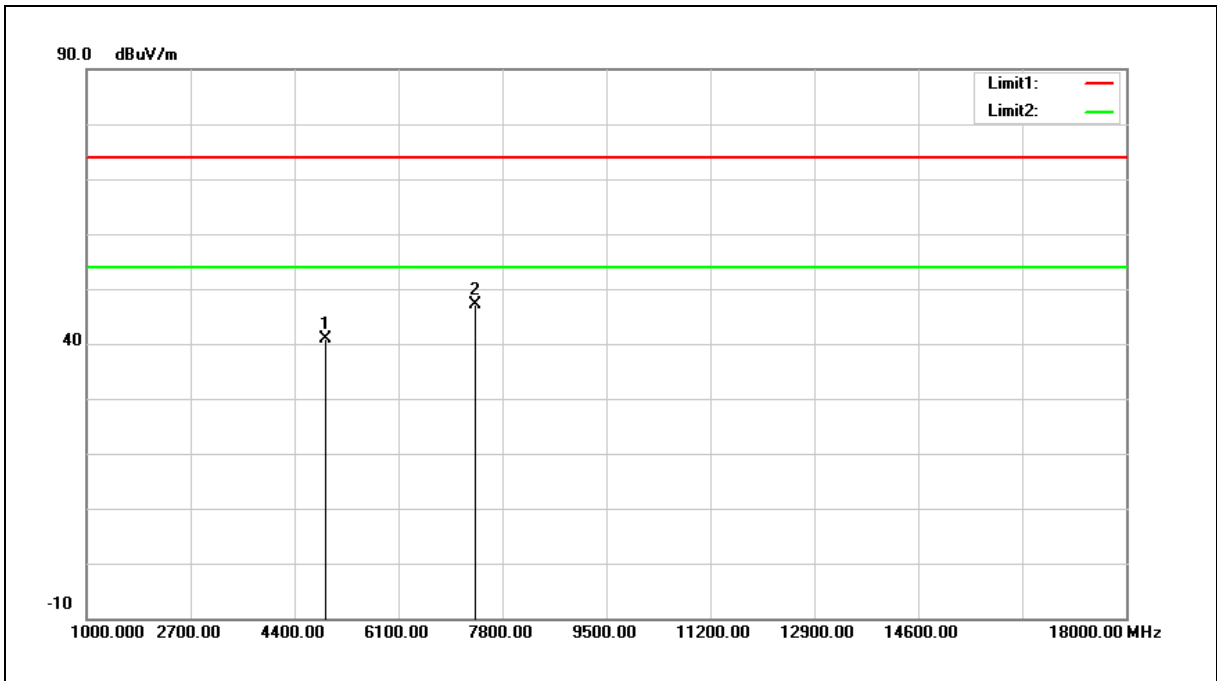

No.	Frequency (MHz)	Reading (dBuV)	Correct Factor (dB/m)	Result (dBuV/m)	Limit (dBuV/m)	Margin (dB)	Remark
1	4904.000	35.14	5.73	40.87	74.00	-33.13	peak
2	7356.000	34.84	12.25	47.09	74.00	-26.91	peak

Note:1.Result (dBuV/m) = Correct Factor (dB/m) + Reading(dBuV).

2.Correction factor (dB/m) = Antenna Factor (dB/m) + Cable loss (dB) – Pre-Amplifier gain (dB).

3. When the peak results are less than average limit, so not need to evaluate the average.



Standard:	FCC Part 15.247	Test Distance:	3 m
Test item:	Harmonic	Power:	AC 120 V/60 Hz
Frequency:	2452 MHz	Temp.(°C)/Hum.(%RH):	26(°C)/60 %RH
Mode:	Mode 5		
Ant.Polar.:	Vertical		

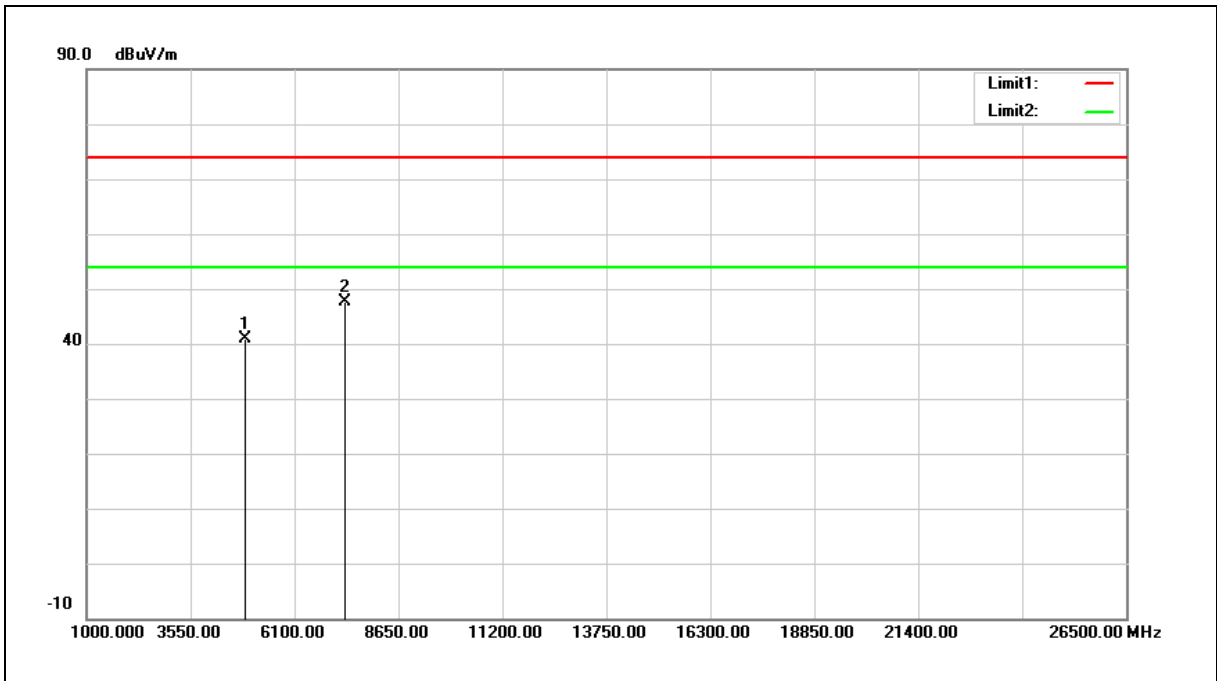

No.	Frequency (MHz)	Reading (dBuV)	Correct Factor (dB/m)	Result (dBuV/m)	Limit (dBuV/m)	Margin (dB)	Remark
1	4904.000	35.17	5.73	40.90	74.00	-33.10	peak
2	7356.000	35.33	12.25	47.58	74.00	-26.42	peak

Note:1.Result (dBuV/m) = Correct Factor (dB/m) + Reading(dBuV).

2.Correction factor (dB/m) = Antenna Factor (dB/m) + Cable loss (dB) – Pre-Amplifier gain (dB).

3. When the peak results are less than average limit, so not need to evaluate the average.



Band Edge

Standard:	FCC Part 15.247	Test Distance:	3 m
Test item:	Band edge	Power:	AC 120 V/60 Hz
Frequency:	2412 MHz	Temp.(°C)/Hum.(%RH):	26(°C)/60 %RH
Mode:	Mode 2	Date:	
Ant.Polar.:	Horizontal		

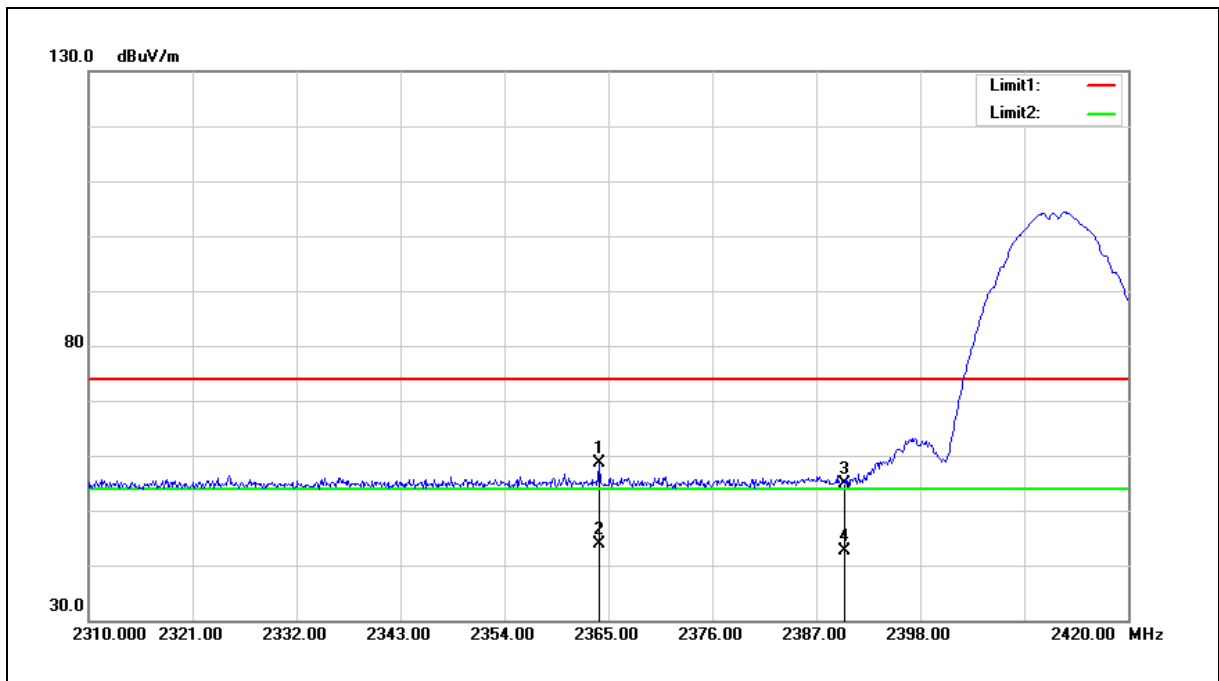

No.	Frequency (MHz)	Reading (dBuV)	Correct Factor (dB/m)	Result (dBuV/m)	Limit (dBuV/m)	Margin (dB)	Remark
1	2364.010	59.87	-1.13	58.74	74.00	-15.26	peak
2	2364.010	45.11	-1.13	43.98	54.00	-10.02	AVG
3	2390.000	55.86	-1.05	54.81	74.00	-19.19	peak
4	2390.000	43.65	-1.05	42.60	54.00	-11.40	AVG

Note:1.Result (dBuV/m) = Correct Factor (dB/m) + Reading(dBuV).

2.Correction factor (dB/m) = Antenna Factor (dB/m) + Cable loss (dB) – Pre-Amplifier gain (dB).

3. When the peak results are less than average limit, so not need to evaluate the average.



Standard:	FCC Part 15.247	Test Distance:	3 m
Test item:	Band edge	Power:	AC 120 V/60 Hz
Frequency:	2412 MHz	Temp.(°C)/Hum.(%RH):	26(°C)/60 %RH
Mode:	Mode 2	Date:	
Ant.Polar.:	Vertical		

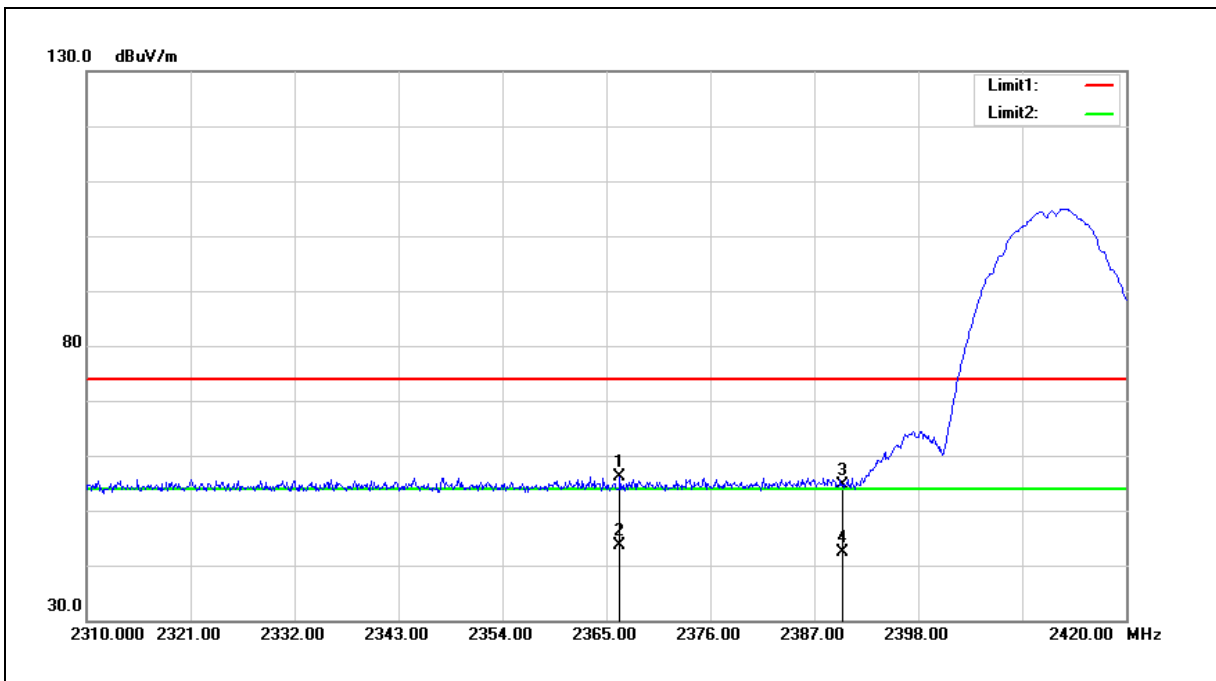

No.	Frequency (MHz)	Reading (dBuV)	Correct Factor (dB/m)	Result (dBuV/m)	Limit (dBuV/m)	Margin (dB)	Remark
1	2366.430	57.23	-1.13	56.10	74.00	-17.90	peak
2	2366.430	44.66	-1.13	43.53	54.00	-10.47	AVG
3	2390.000	55.63	-1.05	54.58	74.00	-19.42	peak
4	2390.000	43.36	-1.05	42.31	54.00	-11.69	AVG

Note:1.Result (dBuV/m) = Correct Factor (dB/m) + Reading(dBuV).

2.Correction factor (dB/m) = Antenna Factor (dB/m) + Cable loss (dB) – Pre-Amplifier gain (dB).

3. When the peak results are less than average limit, so not need to evaluate the average.



Standard:	FCC Part 15.247	Test Distance:	3 m
Test item:	Band edge	Power:	AC 120 V/60 Hz
Frequency:	2462 MHz	Temp.(°C)/Hum.(%RH):	26(°C)/60 %RH
Mode:	Mode 2	Date:	
Ant.Polar.:	Horizontal		

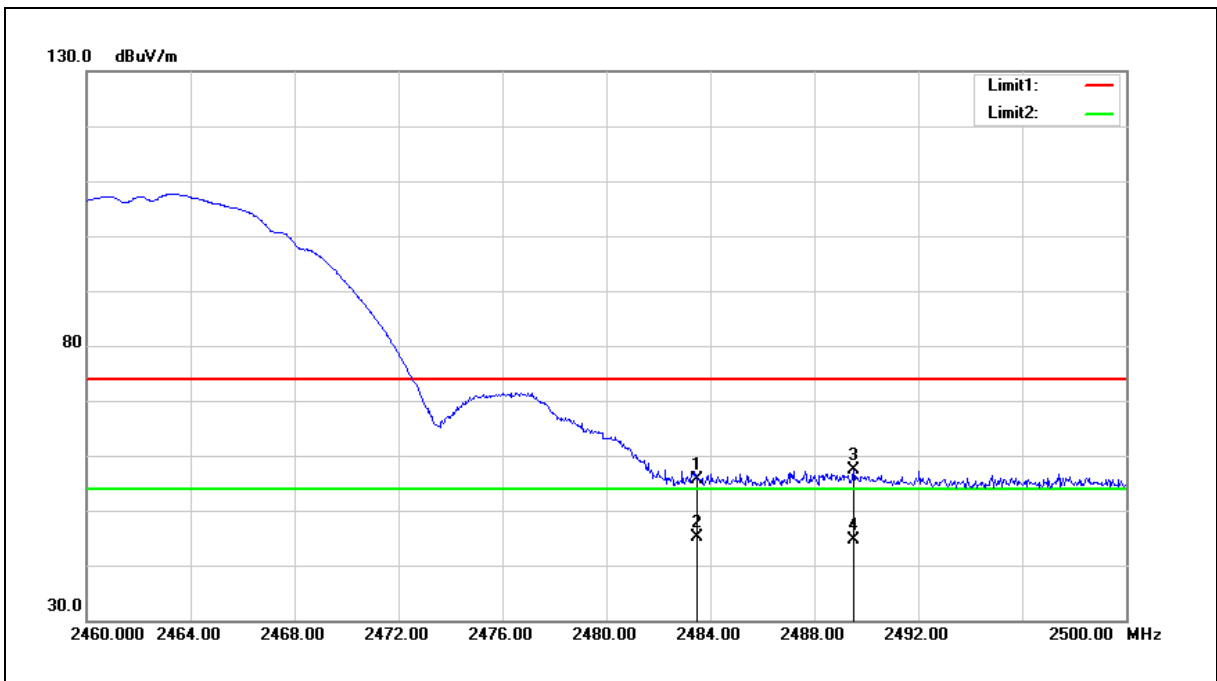

No.	Frequency (MHz)	Reading (dBuV)	Correct Factor (dB/m)	Result (dBuV/m)	Limit (dBuV/m)	Margin (dB)	Remark
1	2483.500	56.36	-0.70	55.66	74.00	-18.34	peak
2	2483.500	45.76	-0.70	45.06	54.00	-8.94	AVG
3	2489.520	58.07	-0.68	57.39	74.00	-16.61	peak
4	2489.520	45.41	-0.68	44.73	54.00	-9.27	AVG

Note:1.Result (dBuV/m) = Correct Factor (dB/m) + Reading(dBuV).

2.Correction factor (dB/m) = Antenna Factor (dB/m) + Cable loss (dB) – Pre-Amplifier gain (dB).

3. When the peak results are less than average limit, so not need to evaluate the average.



Standard:	FCC Part 15.247	Test Distance:	3 m
Test item:	Band edge	Power:	AC 120 V/60 Hz
Frequency:	2462 MHz	Temp.(°C)/Hum.(%RH):	26(°C)/60 %RH
Mode:	Mode 2	Date:	
Ant.Polar.:	Vertical		

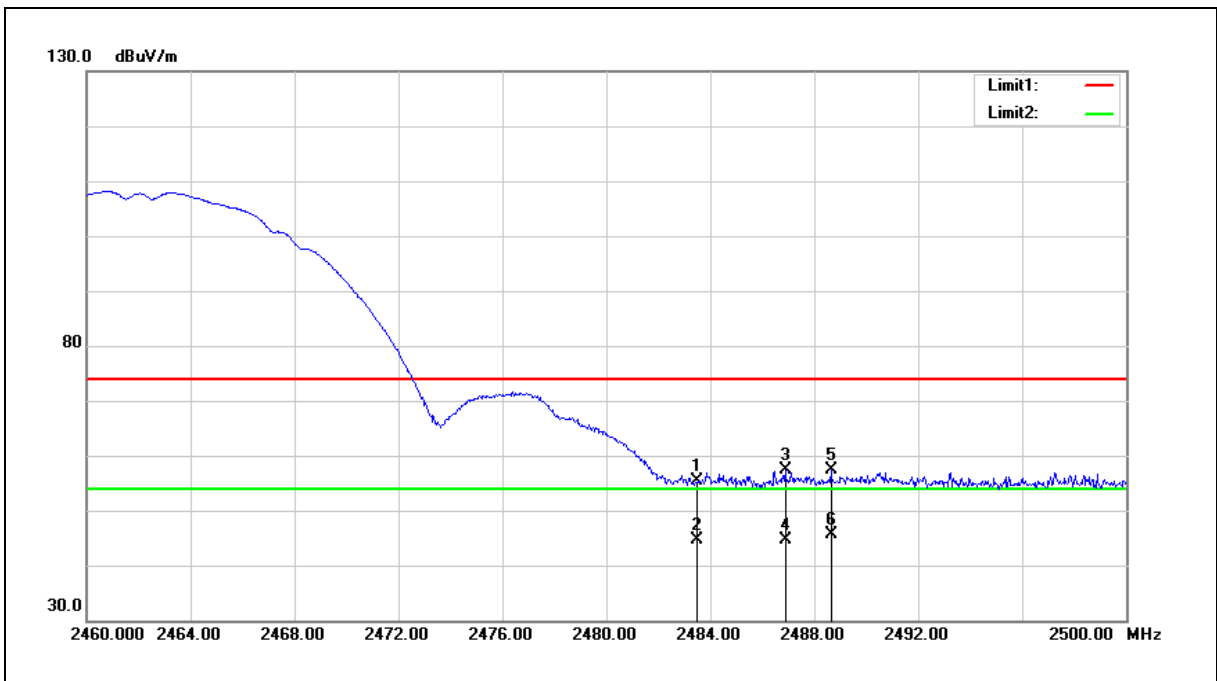

No.	Frequency (MHz)	Reading (dBuV)	Correct Factor (dB/m)	Result (dBuV/m)	Limit (dBuV/m)	Margin (dB)	Remark
1	2483.500	56.20	-0.70	55.50	74.00	-18.50	peak
2	2483.500	45.24	-0.70	44.54	54.00	-9.46	AVG
3	2486.880	58.09	-0.69	57.40	74.00	-16.60	peak
4	2486.880	45.34	-0.69	44.65	54.00	-9.35	AVG
5	2488.640	58.07	-0.68	57.39	74.00	-16.61	peak
6	2488.640	46.41	-0.68	45.73	54.00	-8.27	AVG

Note:1.Result (dBuV/m) = Correct Factor (dB/m) + Reading(dBuV).

2.Correction factor (dB/m) = Antenna Factor (dB/m) + Cable loss (dB) – Pre-Amplifier gain (dB).

3. When the peak results are less than average limit, so not need to evaluate the average.



Standard:	FCC Part 15.247	Test Distance:	3 m
Test item:	Band edge	Power:	AC 120 V/60 Hz
Frequency:	2412 MHz	Temp.(°C)/Hum.(%RH):	26(°C)/60 %RH
Mode:	Mode 3	Date:	
Ant.Polar.:	Horizontal		

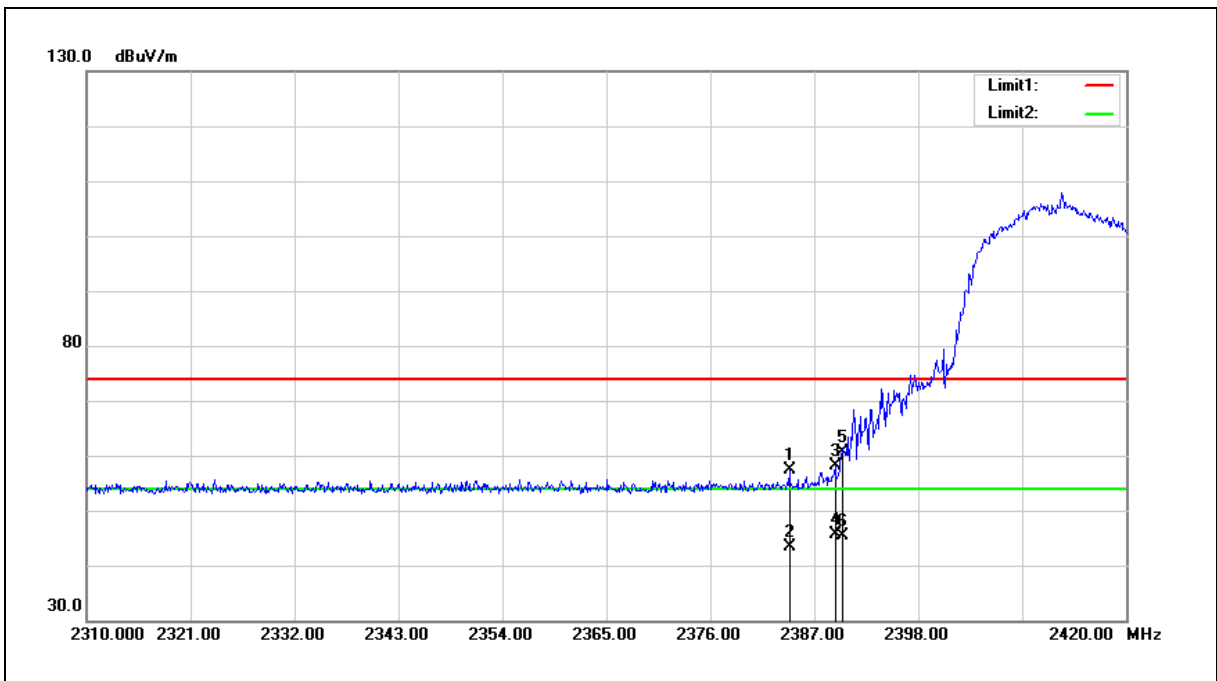

No.	Frequency (MHz)	Reading (dBuV)	Correct Factor (dB/m)	Result (dBuV/m)	Limit (dBuV/m)	Margin (dB)	Remark
1	2384.360	58.33	-1.07	57.26	74.00	-16.74	peak
2	2384.360	44.42	-1.07	43.35	54.00	-10.65	AVG
3	2389.200	59.22	-1.05	58.17	74.00	-15.83	peak
4	2389.200	46.71	-1.05	45.66	54.00	-8.34	AVG
5	2390.000	61.75	-1.05	60.70	74.00	-13.30	peak
6	2390.000	46.44	-1.05	45.39	54.00	-8.61	AVG

Note:1.Result (dBuV/m) = Correct Factor (dB/m) + Reading(dBuV).

2.Correction factor (dB/m) = Antenna Factor (dB/m) + Cable loss (dB) – Pre-Amplifier gain (dB).

3. When the peak results are less than average limit, so not need to evaluate the average.



Standard:	FCC Part 15.247	Test Distance:	3 m
Test item:	Band edge	Power:	AC 120 V/60 Hz
Frequency:	2412 MHz	Temp.(°C)/Hum.(%RH):	26(°C)/60 %RH
Mode:	Mode 3	Date:	
Ant.Polar.:	Vertical		

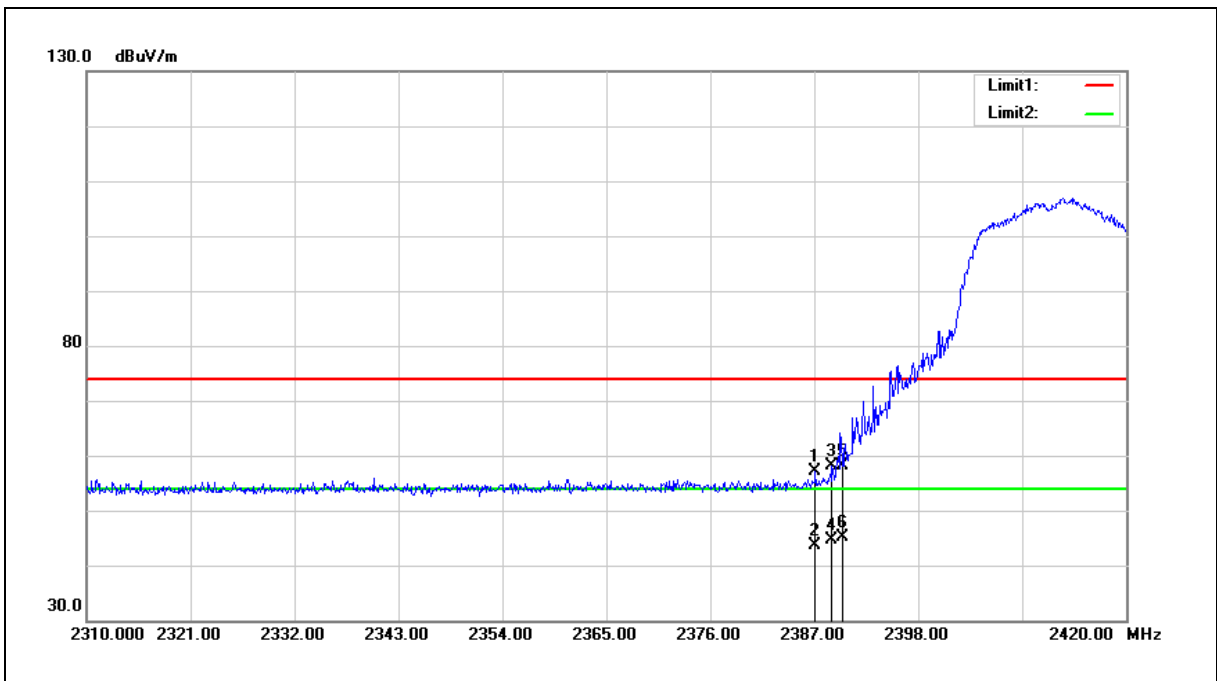

No.	Frequency (MHz)	Reading (dBuV)	Correct Factor (dB/m)	Result (dBuV/m)	Limit (dBuV/m)	Margin (dB)	Remark
1	2387.110	58.09	-1.06	57.03	74.00	-16.97	peak
2	2387.110	44.65	-1.06	43.59	54.00	-10.41	AVG
3	2388.870	59.09	-1.05	58.04	74.00	-15.96	peak
4	2388.870	45.80	-1.05	44.75	54.00	-9.25	AVG
5	2390.000	59.19	-1.05	58.14	74.00	-15.86	peak
6	2390.000	46.14	-1.05	45.09	54.00	-8.91	AVG

Note:1.Result (dBuV/m) = Correct Factor (dB/m) + Reading(dBuV).

2.Correction factor (dB/m) = Antenna Factor (dB/m) + Cable loss (dB) – Pre-Amplifier gain (dB).

3. When the peak results are less than average limit, so not need to evaluate the average.



Standard:	FCC Part 15.247	Test Distance:	3 m
Test item:	Band edge	Power:	AC 120 V/60 Hz
Frequency:	2462 MHz	Temp.(°C)/Hum.(%RH):	26(°C)/60 %RH
Mode:	Mode 3	Date:	
Ant.Polar.:	Horizontal		

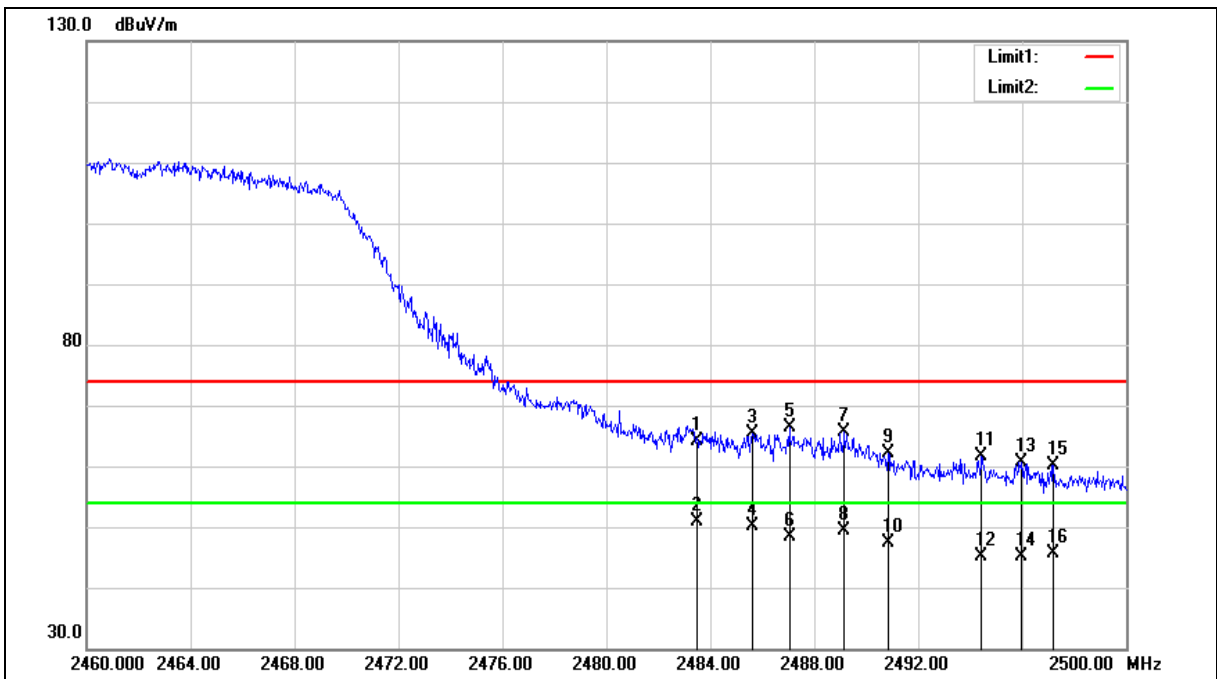



Standard:	FCC Part 15.247	Test Distance:	3 m
Test item:	Band edge	Power:	AC 120 V/60 Hz
Frequency:	2462 MHz	Temp.(°C)/Hum.(%RH):	26(°C)/60 %RH
Mode:	Mode 3	Date:	
Ant.Polar.:	Horizontal		

No.	Frequency (MHz)	Reading (dBuV)	Correct Factor (dB/m)	Result (dBuV/m)	Limit (dBuV/m)	Margin (dB)	Remark
1	2483.500	64.94	-0.70	64.24	74.00	-9.76	peak
2	2483.500	51.49	-0.70	50.79	54.00	-3.21	AVG
3	2485.640	66.04	-0.70	65.34	74.00	-8.66	peak
4	2485.640	50.80	-0.70	50.10	54.00	-3.90	AVG
5	2487.040	66.95	-0.69	66.26	74.00	-7.74	peak
6	2487.040	49.06	-0.69	48.37	54.00	-5.63	AVG
7	2489.160	66.25	-0.68	65.57	74.00	-8.43	peak
8	2489.160	50.06	-0.68	49.38	54.00	-4.62	AVG
9	2490.840	62.69	-0.67	62.02	74.00	-11.98	peak
10	2490.840	48.13	-0.67	47.46	54.00	-6.54	AVG
11	2494.440	62.32	-0.66	61.66	74.00	-12.34	peak
12	2494.440	45.85	-0.66	45.19	54.00	-8.81	AVG
13	2495.960	61.37	-0.65	60.72	74.00	-13.28	peak
14	2495.960	45.87	-0.65	45.22	54.00	-8.78	AVG
15	2497.200	60.80	-0.65	60.15	74.00	-13.85	peak
16	2497.200	46.28	-0.65	45.63	54.00	-8.37	AVG

Note:1.Result (dBuV/m) = Correct Factor (dB/m) + Reading(dBuV).

2.Correction factor (dB/m) = Antenna Factor (dB/m) + Cable loss (dB) – Pre-Amplifier gain (dB).

3. When the peak results are less than average limit, so not need to evaluate the average.



Standard:	FCC Part 15.247	Test Distance:	3 m
Test item:	Band edge	Power:	AC 120 V/60 Hz
Frequency:	2462 MHz	Temp.(°C)/Hum.(%RH):	26(°C)/60 %RH
Mode:	Mode 3	Date:	
Ant.Polar.:	Vertical		

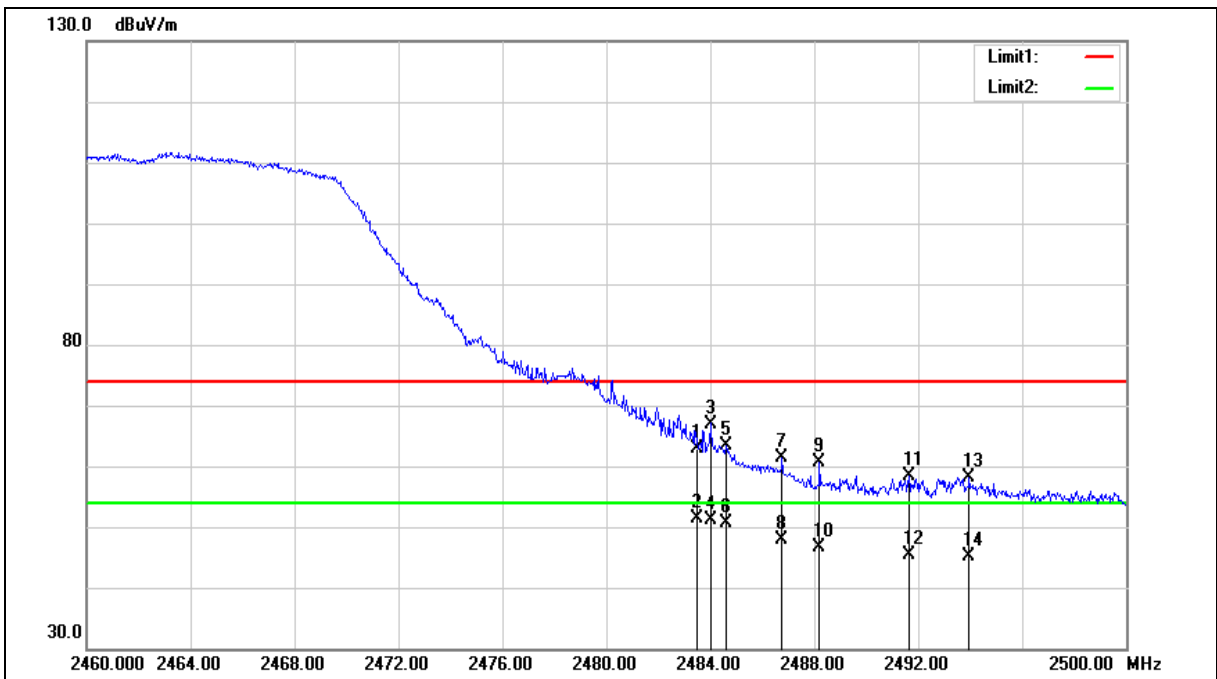



Standard:	FCC Part 15.247	Test Distance:	3 m
Test item:	Band edge	Power:	AC 120 V/60 Hz
Frequency:	2462 MHz	Temp.(°C)/Hum.(%RH):	26(°C)/60 %RH
Mode:	Mode 3	Date:	
Ant.Polar.:	Vertical		

No.	Frequency (MHz)	Reading (dBUV)	Correct Factor (dB/m)	Result (dBUV/m)	Limit (dBUV/m)	Margin (dB)	Remark
1	2483.500	63.63	-0.70	62.93	74.00	-11.07	peak
2	2483.500	52.08	-0.70	51.38	54.00	-2.62	AVG
3	2484.000	67.70	-0.70	67.00	74.00	-7.00	peak
4	2484.000	51.83	-0.70	51.13	54.00	-2.87	AVG
5	2484.600	64.05	-0.70	63.35	74.00	-10.65	peak
6	2484.600	51.36	-0.70	50.66	54.00	-3.34	AVG
7	2486.760	62.14	-0.69	61.45	74.00	-12.55	peak
8	2486.760	48.60	-0.69	47.91	54.00	-6.09	AVG
9	2488.200	61.28	-0.68	60.60	74.00	-13.40	peak
10	2488.200	47.23	-0.68	46.55	54.00	-7.45	AVG
11	2491.640	59.03	-0.67	58.36	74.00	-15.64	peak
12	2491.640	45.98	-0.67	45.31	54.00	-8.69	AVG
13	2493.960	58.87	-0.67	58.20	74.00	-15.80	peak
14	2493.960	45.91	-0.67	45.24	54.00	-8.76	AVG

Note:1.Result (dBUV/m) = Correct Factor (dB/m) + Reading(dBUV).

2.Correction factor (dB/m) = Antenna Factor (dB/m) + Cable loss (dB) – Pre-Amplifier gain (dB).

3. When the peak results are less than average limit, so not need to evaluate the average.



Standard:	FCC Part 15.247	Test Distance:	3 m
Test item:	Band edge	Power:	AC 120 V/60 Hz
Frequency:	2412 MHz	Temp.(°C)/Hum.(%RH):	26(°C)/60 %RH
Mode:	Mode 4	Date:	
Ant.Polar.:	Horizontal		

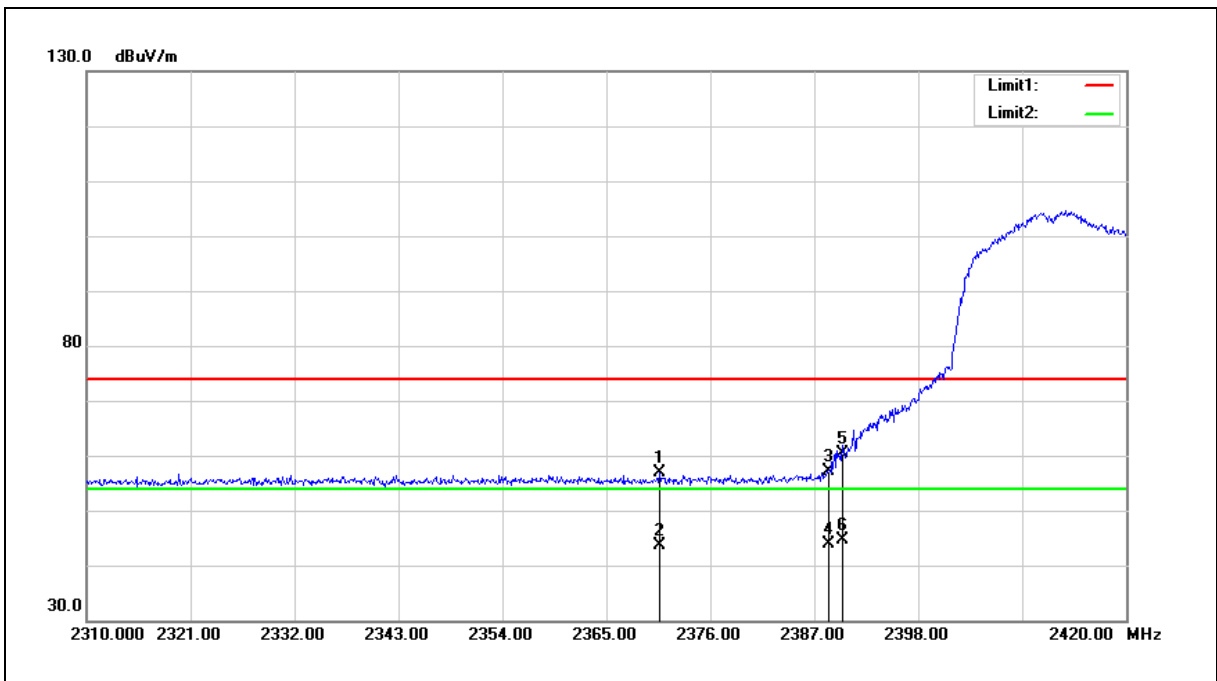

No.	Frequency (MHz)	Reading (dBuV)	Correct Factor (dB/m)	Result (dBuV/m)	Limit (dBuV/m)	Margin (dB)	Remark
1	2370.610	57.93	-1.12	56.81	74.00	-17.19	peak
2	2370.610	44.65	-1.12	43.53	54.00	-10.47	AVG
3	2388.540	58.30	-1.05	57.25	74.00	-16.75	peak
4	2388.540	44.93	-1.05	43.88	54.00	-10.12	AVG
5	2390.000	61.45	-1.05	60.40	74.00	-13.60	peak
6	2390.000	45.57	-1.05	44.52	54.00	-9.48	AVG

Note:1.Result (dBuV/m) = Correct Factor (dB/m) + Reading(dBuV).

2.Correction factor (dB/m) = Antenna Factor (dB/m) + Cable loss (dB) – Pre-Amplifier gain (dB).

3. When the peak results are less than average limit, so not need to evaluate the average.



Standard:	FCC Part 15.247	Test Distance:	3 m
Test item:	Band edge	Power:	AC 120 V/60 Hz
Frequency:	2412 MHz	Temp.(°C)/Hum.(%RH):	26(°C)/60 %RH
Mode:	Mode 4	Date:	
Ant.Polar.:	Vertical		

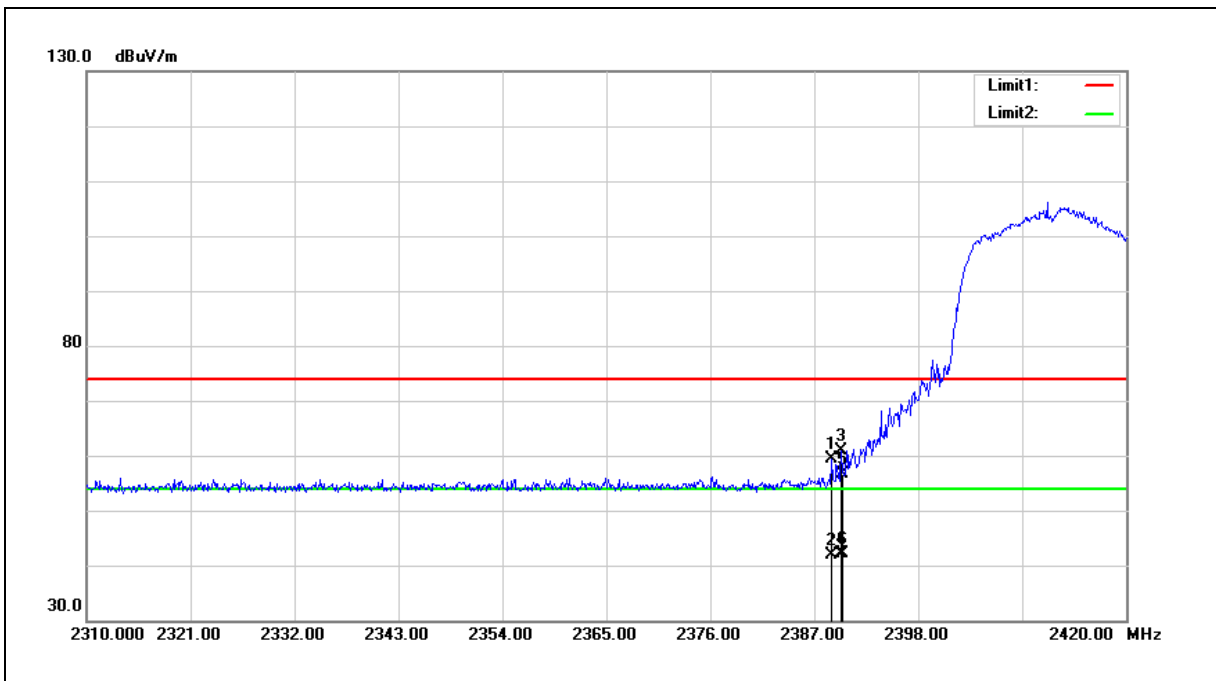

No.	Frequency (MHz)	Reading (dBuV)	Correct Factor (dB/m)	Result (dBuV/m)	Limit (dBuV/m)	Margin (dB)	Remark
1	2388.870	60.41	-1.05	59.36	74.00	-14.64	peak
2	2388.870	42.88	-1.05	41.83	54.00	-12.17	AVG
3	2389.860	61.99	-1.05	60.94	74.00	-13.06	peak
4	2389.860	43.20	-1.05	42.15	54.00	-11.85	AVG
5	2390.000	57.68	-1.05	56.63	74.00	-17.37	peak
6	2390.000	43.18	-1.05	42.13	54.00	-11.87	AVG

Note:1.Result (dBuV/m) = Correct Factor (dB/m) + Reading(dBuV).

2.Correction factor (dB/m) = Antenna Factor (dB/m) + Cable loss (dB) – Pre-Amplifier gain (dB).

3. When the peak results are less than average limit, so not need to evaluate the average.



Standard:	FCC Part 15.247	Test Distance:	3 m
Test item:	Band edge	Power:	AC 120 V/60 Hz
Frequency:	2462 MHz	Temp.(°C)/Hum.(%RH):	26(°C)/60 %RH
Mode:	Mode 4	Date:	
Ant.Polar.:	Horizontal		

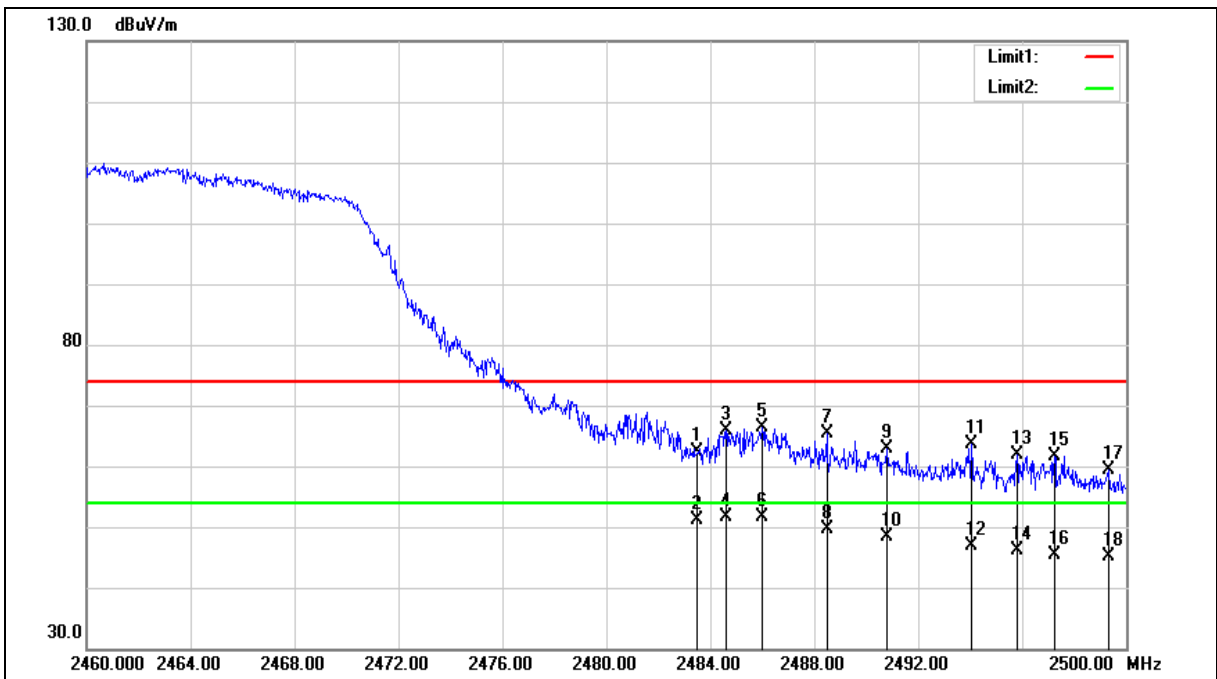



Standard:	FCC Part 15.247	Test Distance:	3 m
Test item:	Band edge	Power:	AC 120 V/60 Hz
Frequency:	2462 MHz	Temp.(°C)/Hum.(%RH):	26(°C)/60 %RH
Mode:	Mode 4	Date:	
Ant.Polar.:	Horizontal		

No.	Frequency (MHz)	Reading (dBuV)	Correct Factor (dB/m)	Result (dBuV/m)	Limit (dBuV/m)	Margin (dB)	Remark
1	2483.500	63.08	-0.70	62.38	74.00	-11.62	peak
2	2483.500	51.75	-0.70	51.05	54.00	-2.95	AVG
3	2484.600	66.54	-0.70	65.84	74.00	-8.16	peak
4	2484.600	52.39	-0.70	51.69	54.00	-2.31	AVG
5	2486.000	67.19	-0.70	66.49	74.00	-7.51	peak
6	2486.000	52.43	-0.70	51.73	54.00	-2.27	AVG
7	2488.480	66.08	-0.68	65.40	74.00	-8.60	peak
8	2488.480	50.42	-0.68	49.74	54.00	-4.26	AVG
9	2490.800	63.61	-0.67	62.94	74.00	-11.06	peak
10	2490.800	49.07	-0.67	48.40	54.00	-5.60	AVG
11	2494.040	64.31	-0.67	63.64	74.00	-10.36	peak
12	2494.040	47.46	-0.67	46.79	54.00	-7.21	AVG
13	2495.800	62.42	-0.66	61.76	74.00	-12.24	peak
14	2495.800	46.77	-0.66	46.11	54.00	-7.89	AVG
15	2497.240	62.35	-0.65	61.70	74.00	-12.30	peak
16	2497.240	46.14	-0.65	45.49	54.00	-8.51	AVG
17	2499.320	60.00	-0.64	59.36	74.00	-14.64	peak
18	2499.320	45.84	-0.64	45.20	54.00	-8.80	AVG

Note:1.Result (dBuV/m) = Correct Factor (dB/m) + Reading(dBuV).

2.Correction factor (dB/m) = Antenna Factor (dB/m) + Cable loss (dB) – Pre-Amplifier gain (dB).

3. When the peak results are less than average limit, so not need to evaluate the average.



Standard:	FCC Part 15.247	Test Distance:	3 m
Test item:	Band edge	Power:	AC 120 V/60 Hz
Frequency:	2462 MHz	Temp.(°C)/Hum.(%RH):	26(°C)/60 %RH
Mode:	Mode 4	Date:	
Ant.Polar.:	Vertical		

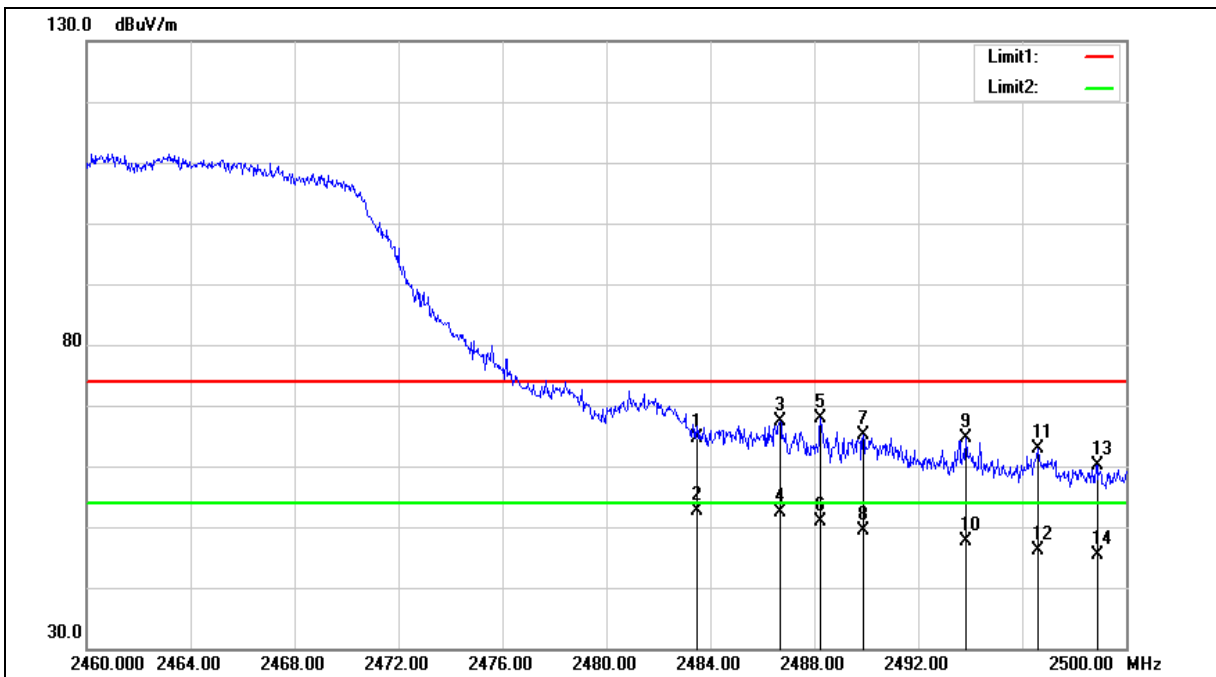



Standard:	FCC Part 15.247	Test Distance:	3 m
Test item:	Band edge	Power:	AC 120 V/60 Hz
Frequency:	2462 MHz	Temp.(°C)/Hum.(%RH):	26(°C)/60 %RH
Mode:	Mode 4	Date:	
Ant.Polar.:	Vertical		

No.	Frequency (MHz)	Reading (dBUV)	Correct Factor (dB/m)	Result (dBUV/m)	Limit (dBUV/m)	Margin (dB)	Remark
1	2483.500	65.34	-0.70	64.64	74.00	-9.36	peak
2	2483.500	53.27	-0.70	52.57	54.00	-1.43	AVG
3	2486.680	68.02	-0.69	67.33	74.00	-6.67	peak
4	2486.680	53.09	-0.69	52.40	54.00	-1.60	AVG
5	2488.240	68.45	-0.68	67.77	74.00	-6.23	peak
6	2488.240	51.61	-0.68	50.93	54.00	-3.07	AVG
7	2489.880	65.91	-0.68	65.23	74.00	-8.77	peak
8	2489.880	49.97	-0.68	49.29	54.00	-4.71	AVG
9	2493.840	65.18	-0.67	64.51	74.00	-9.49	peak
10	2493.840	48.29	-0.67	47.62	54.00	-6.38	AVG
11	2496.600	63.43	-0.65	62.78	74.00	-11.22	peak
12	2496.600	46.78	-0.65	46.13	54.00	-7.87	AVG
13	2498.880	60.80	-0.64	60.16	74.00	-13.84	peak
14	2498.880	45.92	-0.64	45.28	54.00	-8.72	AVG

Note:1.Result (dBUV/m) = Correct Factor (dB/m) + Reading(dBUV).

2.Correction factor (dB/m) = Antenna Factor (dB/m) + Cable loss (dB) – Pre-Amplifier gain (dB).

3. When the peak results are less than average limit, so not need to evaluate the average.



Standard:	FCC Part 15.247	Test Distance:	3 m
Test item:	Band edge	Power:	AC 120 V/60 Hz
Frequency:	2422 MHz	Temp.(°C)/Hum.(%RH):	26(°C)/60 %RH
Mode:	Mode 5	Date:	
Ant.Polar.:	Horizontal		

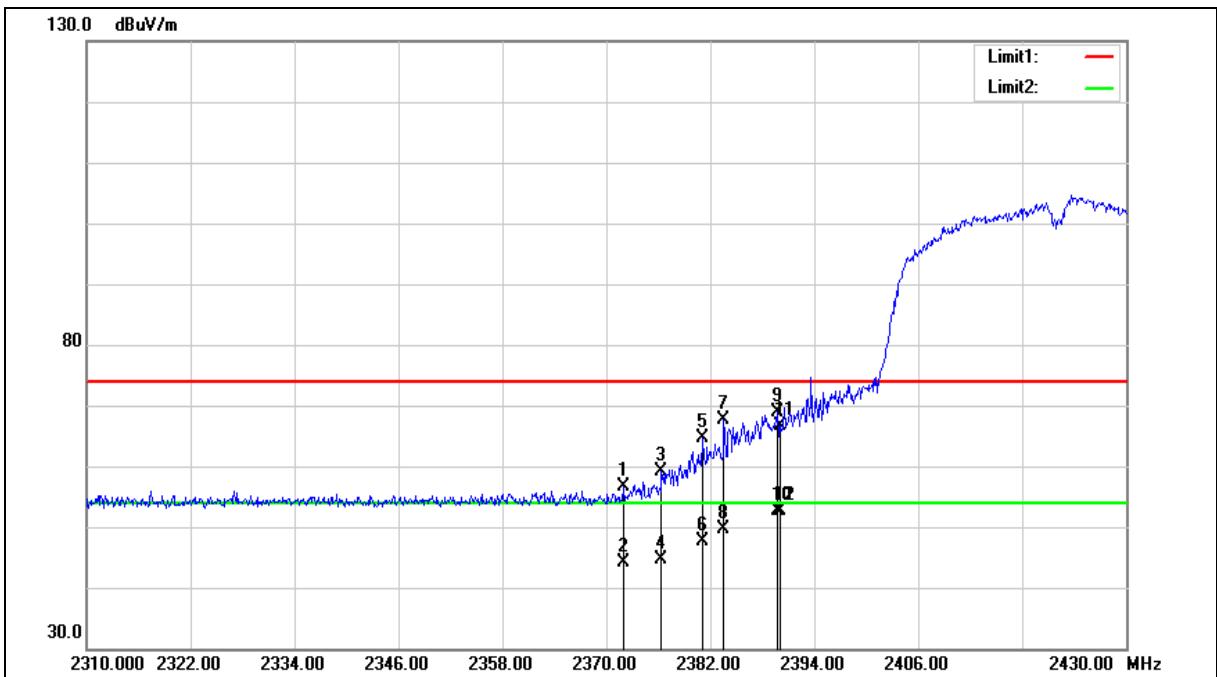



Standard:	FCC Part 15.247	Test Distance:	3 m
Test item:	Band edge	Power:	AC 120 V/60 Hz
Frequency:	2422 MHz	Temp.(°C)/Hum.(%RH):	26(°C)/60 %RH
Mode:	Mode 5	Date:	
Ant.Polar.:	Horizontal		

No.	Frequency (MHz)	Reading (dBuV)	Correct Factor (dB/m)	Result (dBuV/m)	Limit (dBuV/m)	Margin (dB)	Remark
1	2371.920	57.63	-1.10	56.53	74.00	-17.47	peak
2	2371.920	45.13	-1.10	44.03	54.00	-9.97	AVG
3	2376.360	60.26	-1.10	59.16	74.00	-14.84	peak
4	2376.360	45.80	-1.10	44.70	54.00	-9.30	AVG
5	2381.160	65.71	-1.08	64.63	74.00	-9.37	peak
6	2381.160	48.73	-1.08	47.65	54.00	-6.35	AVG
7	2383.560	68.79	-1.07	67.72	74.00	-6.28	peak
8	2383.560	50.59	-1.07	49.52	54.00	-4.48	AVG
9	2389.680	69.90	-1.05	68.85	74.00	-5.15	peak
10	2389.680	53.76	-1.05	52.71	54.00	-1.29	AVG
11	2390.000	67.57	-1.05	66.52	74.00	-7.48	peak
12	2390.000	53.74	-1.05	52.69	54.00	-1.31	AVG

Note:1.Result (dBuV/m) = Correct Factor (dB/m) + Reading(dBuV).

2.Correction factor (dB/m) = Antenna Factor (dB/m) + Cable loss (dB) – Pre-Amplifier gain (dB).

3. When the peak results are less than average limit, so not need to evaluate the average.



Standard:	FCC Part 15.247	Test Distance:	3 m
Test item:	Band edge	Power:	AC 120 V/60 Hz
Frequency:	2422 MHz	Temp.(°C)/Hum.(%RH):	26(°C)/60 %RH
Mode:	Mode 5	Date:	
Ant.Polar.:	Vertical		

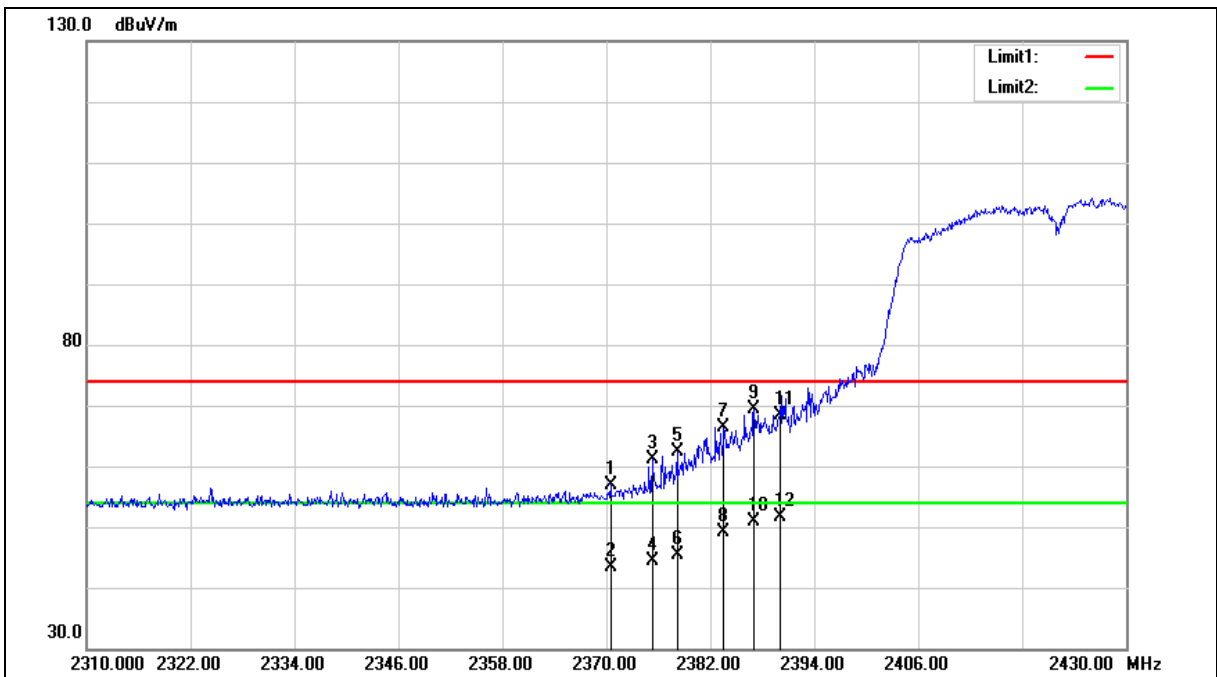



Standard:	FCC Part 15.247	Test Distance:	3 m
Test item:	Band edge	Power:	AC 120 V/60 Hz
Frequency:	2422 MHz	Temp.(°C)/Hum.(%RH):	26(°C)/60 %RH
Mode:	Mode 5	Date:	
Ant.Polar.:	Vertical		

No.	Frequency (MHz)	Reading (dBuV)	Correct Factor (dB/m)	Result (dBuV/m)	Limit (dBuV/m)	Margin (dB)	Remark
1	2370.480	58.12	-1.12	57.00	74.00	-17.00	peak
2	2370.480	44.57	-1.12	43.45	54.00	-10.55	AVG
3	2375.280	62.17	-1.10	61.07	74.00	-12.93	peak
4	2375.280	45.37	-1.10	44.27	54.00	-9.73	AVG
5	2378.160	63.40	-1.10	62.30	74.00	-11.70	peak
6	2378.160	46.51	-1.10	45.41	54.00	-8.59	AVG
7	2383.560	67.36	-1.07	66.29	74.00	-7.71	peak
8	2383.560	50.27	-1.07	49.20	54.00	-4.80	AVG
9	2387.040	70.54	-1.06	69.48	74.00	-4.52	peak
10	2387.040	51.94	-1.06	50.88	54.00	-3.12	AVG
11	2390.000	69.35	-1.05	68.30	74.00	-5.70	peak
12	2390.000	52.60	-1.05	51.55	54.00	-2.45	AVG

Note:1.Result (dBuV/m) = Correct Factor (dB/m) + Reading(dBuV).

2.Correction factor (dB/m) = Antenna Factor (dB/m) + Cable loss (dB) – Pre-Amplifier gain (dB).

3. When the peak results are less than average limit, so not need to evaluate the average.



Standard:	FCC Part 15.247	Test Distance:	3 m
Test item:	Band edge	Power:	AC 120 V/60 Hz
Frequency:	2452 MHz	Temp.(°C)/Hum.(%RH):	26(°C)/60 %RH
Mode:	Mode 5	Date:	
Ant.Polar.:	Horizontal		

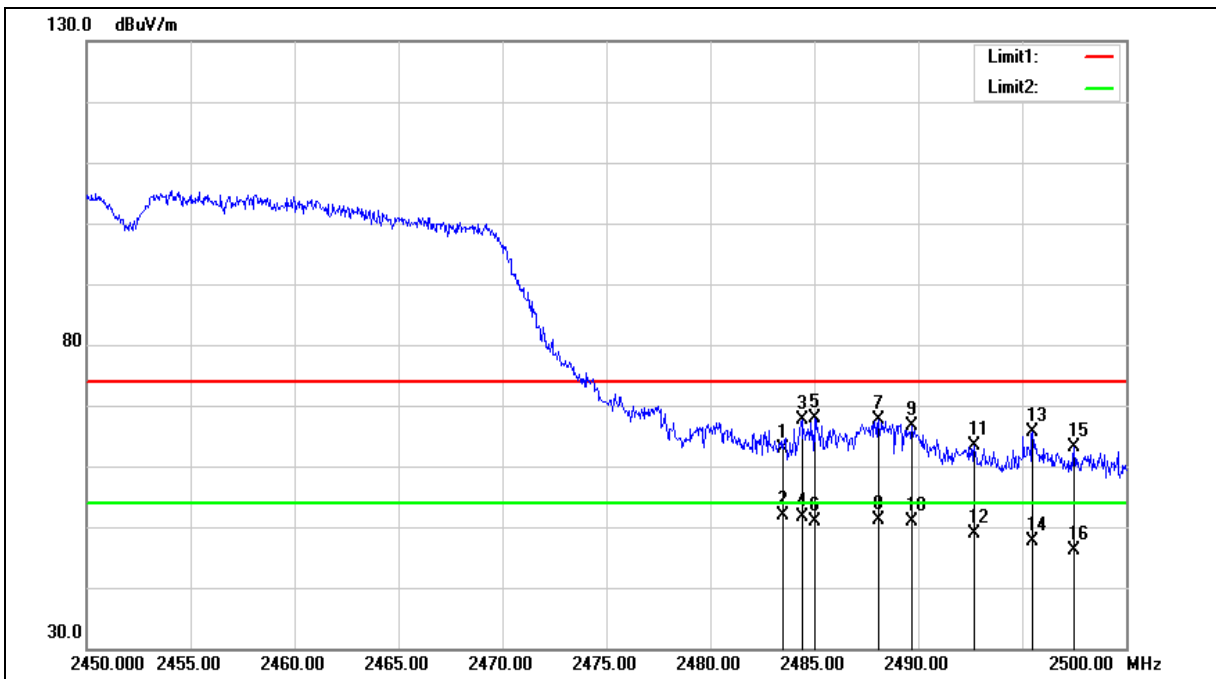



Standard:	FCC Part 15.247	Test Distance:	3 m
Test item:	Band edge	Power:	AC 120 V/60 Hz
Frequency:	2452 MHz	Temp.(°C)/Hum.(%RH):	26(°C)/60 %RH
Mode:	Mode 5	Date:	
Ant.Polar.:	Horizontal		

No.	Frequency (MHz)	Reading (dBuV)	Correct Factor (dB/m)	Result (dBuV/m)	Limit (dBuV/m)	Margin (dB)	Remark
1	2483.500	63.59	-0.70	62.89	74.00	-11.11	peak
2	2483.500	52.65	-0.70	51.95	54.00	-2.05	AVG
3	2484.400	68.39	-0.70	67.69	74.00	-6.31	peak
4	2484.400	52.43	-0.70	51.73	54.00	-2.27	AVG
5	2485.000	68.56	-0.70	67.86	74.00	-6.14	peak
6	2485.000	51.47	-0.70	50.77	54.00	-3.23	AVG
7	2488.100	68.37	-0.68	67.69	74.00	-6.31	peak
8	2488.100	51.78	-0.68	51.10	54.00	-2.90	AVG
9	2489.700	67.27	-0.68	66.59	74.00	-7.41	peak
10	2489.700	51.50	-0.68	50.82	54.00	-3.18	AVG
11	2492.700	64.02	-0.67	63.35	74.00	-10.65	peak
12	2492.700	49.58	-0.67	48.91	54.00	-5.09	AVG
13	2495.500	66.22	-0.66	65.56	74.00	-8.44	peak
14	2495.500	48.29	-0.66	47.63	54.00	-6.37	AVG
15	2497.500	63.85	-0.65	63.20	74.00	-10.80	peak
16	2497.500	46.89	-0.65	46.24	54.00	-7.76	AVG

Note:1.Result (dBuV/m) = Correct Factor (dB/m) + Reading(dBuV).

2.Correction factor (dB/m) = Antenna Factor (dB/m) + Cable loss (dB) – Pre-Amplifier gain (dB).

3. When the peak results are less than average limit, so not need to evaluate the average.



Standard:	FCC Part 15.247	Test Distance:	3 m
Test item:	Band edge	Power:	AC 120 V/60 Hz
Frequency:	2452 MHz	Temp.(°C)/Hum.(%RH):	26(°C)/60 %RH
Mode:	Mode 5	Date:	
Ant.Polar.:	Vertical		

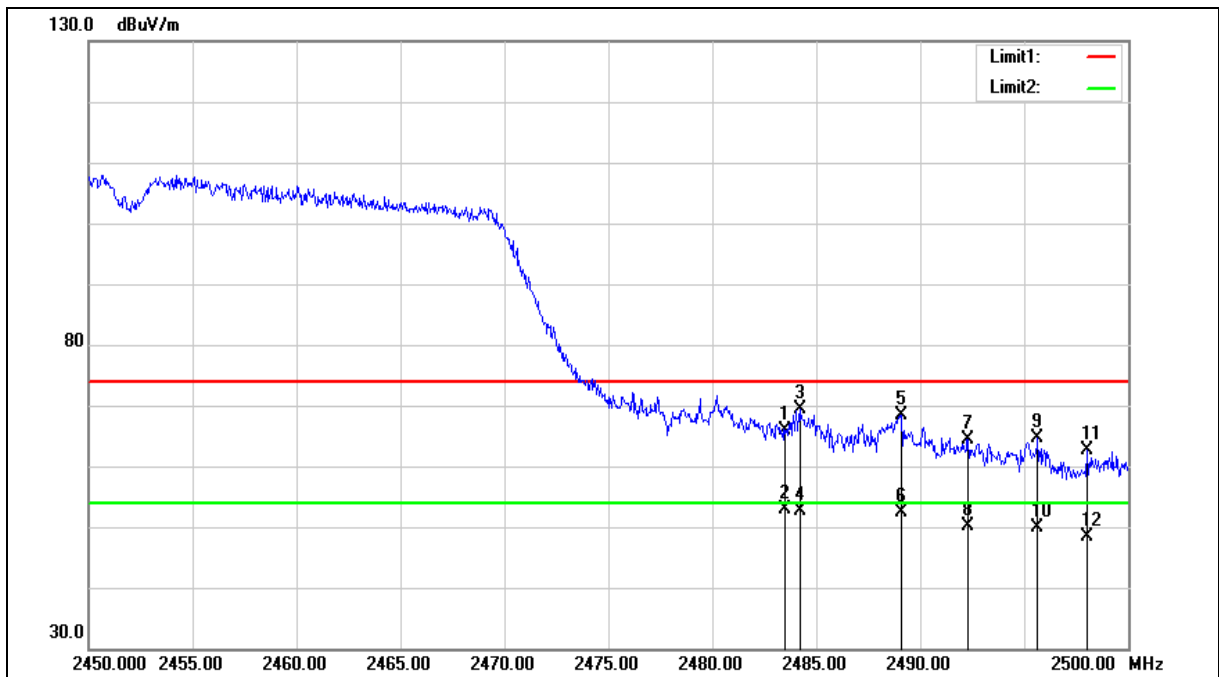



Standard:	FCC Part 15.247	Test Distance:	3 m
Test item:	Band edge	Power:	AC 120 V/60 Hz
Frequency:	2452 MHz	Temp.(°C)/Hum.(%RH):	26(°C)/60 %RH
Mode:	Mode 5	Date:	
Ant.Polar.:	Vertical		

No.	Frequency (MHz)	Reading (dBuV)	Correct Factor (dB/m)	Result (dBuV/m)	Limit (dBuV/m)	Margin (dB)	Remark
1	2483.500	66.59	-0.70	65.89	74.00	-8.11	peak
2	2483.500	53.57	-0.70	52.87	54.00	-1.13	AVG
3	2484.250	70.04	-0.70	69.34	74.00	-4.66	peak
4	2484.250	53.32	-0.70	52.62	54.00	-1.38	AVG
5	2489.100	69.13	-0.68	68.45	74.00	-5.55	peak
6	2489.100	52.99	-0.68	52.31	54.00	-1.69	AVG
7	2492.300	65.17	-0.67	64.50	74.00	-9.50	peak
8	2492.300	50.91	-0.67	50.24	54.00	-3.76	AVG
9	2495.650	65.35	-0.66	64.69	74.00	-9.31	peak
10	2495.650	50.43	-0.66	49.77	54.00	-4.23	AVG
11	2498.000	63.27	-0.65	62.62	74.00	-11.38	peak
12	2498.000	48.98	-0.65	48.33	54.00	-5.67	AVG

Note:1.Result (dBuV/m) = Correct Factor (dB/m) + Reading(dBuV).

2.Correction factor (dB/m) = Antenna Factor (dB/m) + Cable loss (dB) – Pre-Amplifier gain (dB).

3. When the peak results are less than average limit, so not need to evaluate the average.

--- END---