

RF Test Report

Applicant : Swann Communications Pty Ltd
Product Type : Swann Wire-Free Security Camera
Trade Name : Swann
Model Number : SWIFI-CAM
Applicable Standard : FCC 47 CFR PART 15 SUBPART C
ANSI C63.10:2013
Receive Date : May 22, 2019
Test Period : Jun. 05 ~ Jul. 04, 2019
Issue Date : Jul. 17, 2019

Issue by

A Test Lab Techno Corp.
No. 140-1, Changan Street, Bade District,
Taoyuan City 33465, Taiwan (R.O.C.)
Tel : +886-3-2710188 / Fax : +886-3-2710190



Taiwan Accreditation Foundation accreditation number: 1330

Test Firm MRA designation number: TW0010

Note:

1. The test results are valid only for samples provided by customers and under the test conditions described in this report.
2. This report shall not be reproduced except in full, without the written approval of A Test Lab Technology Corporation.
3. The relevant information is provided by customers in this test report. According to the correctness, appropriateness or completeness of the information provided by the customer, if there is any doubt or error in the information which affects the validity of the test results, the laboratory does not take the responsibility.



Revision History

Rev.	Issue Date	Revisions	Revised By
00	Jul. 17, 2019	Initial Issue	Tobey Cheng

Verification of Compliance

Issued Date: Jul. 17, 2019

Applicant : Swann Communications Pty Ltd
Product Type : Swann Wire-Free Security Camera
Trade Name : Swann
Model Number : SWIFI-CAM
FCC ID : VMISWIFICAM
EUT Rated Voltage : DC 5 V, 2.1 A
Test Voltage : 120 Vac / 60 Hz
Applicable Standard : FCC 47 CFR PART 15 SUBPART C
ANSI C63.10:2013
Test Result : Complied

Performing Lab. : A Test Lab Techno Corp.
No. 140-1, Changan Street, Bade District,
Taoyuan City 33465, Taiwan (R.O.C.)
Tel : +886-3-2710188 / Fax : +886-3-2710190



Taiwan Accreditation Foundation accreditation number: 1330
<http://www.atl-lab.com.tw/e-index.htm>

A Test Lab Techno Corp. tested the above equipment in accordance with the requirements set forth in the above standards. All indications of Pass/Fail in this report are opinions expressed by A Test Lab Techno Corp. based on interpretations and/or observations of test results. The test results show that the equipment tested is capable of demonstrating compliance with the requirements as documented in this report.

Approved By : Fly Lu Reviewed By : Eric Ou Yang
(Manager) (Fly Lu) (Testing Engineer) (Eric Ou Yang)



TABLE OF CONTENTS

1	General Information	5
1.1.	Summary of Test Result.....	5
1.2.	Measurement Uncertainty.....	6
2	EUT Description	7
3	Test Methodology	8
3.1.	Mode of Operation.....	8
3.2.	EUT Test Step	11
3.3.	Configuration of Test System Details	12
3.4.	Test Instruments	13
3.5.	Test Site Environment.....	14
4	Measurement Procedure	15
4.1.	AC Power Line Conducted Emission Measurement.....	15
4.2.	Radiated Emission Measurement	17
4.3.	Maximum Conducted Output Power Measurement.....	22
4.4.	6 dB RF Bandwidth Measurement	23
4.5.	Maximum Power Spectral Density Measurement.....	24
4.6.	Out of Band Conducted Emissions Measurement.....	25
4.7.	Antenna Measurement	26
5	Test Results.....	27
	Annex A. Conducted Emission	27
	Annex B. Conducted Test Results	29
	Annex C. Radiated Emission Test Results.....	52



1 General Information

1.1. Summary of Test Result

Standard	Item	Result	Remark
15.207	AC Power Conducted Emission	PASS	----
15.247(d)	Transmitter Radiated Emissions	PASS	----
15.247(b)(3)	Max. Output Power	PASS	----
15.247(a)(2)	6 dB RF Bandwidth	PASS	----
15.247(e)	Maximum Power Spectral Density	PASS	----
15.247(d)	Out of Band Conducted Spurious Emission	PASS	----
15.203	Antenna Requirement	PASS	----

Standard	Description
CFR47, Part 15, Subpart C	Intentional Radiators
ANSI C63. 10: 2013	American National Standard of Procedures for Compliance Testing of Unlicensed Wireless Devices
KDB 558074 D01 15.247 Meas Guidance v05r02	GUIDANCE FOR COMPLIANCE MEASUREMENTS ON DIGITAL TRANSMISSION SYSTEM, FREQUENCY HOPPING SPREAD SPECTRUM SYSTEM, AND HYBRID SYSTEM DEVICES OPERATING UNDER SECTION 15.247 OF THE FCC RULES

1.2. Measurement Uncertainty

Test Item	Frequency Range	Uncertainty (dB)
Conducted Emission	150 kHz ~ 30 MHz	2.8
Radiated Emission	9 kHz ~ 30 MHz	1.7
	30 MHz ~ 1000 MHz	5.7
	1000 MHz ~ 18000 MHz	5.6
	18000 MHz ~ 26500 MHz	4.9
	26500 MHz ~ 40000 MHz	4.8
Conducted Output Power	+0.27 dB / -0.28 dB	
RF Bandwidth	4.96 %	
Power Spectral Density	+0.71 dB / -0.77 dB	

Decision Rule

- Uncertainty is not included.
- Uncertainty is included.



2 EUT Description

Applicant	Swann Communications Pty Ltd Unit 5B 706 Lorimer Street, Port Melbourne 3207, Australia			
Manufacturer	Chicony Electronics (Dong Guan) Co.,Ltd. San Zhong Guan Li Qu, Qingxi Town, Dongguan City Guangdong 523651 China			
Product Type	Swann Wire-Free Security Camera			
Trade Name	Swann			
Model Number	SWIFI-CAM			
FCC ID	VMISWIFICAM			
Operate Freq. Band	Frequency Range (MHz)	Modulation	Channel Bandwidth	Data Rate 400 / 800 GI (ns)
IEEE 802.11b	2412 ~ 2462	DSSS	20 MHz	Up to 11 Mbps
IEEE 802.11g	2412 ~ 2462	OFDM	20 MHz	Up to 54 Mbps
IEEE 802.11n 2.4 GHz 20 MHz	2412 ~ 2462	OFDM	20 MHz	Up to 72.2 Mbps
IEEE 802.11n 2.4 GHz 40 MHz	2422 ~ 2452	OFDM	40 MHz	Up to 150 Mbps
Antenna information	Type		Max. Gain (dBi)	
	PIFA Antenna		0.49	
Antenna Delivery	See section 3.1			
Operate Temp. Range	-20 ~ +50 °C			

Frequency Band	Max. RF Output Power (W)
IEEE 802.11b	0.087
IEEE 802.11g	0.070
IEEE 802.11n 2.4 GHz 20 MHz	0.056
IEEE 802.11n 2.4 GHz 40 MHz	0.043

3 Test Methodology

3.1. Mode of Operation

Decision of Test ATL has verified the construction and function in typical operation. All the test modes were carried out with the EUT in normal operation, which was shown in this test report and defined as:

Test Mode
Mode 1: Transmit mode
Mode 2: IEEE 802.11b Continuous TX mode
Mode 3: IEEE 802.11g Continuous TX mode
Mode 4: IEEE 802.11n 2.4 GHz 20 MHz Continuous TX mode
Mode 5: IEEE 802.11n 2.4 GHz 40 MHz Continuous TX mode

Software used to control the EUT for staying in continuous transmitting mode was programmed.

After verification, all tests were carried out with the worst case test modes.

Test Mode	ANT-0
Mode 2	V
Mode 3	V
Mode 4	V
Mode 5	V

Test Mode	Antenna Delivery	Data Rate (Mbps)	Test Channel
Mode 2	1TX/1RX	1	1, 6, 11
Mode 3	1TX/1RX	6	1, 6, 11
Mode 4	1TX/1RX	6.5	1, 6, 11
Mode 5	1TX/1RX	13.5	3, 6, 9



Duty cycle

Test Mode	Frequency (MHz)	on time (ms)	on+off time (ms)	Duty cycle	Duty Factor (dB)	1/T Minimum VBW (kHz)
Mode 2	2412	10.000	10.000	1.000	0.000	0.010
Mode 3	2412	10.000	10.000	1.000	0.000	0.010
Mode 4	2412	10.000	10.000	1.000	0.000	0.010
Mode 5	2422	10.000	10.000	1.000	0.000	0.010

Duty Cycle Graphs

Mode 2: IEEE 802.11b Continuous TX mode



Mode 3: IEEE 802.11g Continuous TX mode



Mode 4: IEEE 802.11n 2.4 GHz 20 MHz Continuous TX mode



Mode 5: IEEE 802.11n 2.4 GHz 40 MHz Continuous TX mode

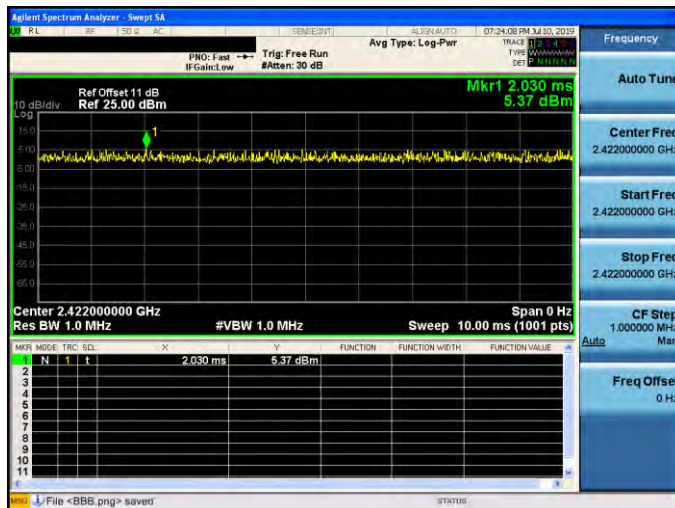



3.2. EUT Test Step

1.	Setup the EUT shown on "Configuration of Test System Details".
2.	Turn on the power of all equipment.
3.	Turn on TX function
4.	EUT run test program.

Measurement Software			
No.	Description	Software	Version
1	Conducted Emission	EZ EMC	1.1.4.3
2	Radiated Emission	EZ EMC	1.1.4.4

3.3. Configuration of Test System Details

Conducted Emissions

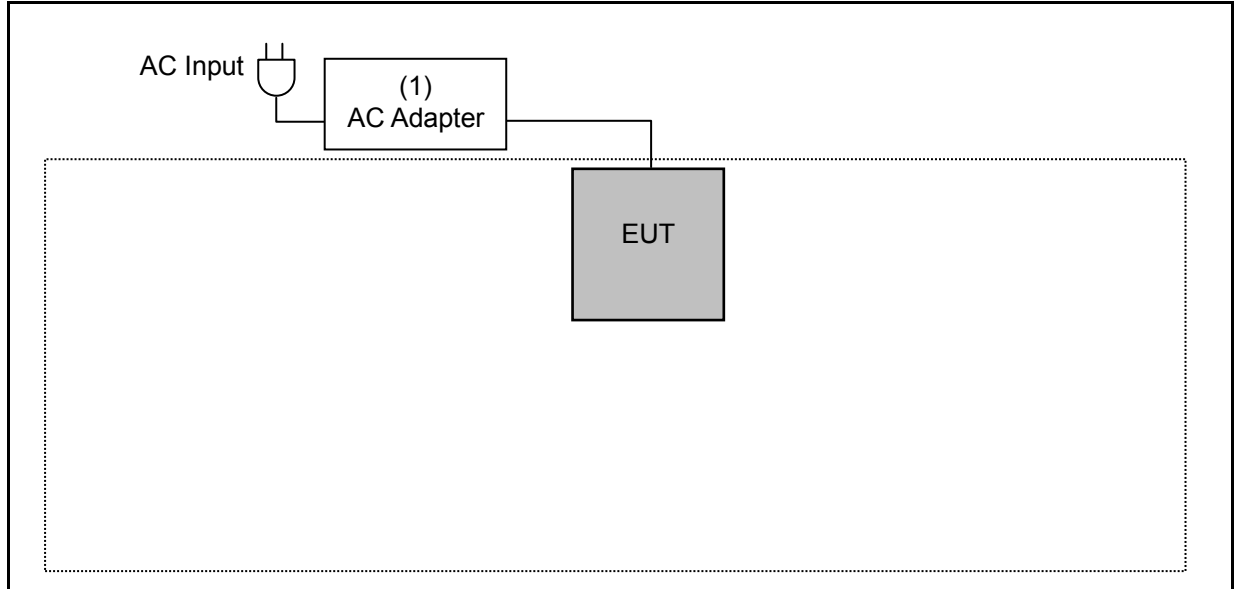

Radiated Emission

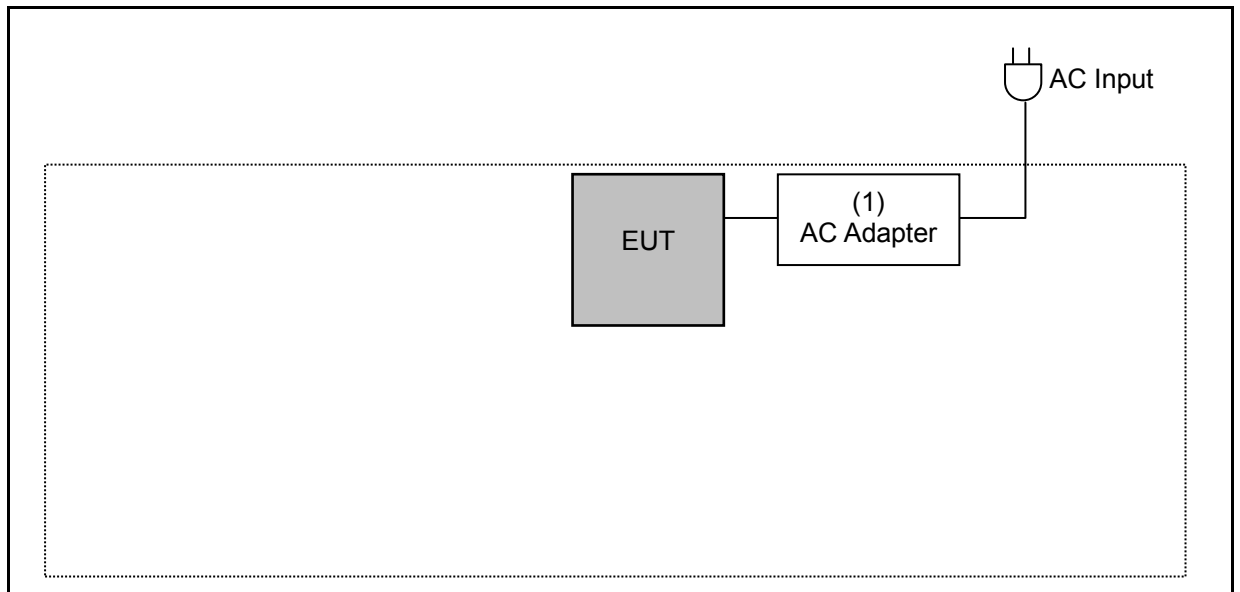

Devices Description					
	Product	Manufacturer	Model Number	Serial Number	Power Cord
(1)	AC Adapter	HUAWEI	HW-050450U00	---	---



3.4. Test Instruments

For Conducted Emission

Test Period: Jul. 04, 2019

Equipment	Manufacturer	Model Number	Serial Number	Cal. Date	Cal. Period
Test Receiver	R&S	ESCI	100367	05/21/2019	1 year
LISN	R&S	ENV216	101040	04/03/2019	1 year
RF Cable	Woken	00100D1380194M	TE-02-03	05/23/2019	1 year

For Radiated Emissions

Test Period: Jun. 05 ~ Jul. 01, 2019

Equipment	Manufacturer	Model Number	Serial Number	Cal. Date	Cal. Period
Spectrum Analyzer (10 Hz~44 GHz)	Keysight	N9010A	MY52221312	01/14/2019	1 year
Pre Amplifier (1~26.5 GHz)	Agilent	8449B	3008A02237	10/16/2018	1 year
Pre Amplifier (100 kHz~1.3 GHz)	Agilent	8447D	2944A11119	01/14/2019	1 year
Broadband Antenna	Schwarzbeck	VULB9168	416	10/19/2018	1 year
Horn Antenna (1~18 GHz)	SCHWARZBECK MESS-ELEKTRONIK	BBHA9120D	9120D-550	08/23/2018	1 year
Horn Antenna (18~40 GHz)	SCHWARZBECK MESS-ELEKTRONIK	BBHA9170	9170-320	08/07/2018	1 year
Loop Antenna	COM-POWER CORPORATION	AL-130	121014	03/29/2019	1 year
RF Cable	EMCI	EMC104-N-N -6000	TE01-1	02/20/2019	1 year
Microwave Cable	EMCI	EMC104-SM -SM-13000	170814	10/30/2018	1 year
Microwave Cable	EMCI	EMC102-KM -KM-14000	151001	02/20/2019	1 year

For Conducted

Test Period: Jun. 10 ~ Jun. 13, 2019

Equipment	Manufacturer	Model Number	Serial Number	Cal. Date	Cal. Period
Spectrum Analyzer (20 Hz~26.5 GHz)	Agilent	N9020A	US47520902	09/25/2018	1 year
Power Sensor	Anritsu	MA2411B	1126022	08/29/2018	1 year
Power Meter	Anritsu	ML2495A	1135009	08/29/2018	1 year
Spectrum Analyzer (3 Hz~50 GHz)	Agilent	N9030A	MY53120541	01/22/2019	1 year

Note: N.C.R. = No Calibration Request.



3.5. Test Site Environment

Items	Required (IEC 60068-1)	Actual
Temperature (°C)	15-35	26
Humidity (%RH)	25-75	60
Barometric pressure (mbar)	860-1060	990

4 Measurement Procedure

4.1. AC Power Line Conducted Emission Measurement

■ Limit

Frequency (MHz)	Quasi-peak	Average
0.15 - 0.5	66 to 56	56 to 46
0.50 - 5.0	56	46
5.0 - 30.0	60	50

■ Test Setup

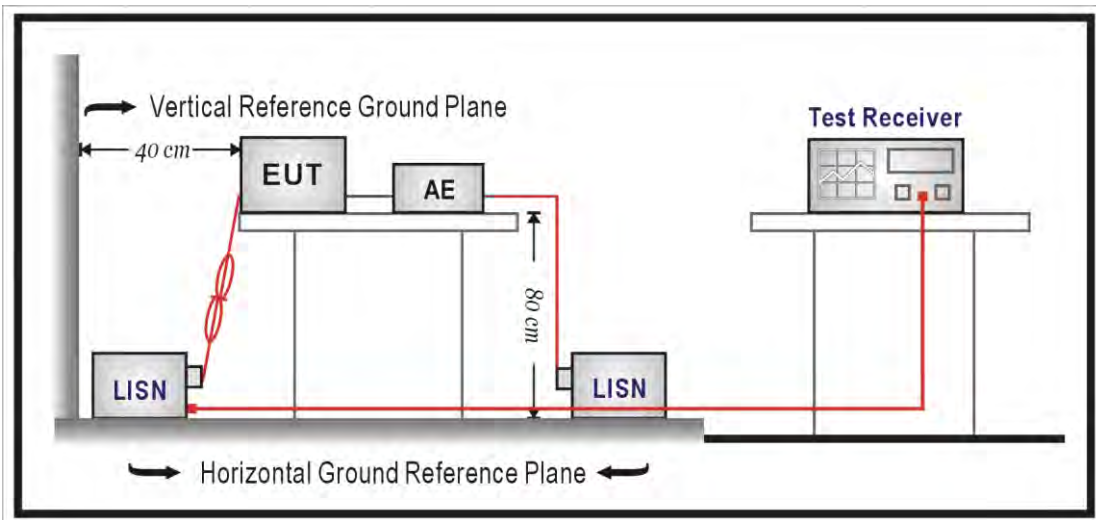

■ Test Procedure

The EUT and simulators are connected to the main power through a line impedance stabilization network (L.I.S.N.). This provides a $50 \Omega // 50 \mu\text{H}$ coupling impedance for the measuring equipment. The peripheral devices are also connected to the main power through a LISN that provides a $50 \Omega // 50 \mu\text{H}$ coupling impedance with 50 ohm termination.

Tabletop device shall be placed on a non-conducting platform, of nominal size 1 m by 1.5 m, raised 80 cm above the reference ground plane. The wall of screened room shall be located 40 cm to the rear of the EUT. Other surfaces of tabletop or floor standing EUT shall be at least 80 cm from any other ground conducting surface including one or more LISNs. For floor-standing device shall be placed under the EUT with a 12 mm insulating material.

Conducted emissions were investigated over the frequency range from 0.15 MHz to 30 MHz using a resolution bandwidth of 9 kHz. The equipment under test (EUT) shall be meet the limits in section 4.1, as applicable, including the average limit and the quasi-peak limit when using respectively, an average detector and quasi-peak detector measured in accordance with the methods described of related standard. When all of peak value were complied with quasi-peak and average limit from 150 kHz to 30 MHz then quasi-peak and average measurement was unnecessary.

The AMN shall be placed 0.8 m from the boundary of the unit under test and bonded to a ground reference plane for AMNs mounted on top of the ground reference plane. This distance is between the closest points of the AMN and the EUT. All other units of the EUT and associated equipment shall be at least 0.8 m from the AMN. If the mains power cable is longer than 1 m then the cable shall be folded back and forth at the centre of the lead to form a bundle no longer than 0.4 m. All of interconnecting cables that hang closer than 40 cm to the ground plane shall be folded back and forth in the center forming a bundle 30 cm to 40 cm long. All of EUT and AE shall be separate place more than 0.1 m. All 50Ω ports of the LISN shall be resistively terminated into 50Ω loads when not connected to the measuring instrument.

If the reading of the measuring receiver shows fluctuations close to the limit, the reading shall be observed for at least 15 s at each measurement frequency; the higher reading shall be recorded with the exception of any brief isolated high reading which shall be ignored.



4.2. Radiated Emission Measurement

■ Limit

According to §15.209(a), except as provided elsewhere in this subpart, the emissions from an intentional radiator shall not exceed the field strength levels specified in the following table:

Frequency (MHz)	Field Strength ($\mu\text{V}/\text{m}$ at meter)	Measurement Distance (meters)
0.009 – 0.490	2400 / F (kHz)	300
0.490 – 1.705	24000 / F (kHz)	30
1.705 – 30.0	30	30
30 - 88	100**	3
88-216	150**	3
216-960	200**	3
Above 960	500	3

** Except as provided in paragraph (g), fundamental emissions from intentional radiators operating under this Section shall not be located in the frequency bands 54-72 MHz, 76-88 MHz, 174-216 MHz or 470-806 MHz. However, operation within these frequency bands is permitted under other sections of this Part, e.g., Sections 15.231 and 15.241.

■ Setup

9 kHz ~ 30 MHz

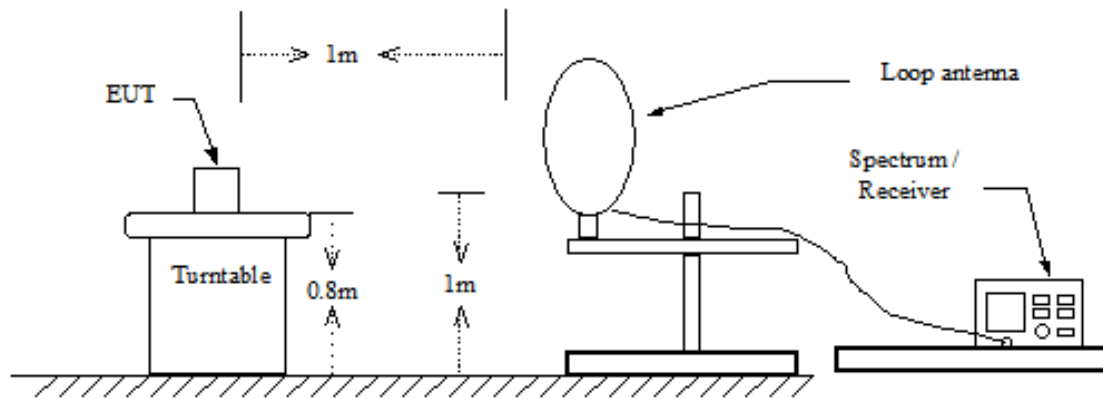

Below 1 GHz

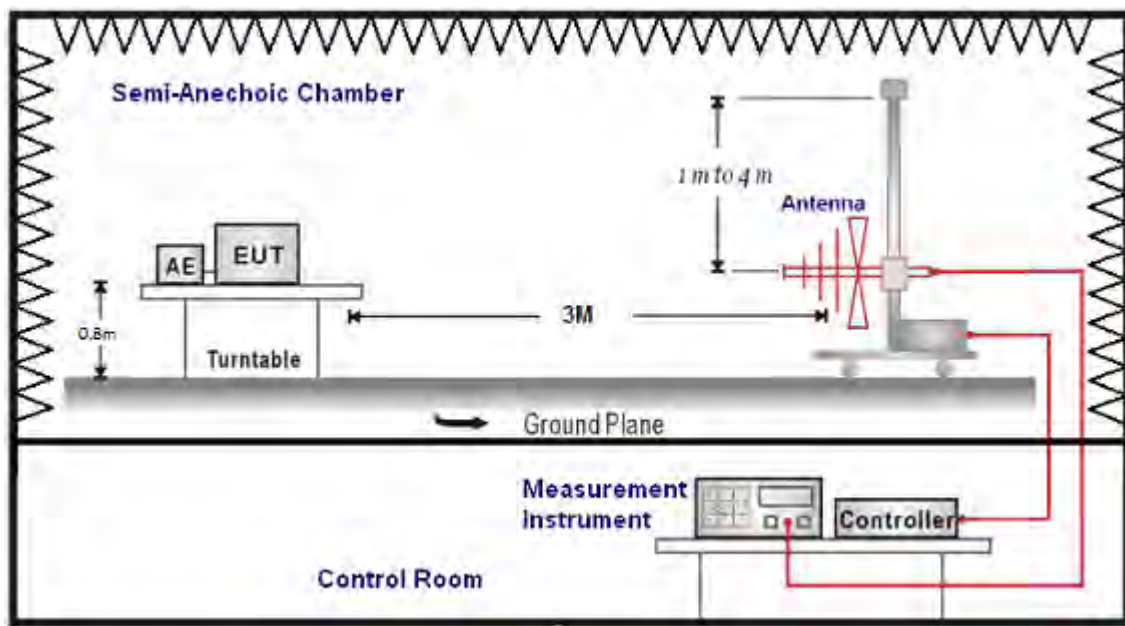

Above 1 GHz

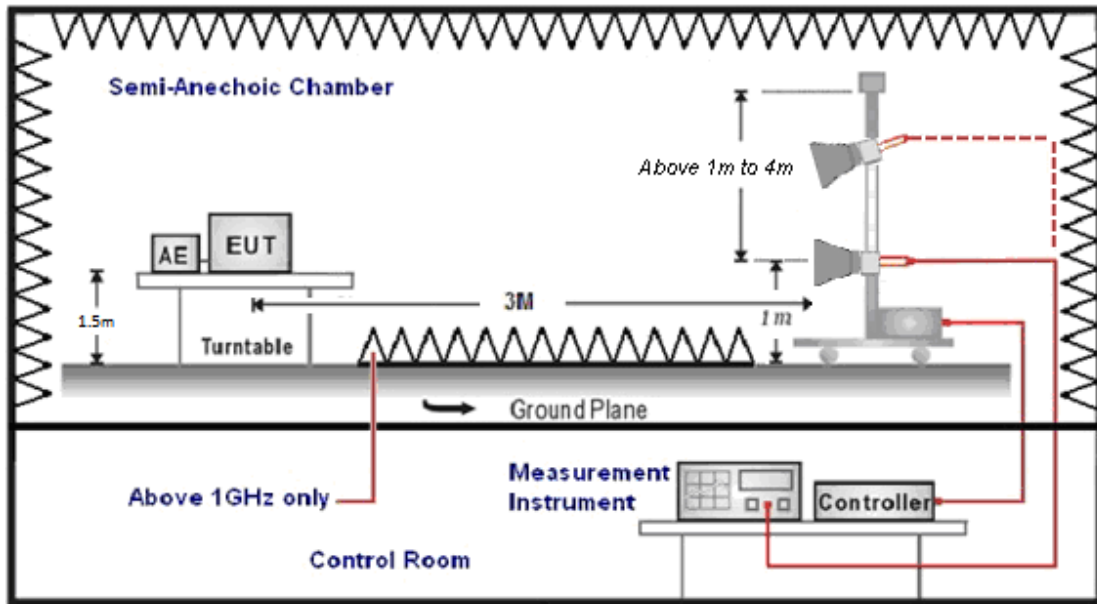

■ Test Procedure

Final radiation measurements were made on a three-meter, Semi Anechoic Chamber. The EUT system was placed on a nonconductive turntable which is 0.8 or 1.5 meters height, top surface 1.0 x 1.5 meter. The spectrum was examined from 250 MHz to 2.5 GHz in order to cover the whole spectrum below 10th harmonic which could generate from the EUT. During the test, EUT was set to transmit continuously & Measurements spectrum range from 9 kHz to 26.5 GHz is investigated.

For measurements below 1 GHz the resolution bandwidth is set to 100 kHz for peak detection measurements or 120 kHz for quasi-peak detection measurements. Peak detection is used unless otherwise noted as quasi-peak.

For measurements above 1 GHz the resolution bandwidth is set to 1 MHz, and then the video bandwidth is set to 3 MHz for peak measurements and 10 Hz for average measurements when Duty cycle >0.98 / 1/T for average measurements when Duty cycle <0.98. A nonconductive material surrounded the EUT to supporting the EUT for standing on three orthogonal planes. At each condition, the EUT was rotated 360 degrees, and the antenna was raised and lowered from one to four meters to find the maximum emission levels. Measurements were taken using both horizontal and vertical antenna polarization.

SCHWARZBECK MESS-ELEKTRONIK Biconilog Antenna at 3 Meter and the SCHWARZBECK Double Ridged Guide Antenna was used in frequencies 1 –26.5 GHz at a distance of 3 meter. The antenna at an angle toward the source of the emission. All test results were extrapolated to equivalent signal at 3 meters utilizing an inverse linear distance extrapolation Factor (20 dB/decade).

For testing above 1 GHz, the emission level of the EUT in peak mode was 20 dB lower than average limit (that means the emission level in peak mode also complies with the limit in average mode), then testing will be stopped and peak values of EUT will be reported, otherwise, the emissions will be measured in average mode again and reported.

Appropriate preamplifiers were used for improving sensitivity and precautions were taken to avoid overloading or desensitizing the spectrum analyzer. No post – detector video filters were used in the test.

The spectrum analyzer's 6 dB bandwidth was set to 1 MHz, and the analyzer was operated in the peak detection mode, for frequencies both below and up 1 GHz. The average levels were obtained by subtracting the duty cycle correction factor from the peak readings.

The following procedures were used to convert the emission levels measured in decibels referenced to 1 microvolt (dBuV) into field intensity in micro volts pre meter (uV/m).

The actual field intensity in decibels referenced to 1 microvolt in to field intensity in micro volts per meter (dBuV/m).



The actual field intensity in referenced to 1 microvolt per meter (dBuV/m) is determined by algebraically adding the measured reading in dBuV, the antenna factor (dB), and cable loss (dB) and Subtracting the gain of preamplifier (dB) is auto calculate in spectrum analyzer.

(1) $\text{Amplitude (dBuV/m)} = \text{FI (dBuV)} + \text{AF (dBuV)} + \text{CL (dBuV)} - \text{Gain (dB)}$

FI= Reading of the field intensity.

AF= Antenna factor.

CL= Cable loss.

P.S Amplitude is auto calculate in spectrum analyzer.

(2) $\text{Actual Amplitude (dBuV/m)} = \text{Amplitude (dBuV)} - \text{Dis(dB)}$

The FCC specified emission limits were calculated according the EUT operating frequency and by following linear interpolation equations:

(a) For fundamental frequency : Transmitter Output < +30 dBm

(b) For spurious frequency : Spurious emission limits = fundamental emission limit /10

Data of measurement within this frequency range without mark in the table above means the reading of emissions are attenuated more than 20 dB below the permissible limits or the field strength is too small to be measured.

4.3. Maximum Conducted Output Power Measurement

■ Limit

For systems using digital modulation in the 2400-2483.5 MHz, the limit for maximum output power is 30 dBm.

And According to 15.247 (b), if transmitting antennas of directional gain greater than 6 dBi are used, the power shall be reduced by the amount in dB that the directional gain of the antenna exceeds 6 dBi.

■ Test Setup

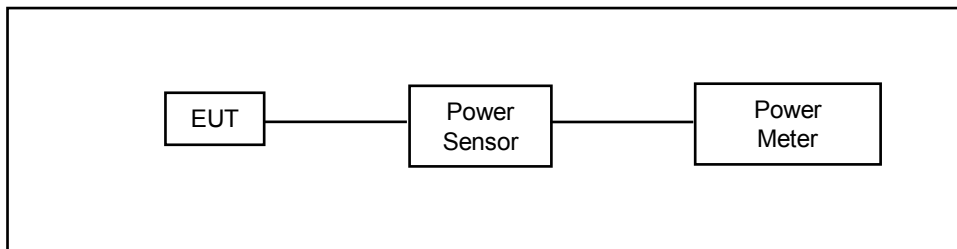

■ Test Procedure

The testing follows the Measurement Procedure of ANSI C63.10:2013 section 11.9.2.3.2 Method AVGPM.

The tests below are run with the EUT's transmitter set at high power in TX mode. The EUT is needed to force selection of output power level and channel number. While testing, EUT was set to transmit continuously. Remove the Subjective device's antenna and connect the RF output port to power sensor.

4.4. 6 dB RF Bandwidth Measurement

■ **Limit**

6 dB RF Bandwidth: Systems using digital modulation techniques may operate in the 2400–2483.5 MHz bands. The minimum 6 dB band-width shall be at least 500 kHz.

■ **Test Setup**

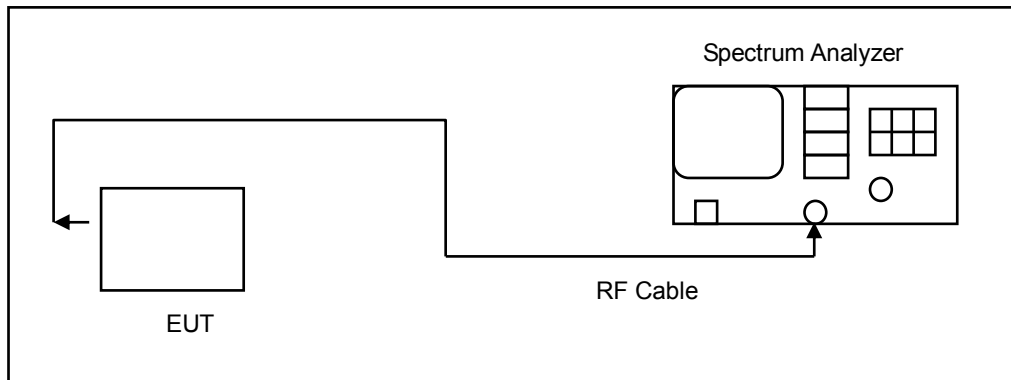

■ **Test Procedure**

The EUT tested to DTS test procedure of ANSI C63.10:2013 section 11.8.2 option2 for compliance to FCC 47CFR 15.247 requirements.

6 dB RF Bandwidth: The antenna port of the EUT was connected to the input of a spectrum analyzer. Analyzer RBW was set to 100 kHz. For each RF output channel investigated, the spectrum analyzer center frequency was set to the channel carrier. A peak output reading was taken, a DISPLAY line was drawn 6 dB lower than peak level. The 6 dB bandwidth was determined from where the channel output spectrum intersected the display line.

The test was performed at 3 channels (Channel low, middle, high)

4.5. Maximum Power Spectral Density Measurement

■ Limit

For digitally modulated systems, the power spectral density conducted from the intentional radiator to the antenna shall not be greater than 8 dBm in any 3 kHz band during any time interval of continuous transmission.

■ Test Setup

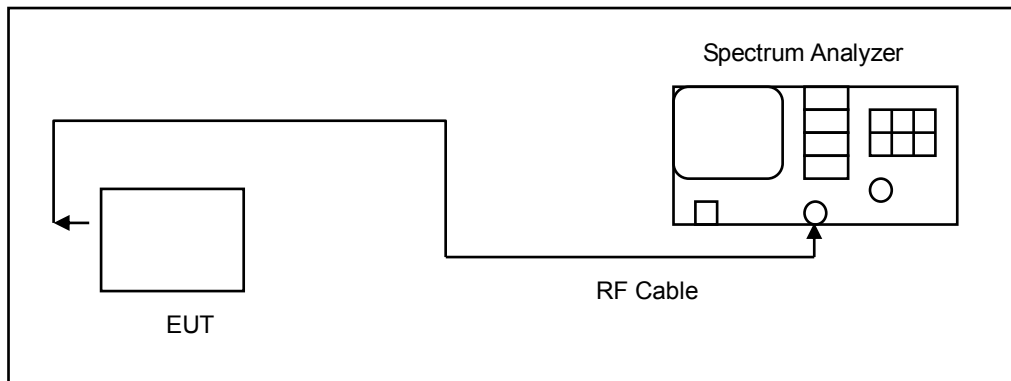

■ Test Procedure

The EUT tested to DTS test procedure of ANSI C63.10:2013 section 11.10.2 Method PKPSD for compliance to FCC 47CFR 15.247 requirements.

1. Set analyzer center frequency to DTS channel center frequency.
2. Set the span to 1.5 times the DTS bandwidth.
3. Set the RBW to: $3 \text{ kHz} \leq \text{RBW} \leq 100 \text{ kHz}$.
4. Set the VBW $\geq 3 \times \text{RBW}$.
5. Detector = peak.
6. Sweep time = auto couple.
7. Trace mode = max hold.
8. Allow trace to fully stabilize.
9. Use the peak marker function to determine the maximum amplitude level within the RBW.
10. If measured value exceeds limit, reduce RBW (no less than 3 kHz) and repeat.

4.6. Out of Band Conducted Emissions Measurement

■ **Limit**

In any 100 kHz bandwidth outside the frequency band in which the spread spectrum or digitally modulated intentional radiator is operating, the radio frequency power that is produced by the intentional radiator shall be at least 30 dB below that in the 100 kHz bandwidth within the band that contains the highest level of the desired power

■ **Test Setup**

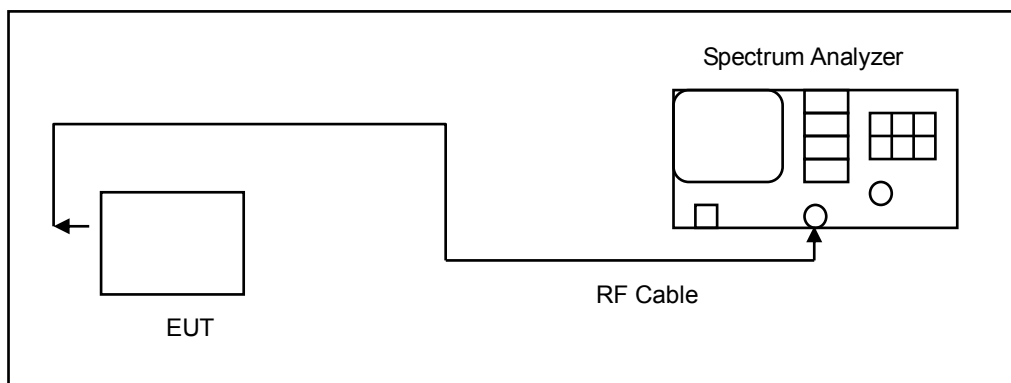

■ **Test Procedure**

In any 100 kHz bandwidth outside the EUT pass band, the RF power produced by the modulation products of the spreading sequence, the information sequence, and the carrier frequency shall be at least 30 dB below that of the maximum in-band 100 kHz emission, antenna output of the EUT was coupled directly to spectrum analyzer; if an external attenuator and/or cable was used, these losses are compensated for with the analyzer OFFSET function.

All other types of emissions from the EUT shall meet the general limits for radiated frequencies outside the pass band.

The test was performed at 3 channels.



4.7. Antenna Measurement

■ Limit

For intentional device, according to 15.203, an intentional radiator shall be designed to ensure that no antenna other than that furnished by the responsible party shall be used with the device.

And According to 15.247 (b), if transmitting antennas of directional gain greater than 6 dBi are used, the power shall be reduced by the amount in dB that the directional gain of the antenna exceeds 6 dBi.

■ Antenna Description

See section 2 – antenna information.



5 Test Results

Annex A. Conducted Emission

Standard:	FCC Part 15.247	Line:	L1
Test item:	Conducted Emission	Power:	AC 120 V/60 Hz
Test Mode:	Mode 1	Temp.(°C)/Hum.(%RH):	26(°C)/60 %RH
Description:			

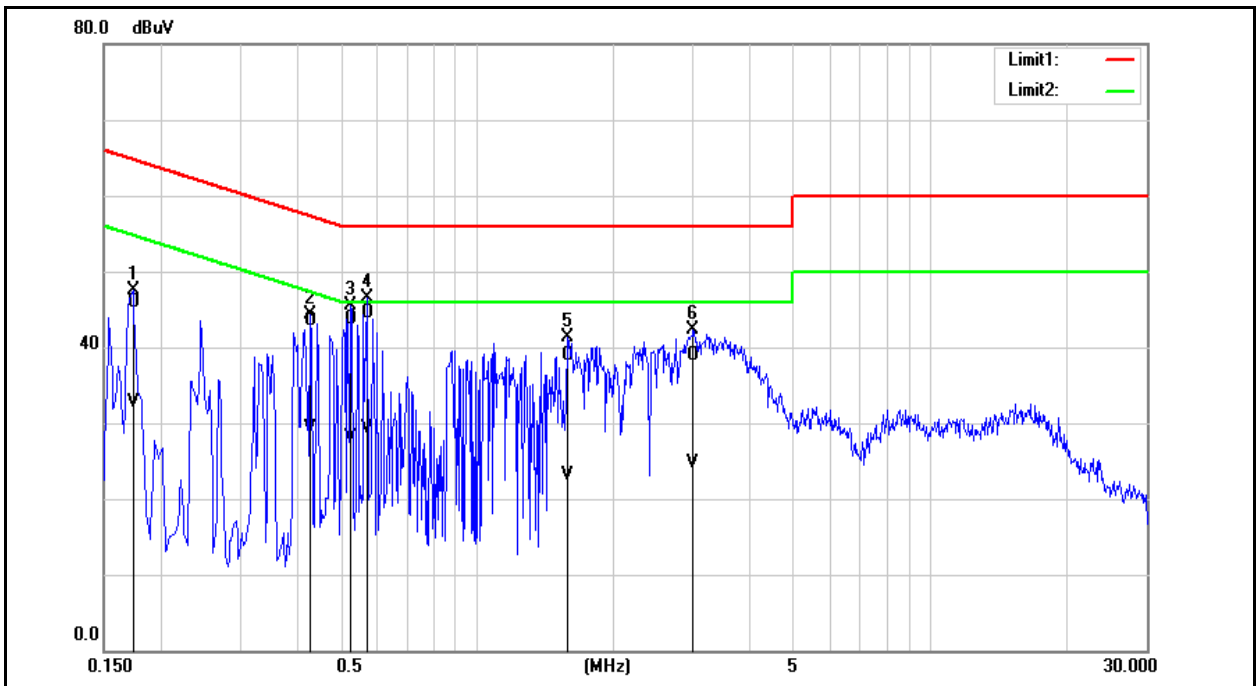

No.	Frequency (MHz)	QP reading (dBuV)	AVG reading (dBuV)	Correction factor (dB)	QP result (dBuV)	AVG result (dBuV)	QP limit (dBuV)	AVG limit (dBuV)	QP margin (dB)	AVG margin (dB)	Remark
1	0.1740	36.29	23.12	9.65	45.94	32.77	64.77	54.77	-18.83	-22.00	Pass
2	0.4300	33.84	19.56	9.66	43.50	29.22	57.25	47.25	-13.75	-18.03	Pass
3	0.5260	33.99	18.54	9.66	43.65	28.20	56.00	46.00	-12.35	-17.80	Pass
4	0.5740	34.93	19.72	9.66	44.59	29.38	56.00	46.00	-11.41	-16.62	Pass
5	1.5860	29.26	13.37	9.70	38.96	23.07	56.00	46.00	-17.04	-22.93	Pass
6	3.0020	29.24	15.03	9.75	38.99	24.78	56.00	46.00	-17.01	-21.22	Pass

Note: 1. Result (dBuV) = Correction factor (dB) + Reading(dBuV).
2. Correction factor (dB) = Cable loss (dB) + L.I.S.N. factor (dB).



Standard:	FCC Part 15.247	Line:	N
Test item:	Conducted Emission	Power:	AC 120 V/60 Hz
Test Mode:	Mode 1	Temp.(°C)/Hum.(%RH):	26(°C)/60 %RH
Description:			

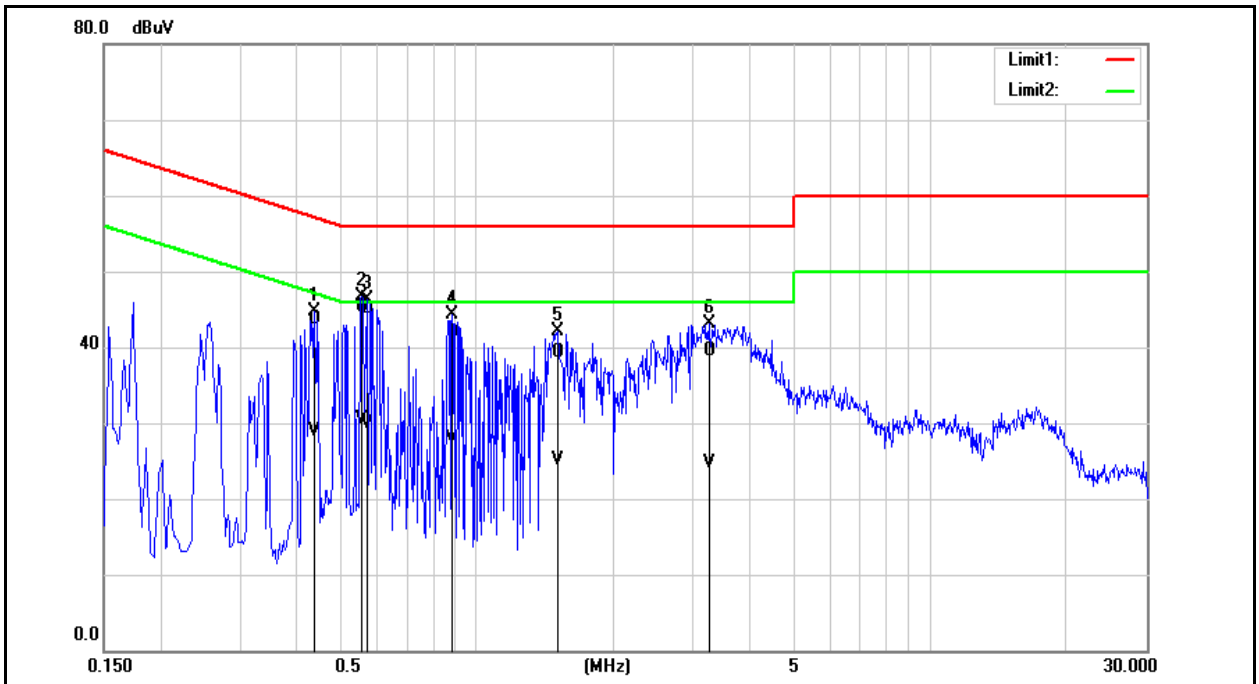

No.	Frequency (MHz)	QP reading (dBuV)	AVG reading (dBuV)	Correction factor (dB)	QP result (dBuV)	AVG result (dBuV)	QP limit (dBuV)	AVG limit (dBuV)	QP margin (dB)	AVG margin (dB)	Remark
1	0.4380	34.00	19.25	9.69	43.69	28.94	57.10	47.10	-13.41	-18.16	Pass
2	0.5580	35.55	20.73	9.69	45.24	30.42	56.00	46.00	-10.76	-15.58	Pass
3	0.5740	35.34	20.20	9.69	45.03	29.89	56.00	46.00	-10.97	-16.11	Pass
4	0.8820	32.12	18.14	9.70	41.82	27.84	56.00	46.00	-14.18	-18.16	Pass
5	1.5060	29.67	15.43	9.73	39.40	25.16	56.00	46.00	-16.60	-20.84	Pass
6	3.2500	29.63	14.94	9.78	39.41	24.72	56.00	46.00	-16.59	-21.28	Pass

Note: 1. Result (dBuV) = Correction factor (dB) + Reading(dBuV).
2. Correction factor (dB) = Cable loss (dB) + L.I.S.N. factor (dB).



Annex B. Conducted Test Results

Maximum Conducted Output Power Measurement

Test Mode	Data Rate (Mbps)	Frequency (MHz)	Average Output Power		
			Measurement Results		Limit
			dBm	W	dBm
Mode 2	1	2412	19.41	0.087	≤ 30
		2437	18.95	0.079	≤ 30
		2462	18.47	0.070	≤ 30
Mode 3	6	2412	18.46	0.070	≤ 30
		2437	18.05	0.064	≤ 30
		2462	17.24	0.053	≤ 30
Mode 4	6.5	2412	17.47	0.056	≤ 30
		2437	17.32	0.054	≤ 30
		2462	16.25	0.042	≤ 30
Mode 5	13.5	2422	16.35	0.043	≤ 30
		2437	16.06	0.040	≤ 30
		2452	15.66	0.037	≤ 30

Note: The relevant measured result has the offset with cable loss already.



6 dB RF Bandwidth Measurement

Test Mode	Frequency (MHz)	Measurement (kHz)	Limit (kHz)
Mode 2	2412	10040	≥ 500
	2437	9572	≥ 500
	2462	9104	≥ 500
Mode 3	2412	16340	≥ 500
	2437	16350	≥ 500
	2462	16330	≥ 500
Mode 4	2412	17560	≥ 500
	2437	17570	≥ 500
	2462	17570	≥ 500
Mode 5	2422	35840	≥ 500
	2437	35720	≥ 500
	2452	35970	≥ 500



■ Test Graphs

Mode 2: IEEE 802.11b Continuous TX mode

<p>2412 MHz</p>	<p>Agilent Spectrum Analyzer - Occupied BW</p> <p>Center Freq: 2.412000000 GHz Trig: Free Run #IF Gain: Low #Atten: 20 dB Avg/Hold: > 1/1 Radio Std: None Radio Device: BTS</p> <p>Ref Offset 11 dB Ref 20.00 dBm</p> <p>Center 2.412 GHz #Res BW 100 kHz #VBW 300 kHz Span 30 MHz Sweep 2.933 ms</p> <p>Occupied Bandwidth 14.425 MHz Total Power 25.3 dBm Transmit Freq Error -22.358 kHz OBW Power 99.00 % x dB Bandwidth 10.04 MHz x dB -6.00 dB</p> <p>File <BB6.png> saved</p>
<p>2437 MHz</p>	<p>Agilent Spectrum Analyzer - Occupied BW</p> <p>Center Freq: 2.437000000 GHz Trig: Free Run #IF Gain: Low #Atten: 20 dB Avg/Hold: > 1/1 Radio Std: None Radio Device: BTS</p> <p>Ref Offset 11 dB Ref 20.00 dBm</p> <p>Center 2.437 GHz #Res BW 100 kHz #VBW 300 kHz Span 30 MHz Sweep 2.933 ms</p> <p>Occupied Bandwidth 14.413 MHz Total Power 25.1 dBm Transmit Freq Error -33.670 kHz OBW Power 99.00 % x dB Bandwidth 9.572 MHz x dB -6.00 dB</p> <p>File <BB6.png> saved</p>
<p>2462 MHz</p>	<p>Agilent Spectrum Analyzer - Occupied BW</p> <p>Center Freq: 2.462000000 GHz Trig: Free Run #IF Gain: Low #Atten: 20 dB Avg/Hold: > 1/1 Radio Std: None Radio Device: BTS</p> <p>Ref Offset 11 dB Ref 20.00 dBm</p> <p>Center 2.462 GHz #Res BW 100 kHz #VBW 300 kHz Span 30 MHz Sweep 2.933 ms</p> <p>Occupied Bandwidth 14.393 MHz Total Power 24.4 dBm Transmit Freq Error -45.602 kHz OBW Power 99.00 % x dB Bandwidth 9.104 MHz x dB -6.00 dB</p> <p>File <BB6.png> saved</p>



Mode 3: IEEE 802.11g Continuous TX mode

2412 MHz



2437 MHz



2462 MHz





Mode 4: IEEE 802.11n 2.4 GHz 20 MHz Continuous TX mode

2412 MHz



2437 MHz



2462 MHz





Mode 5: IEEE 802.11n 2.4 GHz 40 MHz Continuous TX mode

2422 MHz



2437 MHz



2452 MHz





Maximum Power Spectral Density Measurement

Test Mode	Frequency (MHz)	Measurement (dBm/3 kHz)	Limit (dBm/3 kHz)
Mode 2	2412	-4.454	≤ 8
	2437	-4.708	≤ 8
	2462	-5.269	≤ 8
Mode 3	2412	-6.573	≤ 8
	2437	-6.909	≤ 8
	2462	-7.674	≤ 8
Mode 4	2412	-8.492	≤ 8
	2437	-8.350	≤ 8
	2462	-9.646	≤ 8
Mode 5	2422	-11.988	≤ 8
	2437	-12.309	≤ 8
	2452	-12.761	≤ 8



■ Test Graphs

Mode 2: IEEE 802.11b Continuous TX mode	
2412 MHz	<p>Agilent Spectrum Analyzer - Swept SA Ref Offset 11 dB Ref 10.00 dBm Mkr1 2.411172 GHz -4.454 dBm Center 2.412000 GHz #Res BW 3.0 kHz #VBW 10 kHz Sweep 1.588 s (1001 pts) Span 15.06 MHz</p>
2437 MHz	<p>Agilent Spectrum Analyzer - Swept SA Ref Offset 11 dB Ref 10.00 dBm Mkr1 2.436167 GHz -4.708 dBm Center 2.437000 GHz #Res BW 3.0 kHz #VBW 10 kHz Sweep 1.514 s (1001 pts) Span 14.36 MHz</p>
2462 MHz	<p>Agilent Spectrum Analyzer - Swept SA Ref Offset 11 dB Ref 10.00 dBm Mkr1 2.461262 GHz -5.269 dBm Center 2.462000 GHz #Res BW 3.0 kHz #VBW 10 kHz Sweep 1.440 s (1001 pts) Span 13.66 MHz</p>



Mode 3: IEEE 802.11g Continuous TX mode

2412 MHz



2437 MHz

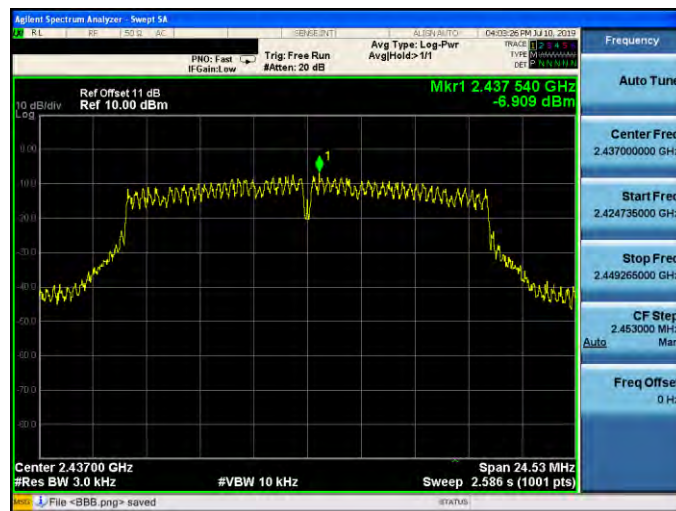

2462 MHz





Mode 4: IEEE 802.11n 2.4 GHz 20 MHz Continuous TX mode

2412 MHz



2437 MHz



2462 MHz





Mode 5: IEEE 802.11n 2.4 GHz 40 MHz Continuous TX mode

2422 MHz

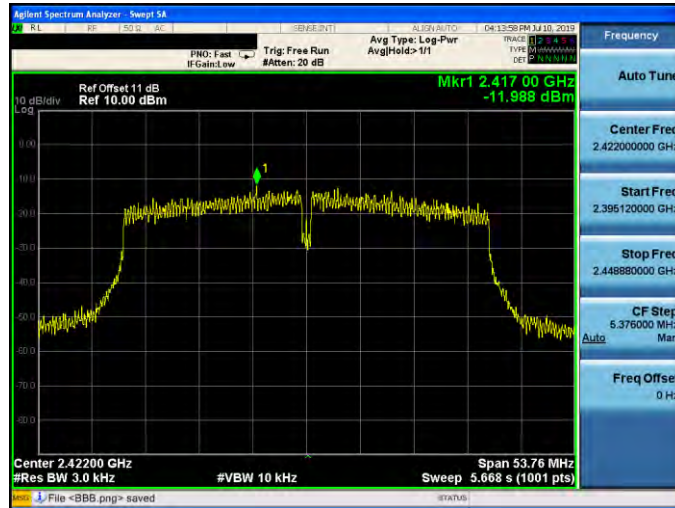

2437 MHz



2452 MHz



Out of Band Conducted Emissions Measurement

■ Test Graphs

Reference level

Mode 2: IEEE 802.11b Continuous TX mode

<p>2412 MHz</p>	<p>Agilent Spectrum Analyzer - Swept SA</p> <p>Ref Offset 11 dB Ref 15.00 dBm</p> <p>Mkr1 2.412 497 GHz 9.462 dBm</p> <p>Center 2.412000 GHz #Res BW 100 kHz #VBW 300 kHz Sweep 1.467 ms (1001 pts)</p> <p>Frequency</p> <p>Auto Tune</p> <p>Center Freq 2.412000000 GHz</p> <p>Start Freq 2.404470000 GHz</p> <p>Stop Freq 2.419530000 GHz</p> <p>CF Step 1.506000 MHz Auto Man</p> <p>Freq Offset 0 Hz</p>
<p>2437 MHz</p>	<p>Agilent Spectrum Analyzer - Swept SA</p> <p>Ref Offset 11 dB Ref 15.00 dBm</p> <p>Mkr1 2.437 503 GHz 9.007 dBm</p> <p>Center 2.437000 GHz #Res BW 100 kHz #VBW 300 kHz Sweep 1.400 ms (1001 pts)</p> <p>Frequency</p> <p>Auto Tune</p> <p>Center Freq 2.437000000 GHz</p> <p>Start Freq 2.429820000 GHz</p> <p>Stop Freq 2.444180000 GHz</p> <p>CF Step 1.436000 MHz Auto Man</p> <p>Freq Offset 0 Hz</p>
<p>2462 MHz</p>	<p>Agilent Spectrum Analyzer - Swept SA</p> <p>Ref Offset 11 dB Ref 15.00 dBm</p> <p>Mkr1 2.461 495 GHz 8.449 dBm</p> <p>Center 2.462000 GHz #Res BW 100 kHz #VBW 300 kHz Sweep 1.333 ms (1001 pts)</p> <p>Frequency</p> <p>Auto Tune</p> <p>Center Freq 2.462000000 GHz</p> <p>Start Freq 2.455170000 GHz</p> <p>Stop Freq 2.468830000 GHz</p> <p>CF Step 1.366000 MHz Auto Man</p> <p>Freq Offset 0 Hz</p>



Mode 3: IEEE 802.11g Continuous TX mode

2412 MHz



2437 MHz



2462 MHz





Mode 4: IEEE 802.11n 2.4 GHz 20 MHz Continuous TX mode

2412 MHz



2437 MHz



2462 MHz

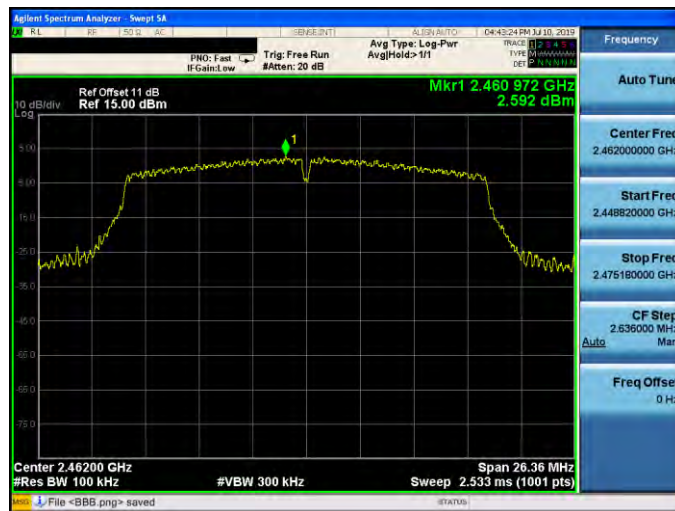



Mode 5: IEEE 802.11n 2.4 GHz 40 MHz Continuous TX mode

2422 MHz



2437 MHz



2452 MHz





Out of Band Conducted Emissions

Mode 2: IEEE 802.11b Continuous TX mode

2412 MHz

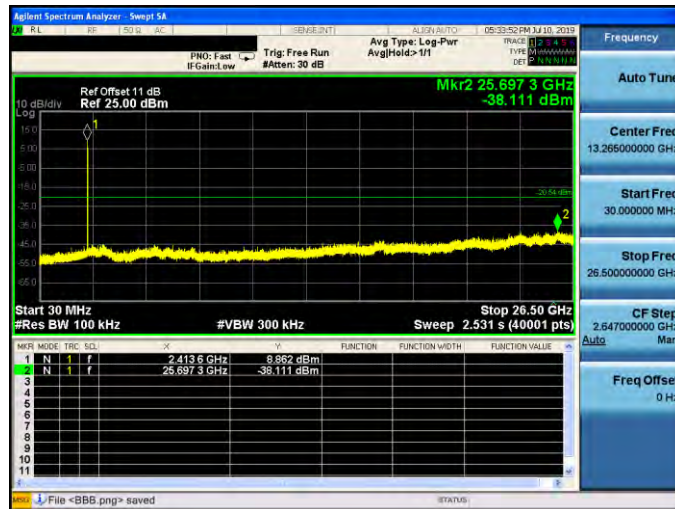

2437 MHz

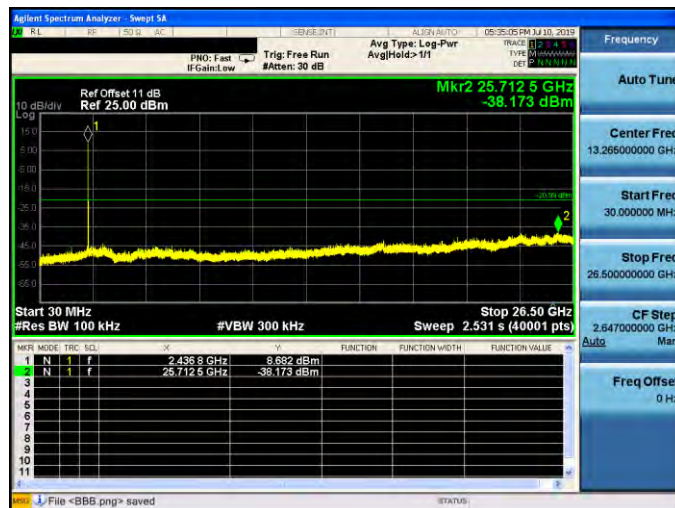

2462 MHz

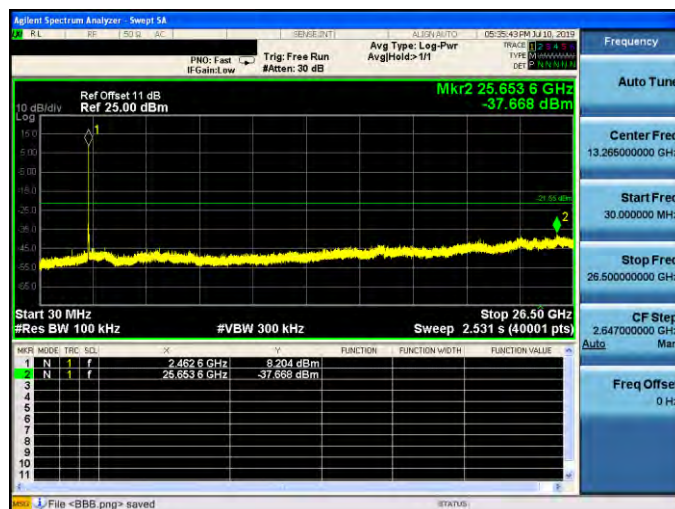



Mode 3: IEEE 802.11g Continuous TX mode

2412 MHz

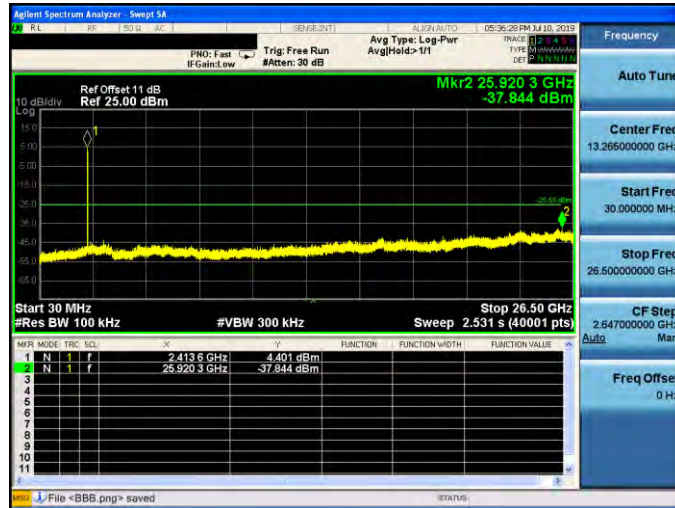

2437 MHz

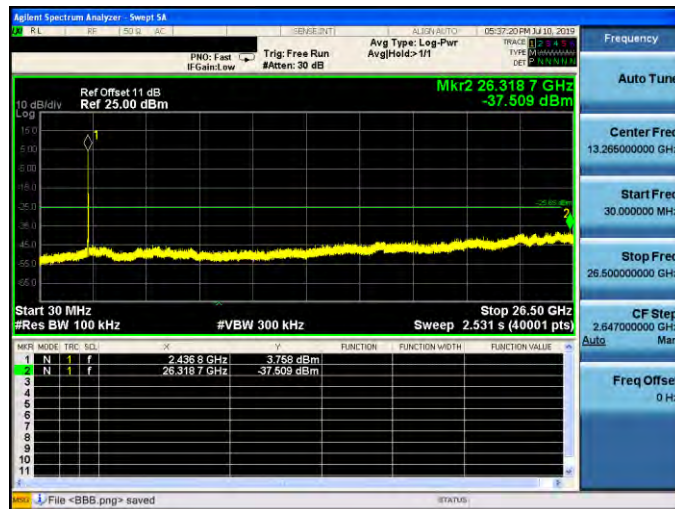

2462 MHz

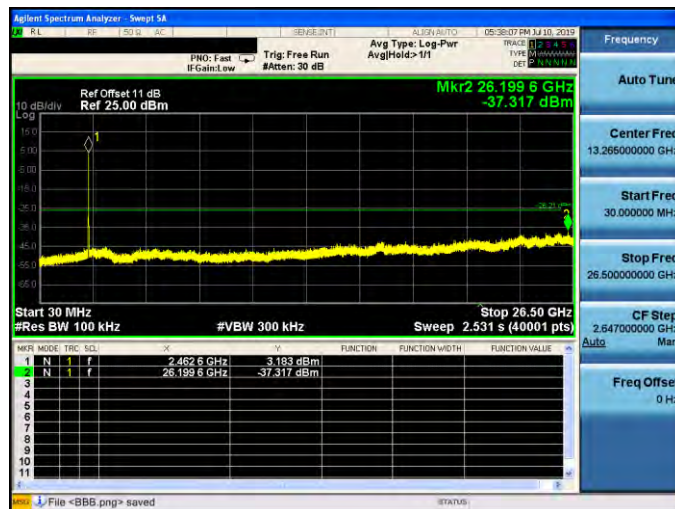



Mode 4: IEEE 802.11n 2.4 GHz 20 MHz Continuous TX mode

2412 MHz

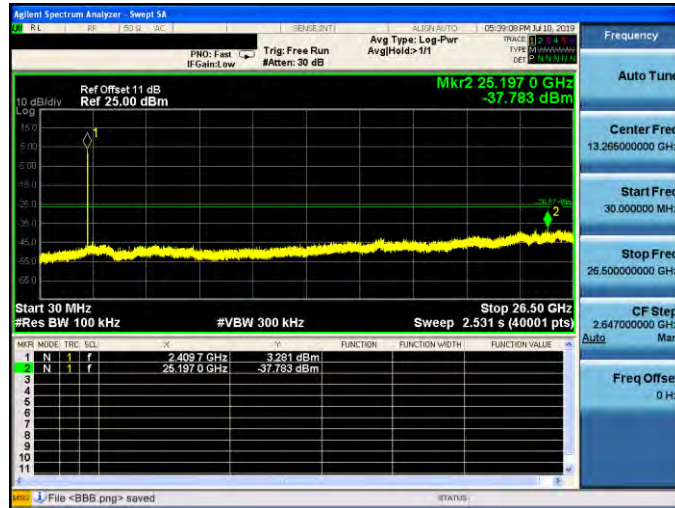

2437 MHz

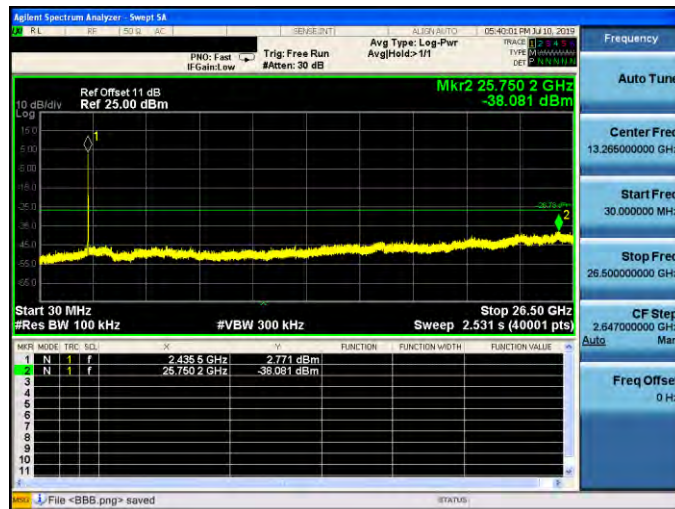

2462 MHz

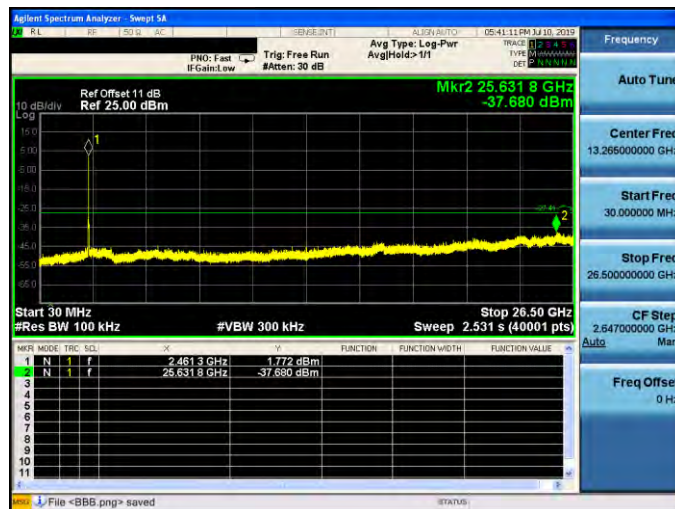



Mode 5: IEEE 802.11n 2.4 GHz 40 MHz Continuous TX mode

2422 MHz

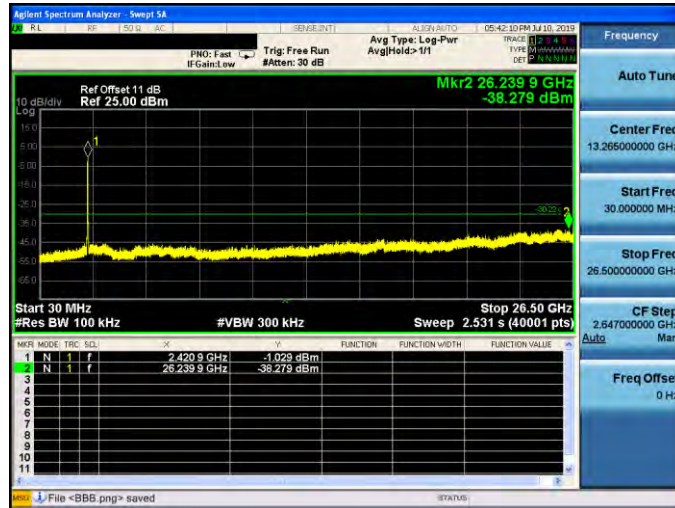

2437 MHz

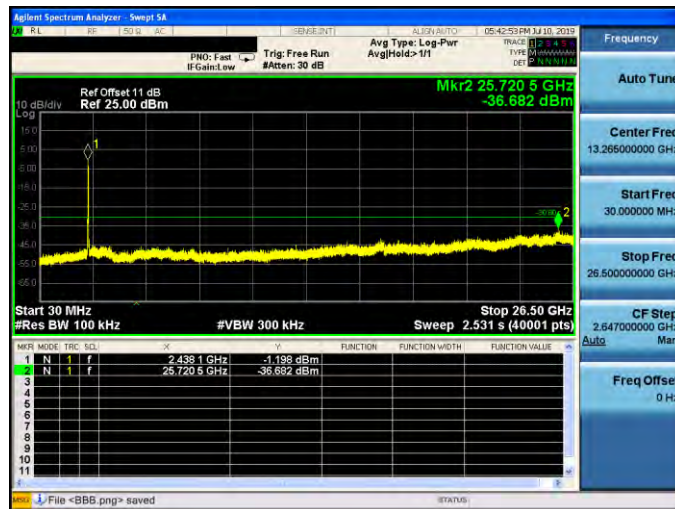

2452 MHz

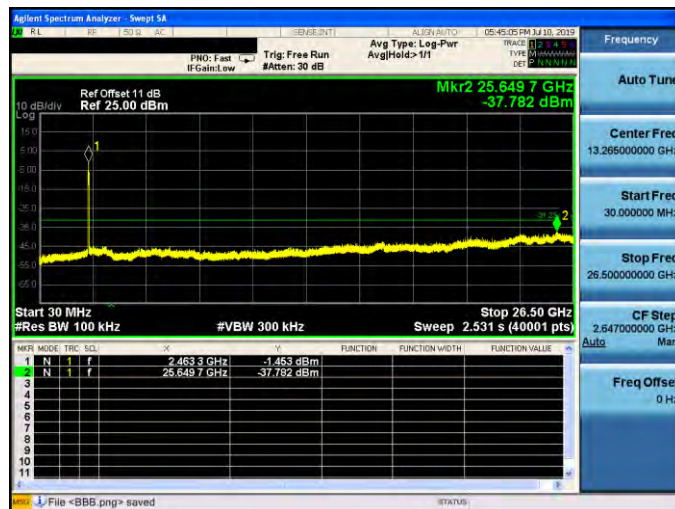

Conducted Band Edge

Mode 2: IEEE 802.11b Continuous TX mode

2412 MHz

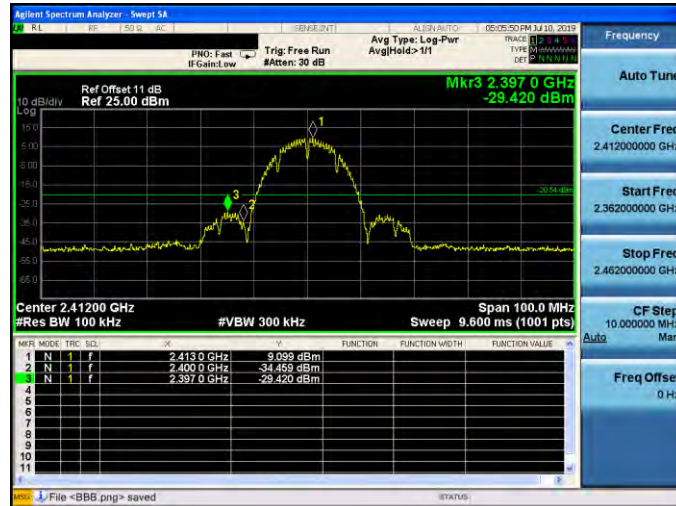

2462 MHz

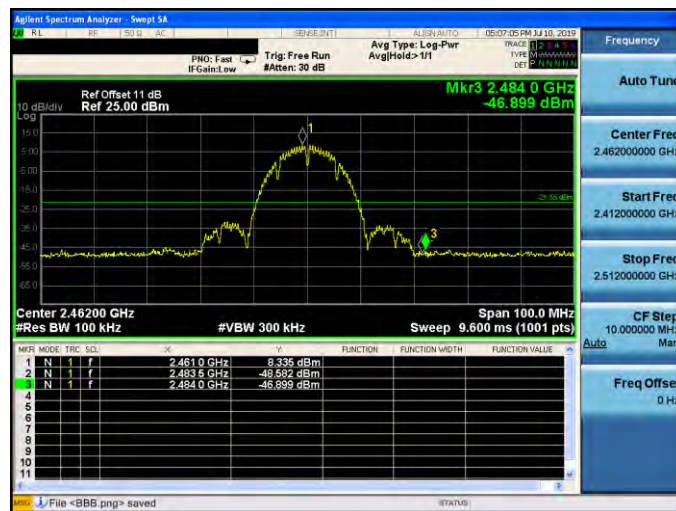

Mode 3: IEEE 802.11g Continuous TX mode

2412 MHz

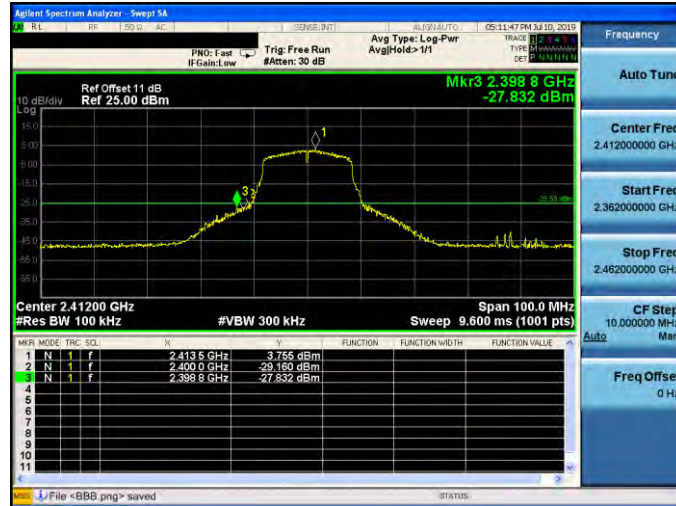

2462 MHz

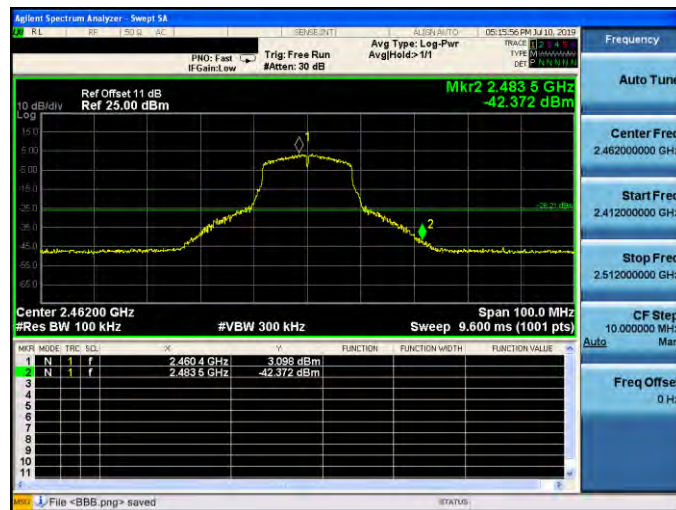

Mode 4: IEEE 802.11n 2.4 GHz 20 MHz Continuous TX mode

2412 MHz

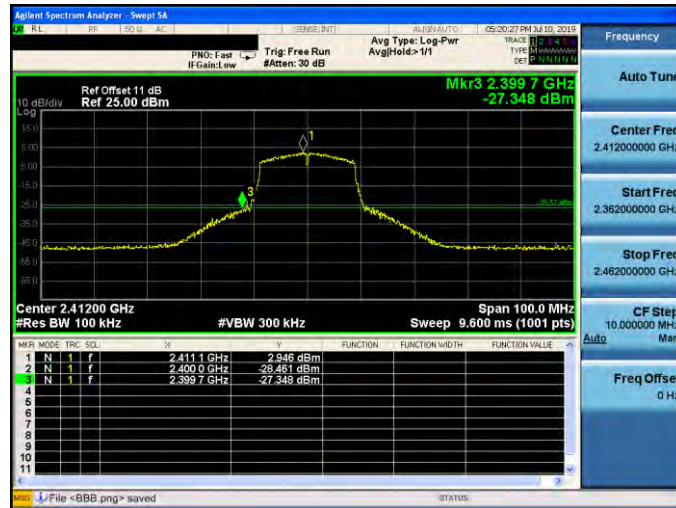

2462 MHz

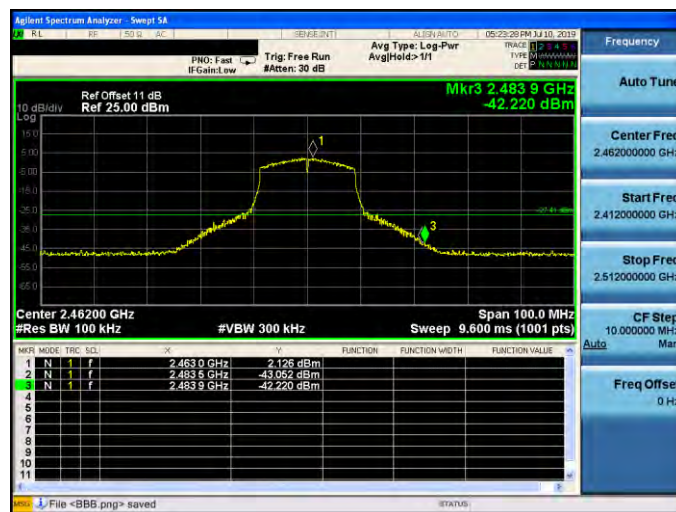

Mode 5: IEEE 802.11n 2.4 GHz 40 MHz Continuous TX mode

2422 MHz



2452 MHz



Annex C. Radiated Emission Test Results

Harmonic

Below 1 GHz

Standard:	FCC Part 15.247	Test Distance:	3 m
Test item:	Harmonic	Power:	AC 120 V/60 Hz
Frequency:	2412 MHz	Temp.(°C)/Hum.(%RH):	26(°C)/60 %RH
Test Mode:	Mode 1		

Frequency (MHz)	Reading (dBuV)	Correct Factor (dB/m)	Result (dBuV/m)	Limit (dBuV/m)	Margin (dB)	Remark	Ant.Polar. H / V
34.8500	44.05	-7.60	36.45	40.00	-3.55	QP	H
162.8900	47.36	-5.83	41.53	43.50	-1.97	QP	H
174.5300	47.71	-6.46	41.25	43.50	-2.25	QP	H
222.0600	46.41	-7.45	38.96	46.00	-7.04	QP	H
260.8600	43.00	-5.72	37.28	46.00	-8.72	QP	H
688.6300	36.29	3.31	39.60	46.00	-6.40	QP	H
42.6100	39.63	-6.73	32.90	40.00	-7.10	QP	V
99.8400	45.47	-11.09	34.38	43.50	-9.12	QP	V
174.5300	41.80	-6.46	35.34	43.50	-8.16	QP	V
207.5100	42.72	-7.87	34.85	43.50	-8.65	QP	V
518.8800	33.01	0.00	33.01	46.00	-12.99	QP	V
597.4500	35.81	2.10	37.91	46.00	-8.09	QP	V

Note:1.Result (dBuV/m) = Correct Factor (dB/m) + Reading(dBuV).

Example: 36.45 = -7.60 + 44.05

2.Correction factor (dB/m) = Antenna Factor (dB/m) + Cable loss (dB) – Pre-Amplifier gain (dB).

3.When the peak results are less than average limit, so not need to evaluate the average.



Above 1 GHz

Standard:	FCC Part 15.247	Test Distance:	3 m
Test item:	Harmonic	Power:	AC 120 V/60 Hz
Frequency:	2412 MHz	Temp.(°C)/Hum.(%RH):	26(°C)/60% RH
Mode:	Mode 2		
Ant.Polar.:	Horizontal		

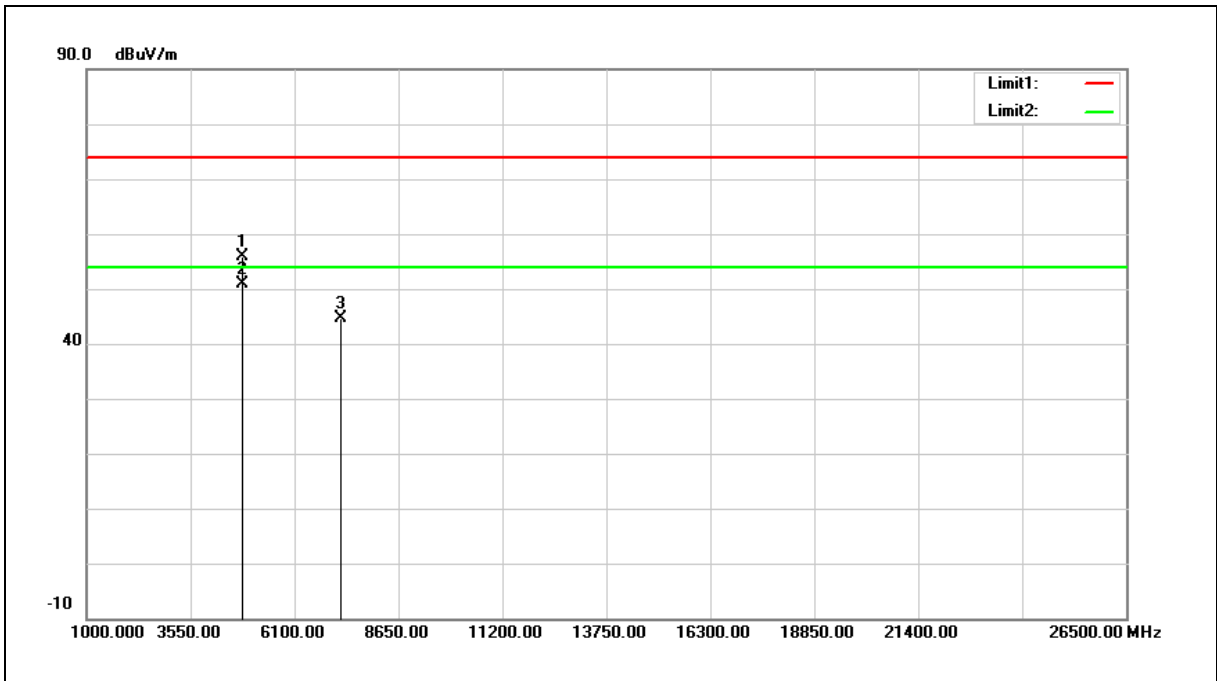

No.	Frequency (MHz)	Reading (dBuV)	Correct Factor (dB/m)	Result (dBuV/m)	Limit (dBuV/m)	Margin (dB)	Remark
1	4824.000	50.21	5.57	55.78	74.00	-18.22	peak
2	4824.000	45.36	5.57	50.93	54.00	-3.07	AVG
3	7236.000	32.54	11.98	44.52	74.00	-29.48	peak

Note:1.Result (dBuV/m) = Correct Factor (dB/m) + Reading(dBuV).

Example: 55.78 = 5.57 + 50.21

2.Correction factor (dB/m) = Antenna Factor (dB/m) + Cable loss (dB) – Pre-Amplifier gain (dB).

3. When the peak results are less than average limit, so not need to evaluate the average.



Standard:	FCC Part 15.247	Test Distance:	3 m
Test item:	Harmonic	Power:	AC 120 V/60 Hz
Frequency:	2412 MHz	Temp.(°C)/Hum.(%RH):	26(°C)/60% RH
Mode:	Mode 2		
Ant.Polar.:	Vertical		

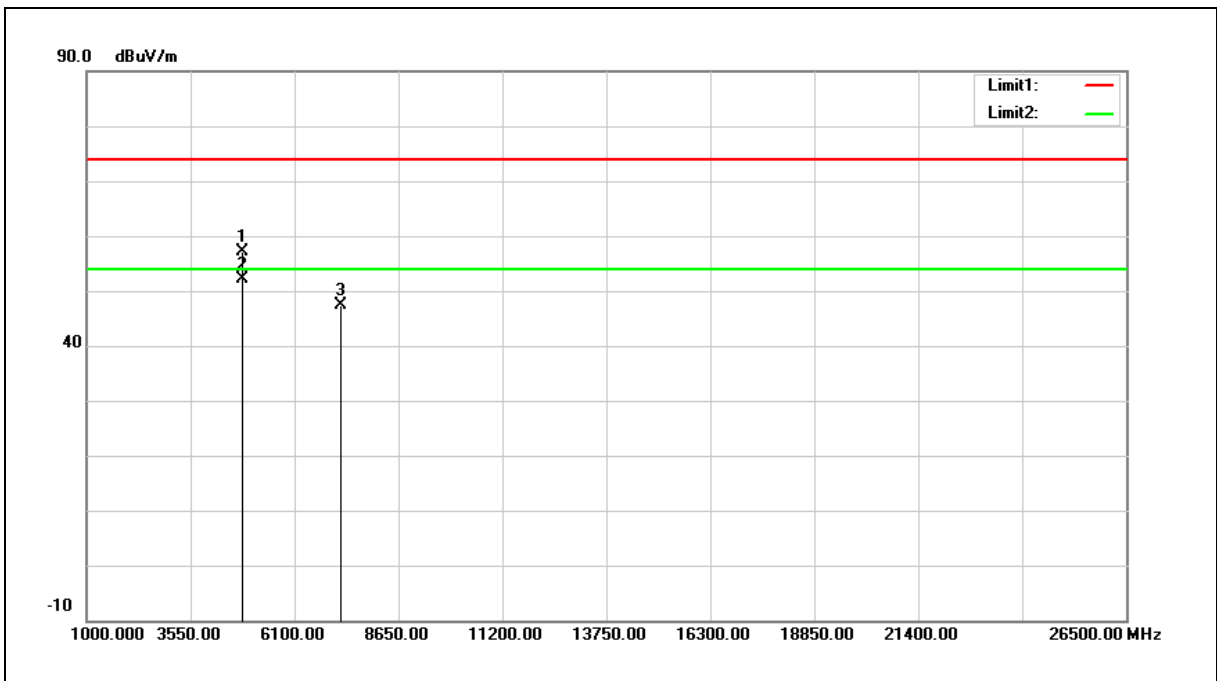

No.	Frequency (MHz)	Reading (dBuV)	Correct Factor (dB/m)	Result (dBuV/m)	Limit (dBuV/m)	Margin (dB)	Remark
1	4824.000	51.58	5.57	57.15	74.00	-16.85	peak
2	4824.000	46.60	5.57	52.17	54.00	-1.83	AVG
3	7236.000	35.44	11.98	47.42	74.00	-26.58	peak

Note:1.Result (dBuV/m) = Correct Factor (dB/m) + Reading(dBuV).

Example: 57.15 = 5.57 + 51.58

2.Correction factor (dB/m) = Antenna Factor (dB/m) + Cable loss (dB) – Pre-Amplifier gain (dB).

3. When the peak results are less than average limit, so not need to evaluate the average.



Standard:	FCC Part 15.247	Test Distance:	3 m
Test item:	Harmonic	Power:	AC 120 V/60 Hz
Frequency:	2437 MHz	Temp.(°C)/Hum.(%RH):	26(°C)/60% RH
Mode:	Mode 2		
Ant.Polar.:	Horizontal		

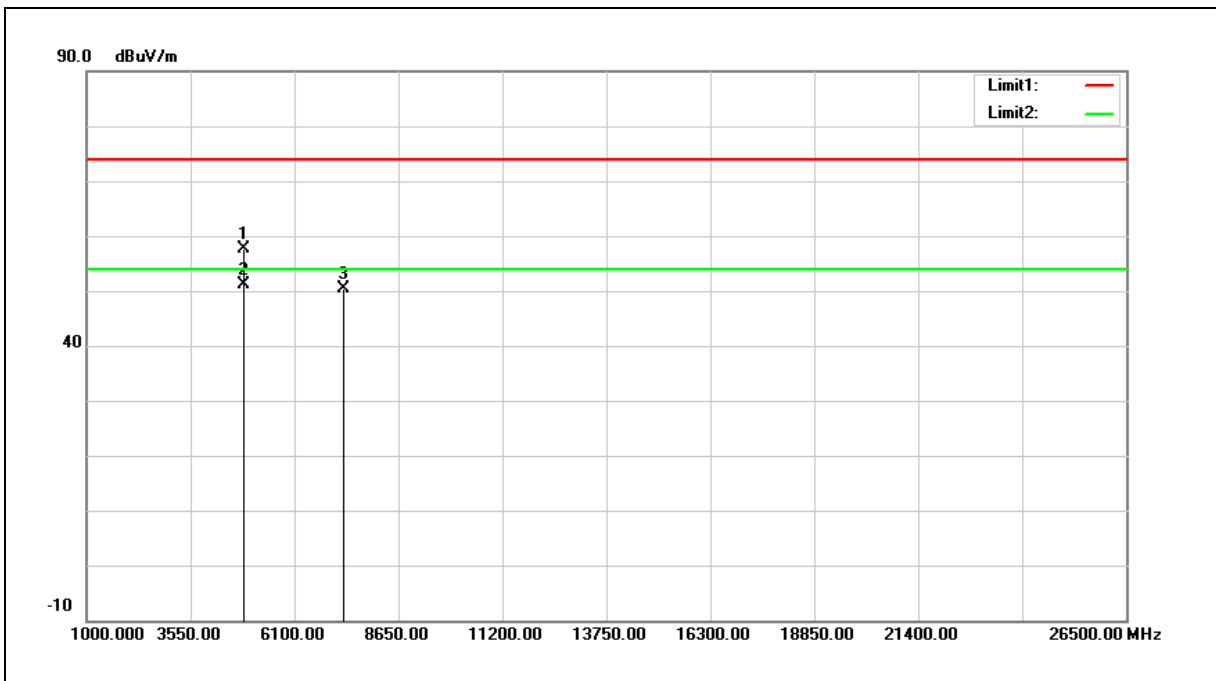

No.	Frequency (MHz)	Reading (dBuV)	Correct Factor (dB/m)	Result (dBuV/m)	Limit (dBuV/m)	Margin (dB)	Remark
1	4874.000	51.84	5.67	57.51	74.00	-16.49	peak
2	4874.000	45.52	5.67	51.19	54.00	-2.81	AVG
3	7311.000	38.32	12.15	50.47	74.00	-23.53	peak

Note:1.Result (dBuV/m) = Correct Factor (dB/m) + Reading(dBuV).

2.Correction factor (dB/m) = Antenna Factor (dB/m) + Cable loss (dB) – Pre-Amplifier gain (dB).

3. When the peak results are less than average limit, so not need to evaluate the average.



Standard:	FCC Part 15.247	Test Distance:	3 m
Test item:	Harmonic	Power:	AC 120 V/60 Hz
Frequency:	2437 MHz	Temp.(°C)/Hum.(%RH):	26(°C)/60% RH
Mode:	Mode 2		
Ant.Polar.:	Vertical		

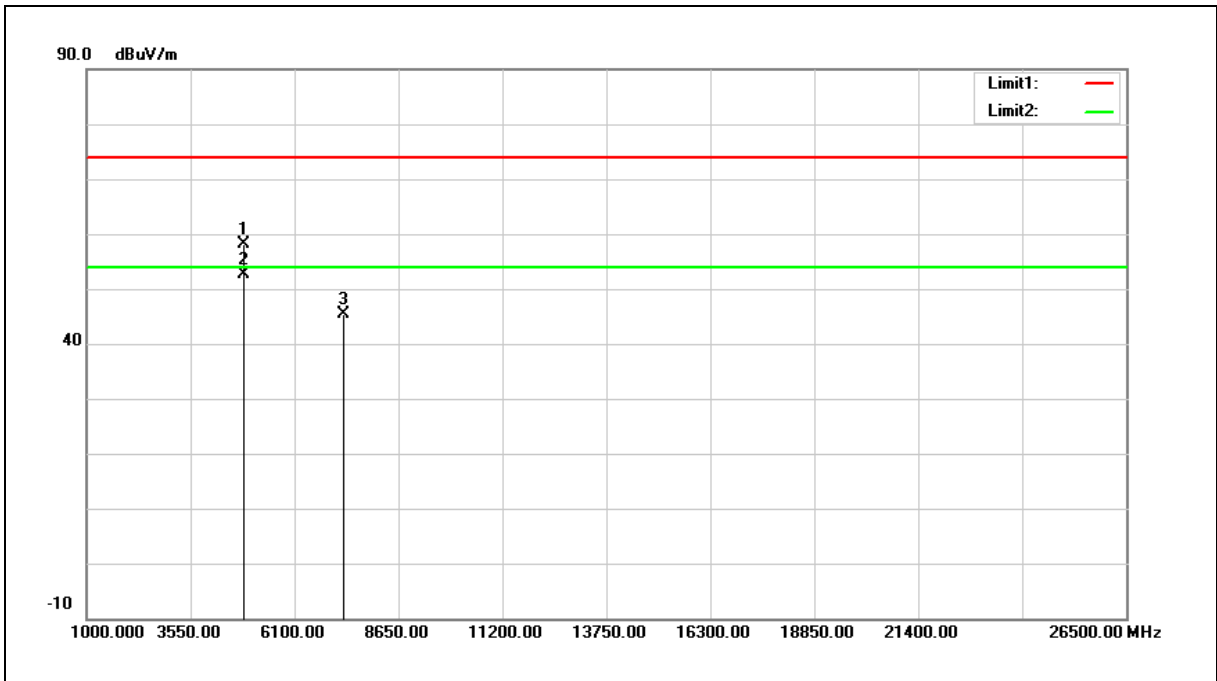

No.	Frequency (MHz)	Reading (dBuV)	Correct Factor (dB/m)	Result (dBuV/m)	Limit (dBuV/m)	Margin (dB)	Remark
1	4874.000	52.35	5.67	58.02	74.00	-15.98	peak
2	4874.000	46.92	5.67	52.59	54.00	-1.41	AVG
3	7311.000	33.24	12.15	45.39	74.00	-28.61	peak

Note:1.Result (dBuV/m) = Correct Factor (dB/m) + Reading(dBuV).

2.Correction factor (dB/m) = Antenna Factor (dB/m) + Cable loss (dB) – Pre-Amplifier gain (dB).

3. When the peak results are less than average limit, so not need to evaluate the average.



Standard:	FCC Part 15.247	Test Distance:	3 m
Test item:	Harmonic	Power:	AC 120 V/60 Hz
Frequency:	2462 MHz	Temp.(°C)/Hum.(%RH):	26(°C)/60% RH
Mode:	Mode 2		
Ant.Polar.:	Horizontal		

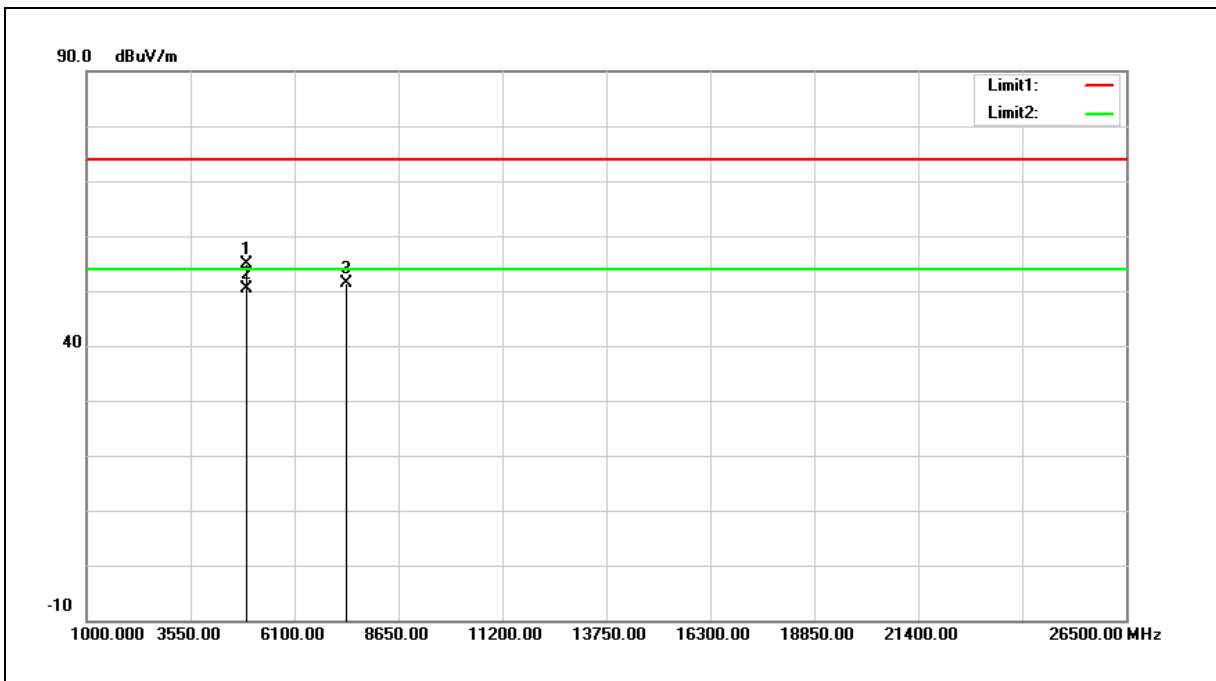

No.	Frequency (MHz)	Reading (dBuV)	Correct Factor (dB/m)	Result (dBuV/m)	Limit (dBuV/m)	Margin (dB)	Remark
1	4924.000	49.08	5.77	54.85	74.00	-19.15	peak
2	4924.000	44.56	5.77	50.33	54.00	-3.67	AVG
3	7386.000	39.06	12.33	51.39	74.00	-22.61	peak

Note:1.Result (dBuV/m) = Correct Factor (dB/m) + Reading(dBuV).

2.Correction factor (dB/m) = Antenna Factor (dB/m) + Cable loss (dB) – Pre-Amplifier gain (dB).

3. When the peak results are less than average limit, so not need to evaluate the average.



Standard:	FCC Part 15.247	Test Distance:	3 m
Test item:	Harmonic	Power:	AC 120 V/60 Hz
Frequency:	2462 MHz	Temp.(°C)/Hum.(%RH):	26(°C)/60% RH
Mode:	Mode 2		
Ant.Polar.:	Vertical		

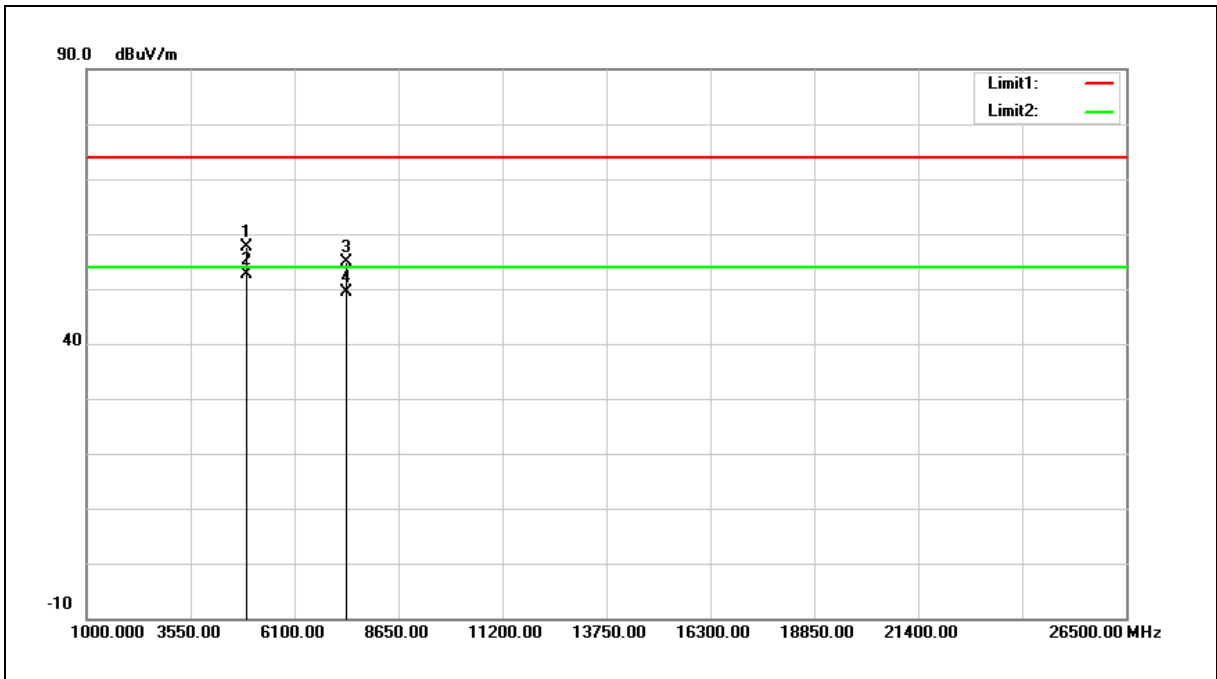

No.	Frequency (MHz)	Reading (dBuV)	Correct Factor (dB/m)	Result (dBuV/m)	Limit (dBuV/m)	Margin (dB)	Remark
1	4924.000	51.80	5.77	57.57	74.00	-16.43	peak
2	4924.000	46.88	5.77	52.65	54.00	-1.35	AVG
3	7386.000	42.59	12.33	54.92	74.00	-19.08	peak
4	7386.000	37.04	12.33	49.37	54.00	-4.63	AVG

Note:1.Result (dBuV/m) = Correct Factor (dB/m) + Reading(dBuV).

2.Correction factor (dB/m) = Antenna Factor (dB/m) + Cable loss (dB) – Pre-Amplifier gain (dB).

3. When the peak results are less than average limit, so not need to evaluate the average.



Standard:	FCC Part 15.247	Test Distance:	3 m
Test item:	Harmonic	Power:	AC 120 V/60 Hz
Frequency:	2412 MHz	Temp.(°C)/Hum.(%RH):	26(°C)/60% RH
Mode:	Mode 3		
Ant.Polar.:	Horizontal		

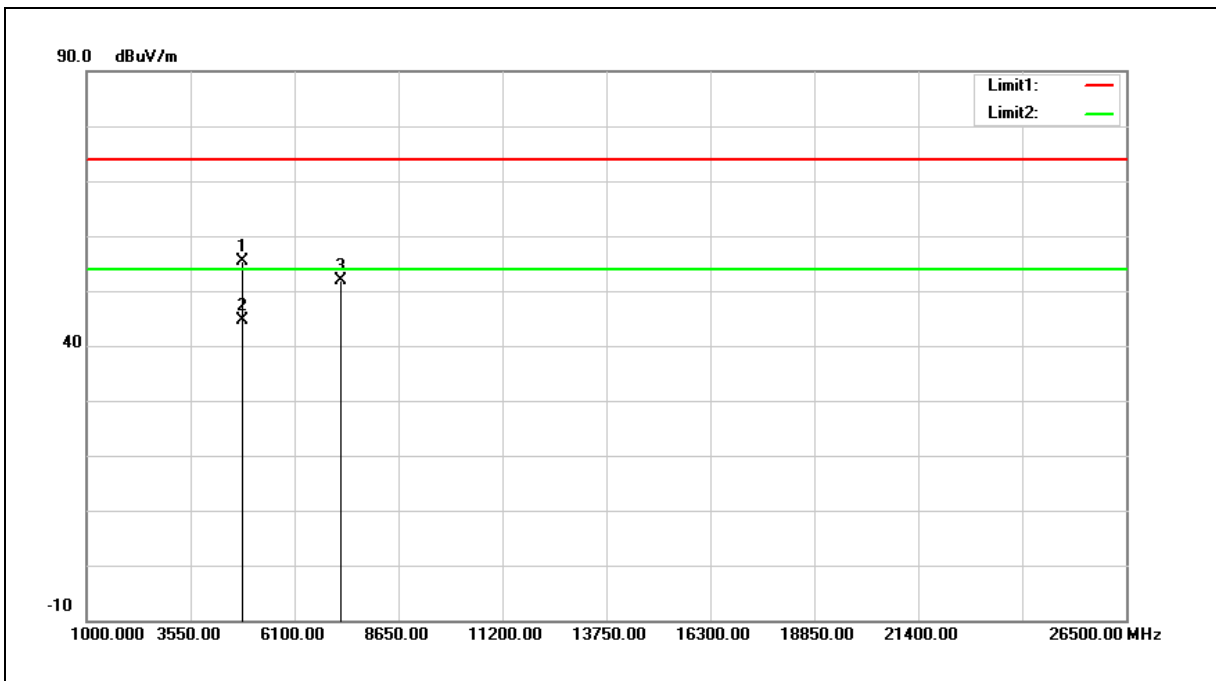

No.	Frequency (MHz)	Reading (dBuV)	Correct Factor (dB/m)	Result (dBuV/m)	Limit (dBuV/m)	Margin (dB)	Remark
1	4824.000	49.88	5.57	55.45	74.00	-18.55	peak
2	4824.000	39.07	5.57	44.64	54.00	-9.36	AVG
3	7236.000	39.95	11.98	51.93	74.00	-22.07	peak

Note:1.Result (dBuV/m) = Correct Factor (dB/m) + Reading(dBuV).

2.Correction factor (dB/m) = Antenna Factor (dB/m) + Cable loss (dB) – Pre-Amplifier gain (dB).

3. When the peak results are less than average limit, so not need to evaluate the average.



Standard:	FCC Part 15.247	Test Distance:	3 m
Test item:	Harmonic	Power:	AC 120 V/60 Hz
Frequency:	2412 MHz	Temp.(°C)/Hum.(%RH):	26(°C)/60% RH
Mode:	Mode 3		
Ant.Polar.:	Vertical		

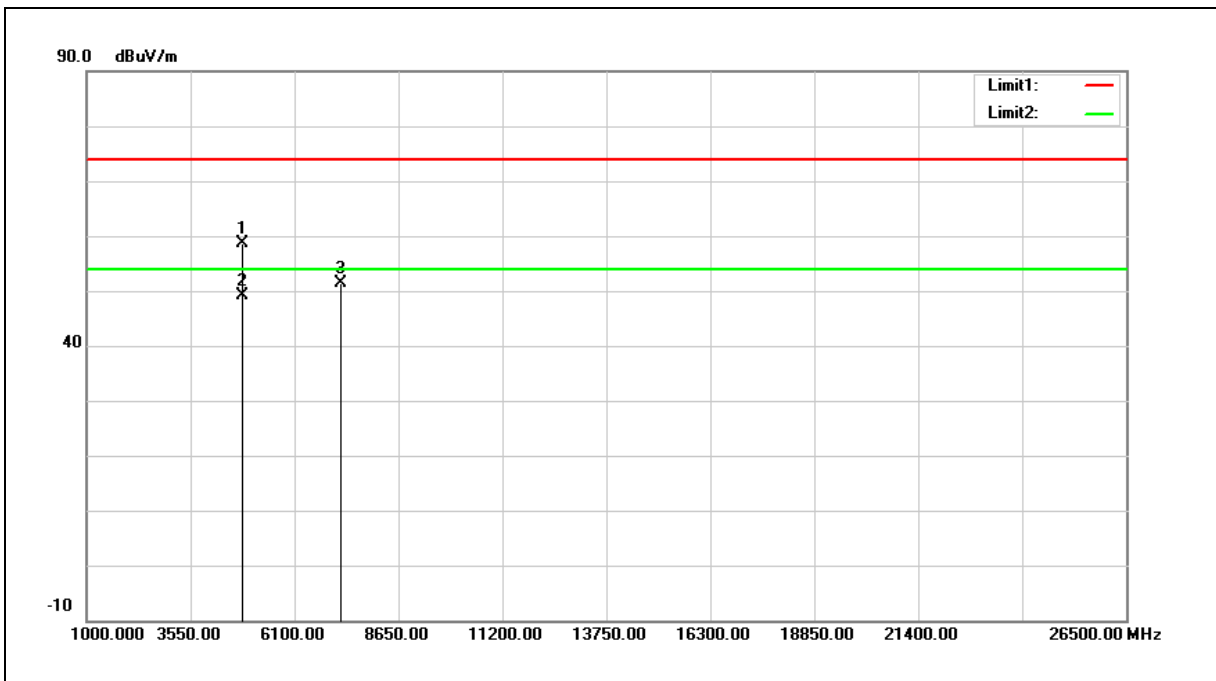

No.	Frequency (MHz)	Reading (dBuV)	Correct Factor (dB/m)	Result (dBuV/m)	Limit (dBuV/m)	Margin (dB)	Remark
1	4824.000	53.09	5.57	58.66	74.00	-15.34	peak
2	4824.000	43.60	5.57	49.17	54.00	-4.83	AVG
3	7236.000	39.45	11.98	51.43	74.00	-22.57	peak

Note:1.Result (dBuV/m) = Correct Factor (dB/m) + Reading(dBuV).

2.Correction factor (dB/m) = Antenna Factor (dB/m) + Cable loss (dB) – Pre-Amplifier gain (dB).

3. When the peak results are less than average limit, so not need to evaluate the average.



Standard:	FCC Part 15.247	Test Distance:	3 m
Test item:	Harmonic	Power:	AC 120 V/60 Hz
Frequency:	2437 MHz	Temp.(°C)/Hum.(%RH):	26(°C)/60% RH
Mode:	Mode 3		
Ant.Polar.:	Horizontal		

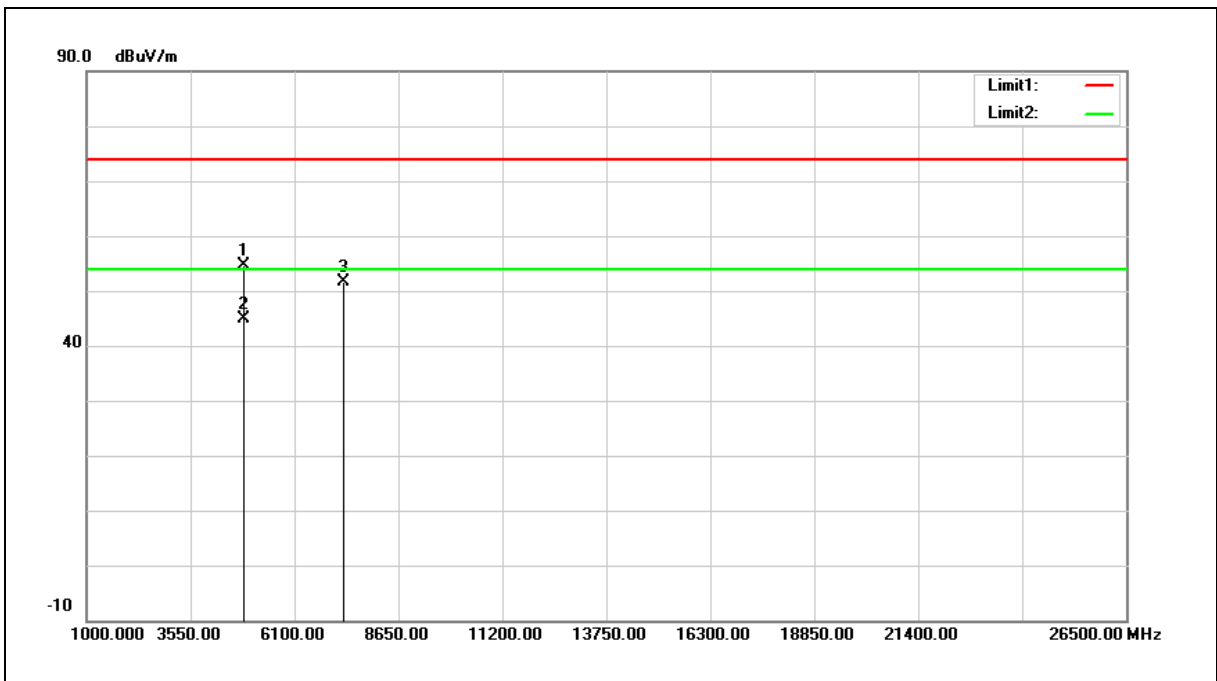

No.	Frequency (MHz)	Reading (dBuV)	Correct Factor (dB/m)	Result (dBuV/m)	Limit (dBuV/m)	Margin (dB)	Remark
1	4874.000	48.94	5.67	54.61	74.00	-19.39	peak
2	4874.000	39.22	5.67	44.89	54.00	-9.11	AVG
3	7311.000	39.56	12.15	51.71	74.00	-22.29	peak

Note:1.Result (dBuV/m) = Correct Factor (dB/m) + Reading(dBuV).

2.Correction factor (dB/m) = Antenna Factor (dB/m) + Cable loss (dB) – Pre-Amplifier gain (dB).

3. When the peak results are less than average limit, so not need to evaluate the average.



Standard:	FCC Part 15.247	Test Distance:	3 m
Test item:	Harmonic	Power:	AC 120 V/60 Hz
Frequency:	2437 MHz	Temp.(°C)/Hum.(%RH):	26(°C)/60% RH
Mode:	Mode 3		
Ant.Polar.:	Vertical		

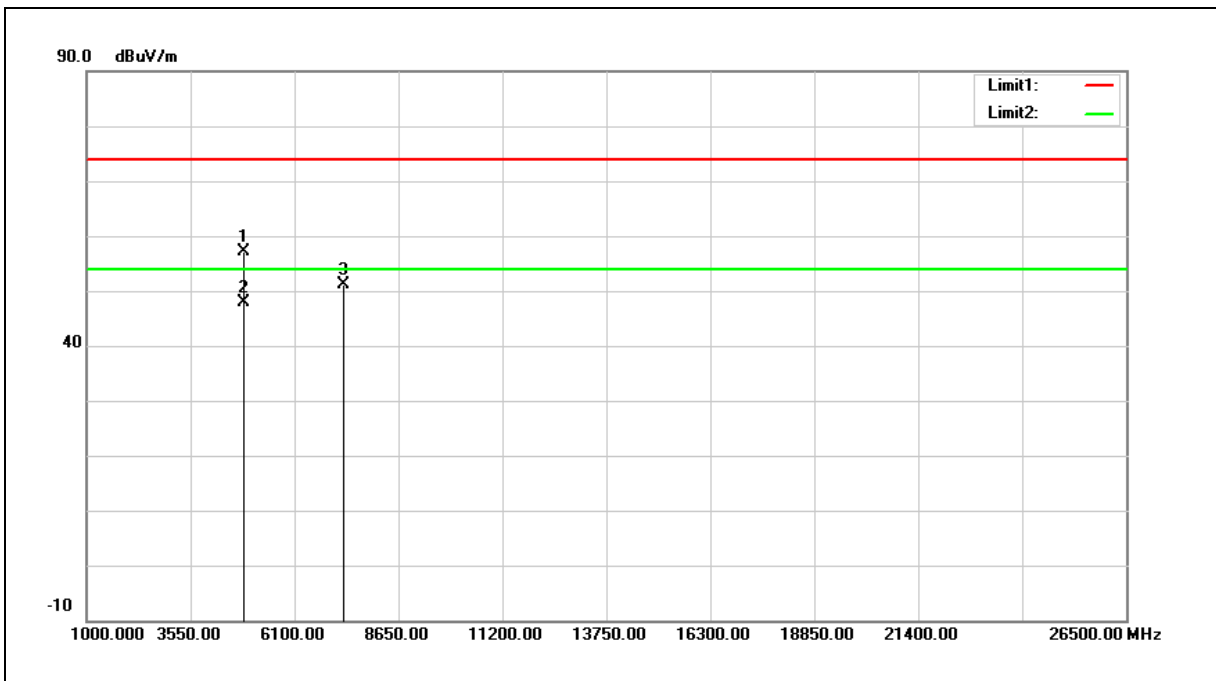

No.	Frequency (MHz)	Reading (dBuV)	Correct Factor (dB/m)	Result (dBuV/m)	Limit (dBuV/m)	Margin (dB)	Remark
1	4874.000	51.36	5.67	57.03	74.00	-16.97	peak
2	4874.000	42.30	5.67	47.97	54.00	-6.03	AVG
3	7311.000	38.91	12.15	51.06	74.00	-22.94	peak

Note:1.Result (dBuV/m) = Correct Factor (dB/m) + Reading(dBuV).

2.Correction factor (dB/m) = Antenna Factor (dB/m) + Cable loss (dB) – Pre-Amplifier gain (dB).

3. When the peak results are less than average limit, so not need to evaluate the average.



Standard:	FCC Part 15.247	Test Distance:	3 m
Test item:	Harmonic	Power:	AC 120 V/60 Hz
Frequency:	2462 MHz	Temp.(°C)/Hum.(%RH):	26(°C)/60% RH
Mode:	Mode 3		
Ant.Polar.:	Horizontal		

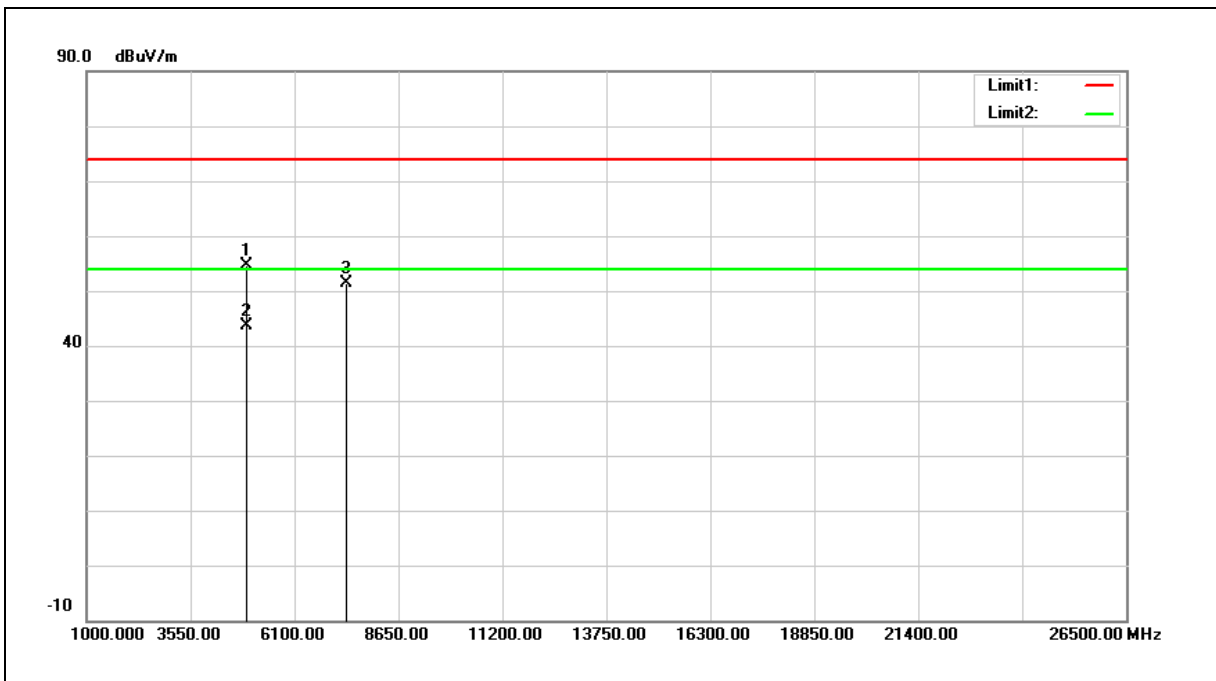

No.	Frequency (MHz)	Reading (dBuV)	Correct Factor (dB/m)	Result (dBuV/m)	Limit (dBuV/m)	Margin (dB)	Remark
1	4924.000	48.86	5.77	54.63	74.00	-19.37	peak
2	4924.000	37.82	5.77	43.59	54.00	-10.41	AVG
3	7386.000	38.97	12.33	51.30	74.00	-22.70	peak

Note:1.Result (dBuV/m) = Correct Factor (dB/m) + Reading(dBuV).

2.Correction factor (dB/m) = Antenna Factor (dB/m) + Cable loss (dB) – Pre-Amplifier gain (dB).

3. When the peak results are less than average limit, so not need to evaluate the average.



Standard:	FCC Part 15.247	Test Distance:	3 m
Test item:	Harmonic	Power:	AC 120 V/60 Hz
Frequency:	2462 MHz	Temp.(°C)/Hum.(%RH):	26(°C)/60% RH
Mode:	Mode 3		
Ant.Polar.:	Vertical		

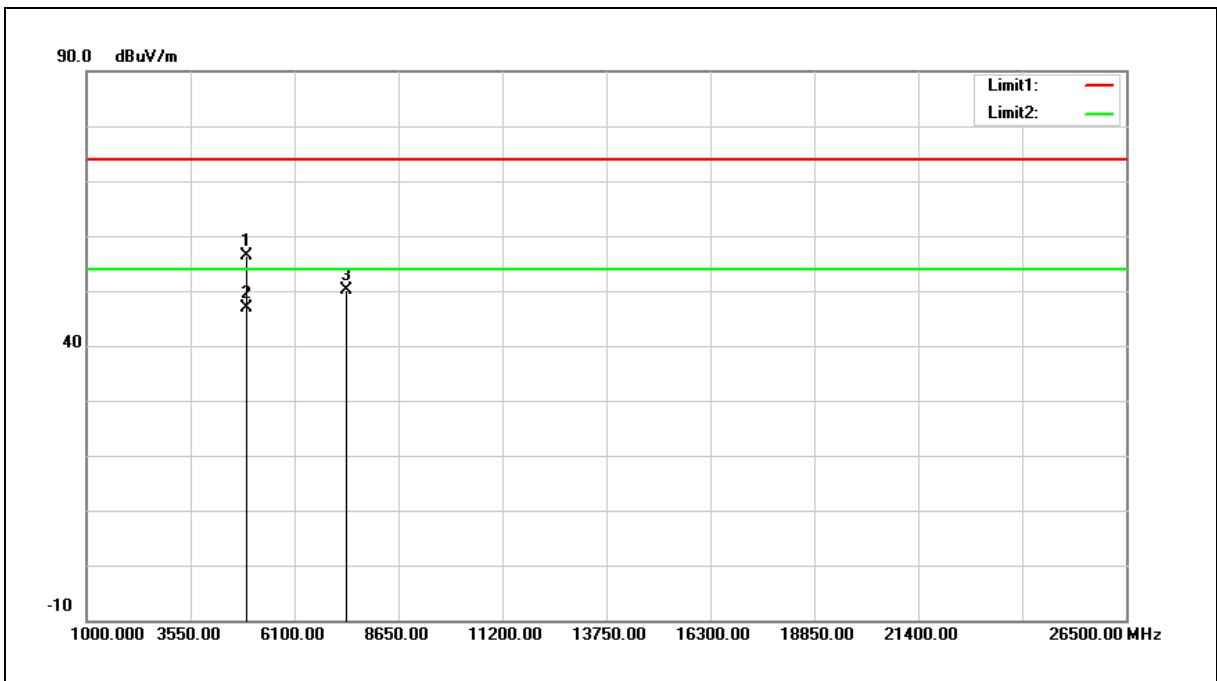

No.	Frequency (MHz)	Reading (dBuV)	Correct Factor (dB/m)	Result (dBuV/m)	Limit (dBuV/m)	Margin (dB)	Remark
1	4924.000	50.68	5.77	56.45	74.00	-17.55	peak
2	4924.000	41.07	5.77	46.84	54.00	-7.16	AVG
3	7386.000	37.80	12.33	50.13	74.00	-23.87	peak

Note:1.Result (dBuV/m) = Correct Factor (dB/m) + Reading(dBuV).

2.Correction factor (dB/m) = Antenna Factor (dB/m) + Cable loss (dB) – Pre-Amplifier gain (dB).

3. When the peak results are less than average limit, so not need to evaluate the average.



Standard:	FCC Part 15.247	Test Distance:	3 m
Test item:	Harmonic	Power:	AC 120 V/60 Hz
Frequency:	2412 MHz	Temp.(°C)/Hum.(%RH):	26(°C)/60% RH
Mode:	Mode 4		
Ant.Polar.:	Horizontal		

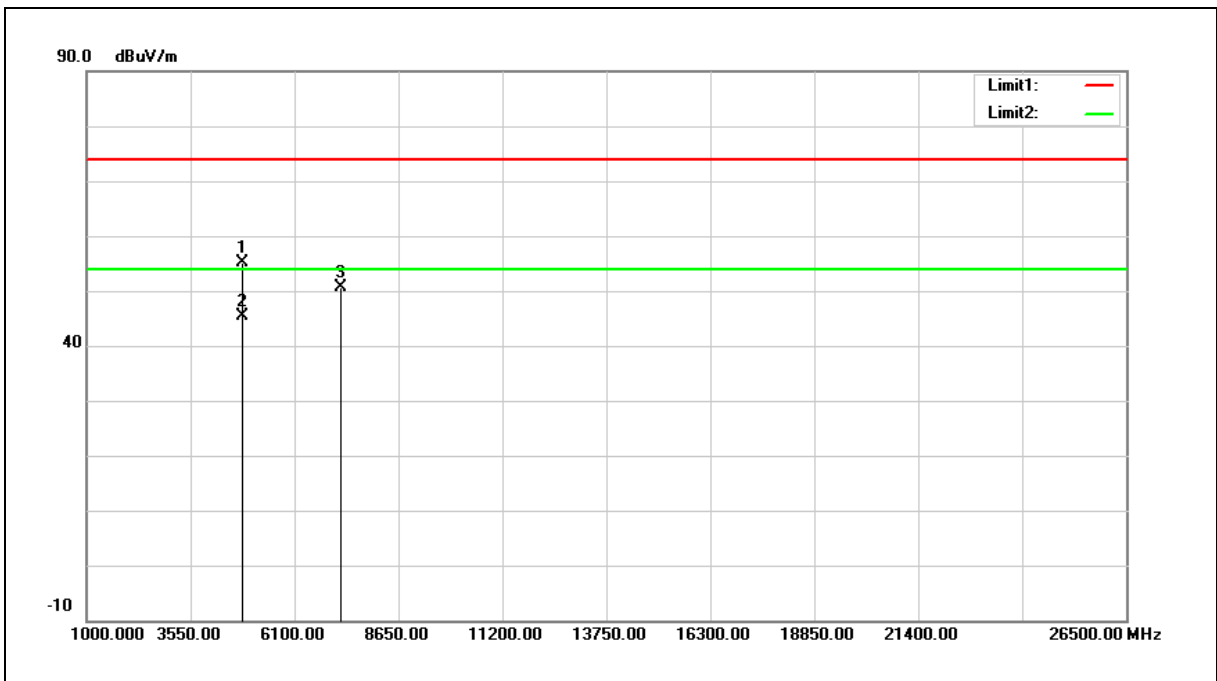

No.	Frequency (MHz)	Reading (dBuV)	Correct Factor (dB/m)	Result (dBuV/m)	Limit (dBuV/m)	Margin (dB)	Remark
1	4824.000	49.48	5.57	55.05	74.00	-18.95	peak
2	4824.000	39.77	5.57	45.34	54.00	-8.66	AVG
3	7236.000	38.56	11.98	50.54	74.00	-23.46	peak

Note:1.Result (dBuV/m) = Correct Factor (dB/m) + Reading(dBuV).

2.Correction factor (dB/m) = Antenna Factor (dB/m) + Cable loss (dB) – Pre-Amplifier gain (dB).

3. When the peak results are less than average limit, so not need to evaluate the average.



Standard:	FCC Part 15.247	Test Distance:	3 m
Test item:	Harmonic	Power:	AC 120 V/60 Hz
Frequency:	2412 MHz	Temp.(°C)/Hum.(%RH):	26(°C)/60% RH
Mode:	Mode 4		
Ant.Polar.:	Vertical		

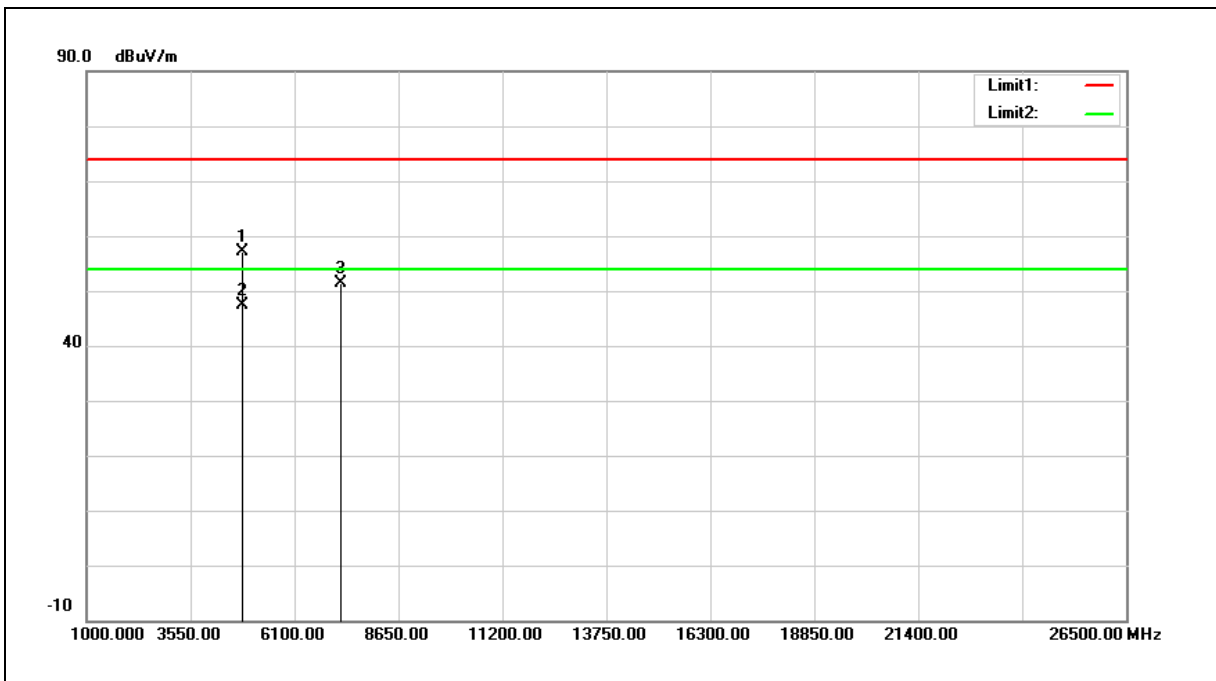

No.	Frequency (MHz)	Reading (dBuV)	Correct Factor (dB/m)	Result (dBuV/m)	Limit (dBuV/m)	Margin (dB)	Remark
1	4824.000	51.57	5.57	57.14	74.00	-16.86	peak
2	4824.000	41.83	5.57	47.40	54.00	-6.60	AVG
3	7236.000	39.28	11.98	51.26	74.00	-22.74	peak

Note:1.Result (dBuV/m) = Correct Factor (dB/m) + Reading(dBuV).

2.Correction factor (dB/m) = Antenna Factor (dB/m) + Cable loss (dB) – Pre-Amplifier gain (dB).

3. When the peak results are less than average limit, so not need to evaluate the average.



Standard:	FCC Part 15.247	Test Distance:	3 m
Test item:	Harmonic	Power:	AC 120 V/60 Hz
Frequency:	2437 MHz	Temp.(°C)/Hum.(%RH):	26(°C)/60% RH
Mode:	Mode 4		
Ant.Polar.:	Horizontal		

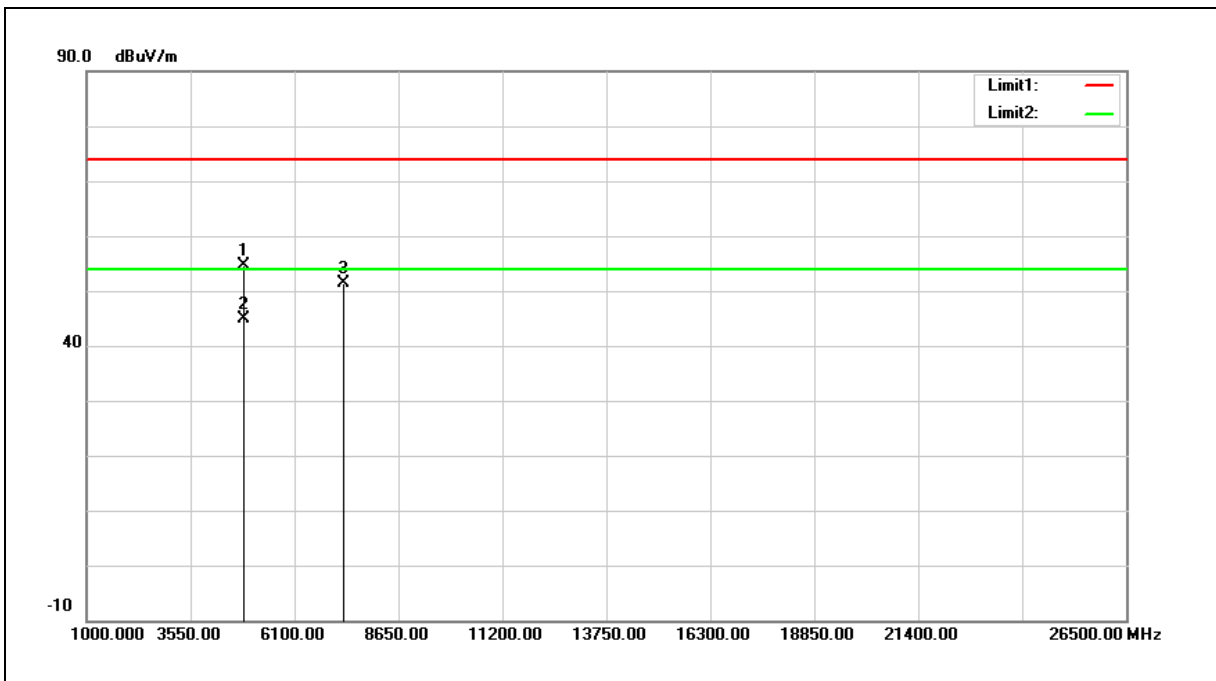

No.	Frequency (MHz)	Reading (dBuV)	Correct Factor (dB/m)	Result (dBuV/m)	Limit (dBuV/m)	Margin (dB)	Remark
1	4874.000	49.03	5.67	54.70	74.00	-19.30	peak
2	4874.000	39.26	5.67	44.93	54.00	-9.07	AVG
3	7311.000	39.35	12.15	51.50	74.00	-22.50	peak

Note:1.Result (dBuV/m) = Correct Factor (dB/m) + Reading(dBuV).

2.Correction factor (dB/m) = Antenna Factor (dB/m) + Cable loss (dB) – Pre-Amplifier gain (dB).

3. When the peak results are less than average limit, so not need to evaluate the average.



Standard:	FCC Part 15.247	Test Distance:	3 m
Test item:	Harmonic	Power:	AC 120 V/60 Hz
Frequency:	2437 MHz	Temp.(°C)/Hum.(%RH):	26(°C)/60% RH
Mode:	Mode 4		
Ant.Polar.:	Vertical		

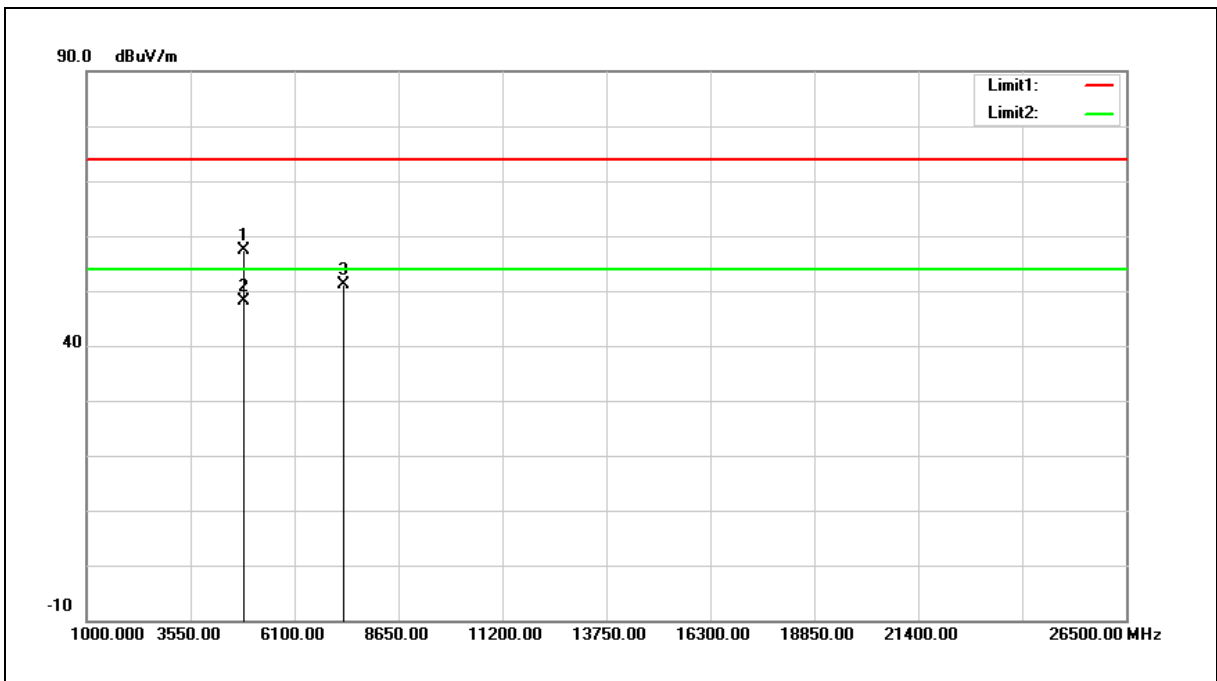

No.	Frequency (MHz)	Reading (dBuV)	Correct Factor (dB/m)	Result (dBuV/m)	Limit (dBuV/m)	Margin (dB)	Remark
1	4874.000	51.76	5.67	57.43	74.00	-16.57	peak
2	4874.000	42.58	5.67	48.25	54.00	-5.75	AVG
3	7311.000	39.02	12.15	51.17	74.00	-22.83	peak

Note:1.Result (dBuV/m) = Correct Factor (dB/m) + Reading(dBuV).

2.Correction factor (dB/m) = Antenna Factor (dB/m) + Cable loss (dB) – Pre-Amplifier gain (dB).

3. When the peak results are less than average limit, so not need to evaluate the average.



Standard:	FCC Part 15.247	Test Distance:	3 m
Test item:	Harmonic	Power:	AC 120 V/60 Hz
Frequency:	2462 MHz	Temp.(°C)/Hum.(%RH):	26(°C)/60% RH
Mode:	Mode 4		
Ant.Polar.:	Horizontal		

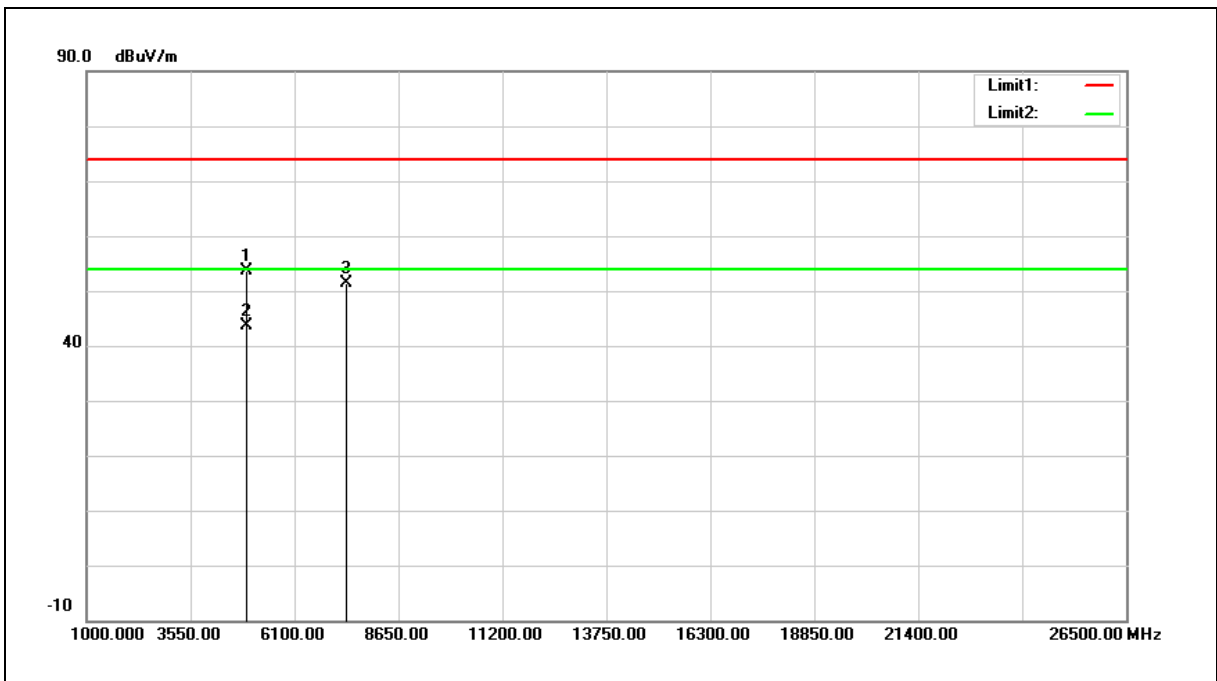

No.	Frequency (MHz)	Reading (dBuV)	Correct Factor (dB/m)	Result (dBuV/m)	Limit (dBuV/m)	Margin (dB)	Remark
1	4924.000	47.94	5.77	53.71	74.00	-20.29	peak
2	4924.000	37.94	5.77	43.71	54.00	-10.29	AVG
3	7386.000	39.14	12.33	51.47	74.00	-22.53	peak

Note:1.Result (dBuV/m) = Correct Factor (dB/m) + Reading(dBuV).

2.Correction factor (dB/m) = Antenna Factor (dB/m) + Cable loss (dB) – Pre-Amplifier gain (dB).

3. When the peak results are less than average limit, so not need to evaluate the average.



Standard:	FCC Part 15.247	Test Distance:	3 m
Test item:	Harmonic	Power:	AC 120 V/60 Hz
Frequency:	2462 MHz	Temp.(°C)/Hum.(%RH):	26(°C)/60% RH
Mode:	Mode 4		
Ant.Polar.:	Vertical		

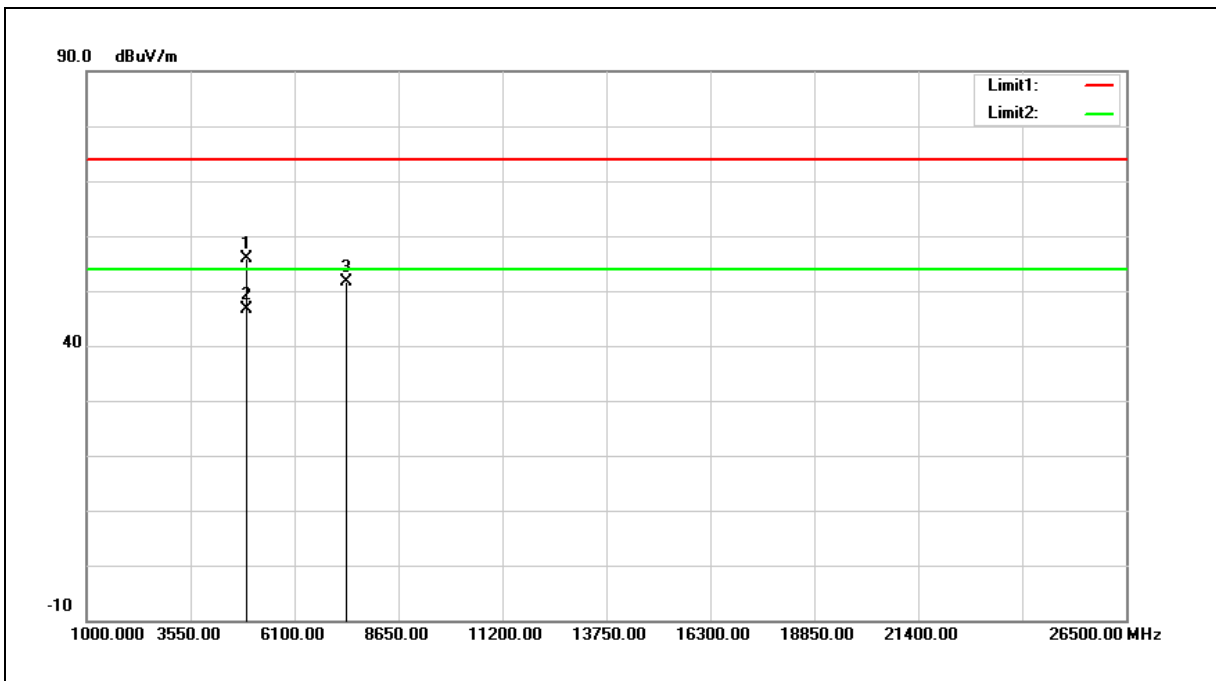

No.	Frequency (MHz)	Reading (dBuV)	Correct Factor (dB/m)	Result (dBuV/m)	Limit (dBuV/m)	Margin (dB)	Remark
1	4924.000	50.11	5.77	55.88	74.00	-18.12	peak
2	4924.000	40.87	5.77	46.64	54.00	-7.36	AVG
3	7386.000	39.37	12.33	51.70	74.00	-22.30	peak

Note:1.Result (dBuV/m) = Correct Factor (dB/m) + Reading(dBuV).

2.Correction factor (dB/m) = Antenna Factor (dB/m) + Cable loss (dB) – Pre-Amplifier gain (dB).

3. When the peak results are less than average limit, so not need to evaluate the average.



Standard:	FCC Part 15.247	Test Distance:	3 m
Test item:	Harmonic	Power:	AC 120 V/60 Hz
Frequency:	2422 MHz	Temp.(°C)/Hum.(%RH):	26(°C)/60% RH
Mode:	Mode 5		
Ant.Polar.:	Horizontal		

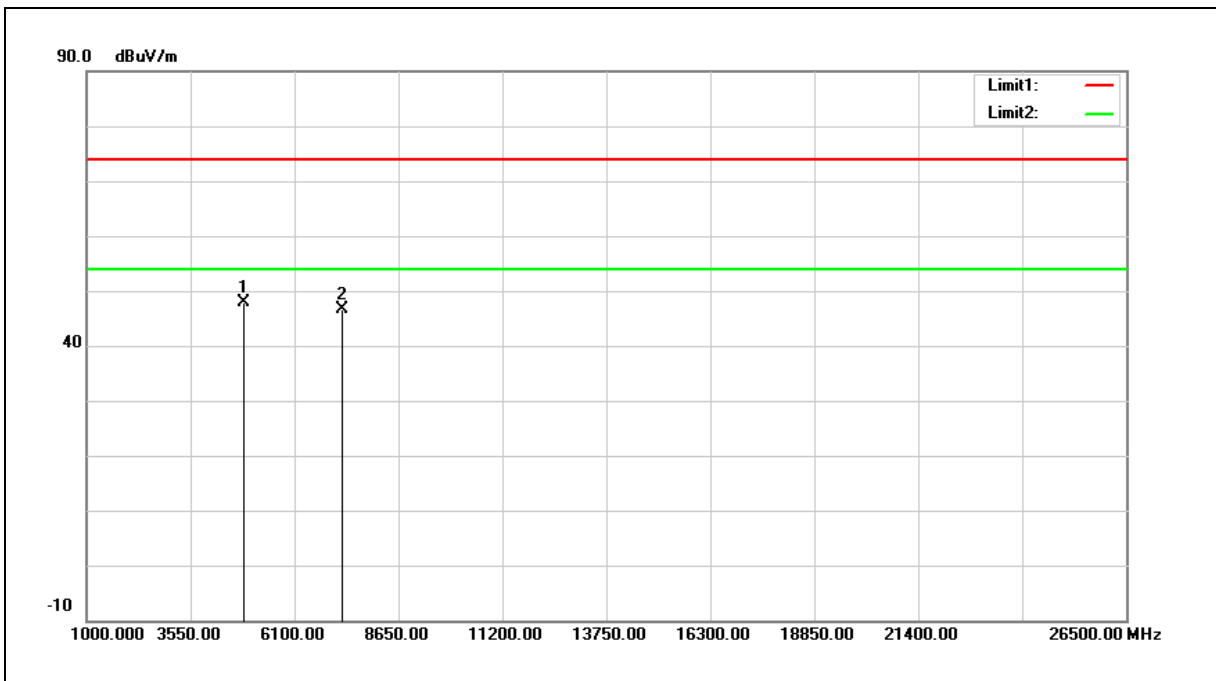

No.	Frequency (MHz)	Reading (dBuV)	Correct Factor (dB/m)	Result (dBuV/m)	Limit (dBuV/m)	Margin (dB)	Remark
1	4844.000	42.35	5.62	47.97	74.00	-26.03	peak
2	7266.000	34.52	12.04	46.56	74.00	-27.44	peak

Note:1.Result (dBuV/m) = Correct Factor (dB/m) + Reading(dBuV).

2.Correction factor (dB/m) = Antenna Factor (dB/m) + Cable loss (dB) – Pre-Amplifier gain (dB).

3. When the peak results are less than average limit, so not need to evaluate the average.



Standard:	FCC Part 15.247	Test Distance:	3 m
Test item:	Harmonic	Power:	AC 120 V/60 Hz
Frequency:	2422 MHz	Temp.(°C)/Hum.(%RH):	26(°C)/60% RH
Mode:	Mode 5		
Ant.Polar.:	Vertical		

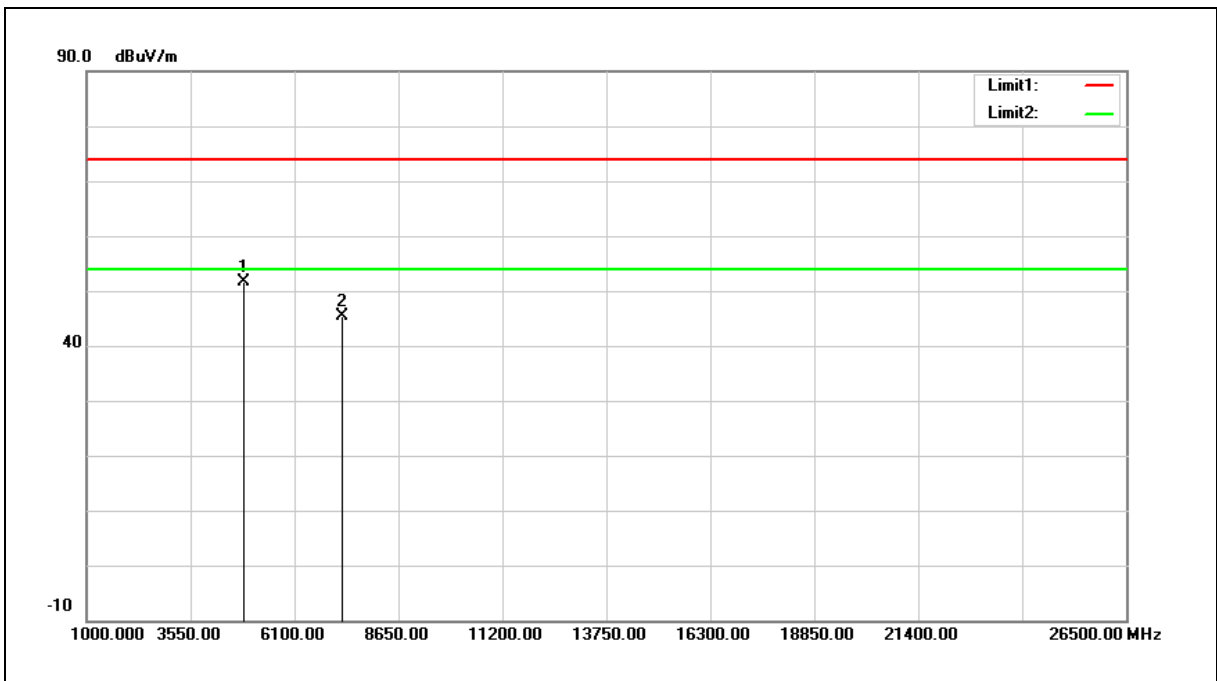

No.	Frequency (MHz)	Reading (dBuV)	Correct Factor (dB/m)	Result (dBuV/m)	Limit (dBuV/m)	Margin (dB)	Remark
1	4844.000	45.97	5.62	51.59	74.00	-22.41	peak
2	7266.000	33.45	12.04	45.49	74.00	-28.51	peak

Note:1.Result (dBuV/m) = Correct Factor (dB/m) + Reading(dBuV).

2.Correction factor (dB/m) = Antenna Factor (dB/m) + Cable loss (dB) – Pre-Amplifier gain (dB).

3. When the peak results are less than average limit, so not need to evaluate the average.



Standard:	FCC Part 15.247	Test Distance:	3 m
Test item:	Harmonic	Power:	AC 120 V/60 Hz
Frequency:	2437 MHz	Temp.(°C)/Hum.(%RH):	26(°C)/60% RH
Mode:	Mode 5		
Ant.Polar.:	Horizontal		

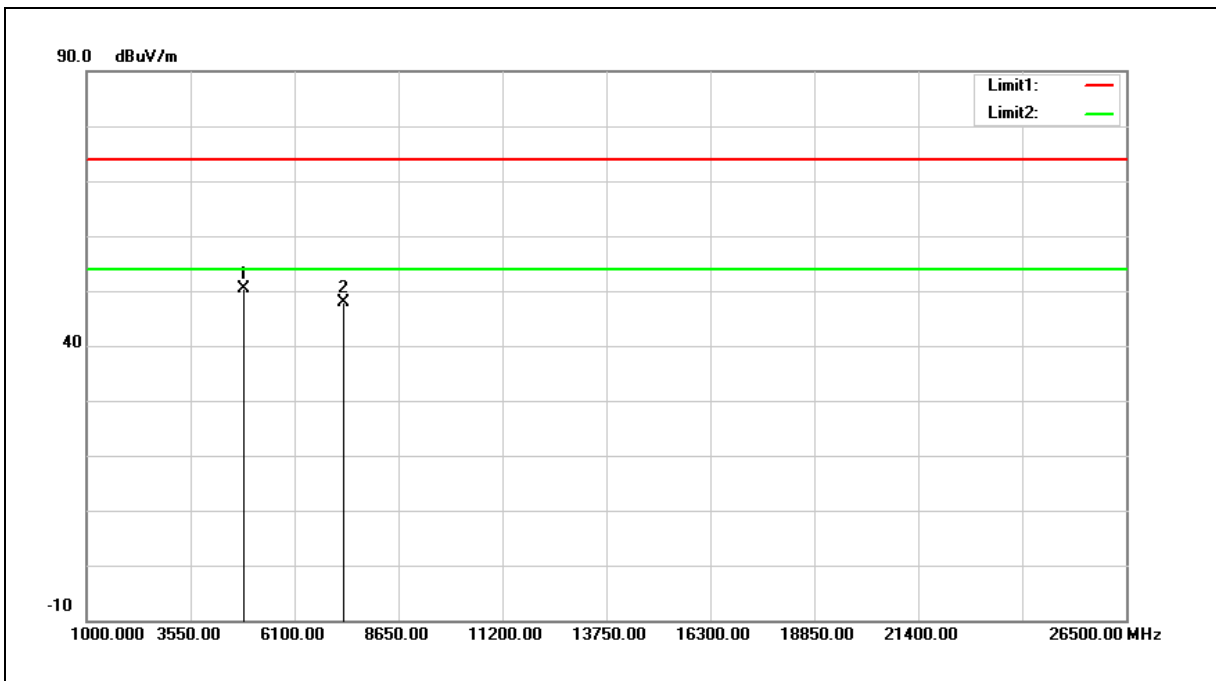

No.	Frequency (MHz)	Reading (dBuV)	Correct Factor (dB/m)	Result (dBuV/m)	Limit (dBuV/m)	Margin (dB)	Remark
1	4874.000	44.61	5.67	50.28	74.00	-23.72	peak
2	7311.000	35.82	12.15	47.97	74.00	-26.03	peak

- Note:1.Result (dBuV/m) = Correct Factor (dB/m) + Reading(dBuV).
 2.Correction factor (dB/m) = Antenna Factor (dB/m) + Cable loss (dB) – Pre-Amplifier gain (dB).
 3. When the peak results are less than average limit, so not need to evaluate the average.



Standard:	FCC Part 15.247	Test Distance:	3 m
Test item:	Harmonic	Power:	AC 120 V/60 Hz
Frequency:	2437 MHz	Temp.(°C)/Hum.(%RH):	26(°C)/60% RH
Mode:	Mode 5		
Ant.Polar.:	Vertical		

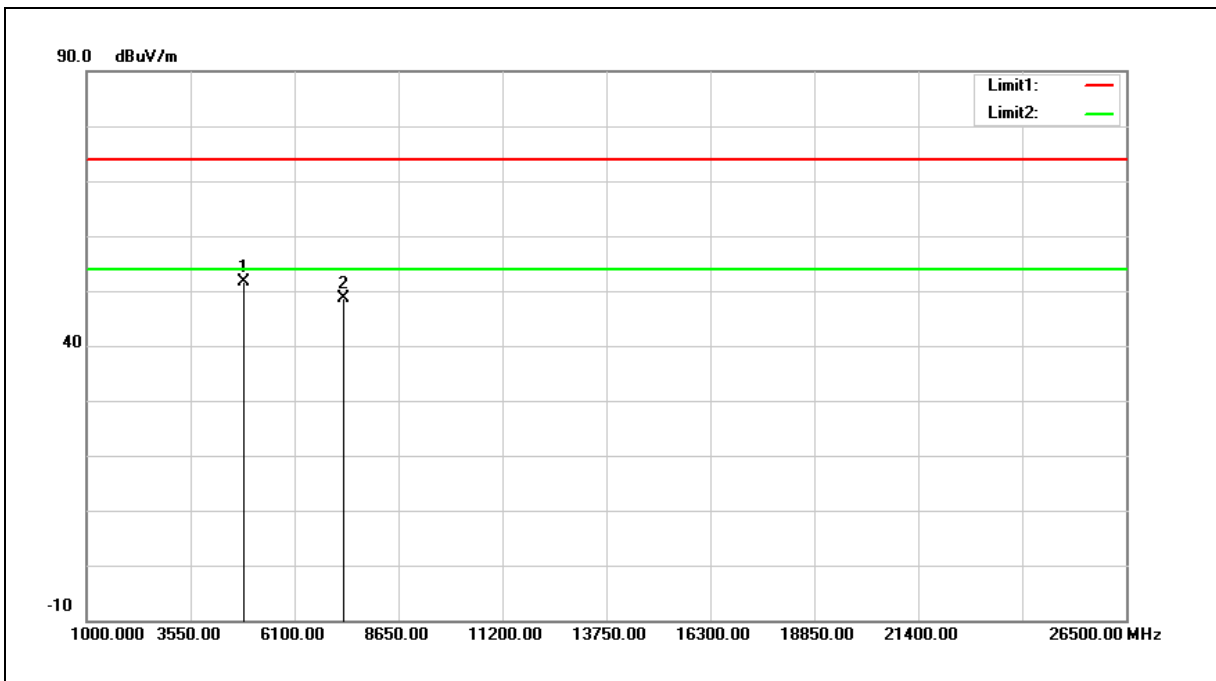

No.	Frequency (MHz)	Reading (dBuV)	Correct Factor (dB/m)	Result (dBuV/m)	Limit (dBuV/m)	Margin (dB)	Remark
1	4874.000	46.06	5.67	51.73	74.00	-22.27	peak
2	7311.000	36.59	12.15	48.74	74.00	-25.26	peak

- Note:1.Result (dBuV/m) = Correct Factor (dB/m) + Reading(dBuV).
 2.Correction factor (dB/m) = Antenna Factor (dB/m) + Cable loss (dB) – Pre-Amplifier gain (dB).
 3. When the peak results are less than average limit, so not need to evaluate the average.



Standard:	FCC Part 15.247	Test Distance:	3 m
Test item:	Harmonic	Power:	AC 120 V/60 Hz
Frequency:	2452 MHz	Temp.(°C)/Hum.(%RH):	26(°C)/60% RH
Mode:	Mode 5		
Ant.Polar.:	Horizontal		

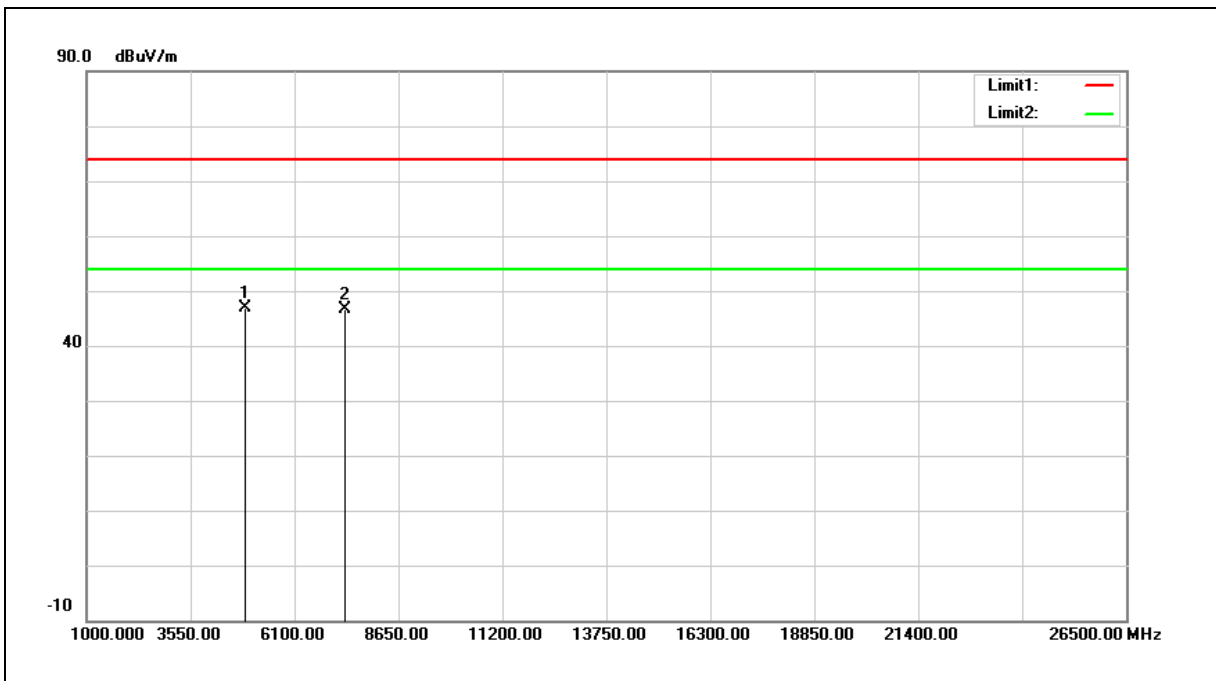

No.	Frequency (MHz)	Reading (dBuV)	Correct Factor (dB/m)	Result (dBuV/m)	Limit (dBuV/m)	Margin (dB)	Remark
1	4904.000	41.12	5.73	46.85	74.00	-27.15	peak
2	7356.000	34.29	12.25	46.54	74.00	-27.46	peak

Note:1.Result (dBuV/m) = Correct Factor (dB/m) + Reading(dBuV).

2.Correction factor (dB/m) = Antenna Factor (dB/m) + Cable loss (dB) – Pre-Amplifier gain (dB).

3. When the peak results are less than average limit, so not need to evaluate the average.



Standard:	FCC Part 15.247	Test Distance:	3 m
Test item:	Harmonic	Power:	AC 120 V/60 Hz
Frequency:	2452 MHz	Temp.(°C)/Hum.(%RH):	26(°C)/60% RH
Mode:	Mode 5		
Ant.Polar.:	Vertical		

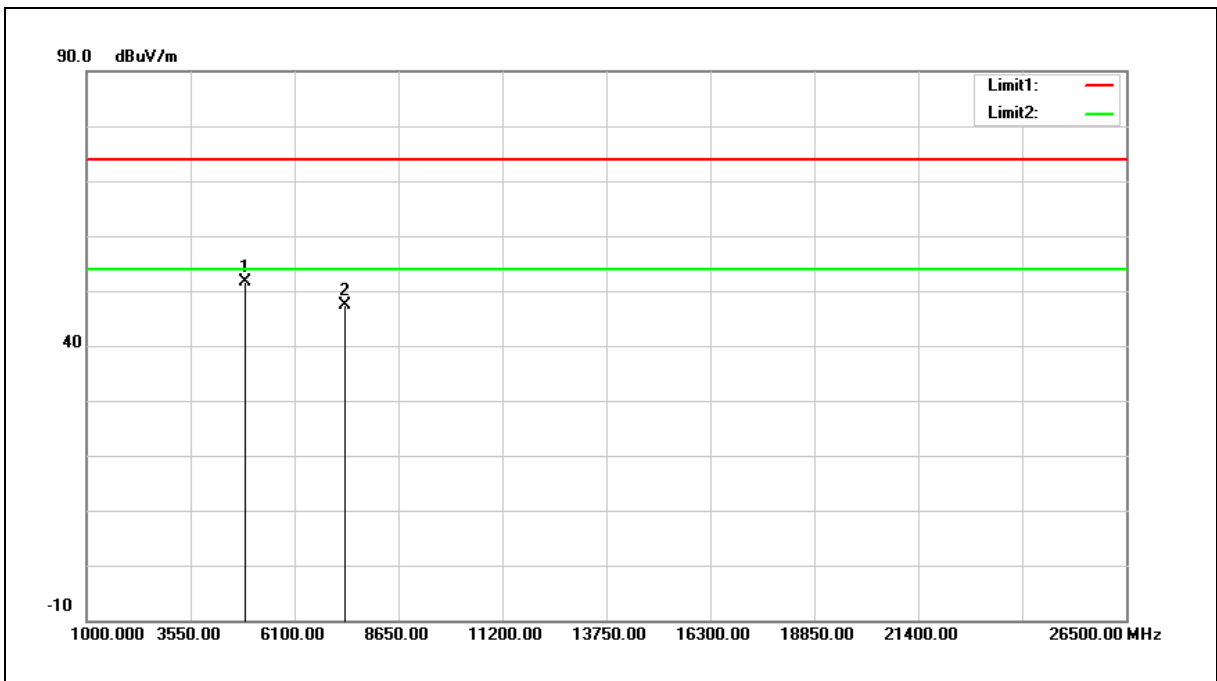

No.	Frequency (MHz)	Reading (dBuV)	Correct Factor (dB/m)	Result (dBuV/m)	Limit (dBuV/m)	Margin (dB)	Remark
1	4904.000	45.95	5.73	51.68	74.00	-22.32	peak
2	7356.000	35.08	12.25	47.33	74.00	-26.67	peak

Note:1.Result (dBuV/m) = Correct Factor (dB/m) + Reading(dBuV).

2.Correction factor (dB/m) = Antenna Factor (dB/m) + Cable loss (dB) – Pre-Amplifier gain (dB).

3. When the peak results are less than average limit, so not need to evaluate the average.



Band Edge

Standard:	FCC Part 15.247	Test Distance:	3 m
Test item:	Band edge	Power:	AC 120 V/60 Hz
Frequency:	2412 MHz	Temp.(°C)/Hum.(%RH):	26(°C)/60 %RH
Mode:	Mode 2		
Ant.Polar.:	Horizontal		

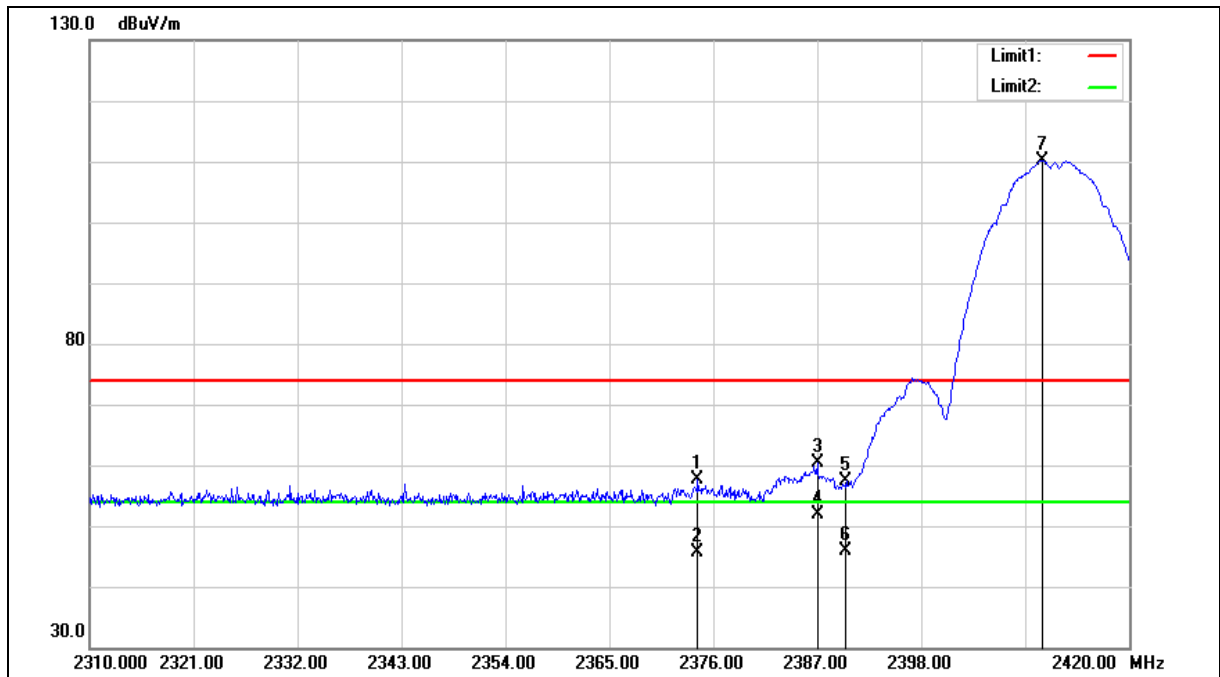



Standard:	FCC Part 15.247	Test Distance:	3 m
Test item:	Band edge	Power:	AC 120 V/60 Hz
Frequency:	2412 MHz	Temp.(°C)/Hum.(%RH):	26(°C)/60 %RH
Mode:	Mode 2		
Ant.Polar.:	Horizontal		

No.	Frequency (MHz)	Reading (dBuV)	Correct Factor (dB/m)	Result (dBuV/m)	Limit (dBuV/m)	Margin (dB)	Remark
1	2374.350	58.85	-1.10	57.75	74.00	-16.25	peak
2	2374.350	46.68	-1.10	45.58	54.00	-8.42	AVG
3	2387.000	61.51	-1.06	60.45	74.00	-13.55	peak
4	2387.000	52.83	-1.06	51.77	54.00	-2.23	AVG
5	2390.000	58.32	-1.05	57.27	74.00	-16.73	peak
6	2390.000	47.01	-1.05	45.96	54.00	-8.04	AVG
7	2410.760	111.10	-0.97	110.13	--	--	peak

Note:1.Result (dBuV/m) = Correct Factor (dB/m) + Reading(dBuV).

2.Correction factor (dB/m) = Antenna Factor (dB/m) + Cable loss (dB) – Pre-Amplifier gain (dB).

3. When the peak results are less than average limit, so not need to evaluate the average.



Standard:	FCC Part 15.247	Test Distance:	3 m
Test item:	Band edge	Power:	AC 120 V/60 Hz
Frequency:	2412 MHz	Temp.(°C)/Hum.(%RH):	26(°C)/60 %RH
Mode:	Mode 2		
Ant.Polar.:	Vertical		

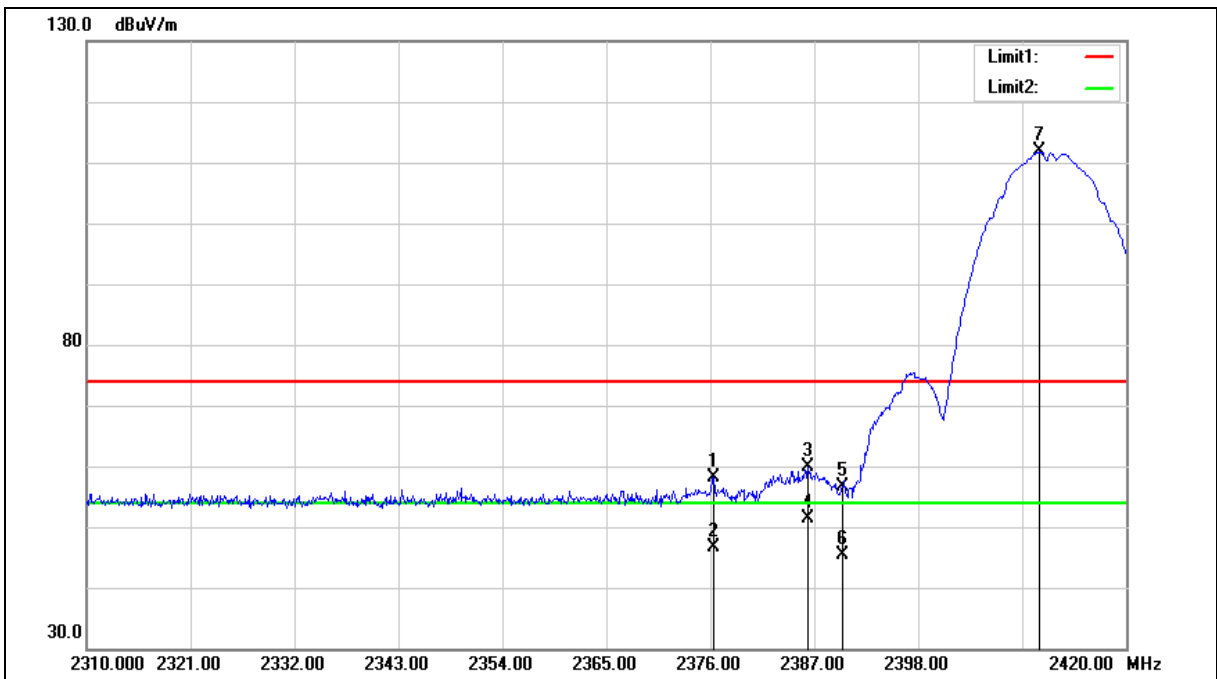



Standard:	FCC Part 15.247	Test Distance:	3 m
Test item:	Band edge	Power:	AC 120 V/60 Hz
Frequency:	2412 MHz	Temp.(°C)/Hum.(%RH):	26(°C)/60 %RH
Mode:	Mode 2		
Ant.Polar.:	Vertical		

No.	Frequency (MHz)	Reading (dBuV)	Correct Factor (dB/m)	Result (dBuV/m)	Limit (dBuV/m)	Margin (dB)	Remark
1	2376.330	59.23	-1.10	58.13	74.00	-15.87	peak
2	2376.330	47.75	-1.10	46.65	54.00	-7.35	AVG
3	2386.340	60.97	-1.07	59.90	74.00	-14.10	peak
4	2386.340	52.38	-1.07	51.31	54.00	-2.69	AVG
5	2390.000	57.68	-1.05	56.63	74.00	-17.37	peak
6	2390.000	46.55	-1.05	45.50	54.00	-8.50	AVG
7	2410.870	112.75	-0.97	111.78	--	--	peak

Note:1.Result (dBuV/m) = Correct Factor (dB/m) + Reading(dBuV).

2.Correction factor (dB/m) = Antenna Factor (dB/m) + Cable loss (dB) – Pre-Amplifier gain (dB).

3. When the peak results are less than average limit, so not need to evaluate the average.



Standard:	FCC Part 15.247	Test Distance:	3 m
Test item:	Band edge	Power:	AC 120 V/60 Hz
Frequency:	2462 MHz	Temp.(°C)/Hum.(%RH):	26(°C)/60 %RH
Mode:	Mode 2		
Ant.Polar.:	Horizontal		

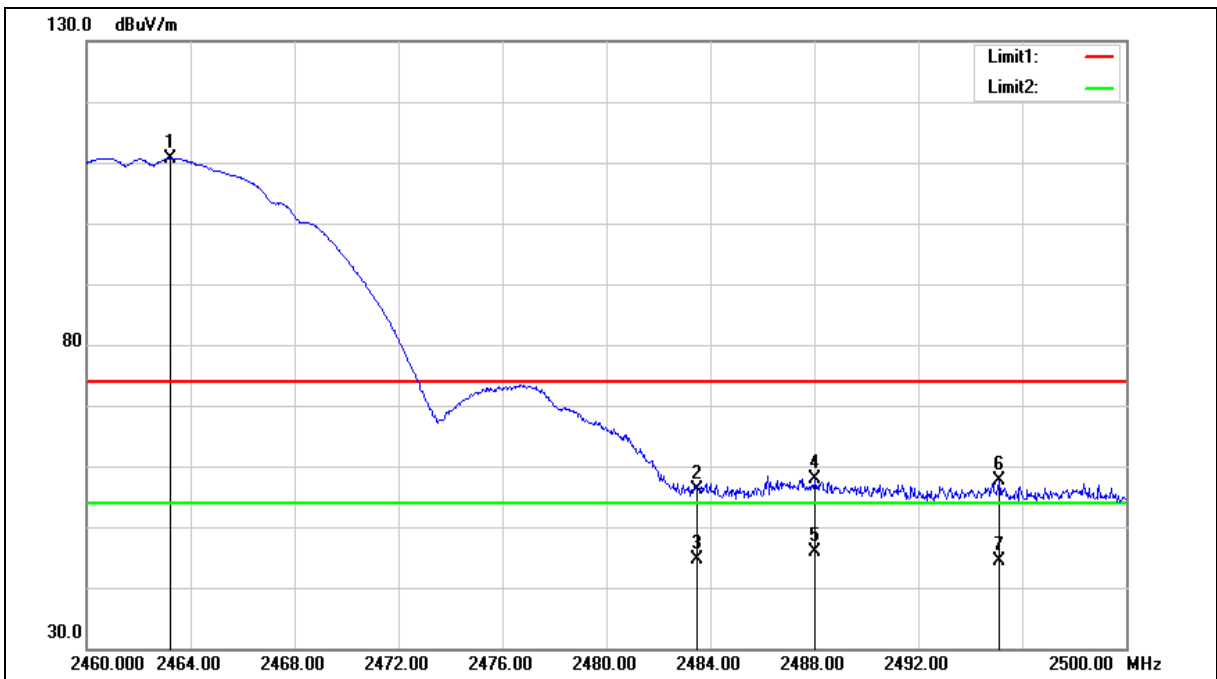



Standard:	FCC Part 15.247	Test Distance:	3 m
Test item:	Band edge	Power:	AC 120 V/60 Hz
Frequency:	2462 MHz	Temp.(°C)/Hum.(%RH):	26(°C)/60 %RH
Mode:	Mode 2		
Ant.Polar.:	Horizontal		

No.	Frequency (MHz)	Reading (dBuV)	Correct Factor (dB/m)	Result (dBuV/m)	Limit (dBuV/m)	Margin (dB)	Remark
1	2463.200	111.51	-0.78	110.73	--	--	peak
2	2483.500	56.76	-0.70	56.06	74.00	-17.94	peak
3	2483.500	45.36	-0.70	44.66	54.00	-9.34	AVG
4	2488.040	58.65	-0.68	57.97	74.00	-16.03	peak
5	2488.040	46.53	-0.68	45.85	54.00	-8.15	AVG
6	2495.120	58.17	-0.66	57.51	74.00	-16.49	peak
7	2495.120	44.94	-0.66	44.28	54.00	-9.72	AVG

Note:1.Result (dBuV/m) = Correct Factor (dB/m) + Reading(dBuV).

2.Correction factor (dB/m) = Antenna Factor (dB/m) + Cable loss (dB) – Pre-Amplifier gain (dB).

3. When the peak results are less than average limit, so not need to evaluate the average.



Standard:	FCC Part 15.247	Test Distance:	3 m
Test item:	Band edge	Power:	AC 120 V/60 Hz
Frequency:	2462 MHz	Temp.(°C)/Hum.(%RH):	26(°C)/60 %RH
Mode:	Mode 2		
Ant.Polar.:	Vertical		

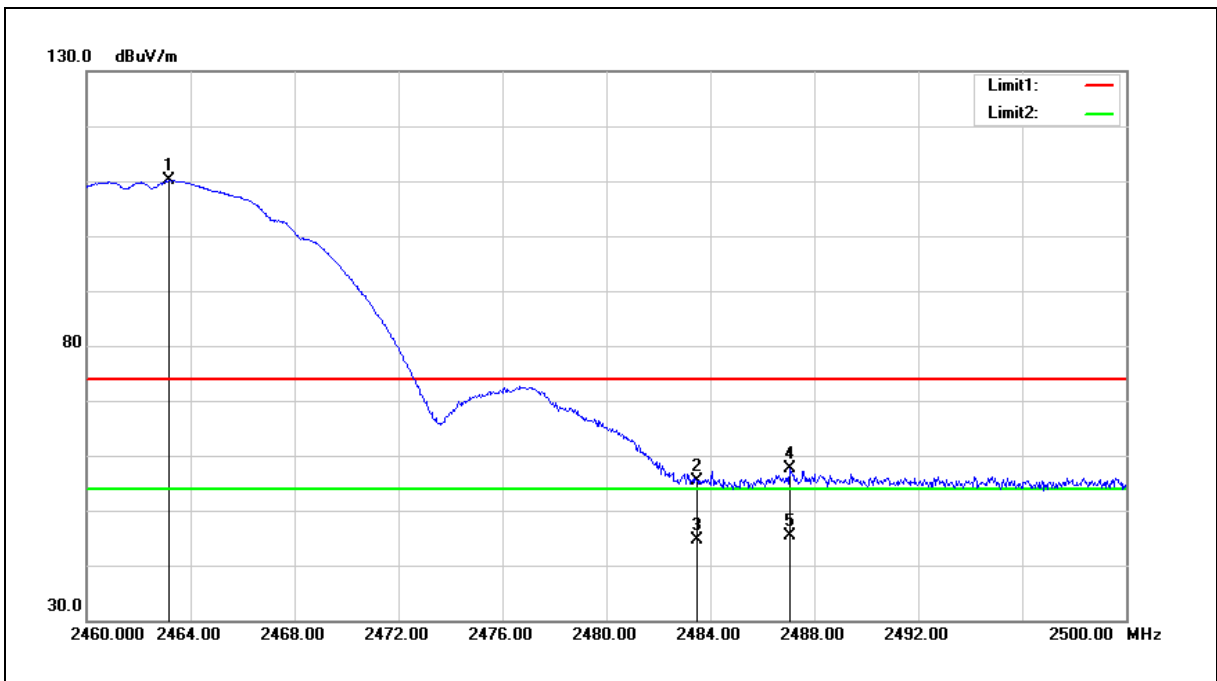

No.	Frequency (MHz)	Reading (dBuV)	Correct Factor (dB/m)	Result (dBuV/m)	Limit (dBuV/m)	Margin (dB)	Remark
1	2463.160	110.86	-0.78	110.08	--	--	peak
2	2483.500	56.10	-0.70	55.40	74.00	-18.60	peak
3	2483.500	45.31	-0.70	44.61	54.00	-9.39	AVG
4	2487.040	58.20	-0.69	57.51	74.00	-16.49	peak
5	2487.040	46.04	-0.69	45.35	54.00	-8.65	AVG

Note:1.Result (dBuV/m) = Correct Factor (dB/m) + Reading(dBuV).

2.Correction factor (dB/m) = Antenna Factor (dB/m) + Cable loss (dB) – Pre-Amplifier gain (dB).

3. When the peak results are less than average limit, so not need to evaluate the average.



Standard:	FCC Part 15.247	Test Distance:	3 m
Test item:	Band edge	Power:	AC 120 V/60 Hz
Frequency:	2412 MHz	Temp.(°C)/Hum.(%RH):	26(°C)/60 %RH
Mode:	Mode 3		
Ant.Polar.:	Horizontal		

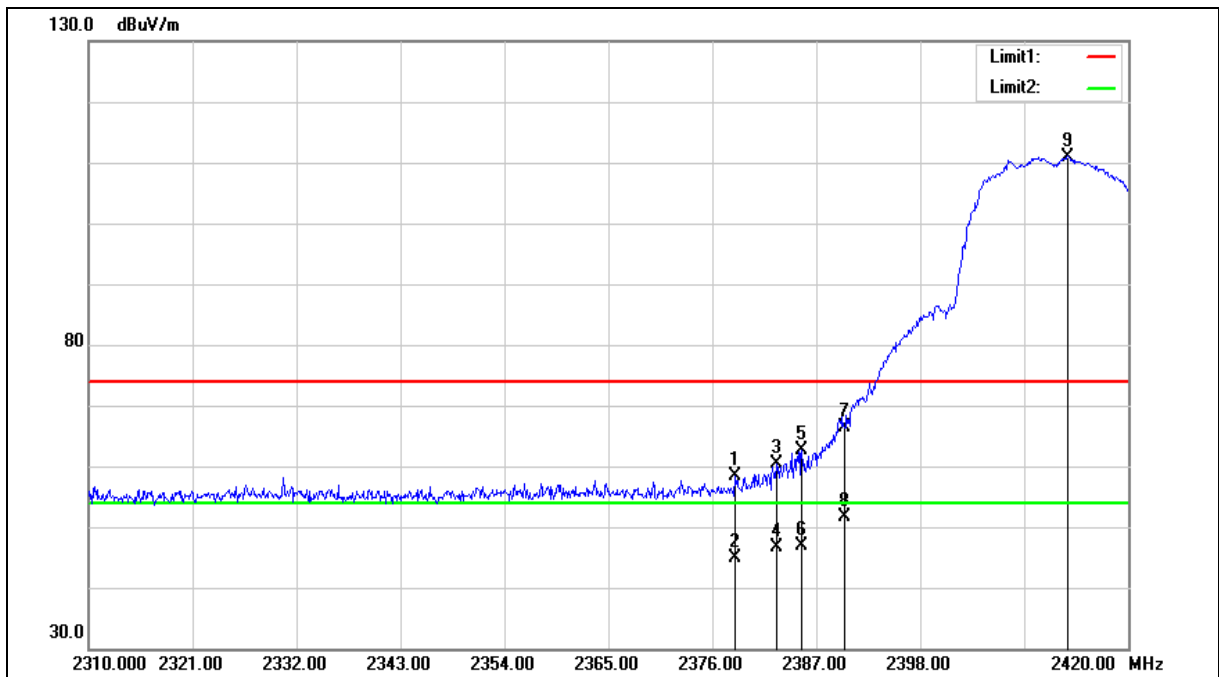



Standard:	FCC Part 15.247	Test Distance:	3 m
Test item:	Band edge	Power:	AC 120 V/60 Hz
Frequency:	2412 MHz	Temp.(°C)/Hum.(%RH):	26(°C)/60 %RH
Mode:	Mode 3		
Ant.Polar.:	Horizontal		

No.	Frequency (MHz)	Reading (dBuV)	Correct Factor (dB/m)	Result (dBuV/m)	Limit (dBuV/m)	Margin (dB)	Remark
1	2378.420	59.39	-1.10	58.29	74.00	-15.71	peak
2	2378.420	46.05	-1.10	44.95	54.00	-9.05	AVG
3	2382.820	61.36	-1.07	60.29	74.00	-13.71	peak
4	2382.820	47.73	-1.07	46.66	54.00	-7.34	AVG
5	2385.460	63.74	-1.07	62.67	74.00	-11.33	peak
6	2385.460	47.90	-1.07	46.83	54.00	-7.17	AVG
7	2390.000	67.42	-1.05	66.37	74.00	-7.63	peak
8	2390.000	52.65	-1.05	51.60	54.00	-2.40	AVG
9	2413.620	111.95	-0.95	111.00	--	--	peak

Note:1.Result (dBuV/m) = Correct Factor (dB/m) + Reading(dBuV).

2.Correction factor (dB/m) = Antenna Factor (dB/m) + Cable loss (dB) – Pre-Amplifier gain (dB).

3. When the peak results are less than average limit, so not need to evaluate the average.



Standard:	FCC Part 15.247	Test Distance:	3 m
Test item:	Band edge	Power:	AC 120 V/60 Hz
Frequency:	2412 MHz	Temp.(°C)/Hum.(%RH):	26(°C)/60 %RH
Mode:	Mode 3		
Ant.Polar.:	Vertical		

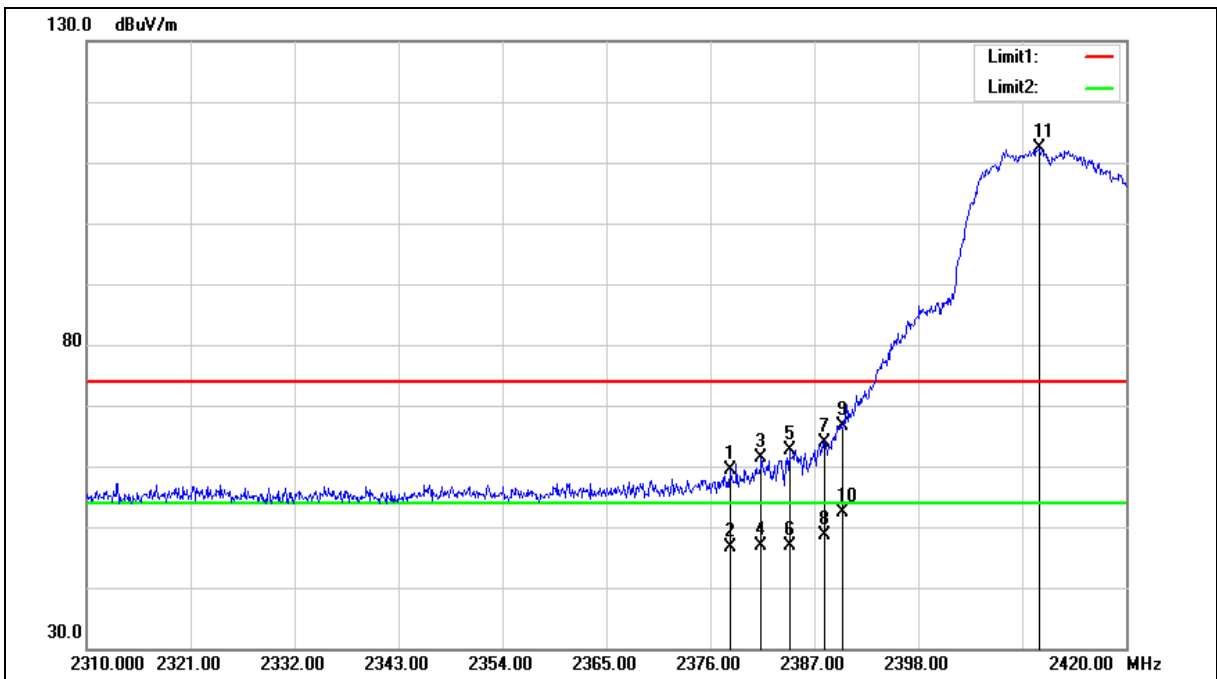



Standard:	FCC Part 15.247	Test Distance:	3 m
Test item:	Band edge	Power:	AC 120 V/60 Hz
Frequency:	2412 MHz	Temp.(°C)/Hum.(%RH):	26(°C)/60 %RH
Mode:	Mode 3		
Ant.Polar.:	Vertical		

No.	Frequency (MHz)	Reading (dBuV)	Correct Factor (dB/m)	Result (dBuV/m)	Limit (dBuV/m)	Margin (dB)	Remark
1	2378.090	60.58	-1.10	59.48	74.00	-14.52	peak
2	2378.090	47.72	-1.10	46.62	54.00	-7.38	AVG
3	2381.390	62.36	-1.08	61.28	74.00	-12.72	peak
4	2381.390	47.86	-1.08	46.78	54.00	-7.22	AVG
5	2384.360	63.76	-1.07	62.69	74.00	-11.31	peak
6	2384.360	48.05	-1.07	46.98	54.00	-7.02	AVG
7	2388.100	65.05	-1.05	64.00	74.00	-10.00	peak
8	2388.100	49.65	-1.05	48.60	54.00	-5.40	AVG
9	2390.000	67.79	-1.05	66.74	74.00	-7.26	peak
10	2390.000	53.51	-1.05	52.46	54.00	-1.54	AVG
11	2410.870	113.39	-0.97	112.42	--	--	peak

Note:1.Result (dBuV/m) = Correct Factor (dB/m) + Reading(dBuV).

2.Correction factor (dB/m) = Antenna Factor (dB/m) + Cable loss (dB) – Pre-Amplifier gain (dB).

3. When the peak results are less than average limit, so not need to evaluate the average.



Standard:	FCC Part 15.247	Test Distance:	3 m
Test item:	Band edge	Power:	AC 120 V/60 Hz
Frequency:	2462 MHz	Temp.(°C)/Hum.(%RH):	26(°C)/60 %RH
Mode:	Mode 3		
Ant.Polar.:	Horizontal		

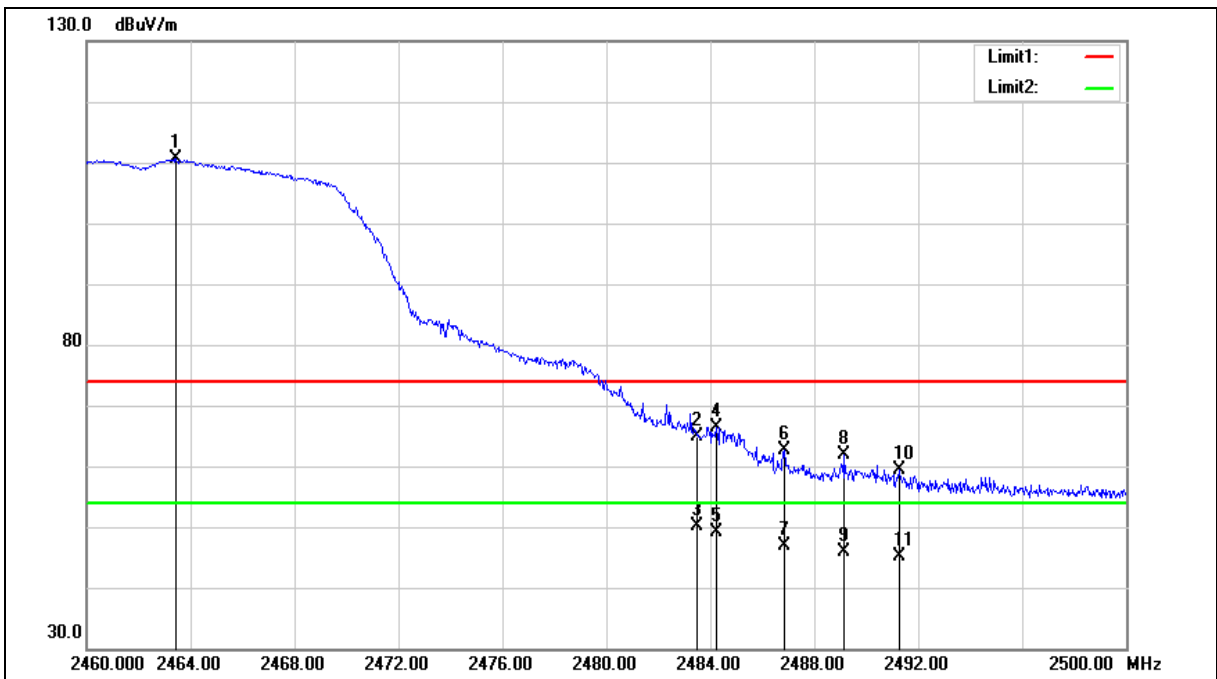



Standard:	FCC Part 15.247	Test Distance:	3 m
Test item:	Band edge	Power:	AC 120 V/60 Hz
Frequency:	2462 MHz	Temp.(°C)/Hum.(%RH):	26(°C)/60 %RH
Mode:	Mode 3		
Ant.Polar.:	Horizontal		

No.	Frequency (MHz)	Reading (dBuV)	Correct Factor (dB/m)	Result (dBuV/m)	Limit (dBuV/m)	Margin (dB)	Remark
1	2463.440	111.41	-0.78	110.63	--	--	peak
2	2483.500	65.56	-0.70	64.86	74.00	-9.14	peak
3	2483.500	50.85	-0.70	50.15	54.00	-3.85	AVG
4	2484.240	67.03	-0.70	66.33	74.00	-7.67	peak
5	2484.240	49.92	-0.70	49.22	54.00	-4.78	AVG
6	2486.840	63.24	-0.69	62.55	74.00	-11.45	peak
7	2486.840	47.62	-0.69	46.93	54.00	-7.07	AVG
8	2489.160	62.66	-0.68	61.98	74.00	-12.02	peak
9	2489.160	46.44	-0.68	45.76	54.00	-8.24	AVG
10	2491.280	59.97	-0.67	59.30	74.00	-14.70	peak
11	2491.280	45.74	-0.67	45.07	54.00	-8.93	AVG

Note:1.Result (dBuV/m) = Correct Factor (dB/m) + Reading(dBuV).

2.Correction factor (dB/m) = Antenna Factor (dB/m) + Cable loss (dB) – Pre-Amplifier gain (dB).

3. When the peak results are less than average limit, so not need to evaluate the average.



Standard:	FCC Part 15.247	Test Distance:	3 m
Test item:	Band edge	Power:	AC 120 V/60 Hz
Frequency:	2462 MHz	Temp.(°C)/Hum.(%RH):	26(°C)/60 %RH
Mode:	Mode 3		
Ant.Polar.:	Vertical		

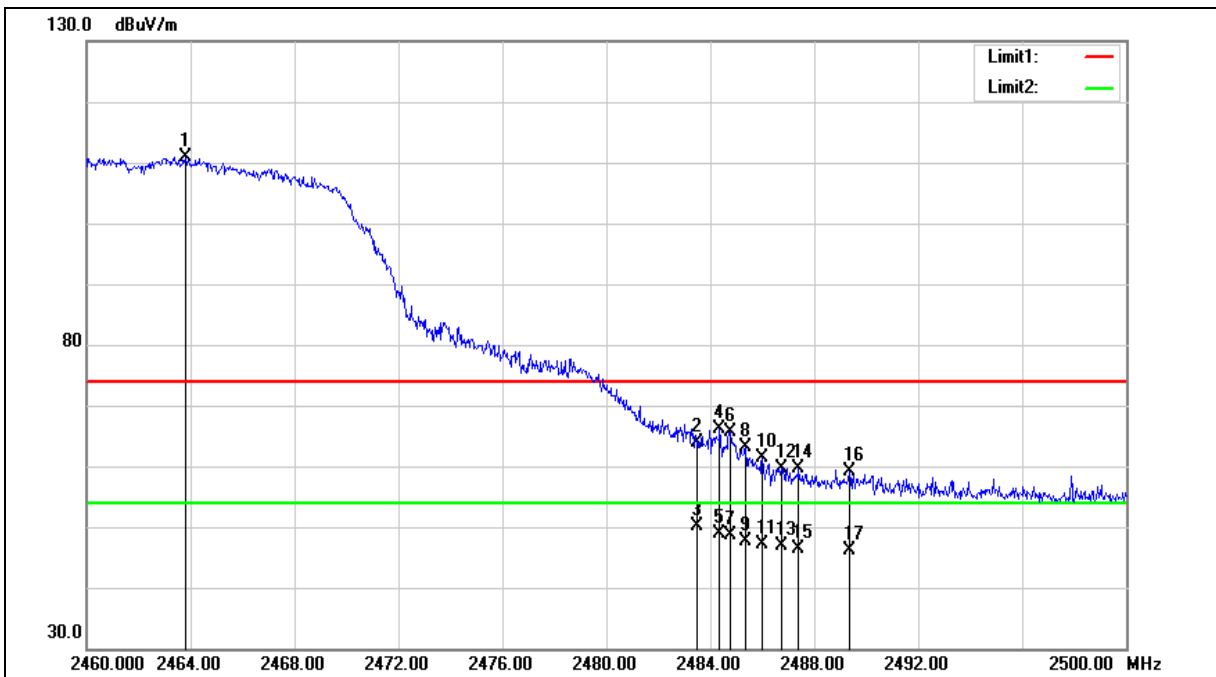



Standard:	FCC Part 15.247	Test Distance:	3 m
Test item:	Band edge	Power:	AC 120 V/60 Hz
Frequency:	2462 MHz	Temp.(°C)/Hum.(%RH):	26(°C)/60 %RH
Mode:	Mode 3		
Ant.Polar.:	Vertical		

No.	Frequency (MHz)	Reading (dBuV)	Correct Factor (dB/m)	Result (dBuV/m)	Limit (dBuV/m)	Margin (dB)	Remark
1	2463.800	111.59	-0.77	110.82	--	--	peak
2	2483.500	64.62	-0.70	63.92	74.00	-10.08	peak
3	2483.500	50.83	-0.70	50.13	54.00	-3.87	AVG
4	2484.360	66.87	-0.70	66.17	74.00	-7.83	peak
5	2484.360	49.59	-0.70	48.89	54.00	-5.11	AVG
6	2484.760	66.31	-0.70	65.61	74.00	-8.39	peak
7	2484.760	49.42	-0.70	48.72	54.00	-5.28	AVG
8	2485.360	63.71	-0.70	63.01	74.00	-10.99	peak
9	2485.360	48.30	-0.70	47.60	54.00	-6.40	AVG
10	2486.000	62.11	-0.70	61.41	74.00	-12.59	peak
11	2486.000	47.77	-0.70	47.07	54.00	-6.93	AVG
12	2486.760	60.40	-0.69	59.71	74.00	-14.29	peak
13	2486.760	47.49	-0.69	46.80	54.00	-7.20	AVG
14	2487.400	60.42	-0.69	59.73	74.00	-14.27	peak
15	2487.400	47.00	-0.69	46.31	54.00	-7.69	AVG
16	2489.360	59.88	-0.68	59.20	74.00	-14.80	peak
17	2489.360	46.74	-0.68	46.06	54.00	-7.94	AVG

Note:1.Result (dBuV/m) = Correct Factor (dB/m) + Reading(dBuV).

2.Correction factor (dB/m) = Antenna Factor (dB/m) + Cable loss (dB) – Pre-Amplifier gain (dB).

3. When the peak results are less than average limit, so not need to evaluate the average.



Standard:	FCC Part 15.247	Test Distance:	3 m
Test item:	Band edge	Power:	AC 120 V/60 Hz
Frequency:	2412 MHz	Temp.(°C)/Hum.(%RH):	26(°C)/60 %RH
Mode:	Mode 4		
Ant.Polar.:	Horizontal		

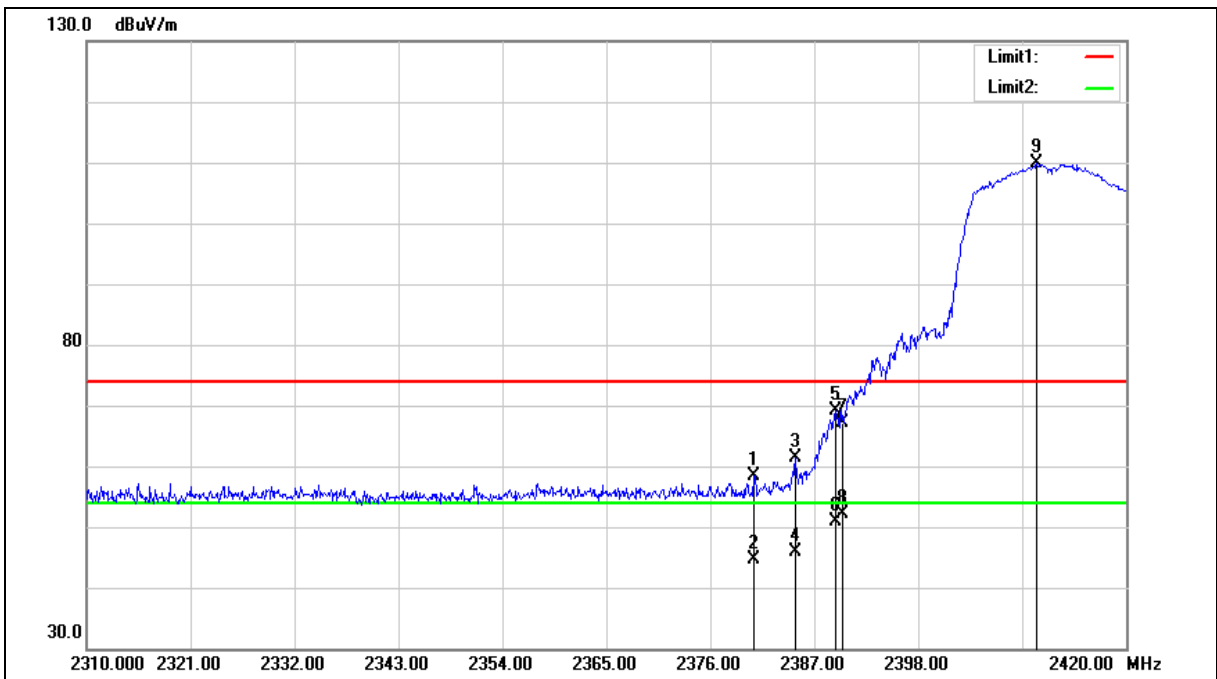



Standard:	FCC Part 15.247	Test Distance:	3 m
Test item:	Band edge	Power:	AC 120 V/60 Hz
Frequency:	2412 MHz	Temp.(°C)/Hum.(%RH):	26(°C)/60 %RH
Mode:	Mode 4		
Ant.Polar.:	Horizontal		

No.	Frequency (MHz)	Reading (dBuV)	Correct Factor (dB/m)	Result (dBuV/m)	Limit (dBuV/m)	Margin (dB)	Remark
1	2380.620	59.58	-1.08	58.50	74.00	-15.50	peak
2	2380.620	45.74	-1.08	44.66	54.00	-9.34	AVG
3	2385.020	62.35	-1.07	61.28	74.00	-12.72	peak
4	2385.020	47.03	-1.07	45.96	54.00	-8.04	AVG
5	2389.200	70.23	-1.05	69.18	74.00	-4.82	peak
6	2389.200	51.95	-1.05	50.90	54.00	-3.10	AVG
7	2390.000	68.09	-1.05	67.04	74.00	-6.96	peak
8	2390.000	53.16	-1.05	52.11	54.00	-1.89	AVG
9	2410.540	110.80	-0.97	109.83	--	--	peak

Note:1.Result (dBuV/m) = Correct Factor (dB/m) + Reading(dBuV).

2.Correction factor (dB/m) = Antenna Factor (dB/m) + Cable loss (dB) – Pre-Amplifier gain (dB).

3. When the peak results are less than average limit, so not need to evaluate the average.



Standard:	FCC Part 15.247	Test Distance:	3 m
Test item:	Band edge	Power:	AC 120 V/60 Hz
Frequency:	2412 MHz	Temp.(°C)/Hum.(%RH):	26(°C)/60 %RH
Mode:	Mode 4		
Ant.Polar.:	Vertical		

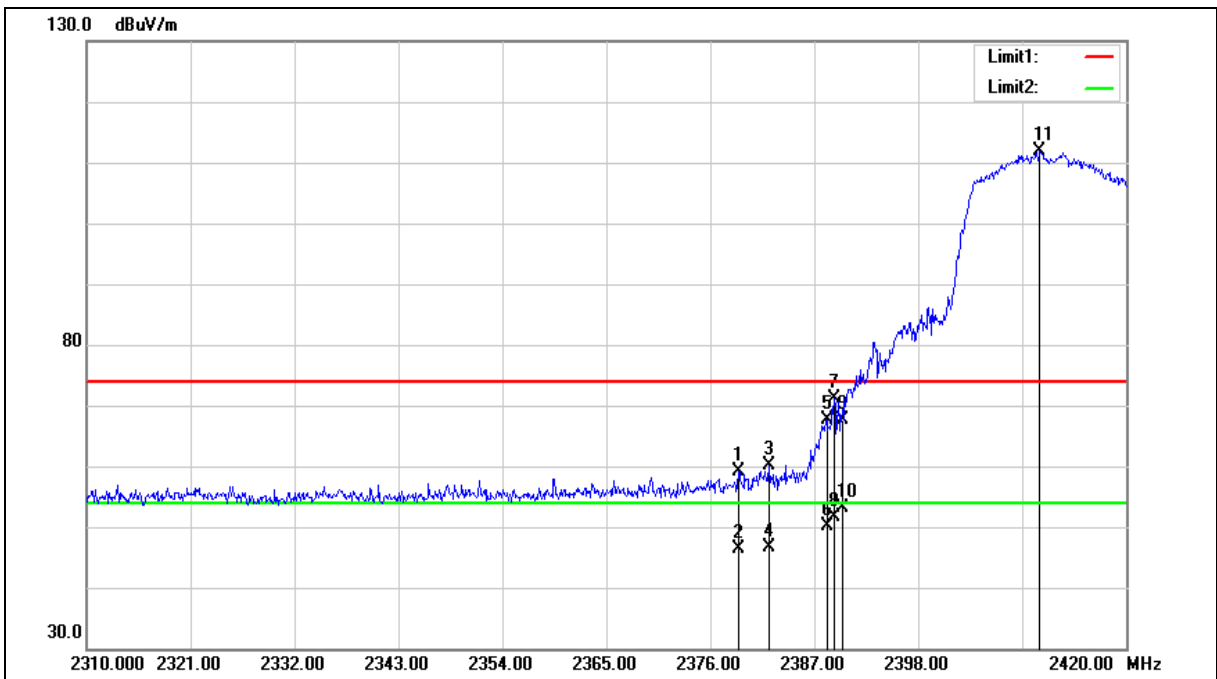



Standard:	FCC Part 15.247	Test Distance:	3 m
Test item:	Band edge	Power:	AC 120 V/60 Hz
Frequency:	2412 MHz	Temp.(°C)/Hum.(%RH):	26(°C)/60 %RH
Mode:	Mode 4		
Ant.Polar.:	Vertical		

No.	Frequency (MHz)	Reading (dBuV)	Correct Factor (dB/m)	Result (dBuV/m)	Limit (dBuV/m)	Margin (dB)	Remark
1	2378.970	60.18	-1.09	59.09	74.00	-14.91	peak
2	2378.970	47.50	-1.09	46.41	54.00	-7.59	AVG
3	2382.160	61.10	-1.08	60.02	74.00	-13.98	peak
4	2382.160	47.83	-1.08	46.75	54.00	-7.25	AVG
5	2388.320	68.71	-1.05	67.66	74.00	-6.34	peak
6	2388.320	51.15	-1.05	50.10	54.00	-3.90	AVG
7	2389.090	72.09	-1.05	71.04	74.00	-2.96	peak
8	2389.090	52.58	-1.05	51.53	54.00	-2.47	AVG
9	2390.000	68.58	-1.05	67.53	74.00	-6.47	peak
10	2390.000	54.07	-1.05	53.02	54.00	-0.98	AVG
11	2410.870	112.86	-0.97	111.89	--	--	peak

Note:1.Result (dBuV/m) = Correct Factor (dB/m) + Reading(dBuV).

2.Correction factor (dB/m) = Antenna Factor (dB/m) + Cable loss (dB) – Pre-Amplifier gain (dB).

3. When the peak results are less than average limit, so not need to evaluate the average.



Standard:	FCC Part 15.247	Test Distance:	3 m
Test item:	Band edge	Power:	AC 120 V/60 Hz
Frequency:	2462 MHz	Temp.(°C)/Hum.(%RH):	26(°C)/60 %RH
Mode:	Mode 4		
Ant.Polar.:	Horizontal		

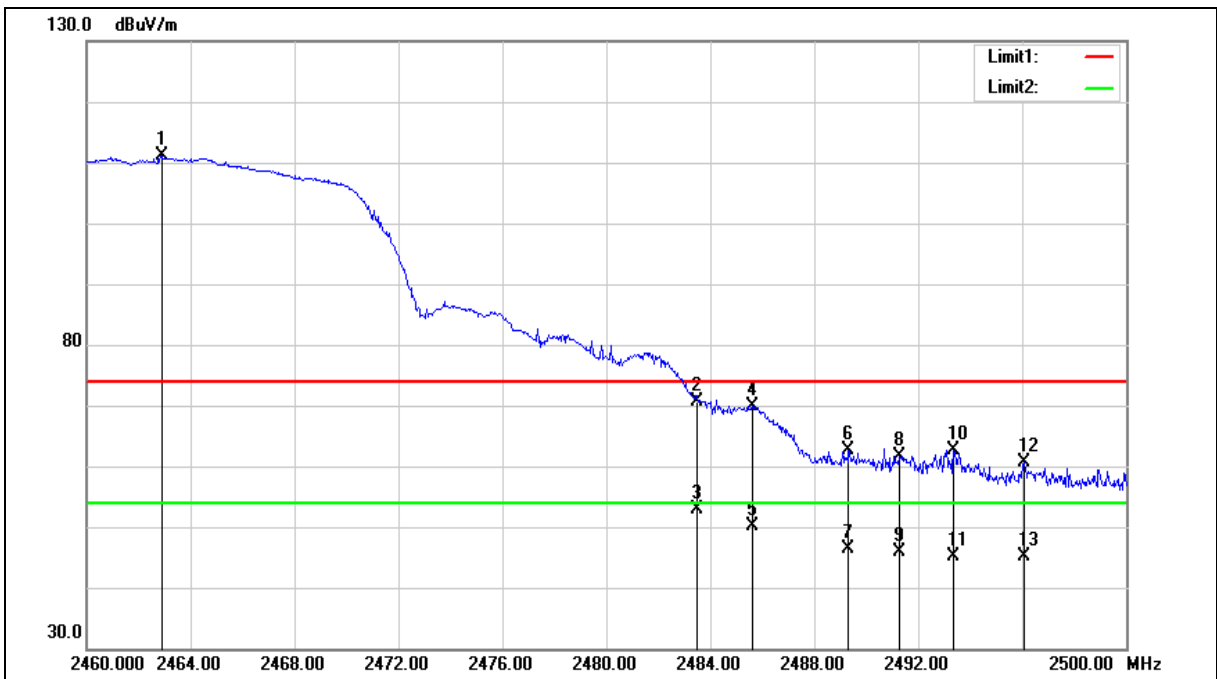



Standard:	FCC Part 15.247	Test Distance:	3 m
Test item:	Band edge	Power:	AC 120 V/60 Hz
Frequency:	2462 MHz	Temp.(°C)/Hum.(%RH):	26(°C)/60 %RH
Mode:	Mode 4		
Ant.Polar.:	Horizontal		

No.	Frequency (MHz)	Reading (dBuV)	Correct Factor (dB/m)	Result (dBuV/m)	Limit (dBuV/m)	Margin (dB)	Remark
1	2462.880	111.95	-0.78	111.17	--	--	peak
2	2483.500	71.40	-0.70	70.70	74.00	-3.30	peak
3	2483.500	53.53	-0.70	52.83	54.00	-1.17	AVG
4	2485.600	70.68	-0.70	69.98	74.00	-4.02	peak
5	2485.600	50.78	-0.70	50.08	54.00	-3.92	AVG
6	2489.320	63.36	-0.68	62.68	74.00	-11.32	peak
7	2489.320	47.09	-0.68	46.41	54.00	-7.59	AVG
8	2491.280	62.35	-0.67	61.68	74.00	-12.32	peak
9	2491.280	46.44	-0.67	45.77	54.00	-8.23	AVG
10	2493.360	63.42	-0.67	62.75	74.00	-11.25	peak
11	2493.360	45.89	-0.67	45.22	54.00	-8.78	AVG
12	2496.080	61.23	-0.65	60.58	74.00	-13.42	peak
13	2496.080	45.79	-0.65	45.14	54.00	-8.86	AVG

Note:1.Result (dBuV/m) = Correct Factor (dB/m) + Reading(dBuV).

2.Correction factor (dB/m) = Antenna Factor (dB/m) + Cable loss (dB) – Pre-Amplifier gain (dB).

3. When the peak results are less than average limit, so not need to evaluate the average.



Standard:	FCC Part 15.247	Test Distance:	3 m
Test item:	Band edge	Power:	AC 120 V/60 Hz
Frequency:	2462 MHz	Temp.(°C)/Hum.(%RH):	26(°C)/60 %RH
Mode:	Mode 4		
Ant.Polar.:	Vertical		

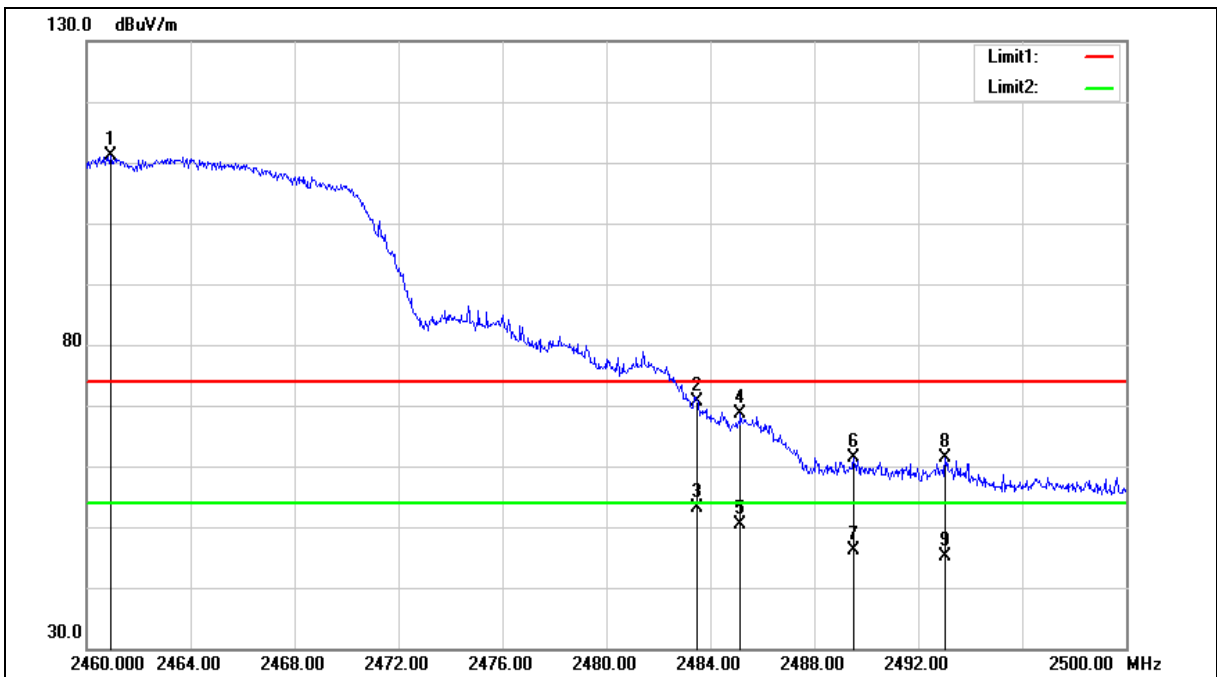



Standard:	FCC Part 15.247	Test Distance:	3 m
Test item:	Band edge	Power:	AC 120 V/60 Hz
Frequency:	2462 MHz	Temp.(°C)/Hum.(%RH):	26(°C)/60 %RH
Mode:	Mode 4		
Ant.Polar.:	Vertical		

No.	Frequency (MHz)	Reading (dBuV)	Correct Factor (dB/m)	Result (dBuV/m)	Limit (dBuV/m)	Margin (dB)	Remark
1	2460.920	111.81	-0.79	111.02	--	--	peak
2	2483.500	71.33	-0.70	70.63	74.00	-3.37	peak
3	2483.500	53.87	-0.70	53.17	54.00	-0.83	AVG
4	2485.160	69.32	-0.70	68.62	74.00	-5.38	peak
5	2485.160	51.08	-0.70	50.38	54.00	-3.62	AVG
6	2489.520	62.00	-0.68	61.32	74.00	-12.68	peak
7	2489.520	46.81	-0.68	46.13	54.00	-7.87	AVG
8	2493.040	62.04	-0.67	61.37	74.00	-12.63	peak
9	2493.040	45.87	-0.67	45.20	54.00	-8.80	AVG

Note:1.Result (dBuV/m) = Correct Factor (dB/m) + Reading(dBuV).

2.Correction factor (dB/m) = Antenna Factor (dB/m) + Cable loss (dB) – Pre-Amplifier gain (dB).

3. When the peak results are less than average limit, so not need to evaluate the average.



Standard:	FCC Part 15.247	Test Distance:	3 m
Test item:	Band edge	Power:	AC 120 V/60 Hz
Frequency:	2422 MHz	Temp.(°C)/Hum.(%RH):	26(°C)/60 %RH
Mode:	Mode 5		
Ant.Polar.:	Horizontal		

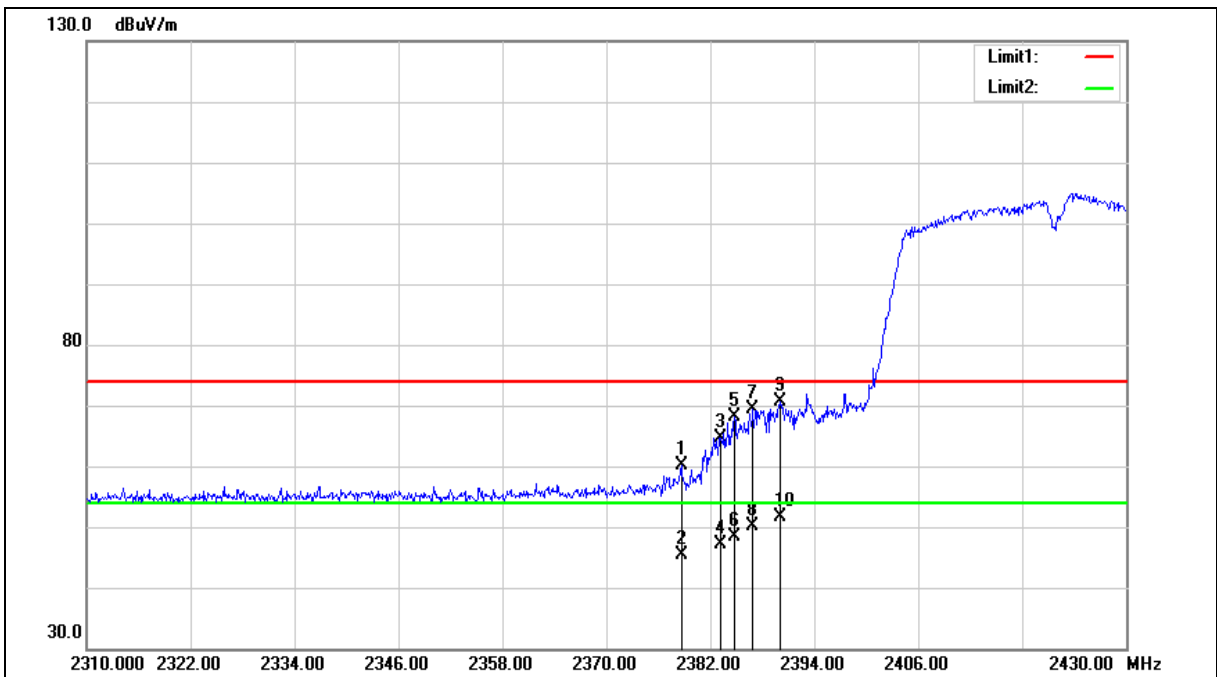



Standard:	FCC Part 15.247	Test Distance:	3 m
Test item:	Band edge	Power:	AC 120 V/60 Hz
Frequency:	2422 MHz	Temp.(°C)/Hum.(%RH):	26(°C)/60 %RH
Mode:	Mode 5		
Ant.Polar.:	Horizontal		

No.	Frequency (MHz)	Reading (dBuV)	Correct Factor (dB/m)	Result (dBuV/m)	Limit (dBuV/m)	Margin (dB)	Remark
1	2378.640	61.28	-1.10	60.18	74.00	-13.82	peak
2	2378.640	46.44	-1.10	45.34	54.00	-8.66	AVG
3	2383.200	65.79	-1.07	64.72	74.00	-9.28	peak
4	2383.200	48.18	-1.07	47.11	54.00	-6.89	AVG
5	2384.760	69.15	-1.07	68.08	74.00	-5.92	peak
6	2384.760	49.57	-1.07	48.50	54.00	-5.50	AVG
7	2386.920	70.37	-1.06	69.31	74.00	-4.69	peak
8	2386.920	51.11	-1.06	50.05	54.00	-3.95	AVG
9	2390.000	71.57	-1.05	70.52	74.00	-3.48	peak
10	2390.000	52.71	-1.05	51.66	54.00	-2.34	AVG

Note:1.Result (dBuV/m) = Correct Factor (dB/m) + Reading(dBuV).

2.Correction factor (dB/m) = Antenna Factor (dB/m) + Cable loss (dB) – Pre-Amplifier gain (dB).

3. When the peak results are less than average limit, so not need to evaluate the average.



Standard:	FCC Part 15.247	Test Distance:	3 m
Test item:	Band edge	Power:	AC 120 V/60 Hz
Frequency:	2422 MHz	Temp.(°C)/Hum.(%RH):	26(°C)/60 %RH
Mode:	Mode 5		
Ant.Polar.:	Vertical		

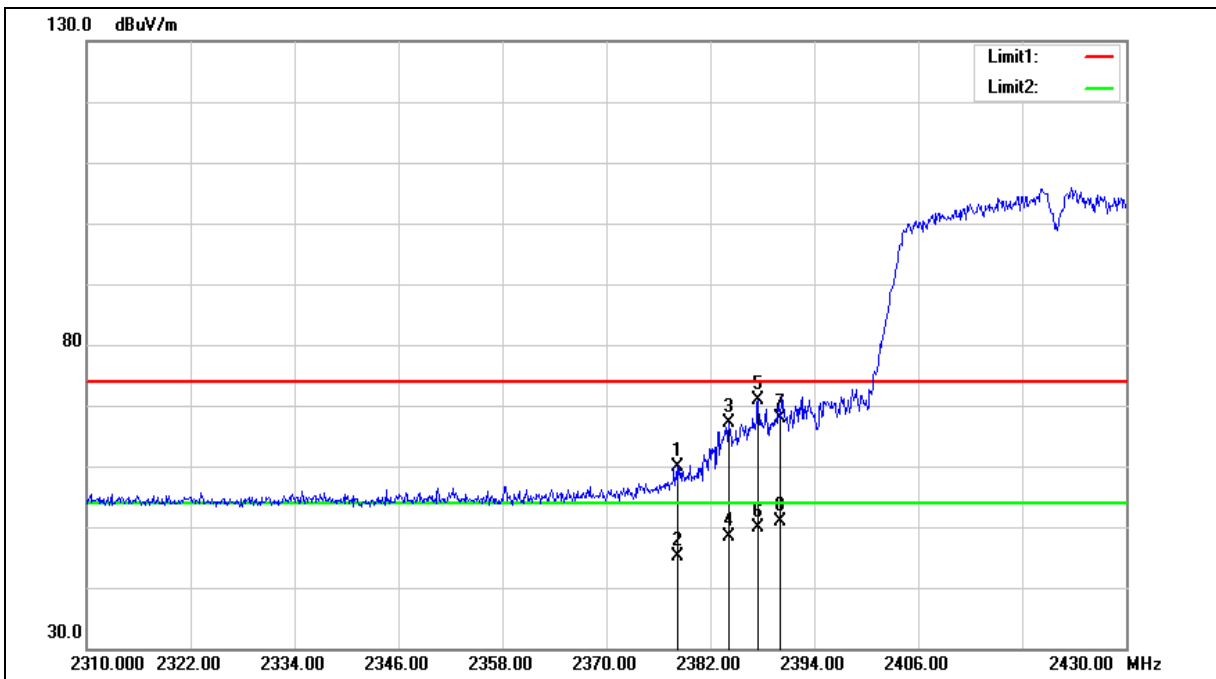



Standard:	FCC Part 15.247	Test Distance:	3 m
Test item:	Band edge	Power:	AC 120 V/60 Hz
Frequency:	2422 MHz	Temp.(°C)/Hum.(%RH):	26(°C)/60 %RH
Mode:	Mode 5		
Ant.Polar.:	Vertical		

No.	Frequency (MHz)	Reading (dBuV)	Correct Factor (dB/m)	Result (dBuV/m)	Limit (dBuV/m)	Margin (dB)	Remark
1	2378.160	60.93	-1.10	59.83	74.00	-14.17	peak
2	2378.160	46.23	-1.10	45.13	54.00	-8.87	AVG
3	2384.160	68.13	-1.07	67.06	74.00	-6.94	peak
4	2384.160	49.41	-1.07	48.34	54.00	-5.66	AVG
5	2387.520	71.99	-1.05	70.94	74.00	-3.06	peak
6	2387.520	50.95	-1.05	49.90	54.00	-4.10	AVG
7	2390.000	69.01	-1.05	67.96	74.00	-6.04	peak
8	2390.000	52.01	-1.05	50.96	54.00	-3.04	AVG

Note:1.Result (dBuV/m) = Correct Factor (dB/m) + Reading(dBuV).

2.Correction factor (dB/m) = Antenna Factor (dB/m) + Cable loss (dB) – Pre-Amplifier gain (dB).

3. When the peak results are less than average limit, so not need to evaluate the average.



Standard:	FCC Part 15.247	Test Distance:	3 m
Test item:	Band edge	Power:	AC 120 V/60 Hz
Frequency:	2452 MHz	Temp.(°C)/Hum.(%RH):	26(°C)/60 %RH
Mode:	Mode 5		
Ant.Polar.:	Horizontal		

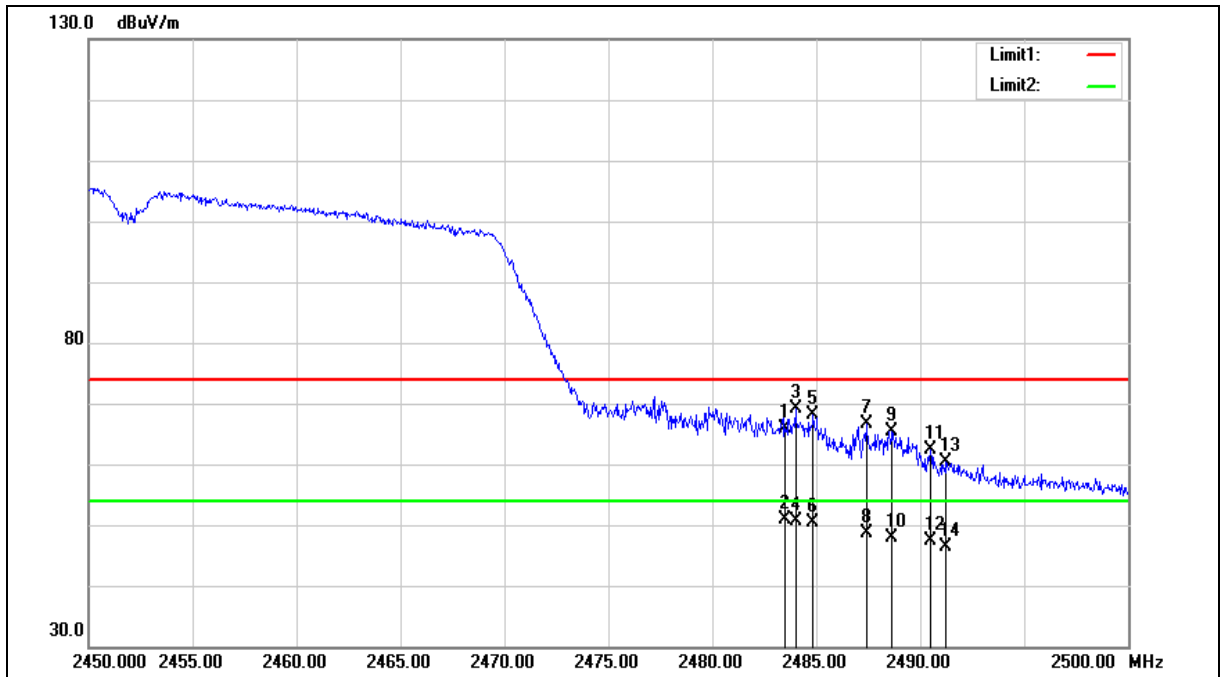



Standard:	FCC Part 15.247	Test Distance:	3 m
Test item:	Band edge	Power:	AC 120 V/60 Hz
Frequency:	2452 MHz	Temp.(°C)/Hum.(%RH):	26(°C)/60 %RH
Mode:	Mode 5		
Ant.Polar.:	Horizontal		

No.	Frequency (MHz)	Reading (dBUV)	Correct Factor (dB/m)	Result (dBUV/m)	Limit (dBUV/m)	Margin (dB)	Remark
1	2483.500	66.68	-0.70	65.98	74.00	-8.02	peak
2	2483.500	51.59	-0.70	50.89	54.00	-3.11	AVG
3	2484.000	69.79	-0.70	69.09	74.00	-4.91	peak
4	2484.000	51.45	-0.70	50.75	54.00	-3.25	AVG
5	2484.850	68.72	-0.70	68.02	74.00	-5.98	peak
6	2484.850	51.01	-0.70	50.31	54.00	-3.69	AVG
7	2487.400	67.35	-0.69	66.66	74.00	-7.34	peak
8	2487.400	49.24	-0.69	48.55	54.00	-5.45	AVG
9	2488.650	66.08	-0.68	65.40	74.00	-8.60	peak
10	2488.650	48.49	-0.68	47.81	54.00	-6.19	AVG
11	2490.500	63.03	-0.67	62.36	74.00	-11.64	peak
12	2490.500	47.99	-0.67	47.32	54.00	-6.68	AVG
13	2491.250	60.93	-0.67	60.26	74.00	-13.74	peak
14	2491.250	46.98	-0.67	46.31	54.00	-7.69	AVG

Note:1.Result (dBUV/m) = Correct Factor (dB/m) + Reading(dBUV).

2.Correction factor (dB/m) = Antenna Factor (dB/m) + Cable loss (dB) – Pre-Amplifier gain (dB).

3. When the peak results are less than average limit, so not need to evaluate the average.



Standard:	FCC Part 15.247	Test Distance:	3 m
Test item:	Band edge	Power:	AC 120 V/60 Hz
Frequency:	2452 MHz	Temp.(°C)/Hum.(%RH):	26(°C)/60 %RH
Mode:	Mode 5		
Ant.Polar.:	Vertical		

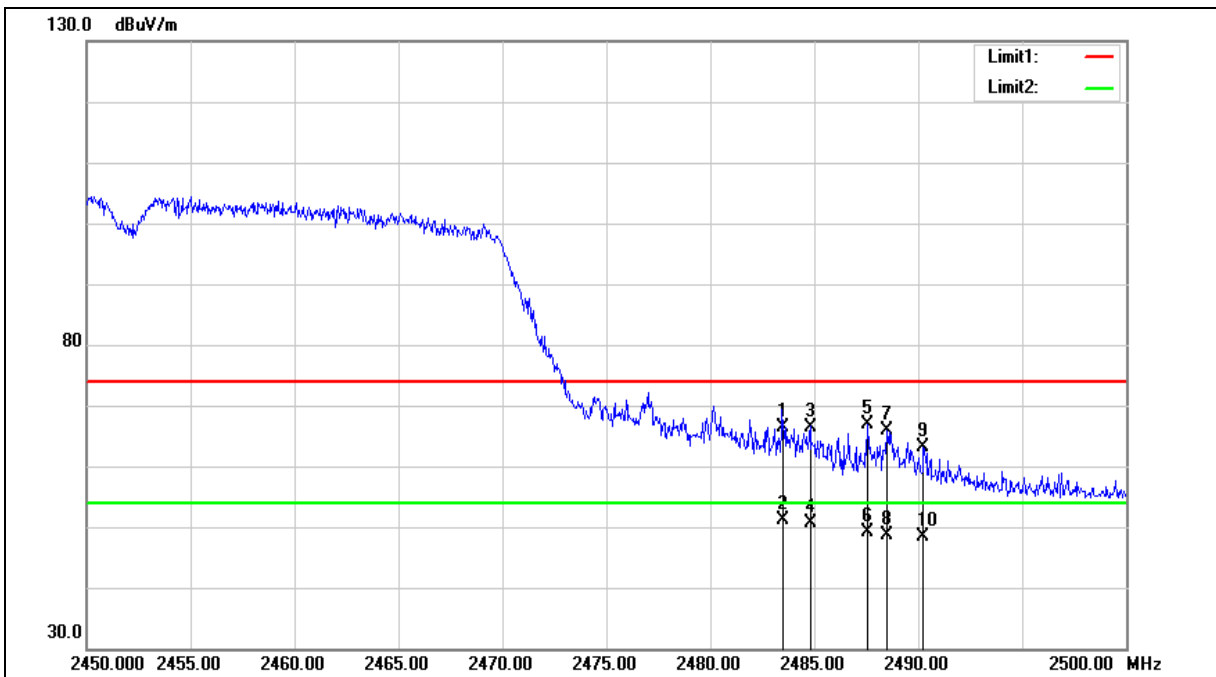



Standard:	FCC Part 15.247	Test Distance:	3 m
Test item:	Band edge	Power:	AC 120 V/60 Hz
Frequency:	2452 MHz	Temp.(°C)/Hum.(%RH):	26(°C)/60 %RH
Mode:	Mode 5		
Ant.Polar.:	Vertical		

No.	Frequency (MHz)	Reading (dBuV)	Correct Factor (dB/m)	Result (dBuV/m)	Limit (dBuV/m)	Margin (dB)	Remark
1	2483.500	67.11	-0.70	66.41	74.00	-7.59	peak
2	2483.500	51.89	-0.70	51.19	54.00	-2.81	AVG
3	2484.800	67.20	-0.70	66.50	74.00	-7.50	peak
4	2484.800	51.34	-0.70	50.64	54.00	-3.36	AVG
5	2487.550	67.52	-0.68	66.84	74.00	-7.16	peak
6	2487.550	49.85	-0.68	49.17	54.00	-4.83	AVG
7	2488.500	66.63	-0.68	65.95	74.00	-8.05	peak
8	2488.500	49.28	-0.68	48.60	54.00	-5.40	AVG
9	2490.250	63.71	-0.68	63.03	74.00	-10.97	peak
10	2490.250	49.01	-0.68	48.33	54.00	-5.67	AVG

Note:1.Result (dBuV/m) = Correct Factor (dB/m) + Reading(dBuV).

2.Correction factor (dB/m) = Antenna Factor (dB/m) + Cable loss (dB) – Pre-Amplifier gain (dB).

3. When the peak results are less than average limit, so not need to evaluate the average.

--- END---