



RADIO TEST REPORT

Report No.: STS2206021W02

Issued for

Swann Communications Pty Ltd

Unit 5B, 706 Lorimer Street Port Melbourne, Victoria, Australia
a 3207

Product Name:	CoreCam Pro 2K Wire-Free Security Camera with Spotlight
Brand Name:	Swann
Model Name:	SWIFI-COREPRO
Series Model:	N/A
FCC ID:	VMICOREPRO
IC:	12494A-COREPRO
Test Standard:	FCC Part 15.247 RSS-247 Issue 2, February 2017 RSS-Gen Issue 5, Amendment 2, February 2021

Any reproduction of this document must be done in full. No single part of this document may be reproduced without permission from STS, all test data presented in this report is only applicable to presented test sample.

Shenzhen STS Test Services Co., Ltd.
A 1/F, Building B, Zhuoke Science Park, No.190 Chongqing Road, HepingShequ,
Fuyong Sub-District, Bao'an District, Shenzhen, Guang Dong, China
TEL: +86-755 3688 6288 FAX: +86-755 3688 6277 E-mail: sts@stsapp.com





TEST RESULT CERTIFICATION

Applicant's Name: Swann Communications Pty Ltd
Address: Unit 5B, 706 Lorimer Street Port Melbourne, Victoria, Australia 3207

Manufacturer's Name.....: Swann Communications Pty Ltd
Address: Unit 5B, 706 Lorimer Street Port Melbourne, Victoria, Australia 3207

Product Description

Product Name.....: CoreCam Pro 2K Wire-Free Security Camera with Spotlight
Brand Name.....: Swann
Model Name: SWIFI-COREPRO
Series Model.....: N/A
FCC Part 15.247

Test Standards: RSS-247 Issue 2, February 2017
RSS-Gen Issue 5, Amendment 2, February 2021

Test Procedure.....: ANSI C63.10-2013

This device described above has been tested by STS, the test results show that the equipment under test (EUT) is in compliance with the FCC/IC requirements. And it is applicable only to the tested sample identified in the report.

This report shall not be reproduced except in full, without the written approval of STS, this document only be altered or revised by STS, personal only, and shall be noted in the revision of the document.

Date of Test

Date of receipt of test item.....: 06 June 2022
Date (s) of performance of tests: 06 June 2022 ~ 23 June 2022
Date of Issue: 23 June 2022
Test Result.....: **Pass**

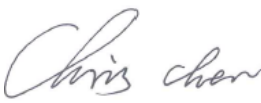
Testing Engineer : 

(Chris Chen)

Technical Manager : 

(Sean she)

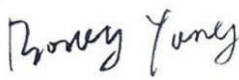
Authorized Signatory : 

(Bovey Yang)





Table of Contents	Page
1. SUMMARY OF TEST RESULTS	6
1.1 TEST FACTORY	7
1.2 MEASUREMENT UNCERTAINTY	7
2. GENERAL INFORMATION	8
2.1 GENERAL DESCRIPTION OF THE EUT	8
2.2 DESCRIPTION OF THE TEST MODES	10
2.3 TEST SOFTWARE AND POWER LEVEL	10
2.4 BLOCK DIAGRAM SHOWING THE CONFIGURATION OF SYSTEM TESTED	11
2.5 DESCRIPTION OF NECESSARY ACCESSORIES AND SUPPORT UNITS	12
2.6 EQUIPMENTS LIST FOR ALL TEST ITEMS	13
3. EMC EMISSION TEST	15
3.1 CONDUCTED EMISSION MEASUREMENT	15
3.2 RADIATED EMISSION MEASUREMENT	19
4. CONDUCTED SPURIOUS & BAND EDGE EMISSION	32
4.1 LIMIT	32
4.2 TEST PROCEDURE	32
4.3 DEVIATION FROM STANDARD	32
4.4 TEST SETUP	32
4.5 EUT OPERATION CONDITIONS	32
4.6 TEST RESULTS	32
5. POWER SPECTRAL DENSITY TEST	33
5.1 LIMIT	33
FCC PART15.247 , SUBPART C	33
RSS-247 ISSUE 2	33
5.2 TEST PROCEDURE	33
5.3 DEVIATION FROM STANDARD	33
5.4 TEST SETUP	33
5.5 EUT OPERATION CONDITIONS	33
5.6 TEST RESULTS	33
6. BANDWIDTH TEST	34
6.1 LIMIT	34
6.2 TEST PROCEDURE	34
6.3 DEVIATION FROM STANDARD	34



Table of Contents	Page
6.4 TEST SETUP	34
6.5 EUT OPERATION CONDITIONS	34
6.6 TEST RESULTS	34
7. PEAK OUTPUT POWER TEST	35
7.1 LIMIT	35
7.2 TEST PROCEDURE	35
7.3 DEVIATION FROM STANDARD	35
7.4 TEST SETUP	36
7.5 EUT OPERATION CONDITIONS	36
7.6 TEST RESULTS	36
8. ANTENNA REQUIREMENT	37
8.1 STANDARD REQUIREMENT	37
8.2 EUT ANTENNA	37
9. FREQUENCY STABILITY	38
9.1 LIMITS OF FREQUENCY STABILITY MEASUREMENT	38
9.2 TEST PROCEDURE	38
9.3 TEST RESULT	38
APPENDIX 1-TEST DATA	39
1. DUTY CYCLE	39
2. MAXIMUM AVERAGE CONDUCTED OUTPUT POWER	46
3. MAXIMUM PEAK CONDUCTED OUTPUT POWER	53
4. BANDWIDTH	60
5. MAXIMUM POWER SPECTRAL DENSITY LEVEL	73
6. BAND EDGE	80
7. CONDUCTED RF SPURIOUS EMISSION	89
APPENDIX 2-PHOTOS OF TEST SETUP	102



Revision History

Rev.	Issue Date	Report No.	Effect Page	Contents
00	23 June 2022	STS2206021W02	ALL	Initial Issue





1. SUMMARY OF TEST RESULTS

Test procedures according to the technical standards:
KDB 558074 D01 15.247 Meas Guidance v05r02.

FCC Part 15.247, Subpart C RSS-247 Issue 2			
Standard Section	Test Item	Judgment	Remark
15.207 RSS-Gen 8.8	Conducted Emission	PASS	--
15.247 (a)(2) RSS-Gen 6.7 RSS-247 5.2 a)	6dB&99% Bandwidth	PASS	--
15.247 (b)(3) RSS-247 5.4 d)	Output Power	PASS	--
15.209 RSS-Gen 8.9/8.10	Radiated Spurious Emission	PASS	--
15.247 (d) RSS-247 5.5 RSS-Gen 8.9/8.10	Conducted Spurious & Band Edge Emission	PASS	--
15.247 (e) RSS-247 5.2 b)	Power Spectral Density	PASS	--
15.205 RSS-Gen 8.9/8.10	Restricted Band Edge Emission	PASS	--
15.203 RSS-Gen 6.8	Antenna Requirement	PASS	--
RSS-Gen 6.11/8.11	Frequency Stability	PASS	--

NOTE:

- (1) 'N/A' denotes test is not applicable in this Test Report.
- (2) All tests are according to ANSI C63.10-2013.



1.1 TEST FACTORY

SHENZHEN STS TEST SERVICES CO., LTD

Add. : A 1/F, Building B, Zhuoke Science Park, No.190 Chongqing Road, HepingShequ, Fuyong Sub-District, Bao'an District, Shenzhen, Guang Dong, China

FCC test Firm Registration Number: 625569

IC test Firm Registration Number: 12108A

A2LA Certificate No.: 4338.01

1.2 MEASUREMENT UNCERTAINTY

The reported uncertainty of measurement $y \pm U$, where expanded uncertainty U is based on a standard uncertainty multiplied by a coverage factor of $k=2$, providing a level of confidence of approximately 95 %.

No.	Item	Uncertainty
1	RF output power, conducted	$\pm 0.87\text{dB}$
2	Unwanted Emissions, conducted	$\pm 2.895\text{dB}$
3	All emissions, radiated 9K-30MHz	$\pm 3.80\text{dB}$
4	All emissions, radiated 30M-1GHz	$\pm 4.09\text{dB}$
5	All emissions, radiated 1G-6GHz	$\pm 4.92\text{dB}$
6	All emissions, radiated >6G	$\pm 5.49\text{dB}$
7	Conducted Emission (9KHz-30MHz)	$\pm 2.73\text{dB}$



2. GENERAL INFORMATION

2.1 GENERAL DESCRIPTION OF THE EUT

Product Name/PMN	CoreCam Pro 2K Wire-Free Security Camera with Spotlight	
Trade Name	Swann	
Model Name/HVIN	SWIFI-COREPRO	
Series Model	N/A	
Model Difference	N/A	
Product Description	The EUT is a CoreCam Pro 2K Wire-Free Security Camera with Spotlight	
	Operation Frequency:	802.11b/g/n 20: 2412~2462 MHz 802.11n(40MHz):2422~2452MHz
	Modulation Type:	802.11b(DSSS):CCK,DQPSK,DBPSK 802.11g(OFDM):BPSK,QPSK,16-QAM,64-QAM 802.11n(OFDM):BPSK,QPSK,16-QAM,64-QAM
	Bit Rate of Transmitter:	802.11b:11/5.5/2/1 Mbps 802.11g:54/48/36/24/18/12/9/6Mbps 802.11n(20MHz): 65/58.5/52/39/26/19.5/13/6.5Mbps 802.11n(40MHz): 135/121.5/108/81/54/40.5/37/13.5Mbps
	Number of Channel:	802.11b/g/n20: 11CH 802.11n 40: 7CH
	Antenna Designation:	Please refer to the Note 3.
	Antenna Gain (dBi):	2dBi
	Channel List	Please refer to the Note 2.
Rating	Input: DC 5V 2A	
Battery	Rated Voltage:3.65V Charge Limit Voltage:4.2V MAX Capacity: 6000mAh	
Hardware version number	V1.0	
Software version number/FVIN	V1.0.41	
Serial Numbers	11093042200132	
Connecting I/O Port(s)	Please refer to the Note 1.	

Note:

1. For a more detailed features description, please refer to the manufacturer's specifications or the User Manual.



2.

Operation Frequency of channel			
802.11b/g/n(20MHz)		Channel List for 802.11n(40MHz)	
Channel	Frequency	Channel	Frequency
01	2412	03	2422
02	2417	04	2427
03	2422	05	2432
04	2427	06	2437
05	2432	07	2442
06	2437	08	2447
07	2442	09	2452
08	2447		
09	2452		
10	2457		
11	2462		

Note:

In section 15.31(m), regards to the operating frequency range over 10 MHz, the Lowest frequency, the middle frequency, and the highest frequency of channel were selected to perform the test, and the selected channel see below:

Carrier Frequency Channel

2.4GHz Test Frequency:

For 802.11b/g/n (HT20)		For 802.11n (HT40)	
Channel	Freq.(MHz)	Channel	Freq.(MHz)
01	2412	03	2422
06	2437	06	2437
11	2462	09	2452

3.

Ant.	Brand	Model Name	Antenna Type	Connector	Gain (dBi)	Note
1	Swann	SWIFI-COR EPRO	FPC	N/A	2dBi	WLAN Antenna

Note: The antenna information refer the manufacturer provide report, applicable only to the tested sample identified in the report. Due to the incorrect antenna information, a series of problems such as the accuracy of the test results will be borne by the customer.



2.2 DESCRIPTION OF THE TEST MODES

Each of these EUT operation mode(s) or test configuration mode(s) mentioned above was evaluated respectively.

Worst Mode	Description	Data Rate
Mode 1	TX IEEE 802.11b CH1	1 Mbps
Mode 2	TX IEEE 802.11b CH6	1 Mbps
Mode 3	TX IEEE 802.11 b CH11	1 Mbps
Mode 4	TX IEEE 802.11g CH1	6 Mbps
Mode 5	TX IEEE 802.11g CH6	6 Mbps
Mode 6	TX IEEE 802.11g CH11	6 Mbps
Mode 7	TX IEEE 802.11n HT20 CH1	MCS 0
Mode 8	TX IEEE 802.11n HT20 CH6	MCS 0
Mode 9	TX IEEE 802.11n HT20 CH11	MCS 0
Mode 10	TX IEEE 802.11n HT40 CH3	MCS 0
Mode 11	TX IEEE 802.11n HT40 CH6	MCS 0
Mode 12	TX IEEE 802.11n HT40 CH9	MCS 0

Note:

- (1) The measurements are performed at all Bit Rate of Transmitter, the worst data was reported.
- (2) We have be tested for all available U.S. voltage and frequencies(For 120V,50/60Hz and 240V, 50/60Hz) for which the device is capable of operation, and the worst case of 120V /60Hz is shown in the report.
- (3) The battery is fully-charged during the radited and RF conducted test.

AC Conducted Emission

Test Case	
AC Conducted Emission	Mode13: Keeping WIFI TX

2.3 TEST SOFTWARE AND POWER LEVEL

During testing channel & power controlling software provided by the customer was used to control the operating channel as well as the output power level.

RF Function	Type	Mode Or Modulation type	ANT Gain(dBi)	Power Class	Software For Testing
WIFI(2.4G)	2.4G WIFI	802.11b	2	30	QATool_Dbg
		802.11g		30	
		802.11n(HT20)		30	
		802.11n(HT40)		30	

2.4 BLOCK DIAGRAM SHOWING THE CONFIGURATION OF SYSTEM TESTED

Radiation Test Set

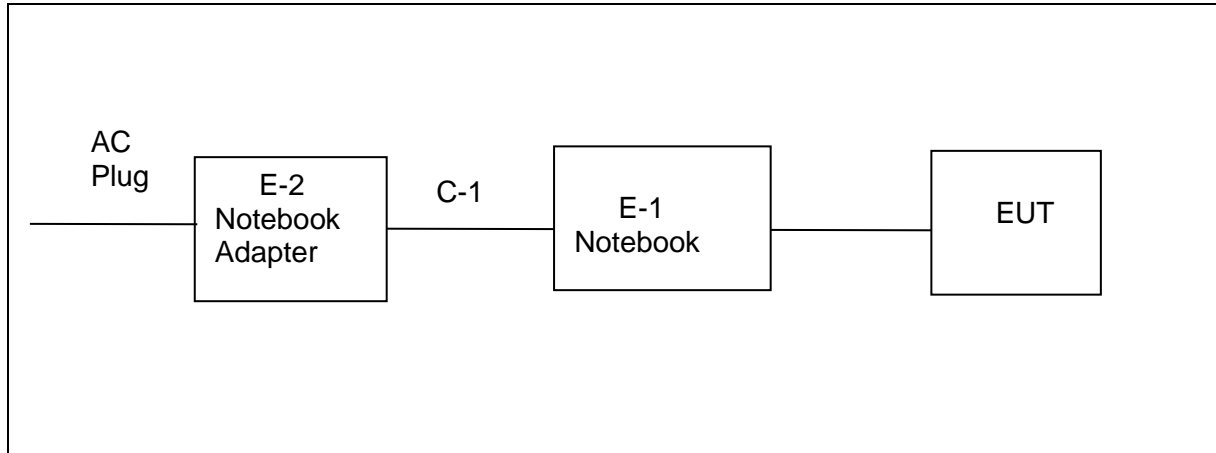

Conduction Test Set

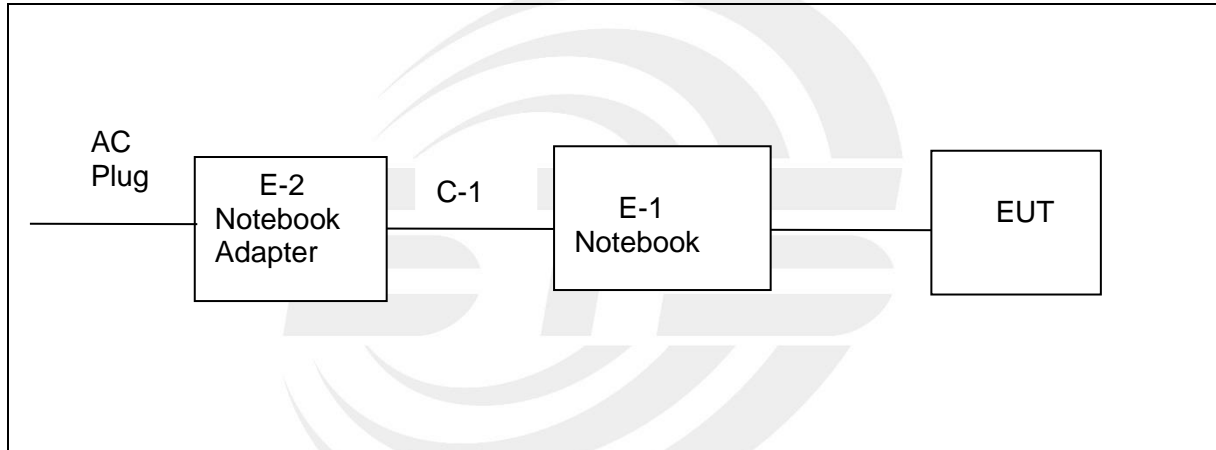



2.5 DESCRIPTION OF NECESSARY ACCESSORIES AND SUPPORT UNITS

The EUT has been tested as an independent unit together with other necessary accessories or support units. The following support units or accessories were used to form a representative test configuration during the tests.

Necessary accessories

Item	Equipment	Mfr/Brand	Model/Type No.	Length	Note
N/A	N/A	N/A	N/A	N/A	N/A

Support units

Item	Equipment	Mfr/Brand	Model/Type No.	Length	Note
E-2	Notebook Adapter	LENOVO	ADLX45DLC3A	N/A	N/A
E-1	Notebook	LENOVO	ThinkPad E470	N/A	N/A
C-1	USB Cable	N/A	N/A	150cm	NO

Note:

- (1) For detachable type I/O cable should be specified the length in cm in 『Length』 column.
- (2) “YES” is means “with core”; “NO” is means “without core”.



2.6 EQUIPMENTS LIST FOR ALL TEST ITEMS

Radiation Test equipment

Kind of Equipment	Manufacturer	Type No.	Serial No.	Last calibration	Calibrated until
Test Receiver	R&S	ESCI	101427	2021.09.30	2022.09.29
Signal Analyzer	R&S	FSV 40-N	101823	2021.09.30	2022.09.29
Active loop Antenna	ZHINAN	ZN30900C	16035	2021.04.11	2023.04.10
Bilog Antenna	TESEQ	CBL6111D	34678	2020.10.12	2022.10.11
Horn Antenna	SCHWARZBECK	BBHA 9120D	02014	2021.10.11	2023.10.10
SHF-EHF Horn Antenna (18G-40GHz)	A-INFO	LB-180400-KF	J211020657	2020.10.12	2022.10.11
Pre-Amplifier (0.1M-3GHz)	EM	EM330	060665	2021.10.08	2022.10.07
Pre-Amplifier (1G-18GHz)	SKET	LNPA-01018G-45	SK2018080901	2021.09.30	2022.09.29
Pre-Amplifier (18G-40GHz)	SKET	LNPA-1840-50	SK2018101801	2021.09.28	2022.09.27
Temperature & Humidity	HH660	Mieo	N/A	2021.10.09	2022.10.08
Turn table	EM	SC100_1	60531	N/A	N/A
Antenna mast	EM	SC100	N/A	N/A	N/A
Test SW	FARAD	EZ-EMC(Ver.STSLAB-03A1 RE)			

Conduction Test equipment

Kind of Equipment	Manufacturer	Type No.	Serial No.	Last calibration	Calibrated until
Test Receiver	R&S	ESCI	101427	2021.09.30	2022.09.29
LISN	R&S	ENV216	101242	2021.09.30	2022.09.29
LISN	EMCO	3810/2NM	23625	2021.09.30	2022.09.29
Temperature & Humidity	HH660	Mieo	N/A	2021.10.09	2022.10.08
Test SW	FARAD	EZ-EMC(Ver.STSLAB-03A1 CE)			



RF Connected Test

Kind of Equipment	Manufacturer	Type No.	Serial No.	Last calibration	Calibrated until
Power Sensor	Keysight	U2021XA	MY55520005	2021.09.30	2022.09.29
			MY55520006	2021.09.30	2022.09.29
			MY56120038	2021.09.30	2022.09.29
			MY56280002	2021.09.30	2022.09.29
Signal Analyzer	Agilent	N9020A	MY51110105	2022.03.01	2023.02.28
Temperature & Humidity	HH660	Mieo	N/A	2021.10.09	2022.10.08
Test SW	FARAD	EZ-EMC(Ver.STSLAB-03A1 RE)			





3. EMC EMISSION TEST

3.1 CONDUCTED EMISSION MEASUREMENT

3.1.1 POWER LINE CONDUCTED EMISSION LIMITS

The radio frequency voltage that is conducted back onto the AC power line on any frequency or frequencies, within the band 150 kHz to 30 MHz, shall not exceed the limits in the following table.

FREQUENCY (MHz)	Conducted Emissionlimit (dBuV)	
	Quasi-peak	Average
0.15 -0.5	66 - 56 *	56 - 46 *
0.50 -5.0	56.00	46.00
5.0 -30.0	60.00	50.00

Note:

- (1) The tighter limit applies at the band edges.
- (2) The limit of “ * ” marked band means the limitation decreases linearly with the logarithm of the frequency in the range.

The following table is the setting of the receiver

Receiver Parameters	Setting
Attenuation	10 dB
Start Frequency	0.15 MHz
Stop Frequency	30 MHz
IF Bandwidth	9 kHz

3.1.2 TEST PROCEDURE

- a. The EUT is 0.8 m from the horizontal ground plane and 0.4 m from the vertical ground plane with EUT being connected to the power mains through a line impedance stabilization network (LISN). All other support equipments are powered from additional LISN(s). The LISN provides 50 Ohm/ 50uH of coupling impedance for the measuring instrument.
- b. Interconnecting cables that hang closer than 40 cm to the ground plane shall be folded back and forth in the center forming a bundle 30 to 40 cm long.
- c. I/O cables that are not connected to a peripheral shall be bundled in the center. The end of the cable may be terminated, if required, using the correct terminating impedance. The overall length shall not exceed 1 m.
- d. LISN is at least 80 cm from the nearest part of EUT chassis.
- e. For the actual test configuration, please refer to the related Item –EUT Test Photos.

3.1.3 TEST SETUP

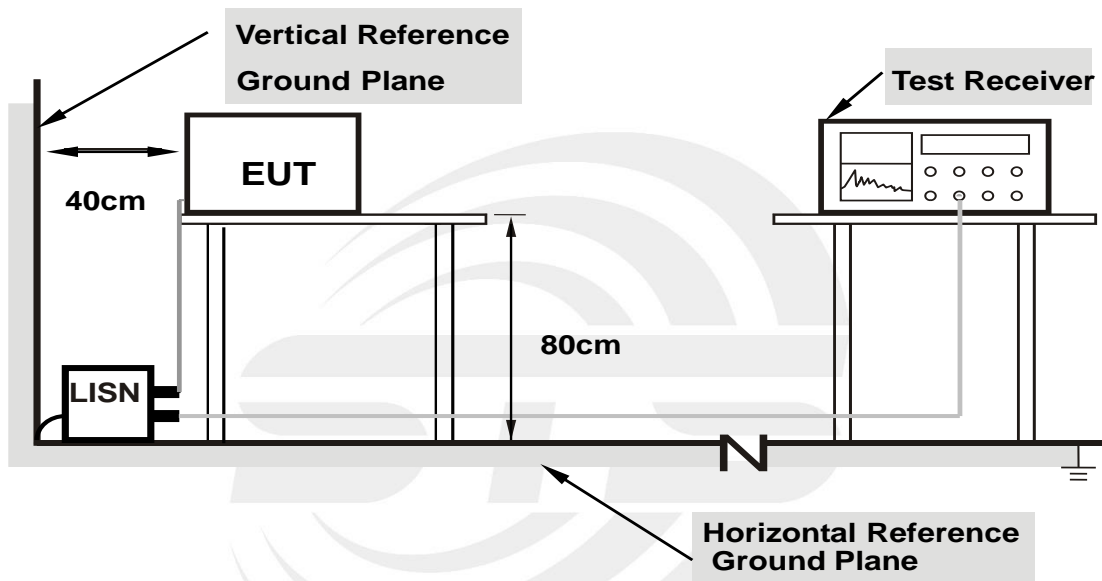

- Note: 1. Support units were connected to second LISN.**
2. Both of LISNs (AMN) are 80 cm from EUT and at least 80 cm from other units and other metal planes support units.

3.1.4 EUT OPERATING CONDITIONS

The EUT was configured for testing in a typical fashion (as a customer would normally use it). The EUT has been programmed to continuously transmit during test. This operating condition was tested and used to collect the included data.



3.1.5 TEST RESULT

Temperature:	25.4(C)	Relative Humidity:	51%RH
Test Voltage:	AC 120V/60Hz	Phase:	L
Test Mode:	Mode 13		

No.	Frequency (MHz)	Reading (dBuV)	Correct Factor(dB)	Result (dBuV)	Limit (dBuV)	Margin (dB)	Remark
1	0.1740	26.47	20.33	46.80	64.77	-17.97	QP
2	0.1740	11.48	20.33	31.81	54.77	-22.96	AVG
3	0.2260	22.41	20.43	42.84	62.60	-19.76	QP
4	0.2260	10.21	20.43	30.64	52.60	-21.96	AVG
5	0.5140	25.61	20.53	46.14	56.00	-9.86	QP
6	0.5140	12.58	20.53	33.11	46.00	-12.89	AVG
7	0.7340	23.29	20.34	43.63	56.00	-12.37	QP
8	0.7340	9.35	20.34	29.69	46.00	-16.31	AVG
9	1.1100	22.08	20.30	42.38	56.00	-13.62	QP
10	1.1100	8.79	20.30	29.09	46.00	-16.91	AVG
11	1.4220	22.85	20.30	43.15	56.00	-12.85	QP
12	1.4220	10.27	20.30	30.57	46.00	-15.43	AVG

Remark:

1. All readings are Quasi-Peak and Average values
2. Margin = Result (Result = Reading + Factor) – Limit
3. Factor=LISN factor+Cable loss+Limiter (10dB)

100.0 dBuV

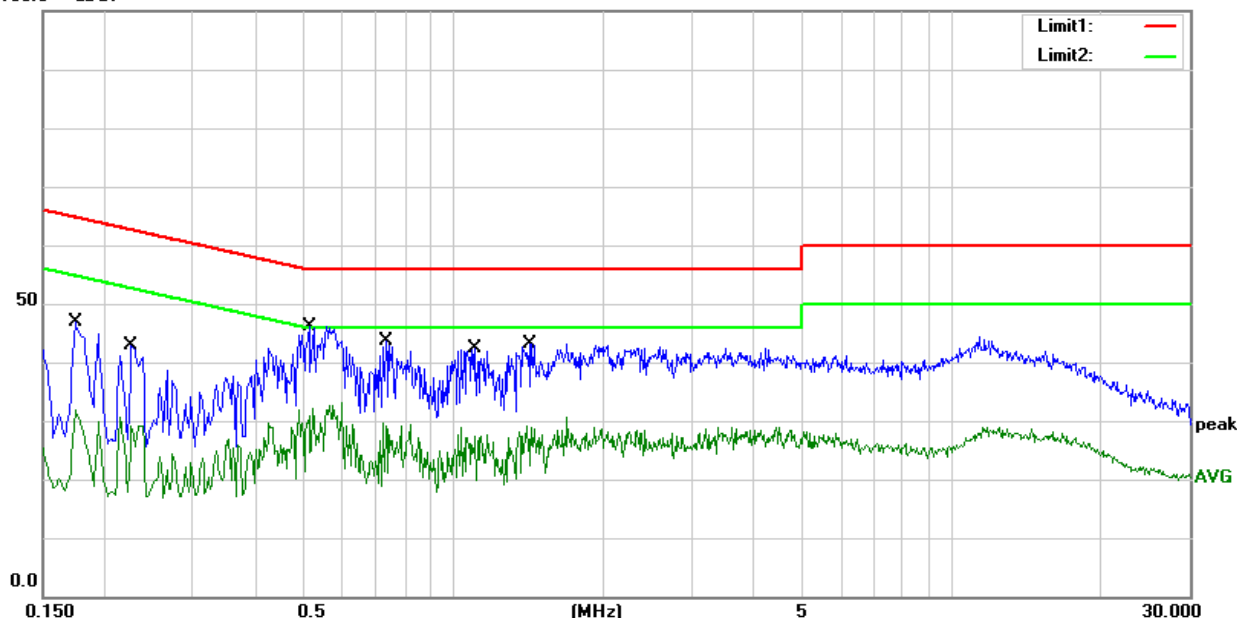



Temperature:	25.4(C)	Relative Humidity:	51%RH
Test Voltage:	AC 120V/60Hz	Phase:	N
Test Mode:	Mode 13		

No.	Frequency (MHz)	Reading (dBuV)	Correct Factor(dB)	Result (dBuV)	Limit (dBuV)	Margin (dB)	Remark
1	0.1860	25.99	20.31	46.30	64.21	-17.91	QP
2	0.1860	8.08	20.31	28.39	54.21	-25.82	AVG
3	0.2380	22.34	20.48	42.82	62.17	-19.35	QP
4	0.2380	6.59	20.48	27.07	52.17	-25.10	AVG
5	0.5260	23.05	20.52	43.57	56.00	-12.43	QP
6	0.5260	10.61	20.52	31.13	46.00	-14.87	AVG
7	0.8580	21.14	20.32	41.46	56.00	-14.54	QP
8	0.8580	6.76	20.32	27.08	46.00	-18.92	AVG
9	1.1460	21.53	20.30	41.83	56.00	-14.17	QP
10	1.1460	5.66	20.30	25.96	46.00	-20.04	AVG
11	1.4860	21.14	20.30	41.44	56.00	-14.56	QP
12	1.4860	6.80	20.30	27.10	46.00	-18.90	AVG

Remark:

1. All readings are Quasi-Peak and Average values
2. Margin = Result (Result =Reading + Factor)–Limit
3. Factor=LISN factor+Cable loss+Limiter (10dB)

100.0 dBuV

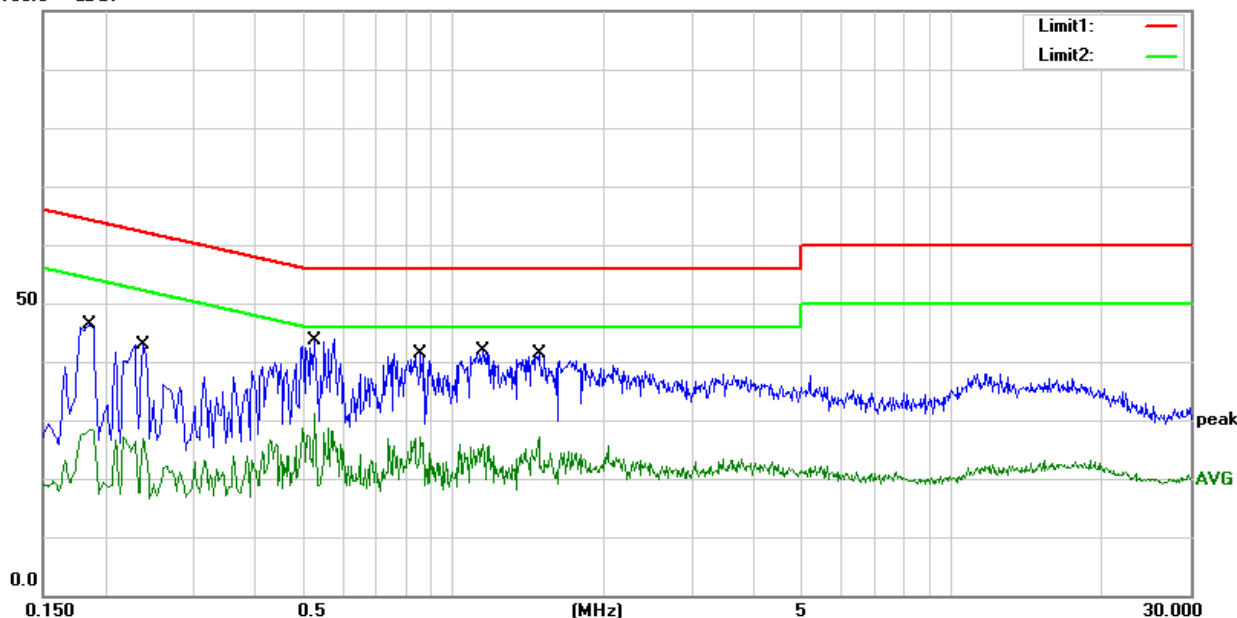



3.2 RADIATED EMISSION MEASUREMENT

3.2.1 RADIATED EMISSION LIMITS

In any 100 kHz bandwidth outside the operating frequency band. In case the emission fall within the Restricted band specified on Part15.205(a)&209(a), RSS-Gen Issue 5 and RSS-247 Issue 2, February 2017 (5.5) limit in the table and according to ANSI C63.10-2013 below has to be followed.

LIMITS OF RADIATED EMISSION MEASUREMENT (0.009MHz - 1000MHz)

Frequencies (MHz)	Field Strength (micровolts/meter)	Measurement Distance (meters)
0.009~0.490	2400/F(KHz)	300
0.490~1.705	24000/F(KHz)	30
1.705~30.0	30	30
30~88	100	3
88~216	150	3
216~960	200	3
Above 960	500	3

LIMITS OF RADIATED EMISSION MEASUREMENT (1000MHz-25GHz)

FREQUENCY (MHz)	(dBuV/m) (at 3M)	
	PEAK	AVERAGE
Above 1000	74	54

Notes:

- (1) The limit for radiated test was performed according to FCC PART 15C.
- (2) The tighter limit applies at the band edges.
- (3) Emission level (dBuV/m)=20log Emission level (uV/m).

LIMITS OF RESTRICTED FREQUENCY BANDS

FCC:

FREQUENCY (MHz)	FREQUENCY (MHz)	FREQUENCY (MHz)	FREQUENCY (GHz)
0.090-0.110	16.42-16.423	399.9-410	4.5-5.15
0.495-0.505	16.69475-16.69525	608-614	5.35-5.46
2.1735-2.1905	16.80425-16.80475	960-1240	7.25-7.75
4.125-4.128	25.5-25.67	1300-1427	8.025-8.5
4.17725-4.17775	37.5-38.25	1435-1626.5	9.0-9.2
4.20725-4.20775	73-74.6	1645.5-1646.5	9.3-9.5
6.215-6.218	74.8-75.2	1660-1710	10.6-12.7
6.26775-6.26825	108-121.94	1718.8-1722.2	13.25-13.4
6.31175-6.31225	123-138	2200-2300	14.47-14.5
8.291-8.294	149.9-150.05	2310-2390	15.35-16.2
8.362-8.366	156.52475-156.52525	2483.5-2500	17.7-21.4
8.37625-8.38675	156.7-156.9	2690-2900	22.01-23.12
8.41425-8.41475	162.0125-167.17	3260-3267	23.6-24.0
12.29-12.293	167.72-173.2	3332-3339	31.2-31.8
12.51975-12.52025	240-285	3345.8-3358	36.43-36.5
12.57675-12.57725	322-335.4	3600-4400	Above 38.6
13.36-13.41			



IC:

FREQUENCY (MHz)	FREQUENCY (MHz)	FREQUENCY (GHz)
0.090 - 0.110	149.9 - 150.05	9.0 - 9.2
0.495 - 0.505	156.52475 - 156.52525	9.3 - 9.5
2.1735 - 2.1905	156.7 - 156.9	10.6 - 12.7
3.020 - 3.026	162.0125 - 167.17	13.25 - 13.4
4.125 - 4.128	167.72 - 173.2	14.47 - 14.5
4.17725 - 4.17775	240 - 285	15.35 - 16.2
4.20725 - 4.20775	322 - 335.4	17.7 - 21.4
5.677 - 5.683	399.9 - 410	22.01 - 23.12
6.215 - 6.218	608 - 614	23.6 - 24.0
6.26775 - 6.26825	960 - 1427	31.2 - 31.8
6.31175 - 6.31225	1435 - 1626.5	36.43 - 36.5
8.291 - 8.294	1645.5 - 1646.5	Above 38.6
8.362 - 8.366	1660 - 1710	
8.37625 - 8.38675	1718.8 - 1722.2	
8.41425 - 8.41475	2200 - 2300	
12.29 - 12.293	2310 - 2390	
12.51975 - 12.52025	2483.5 - 2500	
12.57675 - 12.57725	2655 - 2900	
13.36 - 13.41	3260 - 3267	
16.42 - 16.423	3332 - 3339	
16.69475 - 16.69525	3345.8 - 3358	
16.80425 - 16.80475	3500 - 4400	
25.5 - 25.67	4500 - 5150	
37.5 - 38.25	5350 - 5460	
73 - 74.6	7250 - 7750	
74.8 - 75.2	8025 - 8500	
108 - 138		



For Radiated Emission

Spectrum Parameter	Setting
Attenuation	Auto
Detector	Peak/QP/AV
Start Frequency	9 KHz/150KHz(Peak/QP/AV)
Stop Frequency	150KHz/30MHz(Peak/QP/AV)
RB / VB (emission in restricted band)	200Hz (From 9kHz to 0.15MHz)/ 9KHz (From 0.15MHz to 30MHz); 200Hz (From 9kHz to 0.15MHz)/ 9KHz (From 0.15MHz to 30MHz)

Spectrum Parameter	Setting
Attenuation	Auto
Detector	Peak/QP
Start Frequency	30 MHz(Peak/QP)
Stop Frequency	1000 MHz (Peak/QP)
RB / VB (emission in restricted band)	120 KHz / 300 KHz

Spectrum Parameter	Setting
Attenuation	Auto
Detector	Peak/AV
Start Frequency	1000 MHz(Peak/AV)
Stop Frequency	10th carrier hamonic(Peak/AV)
RB / VB (emission in restricted band)	1 MHz / 3 MHz(Peak) 1 MHz/1/T MHz(AVG)

For Restricted band

Spectrum Parameter	Setting
Detector	Peak/AV
Start/Stop Frequency	Lower Band Edge: 2310 to 2430 MHz Upper Band Edge: 2445 to 2500 MHz
RB / VB	1 MHz / 3 MHz(Peak) 1 MHz/1/T MHz(AVG)



Receiver Parameter	Setting
Start ~ Stop Frequency	9kHz~90kHz / RB 200Hz for PK & AV
Start ~ Stop Frequency	90kHz~110kHz / RB 200Hz for QP
Start ~ Stop Frequency	110kHz~490kHz / RB 200Hz for PK & AV
Start ~ Stop Frequency	490kHz~30MHz / RB 9kHz for QP
Start ~ Stop Frequency	30MHz~1000MHz / RB 120kHz for QP

3.2.2 TEST PROCEDURE

- a. The measuring distance at 3 m shall be used for measurements at frequency 0.009MHz up to 1GHz, and above 1GHz.
- b. The EUT was placed on the top of a rotating table 0.8 m (above 1GHz is 1.5 m) above the ground at a 3 m anechoic chamber test site. The table was rotated 360 degree to determine the position of the highest radiation.
- c. The height of the equipment shall be 0.8 m (above 1GHz is 1.5 m); the height of the test antenna shall vary between 1 m to 4 m. Horizontal and vertical polarization of the antenna are set to make the measurement.
- d. The initial step in collecting conducted emission data is a spectrum analyzer peak detector mode pre-scanning the measurement frequency range. Significant peaks are then marked and QuasiPeak detector mode will be re-measured.
- e. If the Peak Mode measured value is compliance with and lower than Quasi Peak Mode Limit, the EUT shall be deemed to meet QP Limits and no additional QP Mode measurement was performed.
- f. For the actual test configuration, please refer to the related Item –EUT Test Photos.

Note:

Both horizontal and vertical antenna polarities were tested and performed pretest to three orthogonal axis. The worst case emissions were reported.

3.2.3 TEST SETUP

(A) Radiated Emission Test-Up Frequency Below 30MHz

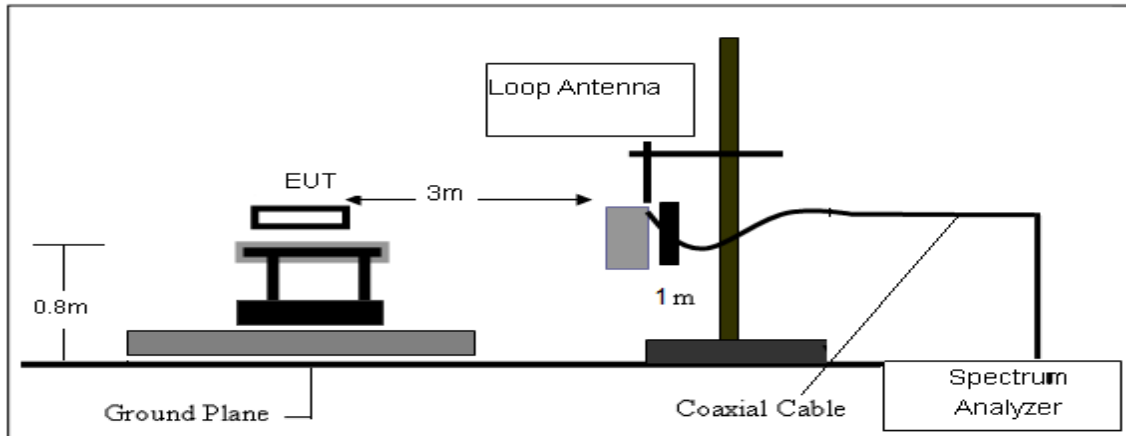

(B) Radiated Emission Test-Up Frequency 30MHz~1GHz

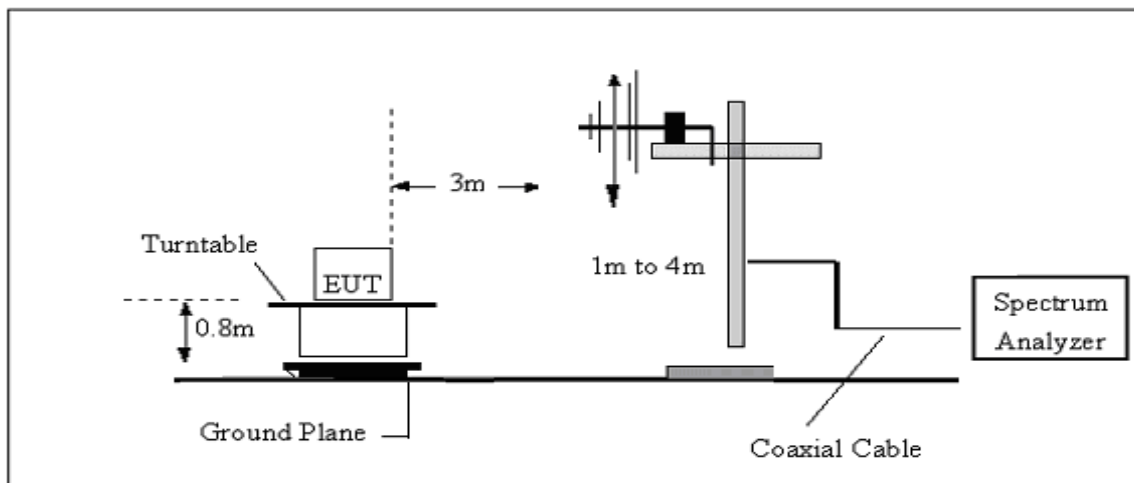

(C) Radiated Emission Test-Up Frequency Above 1GHz

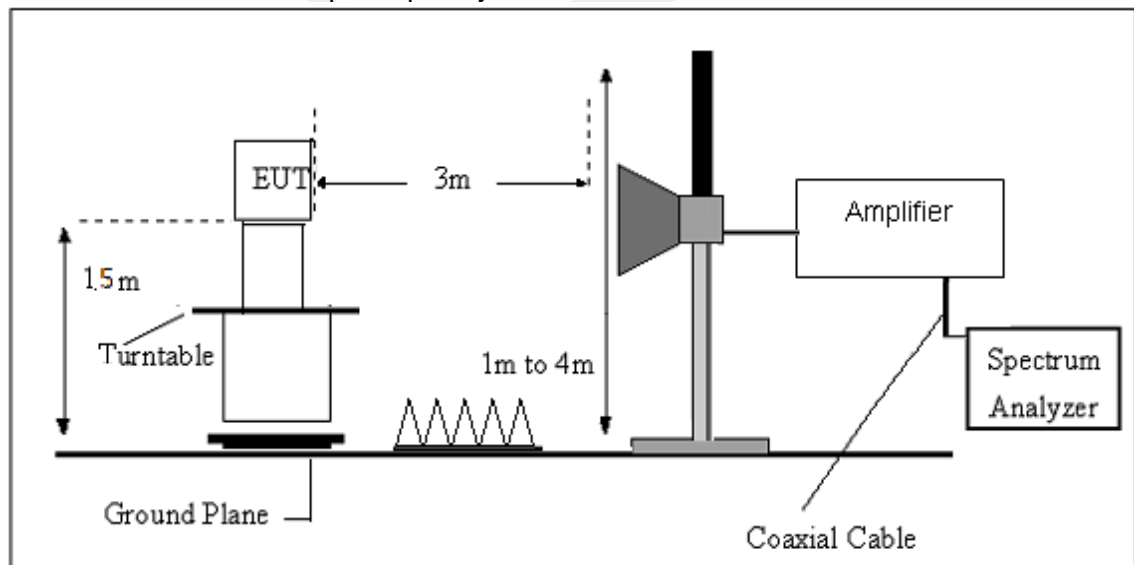

3.2.4 EUT OPERATING CONDITIONS

Please refer to section 3.1.4 of this report.



3.2.5 FIELD STRENGTH CALCULATION

The field strength is calculated by adding the Antenna Factor and Cable Factor and subtracting the Amplifier Gain and Duty Cycle Correction Factor (if any) from the measured reading. The basic equation with a sample calculation is as follows:

$$FS = RA + AF + CL - AG$$

Where

FS = Field Strength

CL = Cable Attenuation Factor (Cable Loss)

RA = Reading Amplitude

AG = Amplifier Gain

AF = Antenna Factor

For example

Frequency (MHz)	FS (dB μ V/m)	RA (dB μ V/m)	AF (dB)	CL (dB)	AG (dB)	Factor (dB)
300	40	58.1	12.2	1.6	31.9	-18.1

$$\text{Factor} = \text{AF} + \text{CL} - \text{AG}$$





3.2.6 TEST RESULT

9KHz-30MHz

Temperature:	23.1(C)	Relative Humidity:	60%RH
Test Voltage:	DC 3.65V	Polarization:	--
Test Mode:	TX Mode		

Freq. (MHz)	Reading (dBuV/m)	Limit (dBuV/m)	Margin (dB)	State P/F	Test Result
--	--	--	--	--	PASS
--	--	--	--	--	PASS

Note:

The amplitude of spurious emissions which are attenuated by more than 20dB below the permissible value has no need to be reported.

Distance extrapolation factor = $40 \log (\text{specific distance}/\text{test distance})$ (dB);

Limit line = specific limits(dBuv) + distance extrapolation factor.

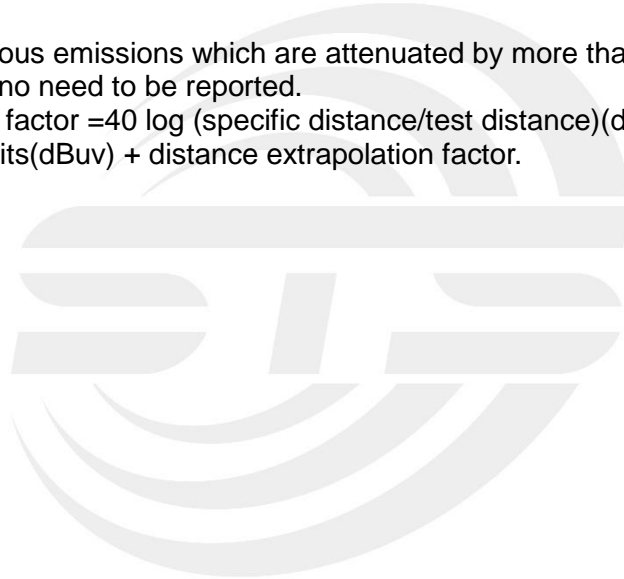



(30MHz - 1000MHz)

Temperature:	23.1(C)	Relative Humidity:	60%RH
Test Voltage:	DC 3.65V	Phase:	Horizontal
Test Mode:	Mode 1/2/3/4/5/6/7/8/9/10/11/12 (Mode 2 worst mode)		

No.	Frequency (MHz)	Reading (dBuV)	Correct Factor(dB/m)	Result (dBuV/m)	Limit (dBuV/m)	Margin (dB)	Remark
1	119.2400	56.30	-18.38	37.92	43.50	-5.58	peak
2	288.0200	56.11	-15.26	40.85	46.00	-5.15	peak
3	335.5500	54.58	-13.54	41.04	46.00	-4.96	peak
4	549.9200	46.41	-5.78	40.63	46.00	-5.37	peak
5	828.3100	39.03	-0.95	38.08	46.00	-7.92	peak
6	900.0900	38.98	-0.45	38.53	46.00	-7.47	peak

Remark:

- Margin = Result (Result =Reading + Factor)–Limit
- Factor= Antenna factor+Cable attenuation factor(cable loss)-Amplifier gain

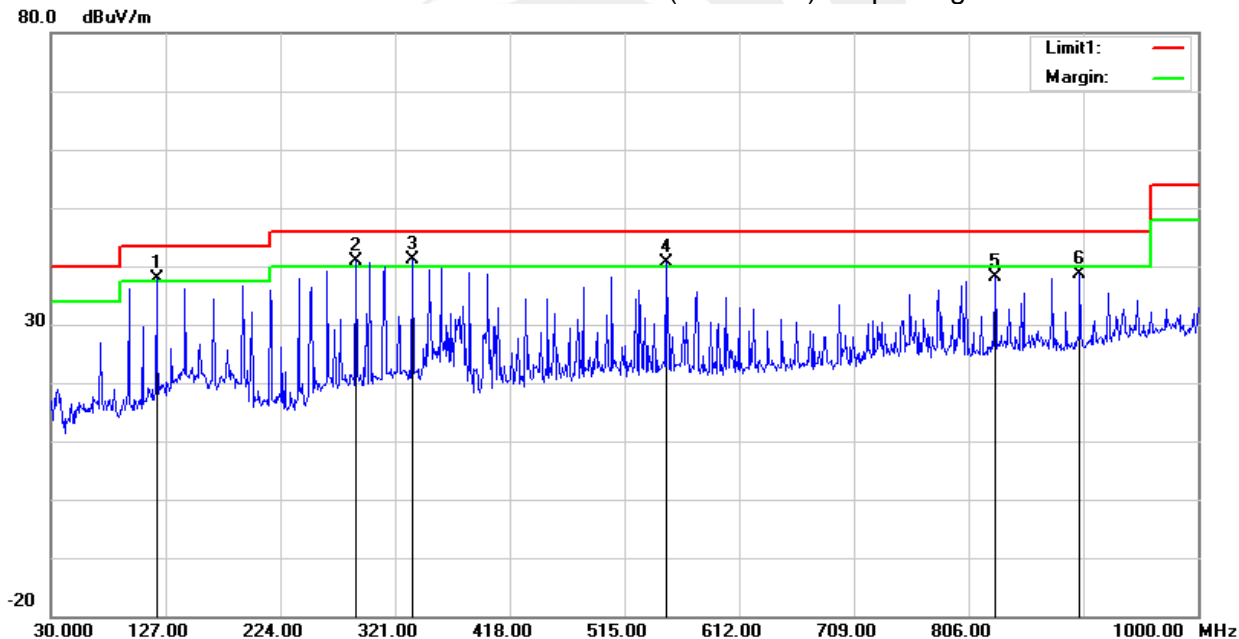



Temperature:	23.1(C)	Relative Humidity:	60%RH
Test Voltage:	DC 3.65V	Phase:	Vertical
Test Mode:	Mode 1/2/3/4/5/6/7/8/9/10/11/12 (Mode 2 worst mode)		

No.	Frequency (MHz)	Reading (dBuV)	Correct Factor(dB/m)	Result (dBuV/m)	Limit (dBuV/m)	Margin (dB)	Remark
1	119.2400	55.47	-18.38	37.09	43.50	-6.41	peak
2	239.5200	58.25	-18.10	40.15	46.00	-5.85	peak
3	335.5500	49.95	-13.54	36.41	46.00	-9.59	peak
4	399.5700	46.50	-11.16	35.34	46.00	-10.66	peak
5	504.3300	42.49	-7.98	34.51	46.00	-11.49	peak
6	773.0200	43.68	-2.30	41.38	46.00	-4.62	peak

Remark:.

- Margin = Result (Result =Reading + Factor)–Limit
- Factor= Antenna factor+Cable attenuation factor(cable loss)-Amplifier gain

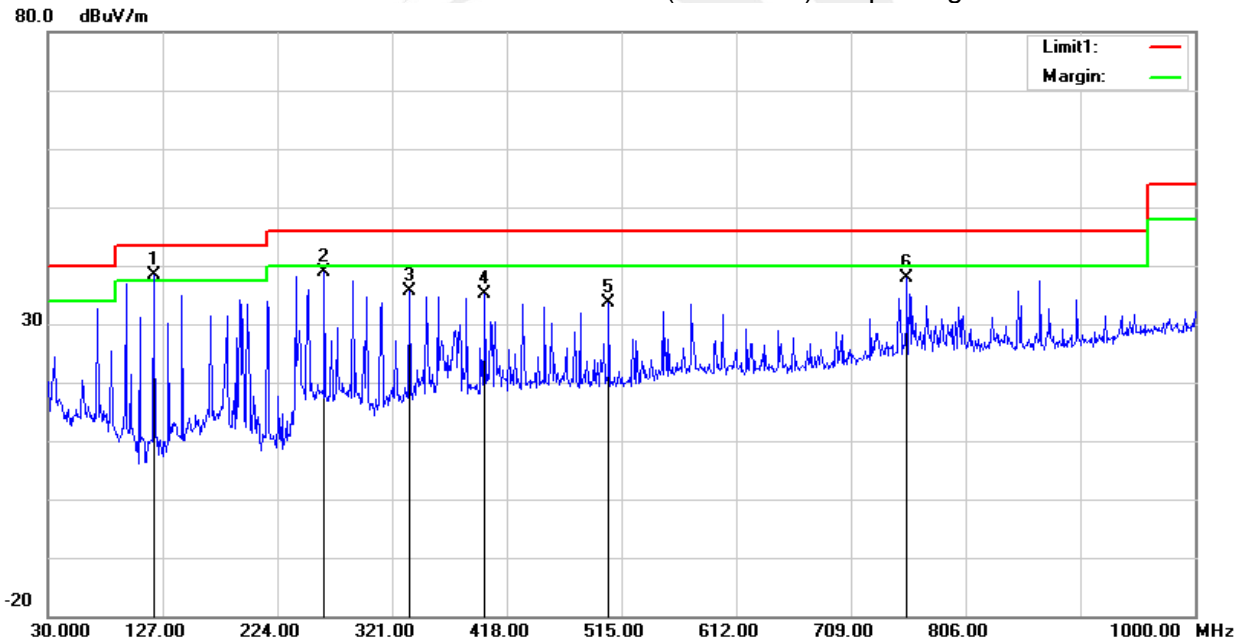



(1000MHz-25GHz) Spurious emission Requirements

802.11 b

Frequency (MHz)	Meter Reading (dBμV)	Amplifier (dB)	Loss (dB)	Antenna Factor (dB/m)	Corrected Factor (dB)	Emission Level (dBμV/m)	Limits (dBμV/m)	Margin (dB)	Detector Type	Comment
Low Channel (802.11b/2412 MHz)										
3264.81	61.66	44.70	6.70	28.20	-9.80	51.86	74.00	-22.14	PK	Vertical
3264.81	51.17	44.70	6.70	28.20	-9.80	41.37	54.00	-12.63	AV	Vertical
3264.57	62.04	44.70	6.70	28.20	-9.80	52.24	74.00	-21.76	PK	Horizontal
3264.57	51.05	44.70	6.70	28.20	-9.80	41.25	54.00	-12.75	AV	Horizontal
4824.56	59.30	44.20	9.04	31.60	-3.56	55.74	74.00	-18.26	PK	Vertical
4824.56	49.65	44.20	9.04	31.60	-3.56	46.09	54.00	-7.91	AV	Vertical
4824.58	59.48	44.20	9.04	31.60	-3.56	55.92	74.00	-18.08	PK	Horizontal
4824.58	50.31	44.20	9.04	31.60	-3.56	46.75	54.00	-7.25	AV	Horizontal
5359.72	49.14	44.20	9.86	32.00	-2.34	46.79	74.00	-27.21	PK	Vertical
5359.72	39.58	44.20	9.86	32.00	-2.34	37.23	54.00	-16.77	AV	Vertical
5359.73	48.14	44.20	9.86	32.00	-2.34	45.80	74.00	-28.20	PK	Horizontal
5359.73	38.25	44.20	9.86	32.00	-2.34	35.90	54.00	-18.10	AV	Horizontal
7235.77	54.24	43.50	11.40	35.50	3.40	57.64	74.00	-16.36	PK	Vertical
7235.77	44.24	43.50	11.40	35.50	3.40	47.64	54.00	-6.36	AV	Vertical
7235.79	54.05	43.50	11.40	35.50	3.40	57.45	74.00	-16.55	PK	Horizontal
7235.79	44.17	43.50	11.40	35.50	3.40	47.57	54.00	-6.43	AV	Horizontal
Middle Channel (802.11b/2437 MHz)										
3264.73	61.71	44.70	6.70	28.20	-9.80	51.91	74.00	-22.09	PK	Vertical
3264.73	50.13	44.70	6.70	28.20	-9.80	40.33	54.00	-13.67	AV	Vertical
3264.71	61.27	44.70	6.70	28.20	-9.80	51.47	74.00	-22.53	PK	Horizontal
3264.71	50.14	44.70	6.70	28.20	-9.80	40.34	54.00	-13.66	AV	Horizontal
4874.49	58.96	44.20	9.04	31.60	-3.56	55.40	74.00	-18.60	PK	Vertical
4874.49	50.17	44.20	9.04	31.60	-3.56	46.61	54.00	-7.39	AV	Vertical
4874.43	58.47	44.20	9.04	31.60	-3.56	54.91	74.00	-19.09	PK	Horizontal
4874.43	50.24	44.20	9.04	31.60	-3.56	46.68	54.00	-7.32	AV	Horizontal
5359.89	48.89	44.20	9.86	32.00	-2.34	46.55	74.00	-27.45	PK	Vertical
5359.89	39.88	44.20	9.86	32.00	-2.34	37.54	54.00	-16.46	AV	Vertical
5359.83	48.01	44.20	9.86	32.00	-2.34	45.67	74.00	-28.33	PK	Horizontal
5359.83	38.72	44.20	9.86	32.00	-2.34	36.38	54.00	-17.62	AV	Horizontal
7310.97	54.62	43.50	11.40	35.50	3.40	58.02	74.00	-15.98	PK	Vertical
7310.97	44.70	43.50	11.40	35.50	3.40	48.10	54.00	-5.90	AV	Vertical
7310.83	54.69	43.50	11.40	35.50	3.40	58.09	74.00	-15.91	PK	Horizontal
7310.83	44.08	43.50	11.40	35.50	3.40	47.48	54.00	-6.52	AV	Horizontal



High Channel (802.11b/2462 MHz)										
3264.62	62.05	44.70	6.70	28.20	-9.80	52.25	74.00	-21.75	PK	Vertical
3264.62	50.15	44.70	6.70	28.20	-9.80	40.35	54.00	-13.65	AV	Vertical
3264.76	61.88	44.70	6.70	28.20	-9.80	52.08	74.00	-21.92	PK	Horizontal
3264.76	50.11	44.70	6.70	28.20	-9.80	40.31	54.00	-13.69	AV	Horizontal
4924.48	59.17	44.20	9.04	31.60	-3.56	55.61	74.00	-18.39	PK	Vertical
4924.48	49.69	44.20	9.04	31.60	-3.56	46.13	54.00	-7.87	AV	Vertical
4924.43	59.18	44.20	9.04	31.60	-3.56	55.62	74.00	-18.38	PK	Horizontal
4924.43	50.35	44.20	9.04	31.60	-3.56	46.79	54.00	-7.21	AV	Horizontal
5359.86	49.00	44.20	9.86	32.00	-2.34	46.65	74.00	-27.35	PK	Vertical
5359.86	39.27	44.20	9.86	32.00	-2.34	36.92	54.00	-17.08	AV	Vertical
5359.58	48.27	44.20	9.86	32.00	-2.34	45.93	74.00	-28.07	PK	Horizontal
5359.58	39.48	44.20	9.86	32.00	-2.34	37.14	54.00	-16.86	AV	Horizontal
7385.79	54.50	43.50	11.40	35.50	3.40	57.90	74.00	-16.10	PK	Vertical
7385.79	44.08	43.50	11.40	35.50	3.40	47.48	54.00	-6.52	AV	Vertical
7385.84	53.60	43.50	11.40	35.50	3.40	57.00	74.00	-17.00	PK	Horizontal
7385.84	43.98	43.50	11.40	35.50	3.40	47.38	54.00	-6.62	AV	Horizontal

Remark:

- Factor = Antenna Factor + Cable Loss – Pre-amplifier.
- Scan with 802.11b, 802.11g, 802.11n (HT-20), 802.11n (HT-40) the worst case is 802.11 b.
Emission Level = Reading + Factor
Margin = Emission Level-Limit
- The frequency emission of peak points that did not show above the forms are at least 20dB below the limit, the frequency emission is mainly from the environment noise.

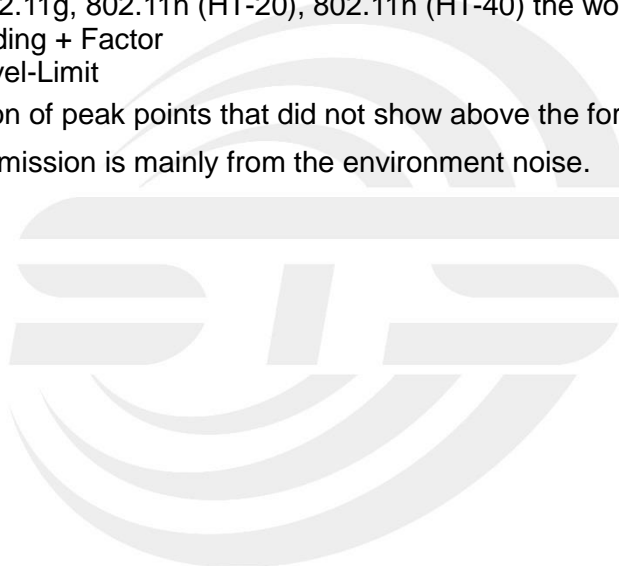



3.2.6 TEST RESULTS(Band edge Requirements)

802.11 b-Low

Horizontal

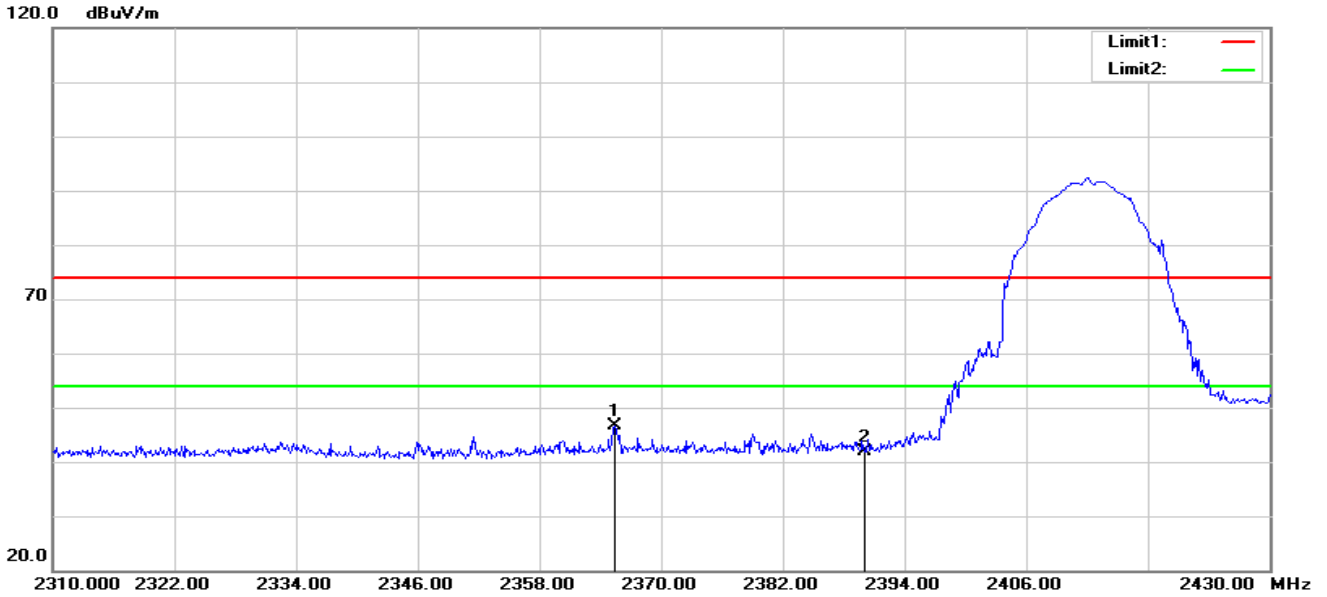

No.	Frequency (MHz)	Reading (dBuV)	Correct Factor(dB/m)	Result (dBuV/m)	Limit (dBuV/m)	Margin (dB)	Remark
1	2365.440	42.61	3.97	46.58	74.00	-27.42	peak
2	2390.000	37.45	4.34	41.79	74.00	-32.21	peak

Vertical

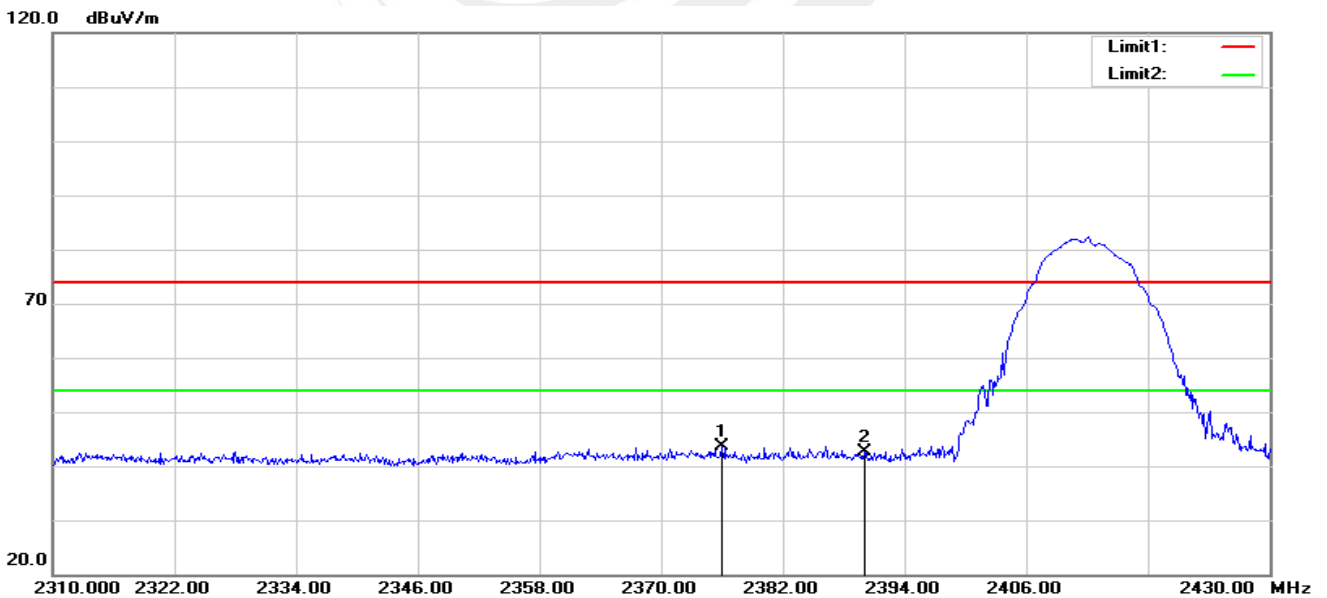

No.	Frequency (MHz)	Reading (dBuV)	Correct Factor(dB/m)	Result (dBuV/m)	Limit (dBuV/m)	Margin (dB)	Remark
1	2376.000	39.40	4.13	43.53	74.00	-30.47	peak
2	2390.000	38.19	4.34	42.53	74.00	-31.47	peak



802.11 b-High
Horizontal

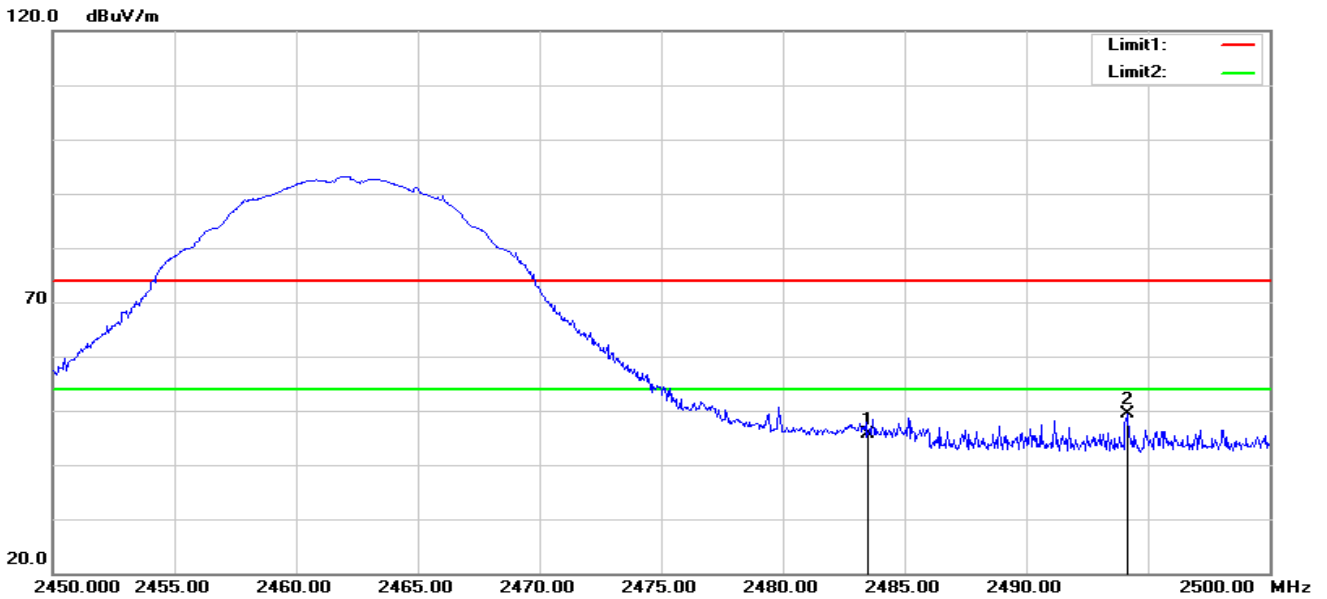

No.	Frequency (MHz)	Reading (dBuV)	Correct Factor(dB/m)	Result (dBuV/m)	Limit (dBuV/m)	Margin (dB)	Remark
1	2483.500	40.93	4.60	45.53	74.00	-28.47	peak
2	2494.150	44.70	4.63	49.33	74.00	-24.67	peak

Vertical

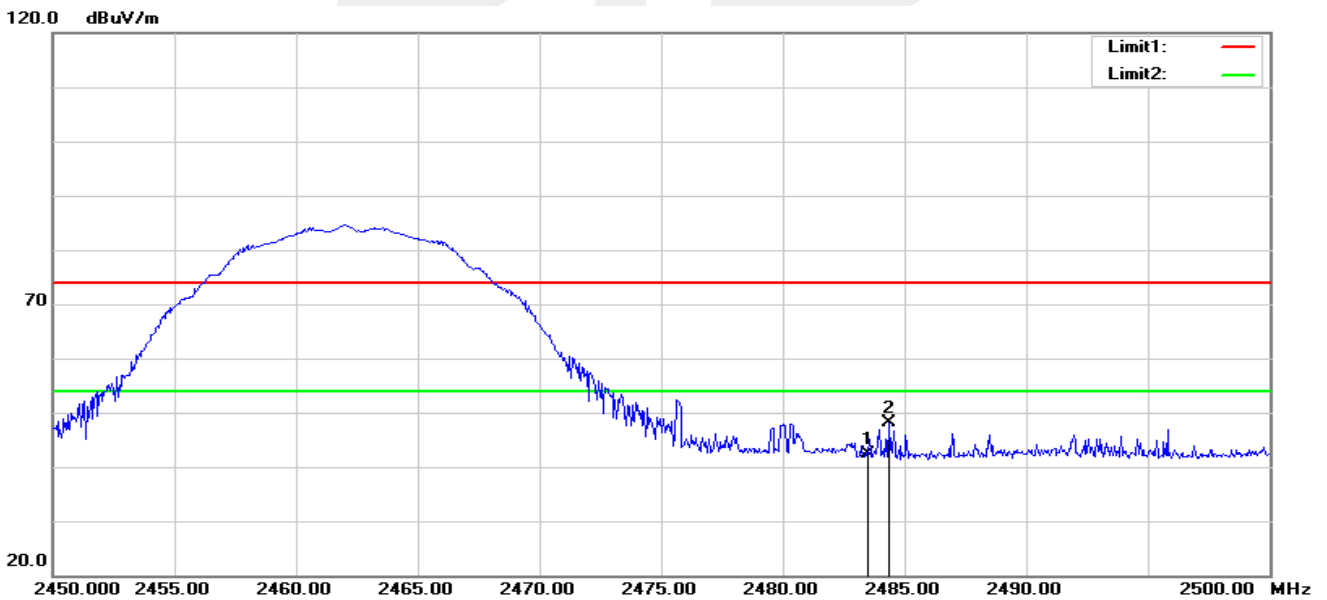

No.	Frequency (MHz)	Reading (dBuV)	Correct Factor(dB/m)	Result (dBuV/m)	Limit (dBuV/m)	Margin (dB)	Remark
1	2483.500	37.86	4.60	42.46	74.00	-31.54	peak
2	2484.350	43.46	4.61	48.07	74.00	-25.93	peak

Note: 802.11b, 802.11g, 802.11n (HT-20), 802.11n (HT-40) mode all have been tested, the worst case is 802.11 b, only show the worst case.

4. CONDUCTED SPURIOUS & BAND EDGE EMISSION

4.1 LIMIT

According to FCC section 15.247(d)&RSS-247 Issue 2, in any 100kHz bandwidth outside the frequency band in which the spread spectrum or digitally modulated intentional radiator is operating, the radio frequency power that is produced by the intentional radiator shall be at least 20dB below that in the 100kHz bandwidth within the band that contains the highest level of the desired power, based on either an RF conducted or a radiated measurement.

4.2 TEST PROCEDURE

Spectrum Parameter	Setting
Detector	Peak
Start/Stop Frequency	30 MHz to 10th carrier harmonic
RB / VB (emission in restricted band)	100 KHz/300 KHz
Trace-Mode:	Max hold

For Band edge

Spectrum Parameter	Setting
Detector	Peak
Start/Stop Frequency	Lower Band Edge: 2300 to 2432 MHz Upper Band Edge: 2442 to 2500 MHz
RB / VB (emission in restricted band)	100 KHz/300 KHz
Trace-Mode:	Max hold

4.3 DEVIATION FROM STANDARD

No deviation.

4.4 TEST SETUP



The EUT is connected to the Spectrum Analyzer; the RF load attached to the EUT antenna terminal is 50Ohm; the path loss as the factor is calibrated to correct the reading.

Make the measurement with the spectrum analyzer's resolution bandwidth (RBW) = 100 kHz. In order to make an accurate measurement, set the span greater than RBW.

4.5 EUT OPERATION CONDITIONS

Please refer to section 3.1.4 of this report.

4.6 TEST RESULTS

Note: The test data please refer to APPENDIX 1.

5. POWER SPECTRAL DENSITY TEST

5.1 LIMIT

FCC PART15.247 , SUBPART C
RSS-247 ISSUE 2

Section	Test Item	Limit	Frequency Range (MHz)	Result
15.247(e) RSS-247 Issue 2	Power Spectral Density	≤8 dBm (RBW ≥3KHz)	2400-2483.5	PASS

5.2 TEST PROCEDURE

1. Set analyzer center frequency to DTS channel center frequency.
2. Set the span to 1.5 times the DTS channel bandwidth.
3. Set the 100 kHz ≥ RBW ≥3 kHz.
4. Set the VBW ≥ 3 x RBW.
5. Detector = peak.
6. Sweep time = auto couple.
7. Trace mode = max hold.
8. Allow trace to fully stabilize.
9. Use the peak marker function to determine the maximum amplitude level.
10. If measured value exceeds limit, reduce RBW (no less than 3 kHz) and repeat.

5.3 DEVIATION FROM STANDARD

No deviation.

5.4 TEST SETUP



5.5 EUT OPERATION CONDITIONS

Please refer to section 3.1.4 of this report.

5.6 TEST RESULTS

Note: The test data please refer to APPENDIX 1.

6. BANDWIDTH TEST

6.1 LIMIT

FCC Part15.247,Subpart C RSS-Gen Clause 6.7				
Section	Test Item	Limit	Frequency Range (MHz)	Result
15.247(a)(2) RSS-247 5.2 (a)	Bandwidth	$\geq 500\text{KHz}$ (6dB bandwidth)	2400-2483.5	PASS
RSS-Gen Clause 6.7	99% Bandwidth	For reporting purposes only.	2400-2483.5	PASS

6.2 TEST PROCEDURE

The automatic bandwidth measurement capability of an instrument may be employed using the X dB bandwidth mode with X set to 6 dB, if the functionality described above (i.e., RBW = 100 kHz, VBW \geq 3RBW, peak detector with maximum hold) is implemented by the instrumentation function. When using this capability, care shall be taken so that the bandwidth measurement is not influenced by any intermediate power nulls in the fundamental emission that might be ≥ 6 dB.

6.3 DEVIATION FROM STANDARD

No deviation.

6.4 TEST SETUP



6.5 EUT OPERATION CONDITIONS

Please refer to section 3.1.4 of this report.

6.6 TEST RESULTS

Note: The test data please refer to APPENDIX 1.



7. PEAK OUTPUT POWER TEST

7.1 LIMIT

FCC Part15.247, Subpart C RSS-247 Issue 2				
Section	Test Item	Limit	Frequency Range (MHz)	Result
15.247(b)(3) RSS 247 Issue 2	Output Power	1 watt or 30dBm	2400-2483.5	PASS
RSS-247	EIRP	4W	2400-2483.5	PASS

7.2 TEST PROCEDURE

One of the following procedures may be used to determine the maximum peak conducted output power of a DTS EUT.

RBW \geq DTS bandwidth

The following procedure shall be used when an instrument with a resolution bandwidth that is greater than the DTS bandwidth is available to perform the measurement:

- Set the RBW \geq DTS bandwidth.
- Set VBW \geq [3 \times RBW].
- Set span \geq [3 \times RBW].
- Sweep time = auto couple.
- Detector = peak.
- Trace mode = max hold.
- Allow trace to fully stabilize.
- Use peak marker function to determine the peak amplitude level.

Integrated band power method:

The following procedure can be used when the maximum available RBW of the instrument is less than the

DTS bandwidth:

- Set the RBW = 1 MHz.
- Set the VBW \geq [3 \times RBW].
- Set the span \geq [1.5 \times DTS bandwidth].
- Detector = peak.
- Sweep time = auto couple.
- Trace mode = max hold.
- Allow trace to fully stabilize.
- Use the instrument's band/channel power measurement function with the band limits set equal to the DTS bandwidth edges (for some instruments, this may require a manual override to select the peak detector). If the instrument does not have a band power function, then sum the spectrum levels (in linear power units) at intervals equal to the RBW extending across the DTS channel bandwidth.

PKPM1 Peak power meter method:

The maximum peak conducted output power may be measured using a broadband peak RF power meter. The power meter shall have a video bandwidth that is greater than or equal to the DTS bandwidth and shall use a fast-responding diode detector.

7.3 DEVIATION FROM STANDARD

No deviation.

7.4 TEST SETUP

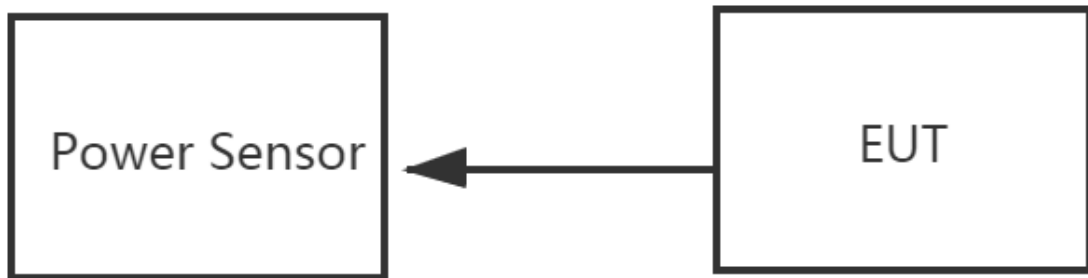

7.5 EUT OPERATION CONDITIONS

Please refer to section 3.1.4 of this report.

7.6 TEST RESULTS

Note: The test data please refer to APPENDIX 1.

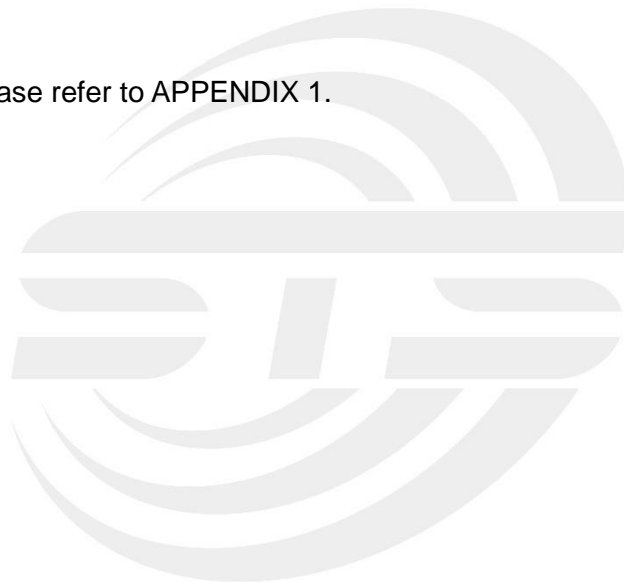



8. ANTENNA REQUIREMENT

8.1 STANDARD REQUIREMENT

15.203 requirement: For intentional device, according to 15.203: an intentional radiator shall be designed to ensure that no antenna other than that furnished by the responsible party shall be used with the device.

8.2 EUT ANTENNA

The EUT antenna is PIFA Antenna. It comply with the standard requirement.





9. FREQUENCY STABILITY

9.1 LIMITS OF FREQUENCY STABILITY MEASUREMENT

The frequency tolerance of the carrier signal shall be maintained within +/-0.02% of the operating frequency over a temperature variation of -30 degrees to 50 degrees C at normal supply voltage, and for a variation in primary supply voltage from 85% to 115% of the rated supply voltage at a temperature of 20 degrees.

9.2 TEST PROCEDURE

1. The EUT was placed inside the environmental test chamber and powered by nominal DC voltage.
2. Turn the EUT on and couple its output to spectrum analyzer.
3. Turn the EUT off and set the chamber to the highest temperature specified.
4. Allow sufficient time (approximately 30 min) for the temperature of the chamber to stabilize, turn the EUT on and measure the operating frequency after 2,5, and 10 minutes.
5. Repeat step 2 and 3 with the temperature chamber set to the lowest temperature.
6. The test chamber was allowed to stabilize at +20 degree C for a minimum of 30 minutes. The supply voltage was then adjusted on the EUT from 85% to 115% and the frequency record.

9.3 TEST RESULT

Channel 06 (2437MHz)

Voltage vs. Frequency Stability

Voltage(V)	Measurement Frequency(MHz)
4.1975	2437.0028
3.65	2437.0027
3.1025	2437.0019
Max.Deviation(MHz)	0.0028
Max.Deviation(ppm)	1.15

Rated working voltage: DC 3.65V

Temperature vs. Frequency Stability

Temperature(°C)	Measurement Frequency(MHz)
-30	2437.0032
-20	2437.0026
-10	2437.0030
0	2437.0023
10	2437.0031
20	2437.0028
30	2437.0032
40	2437.0030
50	2437.0031
Max.Deviation(MHz)	0.0032
Max.Deviation(ppm)	1.31



APPENDIX 1-TEST DATA

1. Duty Cycle

Condition	Mode	Frequency (MHz)	Duty Cycle (%)	Correction Factor (dB)	1/T (kHz)
NVNT	b	2412	99.16	0.04	0.08
NVNT	b	2437	99.57	0.02	0.08
NVNT	b	2462	99.3	0.03	0.08
NVNT	g	2412	95.91	0.18	0.48
NVNT	g	2437	98.33	0.07	0.48
NVNT	g	2462	97.5	0.11	0.48
NVNT	n20	2412	95.1	0.22	0.52
NVNT	n20	2437	93.07	0.31	0.52
NVNT	n20	2462	96.49	0.16	0.52
NVNT	n40	2422	91.49	0.39	1.06
NVNT	n40	2437	92.25	0.35	1.06
NVNT	n40	2452	86.9	0.61	1.06





Test Graphs

Duty Cycle NVNT b 2412MHz

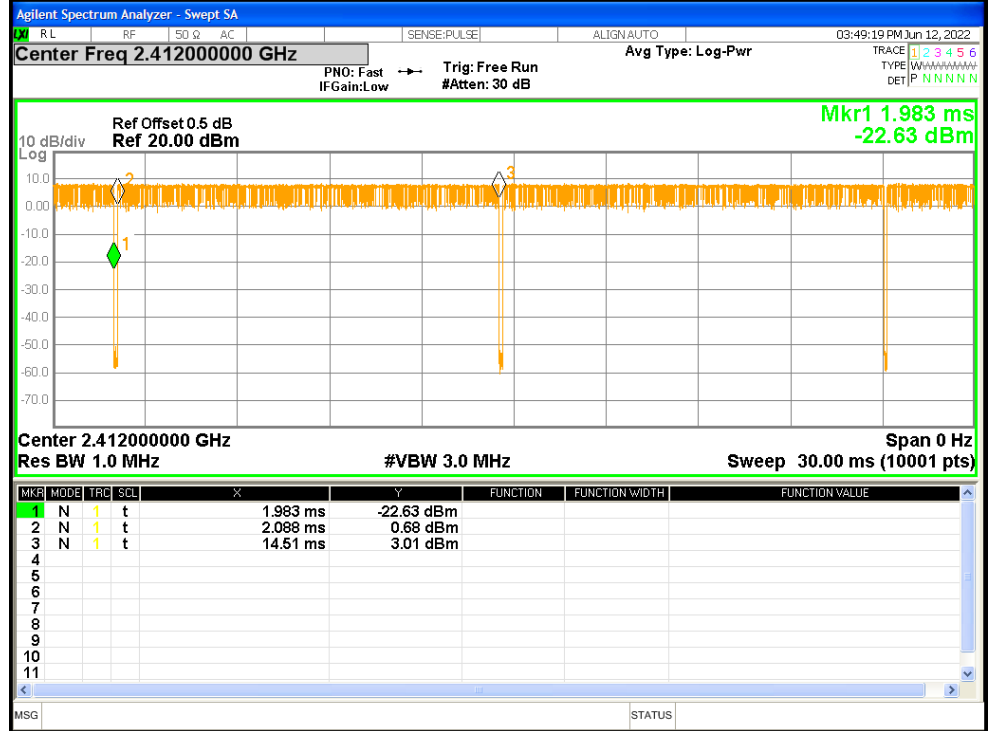

Duty Cycle NVNT b 2437MHz

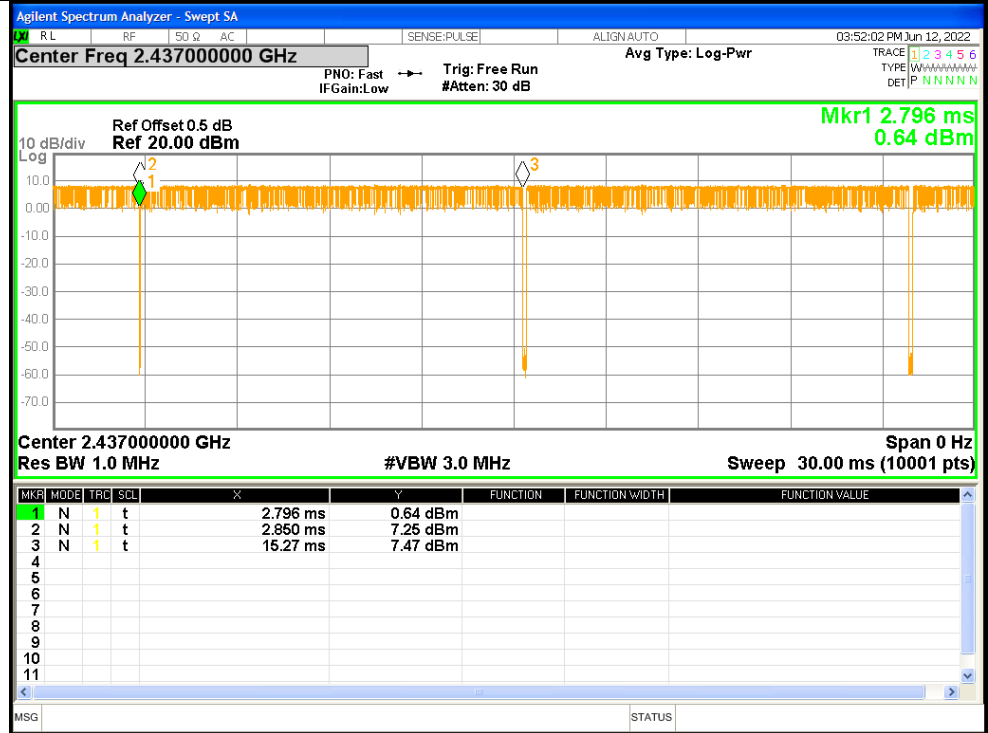

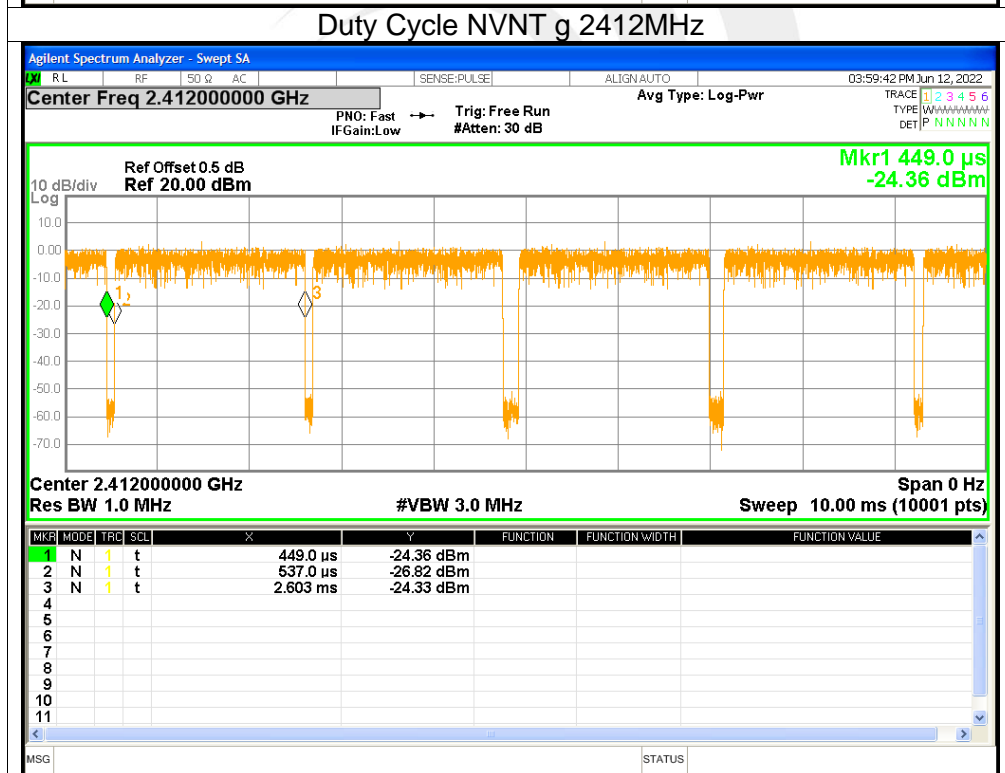
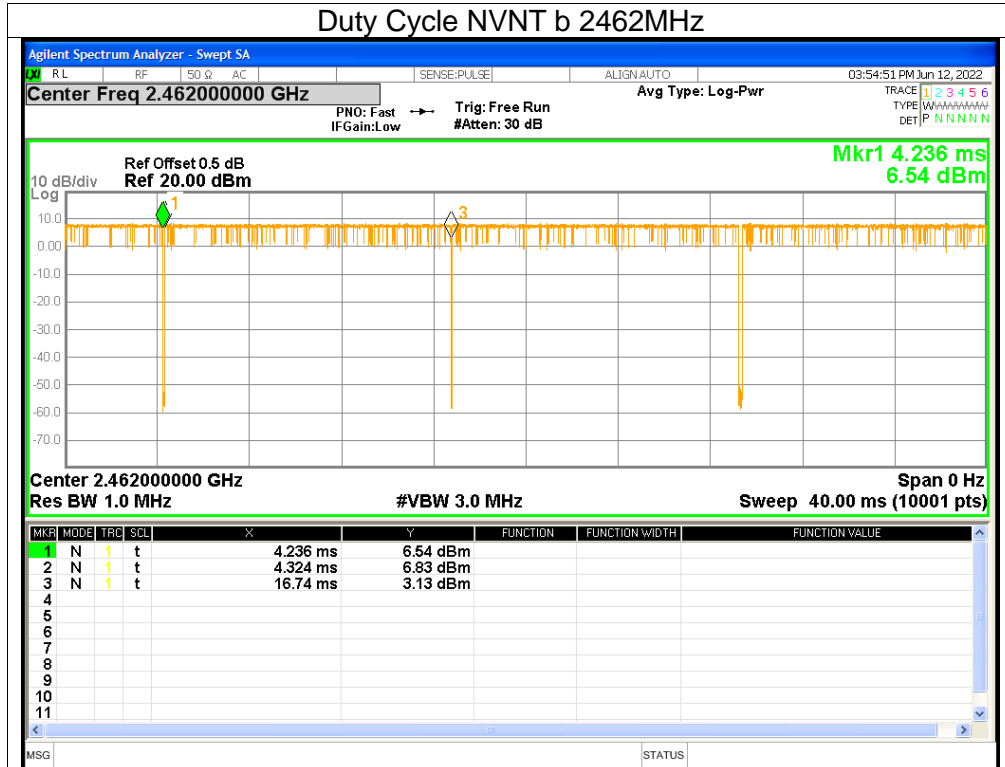



Duty Cycle NVNT g 2437MHz

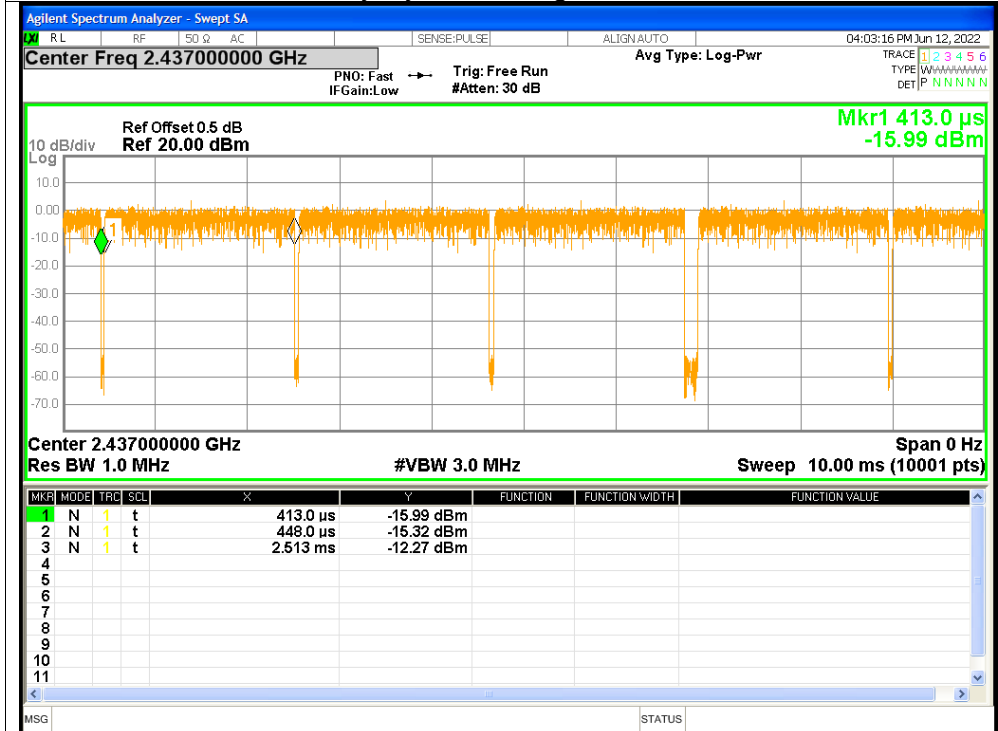

Duty Cycle NVNT g 2462MHz

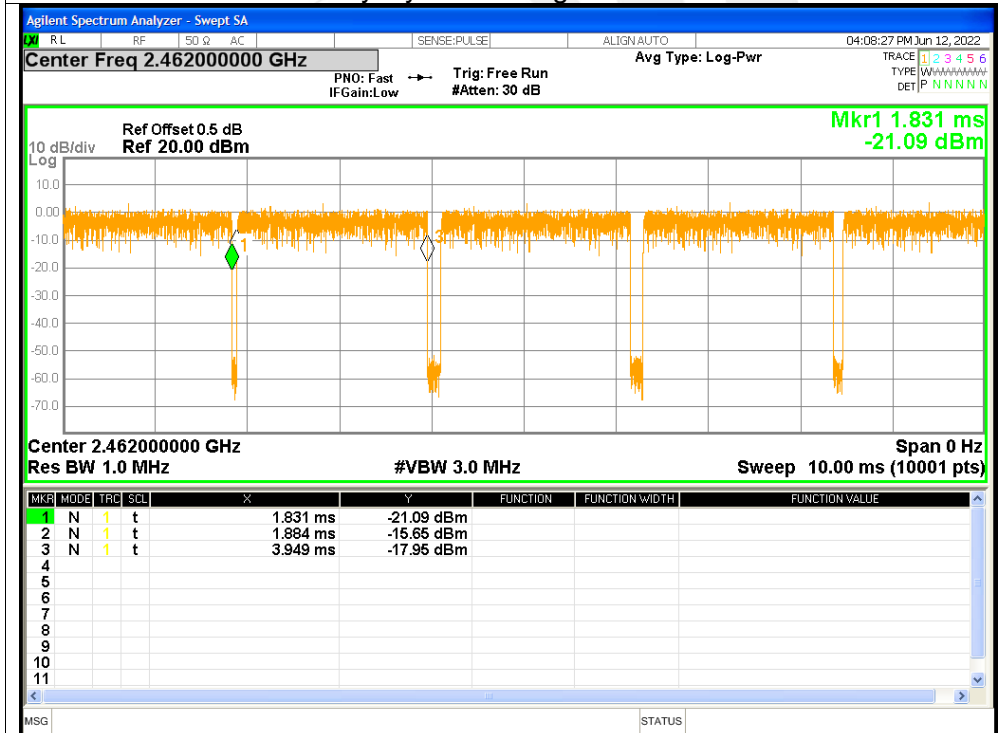



Duty Cycle NVNT n20 2412MHz

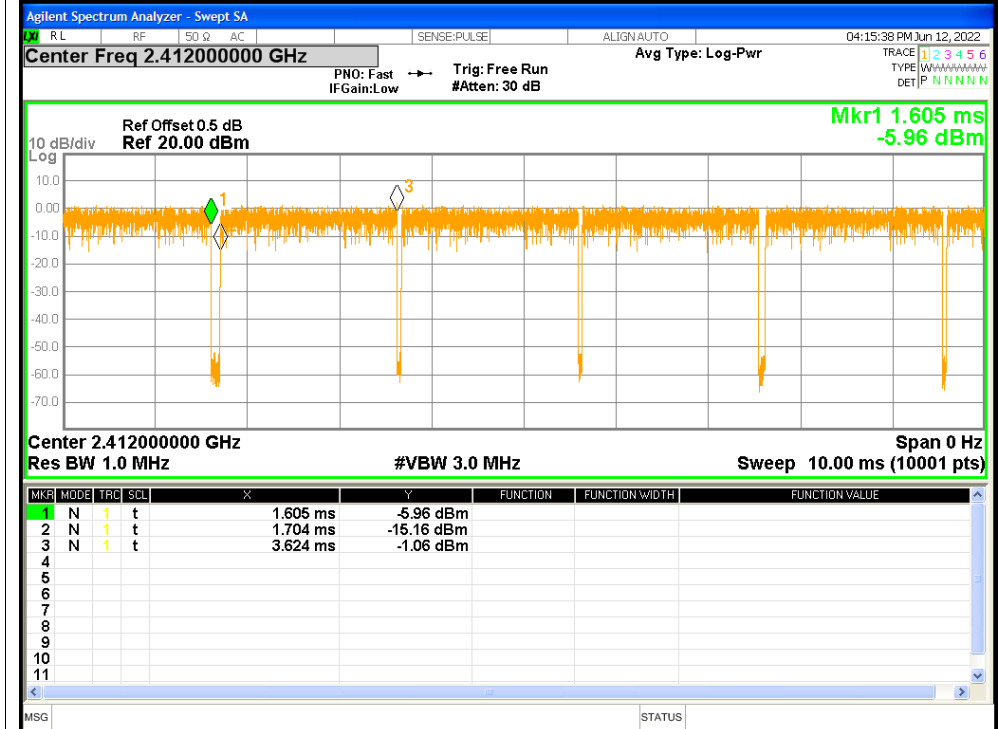

Duty Cycle NVNT n20 2437MHz

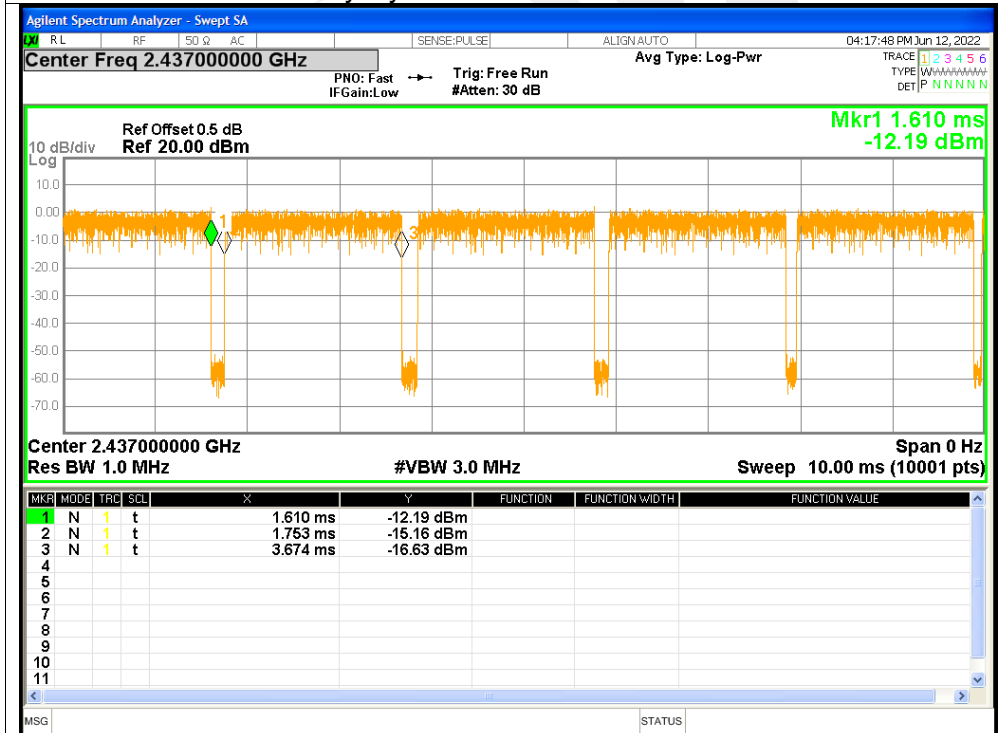



Duty Cycle NVNT n20 2462MHz

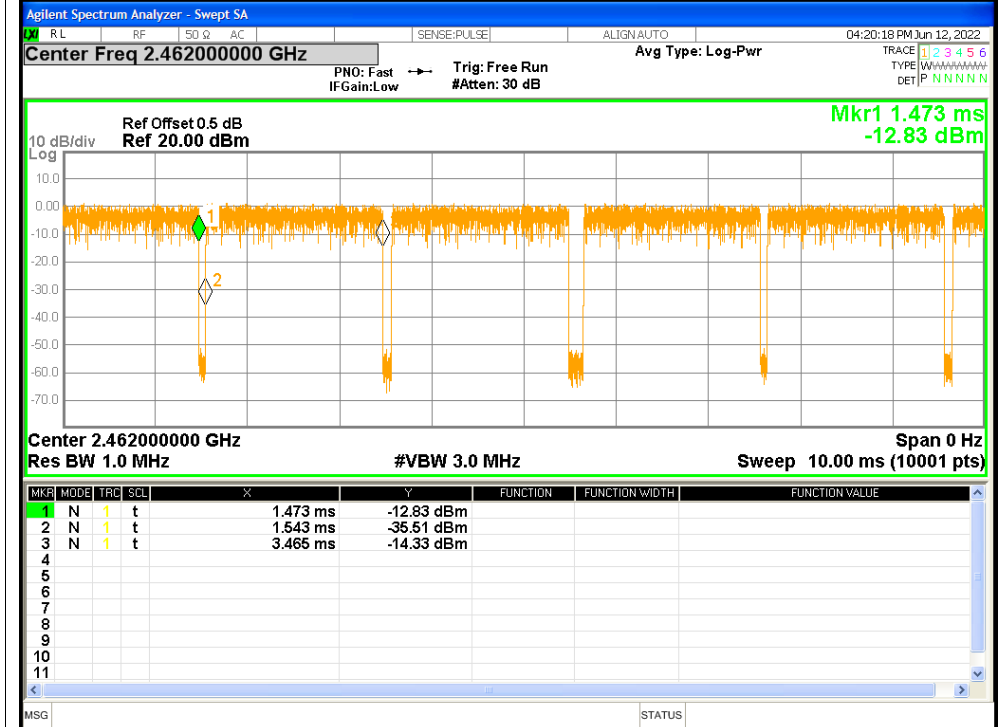

Duty Cycle NVNT n40 2422MHz

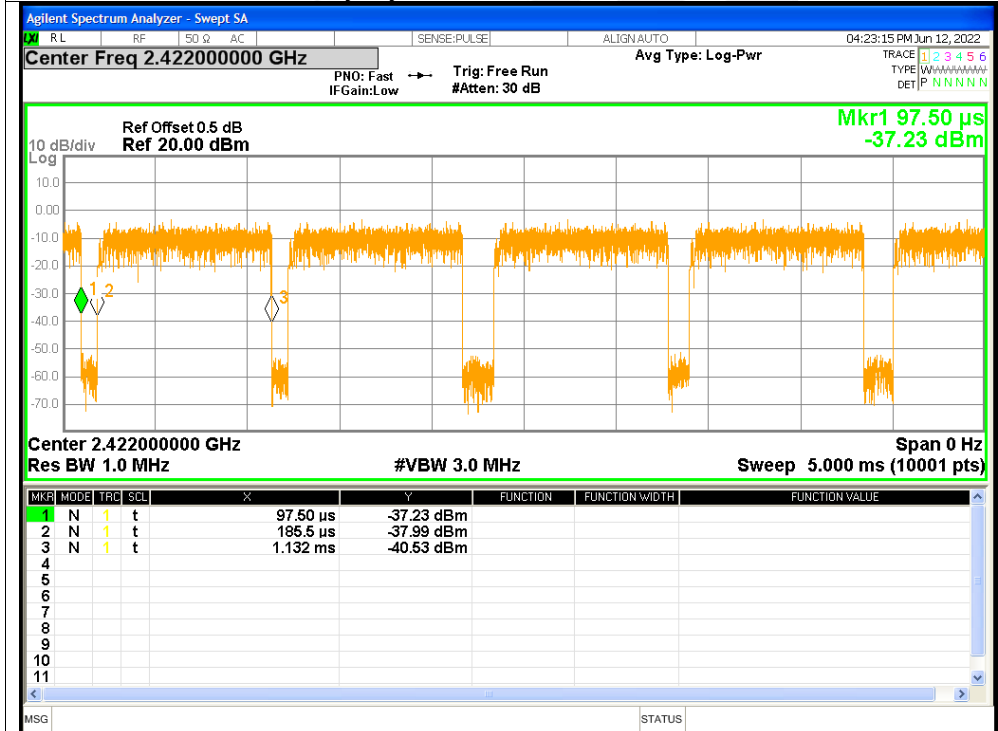



Duty Cycle NVNT n40 2437MHz

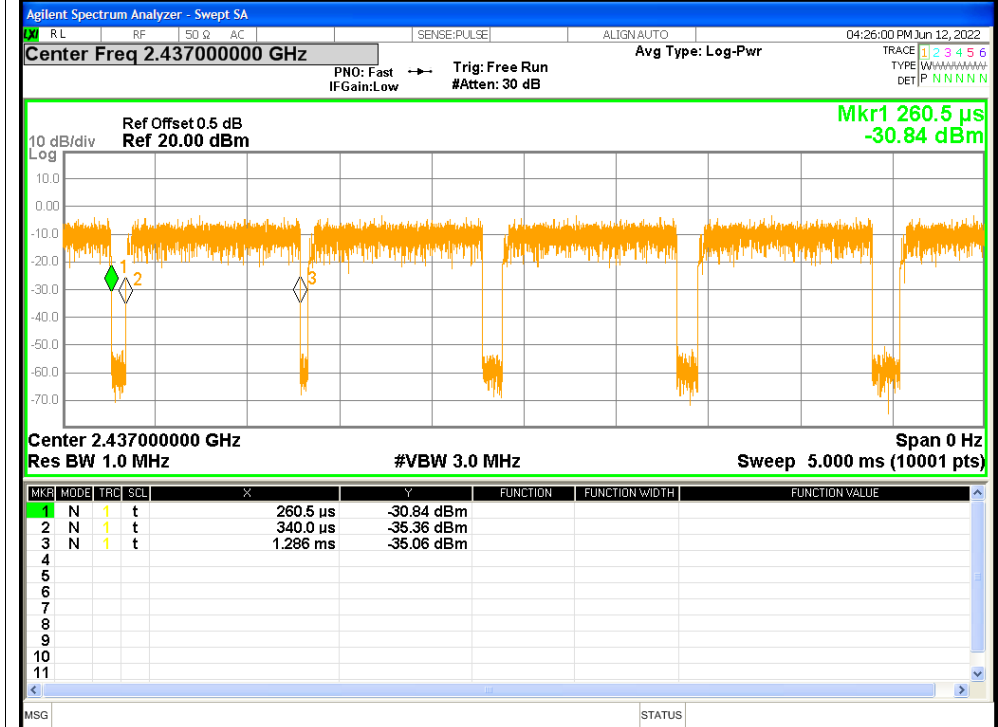

Duty Cycle NVNT n40 2452MHz

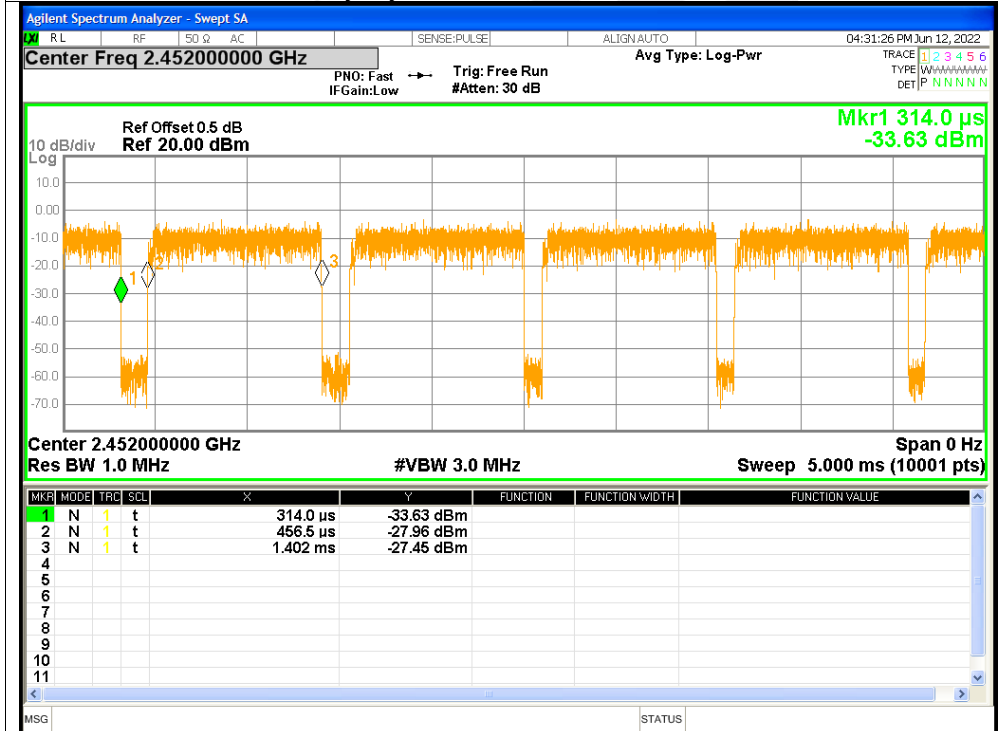



2. Maximum Average Conducted Output Power

Condition	Mode	Frequency (MHz)	Conducted Power (dBm)	Duty Factor (dB)	Total Power (dBm)	Limit (dBm)	Verdict
NVNT	b	2412	12.46	0.04	12.5	<=30	Pass
NVNT	b	2437	12.66	0.02	12.68	<=30	Pass
NVNT	b	2462	12.42	0.03	12.45	<=30	Pass
NVNT	g	2412	6.69	0.18	6.87	<=30	Pass
NVNT	g	2437	6.93	0.07	7	<=30	Pass
NVNT	g	2462	6.69	0.11	6.8	<=30	Pass
NVNT	n20	2412	6.73	0.22	6.95	<=30	Pass
NVNT	n20	2437	6.91	0.31	7.22	<=30	Pass
NVNT	n20	2462	6.73	0.16	6.89	<=30	Pass
NVNT	n40	2422	6.81	0.39	7.2	<=30	Pass
NVNT	n40	2437	6.94	0.35	7.29	<=30	Pass
NVNT	n40	2452	6.83	0.61	7.44	<=30	Pass



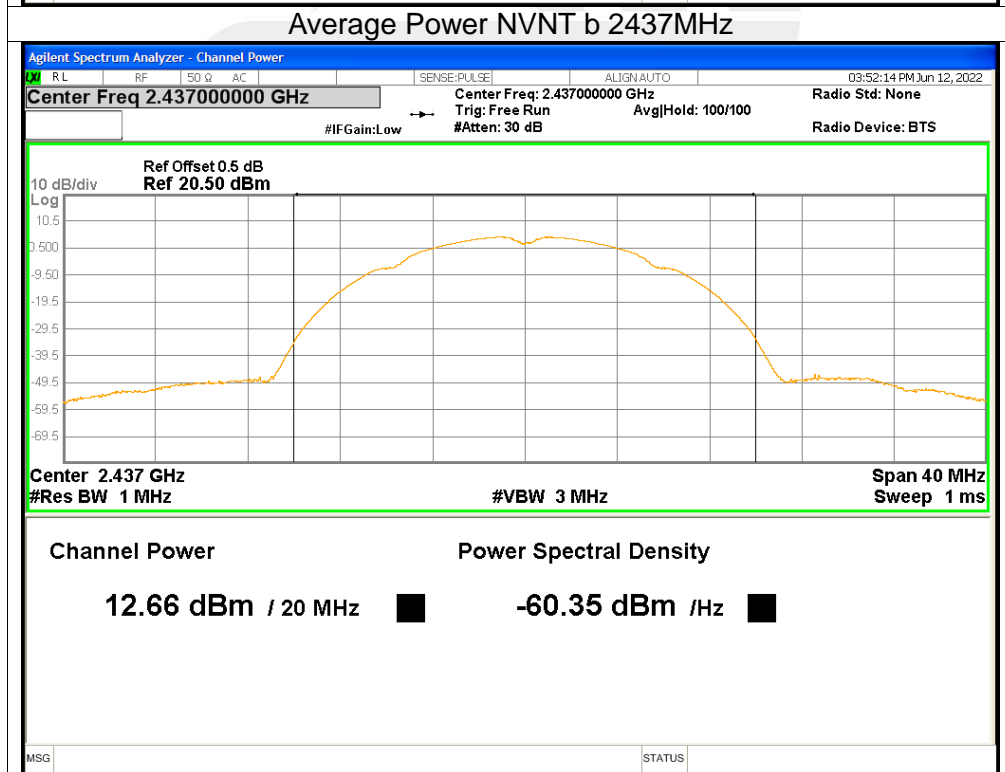
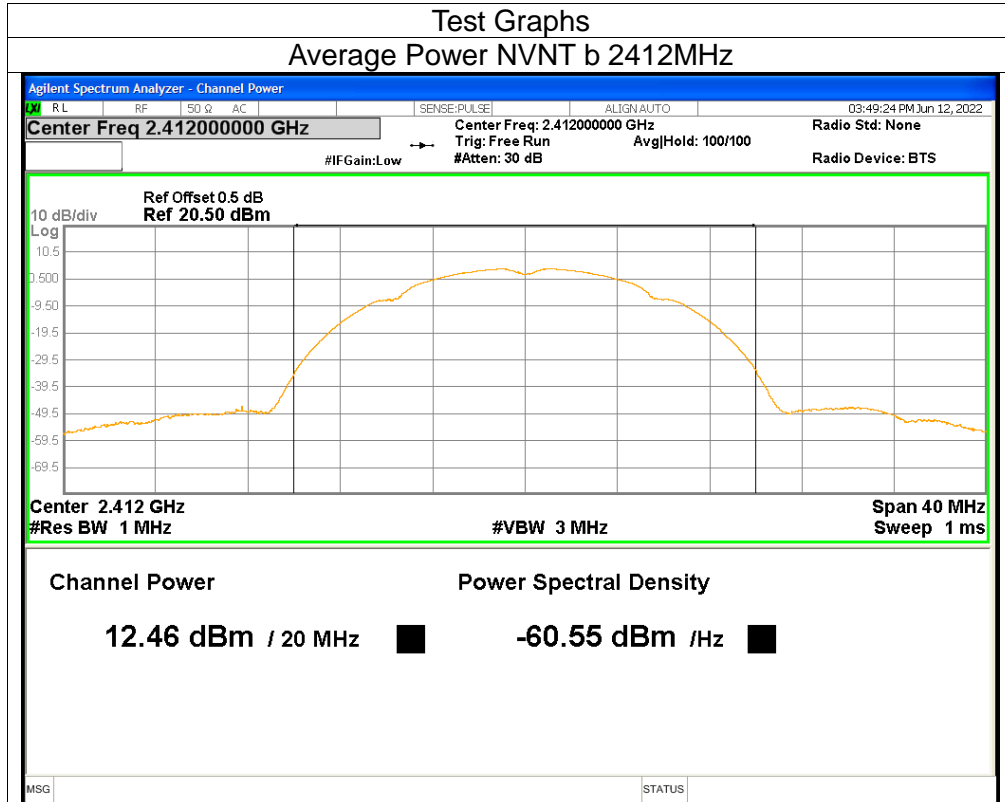

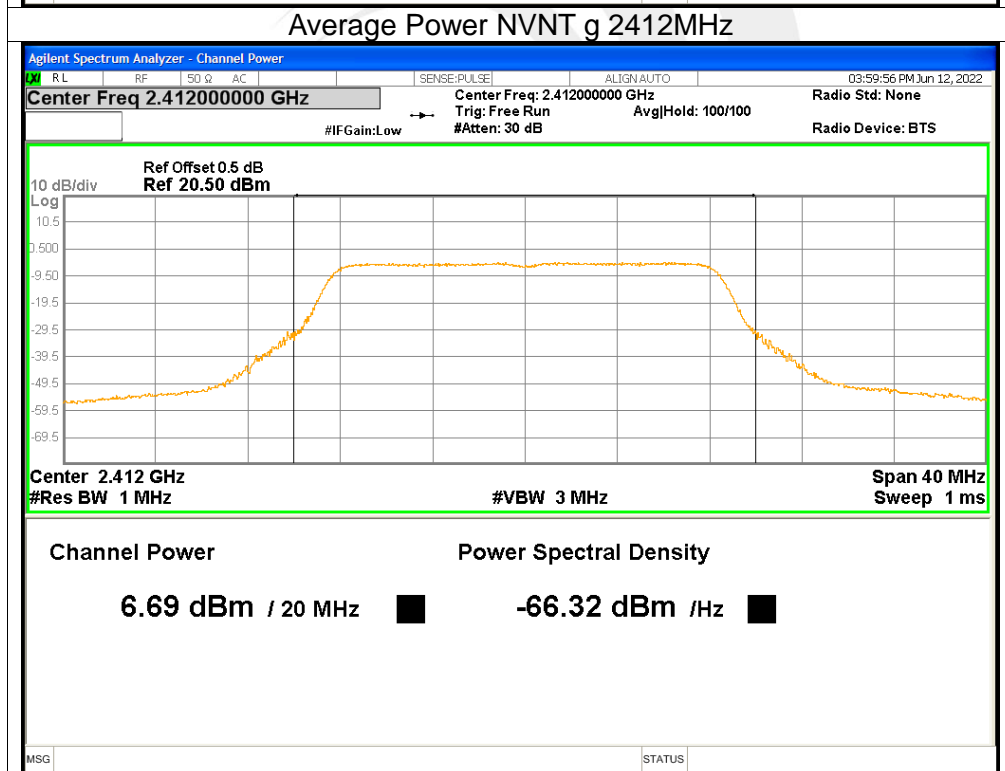
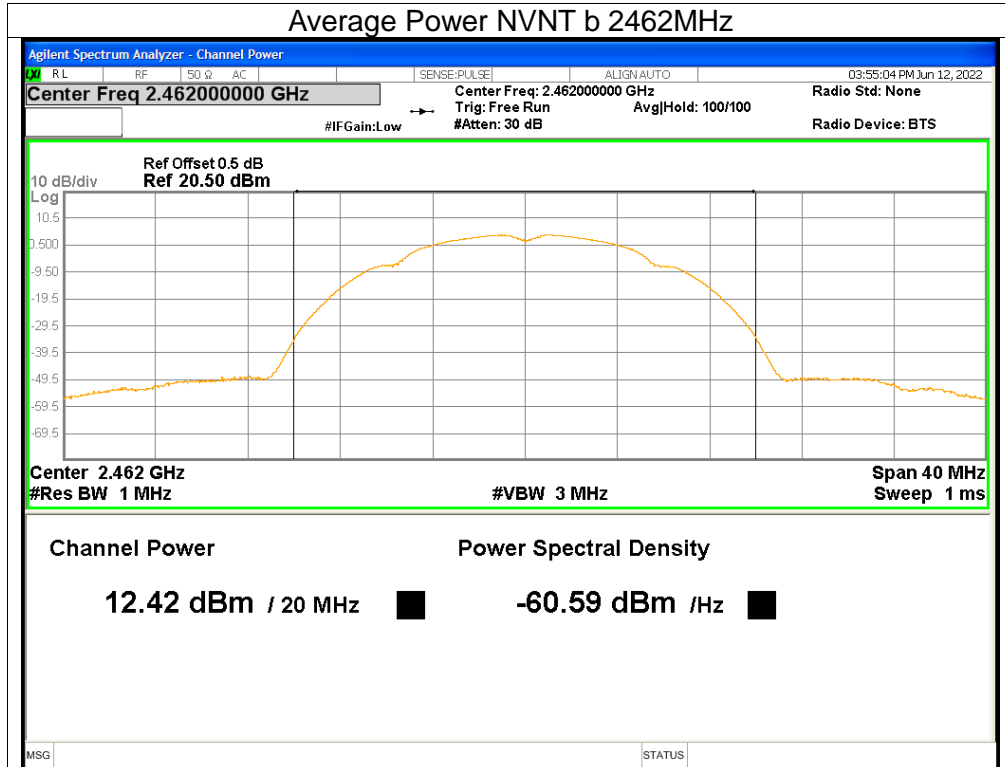

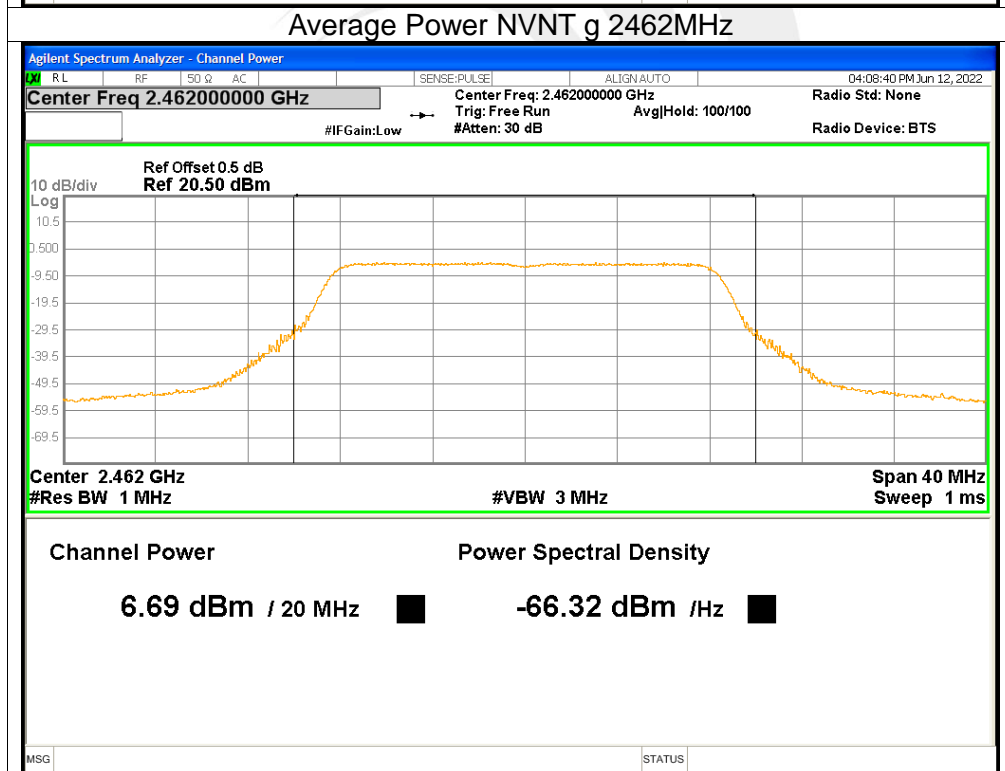
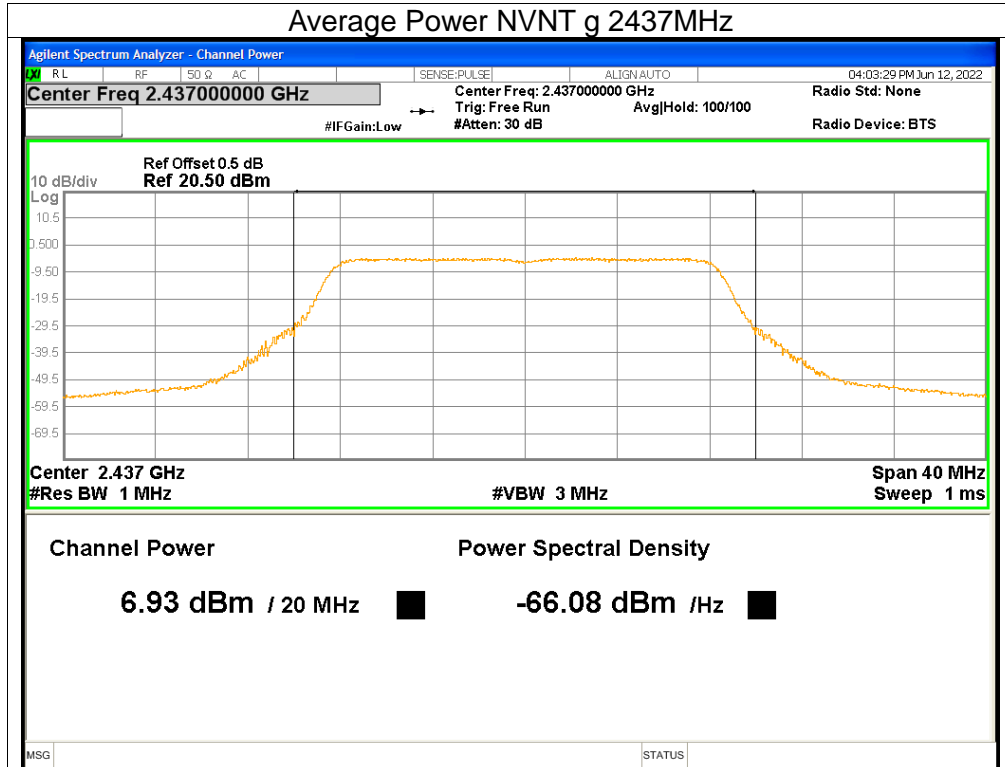

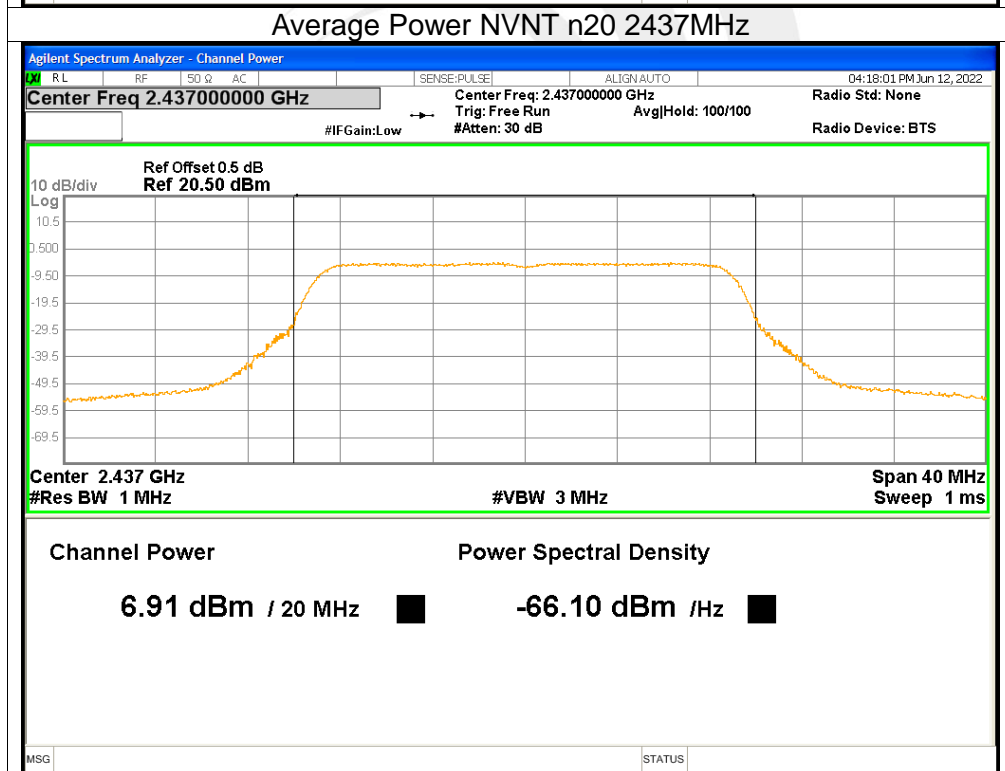
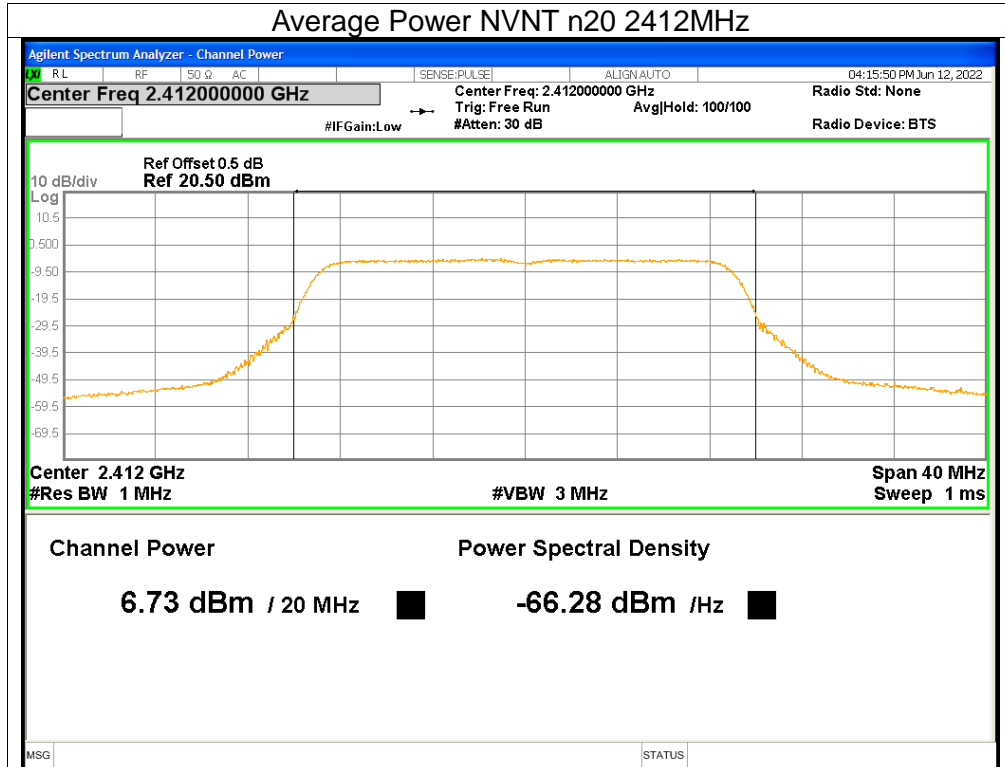

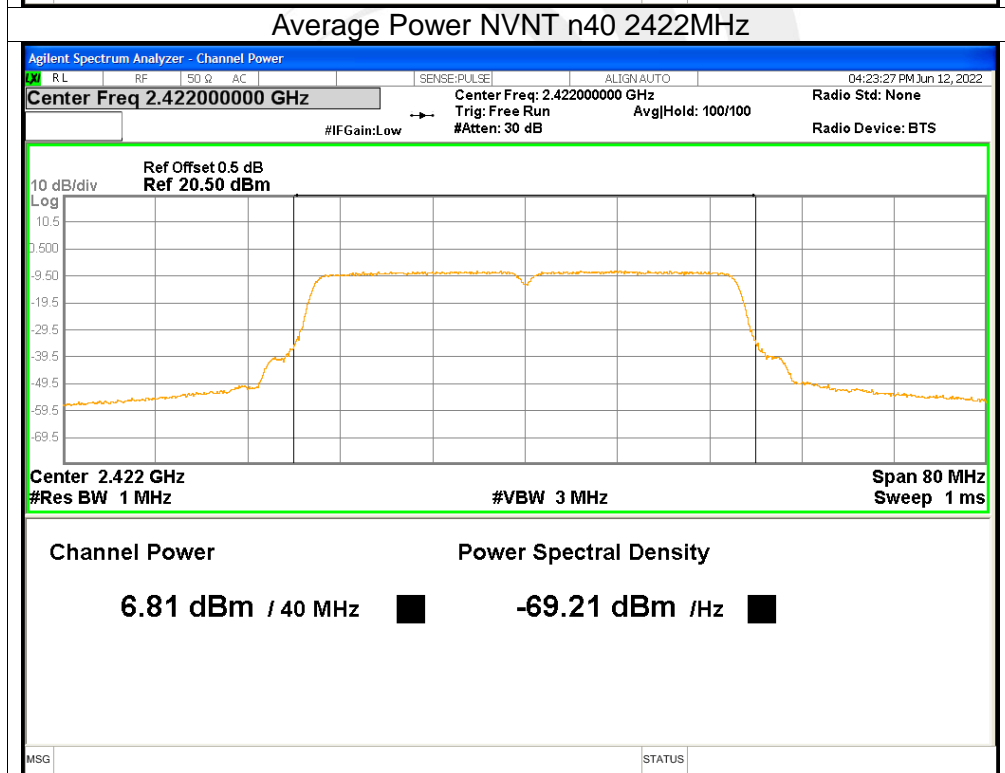
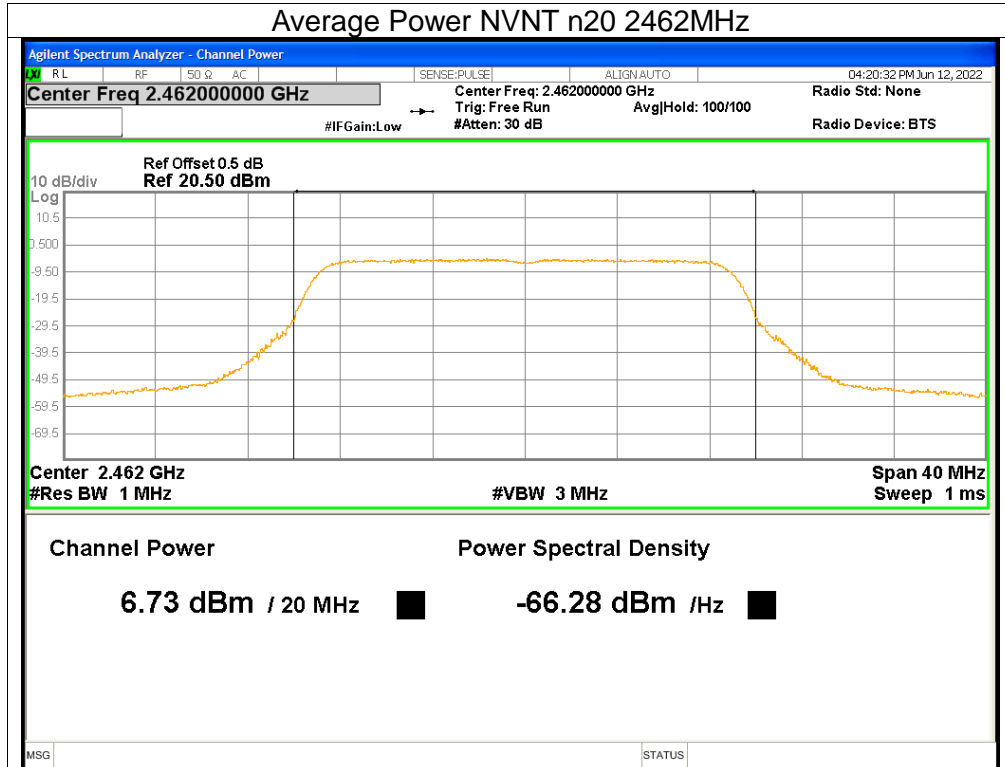

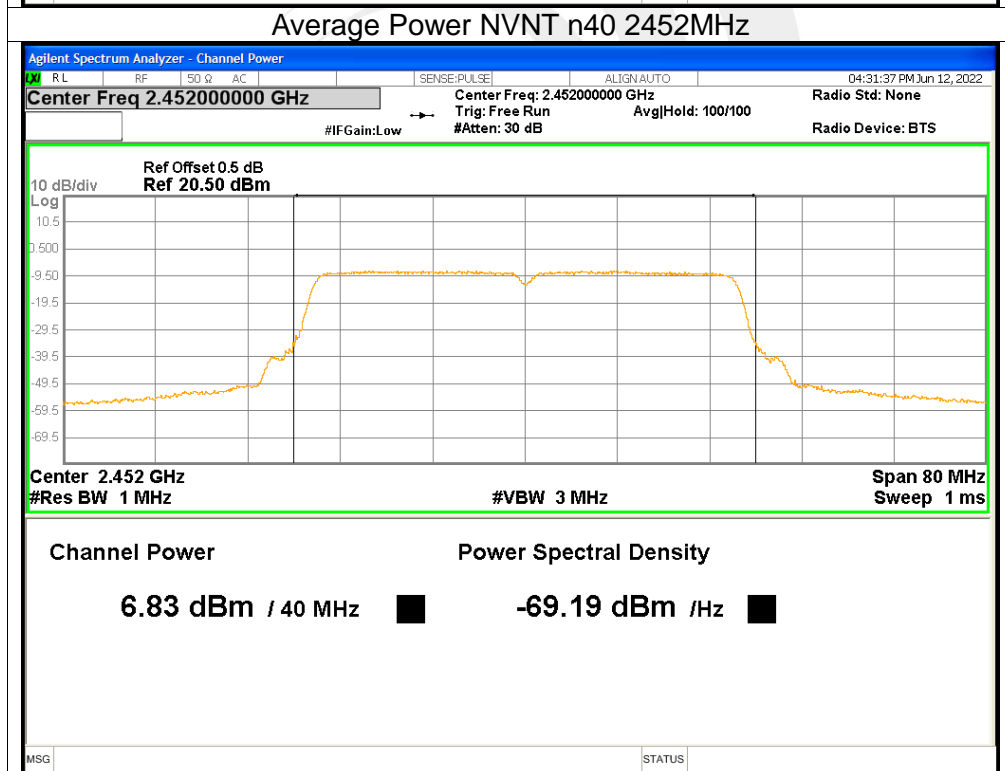
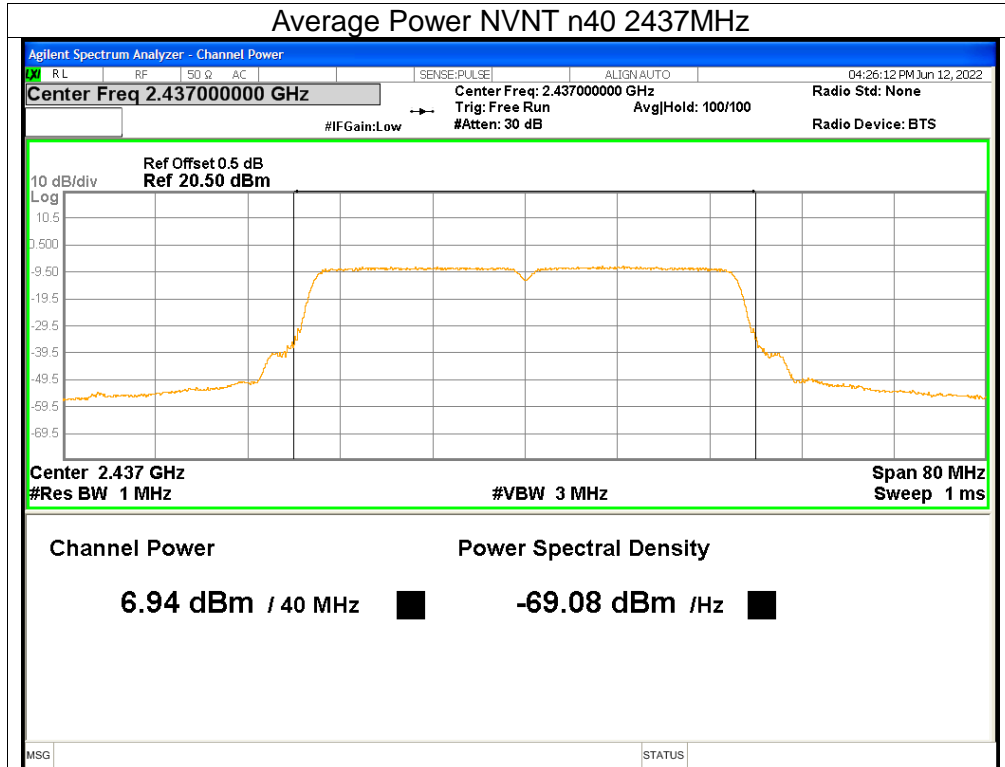



3. Maximum Peak Conducted Output Power

Condition	Mode	Frequency (MHz)	Conducted Power (dBm)	Limit (dBm)	Verdict
NVNT	b	2412	13.17	<=30	Pass
NVNT	b	2437	14.14	<=30	Pass
NVNT	b	2462	13.92	<=30	Pass
NVNT	g	2412	11.35	<=30	Pass
NVNT	g	2437	11.61	<=30	Pass
NVNT	g	2462	11.39	<=30	Pass
NVNT	n20	2412	11.37	<=30	Pass
NVNT	n20	2437	11.54	<=30	Pass
NVNT	n20	2462	11.38	<=30	Pass
NVNT	n40	2422	11.71	<=30	Pass
NVNT	n40	2437	11.76	<=30	Pass
NVNT	n40	2452	11.75	<=30	Pass

EIRP Power

TX 802.11b Mode					
Test Channel	Frequency	Peak Power	Antenna Gain	EIRP Power	LIMIT
	(MHz)	(dBm)	(dBi)	(dBm)	dBm
CH01	2412	13.17	2.00	15.17	36.02
CH06	2437	14.14	2.00	16.14	36.02
CH11	2462	13.92	2.00	15.92	36.02
TX 802.11g Mode					
Test Channel	Frequency	Peak Power	Antenna Gain	EIRP Power	LIMIT
	(MHz)	(dBm)	(dBi)	(dBm)	dBm
CH01	2412	11.35	2.00	13.35	36.02
CH06	2437	11.61	2.00	13.61	36.02
CH11	2462	11.39	2.00	13.39	36.02
TX 802.11n20 Mode					
Test Channel	Frequency	Peak Power	Antenna Gain	EIRP Power	LIMIT
	(MHz)	(dBm)	(dBi)	(dBm)	dBm
CH01	2412	11.37	2.00	13.37	36.02
CH06	2437	11.54	2.00	13.54	36.02
CH11	2462	11.38	2.00	13.38	36.02
TX 802.11n40 Mode					
Test Channel	Frequency	Peak Power	Antenna Gain	EIRP Power	LIMIT
	(MHz)	(dBm)	(dBi)	(dBm)	dBm
CH03	2422	11.71	2.00	13.71	36.02
CH06	2437	11.76	2.00	13.76	36.02
CH09	2452	11.75	2.00	13.75	36.02

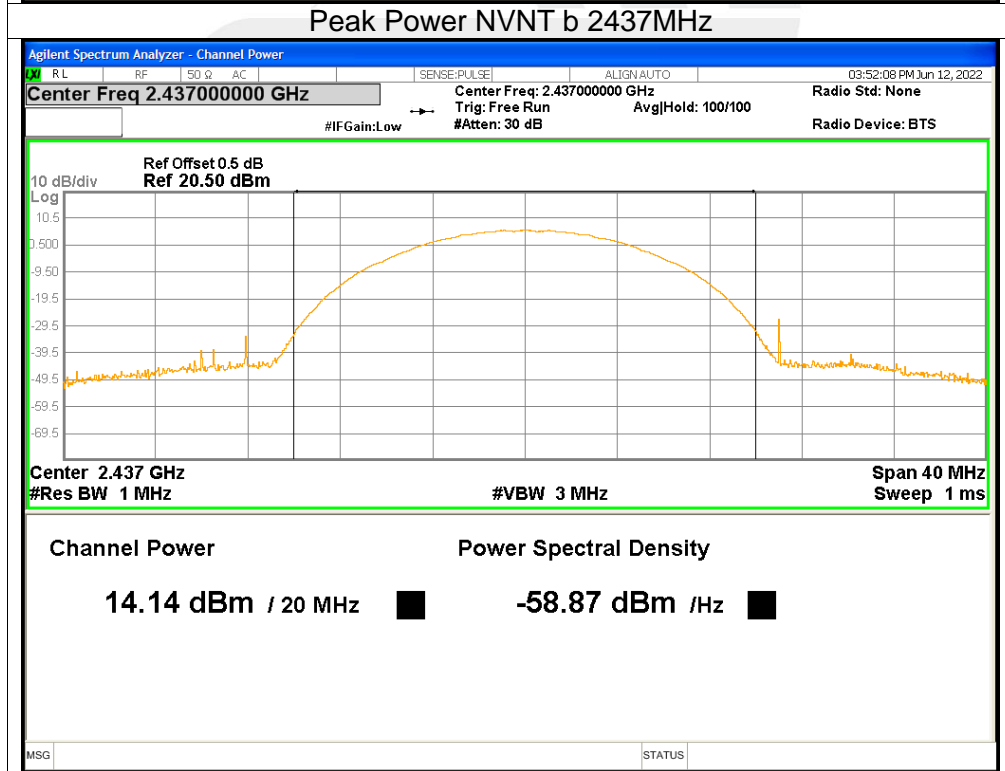
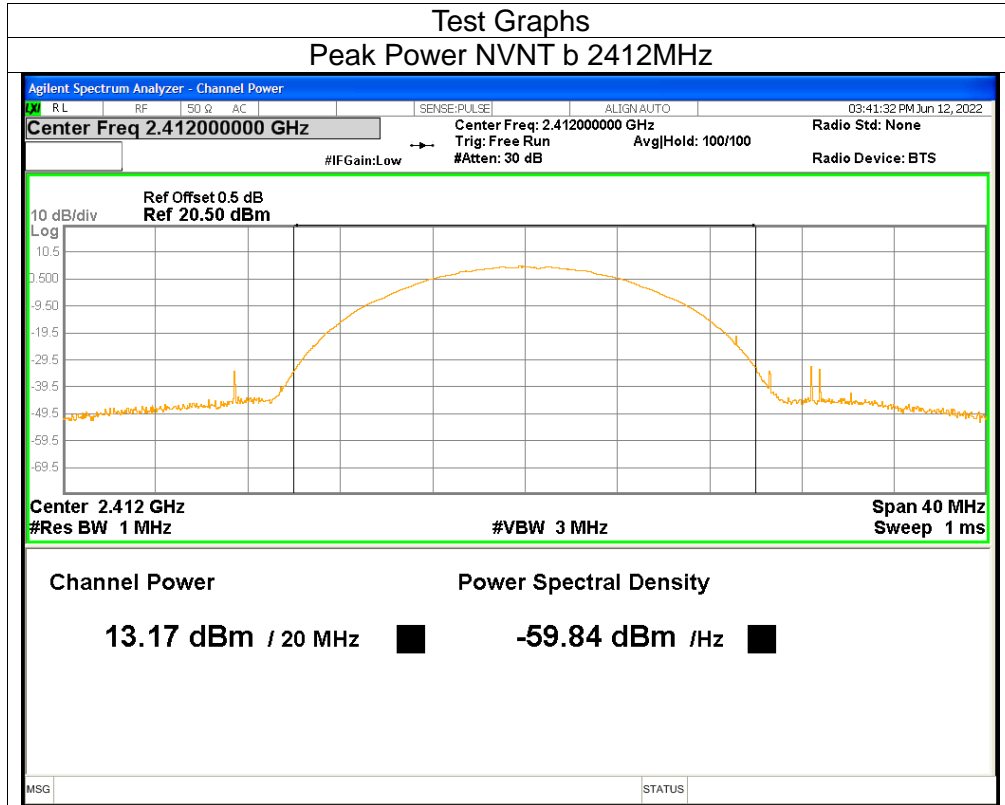

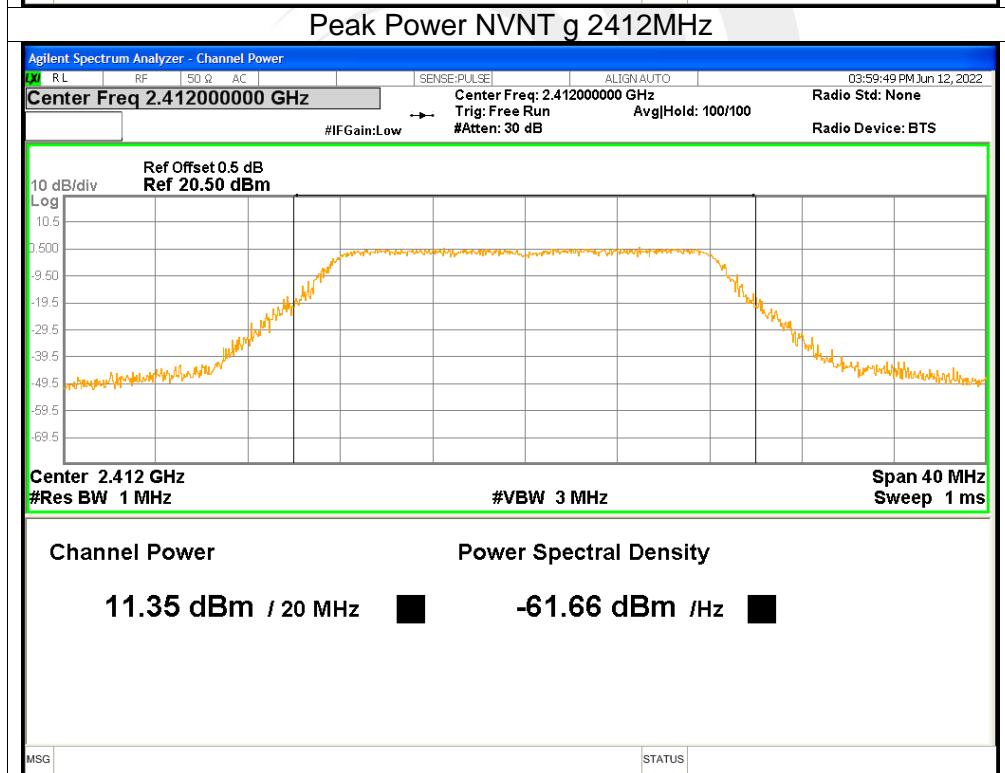
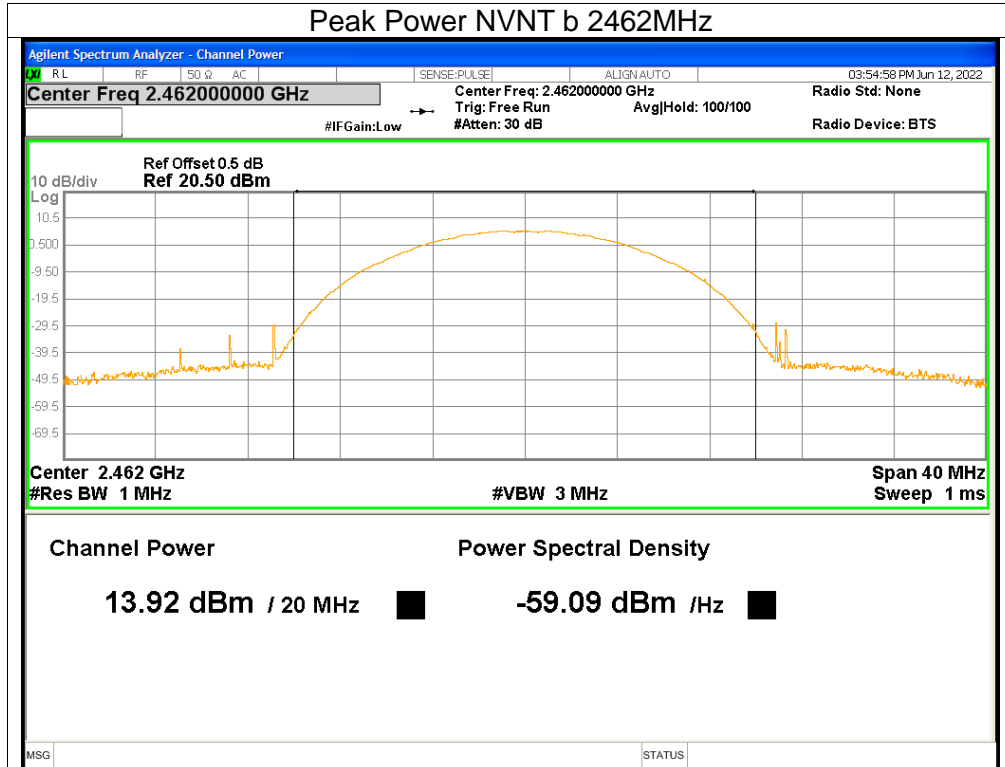

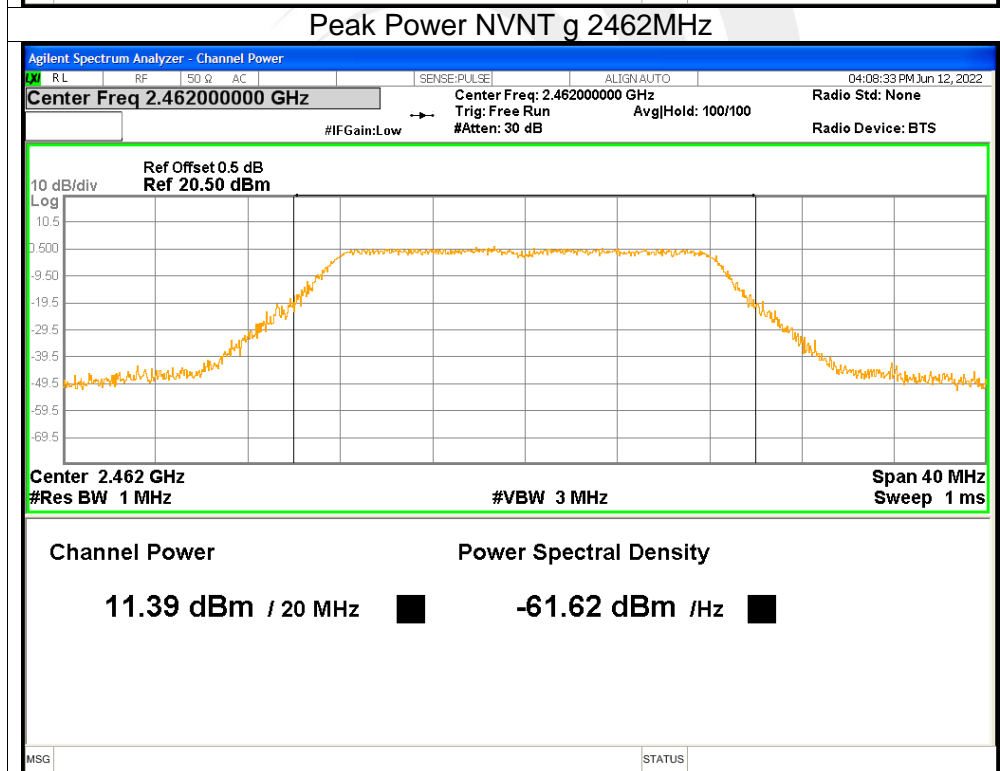
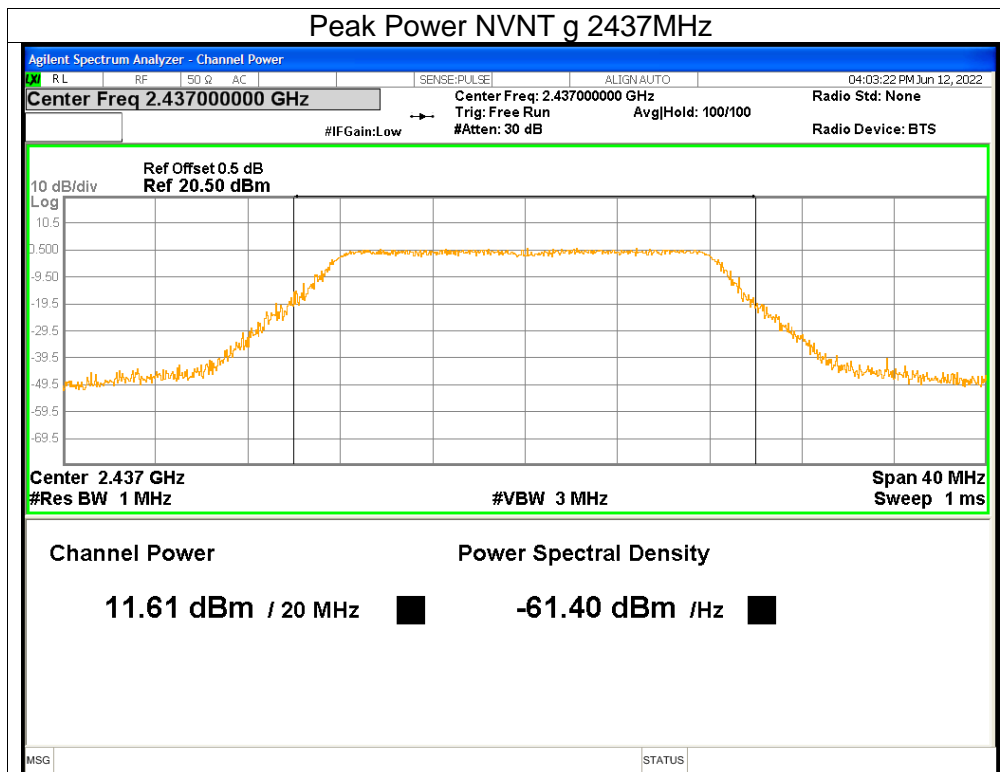

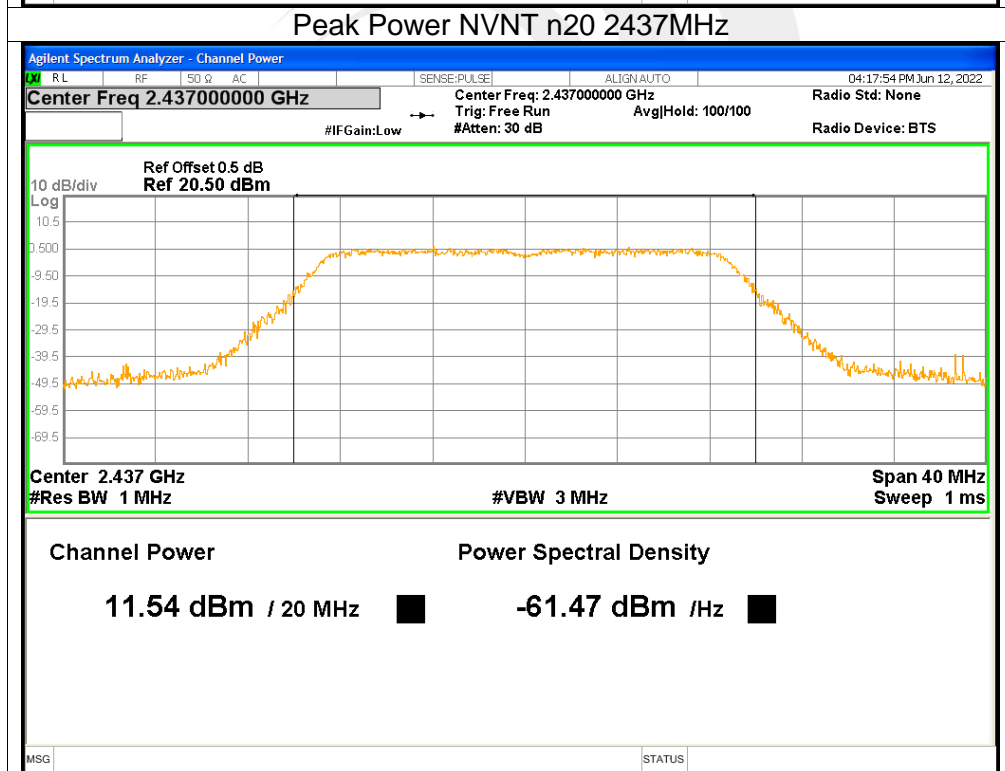
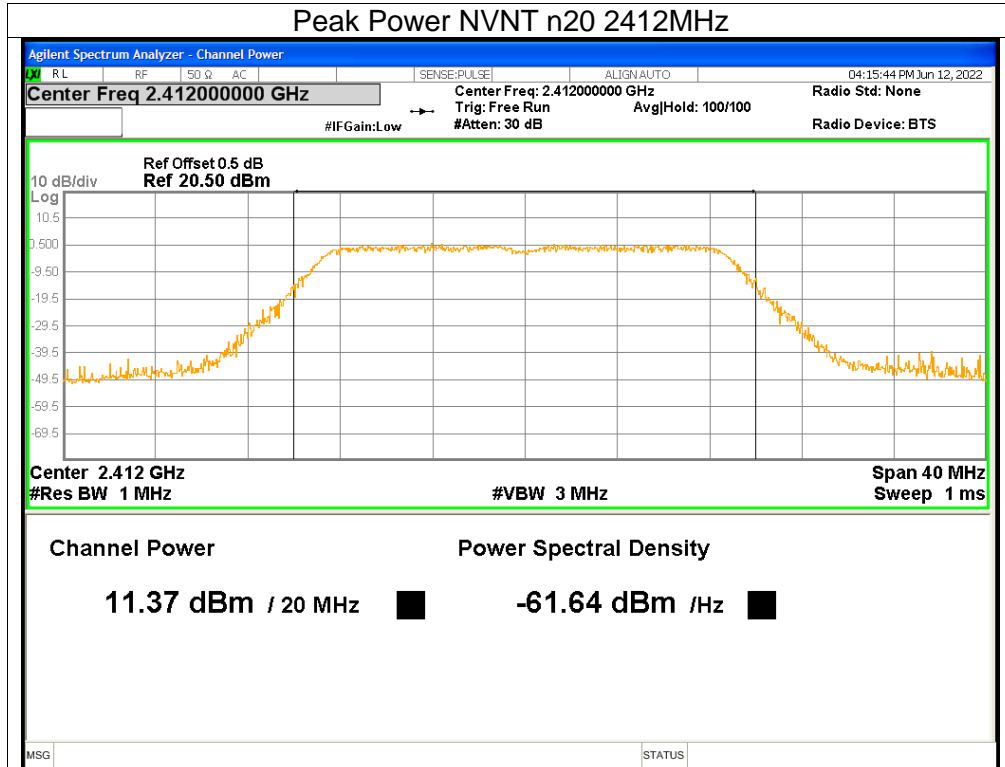

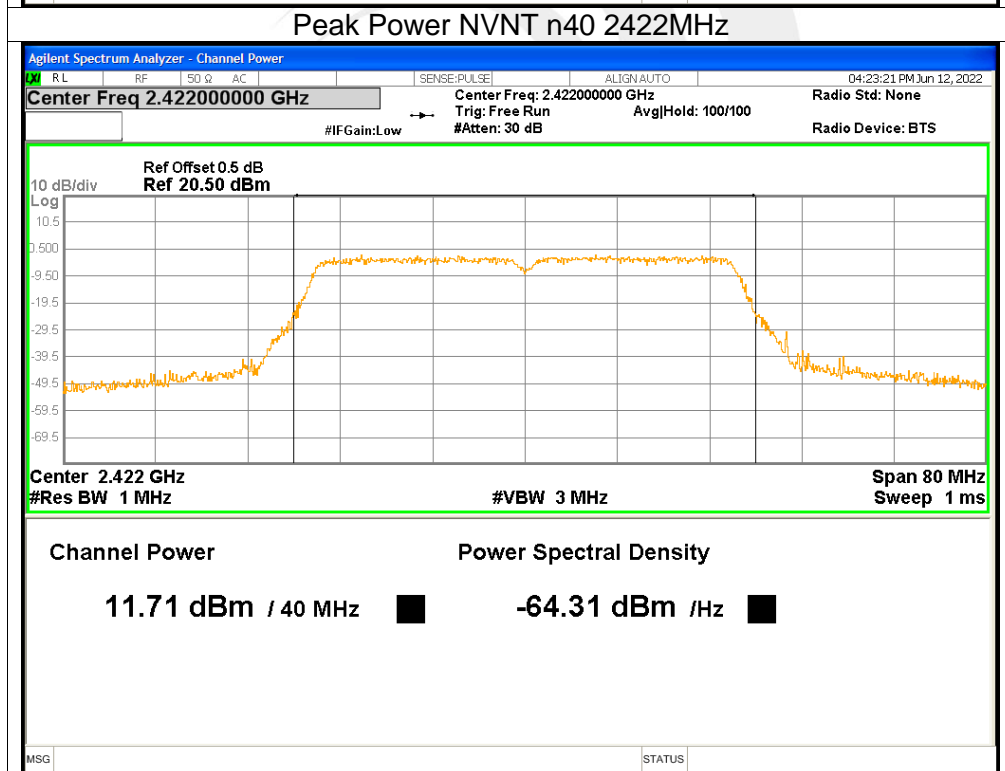
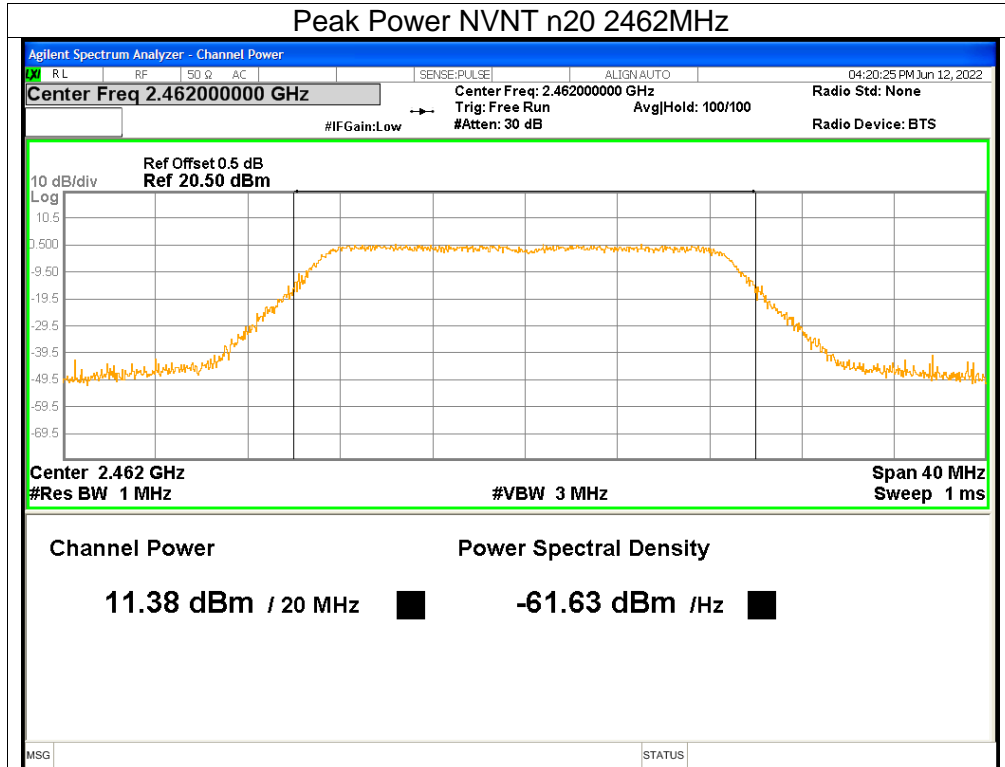

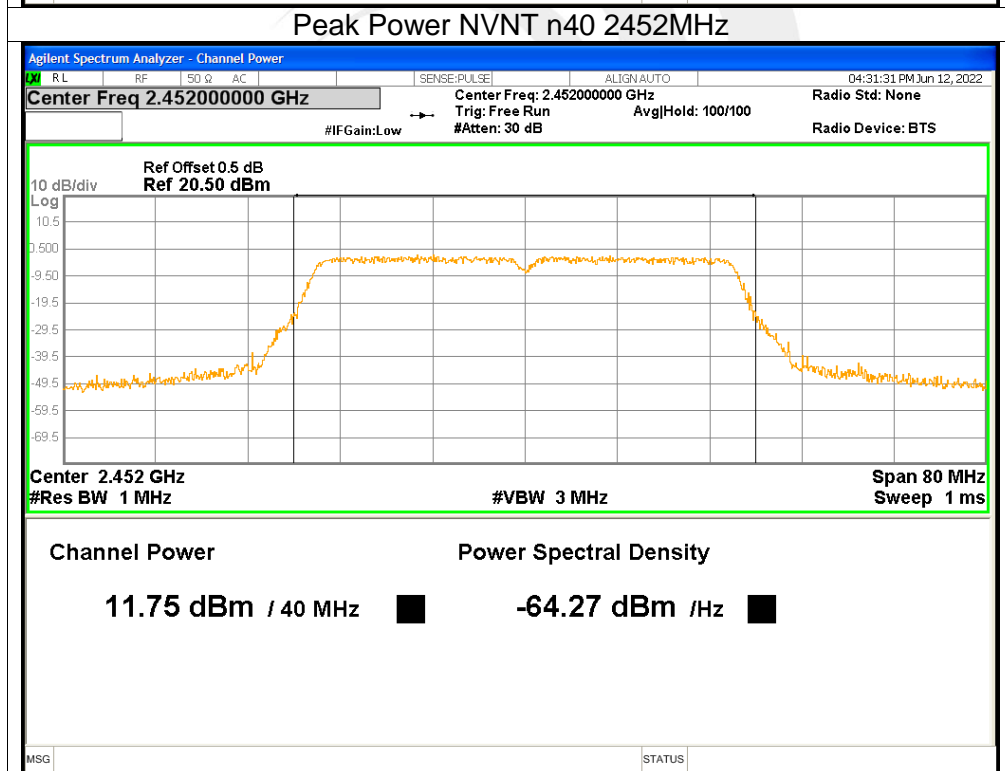
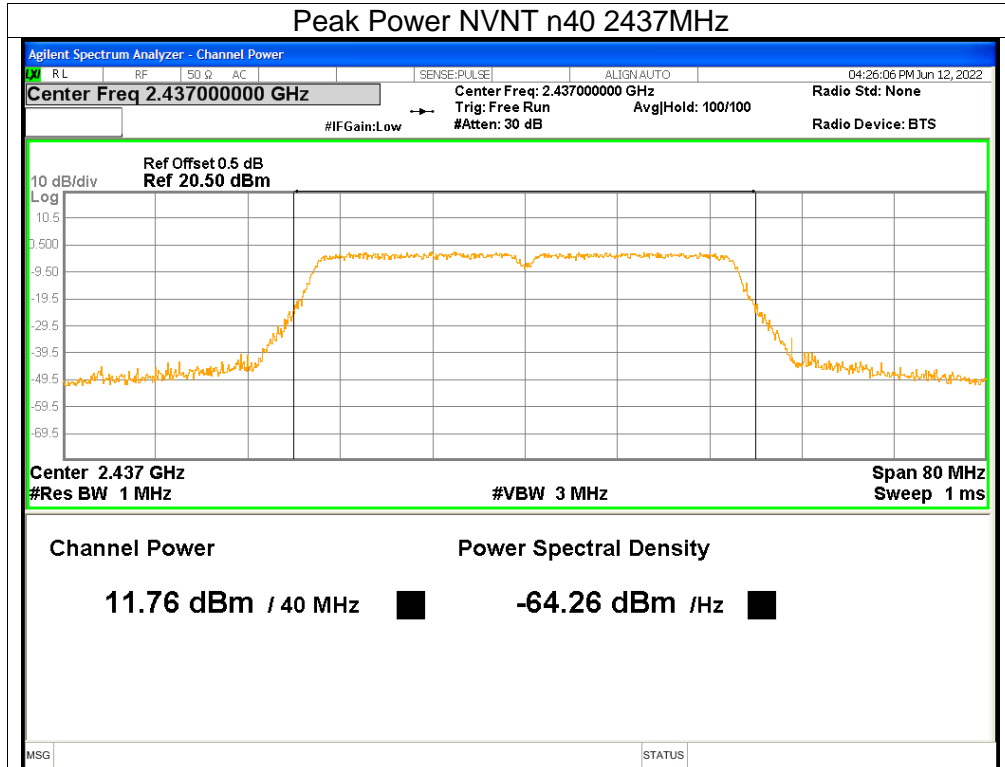



4. Bandwidth

Condition	Mode	Frequency (MHz)	-6 dB Bandwidth (MHz)	99% Bandwidth (MHz)	Limit Bandwidth (MHz)	Verdict
NVNT	b	2412	8.58	13.438	≥ 0.5	Pass
NVNT	b	2437	7.09	13.428	≥ 0.5	Pass
NVNT	b	2462	9.02	13.421	≥ 0.5	Pass
NVNT	g	2412	16.33	16.680	≥ 0.5	Pass
NVNT	g	2437	16.36	16.677	≥ 0.5	Pass
NVNT	g	2462	16.35	16.680	≥ 0.5	Pass
NVNT	n20	2412	17.54	17.729	≥ 0.5	Pass
NVNT	n20	2437	17.56	17.726	≥ 0.5	Pass
NVNT	n20	2462	17.53	17.733	≥ 0.5	Pass
NVNT	n40	2422	36.04	36.333	≥ 0.5	Pass
NVNT	n40	2437	35.8	36.303	≥ 0.5	Pass
NVNT	n40	2452	35.69	36.304	≥ 0.5	Pass





Test Graphs

-6dB Bandwidth NVNT b 2412MHz

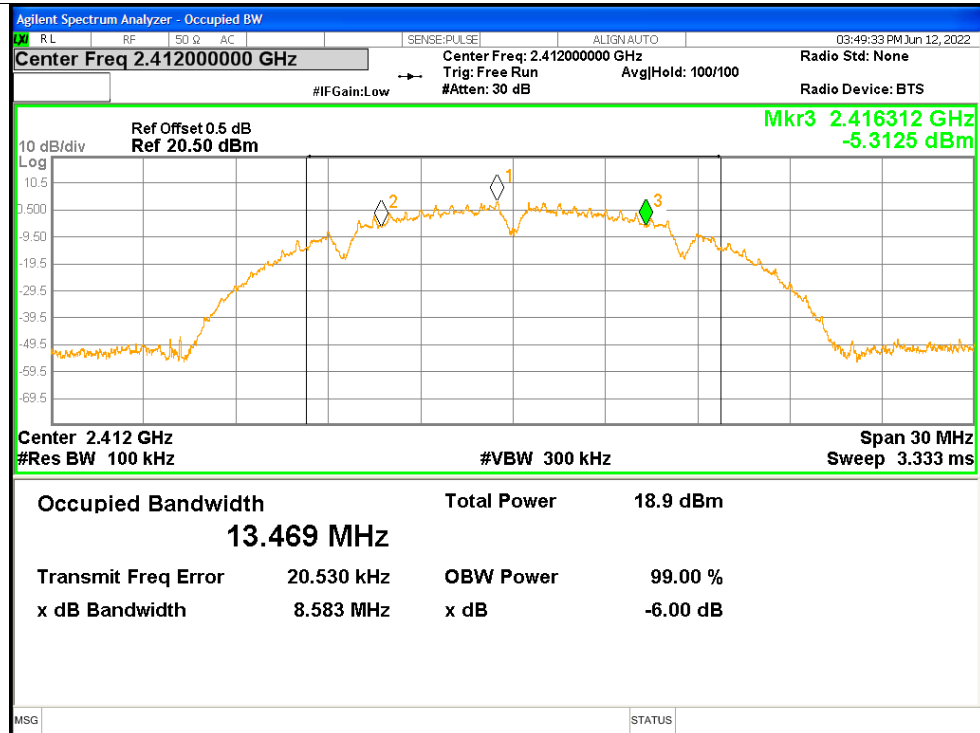

-6dB Bandwidth NVNT b 2437MHz

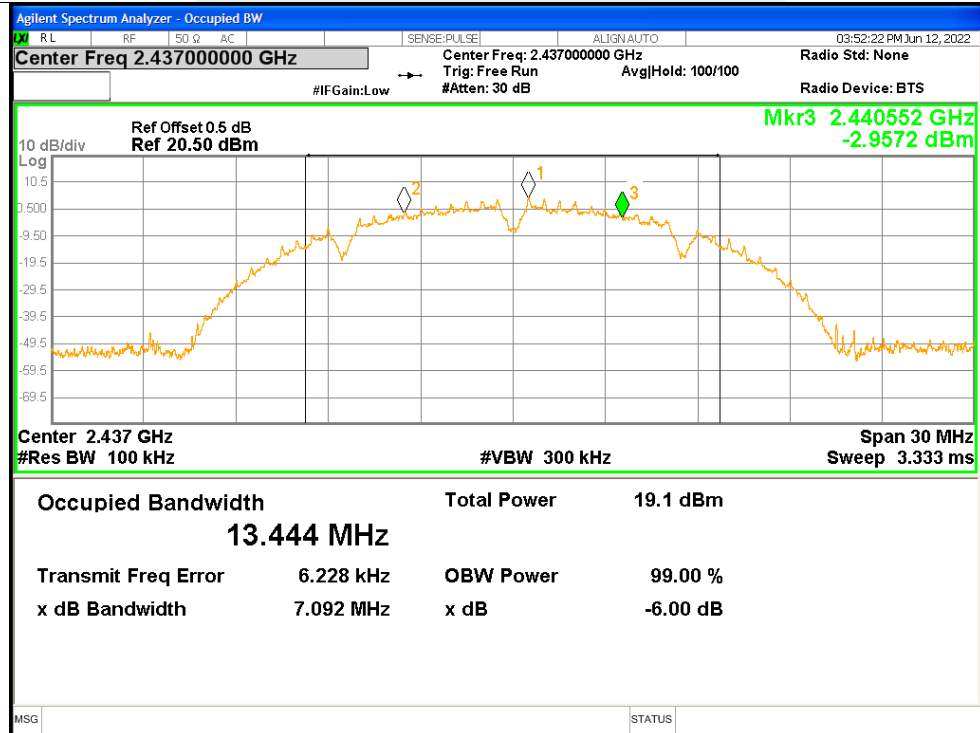

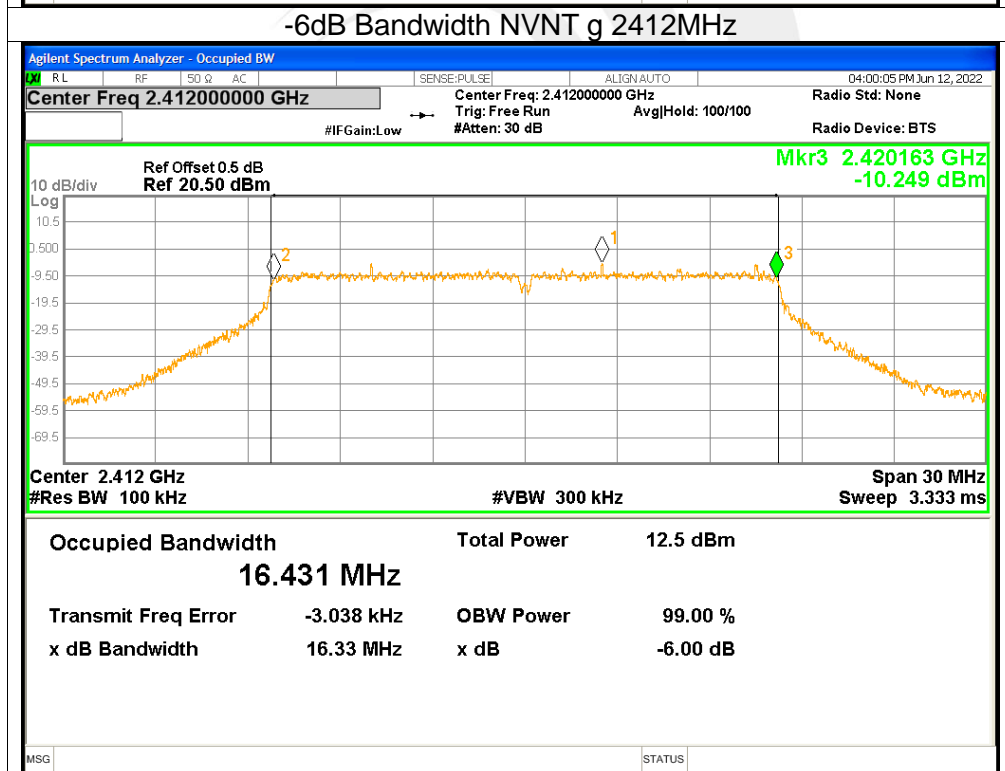
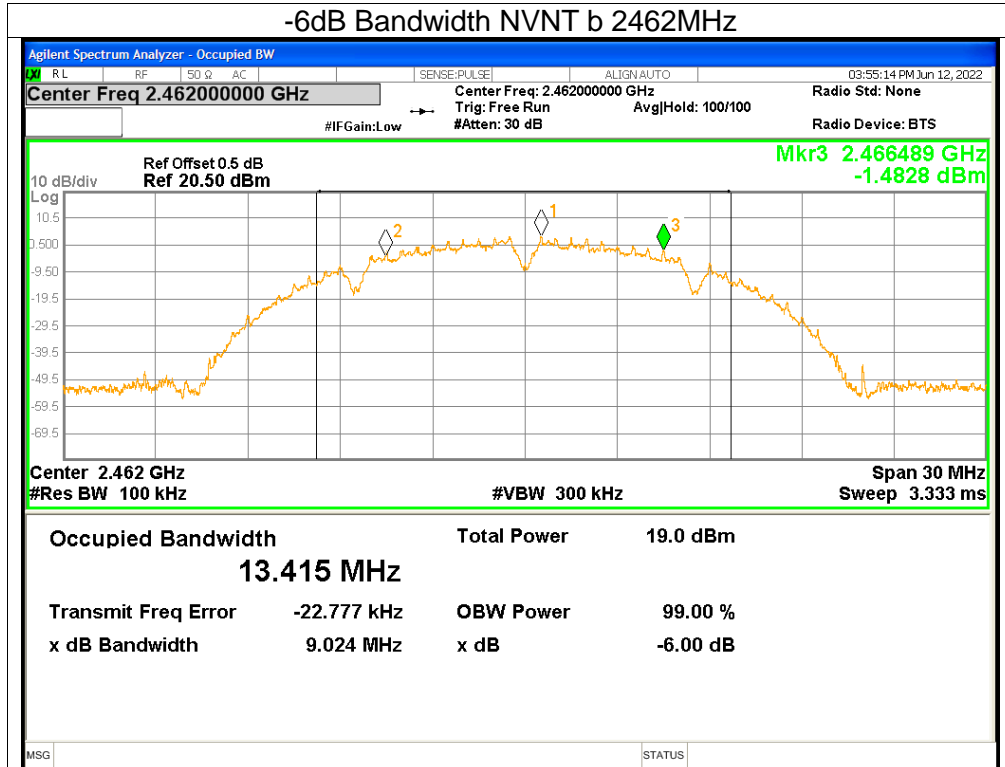

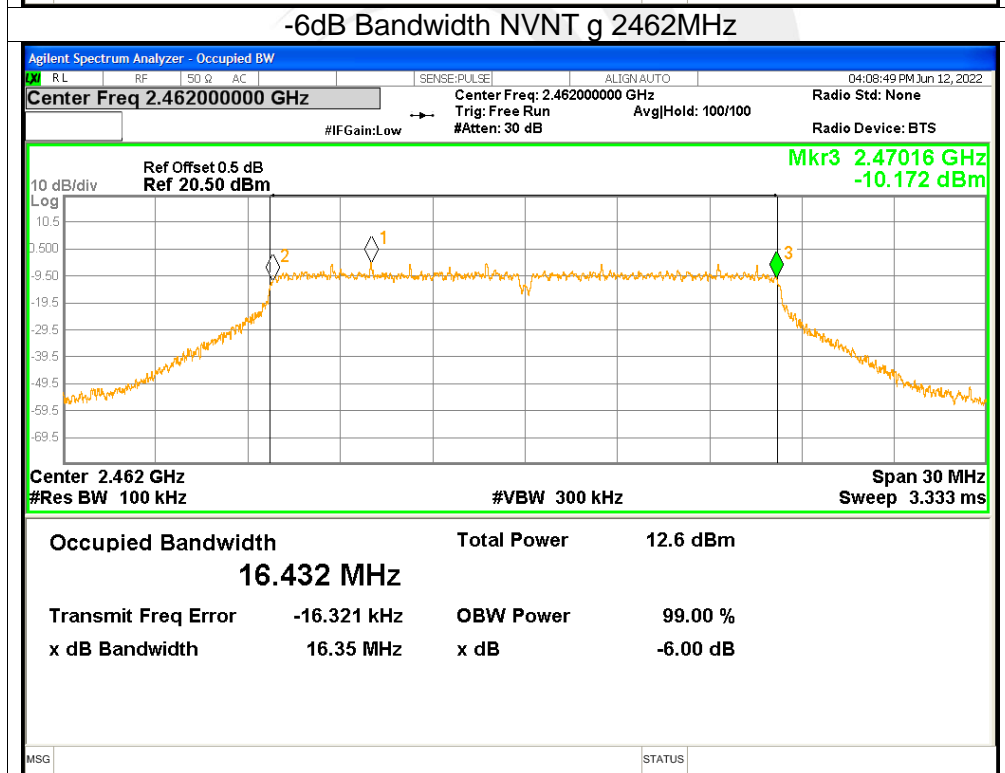
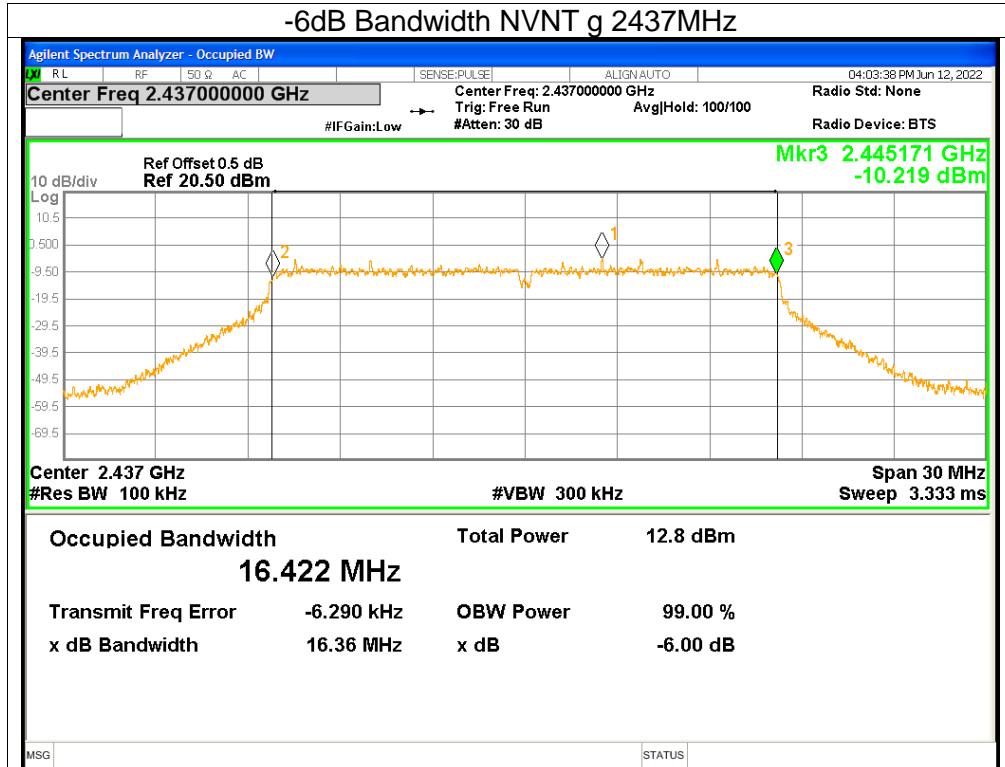

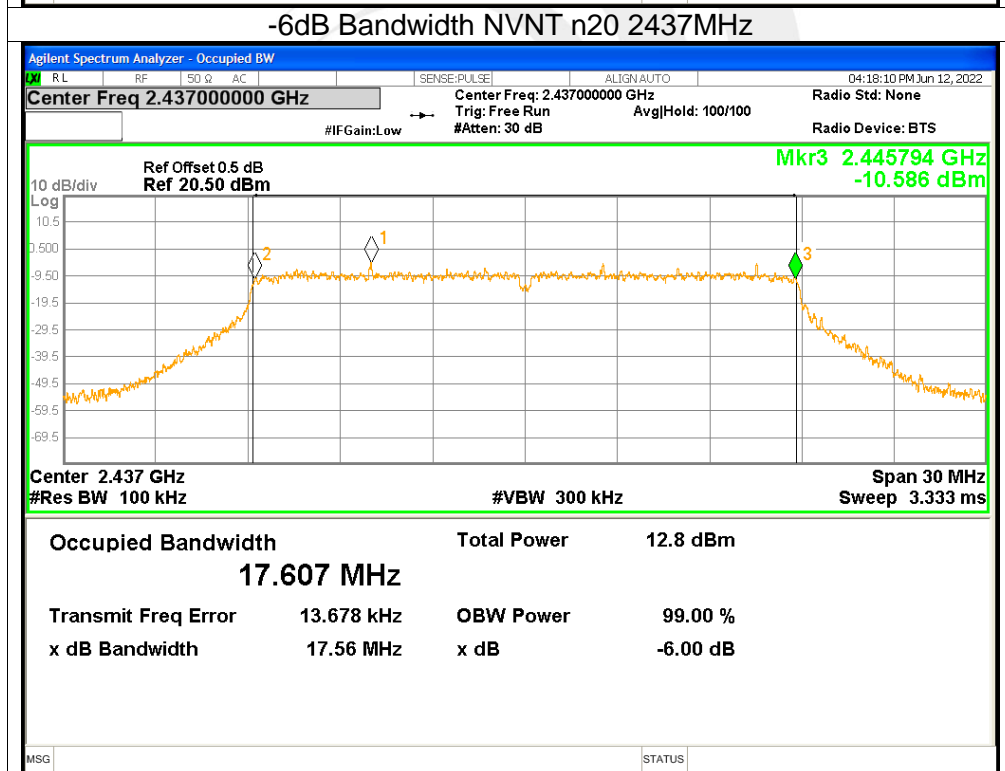
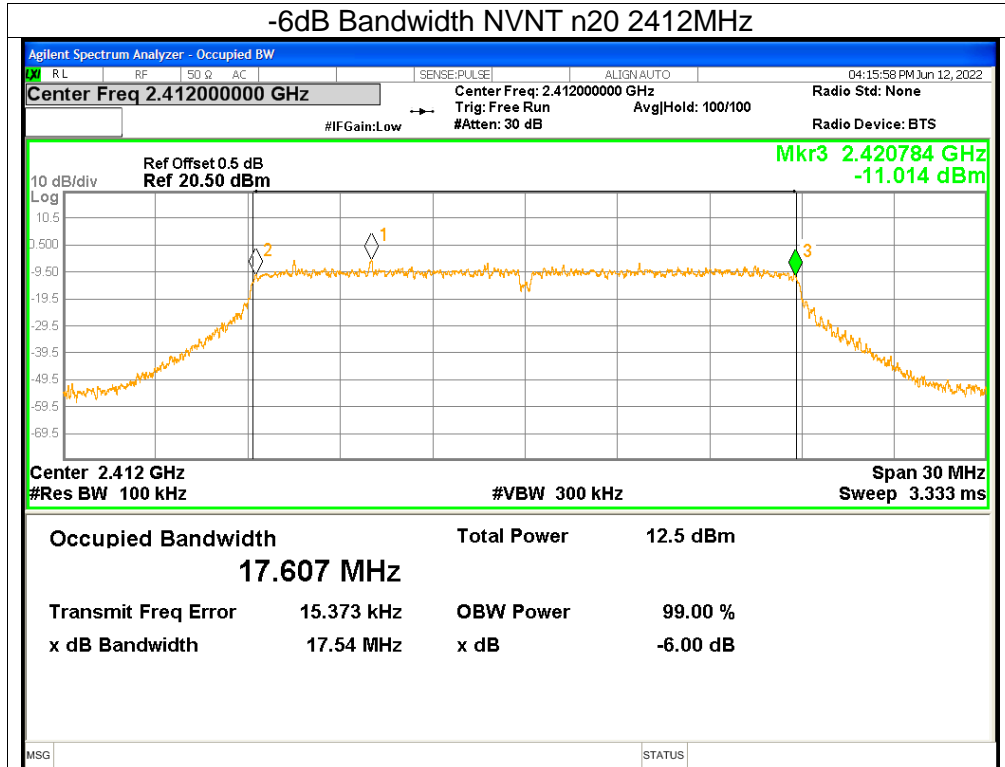

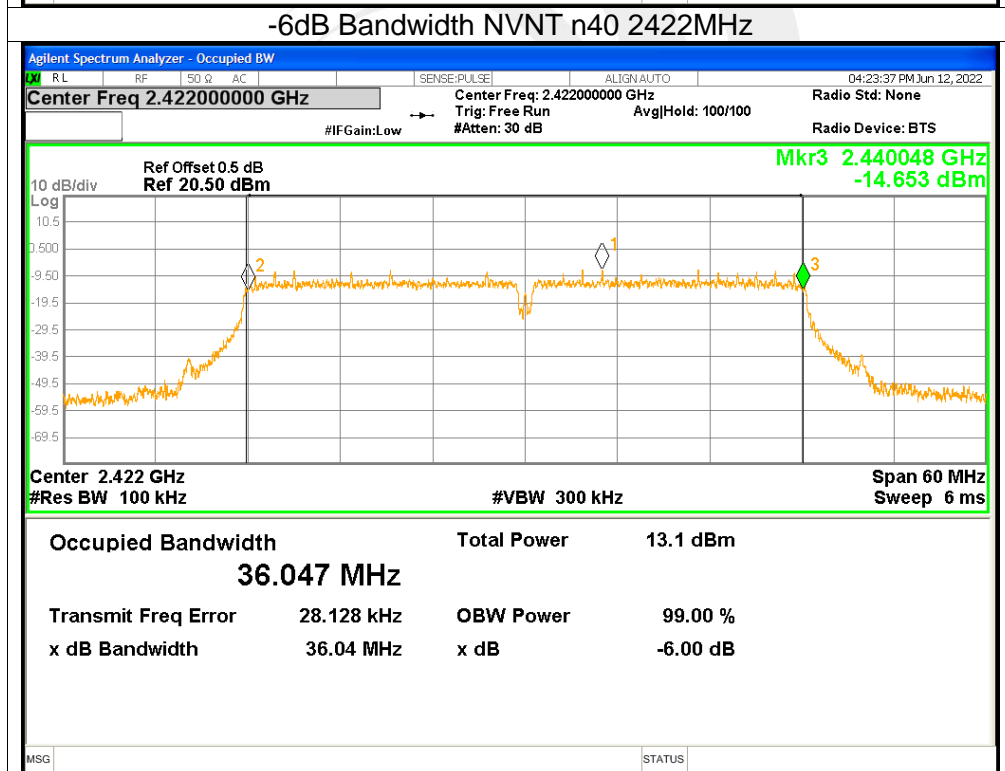
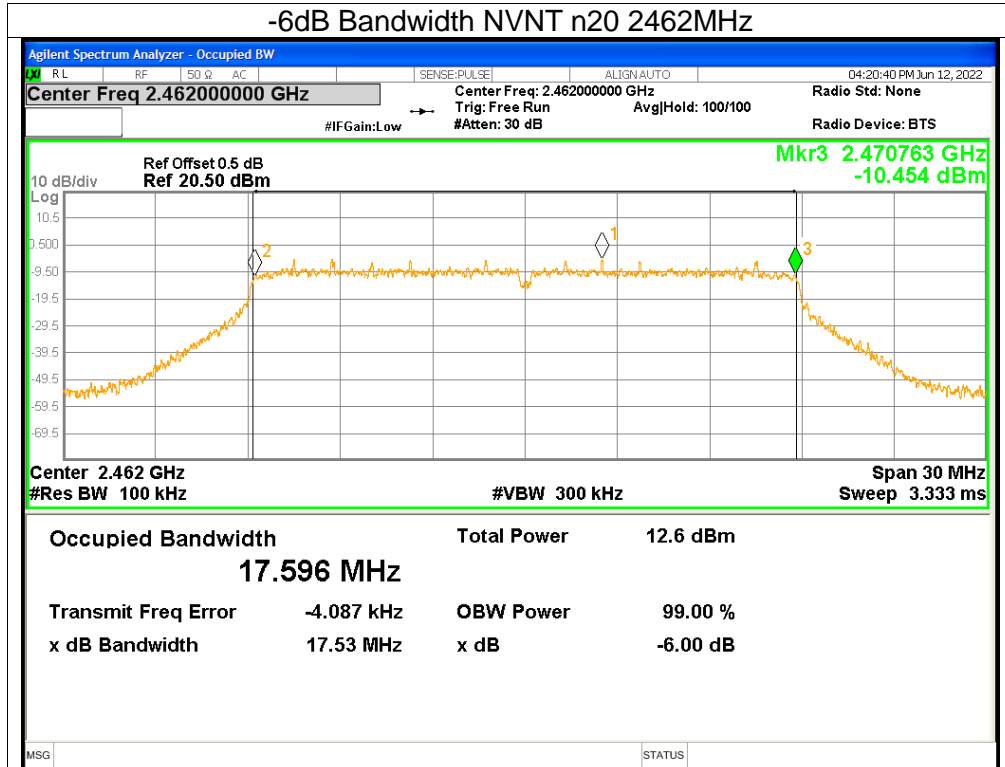

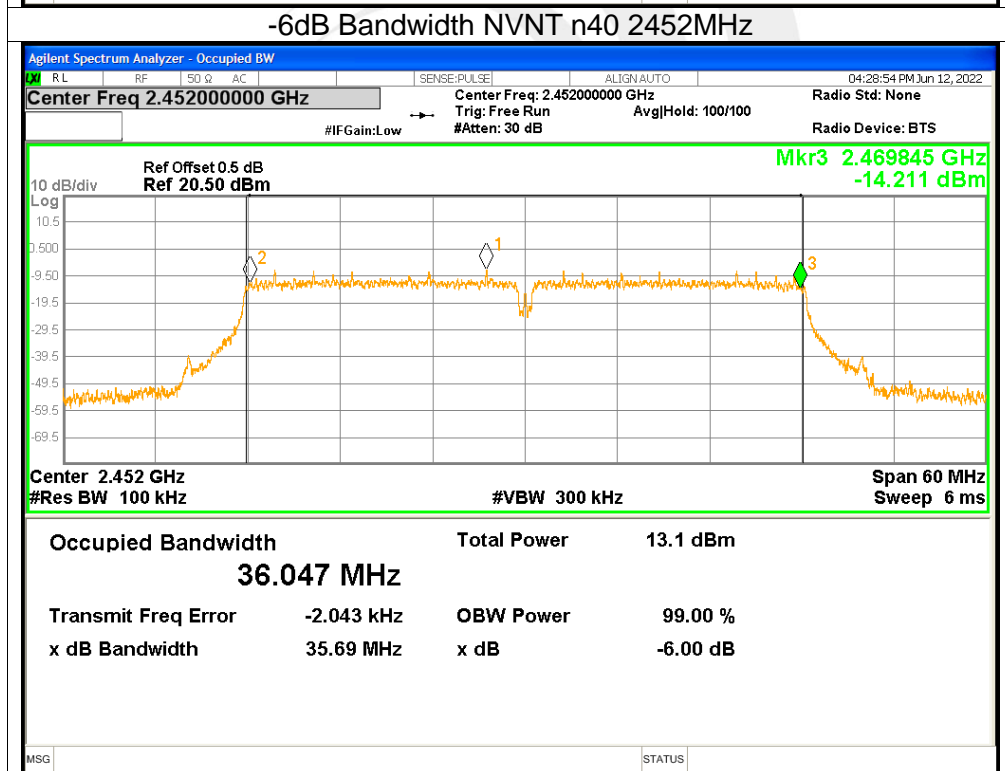
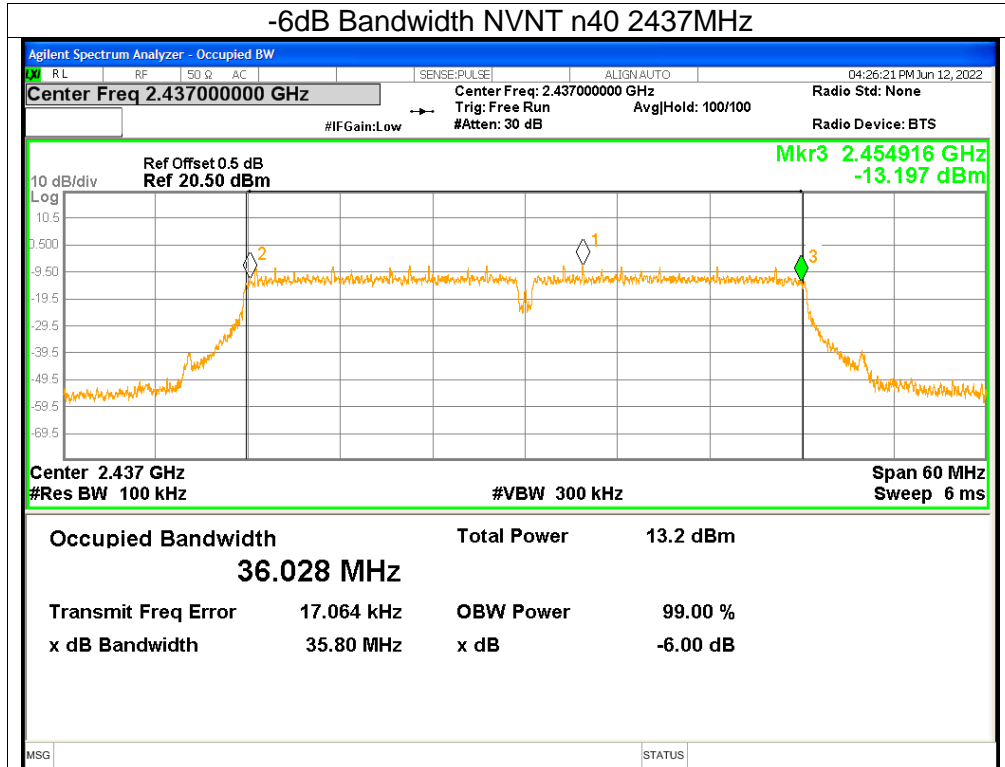



Test Graphs

99% Bandwidth NVNT b 2412MHz

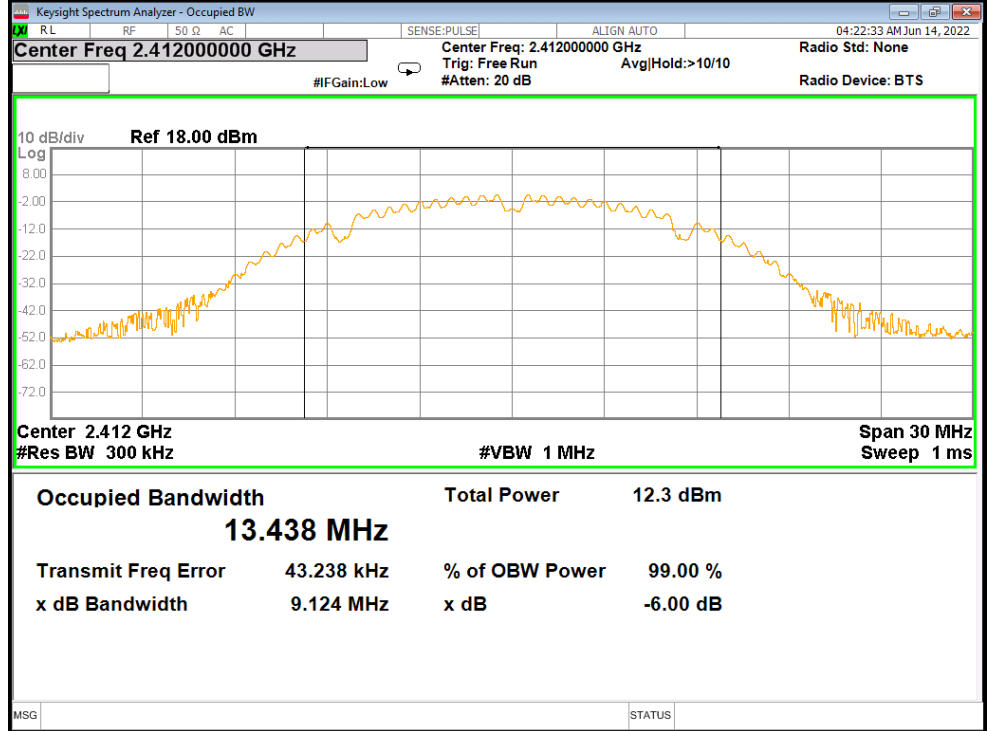

99% Bandwidth NVNT b 2437MHz

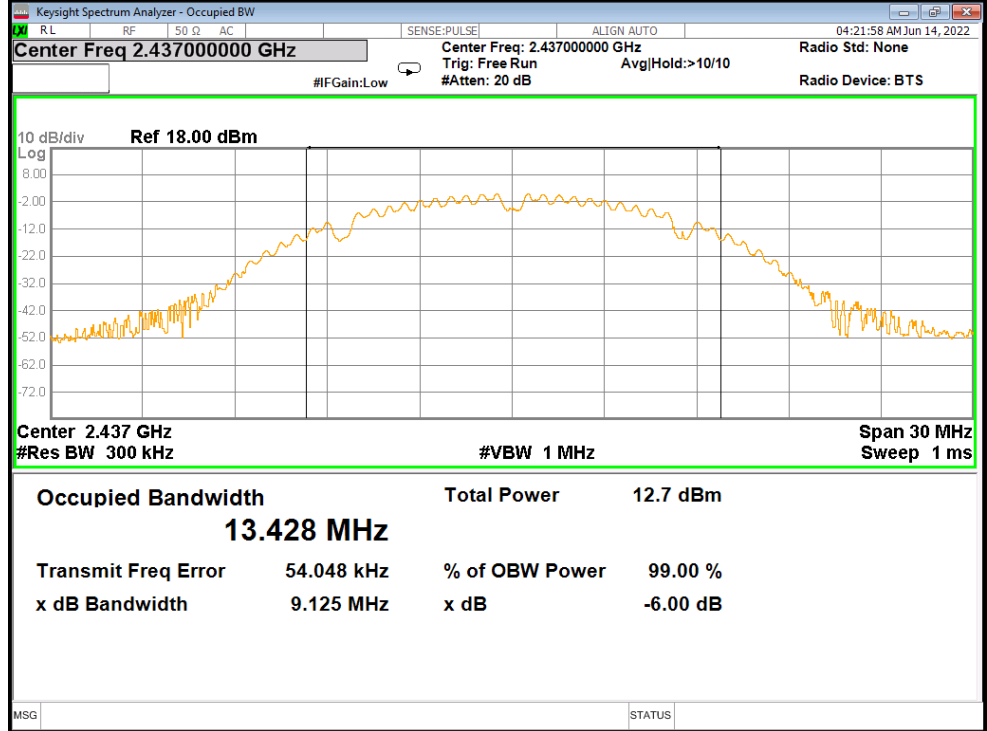

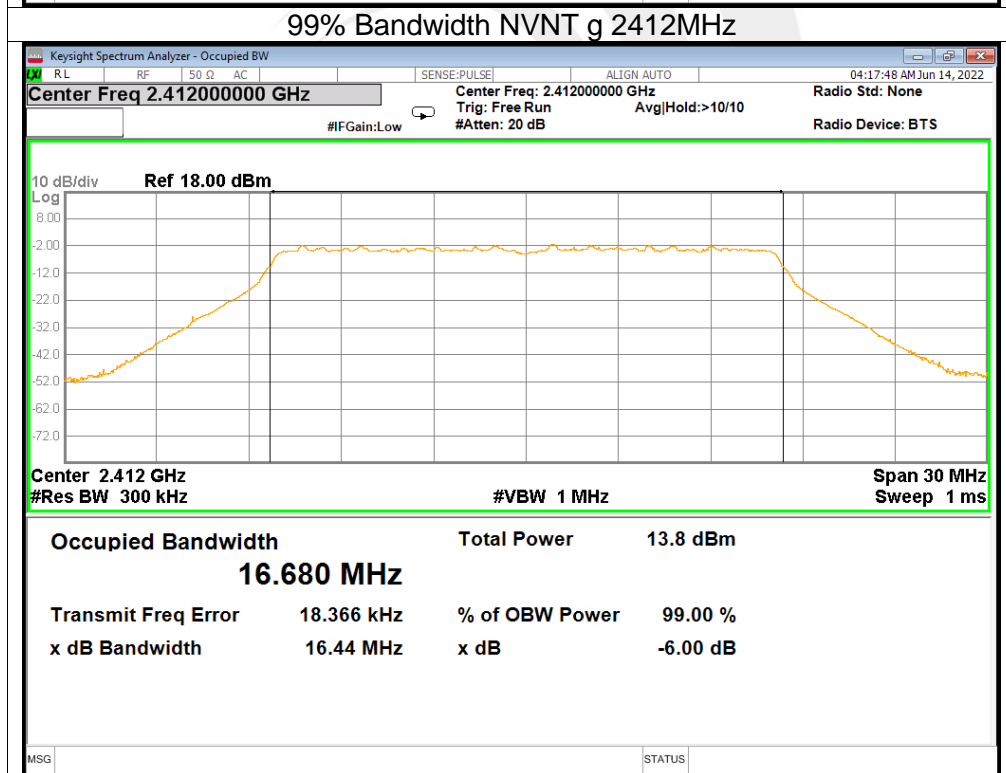
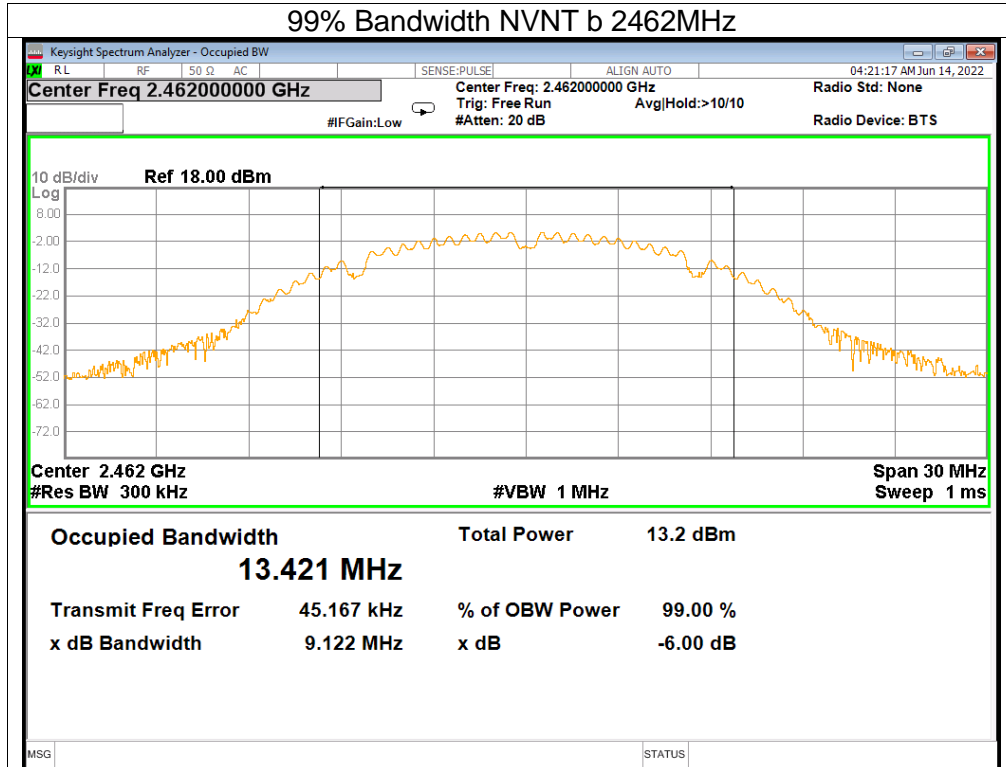

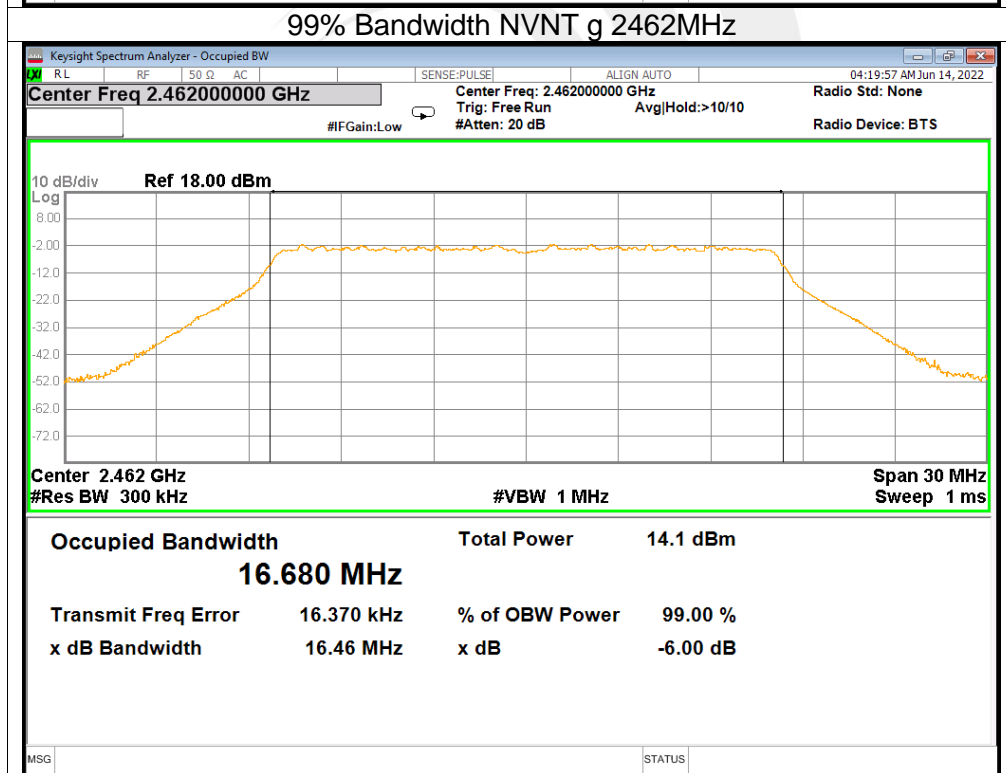
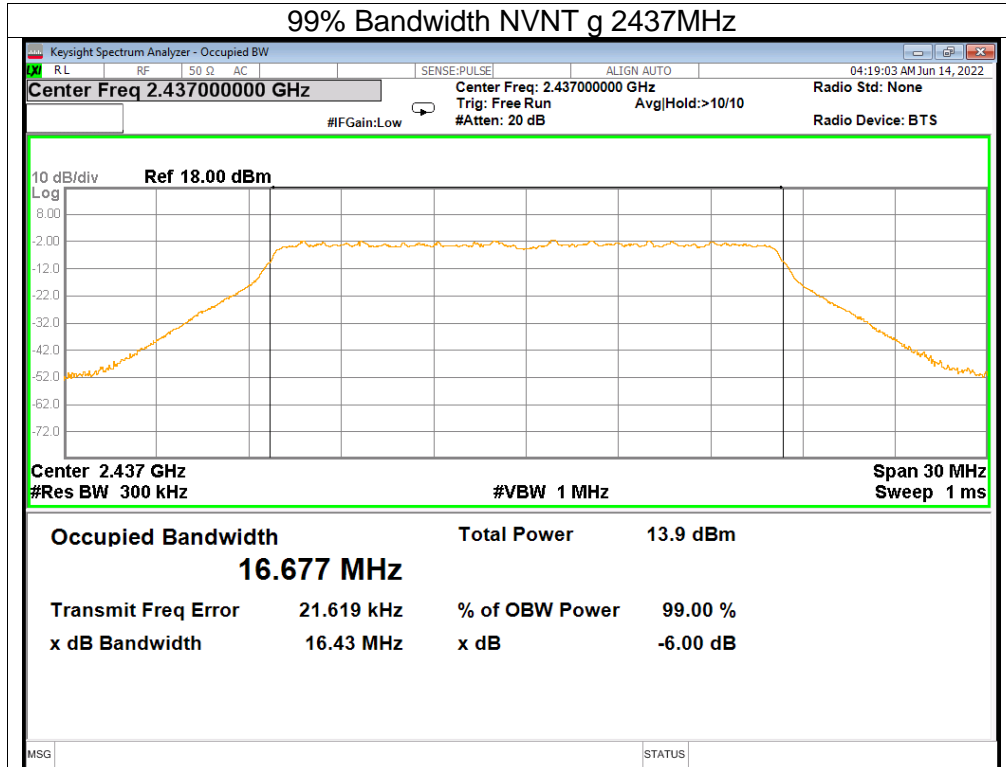

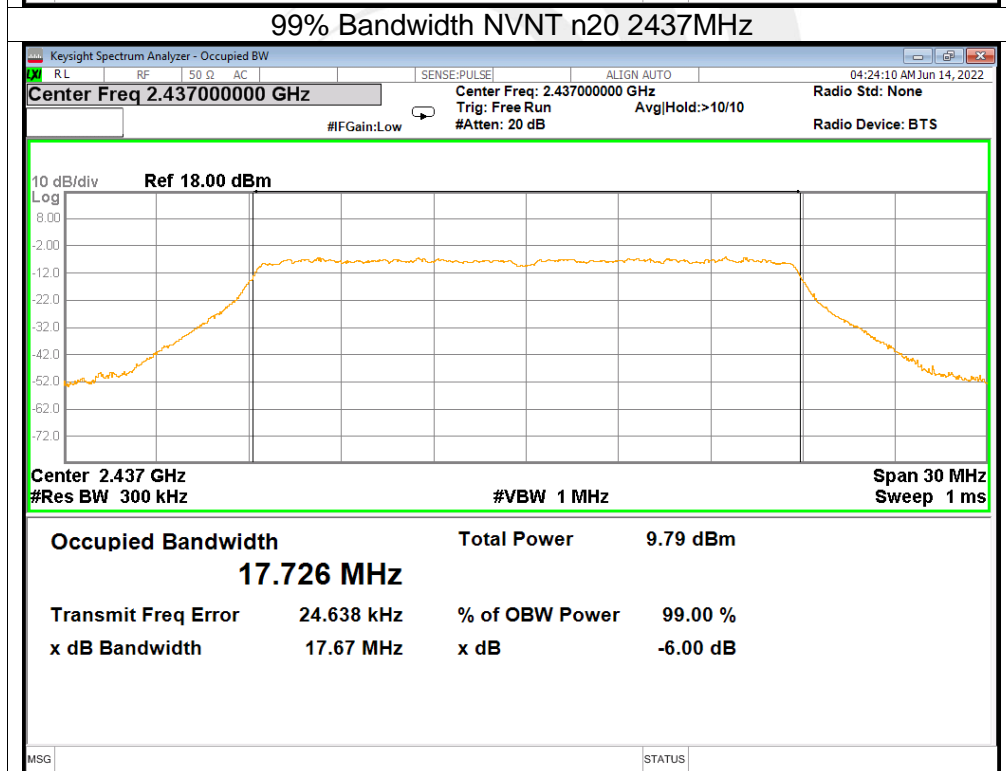
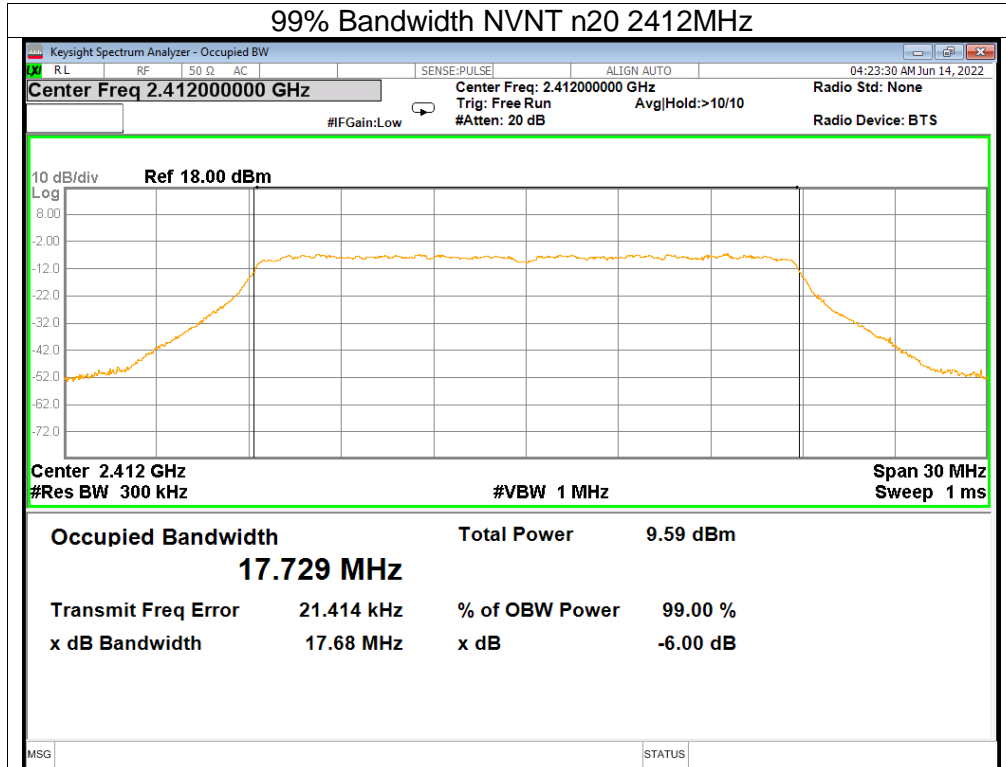

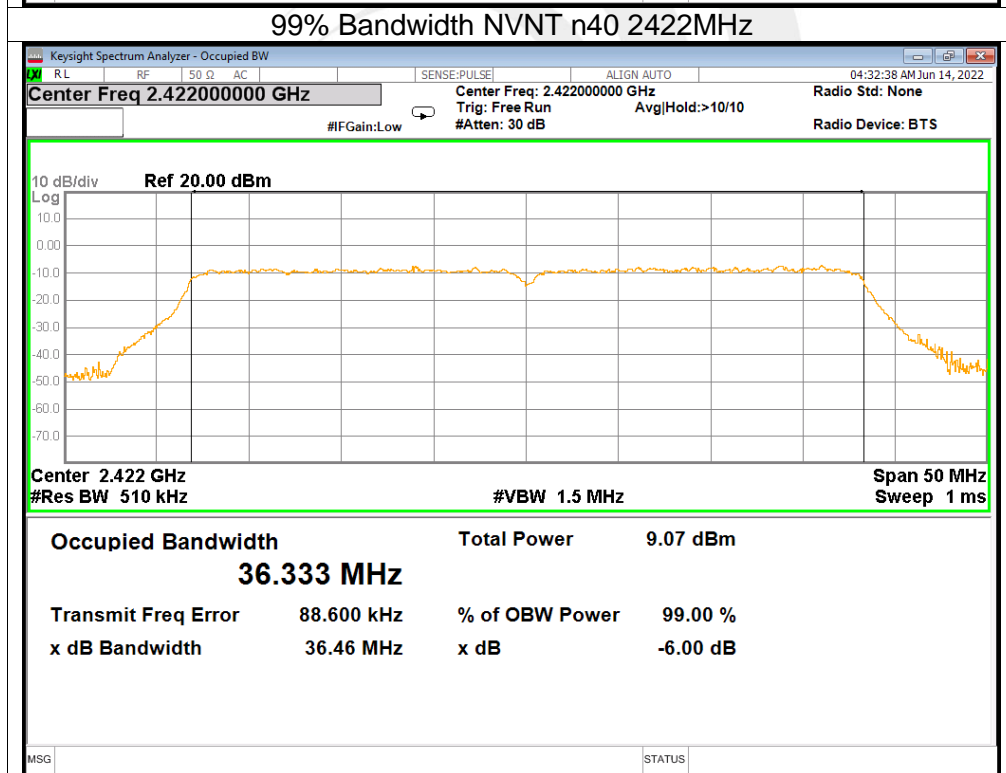
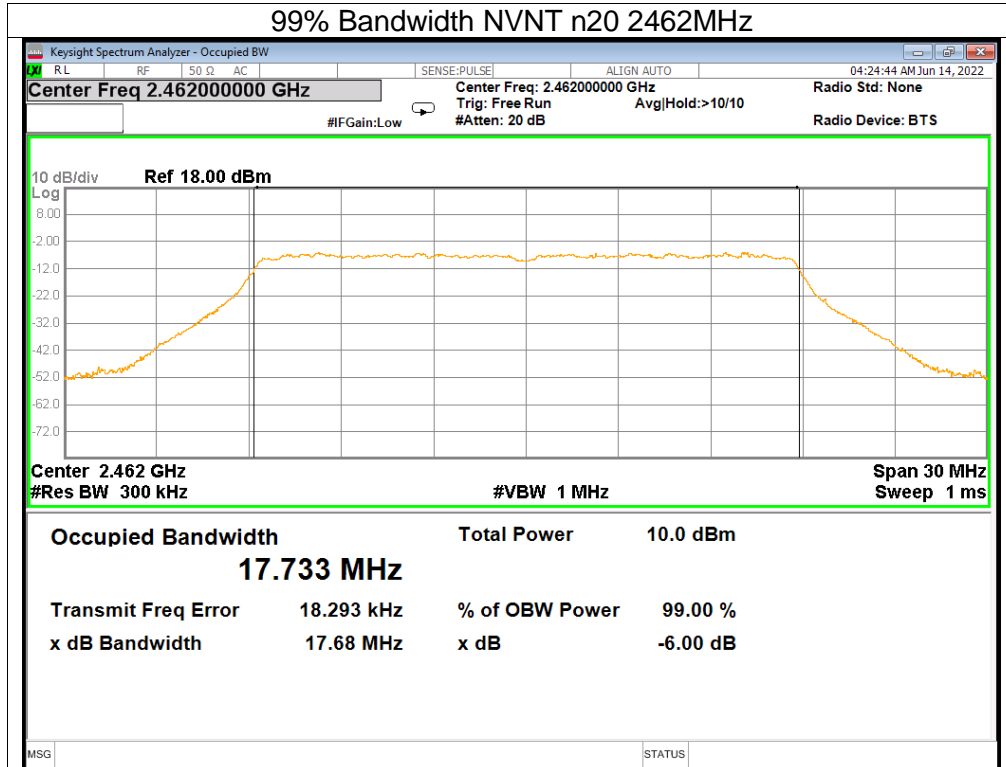

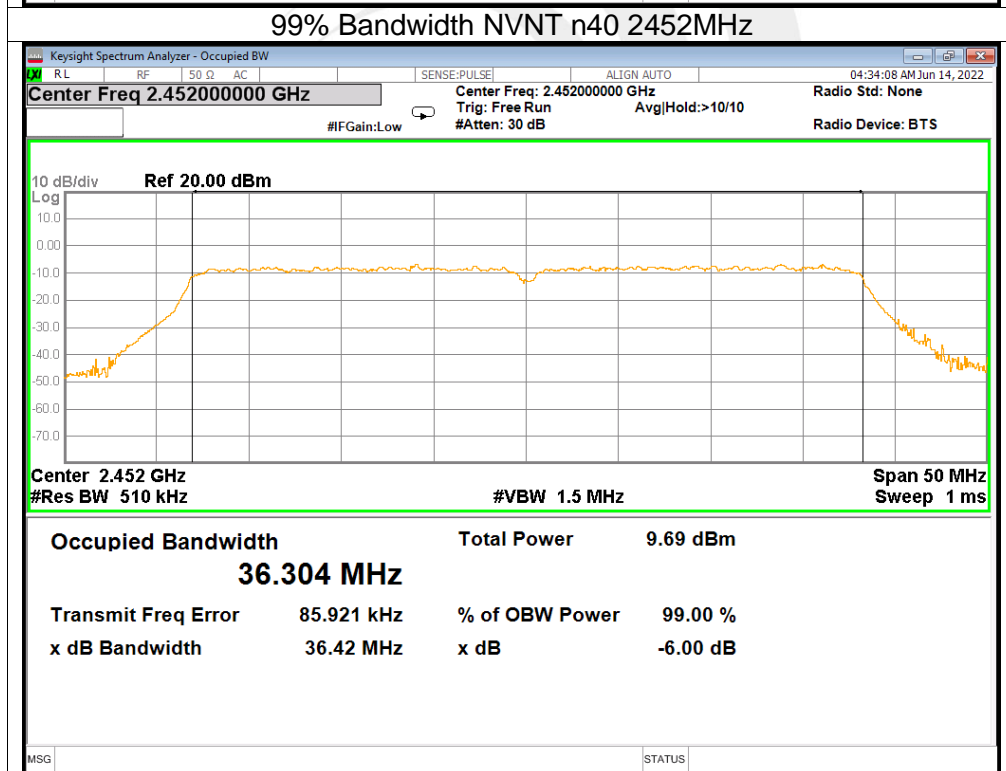
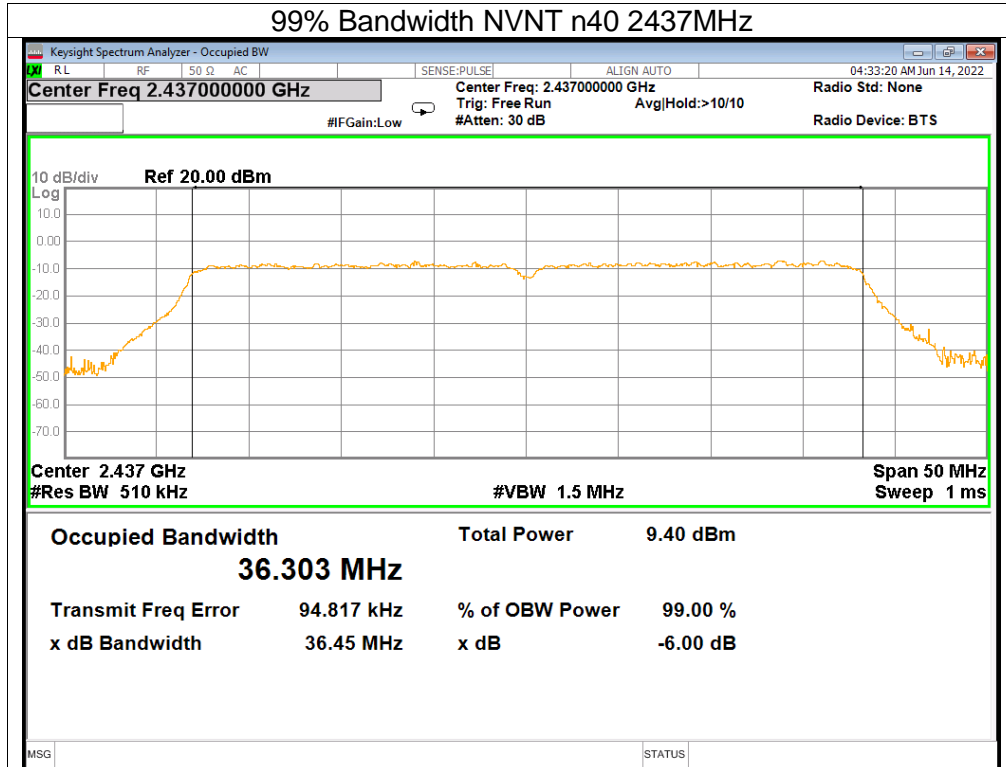



5. Maximum Power Spectral Density Level

Condition	Mode	Frequency (MHz)	PSD (dBm/3kHz)	Limit (dBm/3kHz)	Verdict
NVNT	b	2412	-10.5	<=8	Pass
NVNT	b	2437	-9.29	<=8	Pass
NVNT	b	2462	-9.45	<=8	Pass
NVNT	g	2412	-18.5	<=8	Pass
NVNT	g	2437	-18.26	<=8	Pass
NVNT	g	2462	-18.49	<=8	Pass
NVNT	n20	2412	-18.46	<=8	Pass
NVNT	n20	2437	-18.17	<=8	Pass
NVNT	n20	2462	-18.43	<=8	Pass
NVNT	n40	2422	-18.25	<=8	Pass
NVNT	n40	2437	-18.08	<=8	Pass
NVNT	n40	2452	-18.14	<=8	Pass



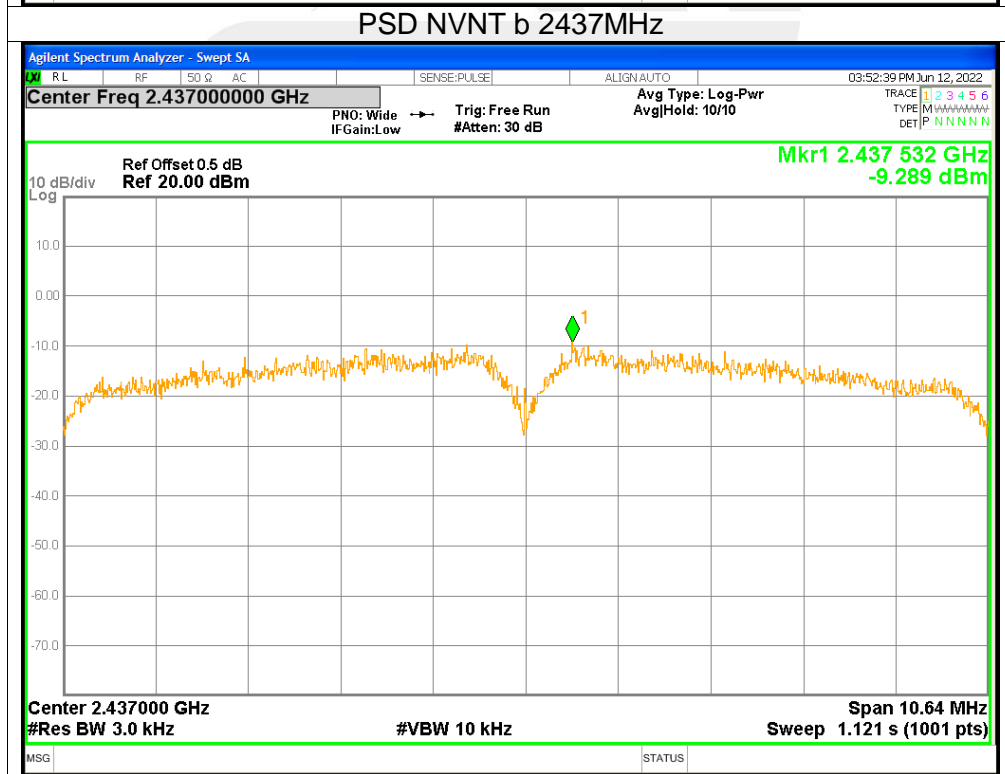
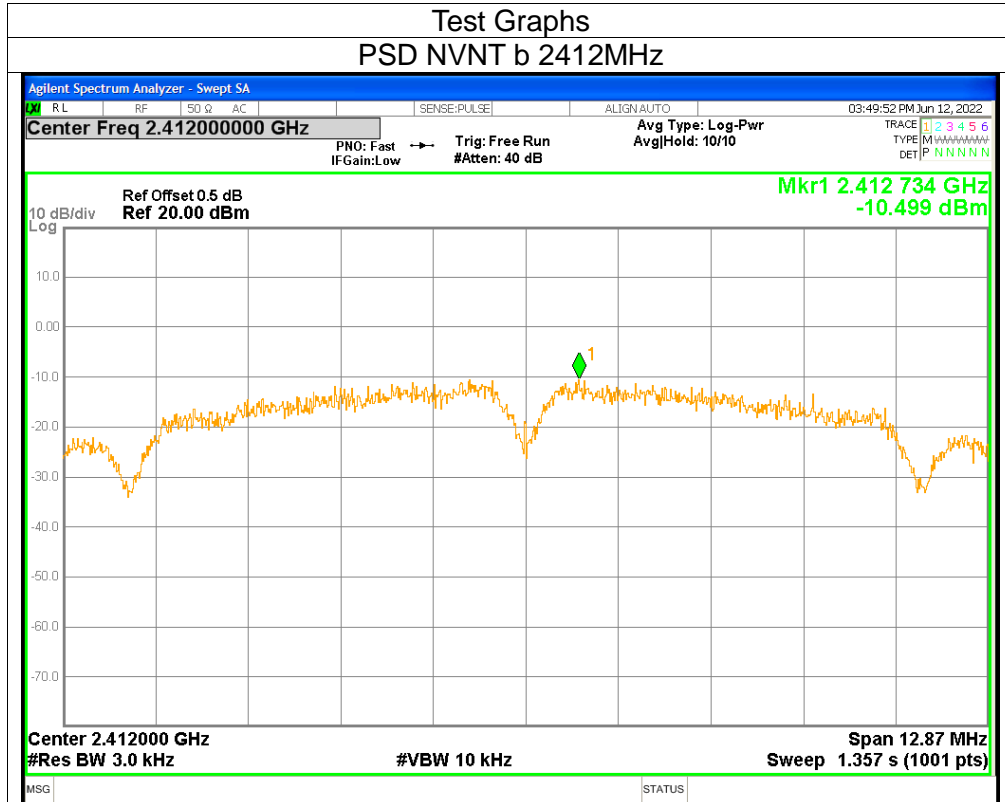

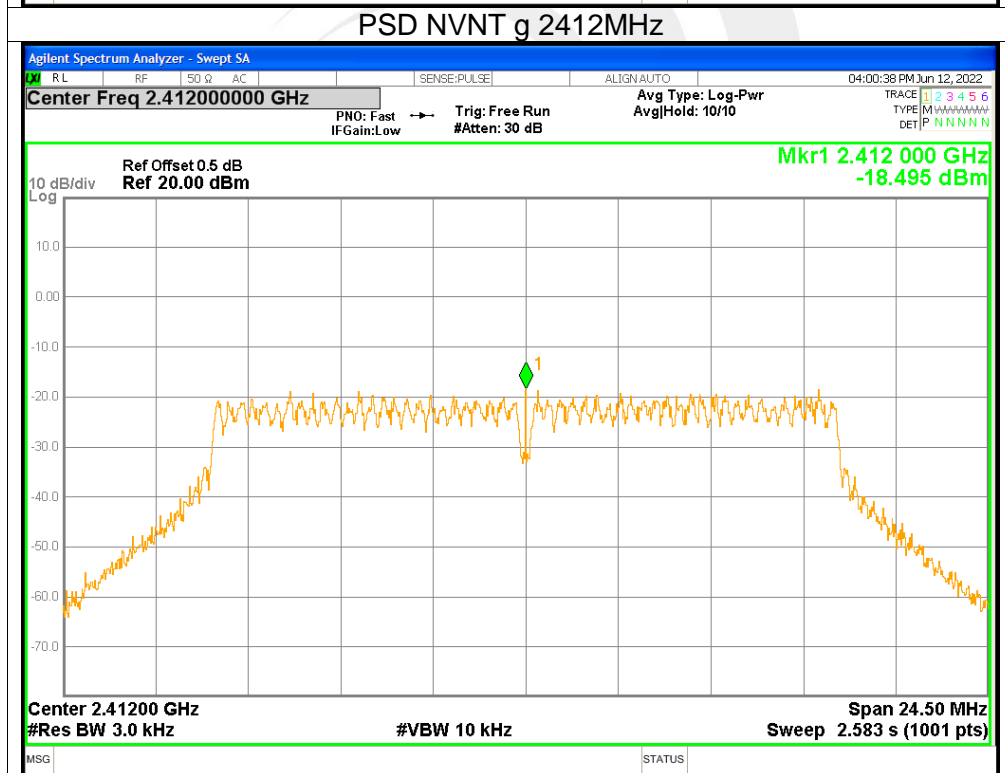
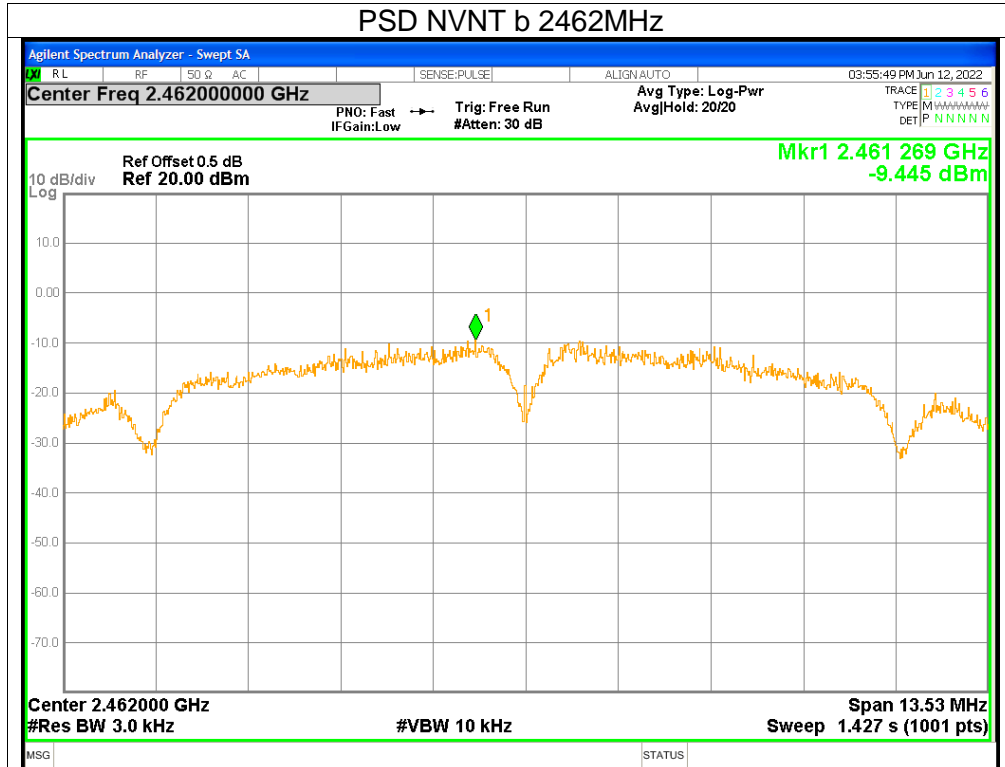

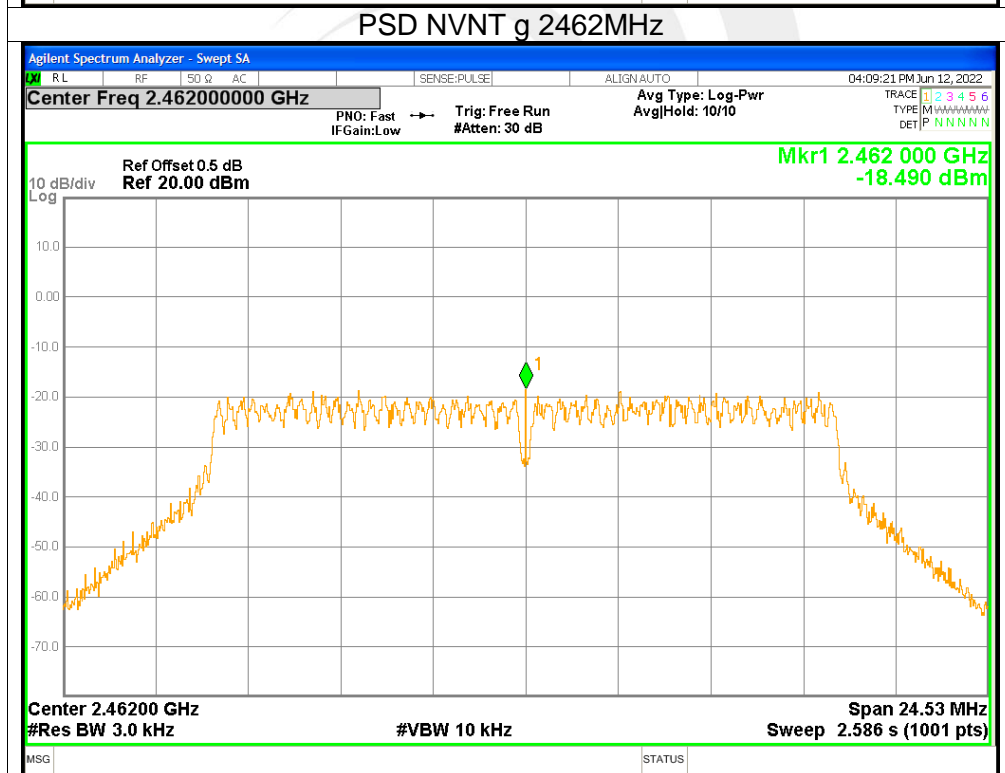
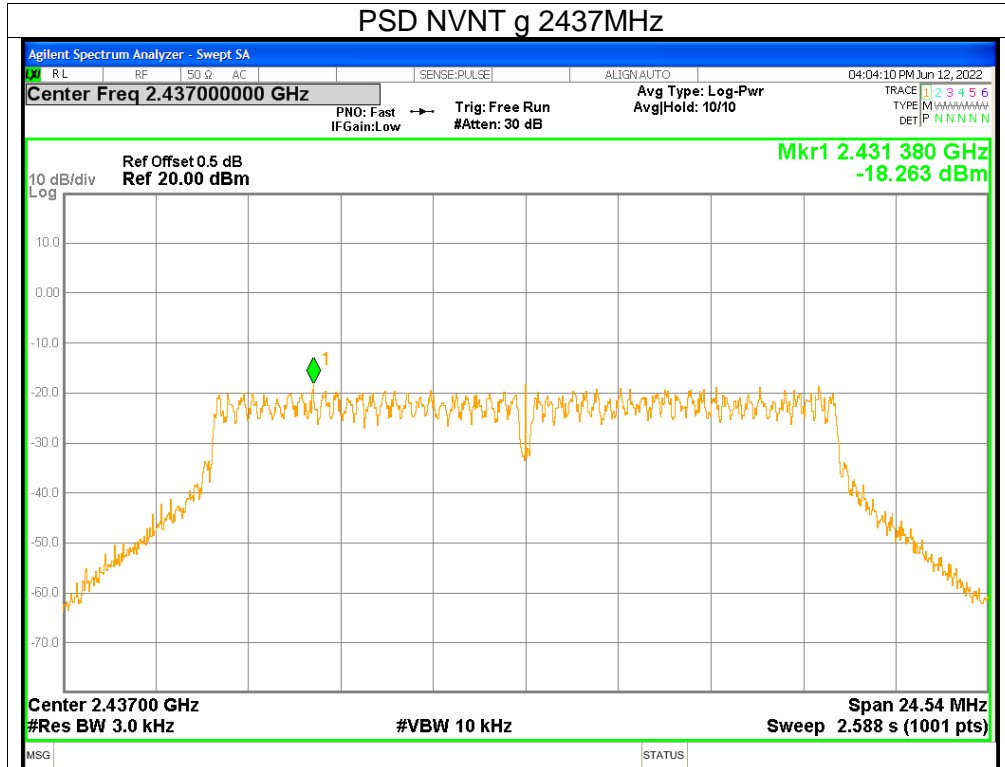

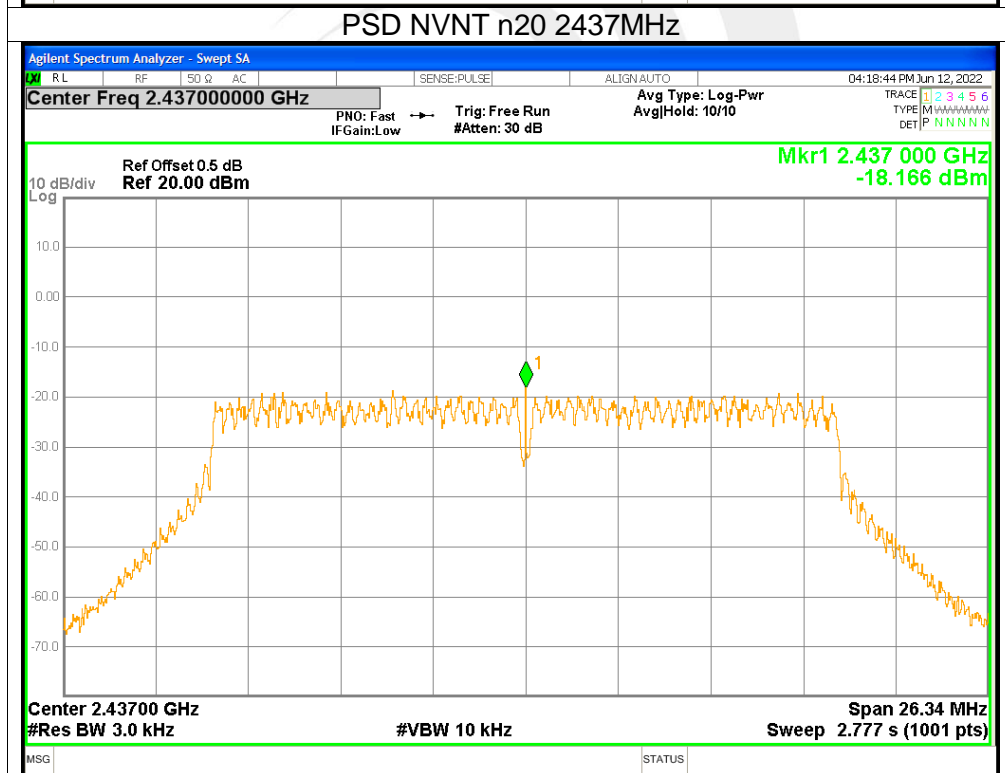
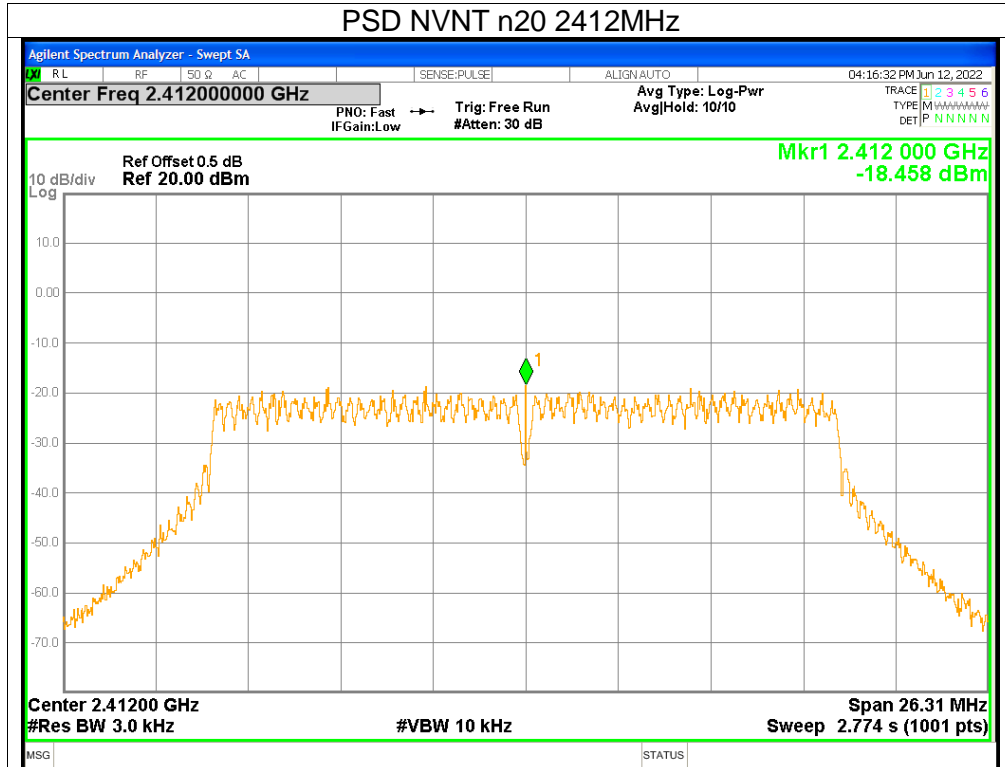

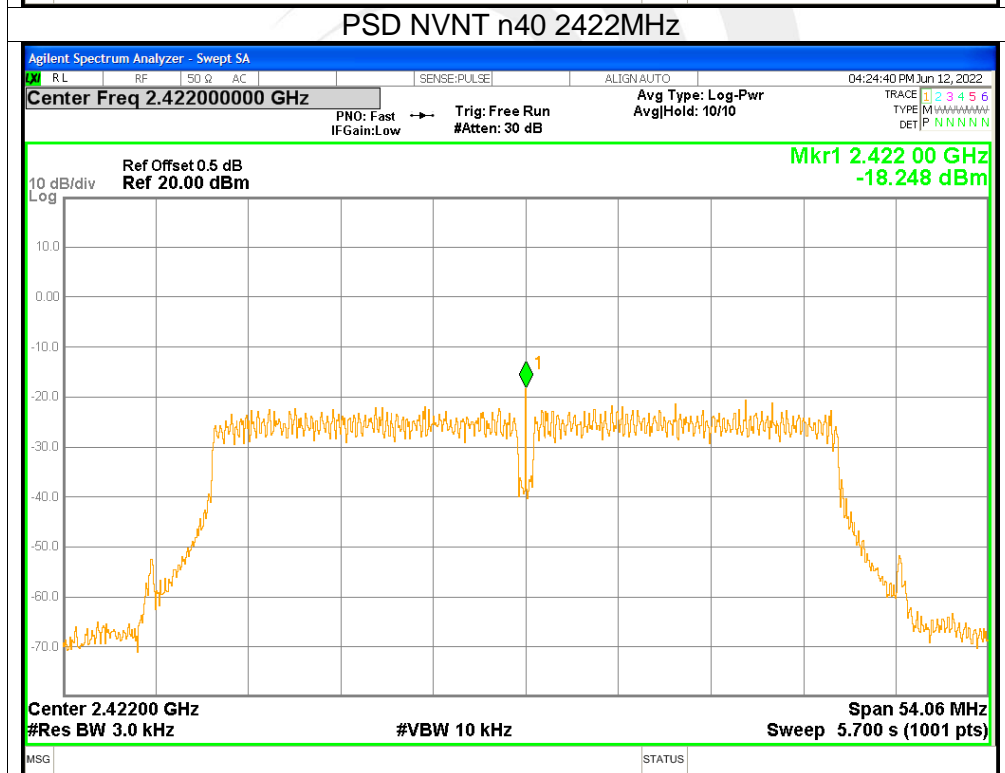
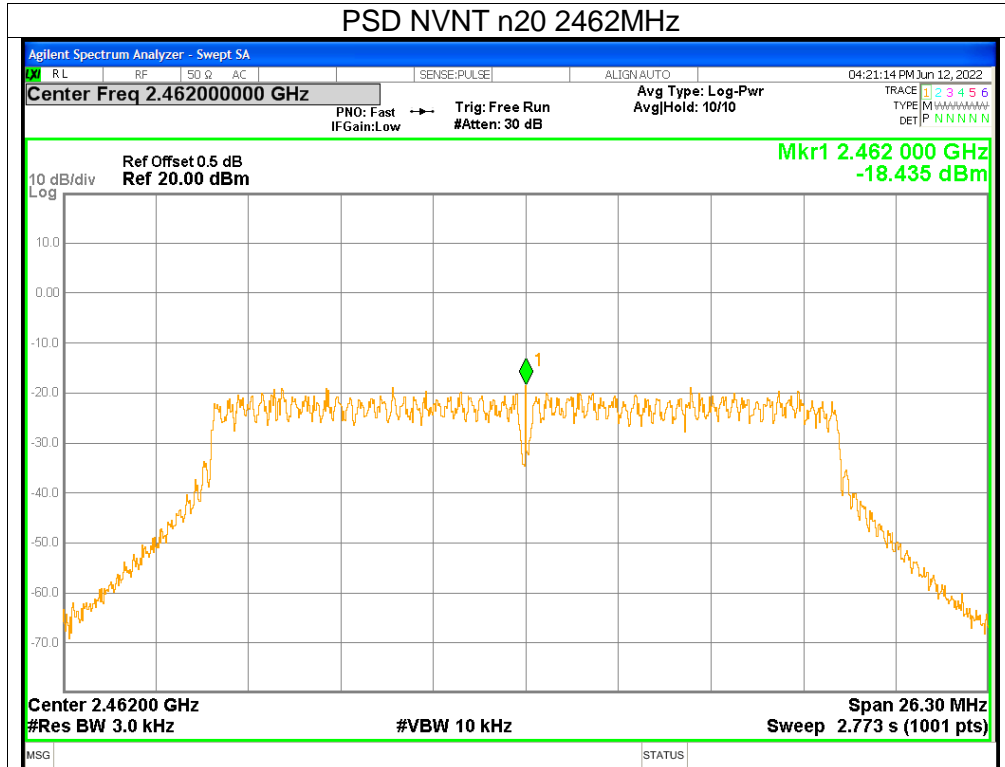

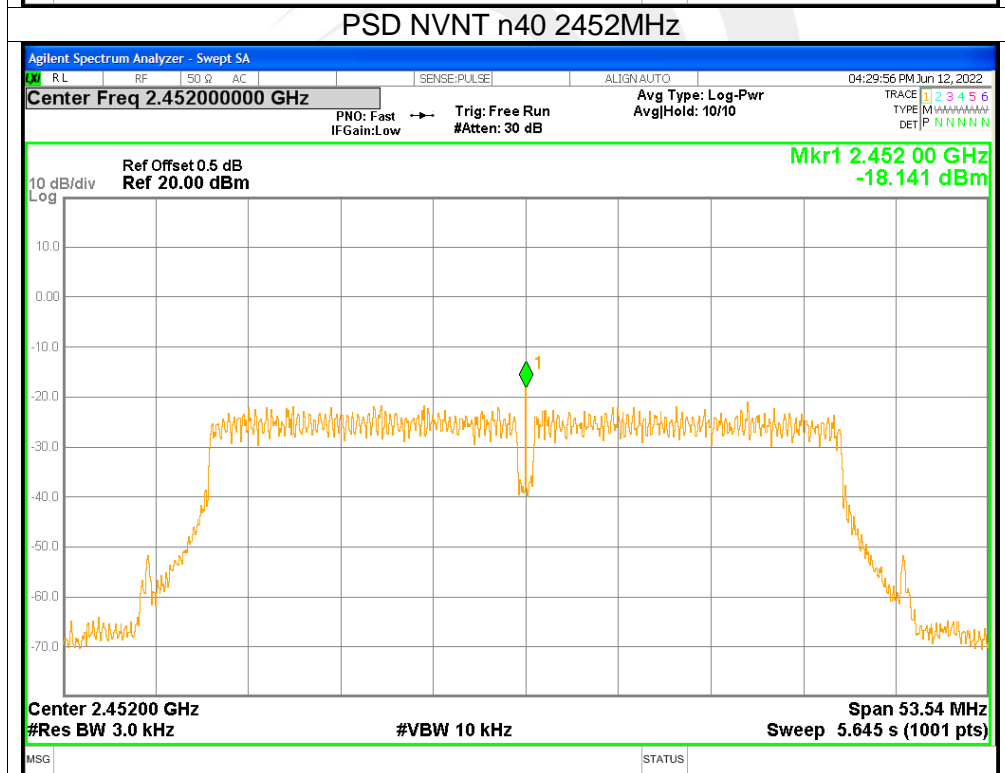
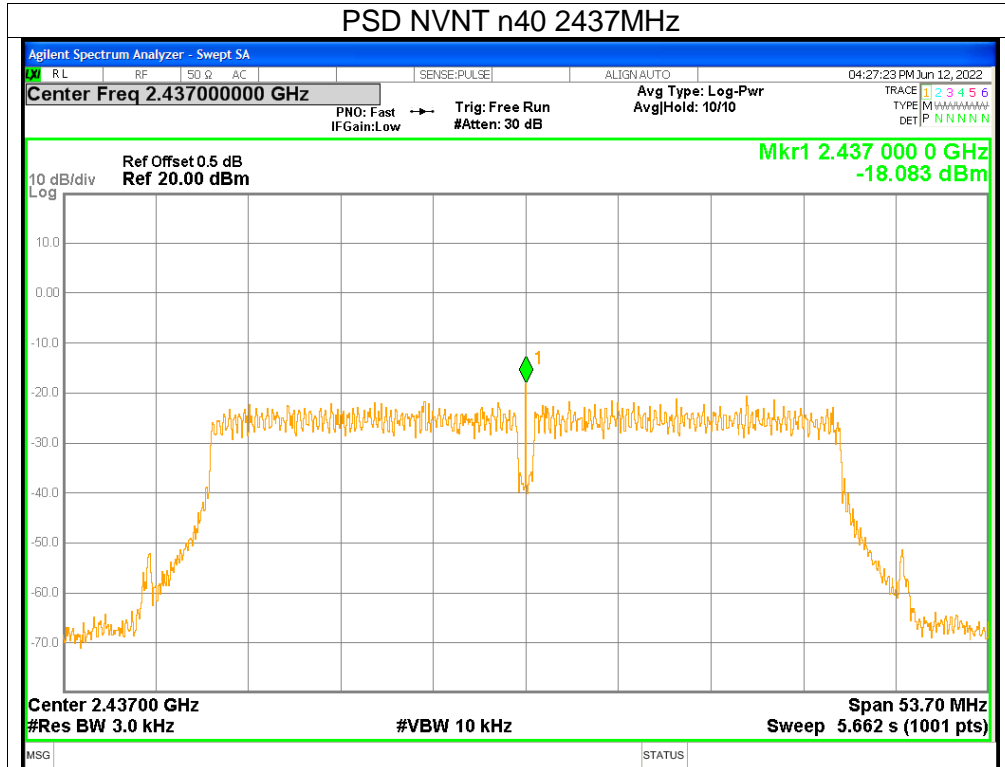



6. Band Edge

Condition	Mode	Frequency (MHz)	Max Value (dBc)	Limit (dBc)	Verdict
NVNT	b	2412	-52.24	<=-20	Pass
NVNT	b	2462	-60.68	<=-20	Pass
NVNT	g	2412	-39.75	<=-20	Pass
NVNT	g	2462	-51.59	<=-20	Pass
NVNT	n20	2412	-42	<=-20	Pass
NVNT	n20	2462	-52.34	<=-20	Pass
NVNT	n40	2422	-35.91	<=-20	Pass
NVNT	n40	2452	-46.02	<=-20	Pass





Test Graphs

Band Edge NVNT b 2412MHz Ref

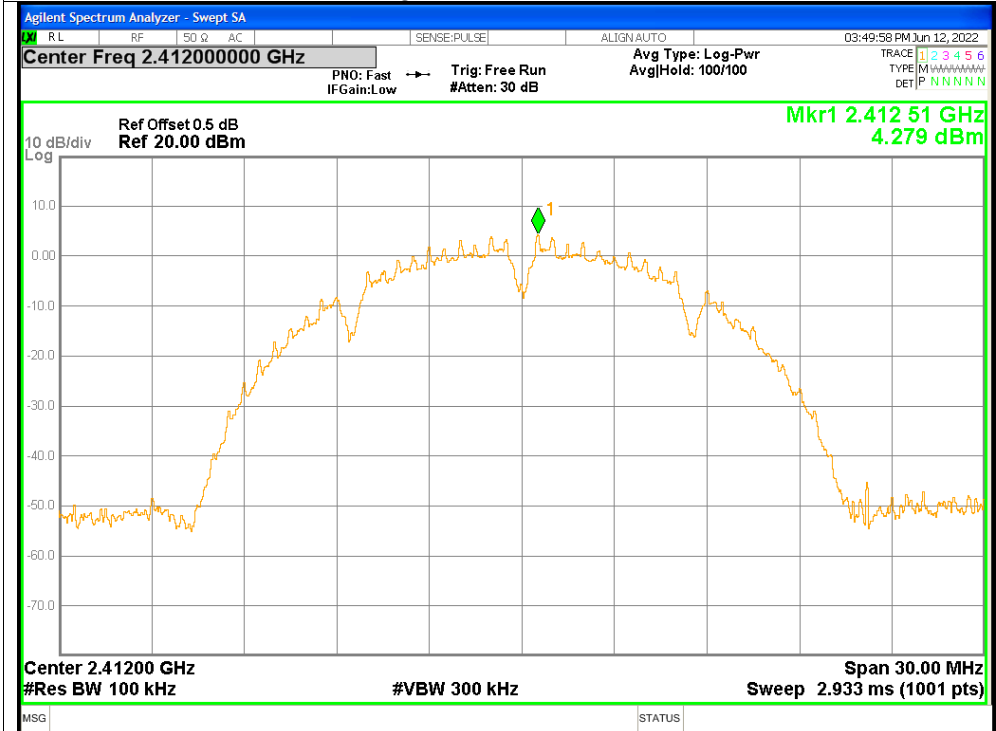

Band Edge NVNT b 2412MHz Emission

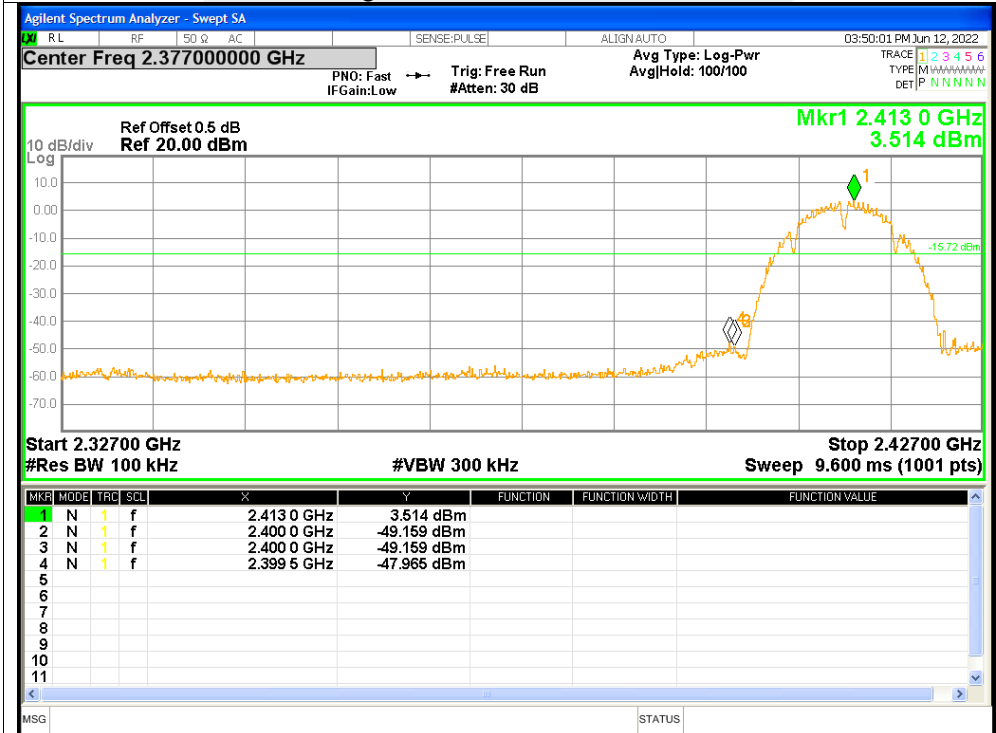

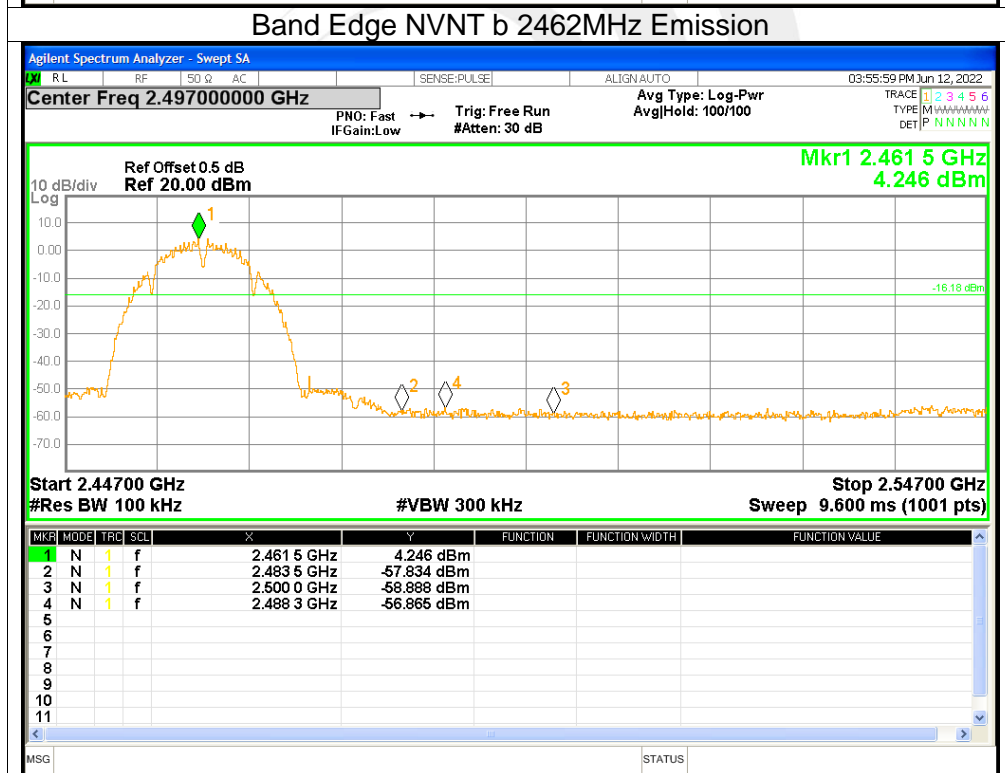
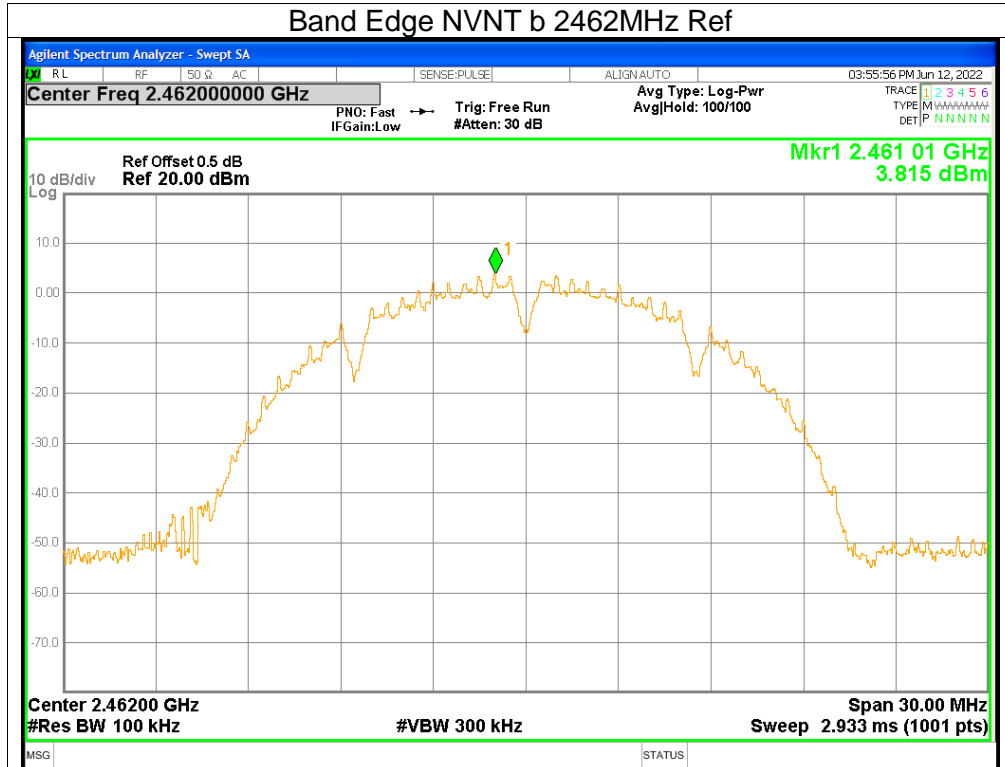

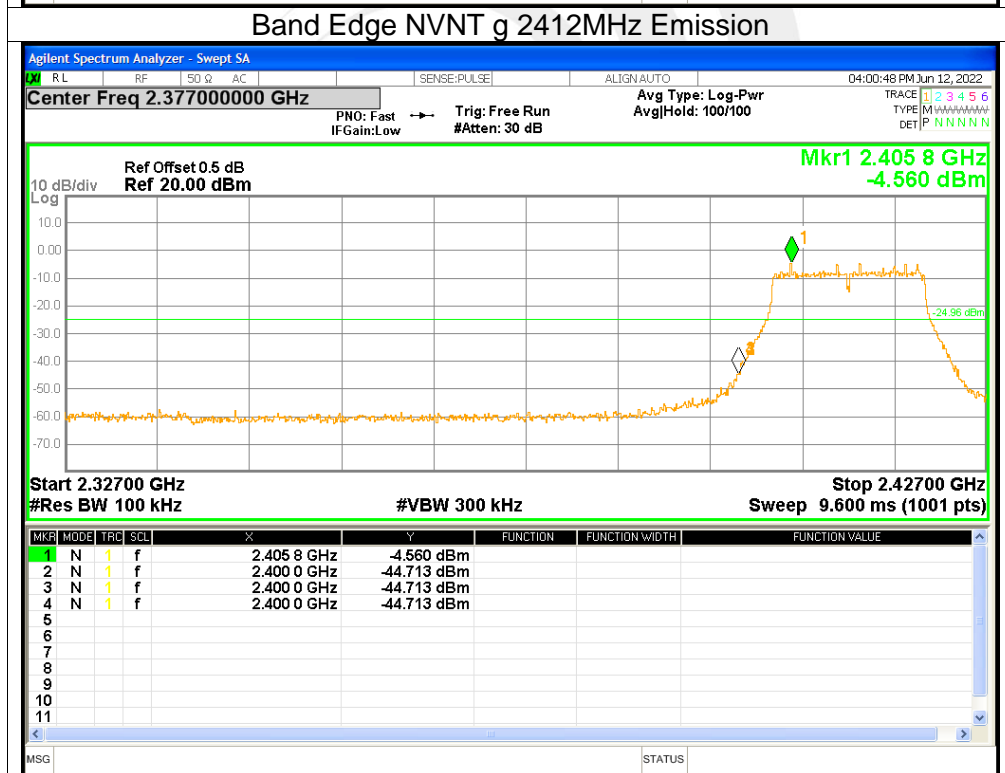
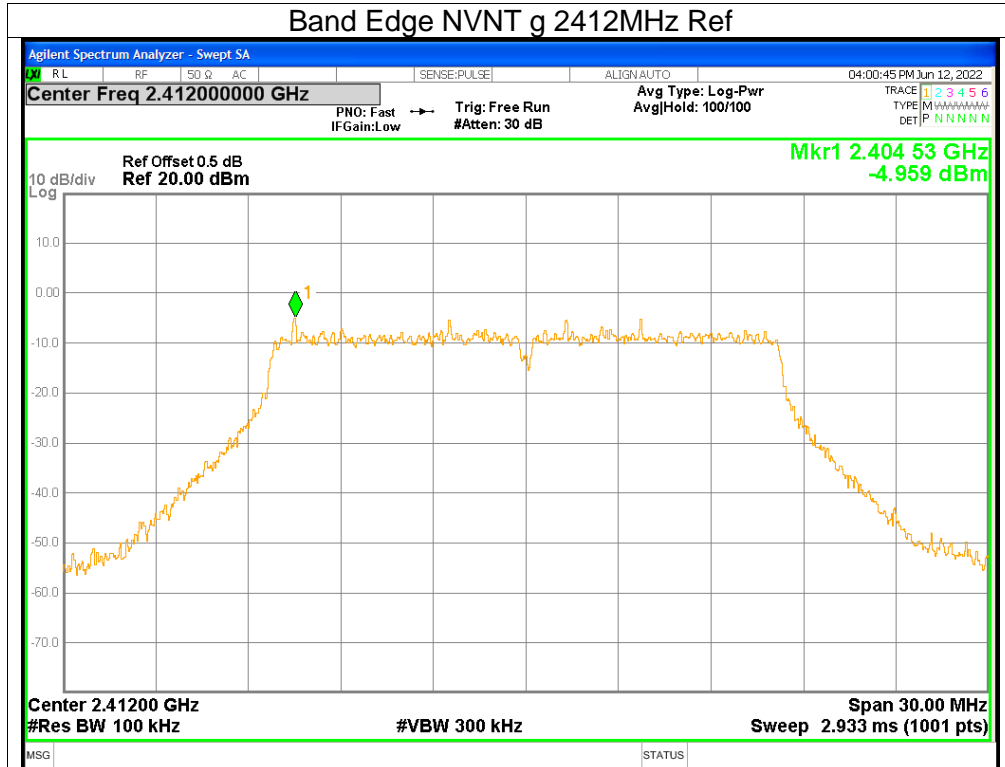

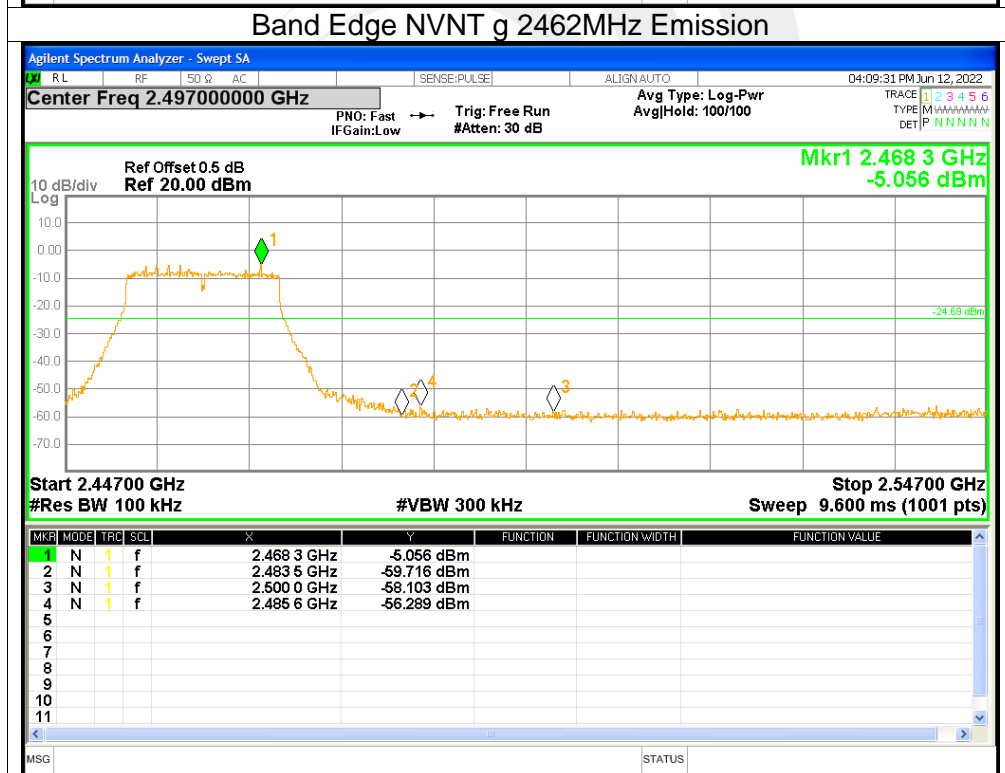
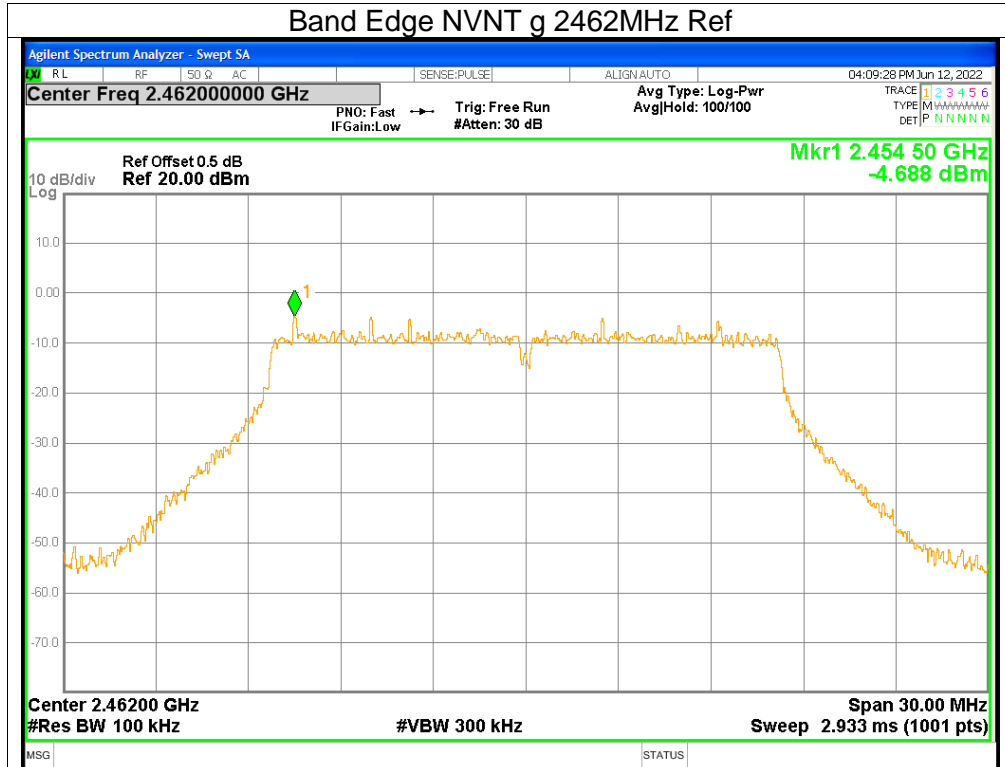

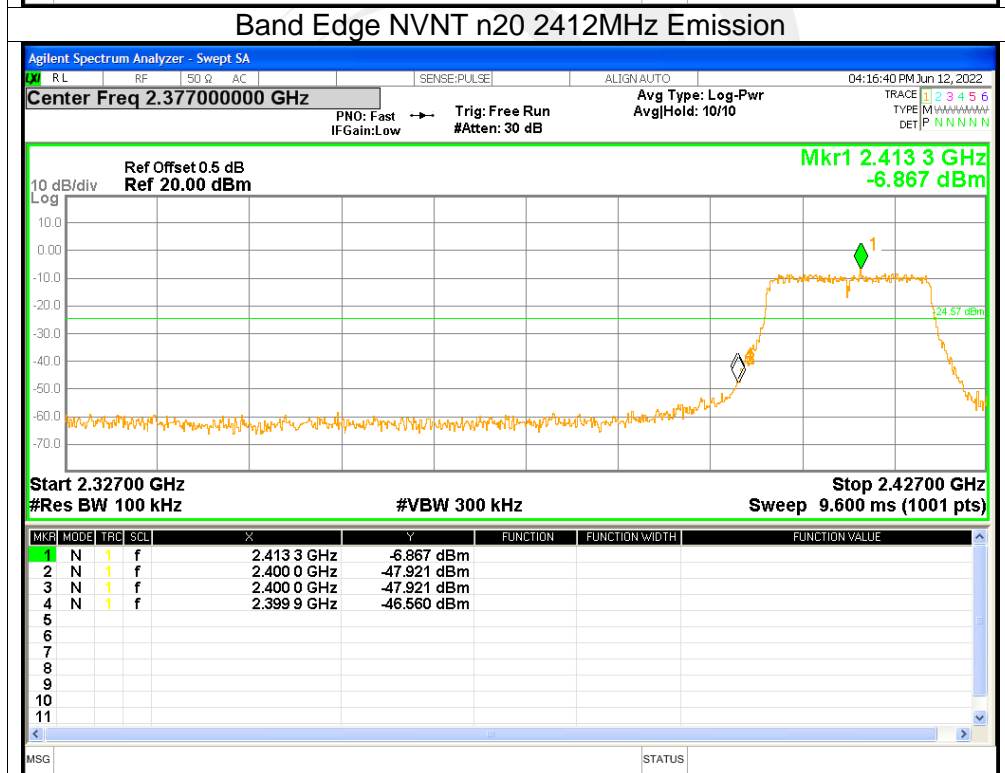
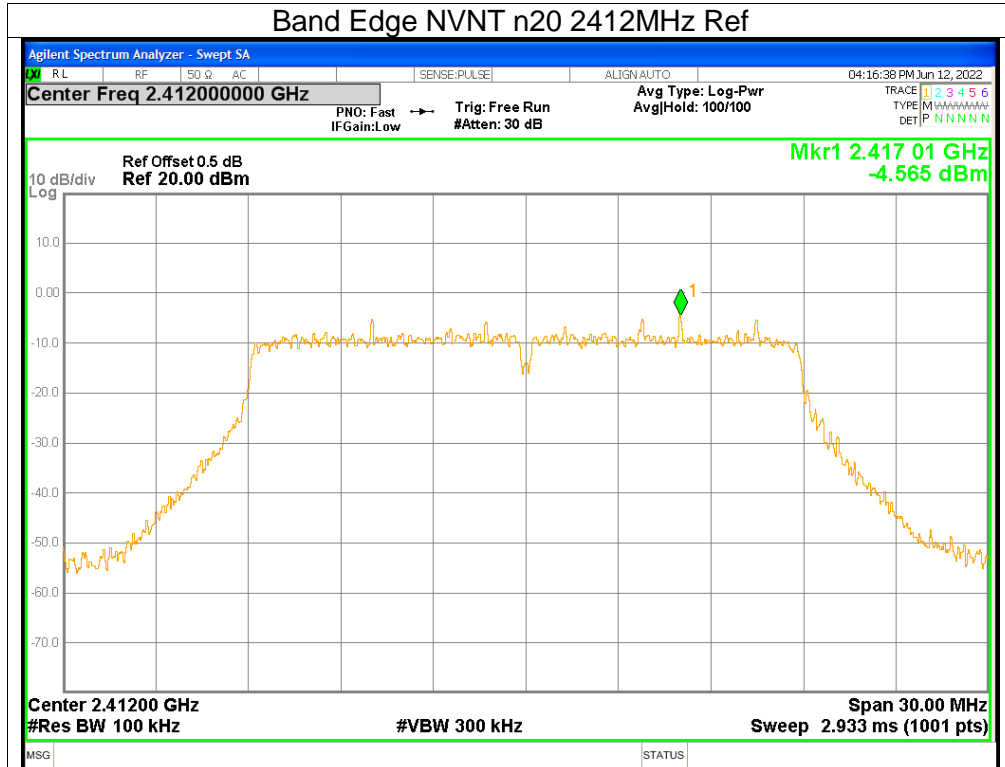

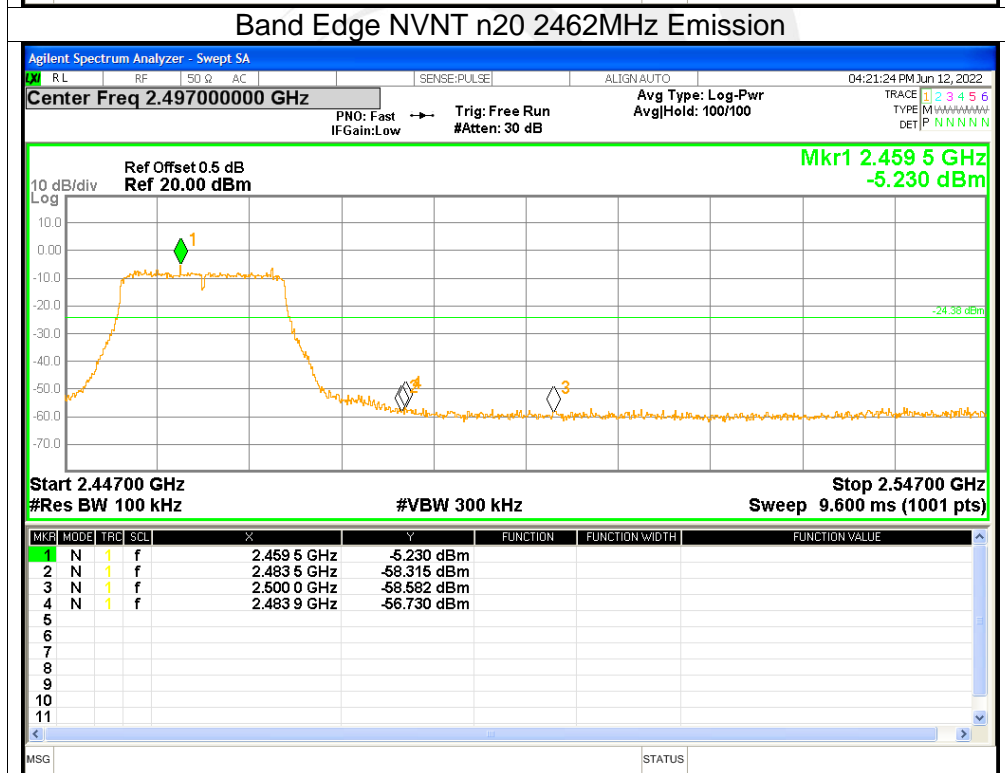
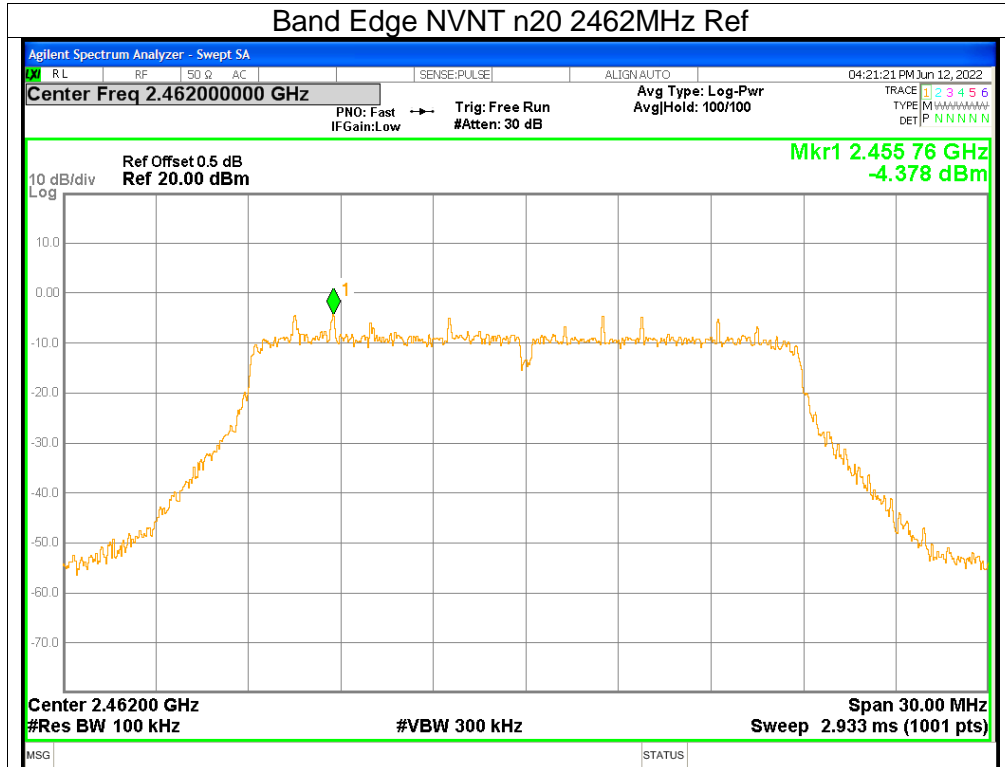

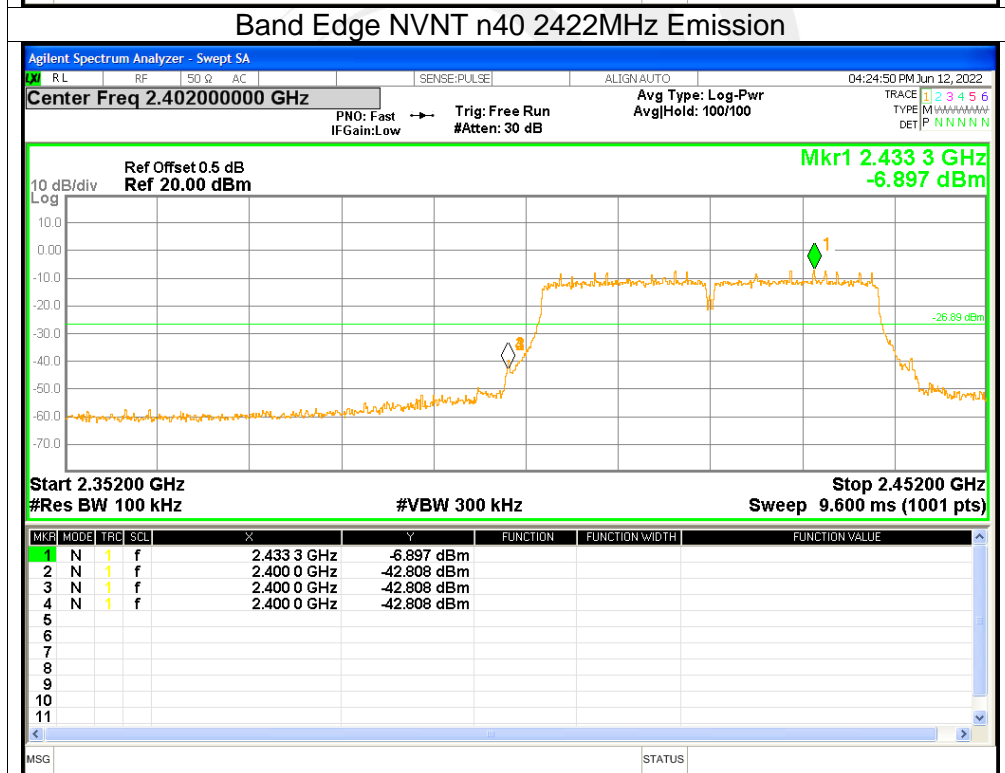
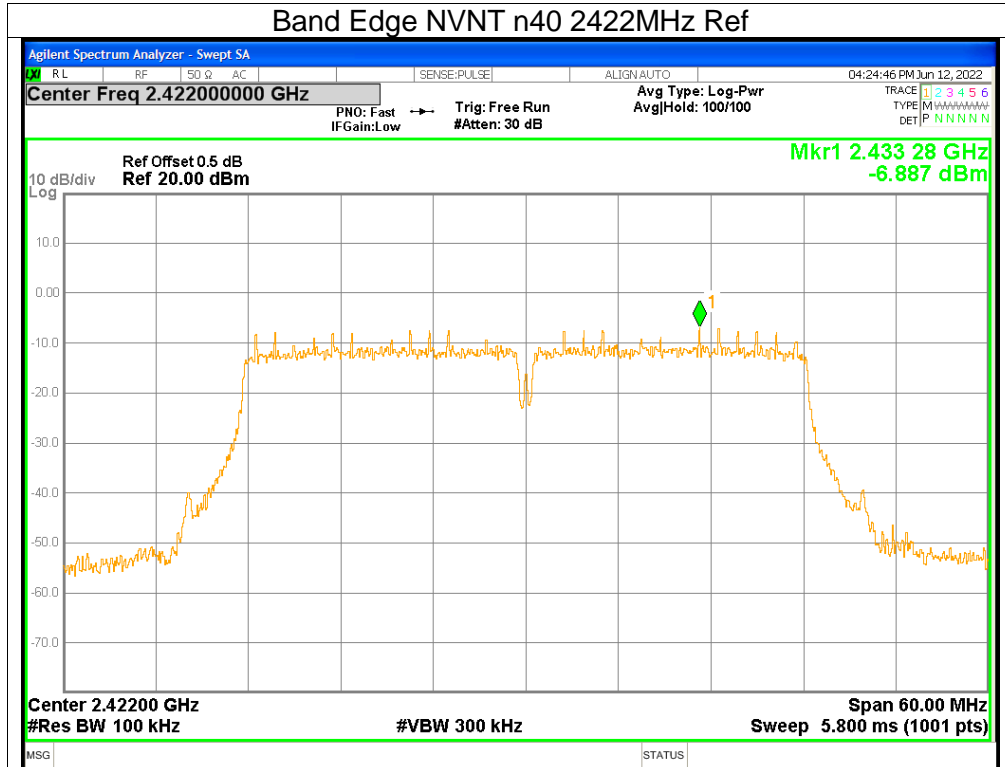

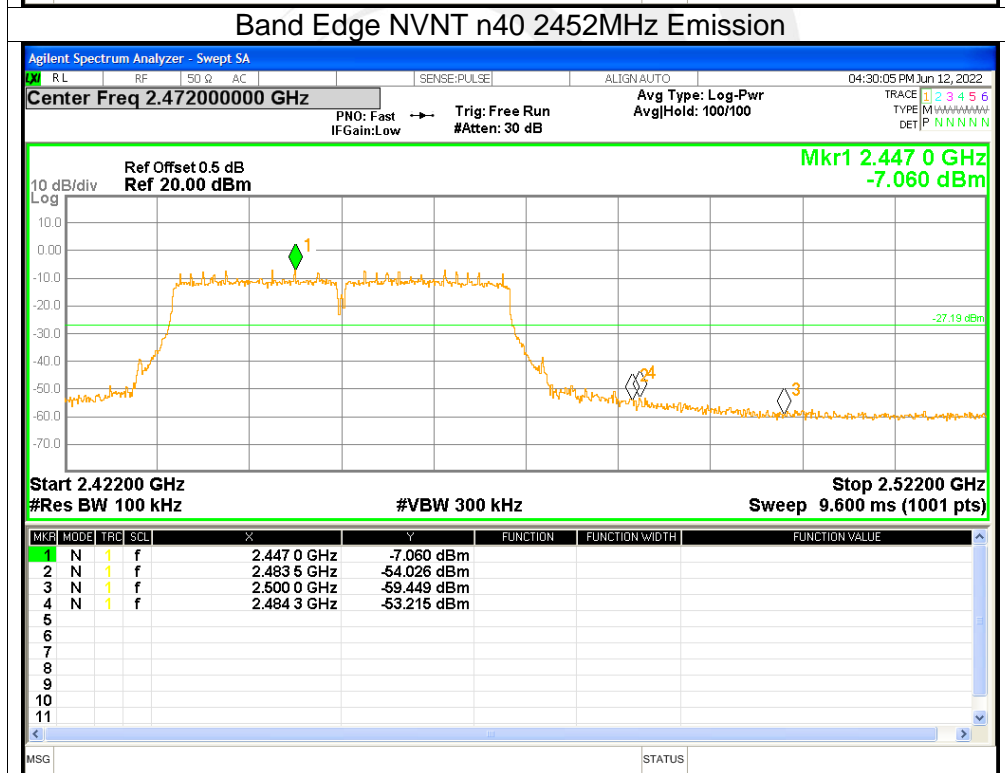
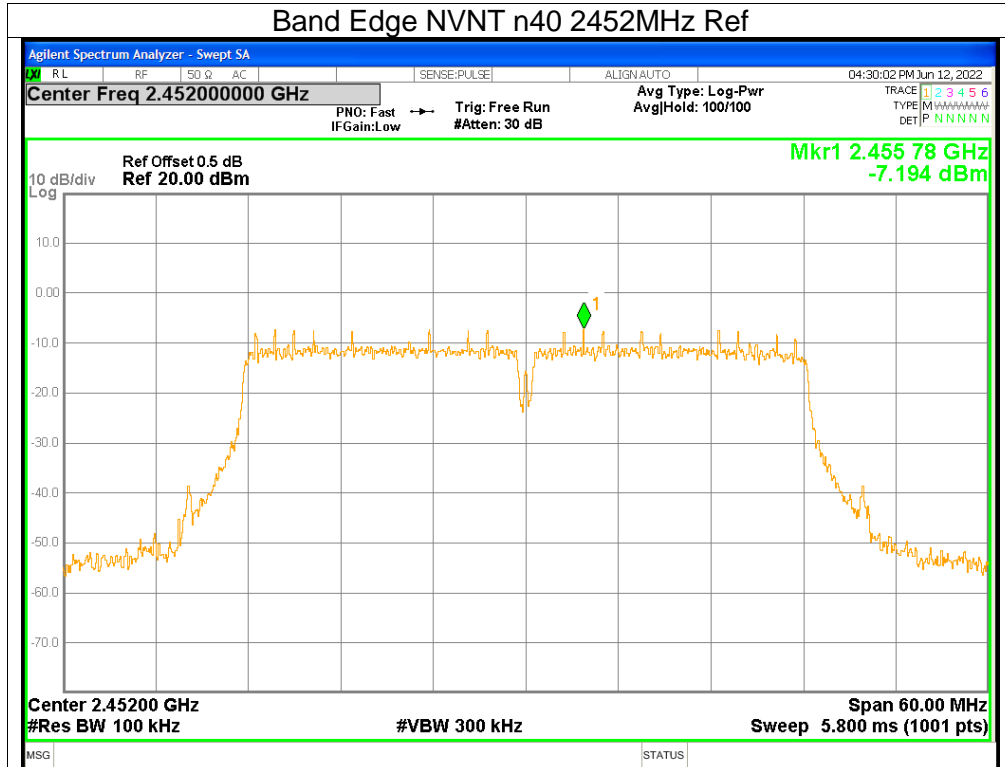



7. Conducted RF Spurious Emission

Condition	Mode	Frequency (MHz)	Max Value (dBc)	Limit (dBc)	Verdict
NVNT	b	2412	-51.02	<=-20	Pass
NVNT	b	2437	-50.61	<=-20	Pass
NVNT	b	2462	-50.57	<=-20	Pass
NVNT	g	2412	-41.56	<=-20	Pass
NVNT	g	2437	-42.42	<=-20	Pass
NVNT	g	2462	-42.24	<=-20	Pass
NVNT	n20	2412	-41.74	<=-20	Pass
NVNT	n20	2437	-42.56	<=-20	Pass
NVNT	n20	2462	-42.29	<=-20	Pass
NVNT	n40	2422	-39.79	<=-20	Pass
NVNT	n40	2437	-39.95	<=-20	Pass
NVNT	n40	2452	-40.58	<=-20	Pass





Test Graphs

Tx. Spurious NVNT b 2412MHz Ref

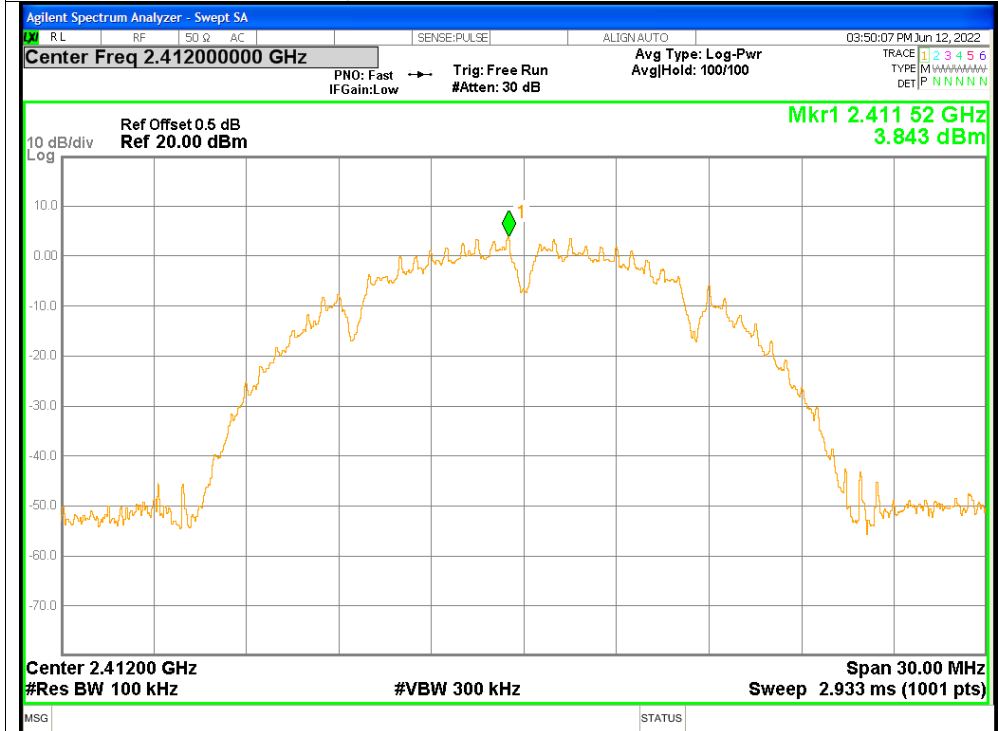

Tx. Spurious NVNT b 2412MHz Emission

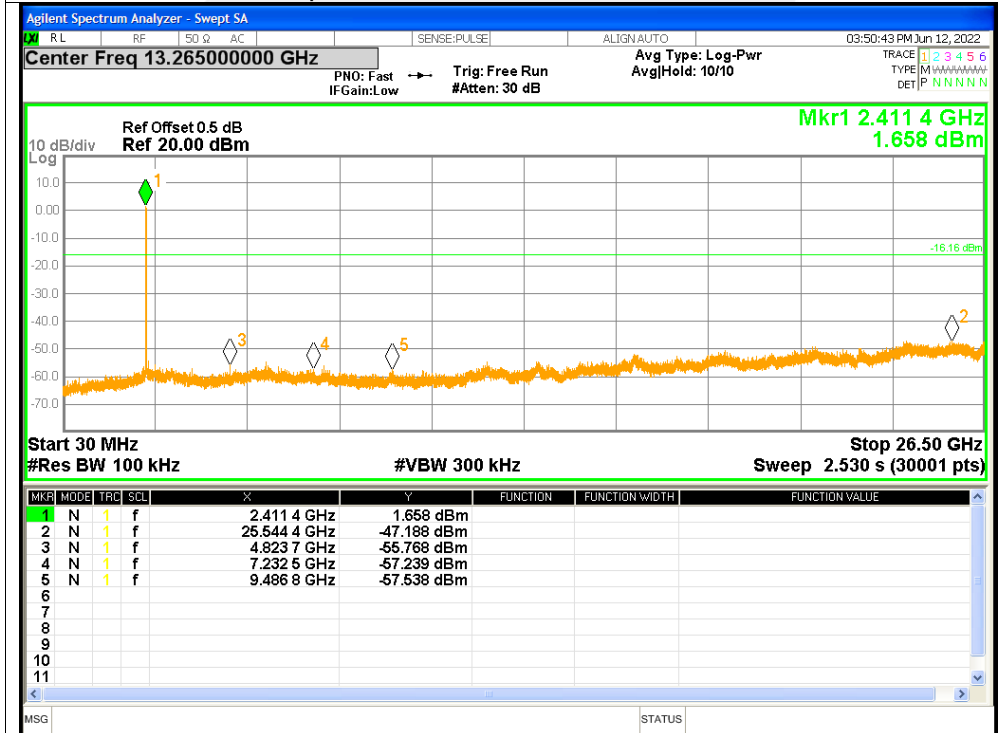

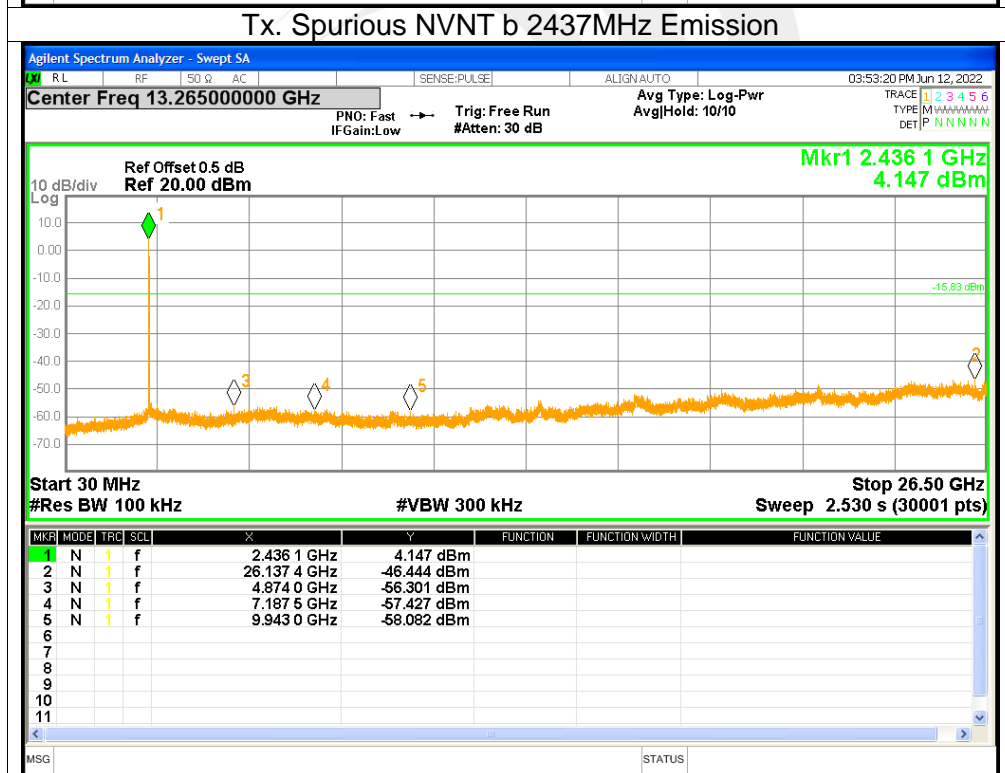
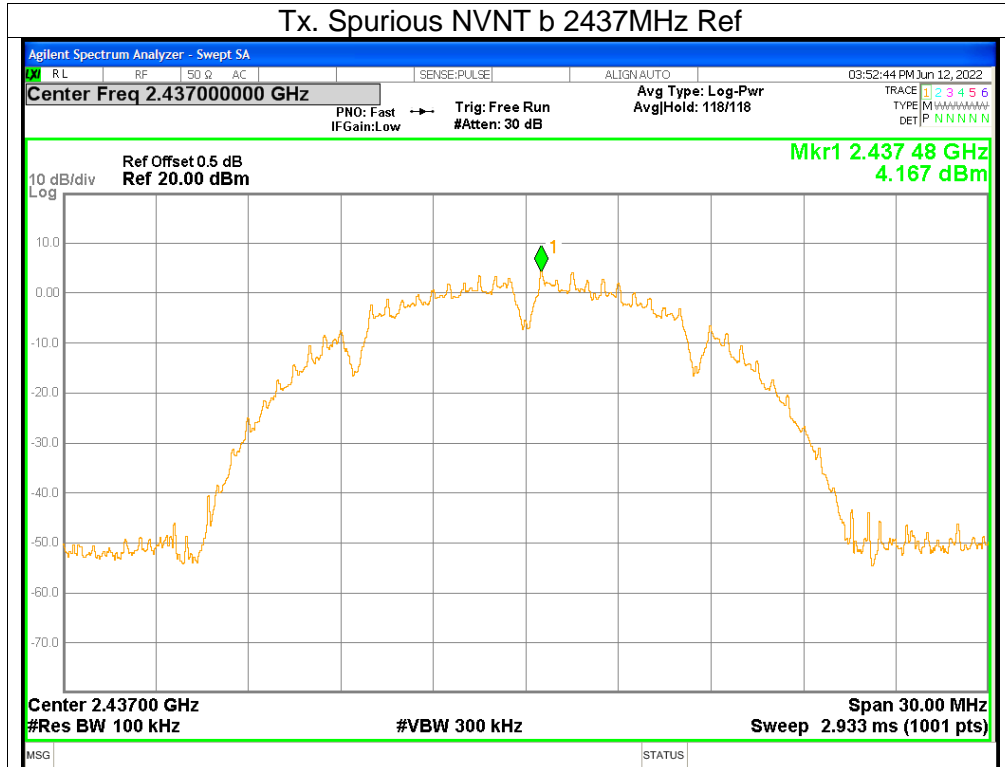

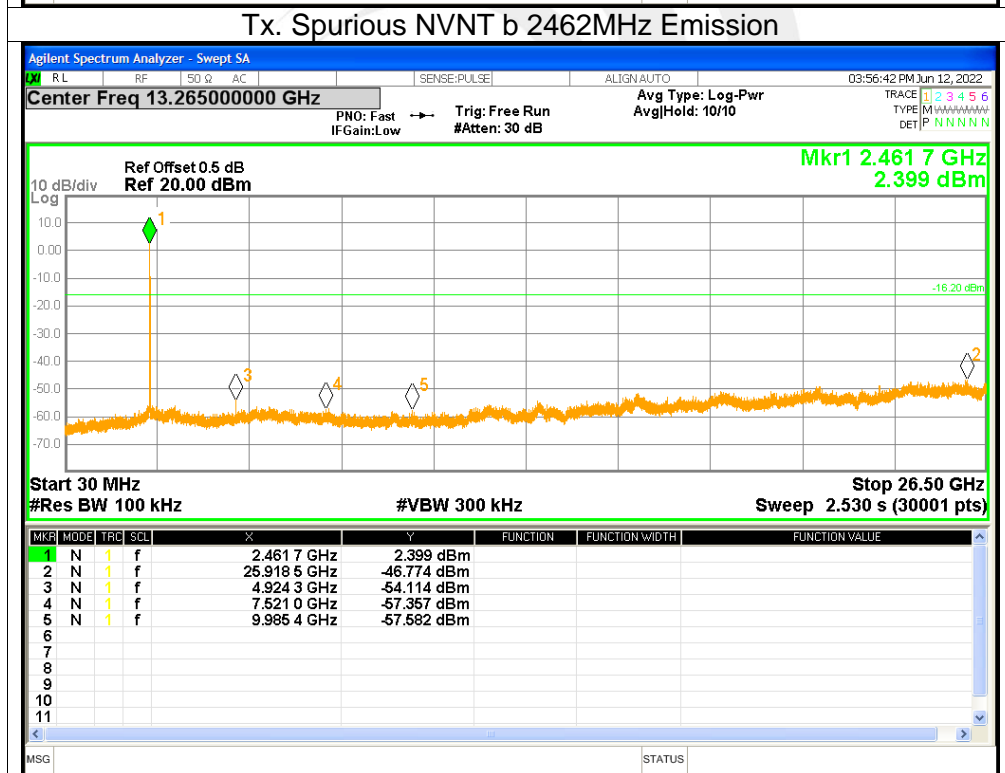
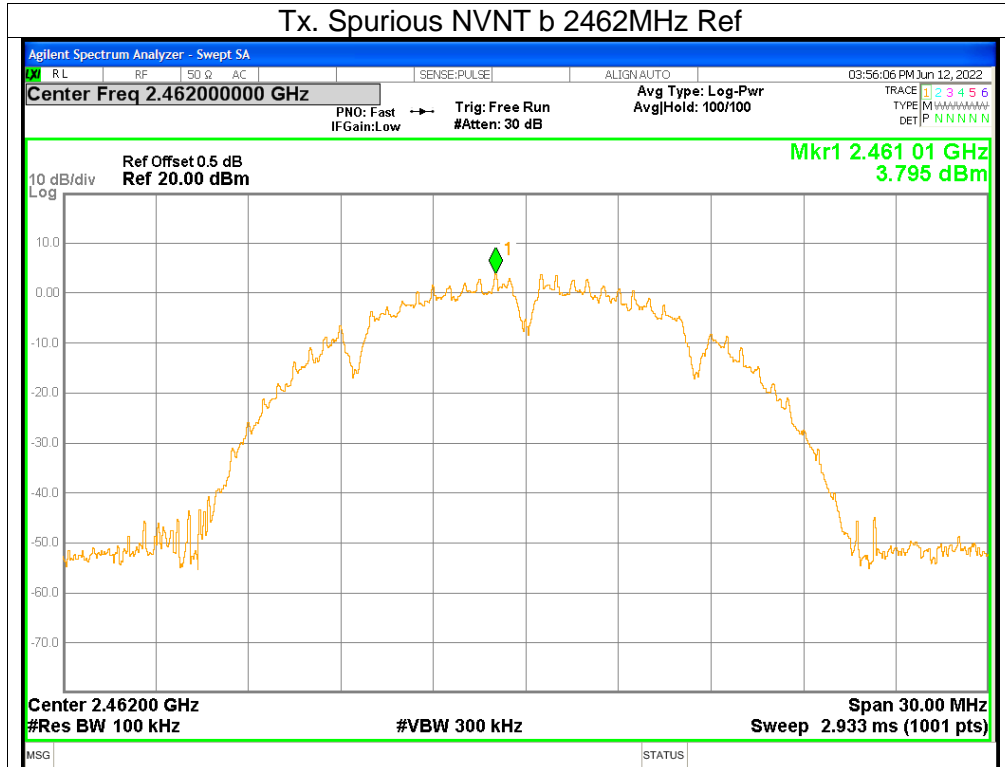



Tx. Spurious NVNT g 2412MHz Ref

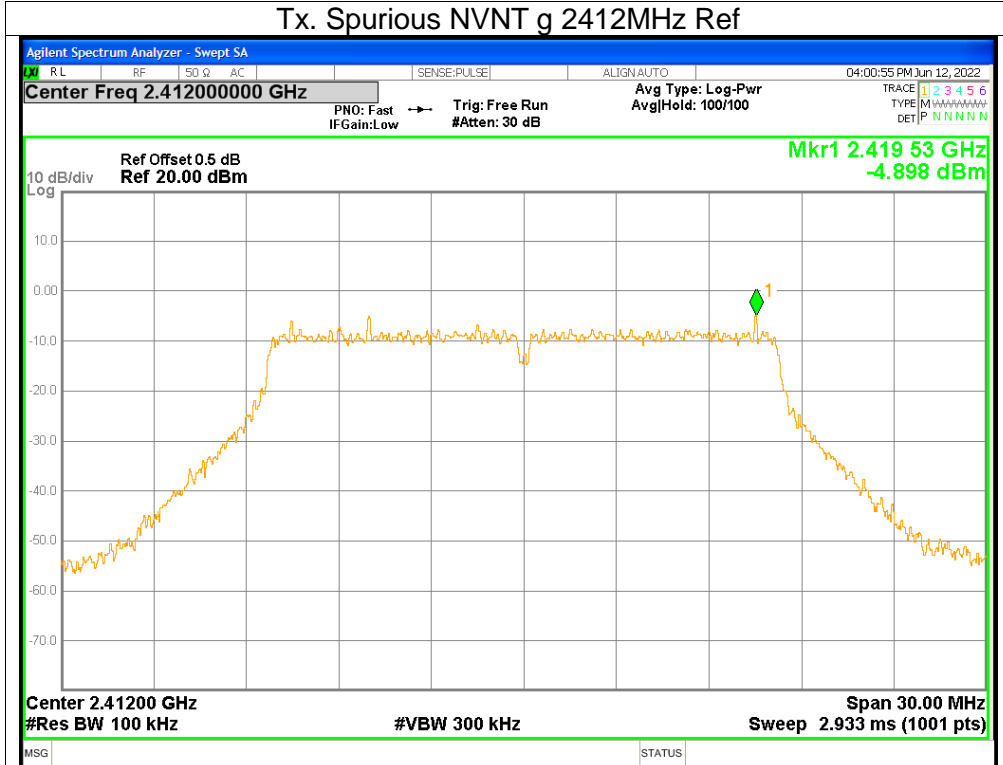

Tx. Spurious NVNT g 2412MHz Emission

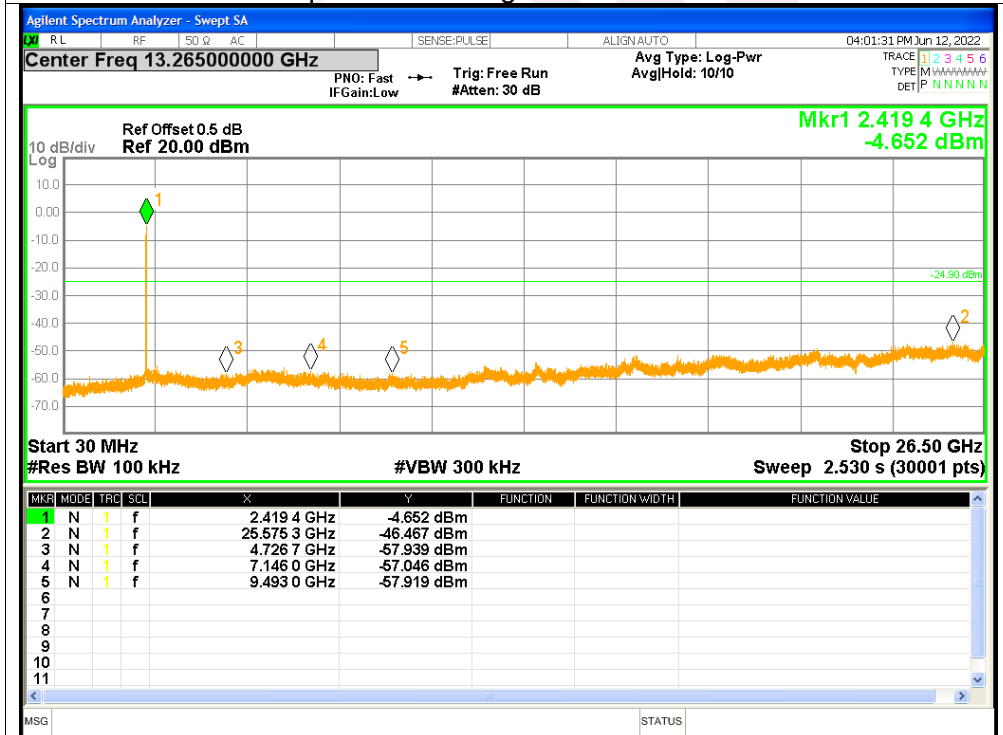



Tx. Spurious NVNT g 2437MHz Ref

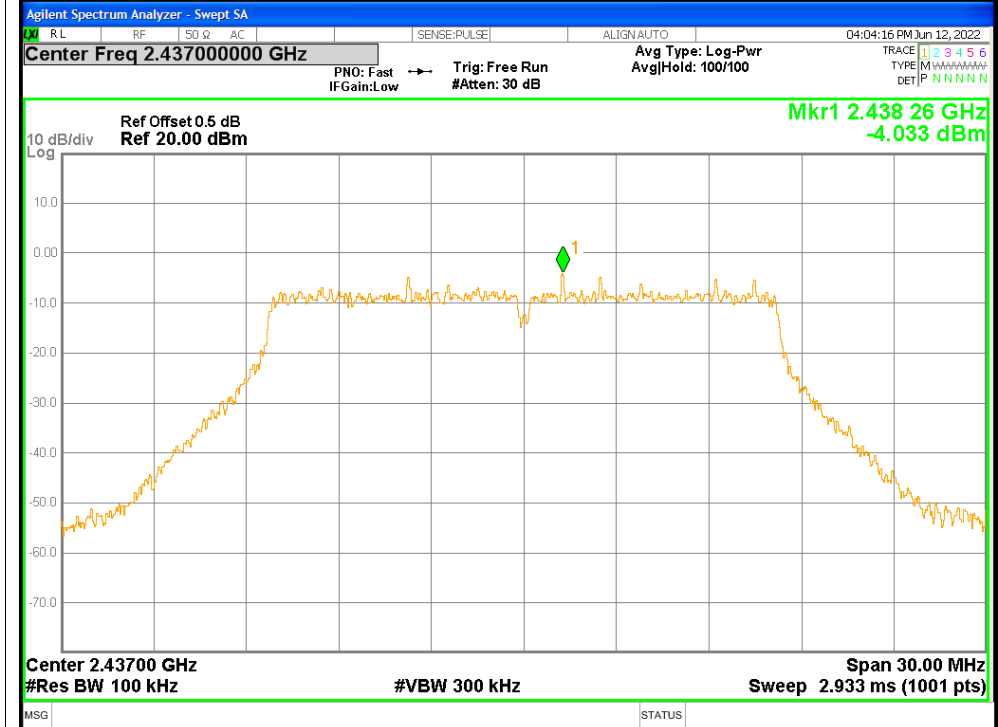

Tx. Spurious NVNT g 2437MHz Emission

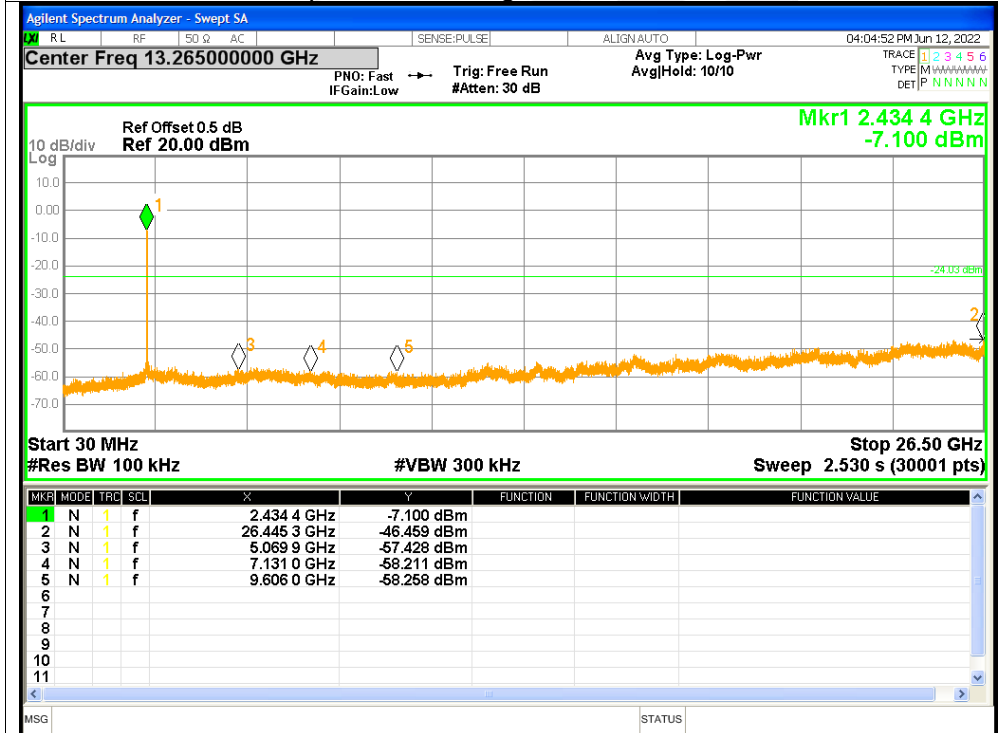



Tx. Spurious NVNT g 2462MHz Ref

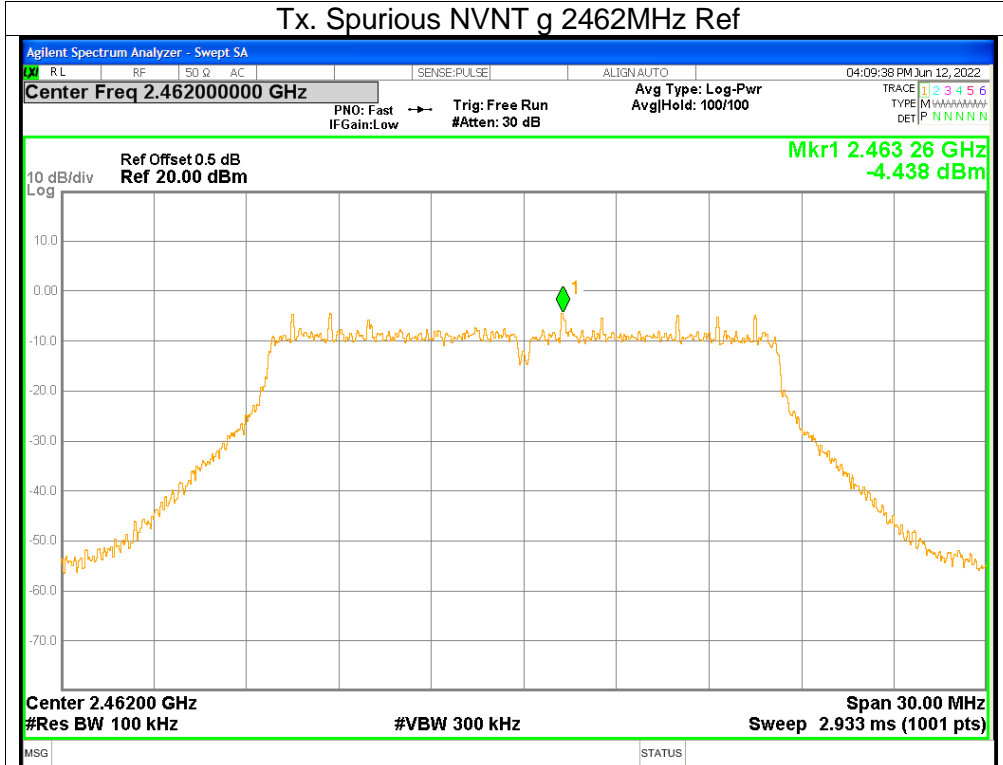

Tx. Spurious NVNT g 2462MHz Emission

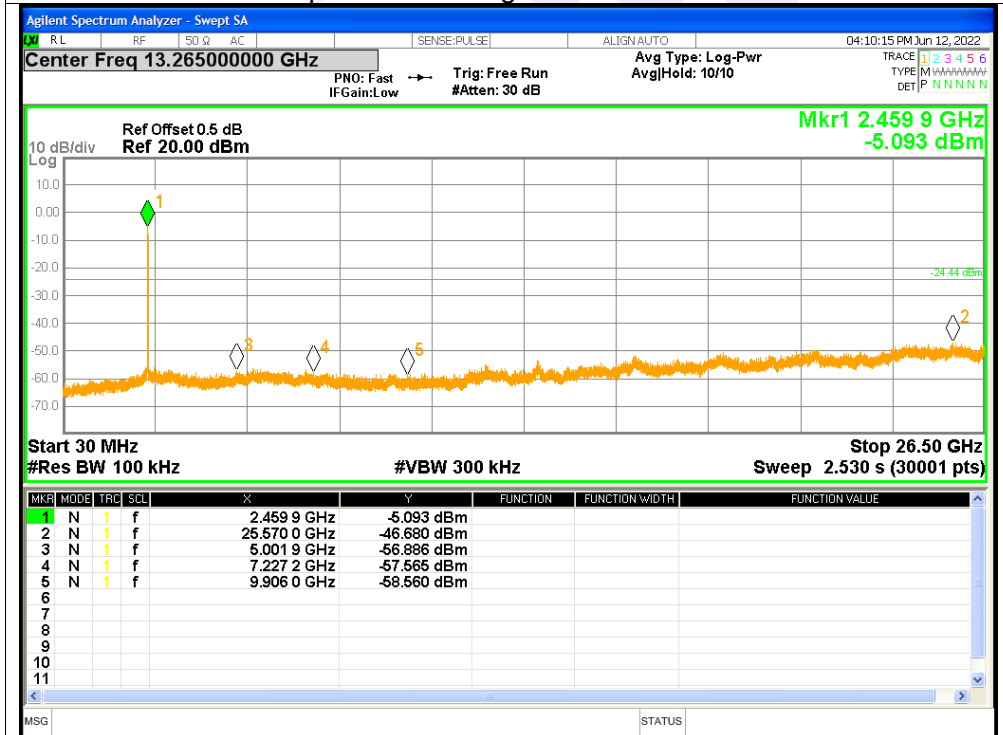



Tx. Spurious NVNT n20 2412MHz Ref

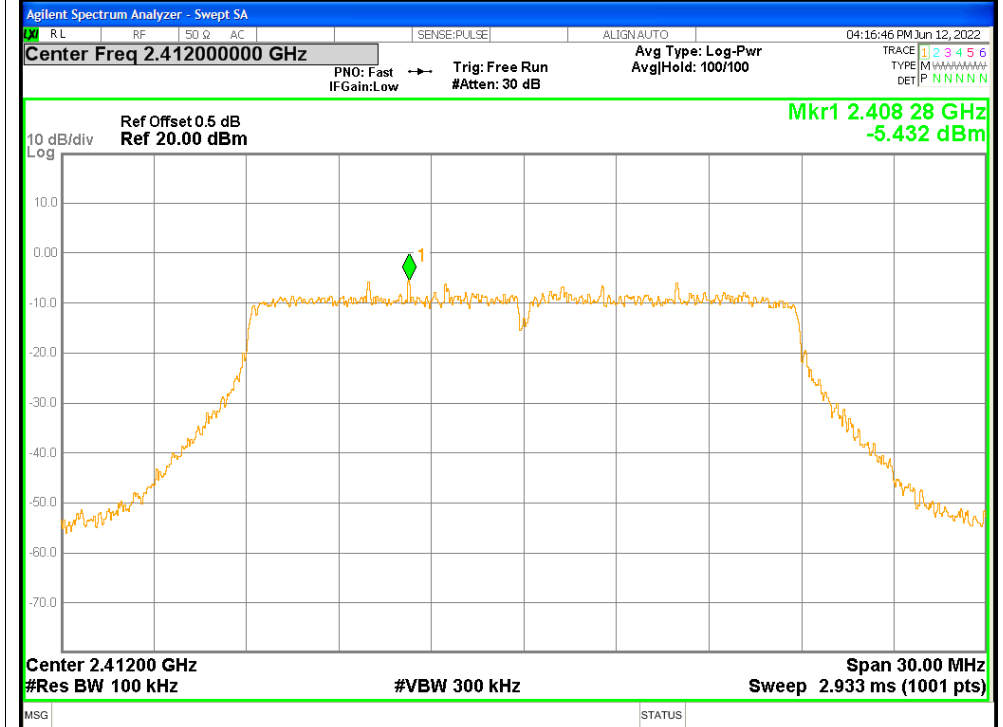

Tx. Spurious NVNT n20 2412MHz Emission

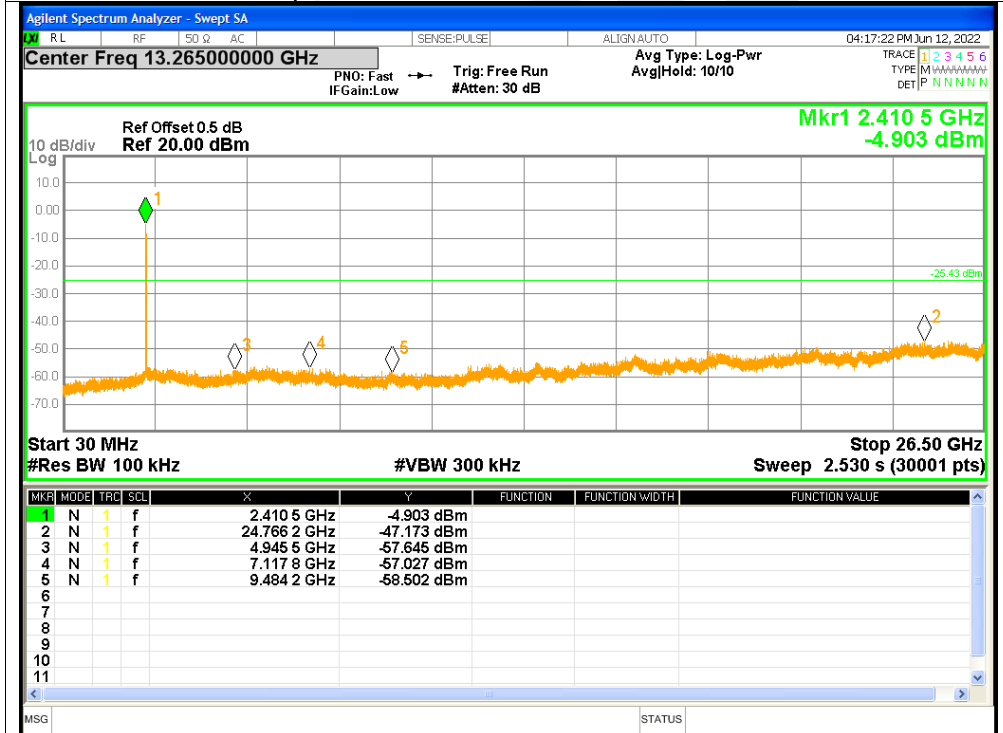



Tx. Spurious NVNT n20 2437MHz Ref

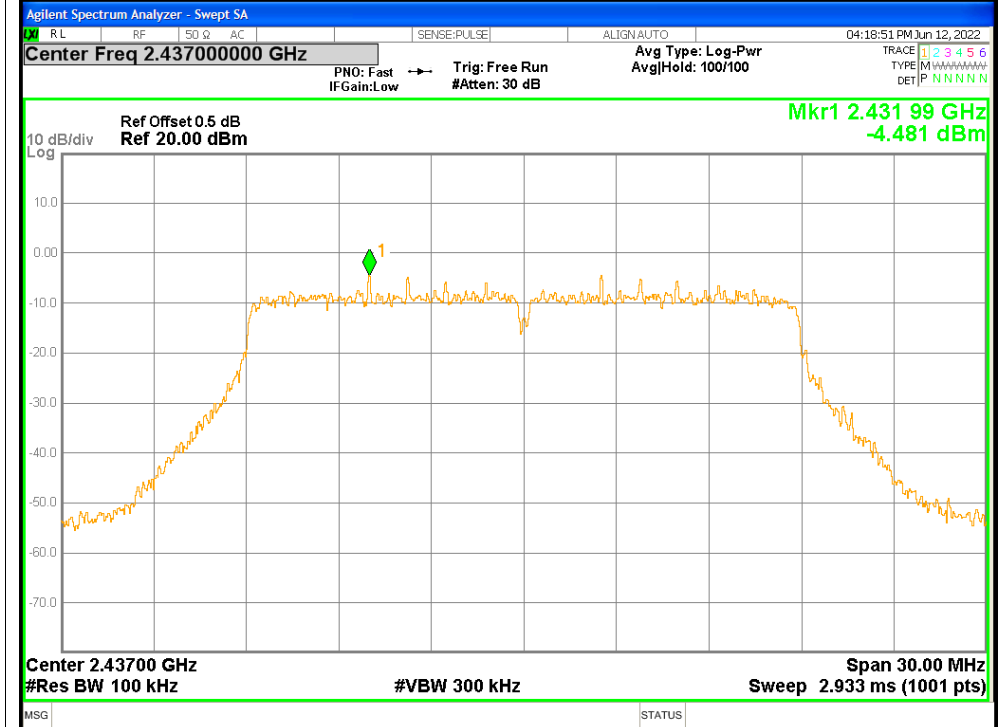

Tx. Spurious NVNT n20 2437MHz Emission

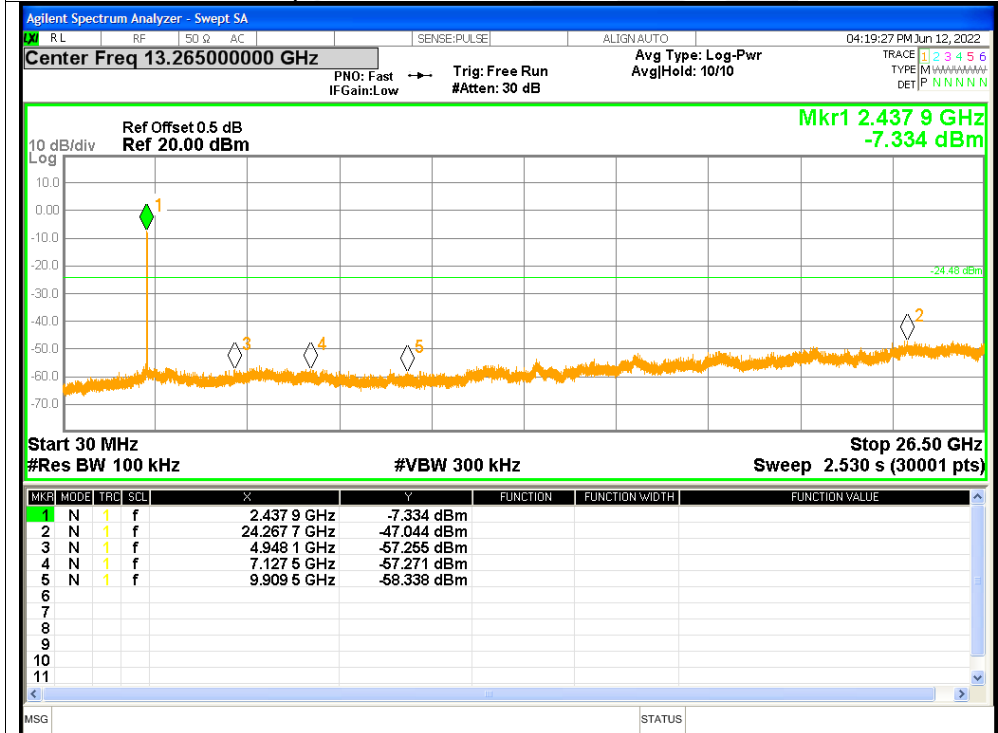



Tx. Spurious NVNT n20 2462MHz Ref

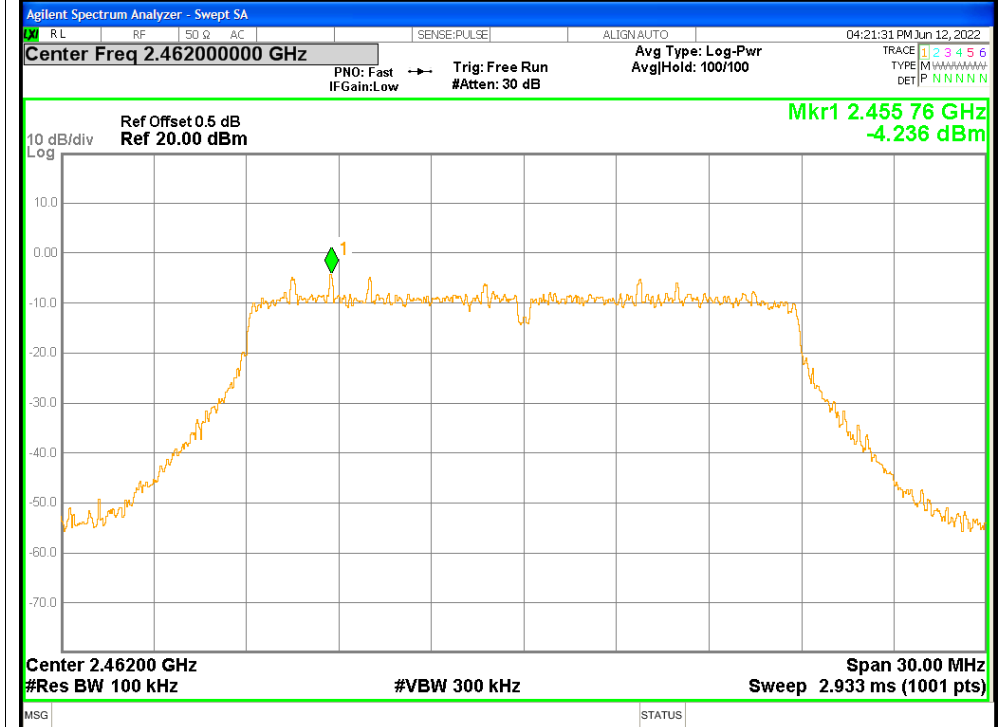

Tx. Spurious NVNT n20 2462MHz Emission

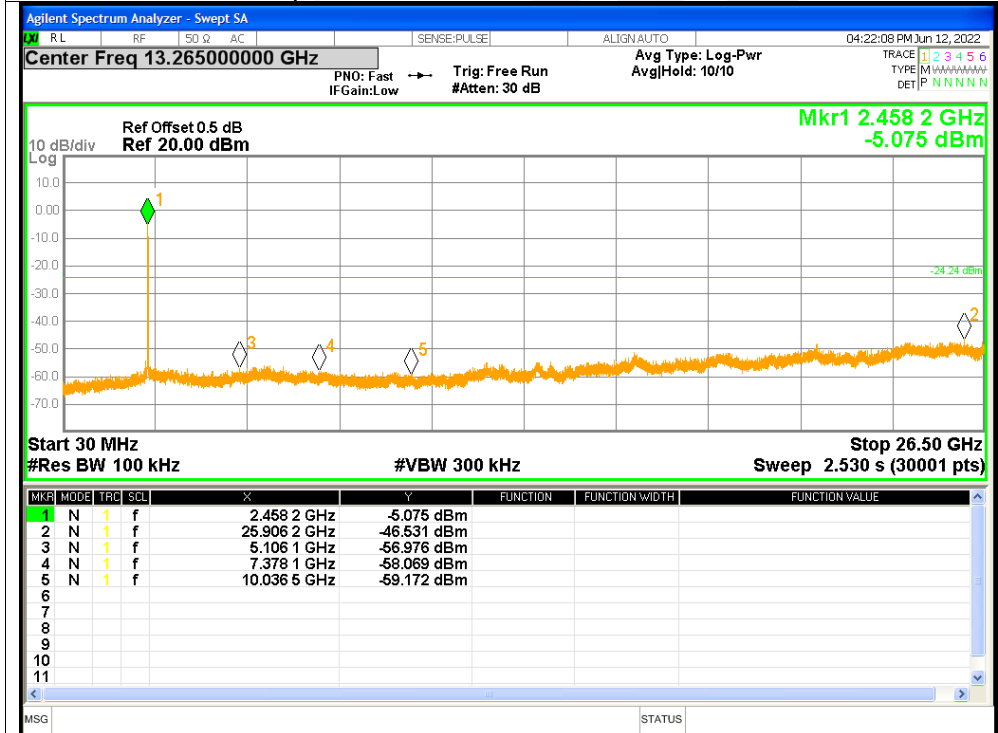



Tx. Spurious NVNT n40 2422MHz Ref

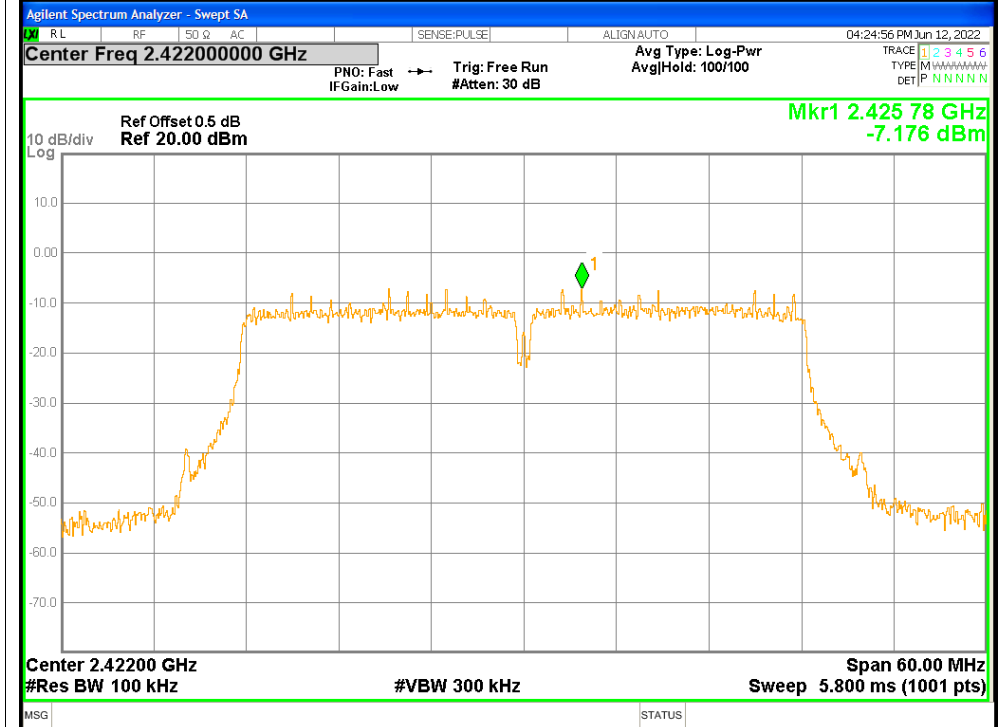

Tx. Spurious NVNT n40 2422MHz Emission

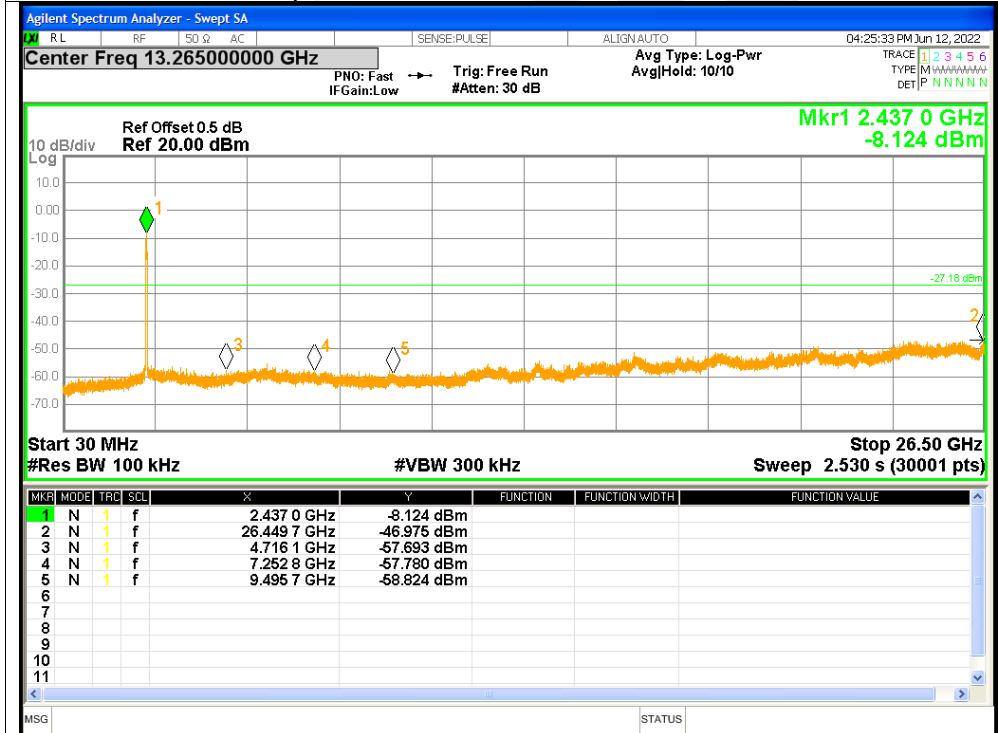



Tx. Spurious NVNT n40 2437MHz Ref

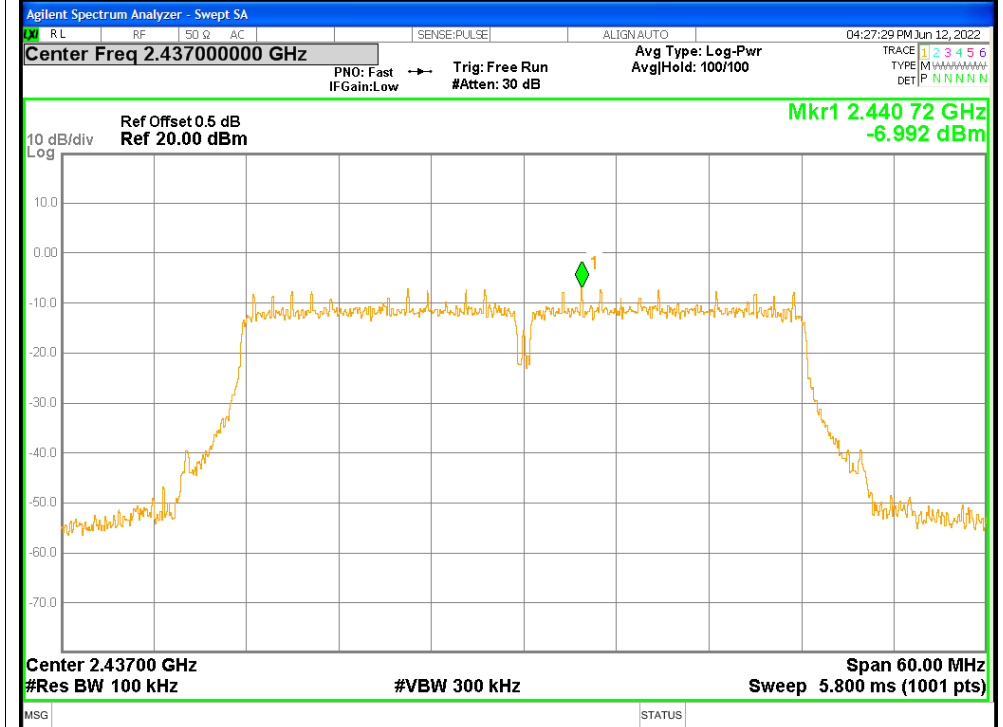

Tx. Spurious NVNT n40 2437MHz Emission

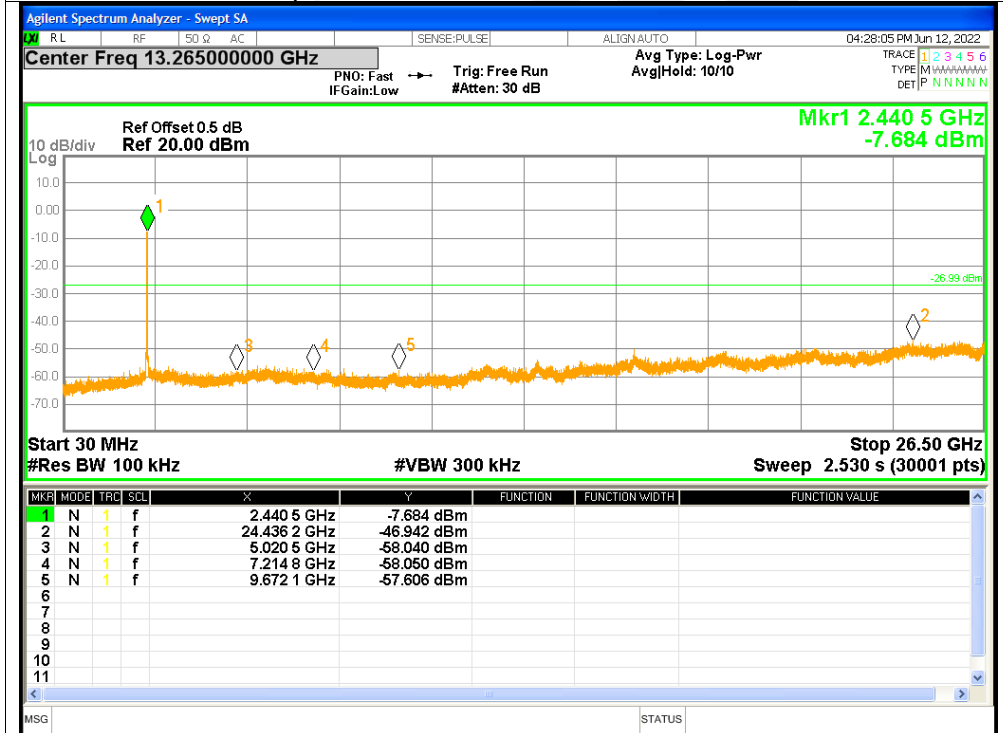



Tx. Spurious NVNT n40 2452MHz Ref

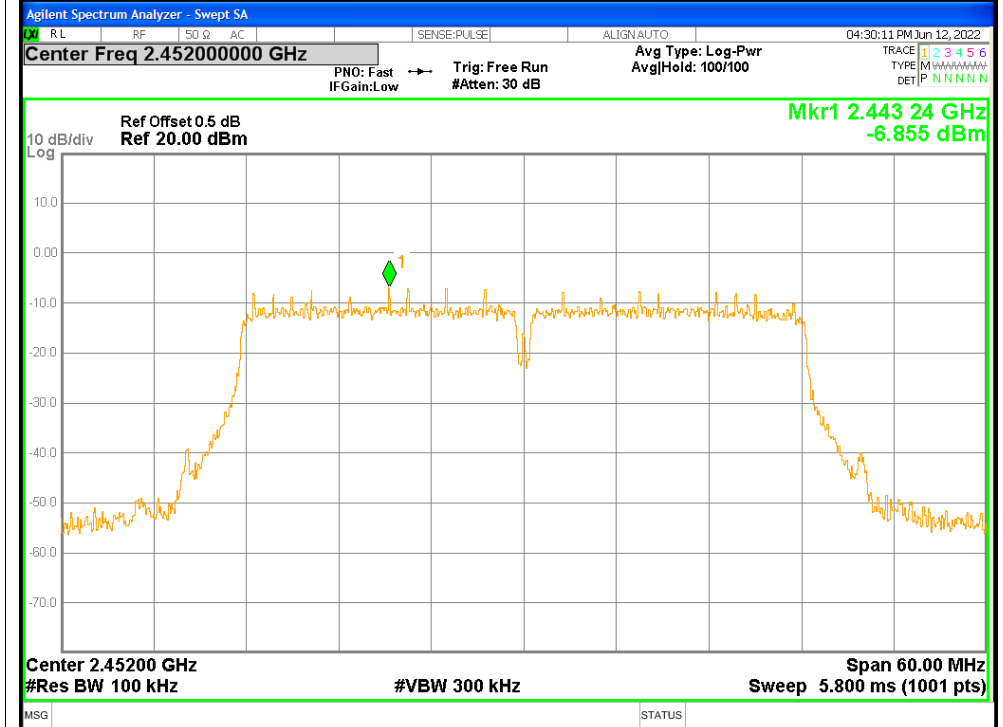

Tx. Spurious NVNT n40 2452MHz Emission

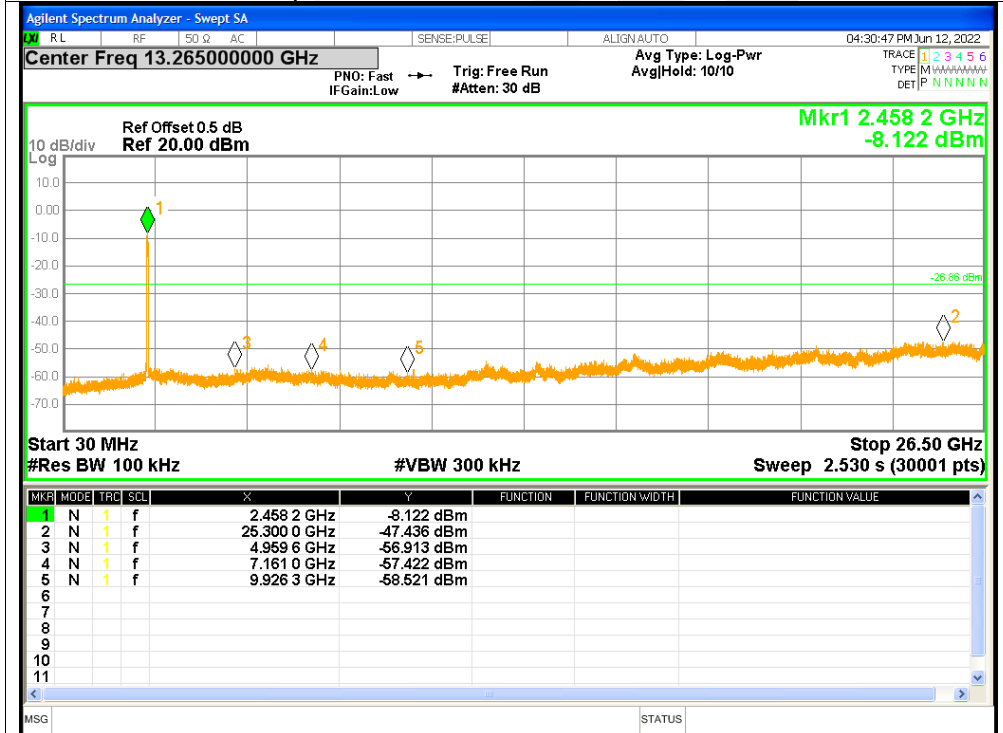



APPENDIX 2-PHOTOS OF TEST SETUP

Note: See test photos in setup photo document for the actual connections between Product and support equipment.

※※※※END OF THE REPORT※※※※

