

LABELS IN POSITION

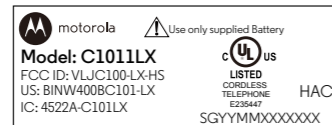

Handset Label

Handset label size: W 43mm x H 16mm



Handset Label-2

Handset label size: W 8mm x H 3.5mm(D=1.5mm)

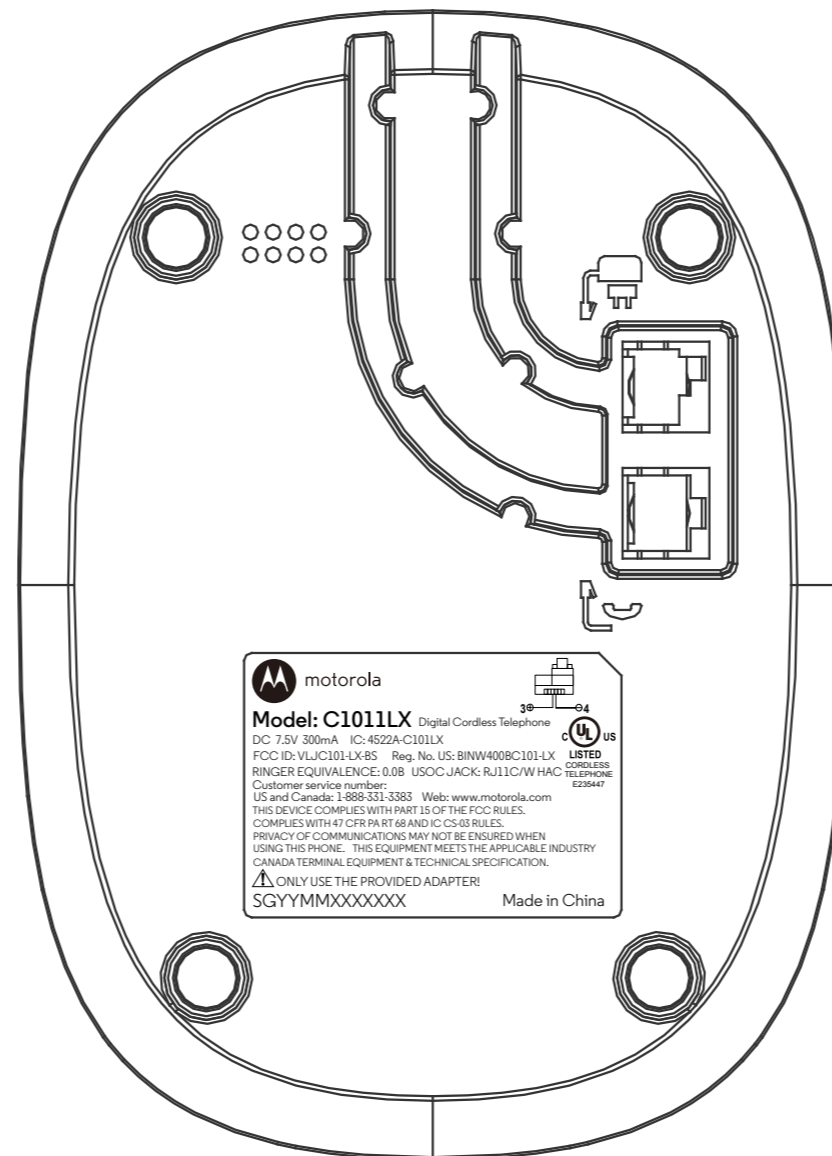

LABELS IN POSITION

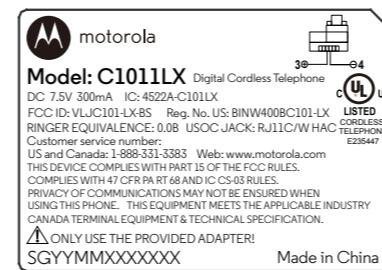

BASE LABEL-1

Engraving size: W50mm x H 35mm
Base label size: W 49.5mm x H 34.5mm

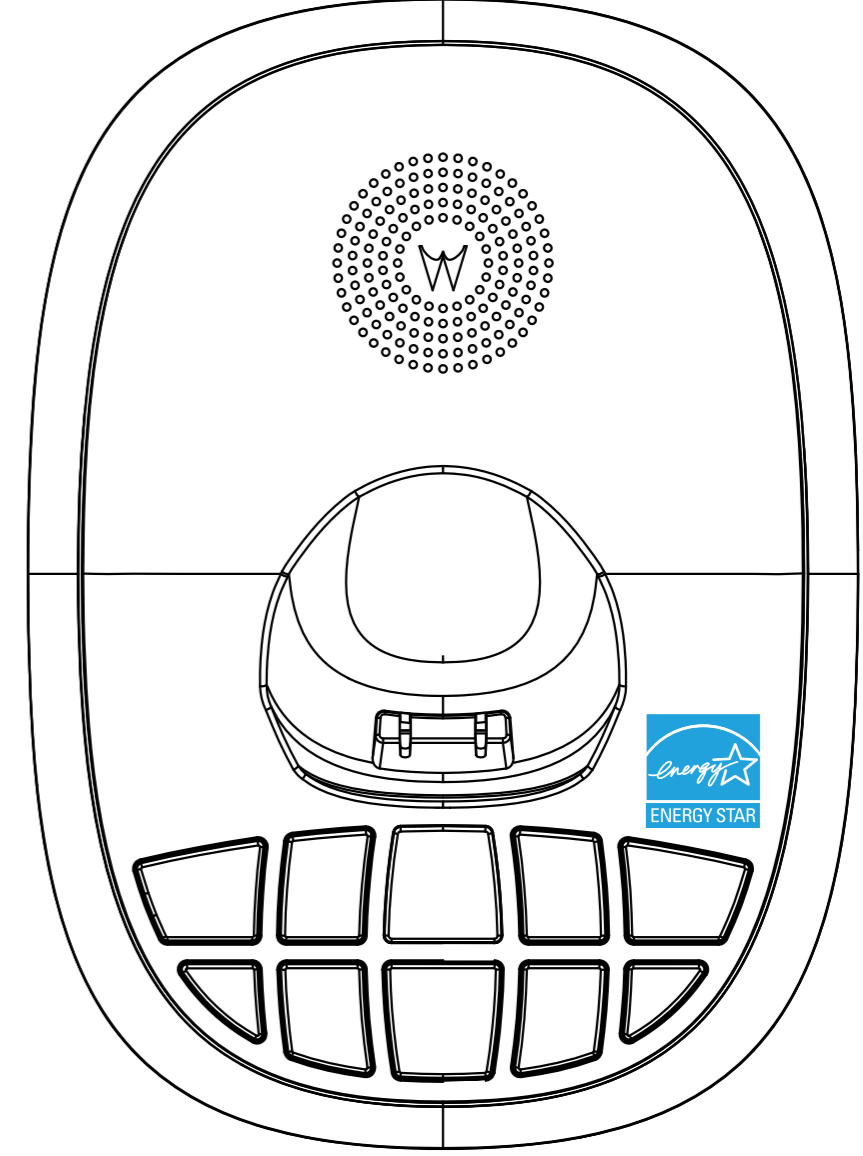

LABELS IN POSITION



BASE LABEL-2

Energy star label size: W 15mm x H 15mm

PRODUCT LABEL ARTWORK

Model: C1011LX | Colour: Black | Country: US
File: PL_C1011LX_US_Black_v9
Label font: Moto Sans
Contact: sheng.wen@sgwglocal.com
Date: 2014-12-16
Version: 9



BC LABEL
(Sticked on the GB)

BC label size: W 18mm x H 18mm

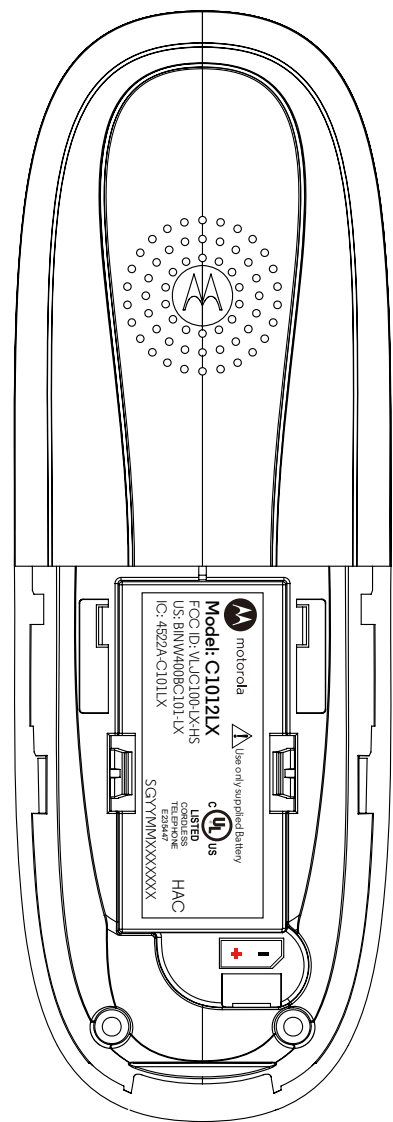

LABELS IN POSITION

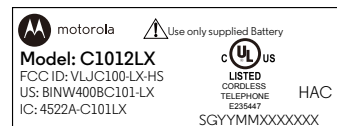

Handset Label

Handset label size: W 43mm x H 16mm



Handset Label-2

Handset label size: W 8mm x H 3.5mm(D=1.5mm)

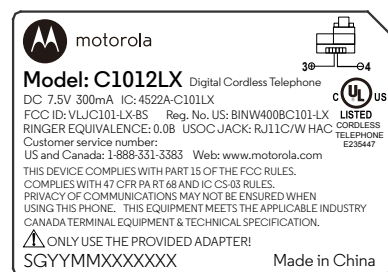
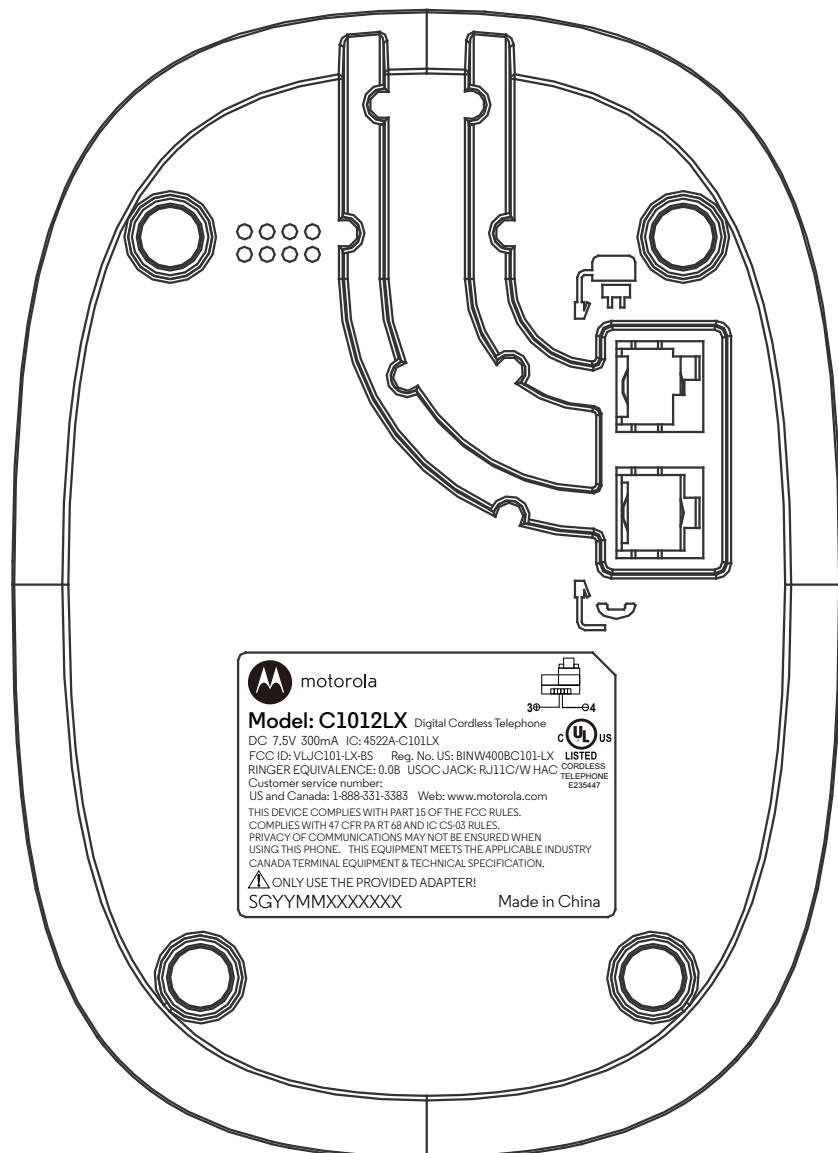

LABELS IN POSITION

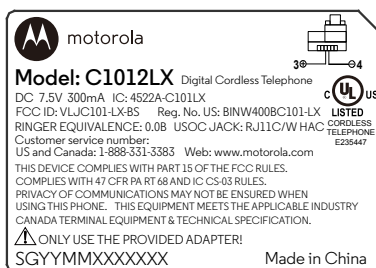

BASE LABEL-1

Engraving size: W50mm x H 35mm
Base label size: W 49.5mm x H 34.5mm



BC LABEL
(Sticked on the GB)

BC label size: W 18mm x H 18mm

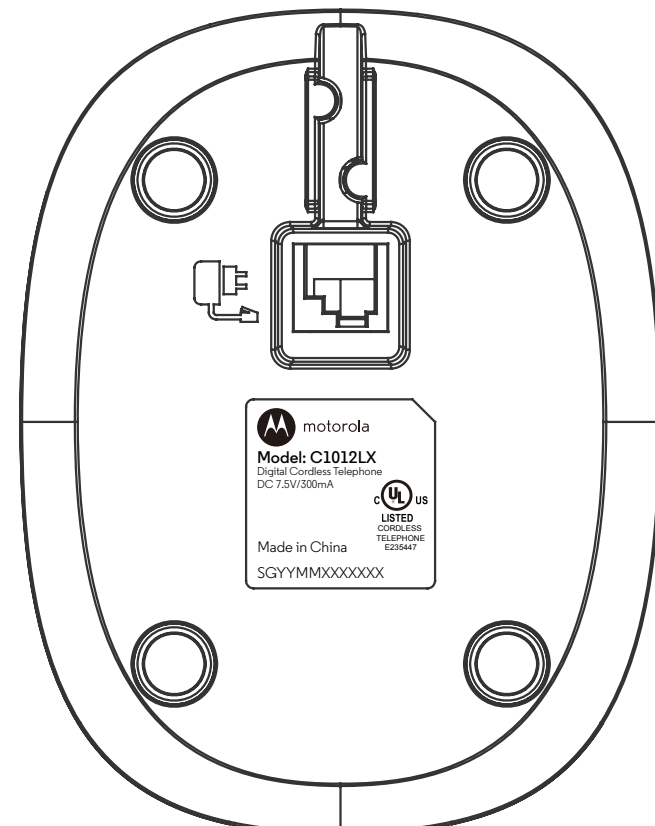

LABELS IN POSITION



CHARGER LABEL-1

Engraving size: W25mm x H 25mm
Base label size: W 24.5mm x H 24.5mm

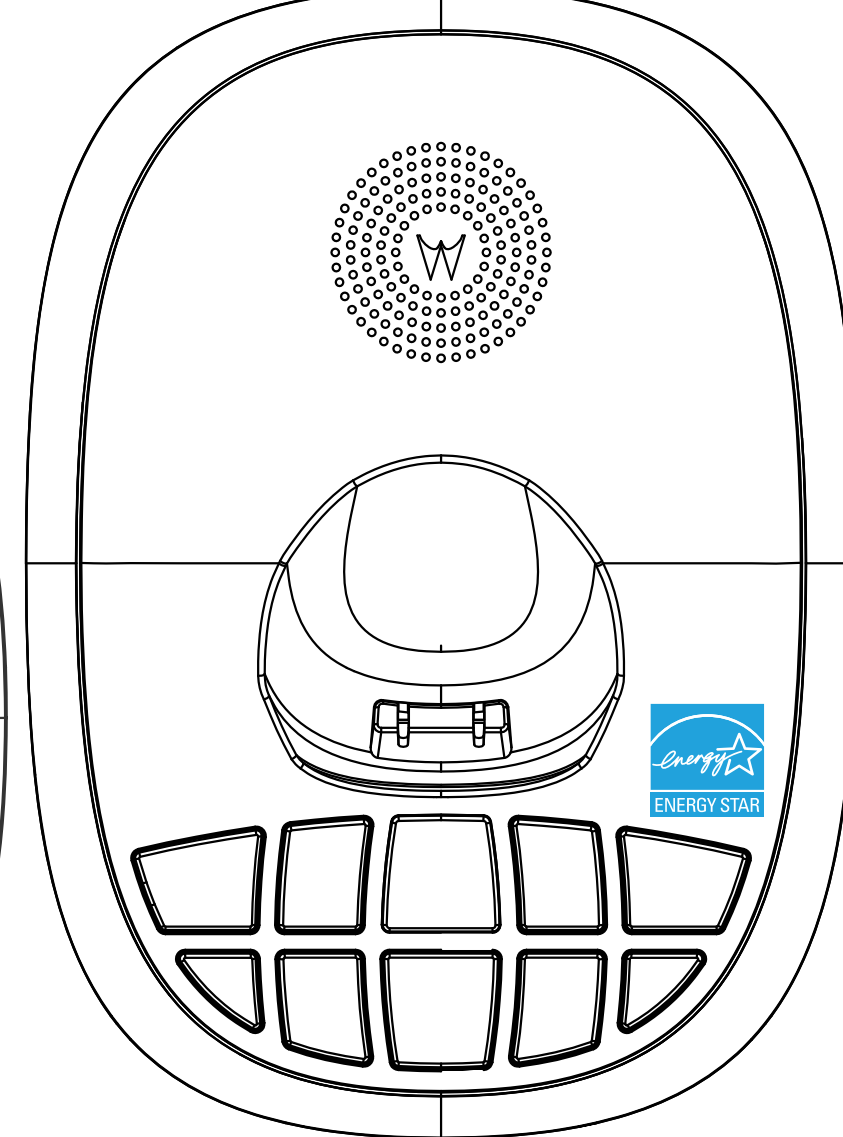

LABELS IN POSITION



BASE LABEL-2

Energy star label size: W 15mm x H 15mm

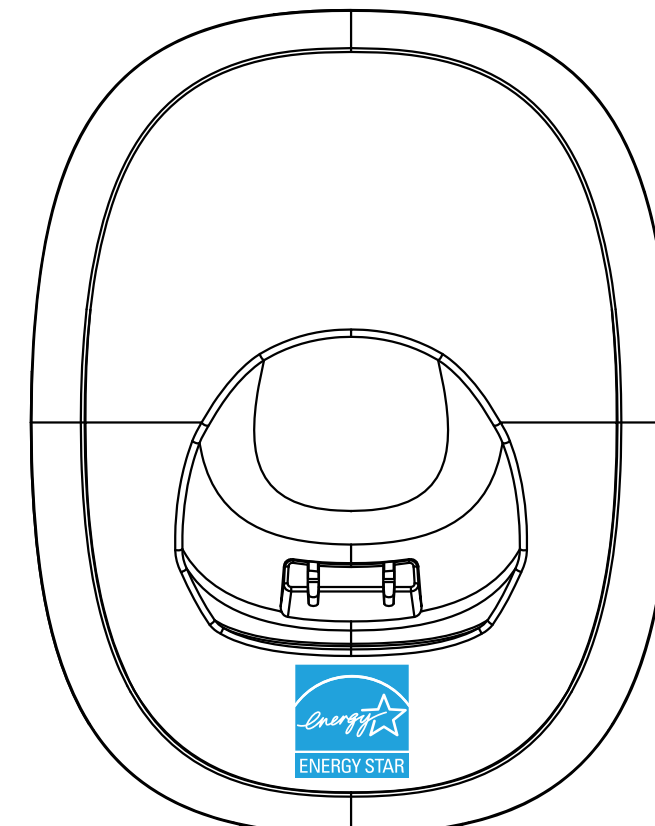

LABELS IN POSITION



CHARGER LABEL-2

Energy star label size: W 15mm x H 15mm

PRODUCT LABEL ARTWORK

Model: C1012LX | Colour: Black | Country: US
File: PL_C1012LX_US_Black_v10
Label font: Moto Sans
Contact: sheng.wen@sgwglobal.com
Date: 2014-12-16
Version: 10



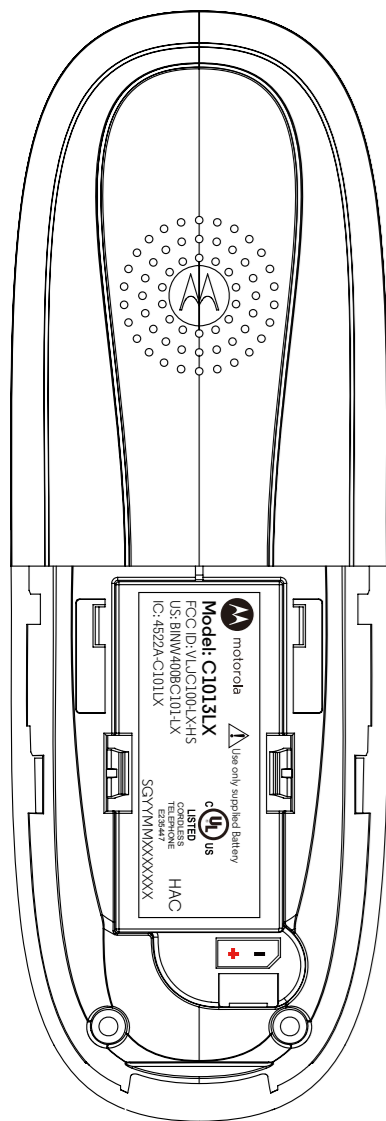

LABELS IN POSITION

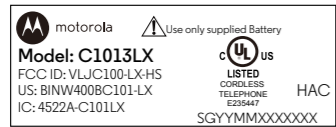

Handset Label

Handset label size: W 43mm x H 16mm



Handset Label-2

Handset label size: W 8mm x H 3.5mm(D=1.5mm)

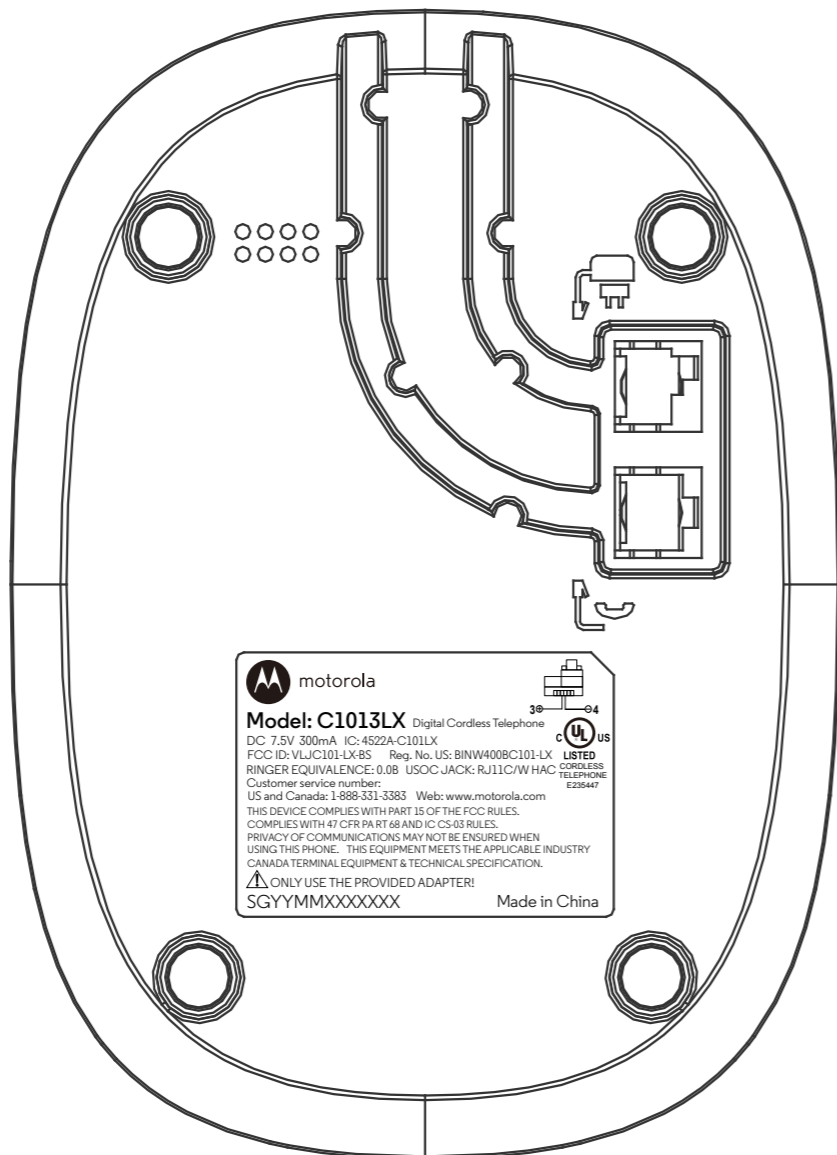

LABELS IN POSITION



BASE LABEL

Engraving size: W50mm x H 35mm
Base label size: W 49.5mm x H 34.5mm

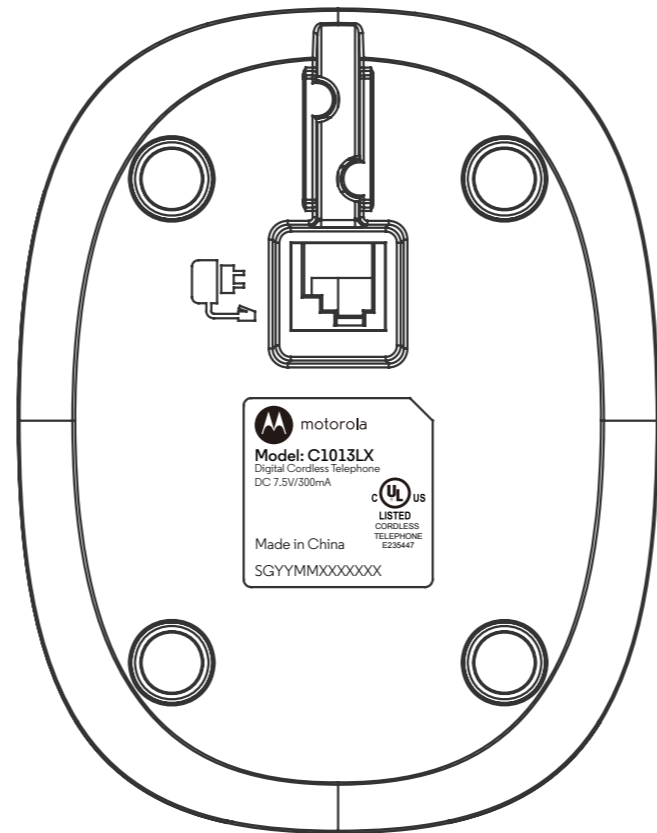

LABELS IN POSITION



CHARGER LABEL

Engraving size: W25mm x H 25mm
Base label size: W 24.5mm x H 24.5mm



BC LABEL
(Sticked on the GB)

BC label size: W 18mm x H 18mm

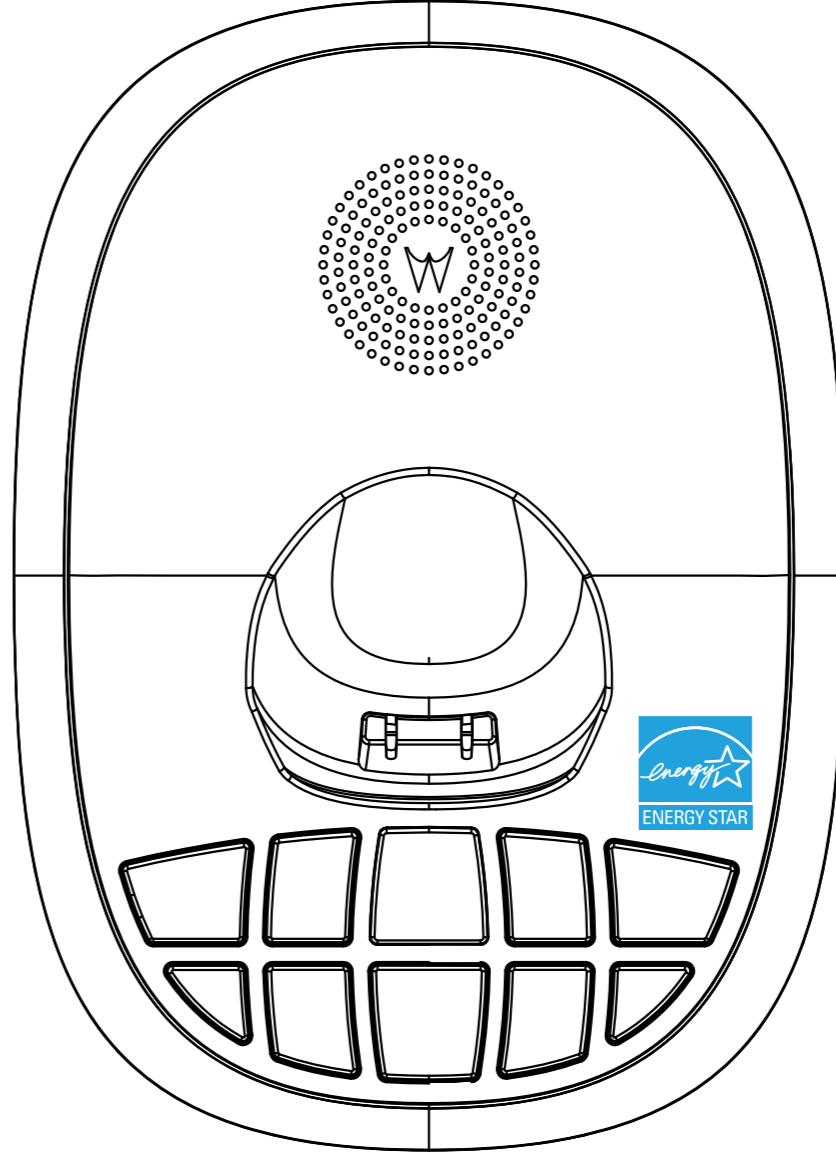

LABELS IN POSITION



BASE LABEL-2

Energy star label size: W 15mm x H 15mm

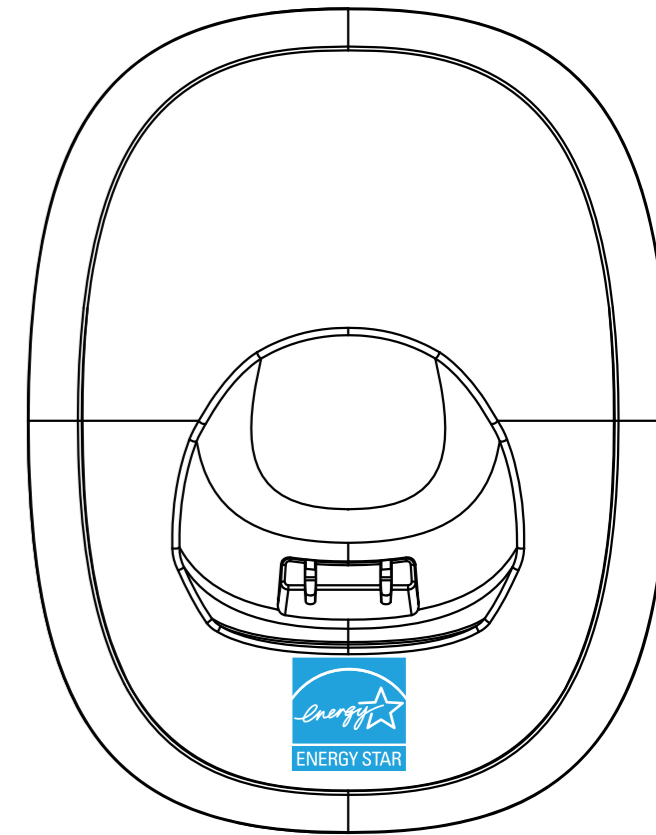

LABELS IN POSITION



CHARGER LABEL-2

Energy star label size: W 15mm x H 15mm

PRODUCT LABEL ARTWORK

Model: C1013LX| Colour: Black | Country: US
File: PL_C1013LX_US_Black_v8
Label font: Moto Sans
Contact: sheng.wen@sgwglobal.com
Date: 2014-12-16
Version: 8



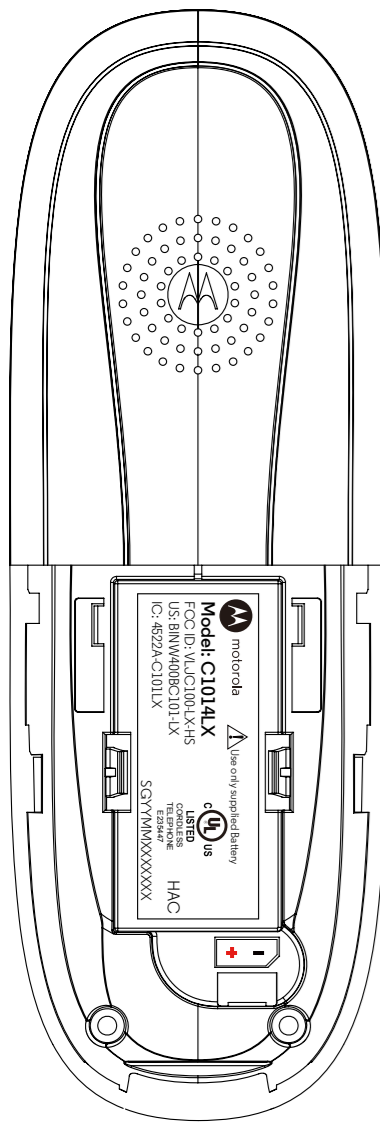

LABELS IN POSITION

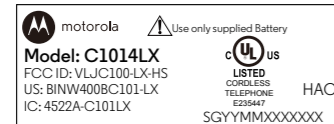

Handset Label

Handset label size: W 43mm x H 16mm



Handset Label-2

Handset label size: W 8mm x H 3.5mm(D=1.5mm)

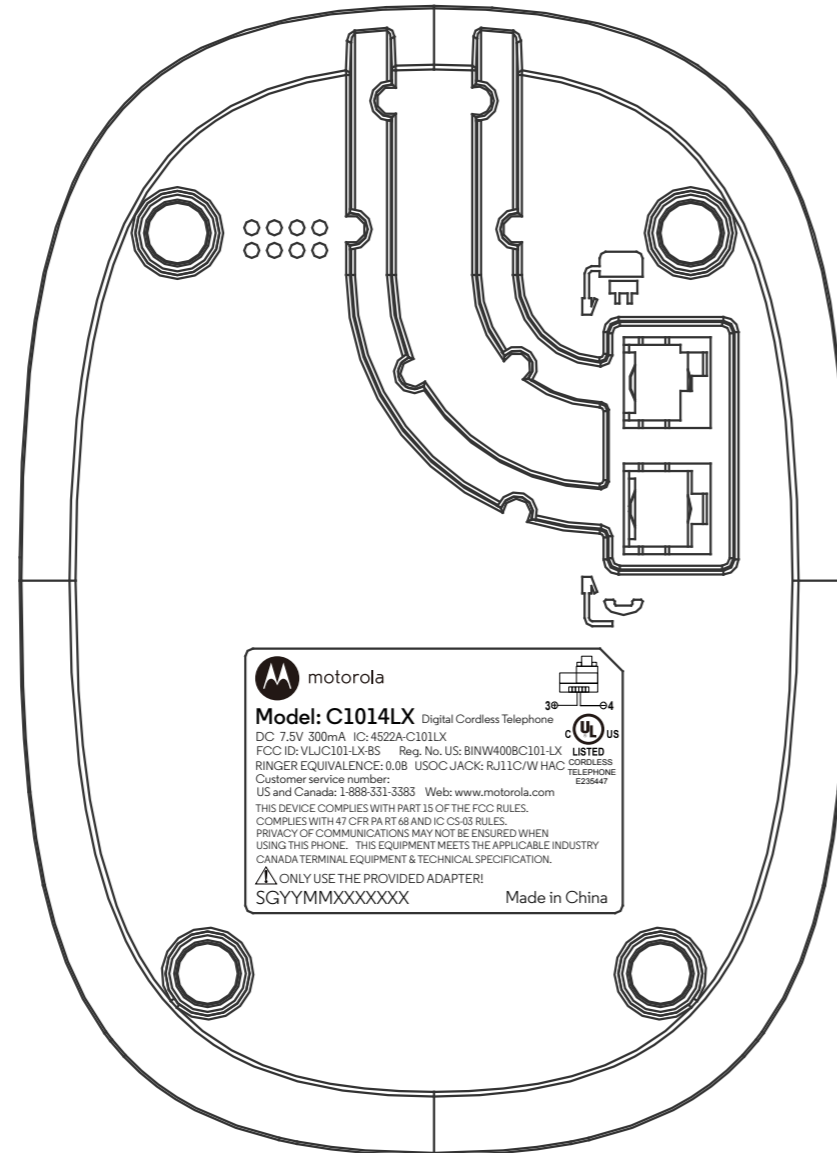

LABELS IN POSITION

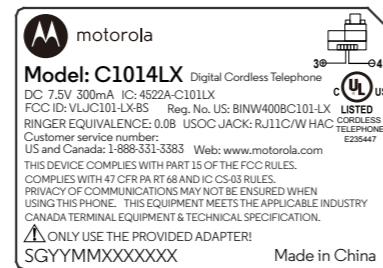

BASE LABEL

Engraving size: W50mm x H 35mm
Base label size: W 49.5mm x H 34.5mm



**BC LABEL
(Sticked on the GB)**

BC label size: W 18mm x H 18mm

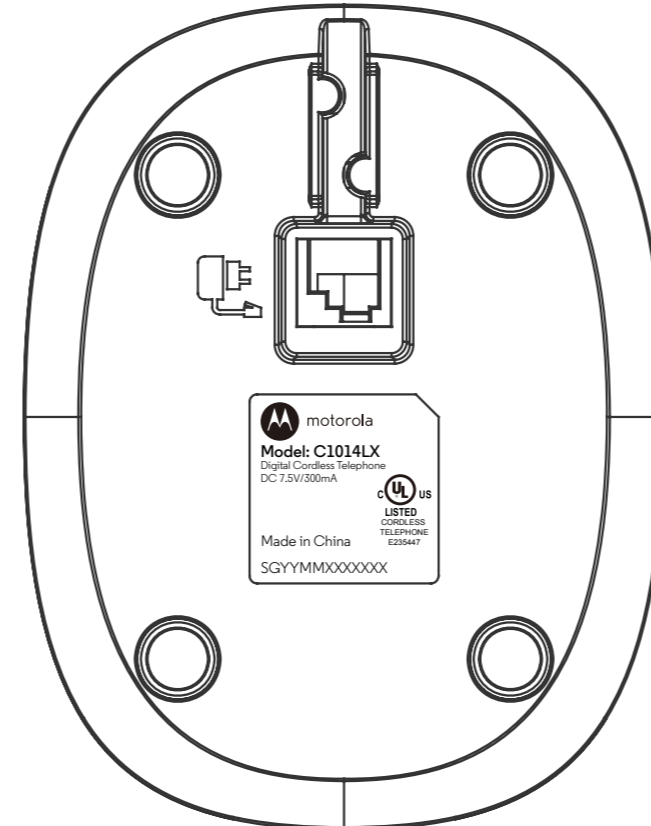

LABELS IN POSITION



CHARGER LABEL

Engraving size: W25mm x H 25mm
Base label size: W 24.5mm x H 24.5mm

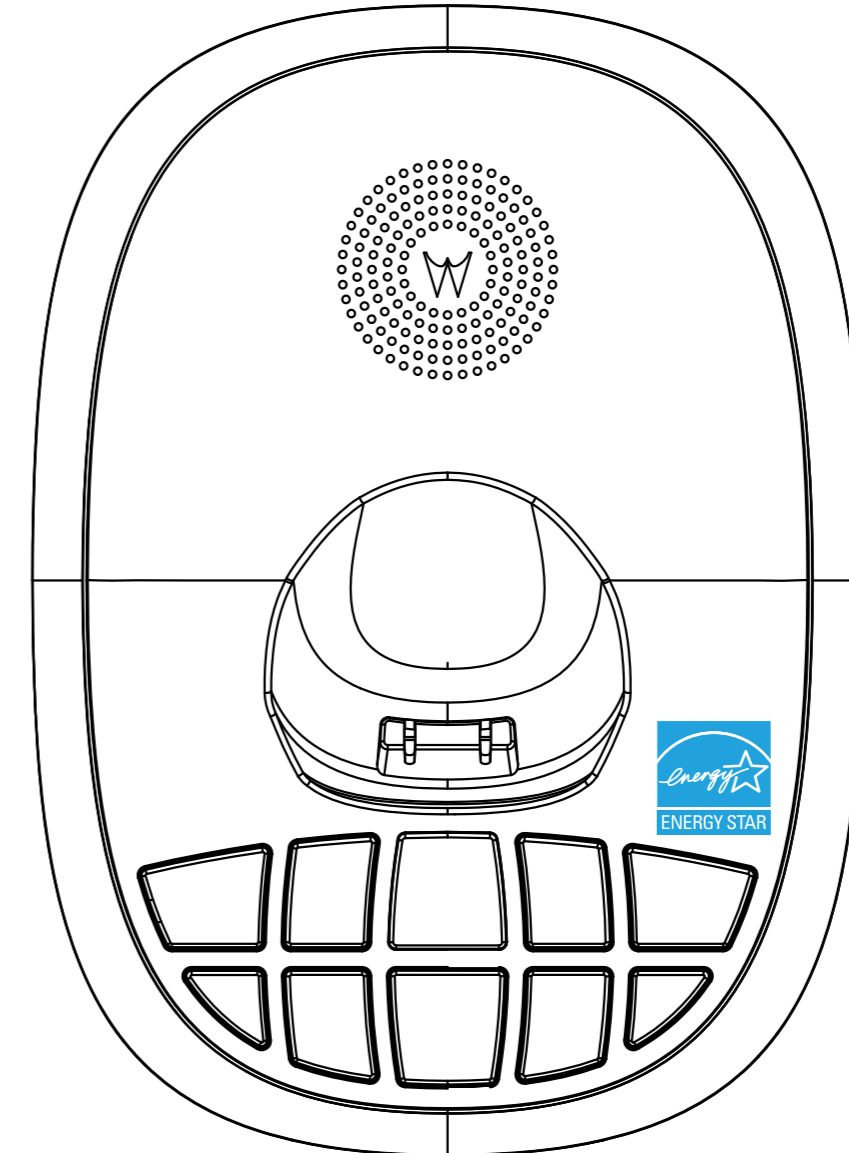

LABELS IN POSITION



BASE LABEL-2

Energy star label size: W 15mm x H 15mm

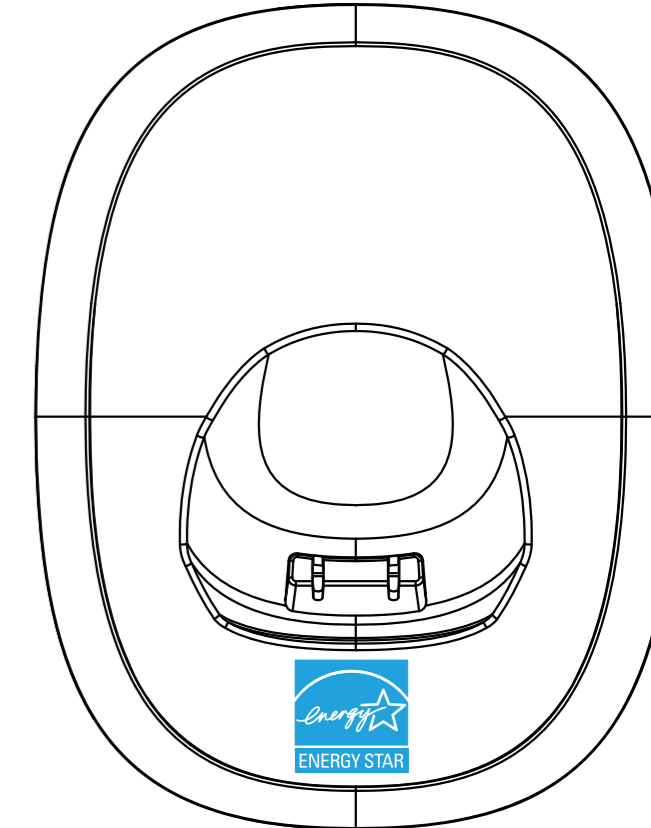

LABELS IN POSITION



CHARGER LABEL-2

Energy star label size: W 15mm x H 15mm

PRODUCT LABEL ARTWORK

Model: C1014LX | Colour: Black | Country: US
File: PL_C1014LX_US_Black_v8
Label font: Moto Sans
Contact: sheng.wen@sgwgglobal.com
Date: 2014-12-16
Version: 8

