

COMPONENT COSMETIC SPECIFICATION

PART NO. **30-011533-000-100**

MODEL NAME : L902
DESCRIPTION : HS FRONT
DOCUMENT NO.: 30-011533-000-100 REV.: 0
MODEL NO. : 80-7821-00-00

COSMETIC SURFACE TREATMENT :

FRONT SURFACE: Engraving.
BACK SURFACE : NIL

OTHER DETAILS :

MATERIALS : Details please see the MECH drawing # 30-011533.
REMARKS : Plastic color please refer to latest color spec.
DELIVERY PROTECTION: POLYBAG PACKING FOR EACH INDIVIDUAL UNIT

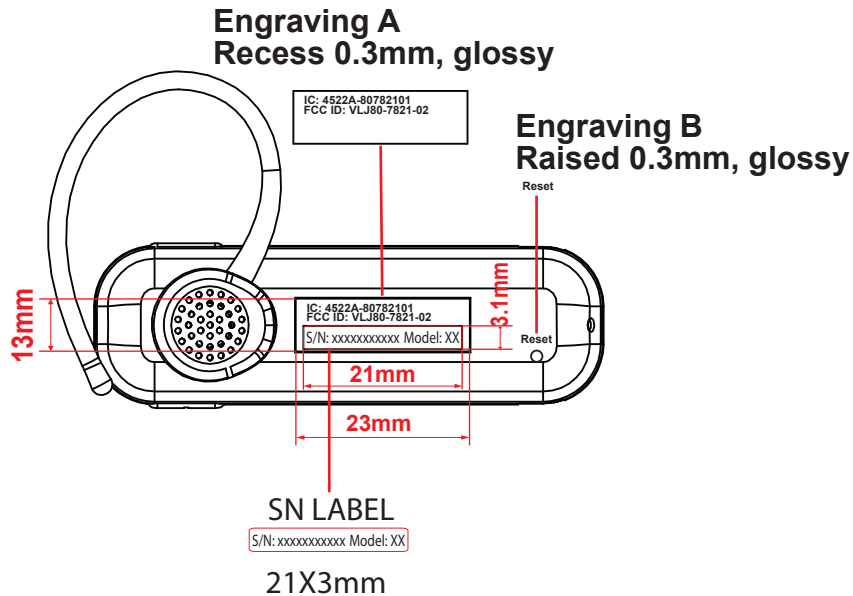

REMARKS :

- ALL TEXT/GRAPHICS PRINTED IN :
- GENERAL DIMENSION TOLERANCE : **+/-0.1mm**

L902 Label:

HS SN Label
Size: 20X10mm

HDS SN Label
Size: 20X3mm

BS SN Label
Size: 28X10mm

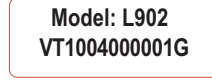
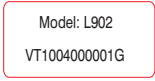

L903 Label:

HS SN Label
Size: 20X10mm

HDS SN Label
Size: 20X3mm

BS SN Label
Size: 28X10mm

Charger SN Label
Size: 20X10mm

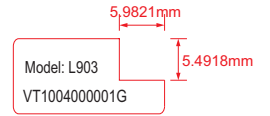
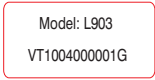

L904 Label:

HS SN Label
Size: 20X10mm

HDS SN Label
Size: 20X3mm

BS SN Label
Size: 28X10mm

Charger SN Label
Size: 20X10mm

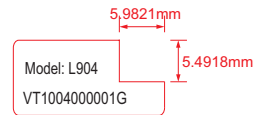
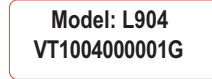
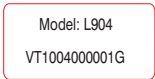

L905 Label:

HS SN Label
Size: 20X10mm

HDS SN Label
Size: 20X3mm

BS SN Label
Size: 28X10mm

Charger SN Label
Size: 20X10mm

