



Hearing Aid Compatibility (HAC) T-COIL TEST REPORT

For

Binatone Electronics International Ltd.

Floor 23A, 9 Des Voeux Road West, Sheung Wan, Hong Kong, China

FCC ID: VLJ-THEBRICK

Report Type: Original Report	Product Type: GSM Mobile Phone
Test Engineer: <u>Ricky Wang</u> <i>Ricky</i>	
Report Number: <u>R13091610-HAC-T</u>	
Report Date: <u>2013-10-16</u>	
Reviewed By: <u>EMC/RF Lead</u> <i>Victor Zhang</i>	
Prepared By: Bay Area Compliance Laboratories Corp. 1274 Anvilwood Avenue, Sunnyvale, CA 94089, USA Tel: (408) 732-9162 Fax: (408) 732 9164	

Note: This test report is prepared for the customer shown above and for the device described herein. It may not be duplicated or used in part without prior written consent from Bay Area Compliance Laboratories Corp. This report must not be used by the customer to claim product certification, approval, or endorsement by A2LA* or any agency of the Federal Government. * This report may contain data that are not covered by the A2LA accreditation and are marked with an asterisk ^{“(Rev.3)”}

HEARING AID COMPATIBILITY DECLARATION OF COMPLIANCE

FCC Rule Part(s):	CFR 47 §20.19
HAC Test Procedure(s):	ANSI C63.19-2007
Device Category:	Portable Transmitter Held to Ear
Modulation Type:	GMSK
TX Frequency Range:	824.2-848.8 MHz (Cellular Band) 1850.2-1909.8 MHz (PCS Band)
Maximum Conducted Power Tested:	32.48 dBm (Cellular Band) 29.33 dBm (PCS Band)
Battery Type (s) Tested:	3.7 V
T Category = T4 (ANSI C63.19-2007)	

BACL Corp. declares under its sole responsibility that this wireless portable device has been tested for Hearing Aid Compatibility in accordance with the measurement procedures specified in ANSI C63.19-2007.

All measurements reported herein were performed under my supervision and believed to be accurate to the best of my knowledge. I further attest for the completeness of these measurements and vouch for the qualifications any and all personnel performing such measurements.

The results and statements contained in this report pertain only to the device(s) evaluated.



TABLE OF CONTENTS

1	GENERATION INFORMATION.....	5
1.1	PRODUCT DESCRIPTION FOR THE EUT	5
1.2	OBJECTIVE	5
1.3	TEST FACILITIES AND ACCREDITATION.....	5
2	DESCRIPTION OF TEST SYSTEM.....	6
2.1	T-COIL MEASUREMENT SYSTEM.....	6
2.2	SYSTEM COMPONENTS.....	8
2.3	DASY4 MEASUREMENT SERVER.....	8
2.4	DATA ACQUISITION ELECTRONICS (DAE).....	8
2.5	LIGHT BEAM UNIT	9
2.6	DEVICE HOLDER AND ARCH PHANTOM	9
2.7	INSTALLATION OF THE TEST ARCH PHANTOM	9
2.8	MOUNTING OF A CALIBRATION DIPOLE	9
2.9	MOUNTING THE DUT.....	10
2.10	ROBOT	11
2.11	AMCC	11
2.12	AMMI	12
2.13	AMID PROBE.....	13
3	TESTING EQUIPMENT LIST AND DETAILS	14
4	HAC T-COIL TEST METHOD AND PROCEDURE.....	15
4.1	TEST PROCEDURE	15
4.2	ARTICULATION WEIGHTING FACTOR (AWF).....	16
4.3	T-COIL SIGNAL QUALITY CATEGORIES.....	16
4.4	TEST FLOW FOR T-COIL SIGNAL TEST	16
4.5	FREQUENCY RESPONSE	17
4.6	TEST SETUP.....	18
4.7	REFERENCE INPUT OF AUDIO SIGNAL SPECTRUM	19
4.8	SIGNAL VERIFICATION	20
4.9	HELMHOLTZ COIL VALIDATION TABLE OF RESULTS	20
5	MEASUREMENT UNCERTAINTY	21
6	HAC T-COIL MEASUREMENT RESULTS.....	22
6.1	TEST ENVIRONMENT CONDITIONS	22
7	HAC T-COIL MEASUREMENT PLOTS.....	24
8	APPENDIX A – PROBE CALIBRATION CERTIFICATES	32
9	APPENDIX B – OUTPUT POWER MEASUREMENT.....	35
9.1	TEST BLOCK DIAGRAM AND PROCEDURE	35
9.2	TEST EQUIPMENT LIST AND DETAILS.....	35
9.3	TEST RESULTS	35
10	APPENDIX C – TEST SETUP PHOTOS.....	36
10.1	T-COIL TEST SETUP PHOTO	36
11	APPENDIX G – EUT PHOTOGRAPHS.....	37
11.1	EUT – FRONT VIEW	37
11.2	EUT – BOTTOM VIEW.....	37
11.3	EUT – BATTERY COMPARTMENT VIEW	38
12	APPENDIX E - INFORMATIVE REFERENCES	39

DOCUMENT REVISION HISTORY

Revision Number	Report Number	Description of Revision	Date of Revision
0	R13091610-HAC-T	Original Report	2013-10-16

1 GENERATION INFORMATION

1.1 Product Description for the EUT

This Bay Area Compliance Laboratories Corp. HAC Report is prepared on behalf of *Binatone Electronics International Ltd.*, and their product GSM Mobile Phone, FCC ID: VLJ-THEBRICK, Model: The Brick Power, or the EUT (Equipment Under Test,) as referred to in the rest of this report.

The test data gathered are from typical production sample, serial number: R13091610, provided by BACL Corp.

Item	Content
Modulation	GMSK
TX Frequency	Cellular Band: 824.2-848.8 MHz PCS Band: 1850.2-1909.8 MHz
Dimensions (L x W x H)	200mm(L)×48mm(W)×42mm (H)
Weight	275.5g
Power Source	3.7 V
Operation Mode	Head and Body-worn

1.2 Objective

The objective is to determine compliance with FCC rules for Hearing Aid Compatibility (HAC) using ANSI/IEEE Std. C63.19-2007 (American National Standard Method of Measurement of Compatibility between Wireless Communications Devices and Hearing Aids) and test in accordance with the specified measurement procedures.

1.3 Test Facilities and Accreditation

The test site used by BACL Corp. to collect radiated and conducted emissions measurement data is located at its facility in Sunnyvale, California, USA.

The test site at BACL Corp. has been fully described in reports submitted to the Federal Communication Commission (FCC) and Voluntary Control Council for Interference (VCCI). The details of these reports have been found to be in compliance with the requirements of Section 2.948 of the FCC Rules on February 11 and December 10, 1997, and Article 8 of the VCCI regulations on December 25, 1997. The test site also complies with the test methods and procedures set forth in CISPR 22:2008 §10.4 for measurements below 1 GHz and §10.6 for measurements above 1 GHz as well as ANSI C63.4-2003, ANSI C63.4-2009, TIA/EIA-603 & CISPR 24:2010.

The Federal Communications Commission and Voluntary Control Council for Interference have the reports on file and they are listed under FCC registration number: 90464 and VCCI Registration No.: A-0027. The test site has been approved by the FCC and VCCI for public use and is listed in the FCC Public Access Link (PAL) database.

Additionally, BACL Corp. is an American Association for laboratory Accreditation (A2LA) accredited laboratory (Lab Code 3297-02). The current scope of accreditations can be found at

<http://www.a2la.org/scopepdf/3297-02.pdf?CFID=1132286&CFTOKEN=e42a3240dac3f6ba-6DE17DCB-1851-9E57-477422F667031258&jsessionid=8430d44f1f47cf2996124343c704b367816b>

2 DESCRIPTION OF TEST SYSTEM

2.1 T-Coil Measurement System

The figure below shows the phantom set up in a DASY4 system. The Helmholtz Audio Magnetic Calibration Coil (AMCC) is mounted on the same plane as the HAC Test Arch phantom available from the HAC RF extension. Both items fit together without additional fixation and are arranged side by side. In place of a separate table, the cover plate of a SAM phantom may be used.



T-Coil Setup with HAC Test Arch and AMCC

The DASY4 system for performing compliance tests consists of the following items:

- A standard high precision 6-axis robot (Stäubli RX family) with controller, teach pendant and software. An arm extension for accommodating the data acquisition electronics (DAE).
- A dosimetric probe, i.e., an isotropic E-field probe optimized and calibrated for usage in tissue simulating liquid. The probe is equipped with an optical surface detector system.
- A Data Acquisition Electronics (DAE) which performs the signal amplification, signal multiplexing, AD-conversion, offset measurements, mechanical surface detection, collision detection, etc. The unit is battery powered with standard or rechargeable batteries. The signal is optically transmitted to the EOC.
- The Electro-Optical Converter (EOC) performs the conversion between optical and electrical of the signals for the digital communication to the DAE and for the analog signal from the optical surface detection. The EOC is connected to the measurement server.
- The function of the measurement server is to perform the time critical tasks such as signal filtering, control of the robot operation and fast movement interrupts.
- A probe alignment unit which improves the (absolute) accuracy of the probe positioning.

- A computer operating Windows 2000 or Windows XP.
- DASY4 software.
- Remote control with teach pendant and additional circuitry for robot safety such as warning lamps, etc.
- The device holder for handheld mobile phones.
- Dipole for evaluating the proper functioning of the system.
- Arch Phantom.

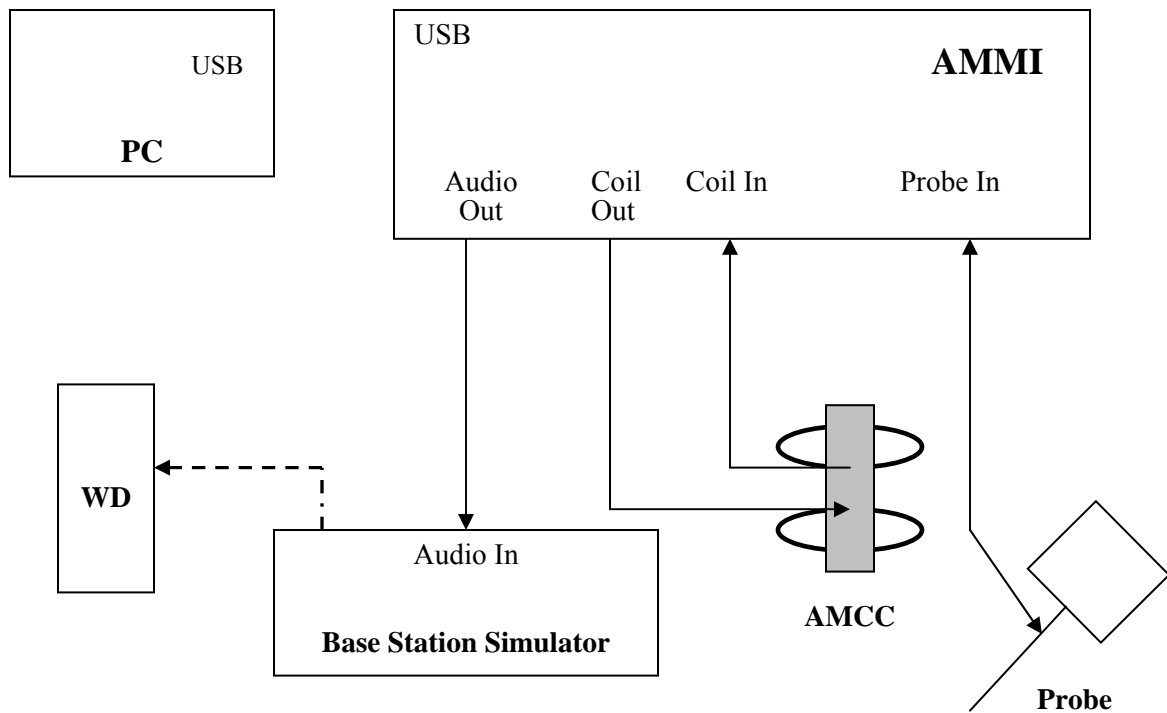

T-Coil Setup Cabling

2.2 System Components

- DASY4 Measurement Server
- Data Acquisition Electronics
- Probes
- Light Beam Unit
- Medium
- SAM Twin Phantom, Arch Phantom
- Device Holder for SAM Twin Phantom
- System Validation Kits
- Robot

2.3 DASY4 Measurement Server

The DASY4 measurement server is based on a PC/104 CPU board with a 166MHz low-power Pentium, 32MB chip disk and 64MB RAM. The necessary circuits for communication with either the DAE4 (or DAE3) electronic box as well as the 16-bit AD-converter system for optical detection and digital I/O interface are contained on the DASY4 I/O-board, which is directly connected to the PC/104 bus of the CPU board.



The measurement server performs all real-time data evaluation for field measurements and surface detection, controls robot movements and handles safety operation. The PC-operating system cannot interfere with these time critical processes. All connections are supervised by a watchdog, and disconnection of any of the cables to the measurement server will automatically disarm the robot and disable all program-controlled robot movements. Furthermore, the measurement server is equipped with two expansion slots which are reserved for future applications. Please note that the expansion slots do not have a standardized pinout and therefore only the expansion cards provided by SPEAG can be inserted. Expansion cards from any other supplier could seriously damage the measurement server.

2.4 Data Acquisition Electronics (DAE)

The data acquisition electronics DAE3 consists of a highly sensitive electrometer grade preamplifier with auto-zeroing, a channel and gain-switching multiplexer, a fast 16 bit AD-converter and a command decoder and control logic unit. Transmission to the measurement server is accomplished through an optical downlink for data and status information as well as an optical uplink for commands and the clock.



2.5 Light Beam Unit

The light beam switch allows automatic “tooling” of the probe. During the process, the actual position of the probe tip with respect to the robot arm is measured, as well as the probe length and the horizontal probe offset. The software then corrects all movements, so that the robot coordinates are valid for the probe tip. The repeatability of this process is better than 0.1 mm. If a position has been taught with an aligned probe, the same position will be reached with another aligned probe within 0.1 mm, even if the other probe has different dimensions. During probe rotations, the probe tip will keep its actual position.

2.6 Device Holder and Arch Phantom

The test Arch phantom should be positioned horizontally on a stable surface. Reference marking on the phantom allows the complete setup of all predefined phantom positions and measurement grids by manually teaching three points in the robot.

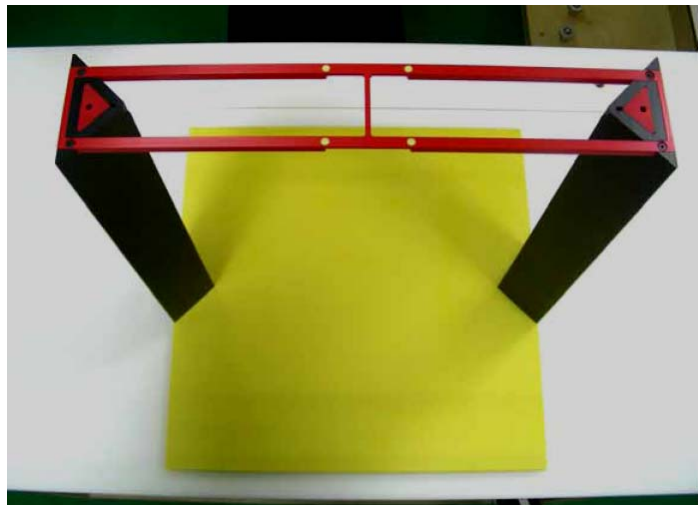

2.7 Installation of the Test Arch Phantom

The Test Arch phantom should be positioned horizontally on a stable surface. If the cover of the Twin SAM phantom is used, side shifting after the teaching shall be avoided. In order to allow a vertical position of the probe (for both DASY4 Professional and Compact versions) the section Park position should be not higher than 15mm above the top of the upper Arch frame. For improved user friendliness a predefined configuration file of the Test Arch phantom is provided by SPEAG.

2.8 Mounting of a Calibration Dipole

A set of three calibration dipoles (CD835, CD1880 and CD2450) is included as a part of the HAC extension. These are used for the validation of the test setup after its installation and prior to the DUT measurements. The calibration dipole is placed in the position normally occupied by the DUT. All three calibration dipoles have the same high which allows an exact fitting below the center point of the Test Arch.

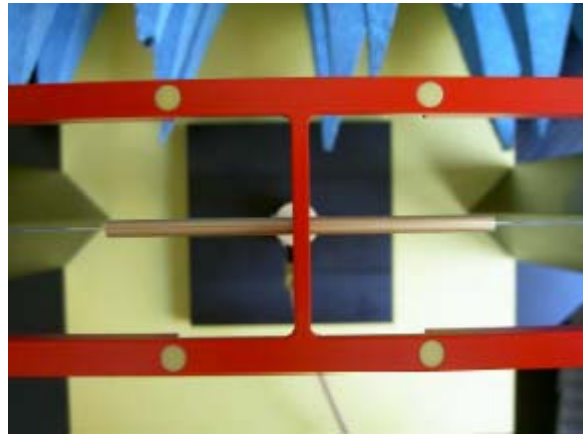

Insert the base of the calibration dipole fully into the dipole holder and fix it against rotation by tightening the white screw. Connect the RF cable to the dipole and secure it before placing it below the Test Arch phantom in order to avoid mechanical stress to it. Hold the dipole on its plate at the base and press it down against the internal spring to reduce the height.

While holding the dipole down, slide the dipole on its holder centered below the arch, with the arms aligned to the dielectric wire (see graphics above). Release the dipole slowly and guide the gap between the arms into the matching center spacer below the dielectric wire.

To remove the dipole from the setup press it in the downwards direction before sliding it carefully out from below the arch.

2.9 Mounting the DUT

A DUT is mounted in the device holder equivalent as for classic dosimetric measurements. The acoustic output of the DUT shall coincide with the center point of the area formed by the dielectric wire and the middle bar of the arch's top frame (see picture below).

The DUT shall be moved vertically upwards until it touches the frame. The fine adjustment is possible by sliding the complete DUT holder on the yellow base plate of the Test Arch phantom.

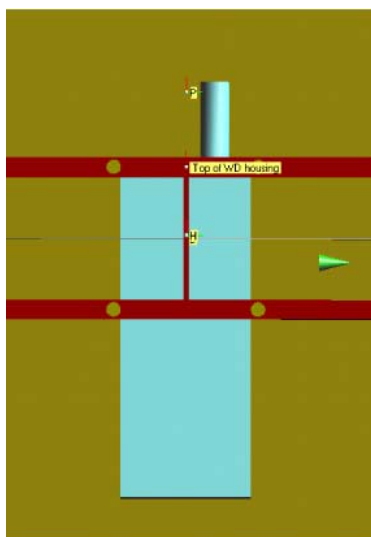

2.10 Robot

The DASY4 system uses the high precision industrial robots RX60L, RX90 and RX90L, as well as the RX60BL and RX90BL types out of the newer series from Stäubli SA (France). The RX robot series offers many features that are important for our application:

- High precision (repeatability 0.02mm)
- High reliability (industrial design)
- Low maintenance costs (virtually maintenance-free due to direct drive gears; no belt drives)
- Jerk-free straight movements (brushless synchrony motors; no stepper motors)
- Low ELF interference (the closed metallic construction shields against motor control fields)

For the newly delivered DASY4 systems as well as for the older DASY3 systems delivered since 1999, the CS7MB robot controller version from Stäubli is used. Previously delivered systems have either a CS7 or CS7M controller; the differences to the CS7MB are mainly in the hardware, but some procedures in the robot software from Stäubli are also not completely the same. The following descriptions about robot hard- and software correspond to CS7MB controller with software version 13.1 (edit S5). The actual commands, procedures and configurations, also including details in hardware, might differ if an older robot controller is in use. In this case please also refer to the Stäubli manuals for further information.



2.11 AMCC

The Audio Magnetic Calibration Coil (AMCC) is a Helmholtz Coil designed for calibration of the AMID probe. Two horizontal coils direction. The DC input resistance is adjusted by a series resistor to approximately 50 Ohm, and a shunt resistor of 10 Ohm permits monitoring the current with a scale of 1:10.

AMCC Port Description:

Signal	Connector Type	Resistance
Coil In	BNC	50 Ohm
Coil Monitor	BNO	10 Ohm \pm 1%



2.12 AMMI

The Audio Magnetic Measuring Instrument (AMMI) is a desktop 19-inch unit containing a sampling unit, a waveform generator for test and calibration signals, and a USB interface.

Signal	Connector Type	Description
Audio Out	BNC	Audio signal to the base station simulator, for >500Ohm load
Coil Out	BNC	Test and calibration signal to the AMCC (top connector), for 50 Ohm load
Coil In	XLR	Monitor signal from the AMCC BNO connector, 600Ohm
Probe In	XLR	Probe signal and phantom supply to the probe Lemo connector

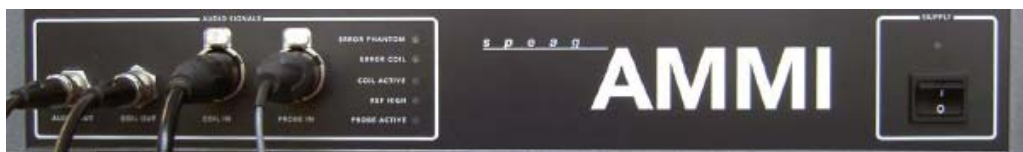

2.13 AM1D Probe

The AM1D probe is an active probe with a single sensor. It is fully RF-shielded and has a rounded tip 6mm in diameter incorporating a pickup coil with its center offset 3mm from the tip and the sides. The symmetric signal preamplifier in the probe is fed via the shielded symmetric output cable from the AMMI with a 48V "phantom" voltage supply. The 7-pin connector on the back in the axis of the probe does not carry any signals. It is mounted to the DAE for the correct orientation of the sensor. If the probe axis is tilted 54.7 degree from the vertical, the sensor is approximately vertical when the signal connector is at the underside of the probe (cable hanging downwards).

The sensor axis is indicated by a dot at the probe tip. AM1D probes are available with 40 dB or 20dB internal amplification factors depending on the required dynamic range.

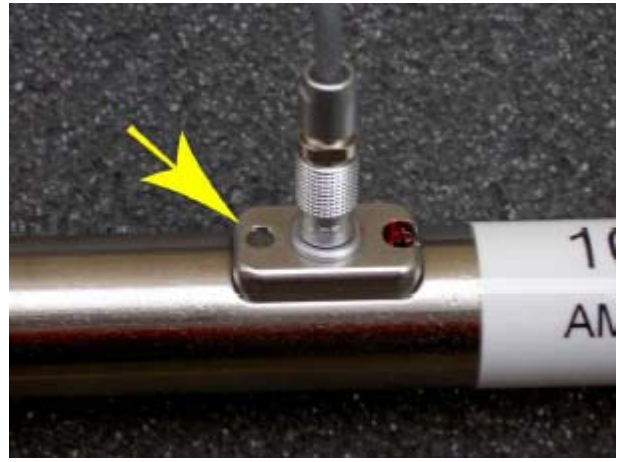

During operation in DASY4, the DAE must be switched on to provide the touch and emergency stop signals. The matching probe cup gives higher stability during tilted movements and rotation, still permitting the necessary movement for surface detection and the emergency stop function. Fix the probe tightly to the DAE, so the probe body cannot be turned against the DAE. In order to avoid breaking the DAE pins, only turn the connector nut, never the probe body! Make sure the probe can move correctly along its axis for surface detection.

3 TESTING EQUIPMENT LIST AND DETAILS

Type/Model	Cal. Due Date	S/N
DASY4 Professional Dosimetric System	N/A	N/A
Robot RX60L	N/A	CS7MBSP/467
Robot Controller	N/A	F01/5J72A1/A/01
Dell Computer Dimension 3000	N/A	N/A
SPEAG EDC3	N/A	N/A
SPEAG DAE3	2015-10-17	456
Audio Magnetic Probe, AM1DV2	2014-01-10	1073
SPEAG Arch Phantom	N/A	1010
SPEAG Light Alignment Sensor	N/A	278
Audio Magnetic Calibration Coil, AMCC	Calibrated Before Each Test	1081
Audio Measuring Instrument, AMMI	Calibrated Before Each Test	1071
Agilent, Spectrum Analyzer E4440A	2014-08-09	US45303156
Analyzer Communication, CMU200	2014-06-22	103492
Microwave Amp. 8349A	N/A	2644A02662
HP, Signal Generator, 83650B	2014-06-21	3614A00276
Agilent, Spectrum Analyzer	2014-08-09	US45303156
Antenna, Horn, EMCO	2014-09-09	3115
Power Meter Agilent E4419B	2014-09-01	MY4121511
Power Sensor Agilent E9301A	2014-05-09	US39211706
Antenna, Horn SAS-200/571	2014-01-18	261

4 HAC T-TOIL TEST METHOD AND PROCEDURE

4.1 Test Procedure

According to ANSI C63.19-2007, the device should be tested as the flowchart hereinafter.

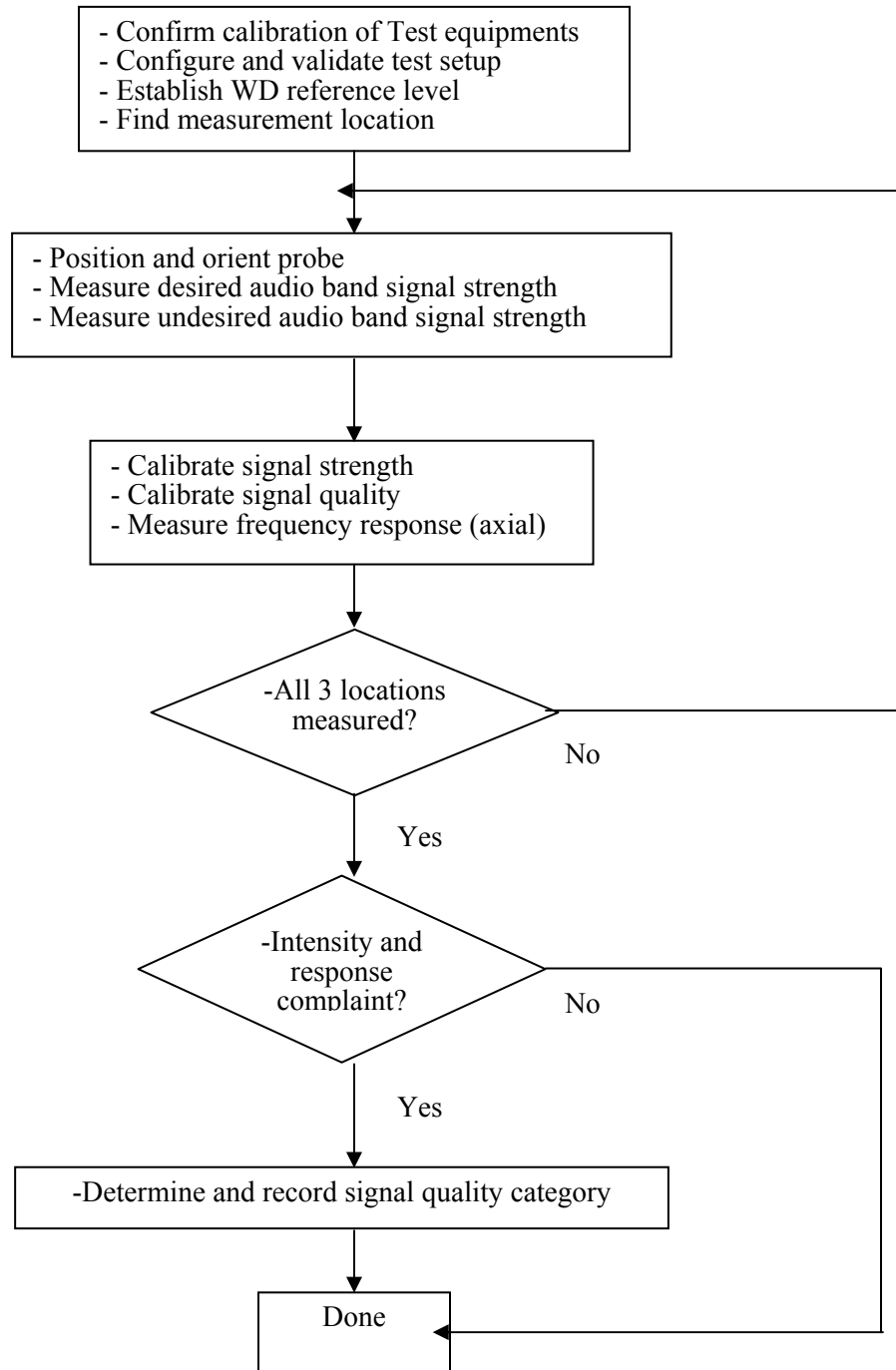

T-Coil Measurement flowchart

4.2 Articulation Weighting Factor (AWF)

The following AWF factors shall be used for the standard transmission protocols:

Standard	Technology	AWF (dB)
TIA/EIA/IS-2000	CDMA	0
TIA/EIA-136	TDMA (50 Hz)	0
J-STD-007	GSM (217)	-5
T1/P1P1/3GPP	UMTS (WCDMA)	0
iDEN	TDMA (22 and 11 Hz)	0

4.3 T-Coil Signal Quality Categories

The RF measurements made for the T-Coil evaluation are used to assign the category T1 through T4. The limitation is given in the table below. This establishes the RF environment presented by the WD to hearing aid.

Category	Telephone Parameters WD signal quality [(signal+noise)-to-noise ratio in dB]
Category T1	0 dB to 10 dB
Category T2	10 dB to 20 dB
Category T3	20 dB to 30 dB
Category T4	> 30 dB

4.4 Test Flow for T-Coil Signal Test

The following steps summarize the basic test flow for determining ABM1 and ABM2. These steps assume that a sine wave or narrowband 1/3 octave signal can be used for the measurement of ABM1. An alternate procedure yielding equivalent results utilizing a broadband excitation is described in 6.4 of ANSI 63.19-2007.

1. A reference check of the test setup and instrumentation may be performed using a TMFS. Position the TMFS into the setup at the position to be occupied by the WD. Measure the emissions from the TMFS and confirm that they are within the tolerance of the expected values.
2. Position the WD in the test setup and connect WD RF connector to a base station simulator or a non-radiating load as Figure 6.1 and Figure 6.2 of ANSI 63.19-2007. Confirm that equipment that requires calibration has been calibrated, and that the noise level meets the requirements given in 6.2.1 of ANSI 63.19-2007.
3. The drive level to the WD is set such that the reference input level defined in 6.3.2.1, Table 6.1 of ANSI 63.19-2007 is input to the base station simulator (or manufacturer's test mode equivalent) in the 1 kHz, 1/3 octave band. This drive level shall be used for the T-Coil signal test (ABM1) at $f = 1$ kHz. Either a sine wave at 1025 Hz or a voice-like signal, band-limited to the 1 kHz 1/3 octave, as defined in 6.3.2 shall be used for the reference audio signal. If interference is found at 1025 Hz an alternate nearby reference audio signal frequency may be used. The same drive level will be used for the ABM1 frequency response measurements at each 1/3 octave band center frequency. The WD volume control may be set at any level up to maximum modulation would not result in clipping or signal overload.

4.5 Frequency Response

Magnetic field frequency response for wireless devices with an axial field between -10 dB to -13 dB (A/m) at 1 kHz

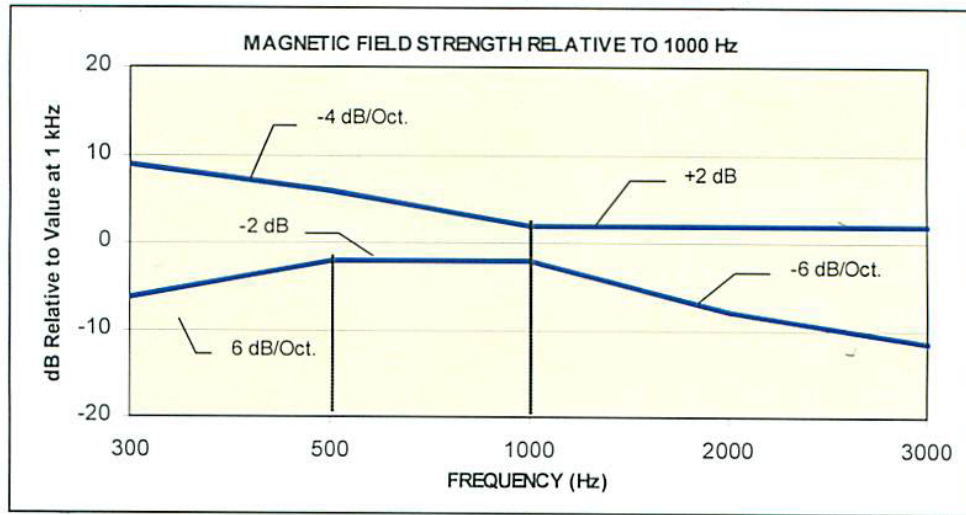

Magnetic field frequency response for wireless devices with an axial field that exceeds -10 dB (A/m) at 1 kHz

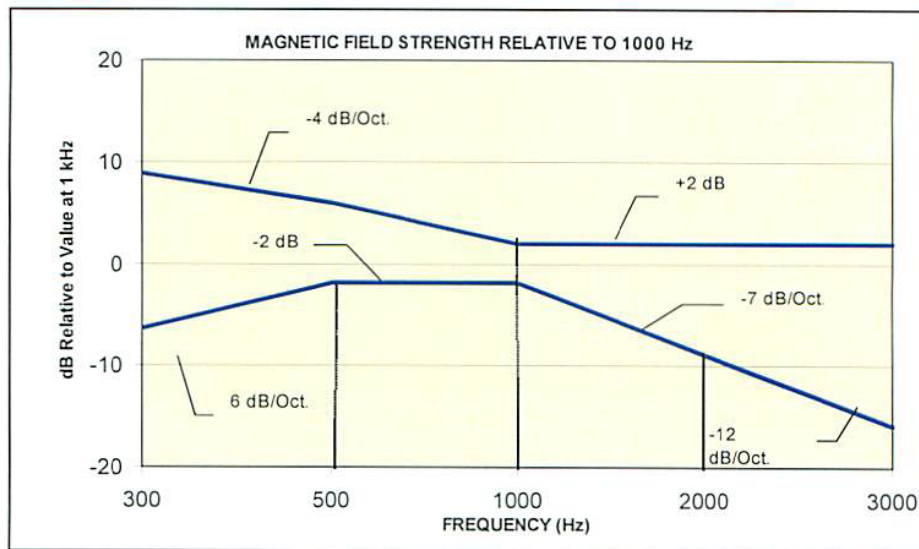

4.6 Test Setup

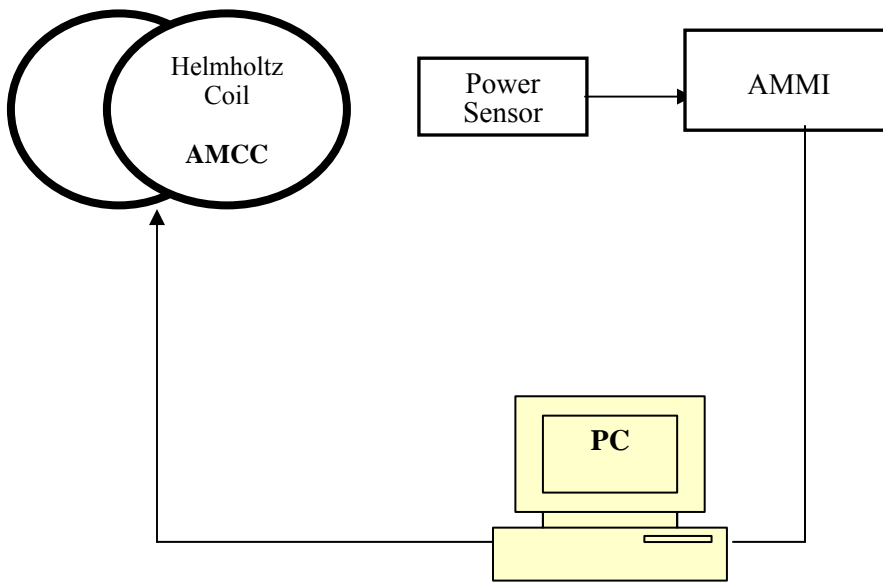

Validation Setup with Helmholtz Coil

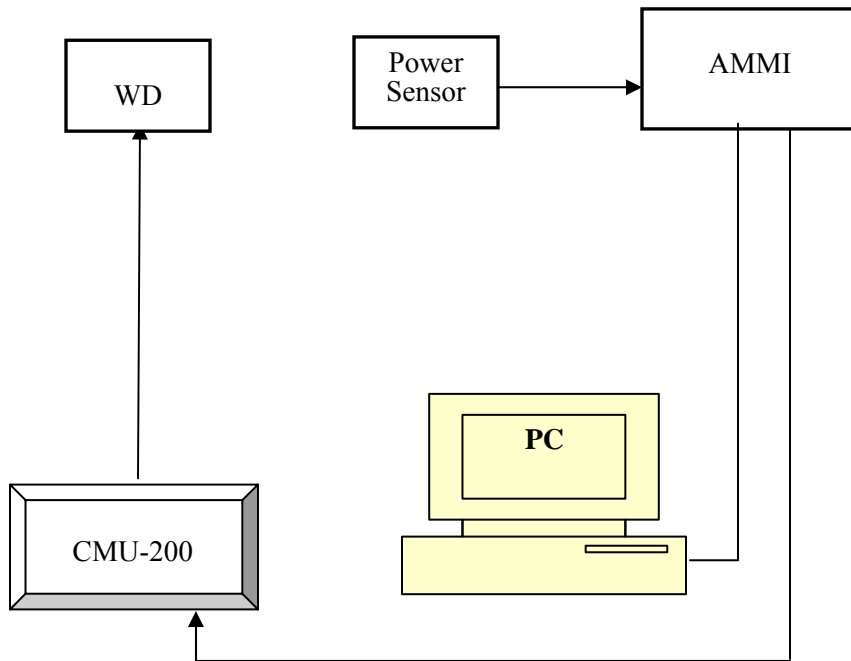

T-Coil Test Setup

4.7 Reference Input of Audio Signal Spectrum

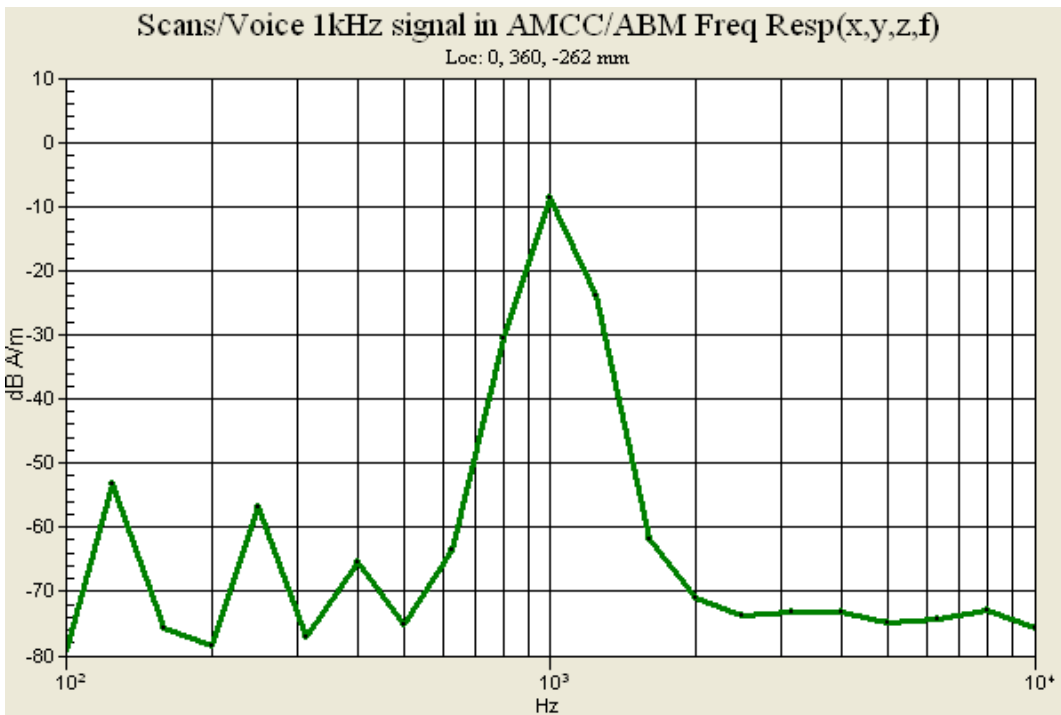
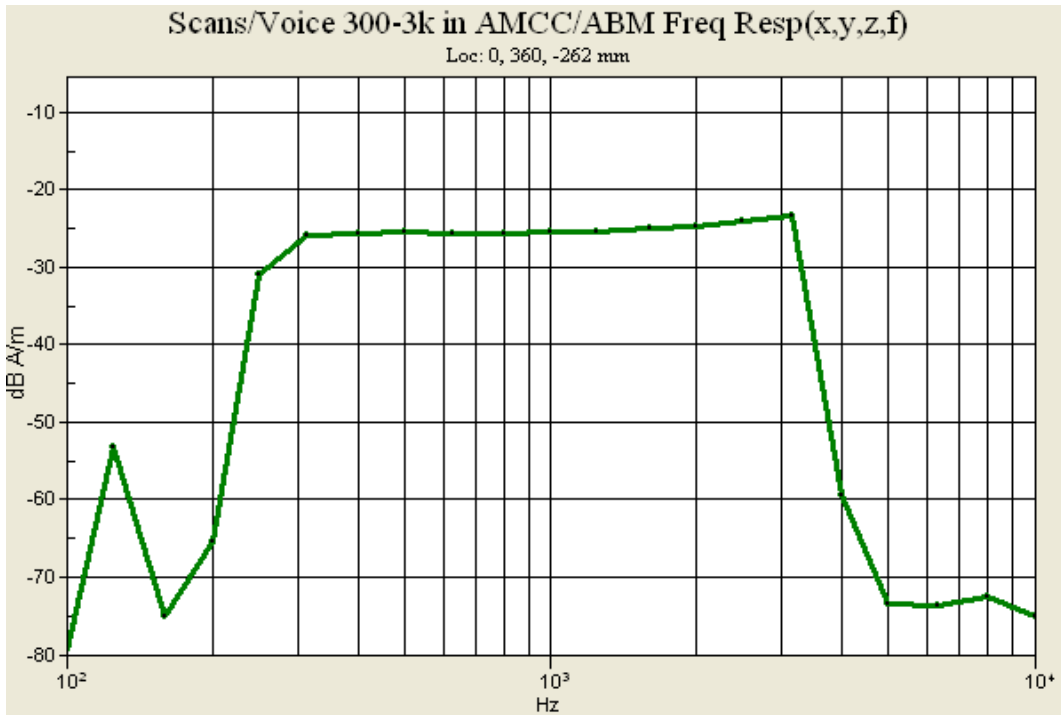

4.8 Signal Verification

According to ANSI C63.19:2007 §6.3.2.1, the following reference input levels that correlate to a normal speech input level shall be used for the standard transmission protocols:

Normal Speech Input Levels

Standard	Technology	Input (dBm0)
TIA/EIA/IS-2000	CDMA	- 18
TIA/EIA-136	TDMA (50 Hz)	- 18
J-STD-007	GSM (217)	- 16
T1/P1P1/3GPP	UMTS (WCDMA)	- 16
iDEN	TDMA (22 and 11 Hz)	- 18

This technical note shows a possibility to evaluate and set the correct level with the HAC T-Coil setup with a Rohde & Schwarz communication tester CMU200 with audio option B52 and B58.

Establish a call from the CMU200 to a wireless device, select CMU200 Network Bitstream “Decoder Cal” to have a 1 kHz signal with a level of 3.14 dBm0 at the speaker output. Run the measurement job and read the voltage level at the multi-meter display “Coil signal”. Read the RMS voltage corresponding to 3.14 dBm0 and note it. Calculate the desired signal levels of -16 dBm0.

Determine the 1 kHz input level to generate the desired signal level of -16 dBm0. Select CMU200 Network Bitstream “Codec Cal” to loop the input via the codec to the output. Run the measurement job (AMMI 1 kHz signal with gain 10 inserted) and read the voltage level at the multi-meter display “Coil signal”. Calculate the required gain setting for the above levels.

4.9 Helmholtz Coil Validation Table of Results

Item	Target	Measured dB About Target	Verdict
Signal Validation			
Frequency Response, from limits	0 + 0.5 dB	0.33	Pass
Noise Validation			
Axial Environment Noise	< - 38 dBA/m	-54.5	Pass
Radial H Environment Noise	< - 38 dBA/m	-53.8	Pass
Radial V Environment Noise	< - 38 dBA/m	-55.1	Pass

The Measurements indicate that the wireless communications device complies with the HAC limits specified in accordance with the ANSI C63.19 Standard. The tested device complies with the requirements in respect to all parameters specific to the test. The results and statements relate only to the item(s) tested.

The measurements system and techniques presented in this evaluation are proposed in the ANSI standard as a means of the best approximating wireless device compatibility with a hearing-aid. The literature is under continual re-construction.

5 MEASUREMENT UNCERTAINTY

Uncertainty Budget for HAC T-Coil							
Error Description	Uncertainty Value (±%)	Prob. Dist.	Divisor	(c i) (ABM1)	(c i) (ABM2)	Std. Unc. (ABM1)	Std. Unc. (ABM2)
Probe Sensitivity							
Reference Level	3	N	1	1	1	±3.0%	±3.0%
AMCC Geometry	0.4	R	√3	1	1	±0.2%	±0.2%
AMCC Current	1.0	R	√3	1	1	±0.6%	±0.6%
Probe Positioning During Calibration	0.1	R	√3	1	0	±0.1%	±0.1%
Noise Contribution	0.7	R	√3	0.0143	1	±0.0%	±0.4%
Frequency Slope	5.9	R	√3	0.1	1	±0.3%	±3.5%
Probe System							
Repeatability/Drift	1.0	R	√3	1	1	±0.6%	±0.6%
Linearity/Dynamic Range	0.6	R	√3	1	1	±0.4%	±0.4%
Acoustic Noise	1.0	R	√3	0.1	1	±0.1%	±0.6%
Probe Angle	2.3	R	√3	1	1	±1.4%	±1.4%
Spectral Processing	0.9	R	√3	1	1	±0.5%	±0.5%
Integration Time	0.6	N	1	1	5	±0.6%	±3.0%
Field Distribution	0.2	R	√3	1	1	±0.1%	±0.1%
Test Signal							
Reference Signal Spectral Response	0.6	R	√3	1	1	±0.0%	±0.4%
Positioning							
Probe Positioning	1.9	R	√3	1	1	±1.1%	±1.1%
Phantom Positioning	0.9	R	√3	1	1	±0.5%	±0.5%
DUT Positioning	1.9	R	√3	1	1	±1.1%	±1.1%
External Contributions							
RF Interface	0.0	R	√3	1	0.3	±0.0%	±0.0%
Test Signal Variation	2.0	R	√3	1	1	±1.2%	±1.2%
Combined Standard Uncertainty						±4.1%	±6.1%
Coverage Factor for 95%						K=2	
Expanded Uncertainty						±8.1%	±12.3%

6 HAC T-Coil MEASUREMENT RESULTS

6.1 Test Environment Conditions

Temperature:	22 °C
Relative Humidity:	43 %
ATM Pressure:	101.3 kPa

Testing was performed by Ricky Wang on 2013-10-11 in the SAR Chamber.

Table 1: Consolidated Table of worst-case Results

C63.19 Sections	Band	Test Description	Minimum Limit* (dBA/m)	Measured (dBA/m)	T-Rating
7.3.1.1	GSM 850	Intensity, Axial	-13	11.09	-
7.3.1.2		Intensity, Radial H	-18	-0.124	-
7.3.1.2		Intensity, Radial V	-18	-0.17	-
7.3.3		Signal-to-Noise/Noise, Axial	5	41.91	T4
7.3.3		Signal-to-Noise/Noise, Radial H	5	30.696	T4
7.3.3		Signal-to-Noise/Noise, Radial V	5	30.65	T4
7.3.2		Frequency Response Axial	0		-
7.3.1.1	PCS 1900	Intensity, Axial	-13	10.55	-
7.3.1.2		Intensity, Radial H	-18	4.267	-
7.3.1.2		Intensity, Radial V	-18	4.479	-
7.3.3		Signal-to-Noise/Noise, Axial	5	40.21	T4
7.3.3		Signal-to-Noise/Noise, Radial H	5	33.927	T4
7.3.3		Signal-to-Noise/Noise, Radial V	5	34.139	T4
7.3.2		Frequency Response Axial	0		-

Note: The above summary table numerical values are based on the results from table 3

Table 2: Consolidated Table of worst-case Results

	Volume Setting	GSM850	PCS1900
Frequency Response Margin	Maximum *	Pass	Pass
Magnetic Intensity Verdict		Pass	Pass
FCC SNR Verdict		Pass	Pass

Note: The above table represents the pass/fail verdict according to data in table 3

* Volume control to MAX.

Table 3: Raw Data Results

	Volume	GSM850 Band		
		Axial (Z)	Radial Longitudinal (X)	Radial Transversal (Y)
		CH 190	CH 190	CH 190
ABM1, dBA/m	Maximum *	11.09	-0.124	-0.17
ABM2, dBA/m		-30.82	-30.82	-30.82
Ambient Noise, dBA/m		-53.52	-53.52	-53.52
Frequency Response Margin (dB)		0.22	/	/
(S+N)/N (dB)		-41.91	-30.696	-30.65
(S+N)/N per orientation (dB)		41.91	30.696	30.65
T-Rating		T4	T4	T4
	Volume	PCS1900 Band		
		Axial (Z)	Radial Longitudinal (X)	Radial Transversal (Y)
		CH 661	CH 661	CH 661
ABM1, dBA/m	Maximum *	10.55	4.267	4.479
ABM2, dBA/m		-29.66	-29.66	-29.66
Ambient Noise, dBA/m		-52.52	-52.52	-52.52
Frequency Response Margin (dB)		0.38	/	/
(S+N)/N (dB)		-40.21	-33.927	-34.139
(S+N)/N per orientation (dB)		40.21	33.927	34.139
T-Rating		T4	T4	T4

Notes: 1) Power Configuration: PCL=5 (GSM850)

2) Phone Condition: Mute on; Maximum volume *

3) Voice Configuration: EFR

7 HAC T-COIL MEASUREMENT PLOTS

Frequency Responses

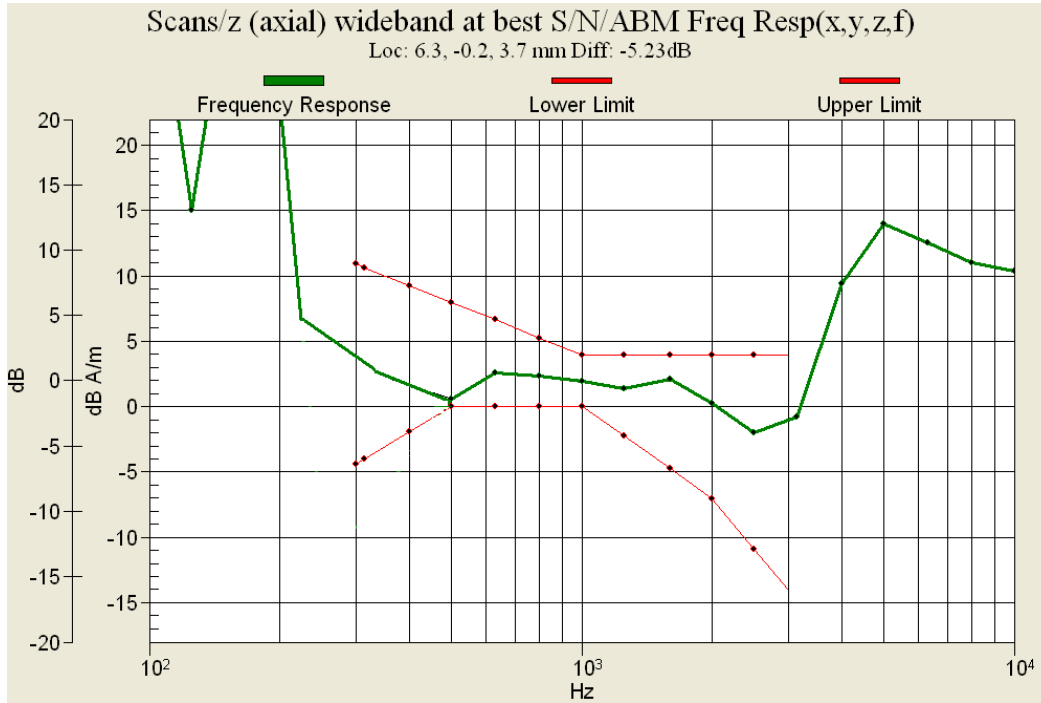

GSM850

HAC_T-Coil_835-Middle**DUT: BinaTone Electronics; Type: GSM phone; Serial: R13091610**

Communication System: GSM 850; Frequency: 836.6 MHz; Duty Cycle: 1:8.3

Medium parameters used: $\sigma = 0$ mho/m, $\epsilon_r = 1$; $\rho = 1$ kg/m³

Phantom section: TCoil Section

Measurement Standard: DAS4 (High Precision Assessment)

DASY4 Configuration:

- Probe: AM1DV2 - 1073; ; Calibrated: 1/10/2013
- Sensor-Surface: 0mm (Fix Surface)
- Electronics: DAE3 Sn456; Calibrated: 3/16/2012
- Phantom: HAC Test Arch with AMCC; Type: SD HAC P01 BA; Serial:
- Measurement SW: DAS4, V4.7 Build 80; Postprocessing SW: SEMCAD, V1.8 Build 186

Scans/z (axial) 4.2mm 50 x 50/ABM Freq Resp(x,y,z,f) (13x13x1):

Measurement grid: dx=10mm, dy=10mm

Signal Type: Audio File (.wav) 48k_voice_1kHz_1s.wav

Output Gain: 35

Measure Window Start: 0ms

Measure Window Length: 1000ms

BWC applied: 0.157003 dB

Device Reference Point: 0.000, 0.000, -6.30 mm

Cursor:

Diff = -15.0 dB

BWC Factor = 0.157003 dB

Location: 4.2, 0, 3.7 mm

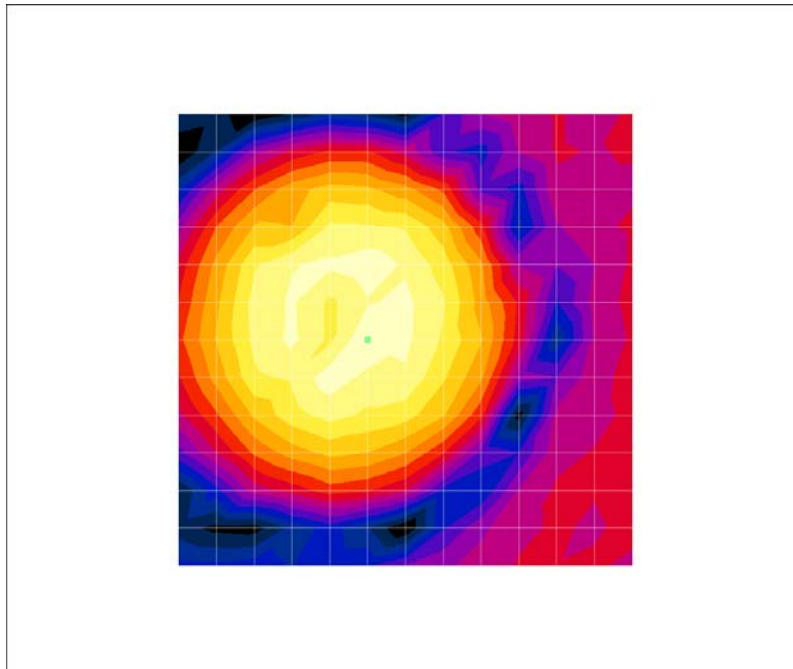

HAC_T-Coil_835-Middle**DUT: BinaTone Electronics; Type: GSM phone; Serial: R13091610**

Communication System: GSM 850; Frequency: 836.6 MHz; Duty Cycle: 1:8.3

Medium parameters used: $\sigma = 0$ mho/m, $\epsilon_r = 1$; $\rho = 1$ kg/m³

Phantom section: TCoil Section

Measurement Standard: DASYS4 (High Precision Assessment)

DASY4 Configuration:

- Probe: AM1DV2 - 1073; ; Calibrated: 1/10/2013
- Sensor-Surface: 0mm (Fix Surface)
- Electronics: DAE3 Sn456; Calibrated: 3/16/2012
- Phantom: HAC Test Arch with AMCC; Type: SD HAC P01 BA; Serial:
- Measurement SW: DASYS4, V4.7 Build 80; Postprocessing SW: SEMCAD, V1.8 Build 186

Scans/x (longitudinal) 4.2mm 50 x 50/ABM Freq Resp(x,y,z,f) (13x13x1):

Measurement grid: dx=10mm, dy=10mm

Signal Type: Audio File (.wav) 48k_voice_1kHz_1s.wav

Output Gain: 35

Measure Window Start: 0ms

Measure Window Length: 1000ms

BWC applied: 0.157003 dB

Device Reference Point: 0.000, 0.000, -6.30 mm

Cursor:

Diff = -20.8 dB

BWC Factor = 0.157003 dB

Location: -4.2, 0, 3.7 mm

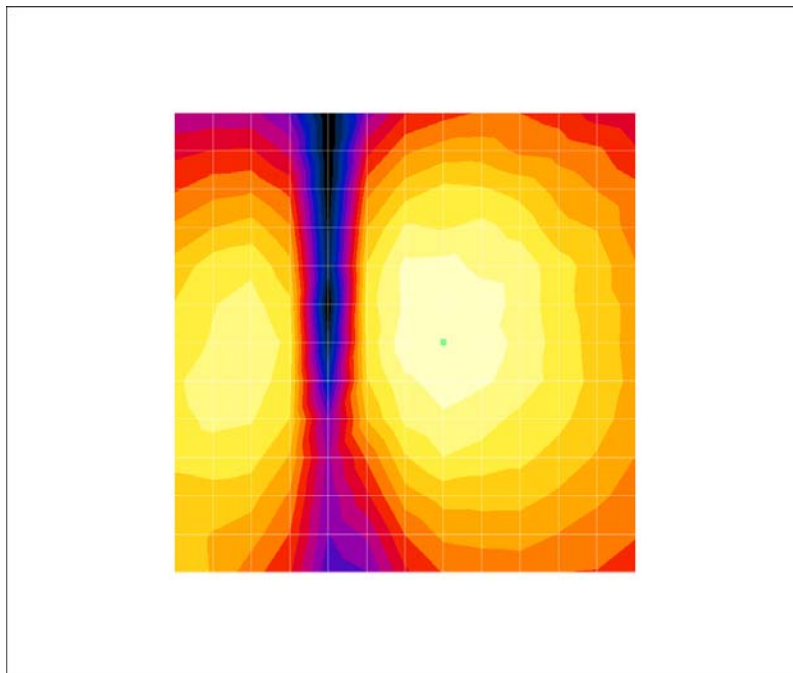

HAC_T-Coil_835-Middle**DUT: BinaTone Electronics; Type: GSM phone; Serial: R13091610**

Communication System: GSM 850; Frequency: 836.6 MHz; Duty Cycle: 1:8.3

Medium parameters used: $\sigma = 0$ mho/m, $\epsilon_r = 1$; $\rho = 1$ kg/m³

Phantom section: TCoil Section

Measurement Standard: DAS4 (High Precision Assessment)

DASY4 Configuration:

- Probe: AM1DV2 - 1073; ; Calibrated: 1/10/2013
- Sensor-Surface: 0mm (Fix Surface)
- Electronics: DAE3 Sn456; Calibrated: 3/16/2012
- Phantom: HAC Test Arch with AMCC; Type: SD HAC P01 BA; Serial:
- Measurement SW: DAS4, V4.7 Build 80; Postprocessing SW: SEMCAD, V1.8 Build 186

Scans/y (transversal) 4.2mm 50 x 50/ABM Freq Resp(x,y,z,f) (13x13x1):

Measurement grid: dx=10mm, dy=10mm

Signal Type: Audio File (.wav) 48k_voice_1kHz_1s.wav

Output Gain: 35

Measure Window Start: 0ms

Measure Window Length: 1000ms

BWC applied: 0.157003 dB

Device Reference Point: 0.000, 0.000, -6.30 mm

Cursor:

Diff = -13.6 dB

BWC Factor = 0.157003 dB

Location: 4.2, -25, 3.7 mm

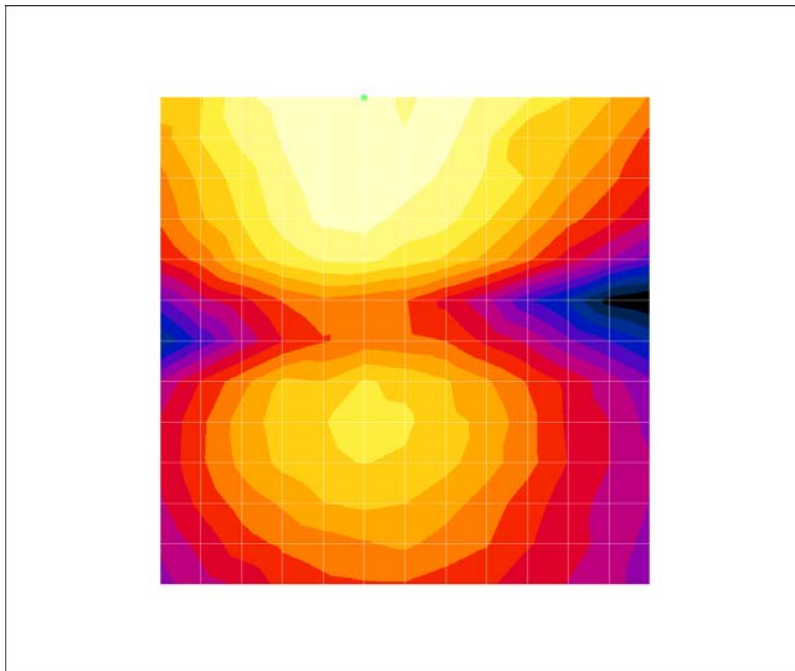

Frequency Responses

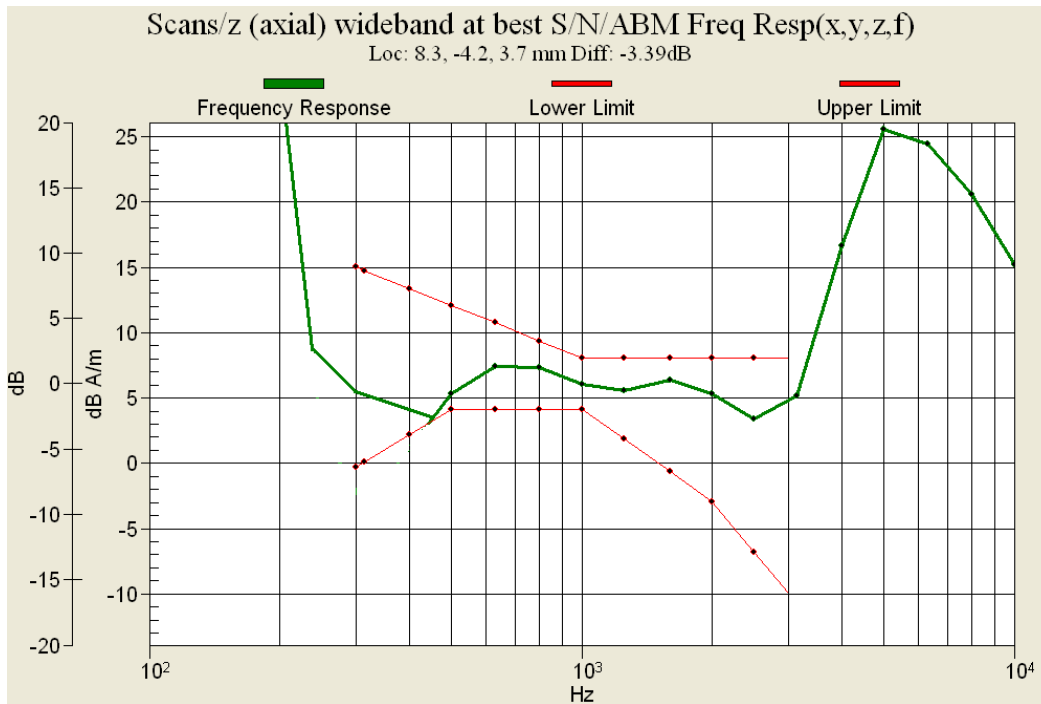

PCS1900

HAC_T-Coil_1900-Middle1**DUT: BinaTone Electronics; Type: GSM phone; Serial: R13091610**

Communication System: PCS 1900; Frequency: 1880 MHz; Duty Cycle: 1:8.3

Medium parameters used: $\sigma = 0$ mho/m, $\epsilon_r = 1$; $\rho = 1$ kg/m³

Phantom section: TCoil Section

Measurement Standard: DAS4 (High Precision Assessment)

DASY4 Configuration:

- Probe: AM1DV2 - 1073; ; Calibrated: 1/10/2013
- Sensor-Surface: 0mm (Fix Surface)
- Electronics: DAE3 Sn456; Calibrated: 3/16/2012
- Phantom: HAC Test Arch with AMCC; Type: SD HAC P01 BA; Serial:
- Measurement SW: DAS4, V4.7 Build 80; Postprocessing SW: SEMCAD, V1.8 Build 186

Scans/z (axial) 4.2mm 50 x 50/ABM Freq Resp(x,y,z,f) (13x13x1):

Measurement grid: dx=10mm, dy=10mm

Signal Type: Audio File (.wav) 48k_voice_1kHz_1s.wav

Output Gain: 35

Measure Window Start: 0ms

Measure Window Length: 1000ms

BWC applied: 0.154017 dB

Device Reference Point: 0.000, 0.000, -6.30 mm

Cursor:

Diff = -11.9 dB

BWC Factor = 0.154017 dB

Location: 8.3, 0, 3.7 mm

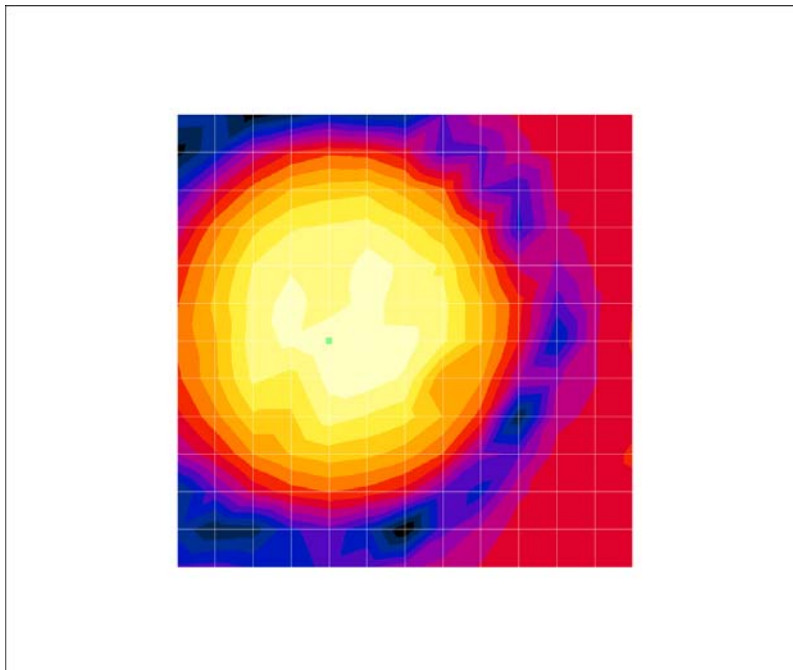

HAC_T-Coil_1900-Middle1**DUT: BinaTone Electronics; Type: GSM phone; Serial: R13091610**

Communication System: PCS 1900; Frequency: 1880 MHz; Duty Cycle: 1:8.3

Medium parameters used: $\sigma = 0$ mho/m, $\epsilon_r = 1$; $\rho = 1$ kg/m³

Phantom section: TCoil Section

Measurement Standard: DAS4 (High Precision Assessment)

DASY4 Configuration:

- Probe: AM1DV2 - 1073; ; Calibrated: 1/10/2013
- Sensor-Surface: 0mm (Fix Surface)
- Electronics: DAE3 Sn456; Calibrated: 3/16/2012
- Phantom: HAC Test Arch with AMCC; Type: SD HAC P01 BA; Serial:
- Measurement SW: DAS4, V4.7 Build 80; Postprocessing SW: SEMCAD, V1.8 Build 186

Scans/x (longitudinal) 4.2mm 50 x 50/ABM Freq Resp(x,y,z,f) (13x13x1):

Measurement grid: dx=10mm, dy=10mm

Signal Type: Audio File (.wav) 48k_voice_1kHz_1s.wav

Output Gain: 35

Measure Window Start: 0ms

Measure Window Length: 1000ms

BWC applied: 0.154017 dB

Device Reference Point: 0.000, 0.000, -6.30 mm

Cursor:

Diff = -18.0 dB

BWC Factor = 0.154017 dB

Location: -4.2, -4.2, 3.7 mm

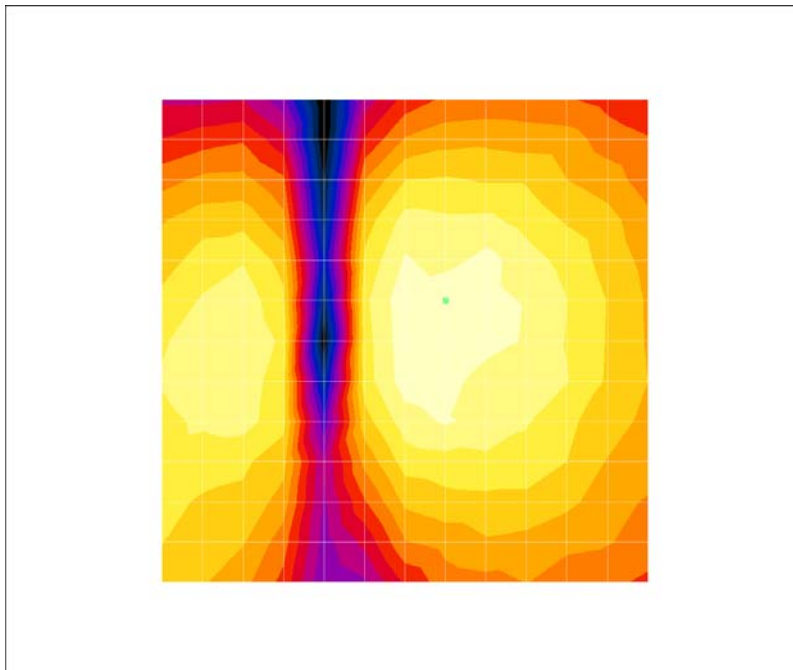

HAC_T-Coil_1900-Middle1**DUT: BinaTone Electronics; Type: GSM phone; Serial: R13091610**

Communication System: PCS 1900; Frequency: 1880 MHz; Duty Cycle: 1:8.3

Medium parameters used: $\sigma = 0$ mho/m, $\epsilon_r = 1$; $\rho = 1$ kg/m³

Phantom section: TCoil Section

Measurement Standard: DAS4 (High Precision Assessment)

DASY4 Configuration:

- Probe: AM1DV2 - 1073; ; Calibrated: 1/10/2013
- Sensor-Surface: 0mm (Fix Surface)
- Electronics: DAE3 Sn456; Calibrated: 3/16/2012
- Phantom: HAC Test Arch with AMCC; Type: SD HAC P01 BA; Serial:
- Measurement SW: DAS4, V4.7 Build 80; Postprocessing SW: SEMCAD, V1.8 Build 186

Scans/y (transversal) 4.2mm 50 x 50/ABM Freq Resp(x,y,z,f) (13x13x1):

Measurement grid: dx=10mm, dy=10mm

Signal Type: Audio File (.wav) 48k_voice_1kHz_1s.wav

Output Gain: 35

Measure Window Start: 0ms

Measure Window Length: 1000ms

BWC applied: 0.154017 dB

Device Reference Point: 0.000, 0.000, -6.30 mm

Cursor:

Diff = -12.1 dB

BWC Factor = 0.154017 dB

Location: -4.2, -20.8, 3.7 mm

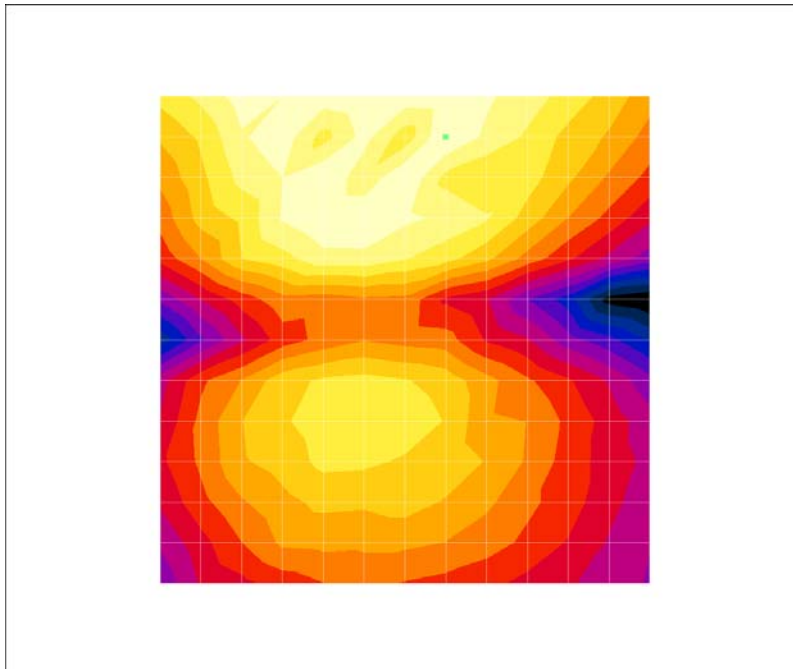

8 APPENDIX A – PROBE CALIBRATION CERTIFICATES

**Calibration Laboratory of
Schmid & Partner
Engineering AG**
Zeughausstrasse 43, 8004 Zurich, Switzerland



S Schweizerischer Kalibrierdienst
C Service suisse d'étalonnage
S Servizio svizzero di taratura
S Swiss Calibration Service

Accredited by the Swiss Accreditation Service (SAS)
The Swiss Accreditation Service is one of the signatories to the EA
Multilateral Agreement for the recognition of calibration certificates

Accreditation No.: **SCS 108**

Client **BACL**

Certificate No: **AM1DV2-1073_Jan13**

CALIBRATION CERTIFICATE

Object: AM1DV2 - SN: 1073

Calibration procedure(s): QA CAL-24.v3
Calibration procedure for AM1D magnetic field probes and TMFS in the audio range

Calibration date: January 10, 2013

This calibration certificate documents the traceability to national standards, which realize the physical units of measurements (SI). The measurements and the uncertainties with confidence probability are given on the following pages and are part of the certificate.

All calibrations have been conducted in the closed laboratory facility: environment temperature (22 ± 3)°C and humidity < 70%.

Calibration Equipment used (M&TE critical for calibration)

Primary Standards	ID #	Cal Date (Certificate No.)	Scheduled Calibration
Keithley Multimeter Type 2001	SN: 0810278	02-Oct-12 (No:12728)	Oct-13
Reference Probe AM1DV2	SN: 1008	10-Jan-13 (No. AM1D-1008_Jan13)	Jan-14
DAE4	SN: 781	29-May-12 (No. DAE4-781_May12)	May-13

Secondary Standards	ID #	Check Date (in house)	Scheduled Check
AMCC	1050	12-Oct-11 (in house check Oct-11)	Oct-13
AMMI Audio Measuring Instrument	1052	26-Sep-12 (in house check Sep-12)	Sep-14

Calibrated by: **Dimce Iliev** (Name), **Laboratory Technician** (Function), *D. Iliev* (Signature)

Approved by: **Fin Bornholt** (Name), **Deputy Technical Manager** (Function), *F. Bornholt* (Signature)

Issued: January 10, 2013

This calibration certificate shall not be reproduced except in full without written approval of the laboratory.

References

- [1] ANSI C63.19-2007
American National Standard for Methods of Measurement of Compatibility between Wireless Communications Devices and Hearing Aids.
- [2] DASY5 manual, Chapter: Hearing Aid Compatibility (HAC) T-Coil Extension

Description of the AM1D probe

The AM1D Audio Magnetic Field Probe is a fully shielded magnetic field probe for the frequency range from 100 Hz to 20 kHz. The pickup coil is compliant with the dimensional requirements of [1]. The probe includes a symmetric low noise amplifier for the signal available at the shielded 3 pin connector at the side. Power is supplied via the same connector (phantom power supply) and monitored via the LED near the connector. The 7 pin connector at the end of the probe does not carry any signals, but determines the angle of the sensor when mounted on the DAE. The probe supports mechanical detection of the surface.

The single sensor in the probe is arranged in a tilt angle allowing measurement of 3 orthogonal field components when rotating the probe by 120° around its axis. It is aligned with the perpendicular component of the field, if the probe axis is tilted nominally 35.3° above the measurement plane, using the connector rotation and sensor angle stated below.

The probe is fully RF shielded when operated with the matching signal cable (shielded) and allows measurement of audio magnetic fields in the close vicinity of RF emitting wireless devices according to [1] without additional shielding.

Handling of the item

The probe is manufactured from stainless steel. In order to maintain the performance and calibration of the probe, it must not be opened. The probe is designed for operation in air and shall not be exposed to humidity or liquids. For proper operation of the surface detection and emergency stop functions in a DASY system, the probe must be operated with the special probe cup provided (larger diameter).

Methods Applied and Interpretation of Parameters

- *Coordinate System:* The AM1D probe is mounted in the DASY system for operation with a HAC Test Arch phantom with AMCC Helmholtz calibration coil according to [2], with the tip pointing to "southwest" orientation.
- *Functional Test:* The functional test preceding calibration includes test of Noise level
RF immunity (1kHz AM modulated signal). The shield of the probe cable must be well connected. Frequency response verification from 100 Hz to 10 kHz.
- *Connector Rotation:* The connector at the end of the probe does not carry any signals and is used for fixation to the DAE only. The probe is operated in the center of the AMCC Helmholtz coil using a 1 kHz magnetic field signal. Its angle is determined from the two minima at nominally +120° and -120° rotation, so the sensor in the tip of the probe is aligned to the vertical plane in z-direction, corresponding to the field maximum in the AMCC Helmholtz calibration coil.
- *Sensor Angle:* The sensor tilting in the vertical plane from the ideal vertical direction is determined from the two minima at nominally +120° and -120°. DASY system uses this angle to align the sensor for radial measurements to the x and y axis in the horizontal plane.
- *Sensitivity:* With the probe sensor aligned to the z-field in the AMCC, the output of the probe is compared to the magnetic field in the AMCC at 1 kHz. The field in the AMCC Helmholtz coil is given by the geometry and the current through the coil, which is monitored on the precision shunt resistor of the coil.

AM1D probe identification and configuration data

Item	AM1DV2 Audio Magnetic 1D Field Probe
Type No	SP AM1 001 AF
Serial No	1073

Overall length	296 mm
Tip diameter	6.0 mm (at the tip)
Sensor offset	3.0 mm (centre of sensor from tip)
Internal Amplifier	40 dB

Manufacturer / Origin	Schmid & Partner Engineering AG, Zurich, Switzerland
Manufacturing date	May-2008
Last calibration date	February 01, 2012

Calibration data

Connector rotation angle	(in DASY system)	81.3 °	+/- 3.6 ° (k=2)
Sensor angle	(in DASY system)	- 0.25 °	+/- 0.5 ° (k=2)
Sensitivity at 1 kHz	(in DASY system)	0.0661 V / (A/m)	+/- 2.2 % (k=2)

The reported uncertainty of measurement is stated as the standard uncertainty of measurement multiplied by the coverage factor k=2, which for a normal distribution corresponds to a coverage probability of approximately 95%.

9 APPENDIX B – OUTPUT POWER MEASUREMENT

9.1 Test Block Diagram and Procedure

The RF output of the transmitter was connected to the input of the spectrum analyzer through sufficient attenuation.

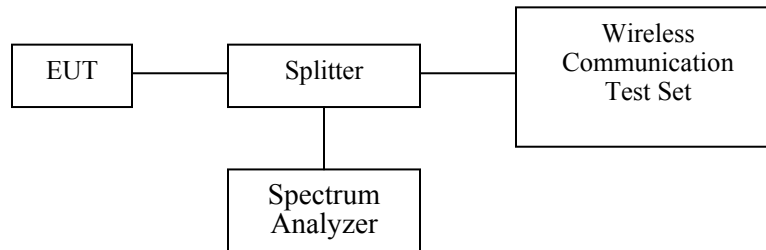

9.2 Test Equipment List and Details

Manufacturer	Description	Model No.	Serial No.	Calibration Due Date
Rohde & Schwarz	Analyzer Communication	CMU200	103492	2014-06-22
Agilent	Spectrum Analyzer	E4440A	US45303156	2014-08-09

9.3 Test Results

Band	Frequency (MHz)	GSM Conducted Output Power (dBm)
GSM850	824.2	32.48
	836.6	32.45
	848.8	32.40
PCS1900	1850.2	29.25
	1880.0	29.30
	1909.8	29.33

10 APPENDIX C – TEST SETUP PHOTOS

10.1 T-Coil Test Setup Photo

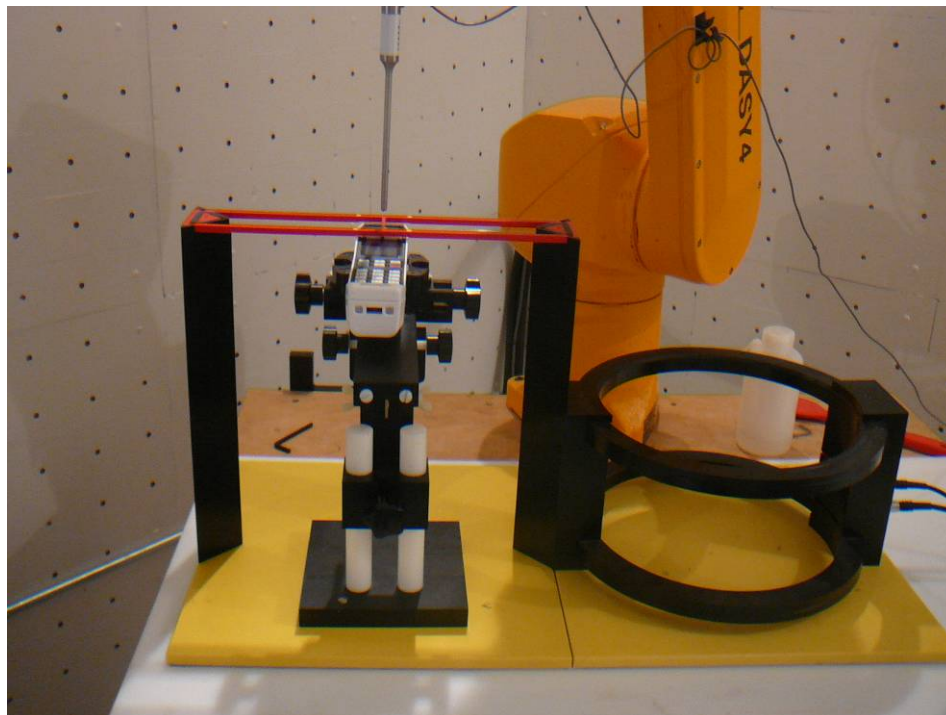

11 APPENDIX G – EUT PHOTOGRAPHS

11.1 EUT – Front View



11.2 EUT – Bottom View



11.3 EUT – Battery Compartment View

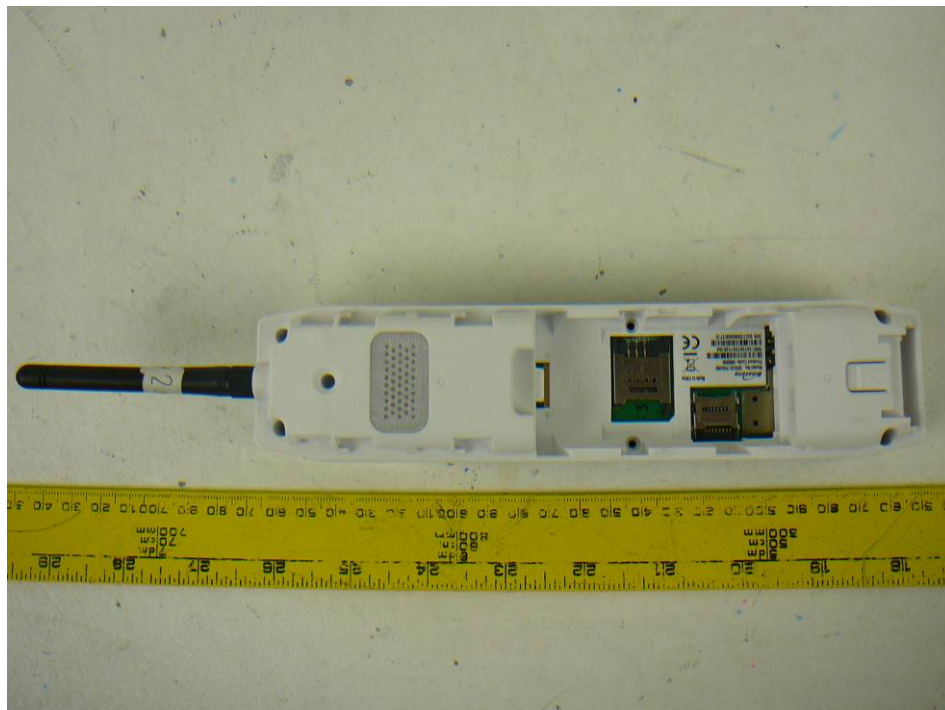

12 APPENDIX E - INFORMATIVE REFERENCES

[1] ANSI C63.19:2007. American National Standard, Methods of Measurement of Compatibility between Wireless Communications Devices and Hearing Aids

[2] CFR47, Part20.19, Federal Communications Commission (FCC), Hearing Aid-Compatible Mobile Handsets

[3] FCC 08-68 A1, A2, A3, A4, A5, WT Docket 07-250, February 28, 2008.

[4] FCC OET KDB 285076, Equipment Authorization Guidance for Hearing Aid Compability.

--- END OF REPORT ---