



Hearing Aid Compatibility (HAC) RF EMISSIONS TEST REPORT

For

Binatone Electronics International Ltd.

Floor 23A, 9 Des Voeux Road West, Sheung Wan, Hong Kong, China

FCC ID: VLJ-THEBRICK

Report Type: Original Report	Product Type: GSM Mobile Phone
Test Engineer: Ricky Wang	<i>Ricky</i>
Report Number: R13061610-HAC-M	
Report Date: 2013-10-16	
Reviewed By: Victor Zhang EMC/RF lead	<i>Victor Zhang</i>
Prepared By: Bay Area Compliance Laboratories Corp. 1274 Anvilwood Avenue, Sunnyvale, CA 94089, USA Tel: (408) 732-9162 Fax: (408) 732 9164	

Note: This test report is prepared for the customer shown above and for the device described herein. It may not be duplicated or used in part without prior written consent from Bay Area Compliance Laboratories Corp. This report must not be used by the customer to claim product certification, approval, or endorsement by A2LA* or any agency of the Federal Government. * This report may contain data that are not covered by the A2LA accreditation and are marked with an asterisk "*" (Rev.3)

HEARING AID COMPATIBILITY DECLARATION OF COMPLIANCE

FCC Rule Part(s):	CFR 47 §20.19
HAC Test Procedure(s):	ANSI C63.19-2007
Device Category:	Portable Transmitter Held to Ear
Modulation Type:	GMSK
TX Frequency Range:	824.2-848.8 MHz (Cellular Band) 1850.2-1909.8 MHz (PCS Band)
Maximum Conducted Power:	32.48 dBm (Cellular Band) 29.33 dBm (PCS Band)
Battery Type (s) Tested:	3.7 V

M Category = M3 (ANSI C63.19-2007)

BACL Corp. declares under its sole responsibility that this wireless portable device has been tested for Hearing Aid Compatibility in accordance with the measurement procedures specified in ANSI C63.19-2007.

All measurements reported herein were performed under my supervision and believed to be accurate to the best of my knowledge. I further attest for the completeness of these measurements and vouch for the qualifications any and all personnel performing such measurements.

The results and statements contained in this report pertain only to the device(s) evaluated.



TABLE OF CONTENTS

1	GENERAL INFORMATION	6
1.1	PRODUCT DESCRIPTION FOR THE EUT	6
1.2	TEST FACILITIES AND ACCREDITATION	6
2	STANDARDS AND GUIDELINES.....	7
2.1	APPLICATION STANDARDS	7
3	DESCRIPTION OF TEST SYSTEM.....	9
3.1	MEASUREMENT SYSTEM DIAGRAM	10
3.2	SYSTEM COMPONENTS	11
3.3	DASY4 MEASUREMENT SERVER.....	11
3.4	DATA ACQUISITION ELECTRONICS.....	12
3.5	LIGHT BEAM UNIT	12
3.6	ROBOT	12
3.7	E-FIELD AND H-FIELD PROBES	13
3.8	PROBES TIP DESCRIPTION	14
3.9	DEVICE HOLDER AND PHANTOM.....	14
3.10	INSTALLATION OF THE TEST ARCH PHANTOM	14
3.11	MOUNTING OF A CALIBRATION DIPOLE	15
3.12	MOUNTING THE DUT.....	15
3.13	SYSTEM VALIDATION KITS	16
3.14	PROBE MODULATION FACTOR	16
4	TESTING EQUIPMENT LIST AND DETAILS	17
5	HAC MEASUREMENT SYSTEM VERIFICATION.....	18
5.1	PURPOSE OF SYSTEM PERFORMANCE CHECK.....	18
5.2	SYSTEM PERFORMANCE CHECK SETUP	18
5.3	SYSTEM VALIDATION RESULTS	19
6	HAC RF EMISSIONS TEST PROCEDURE.....	24
6.1	TEST INSTRUCTIONS.....	24
6.2	TEST SETUP.....	24
6.3	NEAR-FIELD TEST PROCEDURE.....	26
7	MEASUREMENT UNCERTAINTY	27
8	HAC MEASUREMENT SUMMARY	28
8.1	HAC TEST DATA	28
8.2	TEST ENVIRONMENTAL CONDITIONS	28
9	APPENDIX A – HAC MEASUREMENT RESULTS	29
10	APPENDIX B – PROBE CALIBRATION CERTIFICATIONS.....	41
11	APPENDIX C – DIPOLE CALIBRATION CERTIFICATES.....	61
12	APPENDIX D – OUTPUT POWER MEASUREMENT.....	73
12.1	TEST BLOCK DIAGRAM AND PROCEDURE	73
12.2	TEST EQUIPMENT LIST AND DETAILS.....	73
12.3	TEST RESULTS	73
13	APPENDIX F – TEST SETUP PHOTOS	74

13.1 E-FIELD SETUP VIEW 74
13.2 H-FIELD SETUP VIEW 74
14 APPENDIX G – EUT PHOTOGRAPHS..... 75
14.1 EUT – FRONT VIEW 75
14.2 EUT – BOTTOM VIEW 75
14.3 EUT – BATTERY COMPARTMENT VIEW 76
15 APPENDIX H - REFERENCES..... 77

DOCUMENT REVISION HISTORY

Revision Number	Report Number	Description of Revision	Date of Revision
0	R13091610-HAC-M	Original Report	2013-10-16

1 GENERAL INFORMATION

1.1 Product Description for the EUT

This Bay Area Compliance Laboratories Corp. HAC Report is prepared on behalf of *Binatone Electronics International Ltd.*, and their product GSM Mobile Phone, FCC ID: VLJ-THEBRICK, Model: The Brick Power, or the EUT (Equipment Under Test,) as referred to in the rest of this report.

The test data gathered are from typical production sample, serial number: R13091610, provided by BACL Corp.

Item	Content
Modulation	GMSK
TX Frequency	Cellular Band: 824.2-848.8 MHz PCS Band: 1850.2-1909.8 MHz
Dimensions (L x W x H)	200mm(L)×48mm(W)×42mm (H)
Weight	275.5g
Power Source	3.7 V
Operation Mode	Head and Body-worn

1.2 Test Facilities and Accreditation

The test site used by BACL Corp. to collect radiated and conducted emissions measurement data is located at its facility in Sunnyvale, California, USA.

The test site at BACL Corp. has been fully described in reports submitted to the Federal Communication Commission (FCC) and Voluntary Control Council for Interference (VCCI). The details of these reports have been found to be in compliance with the requirements of Section 2.948 of the FCC Rules on February 11 and December 10, 1997, and Article 8 of the VCCI regulations on December 25, 1997. The test site also complies with the test methods and procedures set forth in CISPR 22:2008 §10.4 for measurements below 1 GHz and §10.6 for measurements above 1 GHz as well as ANSI C63.4-2003, ANSI C63.4-2009, TIA/EIA-603 & CISPR 24:2010.

The Federal Communications Commission and Voluntary Control Council for Interference have the reports on file and they are listed under FCC registration number: 90464 and VCCI Registration No.: A-0027. The test site has been approved by the FCC and VCCI for public use and is listed in the FCC Public Access Link (PAL) database.

Additionally, BACL Corp. is an American Association for laboratory Accreditation (A2LA) accredited laboratory (Lab Code 3297-02). The current scope of accreditations can be found at

<http://www.a2la.org/scopepdf/3297-02.pdf?CFID=1132286&CFTOKEN=e42a3240dac3f6ba-6DE17DCB-1851-9E57-477422F667031258&jsessionid=8430d44f1f47cf2996124343c704b367816b>

2 STANDARDS AND GUIDELINES

2.1 Application Standards

This report describes the methodology and results of experiments performed on wireless data terminal. The objective was to assess the electromagnetic characteristics and operational compatibility and accessibility of hearing aids used with wireless communications devices, including cordless, cellular, and personal communications service (PCS) phones, operating in the range of 800 MHz to 3 GHz.

ANSI C63.19 Clause 7 provides the requirements for acceptable interoperability of hearing aids with wireless devices. When these requirements are met, as defined by the tests described in this standard, a hearing aid operates acceptably with a WD.

Compatibility Tests involved:

The standard calls for wireless communications device to be measured for:

- 1) RF Electric-field emissions
- 2) RF Magnetic-field emissions
- 3) T-coil mode, magnetic-signal strength in the audio band.
- 4) T-coil mode, magnetic-signal frequency response through the audio band.
- 5) T-coil mode, magnetic-signal and noise articulation index

The hearing aid must be measured for:

- 1) RF immunity in microphone mode
- 2) RF immunity in T-coil mode

The categories begin with a minimal level of performance, which is described as “usable.” From this minimum level, steps are provided for both the WD and hearing aid. Improvement in either device moves the performance first to the “regular use” and then to the “excellent performance” categories.

In addition to immunity and emission requirements, hearing aid response performance, as measured by gain, can be adversely affected by WD RF interference. The criterion established Clause 7 sets the requirement for achieving these levels and gain requirements.

The values in Table 1 are built on a set of premises, which are documented in items a) through d).

- a) First, 80 dB(SPL) is assumed as the level of the intended audio input signal.
- b) Secondly, the values given are for an equivalent CW signal. Thus, for hearing aid immunity testing, a CW signal is used to establish a field at the specified RF power level. Then the signal is modulated with 1 kHz, 80% AM modulation for the test. Thus, the peak field strength for the test is higher than the CW level by the increase created by the modulation. In a reciprocal fashion, the peak field emissions from the WD are measured. These are then adjusted by the computed AWF, which reflects the interference potential of the modulation method used.
- c) Finally, the hearing aid gain deviation is a measurement of the gain response change of the hearing aid when exposed to the E- and H-fields created by the dipole.
- d) The category levels represent available volume control adjustment availability. For instance, if the volume control requires 4 dB to 6 dB of adjustment to use the WD, it is considered within the residual reserve gain of the hearing aid but may become a problem during normal use and therefore is considered usable but not acceptable for regular use.

Where a value is contained in two categories, the stricter limit applies.

Table 1—Hearing aid and telephone near-field parameters

Category		Telephone RF parameters < 960 MHz			
Near field	AWF	E-field emissions		H-field emissions	
Category M1/T1	0	631.0 to 1122.0	V/m	1.91 to 3.39	A/m
	-5	473.2 to 841.4	V/m	1.43 to 2.54	A/m
Category M2/T2	0	354.8 to 631.0	V/m	1.07 to 1.91	A/m
	-5	266.1 to 473.2	V/m	0.80 to 1.43	A/m
Category M3/T3	0	199.5 to 354.8	V/m	0.60 to 1.07	A/m
	-5	149.6 to 266.1	V/m	0.45 to 0.80	A/m
Category M4/T4	0	< 199.5	V/m	< 0.60	A/m
	-5	< 149.6	V/m	< 0.45	A/m

Category		Telephone RF parameters > 960 MHz			
Near field	AWF	E-field emissions		H-field emissions	
Category M1/T1	0	199.5 to 354.8	V/m	0.60 to 1.07	A/m
	-5	149.6 to 266.1	V/m	0.45 to 0.80	A/m
Category M2/T2	0	112.2 to 199.5	V/m	0.34 to 0.60	A/m
	-5	84.1 to 149.6	V/m	0.25 to 0.45	A/m
Category M3/T3	0	63.1 to 112.2	V/m	0.19 to 0.34	A/m
	-5	47.3 to 84.1	V/m	0.14 to 0.25	A/m
Category M4/T4	0	< 63.1	V/m	< 0.19	A/m
	-5	< 47.3	V/m	< 0.14	A/m

Equipment, which is categorized according to these requirements, shall be coordinated according to Table 2. It should be noted that because the common interference response of hearing aid circuitry is proportional to the square of the RF field, a 5 dB change in the RF yields a 10 dB change in the interference level.

Table 2—System performance classification table

System classification	Articulation index (AI)	Category sum of hearing aid category + telephone category
Usable	0.3	Hearing aid category + telephone category = 4
Normal use	0.5	Hearing aid category + telephone category = 5
Excellent performance	0.7	Hearing aid category + telephone category = ≥6

3 DESCRIPTION OF TEST SYSTEM

These measurements were performed with the automated near-field scanning system DASY4 from Schmid & Partner Engineering AG (SPEAG) which is the fourth generation of the system shown in the figure hereinafter:



The system is based on a high precision robot (working range greater than 0.9m), which positions the probes with a positional repeatability of better than $\pm 0.02\text{mm}$. Special E- and H-field probes have been developed for measurements close to material discontinuity, the sensors of which are directly loaded with a Schottky diode and connected via highly resistive lines to the data acquisition unit.

3.1 Measurement System Diagram

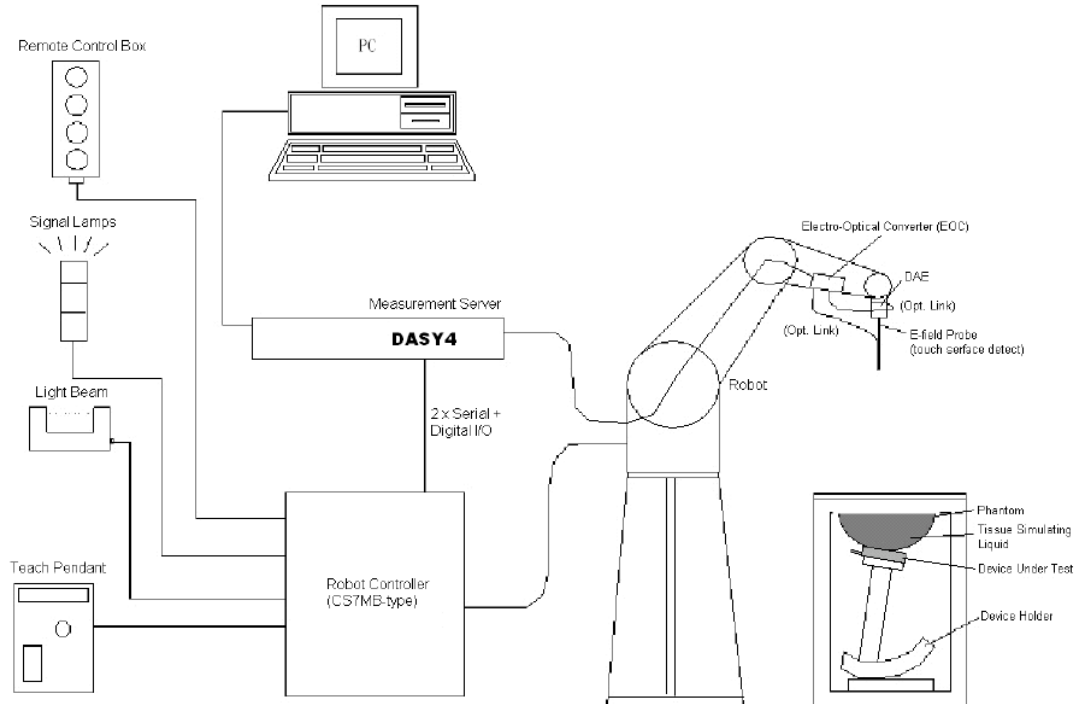

The DASY4 system for performing compliance tests consists of the following items:

- A standard high precision 6-axis robot (Stäubli RX family) with controller, teach pendant and software. An arm extension for accommodating the data acquisition electronics (DAE).
- A dosimetric probe, i.e., an isotropic E-field probe optimized and calibrated for usage in tissue simulating liquid. The probe is equipped with an optical surface detector system.
- A Data Acquisition Electronics (DAE) which performs the signal amplification, signal multiplexing, AD-conversion, offset measurements, mechanical surface detection, collision detection, etc. The unit is battery powered with standard or rechargeable batteries. The signal is optically transmitted to the EOC.
- The Electro-Optical Converter (EOC) performs the conversion between optical and electrical of the signals for the digital communication to the DAE and for the analog signal from the optical surface detection. The EOC is connected to the measurement server.
- The function of the measurement server is to perform the time critical tasks such as signal filtering, control of the robot operation and fast movement interrupts.
- A probe alignment unit which improves the (absolute) accuracy of the probe positioning.
- A computer operating Windows XP.
- DASY4 software.

Remote control with teach pendant and additional circuitry for robot safety such as warning lamps, etc.

- The SAM twin phantom.
- The device holder for handheld mobile phones.
- Dipole for evaluating the proper functioning of the system.
- Arch Phantom.
- Validation dipole kits allowing it to validate the proper functioning of the system.

3.2 System Components

- DASY4 Measurement Server
- Data Acquisition Electronics
- Probes
- Light Beam Unit
- Medium
- SAM Twin Phantom
- Device Holder for SAM Twin Phantom
- System Validation Kits
- Robot

3.3 DASY4 Measurement Server

The DASY4 measurement server is based on a PC/104 CPU board with a 166MHz low-power Pentium, 32MB chip disk and 64MB RAM. The necessary circuits for communication with either the DAE4 (or DAE3) electronic box as well as the 16-bit AD-converter system for optical detection and digital I/O interface are contained on the DASY4 I/O-board, which is directly connected to the PC/104 bus of the CPU board.



The measurement server performs all real-time data evaluation for field measurements and surface detection, controls robot movements and handles safety operation. The PC-operating system cannot interfere with these time critical processes. All connections are supervised by a watchdog, and disconnection of any of the cables to the measurement server will automatically disarm the robot and disable all program-controlled robot movements. Furthermore, the measurement server is equipped with two expansion slots which are reserved for future applications. Please note that the expansion slots do not have a standardized pinout and therefore only the expansion cards provided by SPEAG can be inserted. Expansion cards from any other supplier could seriously damage the measurement server.

3.4 Data Acquisition Electronics

The data acquisition electronics DAE3 consists of a highly sensitive electrometer grade preamplifier with auto-zeroing, a channel and gain-switching multiplexer, a fast 16 bit AD-converter and a command decoder and control logic unit. Transmission to the measurement server is accomplished through an optical downlink for data and status information as well as an optical uplink for commands and the clock.



3.5 Light Beam Unit

The light beam switch allows automatic “tooling” of the probe. During the process, the actual position of the probe tip with respect to the robot arm is measured, as well as the probe length and the horizontal probe offset. The software then corrects all movements, so that the robot coordinates are valid for the probe tip. The repeatability of this process is better than 0.1 mm. If a position has been taught with an aligned probe, the same position will be reached with another aligned probe within 0.1 mm, even if the other probe has different dimensions. During probe rotations, the probe tip will keep its actual position.

3.6 Robot

The DASY4 system uses the high precision industrial robots RX60L, RX90 and RX90L, as well as the RX60BL and RX90BL types out of the newer series from Stäubli SA (France). The RX robot series offers many features that are important for our application:

- High precision (repeatability 0.02mm)
- High reliability (industrial design)
- Low maintenance costs (virtually maintenance-free due to direct drive gears; no belt drives)
- Jerk-free straight movements (brushless synchrony motors; no stepper motors)
- Low ELF interference (the closed metallic construction shields against motor control fields)

For the newly delivered DASY4 systems as well as for the older DASY3 systems delivered since 1999, the CS7MB robot controller version from Stäubli is used. Previously delivered systems have either a CS7 or CS7M controller; the differences to the CS7MB are mainly in the hardware, but some procedures in the robot software from Stäubli are also not completely the same. The following descriptions about robot hard- and software correspond to CS7MB controller with software version 13.1 (edit S5). The actual commands, procedures and configurations, also including details in hardware, might differ if an older robot controller is in use. In this case please also refer to the Stäubli manuals for further information.



3.7 E-Field and H-Field Probes

The HAC measurement is conducted with the dosimetric probe ER3DV6 and H3DV6 (manufactured by SPEAG). The probe is specially designed and calibrated. This probe has a built in optical surface detection system from collision with DUT.

ER3DV6 E-Field Probe Description

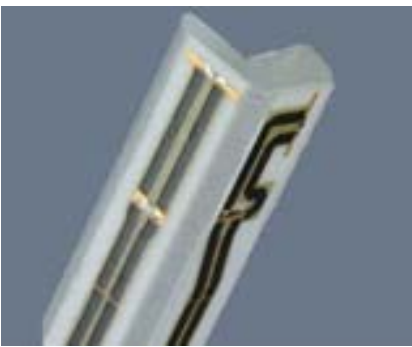
Construction	One dipole parallel, two dipoles normal to probe axis Built-in shielding against static charges PEEK enclosure material	 <p>E-Filed Free-space Probe (ER3DV6)</p>
Calibration	In air from 100 MHz to 3.0 GHz (absolute accuracy $\pm 6.0\%$, $k=2$)	
Frequency	40 MHz to > 6 GHz (can be extended to < 20 MHz) Linearity: ± 0.2 dB (100 MHz to 3 GHz)	
Directivity	± 0.2 dB in air (rotation around probe axis) ± 0.4 dB in air (rotation normal to probe axis)	
Dynamic Range	2 V/m to > 1000 V/m; Linearity: ± 0.2 dB	
Dimensions	Overall length: 330 mm (Tip: 16 mm) Tip diameter: 8 mm (Body: 12 mm) Distance from probe tip to dipole centers: 2.5 mm	
Application	General near-field measurements up to 6 GHz Field component measurements Fast automatic scanning in phantoms	

H3DV6 H-Field Probe Description

Construction	Three concentric loop sensors with 3.8 mm loop diameters Resistively loaded detector diodes for linear response Built-in shielding against static charges PEEK enclosure material (resistant to organic solvents, e.g., glycoether)	 <p>H-Filed Free-space Probe (H3DV6)</p>
Frequency	200 MHz to 3 GHz (absolute accuracy $\pm 6.0\%$, $k=2$); Output linearized	
Directivity	± 0.2 dB (spherical isotropy error)	
Dynamic Range	10 mA/m to 2 A/m at 1 GHz	
E-Field Interference	< 10% at 3 GHz (for plane wave)	
Dimensions	Overall length: 330 mm (Tip: 40 mm) Tip diameter: 6 mm (Body: 12 mm) Distance from probe tip to dipole centers: 3 mm	
Application	General magnetic near-field measurements up to 3 GHz (in air or liquids) Field component measurements Surface current measurements Low interaction with the measured field	

3.8 Probes Tip Description

HAC field measurements take place in the close near field gradients. Increasing the measuring distance from the source will generally decrease the measured field values (in case of the validation dipole approx. 10% per mm)

Magnetic field sensors are measuring the integral of H-field across area surrounded by the loop. They are calibrated in a precise, homogeneous field. When measuring a gradient field, the result will be very close to the field in the center of the loop which is equivalent to the value of a homogeneous field equivalent to the center value. But it will be different from the field at the field at the board of the loop.

Consequently, two sensors with different loop diameters – both calibrated ideally- would give different results when measuring from the edge of probe of the probe sensor elements. The behavior for electronically small E-field sensors is equivalent.

The magnetic field loops of the H3D probes are concentric, with the center 3 mm from the tip for H3DV6.

The electric field probes have a more irregular internal geometry because it is physically not possible to have the 3 orthogonal sensors situated with the same center. The different sensor center is accounted for in HAC uncertainty budget (“sensor displacement”). Their geometric center is at 2.5 mm from the tip, and the element ends are 1.1 mm closer to the tip.

3.9 Device Holder and Phantom

The test Arch phantom should be positioned horizontally on a stable surface. Reference marking on the phantom allows the complete setup of all predefined phantom positions and measurement grids by manually teaching three points in the robot.

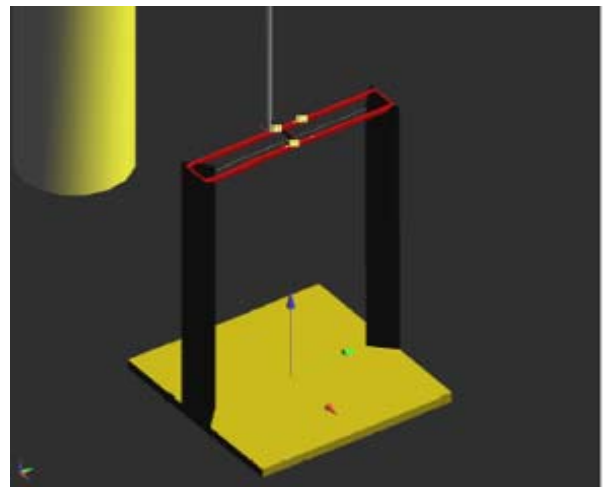
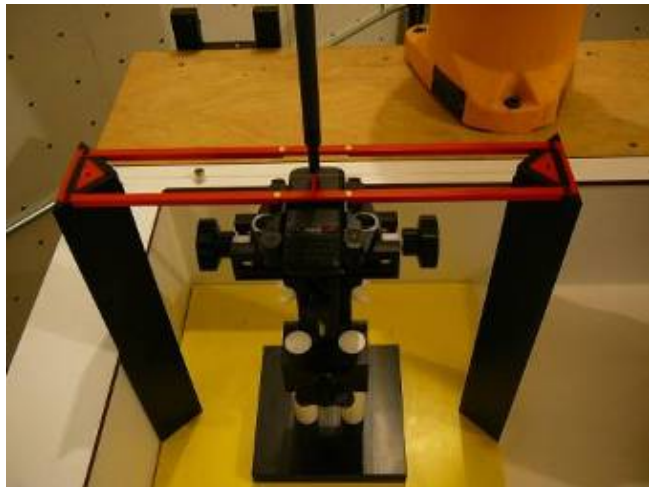

The DASy device holder has been made out of low-loss POM material having the following dielectric parameters: relative permittivity $\epsilon_r=3$ and loss tangent $\tan \delta=0.02$. The amount of dielectric material has been reduced in the closest vicinity of the device, since measurements have suggested that the influence of the clamp on the test results could thus be lowered.

3.10 Installation of the Test Arch Phantom

The Test Arch phantom should be positioned horizontally on a stable surface. If the cover of the Twin SAM phantom is used, side shifting after the teaching shall be avoided. In order to allow a vertical position of the probe (for both DASy4 Professional and Compact versions) the section Park position should be not higher than 15mm above the top of the upper Arch frame. For improved user friendliness a predefined configuration file of the Test Arch phantom is provided by SPEAG.

3.11 Mounting of a Calibration Dipole

A set of three calibration dipoles (CD835, CD1880 and CD2450) is included as a part of the HAC extension. These are used for the validation of the test setup after its installation and prior to the DUT measurements. The calibration dipole is placed in the position normally occupied by the DUT. All three calibration dipoles have the same high which allows an exact fitting below the center point of the Test Arch.

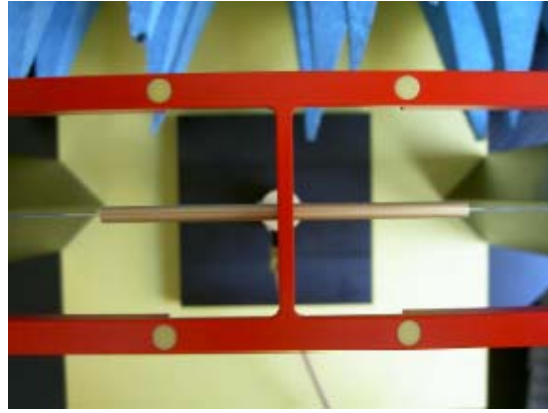

Insert the base of the calibration dipole fully into the dipole holder and fix it against rotation by tightening the white screw. Connect the RF cable to the dipole and secure it before placing it below the Test Arch phantom in order to avoid mechanical stress to it. Hold the dipole on its plate at the base and press it down against the internal spring to reduce the height.

While holding the dipole down, slide the dipole on its holder centered below the arch, with the arms aligned to the dielectric wire (see graphics above). Release the dipole slowly and guide the gap between the arms into the matching center spacer below the dielectric wire.

To remove the dipole from the setup press it in the downwards direction before sliding it carefully out from below the arch.

3.12 Mounting the DUT

A DUT is mounted in the device holder equivalent as for classic dosimetric measurements. The acoustic output of the DUT shall coincide with the center point of the area formed by the dielectric wire and the middle bar of the arch's top frame (see picture below).

The DUT shall be moved vertically upwards until it touches the frame. The fine adjustment is possible by sliding the complete DUT holder on the yellow base plate of the Test Arch phantom.

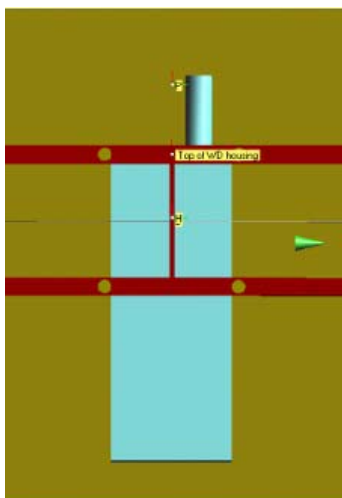

3.13 System Validation Kits

Each DASY system is equipped with one or more system validation kits. These units, together with the predefined measurement procedures within the DASY software, enable the user to conduct the system performance check and system validation. For that purpose a well defined SAR distribution in the flat section of the SAM twin phantom is produced.

System validation kit includes a dipole, tripod holder to fix it underneath the flat phantom and a corresponding distance holder. Dipoles are available for the variety of frequencies between 300MHz and 6 GHz (dipoles for other frequencies or media and other calibration conditions are available upon request).

The dipoles are highly symmetric and matched at the center frequency for the specified liquid and distance to the flat phantom (or flat section of the SAM-twin phantom). The accurate distance between the liquid surface and the dipole center is achieved with a distance holder that snaps on the dipole.

3.14 Probe Modulation Factor

According to ANSI C63.19: 2007, The Probe Modulation Factor (PMF) is defined as the ratio of the field reading of CW and modulated signal.

Modulation Factor (E-Field)

Frequency (MHz)	Mode	Probe Modulation Factor (PMF)
835	CW	/
	GSM	2.88
1900	CW	/
	GSM	2.88

Modulation Factor (H-Field)

Frequency (MHz)	Mode	Probe Modulation Factor (PMF)
835	CW	/
	GSM	2.88
1900	CW	/
	GSM	2.88

4 TESTING EQUIPMENT LIST AND DETAILS

Type/Model	Cal. Due Date	Serial Number
DASY4 Professional Dosimetric System	N/A	N/A
Robot RX60L	N/A	CS7MBSP/467
Robot Controller	N/A	F01/5J72A1/A/01
Dell Computer Dimension 3000	N/A	N/A
SPEAG EDC3	N/A	N/A
SPEAG DAE3	2015-10-17	456
Probe, ER3DV6	2014-01-11	2338
Probe, H3DV6	2014-01-11	6158
SPEAG Arch Phantom	N/A	1010
SPEAG Light Alignment Sensor	N/A	278
DASY4 Measurement Server	N/A	1176
Antenna, Dipole, CD835V3	2014-01-24	1012
Antenna, Dipole, CD1880V3	2014-01-24	1009
Microwave Amp. 8349A	N/A	2644A02662
Power Meter Agilent E4419B	2014-09-01	MY4121511
Power Sensor Agilent E9301A	2014-05-09	US39211706
Analyzer Communication, CMU200	2014-06-22	103492
HP, Signal Generator, 83650B	2014-06-21	3614A00276
Agilent, Spectrum Analyzer	2014-08-09	US45303156
Antenna, Horn SAS-200/571	2014-01-18	261

5 HAC MEASUREMENT SYSTEM VERIFICATION

5.1 Purpose of System Performance Check

The system performance check verifies that the system operates within its specifications. System and operator errors can be detected and corrected. It is recommended that the system performance check be performed prior to any usage of the system. The system performance check use normal HAC measurements in a simplified setup with a well characterized source. This setup was selected to give a high sensitivity to all parameters that might fail or vary time. The system check does not intend to replace the calibration of the components, but indicates situations where the system uncertainty is exceeded due to drift or failure.

5.2 System Performance Check Setup

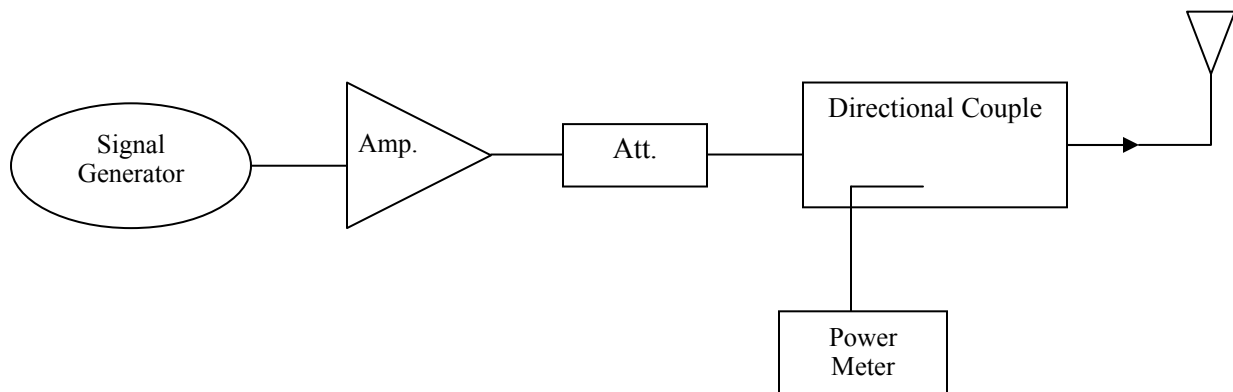

In the simplified setup for system evaluation, the EUT is replaced by a calibrated dipole and the power source is replaced by a continuous wave which comes from a signal generator at frequency 835 MHz and 1880 MHz. The calibrated dipole must be placed beneath the flat phantom section of ARC with the correct distance holder.

The output power on dipole port must be calibrated to 20 dBm (100 mw) before dipole is connected.

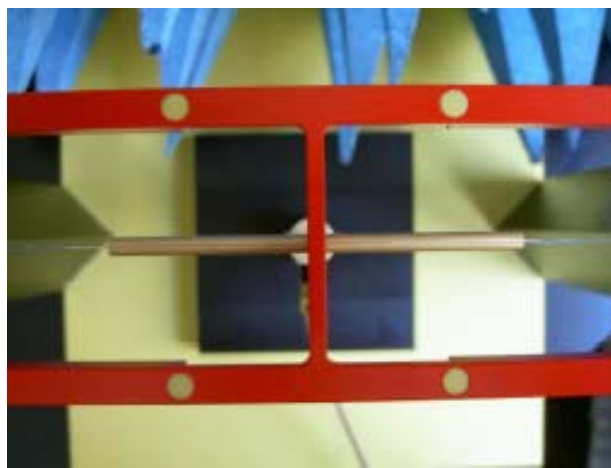

5.3 System Validation Results

E-Field System Validation

Frequency (MHz)	Input Power (dBm)	E-Field Result (V/m)	Target E-Field (V/m)	Deviation (%)
835	20.0	173.7	171.1	1.52
1880	20.0	140.8	140.4	0.28

H-Field System Validation

Frequency (MHz)	Input Power (dBm)	H-Field Result (A/m)	Target H-Field (A/m)	Deviation (%)
835	20.0	0.484	0.470	2.98
1880	20.0	0.479	0.472	1.48

*Note: Deviation = ((E or H-Field Result)-(Target Field))/(Target Value) * 100 %
Target value is provided by SPEAD in the calibration certificate.*

Test Laboratory: Bay Area Compliance Lab Corp. (BACL)

HAC_E_Dipole_835 System Validation

DUT: HAC-Dipole 835 MHz; Type: D835V3; Serial: 1012

Communication System: CW; Frequency: 835 MHz; Duty Cycle: 1:1
 Medium parameters used: $\sigma = 0$ mho/m, $\epsilon_r = 1$; $\rho = 1000$ kg/m³
 Phantom section: RF Section
 Measurement Standard: DAS4 (High Precision Assessment)

DASY4 Configuration:

- Probe: ER3DV6 - SN2338; ConvF(1, 1, 1); Calibrated: 1/11/2013
- Sensor-Surface: (Fix Surface)
- Electronics: DAE3 Sn456; Calibrated: 3/16/2012
- Phantom: HAC Test Arch with AMCC; Type: SD HAC P01 BA;
- Measurement SW: DAS4, V4.7 Build 80; Postprocessing SW: SEMCAD, V1.8 Build 186

E Scan 10mm above CD 835 MHz/Hearing Aid Compatibility Test (41x361x1): Measurement grid: dx=5mm, dy=5mm

Maximum value of peak Total field = 173.7 V/m

Probe Modulation Factor = 1.00

Device Reference Point: 0.000, 0.000, -6.30 mm

Reference Value = 48.1 V/m; Power Drift = 0.014 dB

Hearing Aid Near-Field Category: M4 (AWF 0 dB)

Peak E-field in V/m

Grid 1 157.6 M4	Grid 2 161.0 M4	Grid 3 152.5 M4
Grid 4 85.3 M4	Grid 5 86.8 M4	Grid 6 81.9 M4
Grid 7 170.6 M4	Grid 8 173.7 M4	Grid 9 158.4 M4

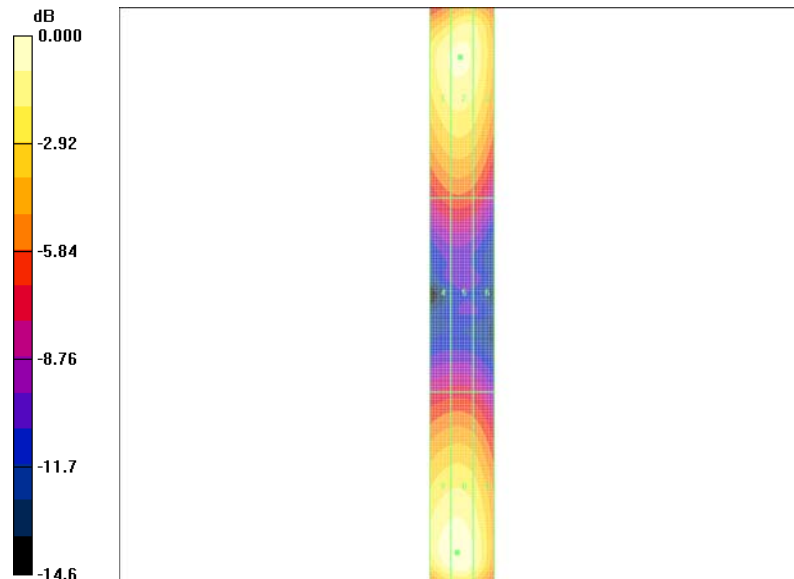

0 dB = 173.7V/m

Test Laboratory: Bay Area Compliance Lab Corp. (BACL)

HAC_E_Dipole_1880 System Validation

DUT: HAC Dipole 1880 MHz; Type: CD1880V3; Serial: 1009

Communication System: CW; Frequency: 1880 MHz; Duty Cycle: 1:1
 Medium parameters used: $\sigma = 0$ mho/m, $\epsilon_r = 1$; $\rho = 1000$ kg/m³
 Phantom section: RF Section
 Measurement Standard: DAS4 (High Precision Assessment)

DASY4 Configuration:

- Probe: ER3DV6 - SN2338; ConvF(1, 1, 1); Calibrated: 1/11/2013
- Sensor-Surface: (Fix Surface)
- Electronics: DAE3 Sn456; Calibrated: 3/16/2012
- Phantom: HAC Test Arch with AMCC; Type: SD HAC P01 BA;
- Measurement SW: DAS4, V4.7 Build 80; Postprocessing SW: SEMCAD, V1.8 Build 186

E Scan 10mm above CD 1880 MHz/Hearing Aid Compatibility Test (41x181x1): Measurement grid: dx=5mm, dy=5mm

Maximum value of peak Total field = 140.8 V/m

Probe Modulation Factor = 1.00

Device Reference Point: 0.000, 0.000, -6.30 mm

Reference Value = 64.2 V/m; Power Drift = 0.045 dB

Hearing Aid Near-Field Category: M2 (AWF 0 dB)

Peak E-field in V/m

Grid 1 137.8 M2	Grid 2 140.8 M2	Grid 3 133.6 M2
Grid 4 83.1 M3	Grid 5 83.2 M3	Grid 6 77.8 M3
Grid 7 133.5 M2	Grid 8 137.1 M2	Grid 9 127.9 M2

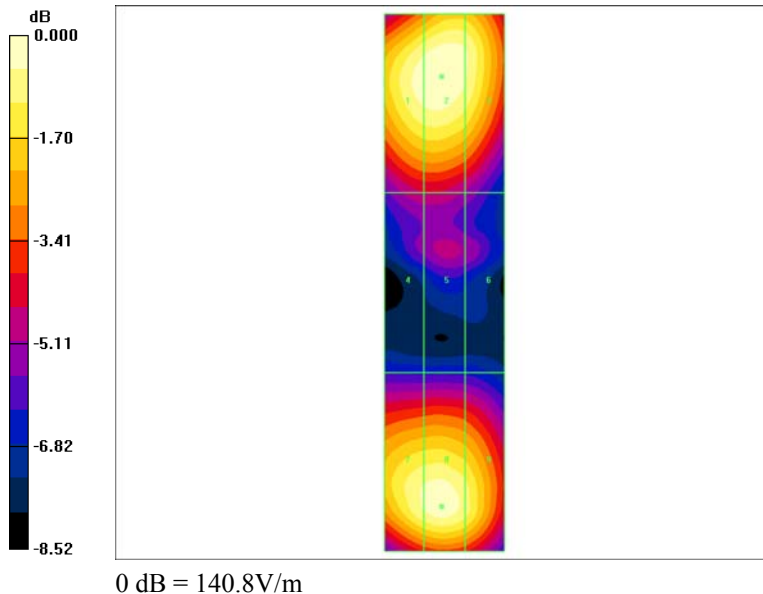

Test Laboratory: Bay Area Compliance Lab Corp. (BACL)

HAC_H_Dipole_835 System Validation

DUT: HAC-Dipole 835 MHz; Type: D835V3; Serial: 1012

Communication System: CW; Frequency: 835 MHz; Duty Cycle: 1:1
 Medium parameters used: $\sigma = 0$ mho/m, $\epsilon_r = 1$; $\rho = 1$ kg/m³
 Phantom section: RF Section
 Measurement Standard: DAS4 (High Precision Assessment)

DASY4 Configuration:

- Probe: H3DV6 - SN6158; ; Calibrated: 1/11/2013
- Sensor-Surface: (Fix Surface)
- Electronics: DAE3 Sn456; Calibrated: 3/16/2012
- Phantom: HAC Test Arch with AMCC; Type: SD HAC P01 BA;
- Measurement SW: DAS4, V4.7 Build 80; Postprocessing SW: SEMCAD, V1.8 Build 186

H Scan 10mm above CD 835 MHz/Hearing Aid Compatibility Test (41x361x1): Measurement grid: dx=5mm, dy=5mm

Maximum value of peak Total field = 0.484 A/m

Probe Modulation Factor = 1.00

Device Reference Point: 0.000, 0.000, -6.30 mm

Reference Value = 0.458 A/m; Power Drift = 0.009 dB

Hearing Aid Near-Field Category: M4 (AWF 0 dB)

Peak H-field in A/m

Grid 1 0.400 M4	Grid 2 0.419 M4	Grid 3 0.378 M4
Grid 4 0.464 M4	Grid 5 0.484 M4	Grid 6 0.435 M4
Grid 7 0.412 M4	Grid 8 0.426 M4	Grid 9 0.383 M4

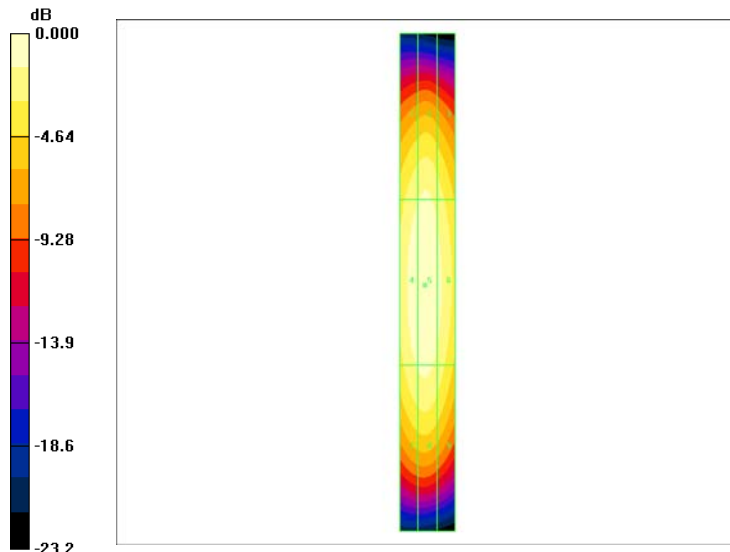

0 dB = 0.484A/m

Test Laboratory: Bay Area Compliance Lab Corp. (BACL)

HAC_H_Dipole_1880 System Validation

DUT: HAC Dipole 1880 MHz; Type: CD1880V3; Serial: 1009

Communication System: CW; Frequency: 1880 MHz; Duty Cycle: 1:1
 Medium parameters used: $\sigma = 0$ mho/m, $\epsilon_r = 1$; $\rho = 1$ kg/m³
 Phantom section: RF Section
 Measurement Standard: DAS4 (High Precision Assessment)

DASY4 Configuration:

- Probe: H3DV6 - SN6158; ; Calibrated: 1/11/2013
- Sensor-Surface: (Fix Surface)
- Electronics: DAE3 Sn456; Calibrated: 3/16/2012
- Phantom: HAC Test Arch with AMCC; Type: SD HAC P01 BA;
- Measurement SW: DAS4, V4.7 Build 80; Postprocessing SW: SEMCAD, V1.8 Build 186

H Scan 10mm above CD 1880 MHz 2/Hearing Aid Compatibility Test (41x181x1): Measurement grid: dx=5mm, dy=5mm

Maximum value of peak Total field = 0.479 A/m

Probe Modulation Factor = 1.00

Device Reference Point: 0.000, 0.000, -6.30 mm

Reference Value = 0.458 A/m; Power Drift = 0.002 dB

Hearing Aid Near-Field Category: M2 (AWF 0 dB)

Peak H-field in A/m

Grid 1 0.421 M2	Grid 2 0.441 M2	Grid 3 0.404 M2
Grid 4 0.458 M2	Grid 5 0.479 M2	Grid 6 0.443 M2
Grid 7 0.415 M2	Grid 8 0.434 M2	Grid 9 0.399 M2

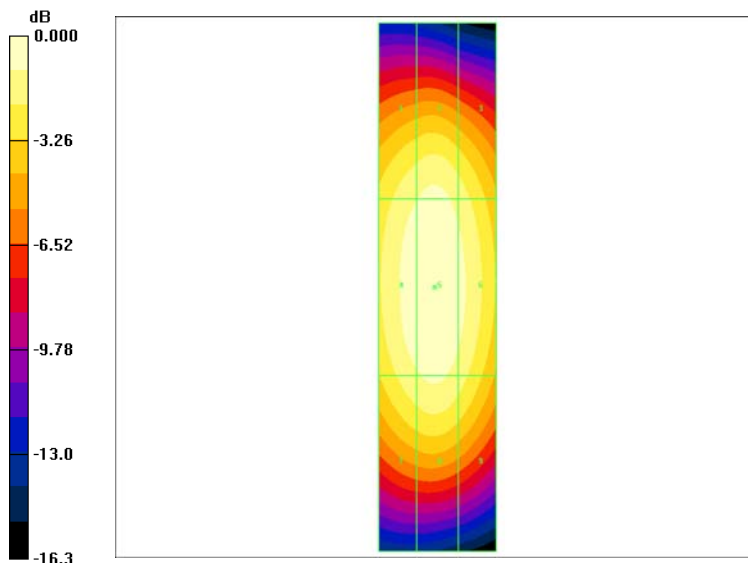

0 dB = 0.479A/m

6 HAC RF EMISSIONS TEST PROCEDURE

6.1 Test Instructions

Test Instructions

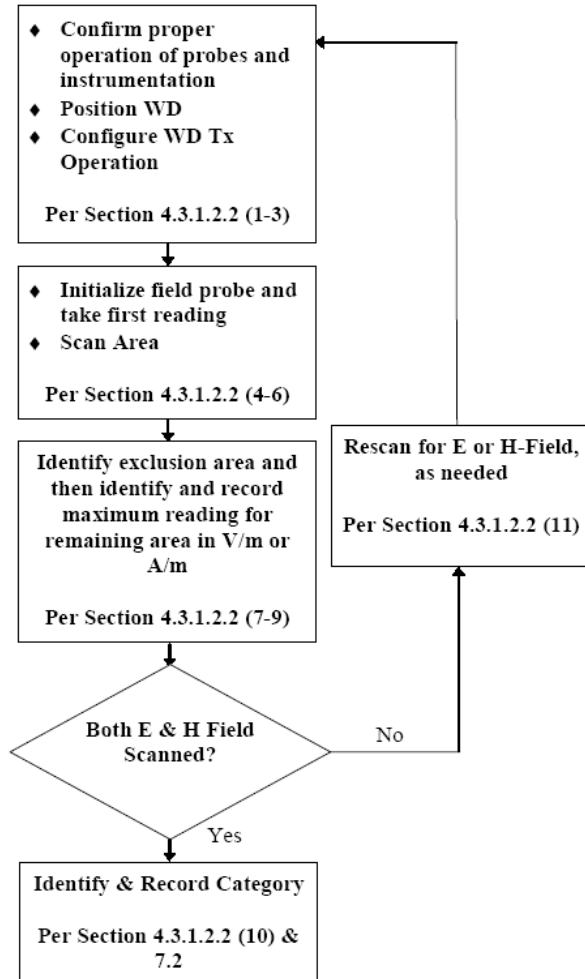

6.2 Test Setup

Figure 1 through Figure 3 illustrates the references and reference plane that shall be used in the WD emissions measurement.

- 1) The grid is 5.0 cm by 5.0 cm area that is divided into nine evenly sized blocks or sub-grids.
- 2) The grid is centered on the audio frequency output transducer of the WD (speaker or T-Coil).
- 3) The grid is in a reference plane, which is defined as the planar area that contains the highest point in the area of the phone that normally rests against the user's ear. It is parallel to the centerline of the receiver area of the phone and is defined by the points of the receiver-end of the WD handset, which, in normal handset use, rest against the ear.
- 4) The measurement plane is parallel to, and 10.0 mm in front of, the reference plane.



Figure 1. WD reference and plan for RF emission measurement

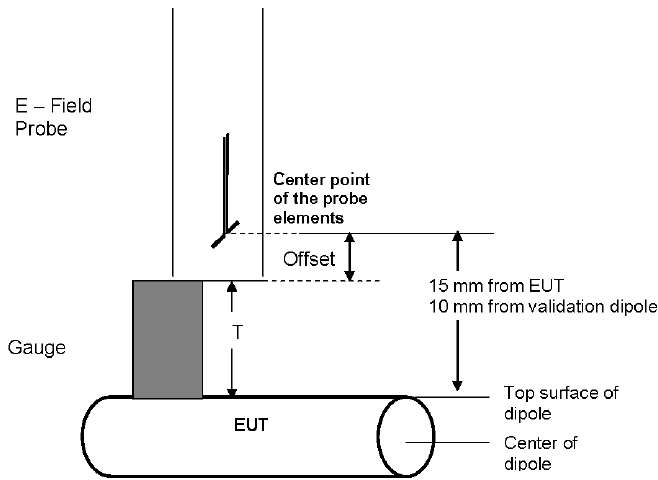

Figure 2. Gauge Block with E-field Probe

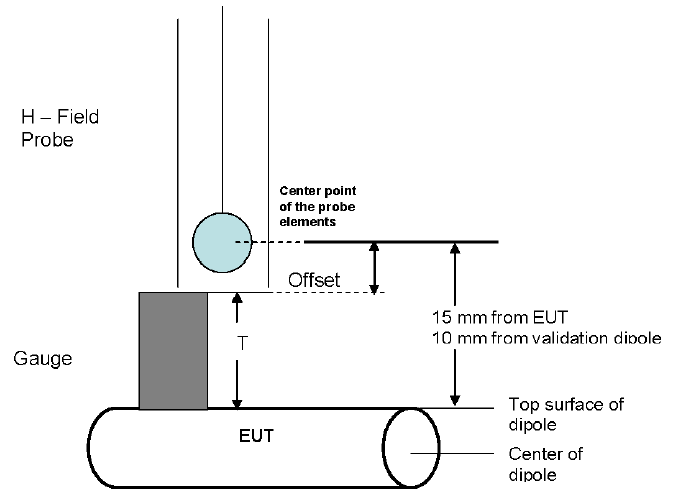

Figure 3. Gauge Block with H-field Probe

6.3 Near-Field Test Procedure

The electric field probe, and, separately, the magnetic field probe, is to be used to measure the highest field strength in the 5 cm by 5 cm scan surface. The average field strength measured over many pulse cycles may be measured, with the peak then being calculated from the measured average value and the known duty cycle of the WD.

The 5 cm by 5 cm area is divided into nine subgrids (see the diagram in Figure A.2). Three contiguous subgrids on the perimeter may be excluded from the measurement. This allows for RF "hot spots" that can easily be avoided in actual use. The highest reading found in the area defined by the middle subgrid and the remaining subgrids determines the category rating. The field probe is carefully moved through the measurement area and the maximum reading is located. In order to accurately scan the entire 5 cm by 5 cm area, the center of the probe shall be moved through this area. Accordingly the total area covered by the outside edge of the probe shall be the 5 cm by 5 cm area, increased by half (1/2) the probe diameter on all sides.

The method of displaying the data is not important as long as good measurement techniques are followed and the resultant highest field strength is obtained.

The distance from the WD reference plane to the nearest point on the probe element shall be 1.0 cm. The WD reference plane is a plane parallel with the front "face" of the WD and containing the highest point on its contour. The probe element is that portion of the probe that is designed to receive and sense the field being measured. The physical body of the probe housing shall not be used when setting this 1.0 cm distance as this would place the sensing elements at an indeterminate distance from the reference plane. Although it is theoretically possible to measure at almost any distance and calculate the equivalent field strengths at 1.0 cm, it is not recommended as these calculations are very difficult and prone to errors.

In the case of a field probe that may have less than three orthogonal elements, it is necessary to rotate the probe to obtain the measurement. Two methods may be used. In the preferred method, the probe shall be rotated in three dimensions for maximum alignment and the reading at maximum field alignment used. An alternative method is to rotate the probe about its geometric center so as to obtain measurements in all three mutually orthogonal orientations. The geometric center is the point that is physically located at the center of the electromagnetic sensing element of the probe. This may be determined from physical measurements or from field pattern measurements during calibration. The maximum field shall be the vector sum of all three individual mutually orthogonal measurements. Note that even when using three element probes, the probe may be rotated so as to align one element for maximum field coupling. When this is done the reading of the single, maximally aligned element is used as the field reading at that location. Readings taken in this manner are preferred over those taken with the non-aligned method because of the greater accuracy. However, when the alignment method is used, the probe shall be realigned at every measurement point.

7 MEASUREMENT UNCERTAINTY

The uncertainty budget has been determined for the DASY4 measurement system and is given in the following Table:

Wireless Communication Device Near-Field Measurement Uncertainty Estimation (According to ANSI C63.19)							
Error Description	Uncertainty Value	Prob. Dist.	Div.	(c i) E	(c i) H	Std. Unc. (E) K=2	Std. Unc. (H) K=2
Measurement System							
Probe Calibration	± 5.1 %	N	1	1	1	± 10.1 %	±5.1%
Axial Isotropy	± 4.7%	R	$\sqrt{3}$	1	1	±2.7%	±2.7%
Sensor Displacement	±16.5%	R	$\sqrt{3}$	1	0.145	±9.5%	±1.4%
Test Arch	±7.2%	R	$\sqrt{3}$	1	0	±4.1%	±0.0%
Linearity	±4.7%	R	$\sqrt{3}$	1	1	±2.7%	±2.7%
Scaling to Peak Envelope Power	±0.0%	R	$\sqrt{3}$	1	1	±0.0%	±0.0%
System Detection Limit	±1.0%	R	$\sqrt{3}$	1	1	±0.6%	±0.6%
Readout Electronics	±0.3%	N	1	1	1	±0.3%	±0.3%
Response Time	±0.8%	R	$\sqrt{3}$	1	1	±0.5%	±0.5%
Integration Time	±2.6%	R	$\sqrt{3}$	1	1	±1.5%	±1.5%
RF Ambient Conditions	±3.0%	R	$\sqrt{3}$	1	1	±1.7%	±1.7%
RF Reflections	±12.0%	R	$\sqrt{3}$	1	1	±6.9%	±6.9%
Probe Positioner	±1.2%	R	$\sqrt{3}$	1	0.67	±0.7%	±0.5%
Probe Positioning	±4.7%	R	$\sqrt{3}$	1	0.67	±2.7%	±1.8%
Extrap. and Interpolation	±1.0%	R	$\sqrt{3}$	1	1	±0.6%	±0.6%
Test Sample Related							
Device Positioning Vertical	±4.7%	R	$\sqrt{3}$	1	0.67	±2.7%	±1.8%
Device Positioning Lateral	±1.0%	R	$\sqrt{3}$	1	1	±0.6%	±0.6%
Device Holder and Phantom	±2.4%	R	$\sqrt{3}$	1	1	±1.4%	±1.4%
Power Drift	±5.0%	R	$\sqrt{3}$	1	1	±2.9%	±2.9%
Phantom and Setup Related							
Phantom Thickness	± 2.4%	R	$\sqrt{3}$	1	0.67	±1.4%	±0.9%
Combined Std. Uncertainty						±15.2%	±10.8%
Expanded Std. Uncertainty on Power						±30.4%	±21.6%
Expanded Std. Uncertainty on Field						±15.2%	±10.8%

8 HAC MEASUREMENT SUMMARY

8.1 HAC Test Data

This page summarizes the results of the performed dosimetric evaluation. The plots with the corresponding E & H Fields distributions, which reveal information about the category of the wireless communication device with respect to the HAC test result, could be found in Appendix A.

8.2 Test Environmental Conditions

Temperature:	22 °C
Relative Humidity:	48 %
ATM Pressure:	101.4 kPa

Testing was performed by Ricky Wang on 2013-10-09 in the SAR Chamber.

Frequency (MHz)	Test Type	Medium	Phantom	Notes/ Accessories	Peak Field (V/m, E-Field)	HAC Category	Plot #
824.2	E-Field	Air	Arch	none	142.3	M4	1
836.6	E-Field	Air	Arch	none	149.9	M3	2
848.8	E-Field	Air	Arch	none	158.1	M3	3
1850.2	E-Field	Air	Arch	none	51.6	M3	4
1880.0	E-Field	Air	Arch	none	46.4	M4	5
1909.8	E-Field	Air	Arch	none	39.1	M4	6

Frequency (MHz)	Test Type	Medium	Phantom	Notes/ Accessories	Peak Field (A/m, H-Field)	HAC Category	Plot #
824.2	H-Field	Air	Arch	none	0.163	M4	7
836.6	H-Field	Air	Arch	none	0.179	M4	8
848.8	H-Field	Air	Arch	none	0.209	M4	9
1850.2	H-Field	Air	Arch	none	0.164	M3	10
1880.0	H-Field	Air	Arch	none	0.145	M3	11
1909.8	H-Field	Air	Arch	none	0.118	M4	12

9 APPENDIX A – HAC MEASUREMENT RESULTS

835 E Field Testing Low CH

DUT: BinatTone Electrics; Type: GSM phone; Serial: R13091610

Communication System: GSM 850; Frequency: 824.2 MHz; Duty Cycle: 1:8.3
 Medium parameters used: $\sigma = 0$ mho/m, $\epsilon_r = 1$; $\rho = 1000$ kg/m³
 Phantom section: E Dipole Section
 Measurement Standard: DAS4 (High Precision Assessment)

DASY4 Configuration:

- Probe: ER3DV6 - SN2338; ConvF(1, 1, 1); Calibrated: 1/11/2013
- Sensor-Surface: (Fix Surface)
- Electronics: DAE3 Sn456; Calibrated: 3/16/2012
- Phantom: HAC Test Arch; Type: SD HAC P01 BA; Serial:
- Measurement SW: DAS4, V4.7 Build 80; Postprocessing SW: SEMCAD, V1.8 Build 186

E Scan 10mm above 850 MHz/Hearing Aid Compatibility Test (101x101x1): Measurement grid: dx=5mm, dy=5mm

Maximum value of peak Total field = 142.3 V/m
 Probe Modulation Factor = 2.88
 Device Reference Point: 0.000, 0.000, 354.7 mm
 Reference Value = 29.2 V/m; Power Drift = 0.101 dB
 Test Arch Compensation is Applied.

Hearing Aid Near-Field Category: M4 (AWF -5 dB)

Peak E-field in V/m

Grid 1	Grid 2	Grid 3
142.3 M4	130.3 M4	87.3 M4
Grid 4	Grid 5	Grid 6
138.6 M4	121.3 M4	82.7 M4
Grid 7	Grid 8	Grid 9
125.9 M4	88.9 M4	62.3 M4

Plot #1

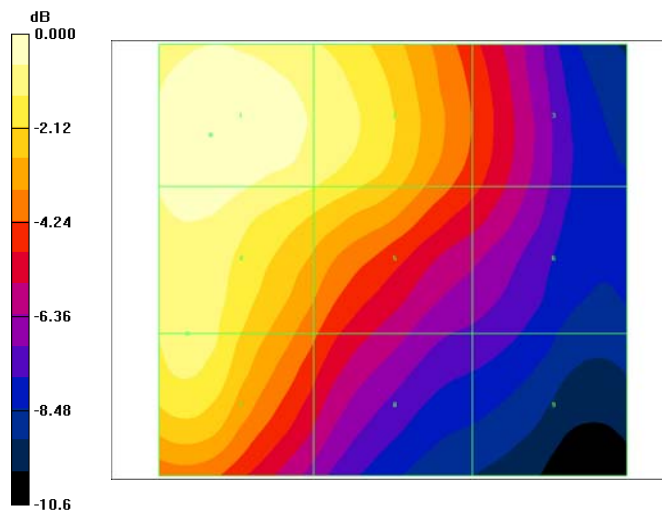

0 dB = 142.3V/m

Plot #1

835 E Field Testing Mid CH

DUT: BinaTone Electrics; Type: GSM phone; Serial: R13091610

Communication System: GSM 850; Frequency: 836.6 MHz; Duty Cycle: 1:8.3
 Medium parameters used: $\sigma = 0$ mho/m, $\epsilon_r = 1$; $\rho = 1000$ kg/m³
 Phantom section: E Dipole Section
 Measurement Standard: DAS4 (High Precision Assessment)

DASY4 Configuration:

- Probe: ER3DV6 - SN2338; ConvF(1, 1, 1); Calibrated: 1/11/2013
- Sensor-Surface: (Fix Surface)
- Electronics: DAE3 Sn456; Calibrated: 3/16/2012
- Phantom: HAC Test Arch; Type: SD HAC P01 BA; Serial: 1009
- Measurement SW: DAS4, V4.7 Build 80; Postprocessing SW: SEMCAD, V1.8 Build 186

E Scan 10mm above 850 MHz/Hearing Aid Compatibility Test (101x101x1): Measurement grid: dx=5mm, dy=5mm

Maximum value of peak Total field = 149.9 V/m
 Probe Modulation Factor = 2.88
 Device Reference Point: 0.000, 0.000, 354.7 mm
 Reference Value = 32.1 V/m; Power Drift = 0.119 dB
 Test Arch Compensation is Applied.

Hearing Aid Near-Field Category: M3 (AWF -5 dB)

Peak E-field in V/m

Grid 1 149.9 M3	Grid 2 141.3 M4	Grid 3 97.6 M4
Grid 4 145.0 M4	Grid 5 130.5 M4	Grid 6 90.5 M4
Grid 7 130.5 M4	Grid 8 96.0 M4	Grid 9 68.5 M4

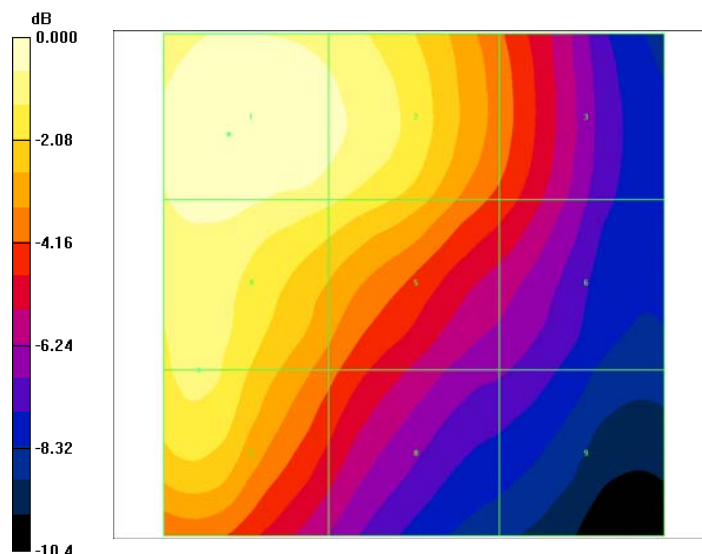

0 dB = 149.9V/m

Plot #2

835 E Field Testing High CH

DUT: BinaTone Electrics; Type: GSM phone; Serial: R13091610

Communication System: GSM 850; Frequency: 848.8 MHz; Duty Cycle: 1:8.3
 Medium parameters used: $\sigma = 0$ mho/m, $\epsilon_r = 1$; $\rho = 1000$ kg/m³
 Phantom section: E Dipole Section
 Measurement Standard: DAS4 (High Precision Assessment)

DASY4 Configuration:

- Probe: ER3DV6 - SN2338; ConvF(1, 1, 1); Calibrated: 1/11/2013
- Sensor-Surface: (Fix Surface)
- Electronics: DAE3 Sn456; Calibrated: 3/16/2012
- Phantom: HAC Test Arch; Type: SD HAC P01 BA; Serial: 1009
- Measurement SW: DAS4, V4.7 Build 80; Postprocessing SW: SEMCAD, V1.8 Build 186

E Scan 10mm above 850 MHz/Hearing Aid Compatibility Test (101x101x1): Measurement grid: dx=5mm, dy=5mm

Maximum value of peak Total field = 158.1 V/m
 Probe Modulation Factor = 2.88
 Device Reference Point: 0.000, 0.000, 354.7 mm
 Reference Value = 37.1 V/m; Power Drift = 0.017 dB
 Test Arch Compensation is Applied.

Hearing Aid Near-Field Category: M3 (AWF -5 dB)

Peak E-field in V/m

Grid 1 158.1 M3	Grid 2 153.5 M3	Grid 3 110.1 M4
Grid 4 151.8 M3	Grid 5 141.6 M4	Grid 6 102.4 M4
Grid 7 135.0 M4	Grid 8 106.1 M4	Grid 9 79.8 M4

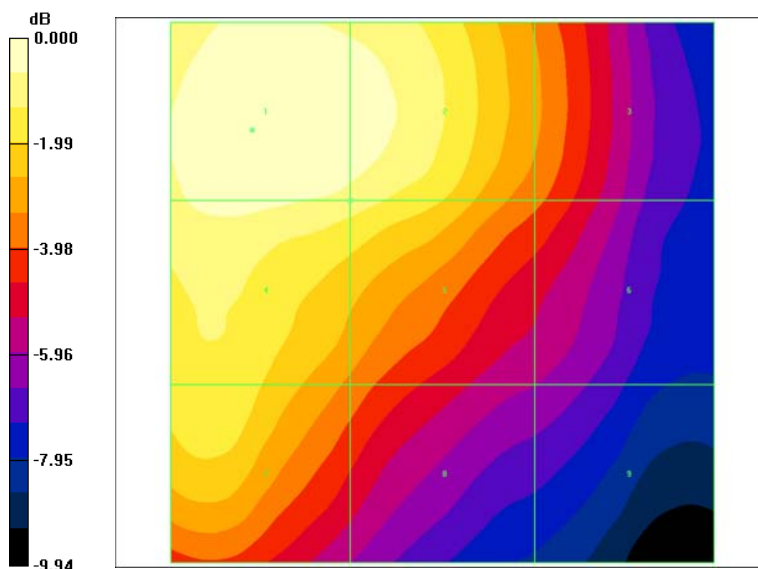

0 dB = 158.1V/m

Plot #3

1900 E Field Testing Low CH

DUT: BinaTone Electrics; Type: GSM phone; Serial: R13091610

Communication System: PCS 1900; Frequency: 1850.2 MHz; Duty Cycle: 1:8.3
 Medium parameters used: $\sigma = 0$ mho/m, $\epsilon_r = 1$; $\rho = 1000$ kg/m³
 Phantom section: E Dipole Section
 Measurement Standard: DAS4 (High Precision Assessment)

DASY4 Configuration:

- Probe: ER3DV6 - SN2338; ConvF(1, 1, 1); Calibrated: 1/11/2013
- Sensor-Surface: (Fix Surface)
- Electronics: DAE3 Sn456; Calibrated: 3/16/2012
- Phantom: HAC Test Arch; Type: SD HAC P01 BA; Serial: 1009
- Measurement SW: DAS4, V4.7 Build 80; Postprocessing SW: SEMCAD, V1.8 Build 186

E Scan 10mm above 850 MHz/Hearing Aid Compatibility Test (101x101x1): Measurement grid: dx=5mm, dy=5mm

Maximum value of peak Total field = 51.6 V/m

Probe Modulation Factor = 2.88

Device Reference Point: 0.000, 0.000, 354.7 mm

Reference Value = 11.8 V/m; Power Drift = -0.010 dB

Test Arch Compensation is Applied.

Hearing Aid Near-Field Category: M3 (AWF -5 dB)

Peak E-field in V/m

Grid 1	Grid 2	Grid 3
45.1 M4	34.5 M4	27.2 M4
Grid 4	Grid 5	Grid 6
51.1 M3	40.5 M4	36.7 M4
Grid 7	Grid 8	Grid 9
51.6 M3	39.8 M4	36.6 M4

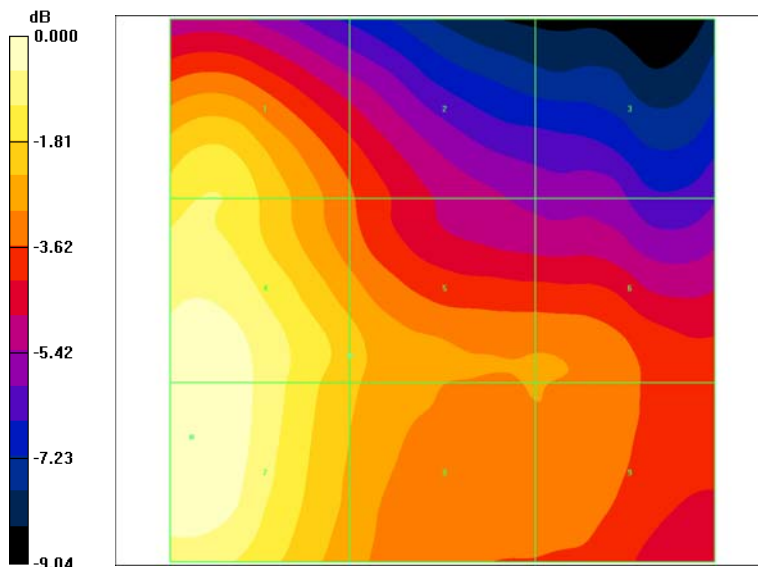

0 dB = 51.6V/m

Plot #4

1900 E Field Testing Mid CH

DUT: BinaTone Electrics; Type: GSM phone; Serial: R13091610

Communication System: PCS 1900; Frequency: 1880 MHz; Duty Cycle: 1:8.3
 Medium parameters used: $\sigma = 0$ mho/m, $\epsilon_r = 1$; $\rho = 1000$ kg/m³
 Phantom section: E Dipole Section
 Measurement Standard: DAS4 (High Precision Assessment)

DASY4 Configuration:

- Probe: ER3DV6 - SN2338; ConvF(1, 1, 1); Calibrated: 1/11/2013
- Sensor-Surface: (Fix Surface)
- Electronics: DAE3 Sn456; Calibrated: 3/16/2012
- Phantom: HAC Test Arch; Type: SD HAC P01 BA; Serial: 1009
- Measurement SW: DAS4, V4.7 Build 80; Postprocessing SW: SEMCAD, V1.8 Build 186

E Scan 10mm above 850 MHz/Hearing Aid Compatibility Test (101x101x1): Measurement grid: dx=5mm, dy=5mm
 Maximum value of peak Total field = 46.4 V/m
 Probe Modulation Factor = 2.88
 Device Reference Point: 0.000, 0.000, 354.7 mm
 Reference Value = 11.6 V/m; Power Drift = 0.030 dB
 Test Arch Compensation is Applied.
Hearing Aid Near-Field Category: M4 (AWF -5 dB)

Peak E-field in V/m

Grid 1 41.4 M4	Grid 2 33.5 M4	Grid 3 26.3 M4
Grid 4 46.0 M4	Grid 5 38.2 M4	Grid 6 34.9 M4
Grid 7 46.4 M4	Grid 8 37.4 M4	Grid 9 34.4 M4

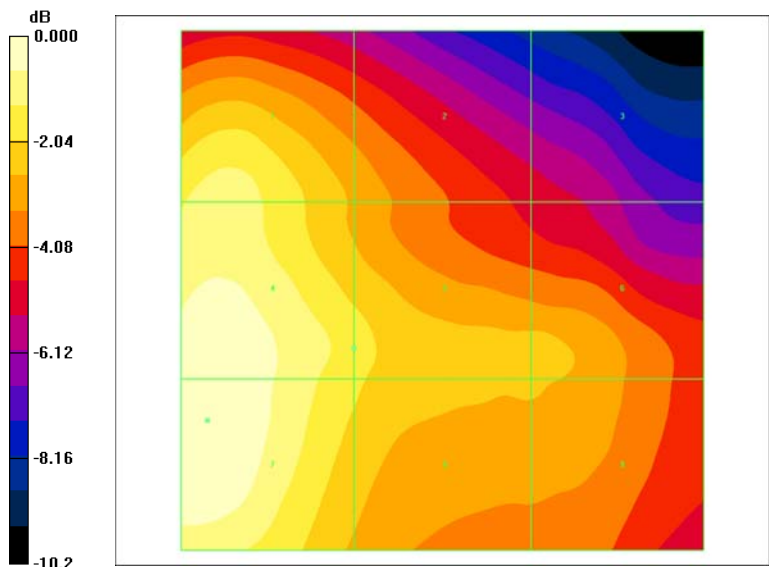

0 dB = 46.4V/m

Plot #5

1900 E Field Testing High CH

DUT: BinaTone Electrics; Type: GSM phone; Serial: R13091610

Communication System: PCS 1900; Frequency: 1909.8 MHz; Duty Cycle: 1:8.3
 Medium parameters used: $\sigma = 0$ mho/m, $\epsilon_r = 1$; $\rho = 1000$ kg/m³
 Phantom section: E Dipole Section
 Measurement Standard: DAS4 (High Precision Assessment)

DASY4 Configuration:

- Probe: ER3DV6 - SN2338; ConvF(1, 1, 1); Calibrated: 1/11/2013
- Sensor-Surface: (Fix Surface)
- Electronics: DAE3 Sn456; Calibrated: 3/16/2012
- Phantom: HAC Test Arch; Type: SD HAC P01 BA; Serial: 1009
- Measurement SW: DAS4, V4.7 Build 80; Postprocessing SW: SEMCAD, V1.8 Build 186

E Scan 10mm above 850 MHz/Hearing Aid Compatibility Test (101x101x1): Measurement grid: dx=5mm, dy=5mm

Maximum value of peak Total field = 39.1 V/m

Probe Modulation Factor = 2.88

Device Reference Point: 0.000, 0.000, 354.7 mm

Reference Value = 9.37 V/m; Power Drift = -0.121 dB

Test Arch Compensation is Applied.

Hearing Aid Near-Field Category: M4 (AWF -5 dB)

Peak E-field in V/m

Grid 1 33.4 M4	Grid 2 26.4 M4	Grid 3 21.9 M4
Grid 4 38.3 M4	Grid 5 30.4 M4	Grid 6 28.9 M4
Grid 7 39.1 M4	Grid 8 30.0 M4	Grid 9 28.7 M4

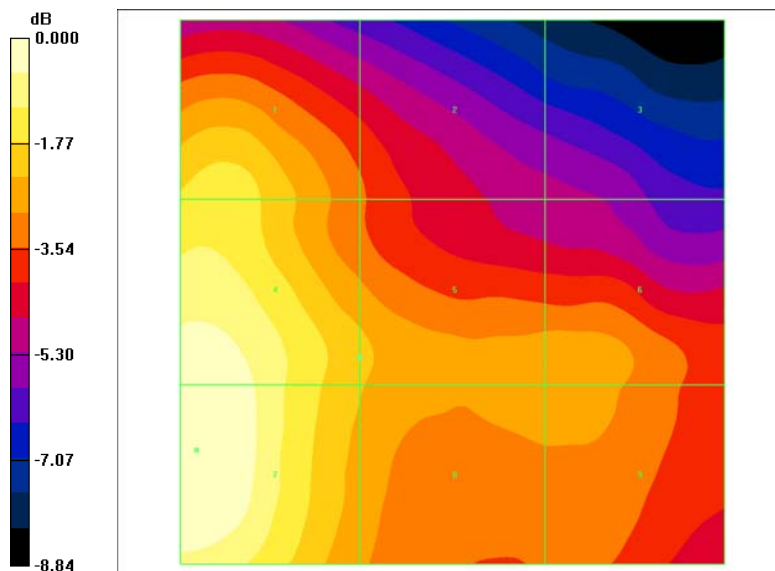

0 dB = 39.1V/m

Plot #6

835 H Field Testing Low CH

DUT: BinaTone Electrics; Type: GSM phone; Serial: R13091610

Communication System: GSM 850; Frequency: 824.2 MHz; Duty Cycle: 1:8.3
 Medium parameters used: $\sigma = 0$ mho/m, $\epsilon_r = 1$; $\rho = 1$ kg/m³
 Phantom section: E Dipole Section
 Measurement Standard: DAS4 (High Precision Assessment)

DASY4 Configuration:

- Probe: H3DV6 - SN6158; ; Calibrated: 1/11/2013
- Sensor-Surface: (Fix Surface)
- Electronics: DAE3 Sn456; Calibrated: 3/16/2012
- Phantom: HAC Test Arch; Type: SD HAC P01 BA; Serial: 1009
- Measurement SW: DAS4, V4.7 Build 80; Postprocessing SW: SEMCAD, V1.8 Build 186

H Scan 10mm above 850 MHz/Hearing Aid Compatibility Test (101x101x1): Measurement grid: dx=5mm, dy=5mm
 Maximum value of peak Total field = 0.163 A/m
 Probe Modulation Factor = 2.88
 Device Reference Point: 0.000, 0.000, 354.7 mm
 Reference Value = 0.036 A/m; Power Drift = 0.103 dB
Hearing Aid Near-Field Category: M4 (AWF -5 dB)

Peak H-field in A/m

Grid 1 0.163 M4	Grid 2 0.127 M4	Grid 3 0.074 M4
Grid 4 0.161 M4	Grid 5 0.129 M4	Grid 6 0.084 M4
Grid 7 0.150 M4	Grid 8 0.121 M4	Grid 9 0.087 M4

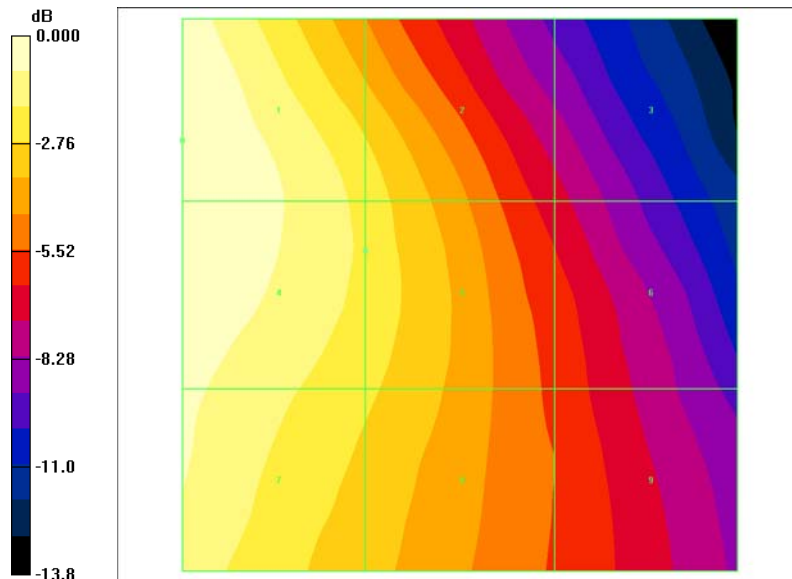

0 dB = 0.163A/m

Plot #7

835 H Field Testing Mid CH

DUT: BinaTone Electrics; Type: GSM phone; Serial: R13091610

Communication System: GSM 850; Frequency: 836.6 MHz; Duty Cycle: 1:8.3
 Medium parameters used: $\sigma = 0$ mho/m, $\epsilon_r = 1$; $\rho = 1$ kg/m³
 Phantom section: E Dipole Section
 Measurement Standard: DAS4 (High Precision Assessment)

DASY4 Configuration:

- Probe: H3DV6 - SN6158; ; Calibrated: 1/11/2013
- Sensor-Surface: (Fix Surface)
- Electronics: DAE3 Sn456; Calibrated: 3/16/2012
- Phantom: HAC Test Arch; Type: SD HAC P01 BA; Serial: 1009
- Measurement SW: DAS4, V4.7 Build 80; Postprocessing SW: SEMCAD, V1.8 Build 186

H Scan 10mm above 850 MHz/Hearing Aid Compatibility Test (101x101x1): Measurement grid: dx=5mm, dy=5mm

Maximum value of peak Total field = 0.179 A/m

Probe Modulation Factor = 2.88

Device Reference Point: 0.000, 0.000, 354.7 mm

Reference Value = 0.034 A/m; Power Drift = 0.019 dB

Hearing Aid Near-Field Category: M4 (AWF -5 dB)

Peak H-field in A/m

Grid 1 0.179 M4	Grid 2 0.124 M4	Grid 3 0.069 M4
Grid 4 0.171 M4	Grid 5 0.124 M4	Grid 6 0.082 M4
Grid 7 0.160 M4	Grid 8 0.119 M4	Grid 9 0.085 M4

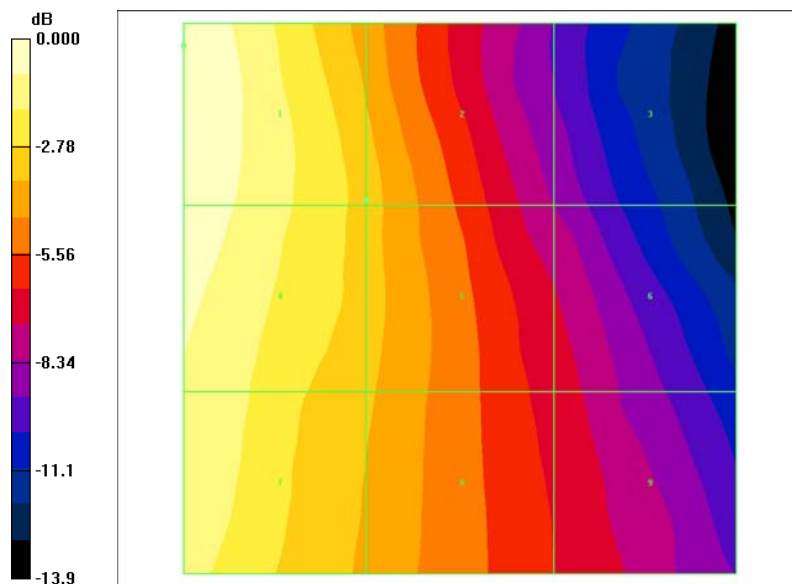

0 dB = 0.179A/m

Plot #8

835 H Field Testing High CH

DUT: BinaTone Electrics; Type: GSM phone; Serial: R13091610

Communication System: GSM 850; Frequency: 848.8 MHz; Duty Cycle: 1:8.3
 Medium parameters used: $\sigma = 0$ mho/m, $\epsilon_r = 1$; $\rho = 1$ kg/m³
 Phantom section: E Dipole Section
 Measurement Standard: DAS4 (High Precision Assessment)

DASY4 Configuration:

- Probe: H3DV6 - SN6158; ; Calibrated: 1/11/2013
- Sensor-Surface: (Fix Surface)
- Electronics: DAE3 Sn456; Calibrated: 3/16/2012
- Phantom: HAC Test Arch; Type: SD HAC P01 BA; Serial: 1009
- Measurement SW: DAS4, V4.7 Build 80; Postprocessing SW: SEMCAD, V1.8 Build 186

H Scan 10mm above 850 MHz/Hearing Aid Compatibility Test (101x101x1): Measurement grid: dx=5mm, dy=5mm
 Maximum value of peak Total field = 0.209 A/m
 Probe Modulation Factor = 2.88
 Device Reference Point: 0.000, 0.000, 354.7 mm
 Reference Value = 0.037 A/m; Power Drift = 0.092 dB
Hearing Aid Near-Field Category: M4 (AWF -5 dB)

Peak H-field in A/m

Grid 1 0.209 M4	Grid 2 0.136 M4	Grid 3 0.075 M4
Grid 4 0.197 M4	Grid 5 0.136 M4	Grid 6 0.087 M4
Grid 7 0.185 M4	Grid 8 0.131 M4	Grid 9 0.093 M4

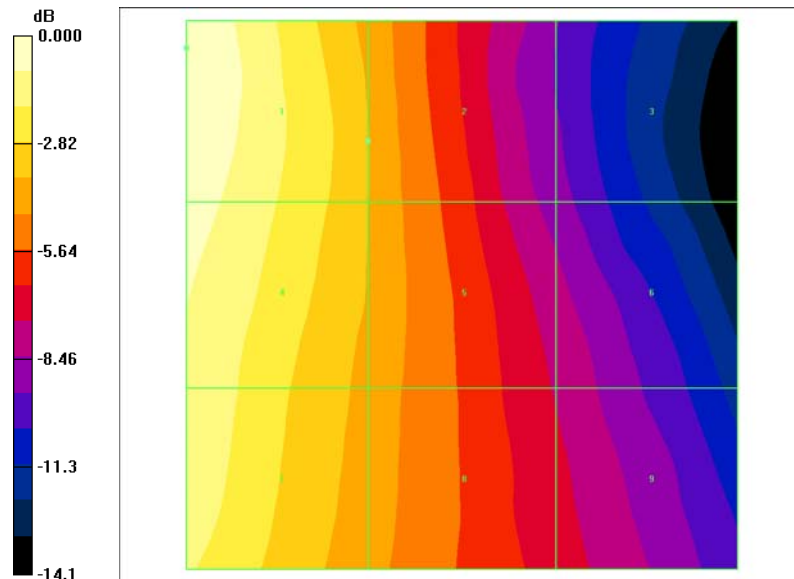

0 dB = 0.209A/m

Plot #9

1900 H Field Testing Low CH

DUT: BinaTone Electrics; Type: GSM phone; Serial: R13091610

Communication System: PCS 1900; Frequency: 1850.2 MHz; Duty Cycle: 1:8.3
 Medium parameters used: $\sigma = 0$ mho/m, $\epsilon_r = 1$; $\rho = 1$ kg/m³
 Phantom section: E Dipole Section
 Measurement Standard: DAS4 (High Precision Assessment)

DASY4 Configuration:

- Probe: H3DV6 - SN6158; ; Calibrated: 1/11/2013
- Sensor-Surface: (Fix Surface)
- Electronics: DAE3 Sn456; Calibrated: 3/16/2012
- Phantom: HAC Test Arch; Type: SD HAC P01 BA; Serial: 1009
- Measurement SW: DAS4, V4.7 Build 80; Postprocessing SW: SEMCAD, V1.8 Build 186

H Scan 10mm above 850 MHz/Hearing Aid Compatibility Test (101x101x1): Measurement grid: dx=5mm, dy=5mm
 Maximum value of peak Total field = 0.164 A/m
 Probe Modulation Factor = 2.88
 Device Reference Point: 0.000, 0.000, 354.7 mm
 Reference Value = 0.037 A/m; Power Drift = 0.038 dB
Hearing Aid Near-Field Category: M3 (AWF -5 dB)

Peak H-field in A/m

Grid 1 0.128 M4	Grid 2 0.105 M4	Grid 3 0.084 M4
Grid 4 0.160 M3	Grid 5 0.134 M4	Grid 6 0.097 M4
Grid 7 0.164 M3	Grid 8 0.136 M4	Grid 9 0.099 M4

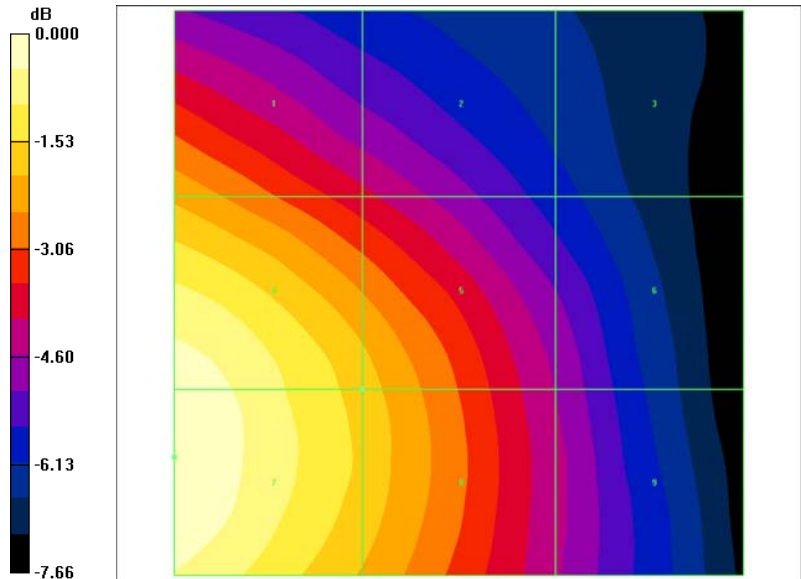

0 dB = 0.164A/m

Plot #10

1900 H Field Testing Mid CH

DUT: BinaTone Electrics; Type: GSM phone; Serial: R13091610

Communication System: PCS 1900; Frequency: 1880 MHz; Duty Cycle: 1:8.3
 Medium parameters used: $\sigma = 0$ mho/m, $\epsilon_r = 1$; $\rho = 1$ kg/m³
 Phantom section: E Dipole Section
 Measurement Standard: DAS4 (High Precision Assessment)

DASY4 Configuration:

- Probe: H3DV6 - SN6158; ; Calibrated: 1/11/2013
- Sensor-Surface: (Fix Surface)
- Electronics: DAE3 Sn456; Calibrated: 3/16/2012
- Phantom: HAC Test Arch; Type: SD HAC P01 BA; Serial: 1009
- Measurement SW: DAS4, V4.7 Build 80; Postprocessing SW: SEMCAD, V1.8 Build 186

H Scan 10mm above 850 MHz/Hearing Aid Compatibility Test (101x101x1): Measurement grid: dx=5mm, dy=5mm
 Maximum value of peak Total field = 0.145 A/m
 Probe Modulation Factor = 2.88
 Device Reference Point: 0.000, 0.000, 354.7 mm
 Reference Value = 0.032 A/m; Power Drift = 0.128 dB
Hearing Aid Near-Field Category: M3 (AWF -5 dB)

Peak H-field in A/m

Grid 1	Grid 2	Grid 3
0.110 M4	0.090 M4	0.067 M4
Grid 4	Grid 5	Grid 6
0.141 M3	0.122 M4	0.087 M4
Grid 7	Grid 8	Grid 9
0.145 M3	0.125 M4	0.091 M4

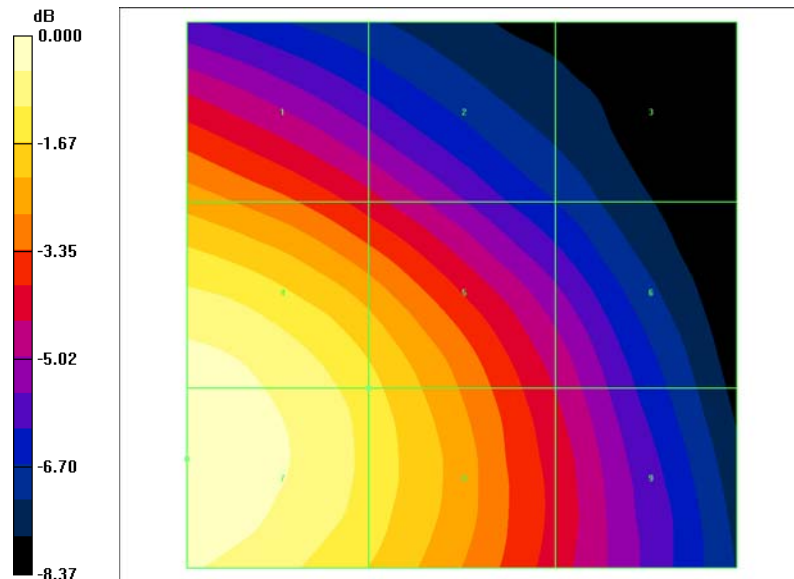

0 dB = 0.145A/m

Plot #11

1900 E Field Testing High CH

DUT: BinaTone Electrics; Type: GSM phone; Serial: R13091610

Communication System: PCS 1900; Frequency: 1909.8 MHz; Duty Cycle: 1:8.3
 Medium parameters used: $\sigma = 0$ mho/m, $\epsilon_r = 1$; $\rho = 1$ kg/m³
 Phantom section: E Dipole Section
 Measurement Standard: DAS4 (High Precision Assessment)

DASY4 Configuration:

- Probe: H3DV6 - SN6158; ; Calibrated: 1/11/2013
- Sensor-Surface: (Fix Surface)
- Electronics: DAE3 Sn456; Calibrated: 3/16/2012
- Phantom: HAC Test Arch; Type: SD HAC P01 BA; Serial: 1009
- Measurement SW: DAS4, V4.7 Build 80; Postprocessing SW: SEMCAD, V1.8 Build 186

H Scan 10mm above 850 MHz/Hearing Aid Compatibility Test (101x101x1): Measurement grid: dx=5mm, dy=5mm
 Maximum value of peak Total field = 0.118 A/m
 Probe Modulation Factor = 2.88
 Device Reference Point: 0.000, 0.000, 354.7 mm
 Reference Value = 0.028 A/m; Power Drift = 0.072 dB
Hearing Aid Near-Field Category: M4 (AWF -5 dB)

Peak H-field in A/m

Grid 1 0.095 M4	Grid 2 0.080 M4	Grid 3 0.057 M4
Grid 4 0.116 M4	Grid 5 0.103 M4	Grid 6 0.073 M4
Grid 7 0.118 M4	Grid 8 0.104 M4	Grid 9 0.076 M4

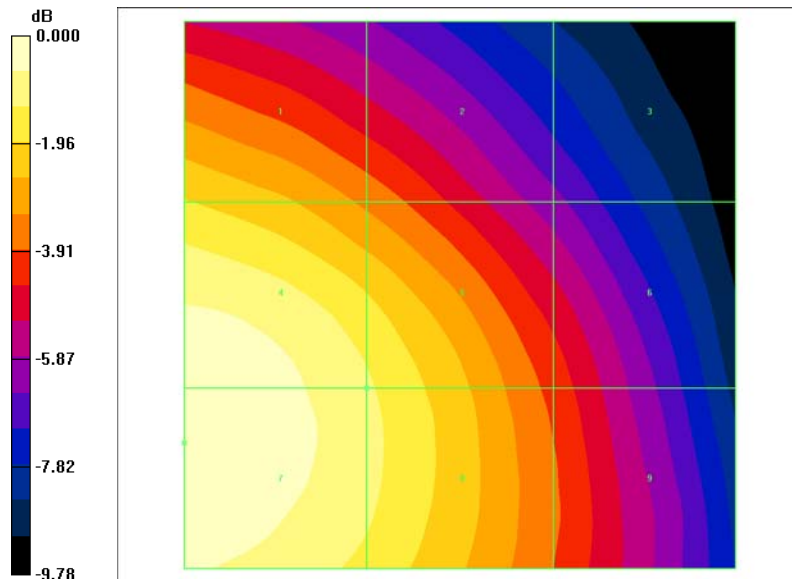

0 dB = 0.118A/m

Plot #12

10 APPENDIX B – PROBE CALIBRATION CERTIFICATIONS

**Calibration Laboratory of
Schmid & Partner
Engineering AG**
Zeughausstrasse 43, 8004 Zurich, Switzerland



S Schweizerischer Kalibrierdienst
S Service suisse d'étalonnage
S Servizio svizzero di taratura
S Swiss Calibration Service

Accredited by the Swiss Accreditation Service (SAS)
The Swiss Accreditation Service is one of the signatories to the EA
Multilateral Agreement for the recognition of calibration certificates

Accreditation No.: **SCS 108**

Client **BACL**

Certificate No: **ER3-2338_Jan13**

CALIBRATION CERTIFICATE

Object **ER3DV6 - SN:2338**

Calibration procedure(s) **QA CAL-02.v6, QA CAL-25.v4
Calibration procedure for E-field probes optimized for close near field
evaluations in air**

Calibration date: **January 11, 2013**

This calibration certificate documents the traceability to national standards, which realize the physical units of measurements (SI).
The measurements and the uncertainties with confidence probability are given on the following pages and are part of the certificate.

All calibrations have been conducted in the closed laboratory facility: environment temperature (22 ± 3)°C and humidity < 70%.

Calibration Equipment used (M&TE critical for calibration)

Primary Standards	ID	Cal Date (Certificate No.)	Scheduled Calibration
Power meter E4419B	GB41293874	29-Mar-12 (No. 217-01508)	Apr-13
Power sensor E4412A	MY41498087	29-Mar-12 (No. 217-01508)	Apr-13
Reference 3 dB Attenuator	SN: S5054 (3c)	27-Mar-12 (No. 217-01531)	Apr-13
Reference 20 dB Attenuator	SN: S5086 (20b)	27-Mar-12 (No. 217-01529)	Apr-13
Reference 30 dB Attenuator	SN: S5129 (30b)	27-Mar-12 (No. 217-01532)	Apr-13
Reference Probe ER3DV6	SN: 2328	12-Oct-12 (No. ER3-2328_Oct12)	Oct-13
DAE4	SN: 789	18-Sep-12 (No. DAE4-789_Sep12)	Sep-13
Secondary Standards	ID	Check Date (in house)	Scheduled Check
RF generator HP 8648C	US3642U01700	4-Aug-99 (in house check Apr-11)	In house check: Apr-13
Network Analyzer HP 8753E	US37390585	18-Oct-01 (in house check Oct-12)	In house check: Oct-13

	Name	Function	Signature
Calibrated by:	Jeton Kastrati	Laboratory Technician	
Approved by:	Katja Pokovic	Technical Manager	

Issued: January 11, 2013

This calibration certificate shall not be reproduced except in full without written approval of the laboratory.

**Calibration Laboratory of
Schmid & Partner
Engineering AG**
Zeughausstrasse 43, 8004 Zurich, Switzerland



S Schweizerischer Kalibrierdienst
S Service suisse d'étalonnage
C Servizio svizzero di taratura
S Swiss Calibration Service

Accredited by the Swiss Accreditation Service (SAS)
The Swiss Accreditation Service is one of the signatories to the EA
Multilateral Agreement for the recognition of calibration certificates

Accreditation No.: **SCS 108**

Glossary:

NORM _{x,y,z}	sensitivity in free space
DCP	diode compression point
CF	crest factor (1/duty_cycle) of the RF signal
A, B, C, D	modulation dependent linearization parameters
Polarization φ	φ rotation around probe axis
Polarization ϑ	ϑ rotation around an axis that is in the plane normal to probe axis (at measurement center), i.e., $\vartheta = 0$ is normal to probe axis
Connector Angle	information used in DASY system to align probe sensor X to the robot coordinate system

Calibration is Performed According to the Following Standards:

- IEEE Std 1309-2005, "IEEE Standard for calibration of electromagnetic field sensors and probes, excluding antennas, from 9 kHz to 40 GHz", December 2005
- CTIA Test Plan for Hearing Aid Compatibility, April 2010.

Methods Applied and Interpretation of Parameters:

- NORM_{x,y,z}**: Assessed for E-field polarization $\vartheta = 0$ for XY sensors and $\vartheta = 90$ for Z sensor ($f \leq 900$ MHz in TEM-cell; $f > 1800$ MHz: R22 waveguide).
- NORM(f)_{x,y,z}** = NORM_{x,y,z} * frequency_response (see Frequency Response Chart).
- DCP_{x,y,z}**: DCP are numerical linearization parameters assessed based on the data of power sweep with CW signal (no uncertainty required). DCP does not depend on frequency nor media.
- PAR**: PAR is the Peak to Average Ratio that is not calibrated but determined based on the signal characteristics
- A_{x,y,z}; B_{x,y,z}; C_{x,y,z}; D_{x,y,z}; VR_{x,y,z}**: A, B, C, D are numerical linearization parameters assessed based on the data of power sweep for specific modulation signal. The parameters do not depend on frequency nor media. VR is the maximum calibration range expressed in RMS voltage across the diode.
- Spherical isotropy (3D deviation from isotropy)**: in a locally homogeneous field realized using an open waveguide setup.
- Sensor Offset**: The sensor offset corresponds to the offset of virtual measurement center from the probe tip (on probe axis). No tolerance required.
- Connector Angle**: The angle is assessed using the information gained by determining the NORM_x (no uncertainty required).

ER3DV6 – SN:2338

January 11, 2013

Probe ER3DV6

SN:2338

Manufactured: June 15, 2004
Calibrated: January 11, 2013

Calibrated for DASY/EASY Systems
(Note: non-compatible with DASY2 system!)

ER3DV6- SN:2338

January 11, 2013

DASY/EASY - Parameters of Probe: ER3DV6 - SN:2338

Basic Calibration Parameters

	Sensor X	Sensor Y	Sensor Z	Unc (k=2)
Norm ($\mu\text{V}/(\text{V}/\text{m})^2$)	1.66	1.70	1.97	$\pm 10.1\%$
DCP (mV) ^b	98.6	98.6	98.0	

Modulation Calibration Parameters

UID	Communication System Name		A dB	B dB $\sqrt{\mu\text{V}}$	C	D dB	VR mV	Unc ^c (k=2)
0	CW	X	0.0	0.0	1.0	0.00	166.5	$\pm 2.7\%$
		Y	0.0	0.0	1.0		159.1	
		Z	0.0	0.0	1.0		157.7	

The reported uncertainty of measurement is stated as the standard uncertainty of measurement multiplied by the coverage factor k=2, which for a normal distribution corresponds to a coverage probability of approximately 95%.

^b Numerical linearization parameter: uncertainty not required.

^c Uncertainty is determined using the max. deviation from linear response applying rectangular distribution and is expressed for the square of the field value.

ER3DV6- SN:2338

January 11, 2013

Frequency Response of E-Field (TEM-Cell:ifi110 EXX, Waveguide: R22)

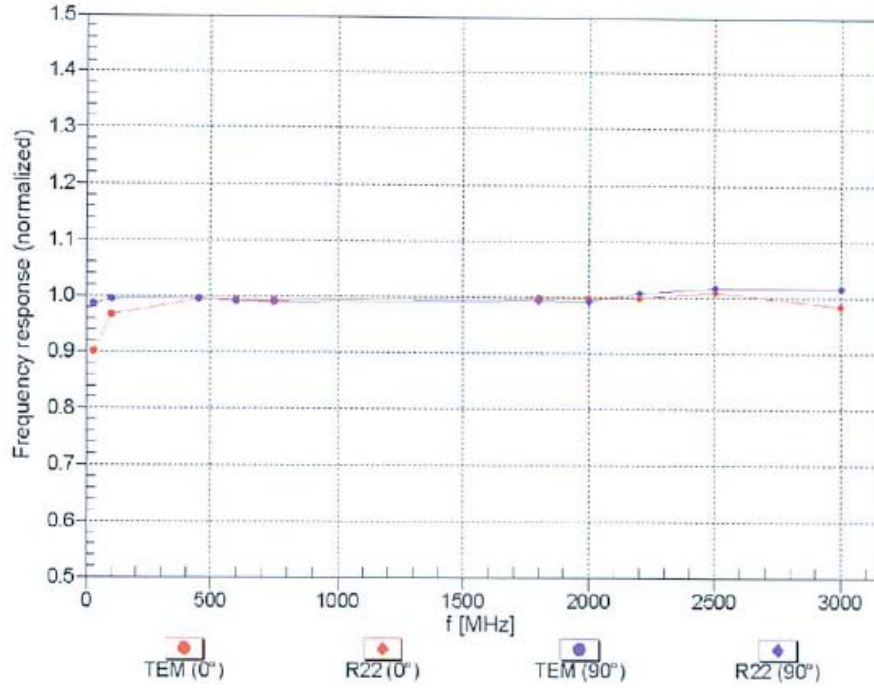

Uncertainty of Frequency Response of E-field: $\pm 6.3\%$ (k=2)

ER3DV6- SN:2338

January 11, 2013

Receiving Pattern (ϕ), $\vartheta = 0^\circ$

f=600 MHz,TEM,0°



f=2500 MHz,R22,0°

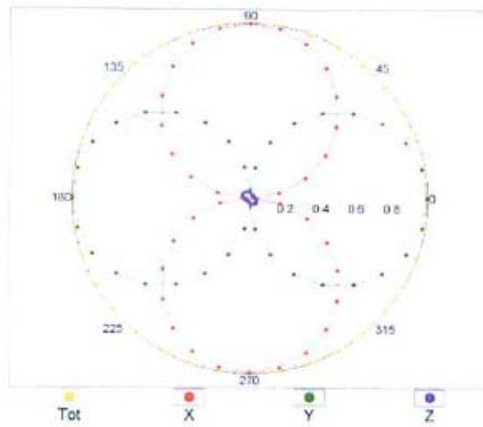

Receiving Pattern (ϕ), $\vartheta = 90^\circ$

f=600 MHz,TEM,90°

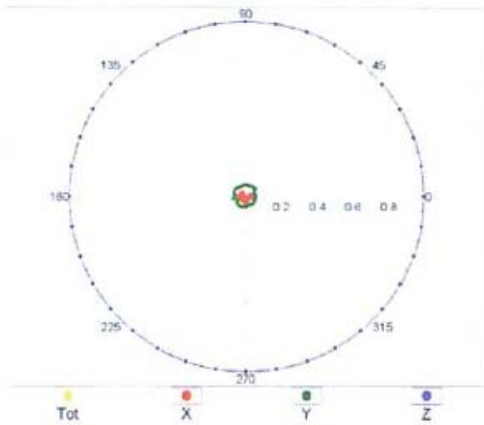

f=2500 MHz,R22,90°

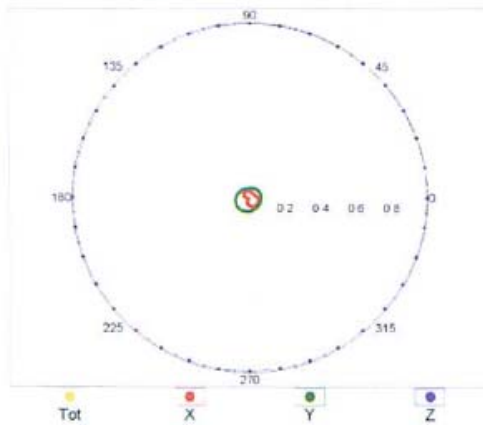

ER3DV6- SN.2338

January 11, 2013

Receiving Pattern (ϕ), $\vartheta = 0^\circ$

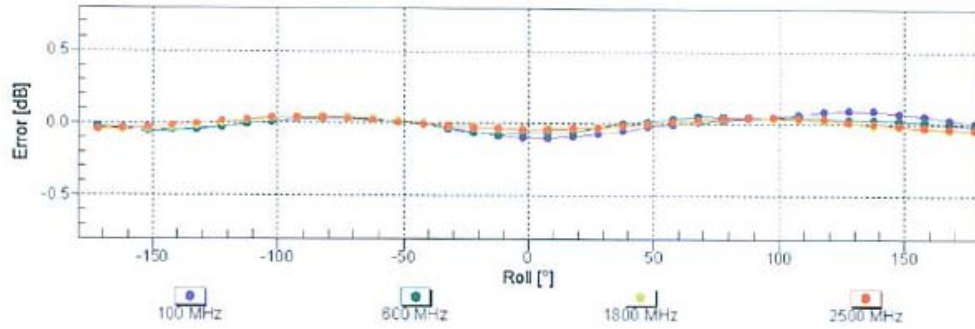

Uncertainty of Axial Isotropy Assessment: $\pm 0.5\%$ (k=2)

Receiving Pattern (ϕ), $\vartheta = 90^\circ$

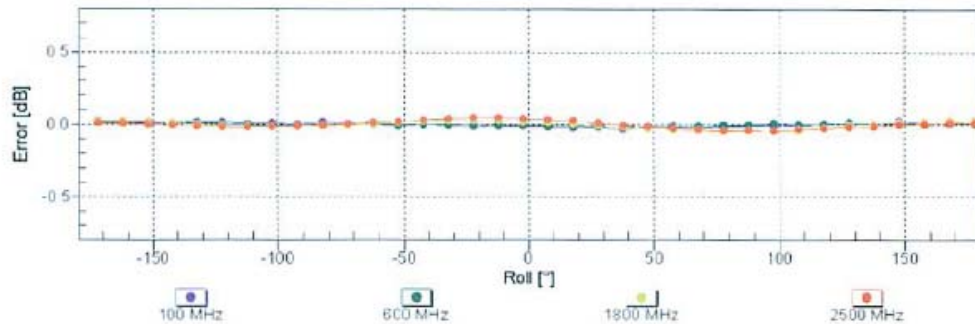

Uncertainty of Axial Isotropy Assessment: $\pm 0.5\%$ (k=2)

ER3DV6- SN:2338

January 11, 2013

Dynamic Range f(E-field) (TEM cell , f = 900 MHz)

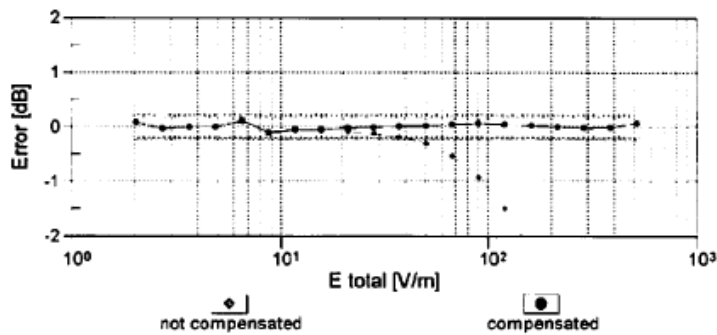
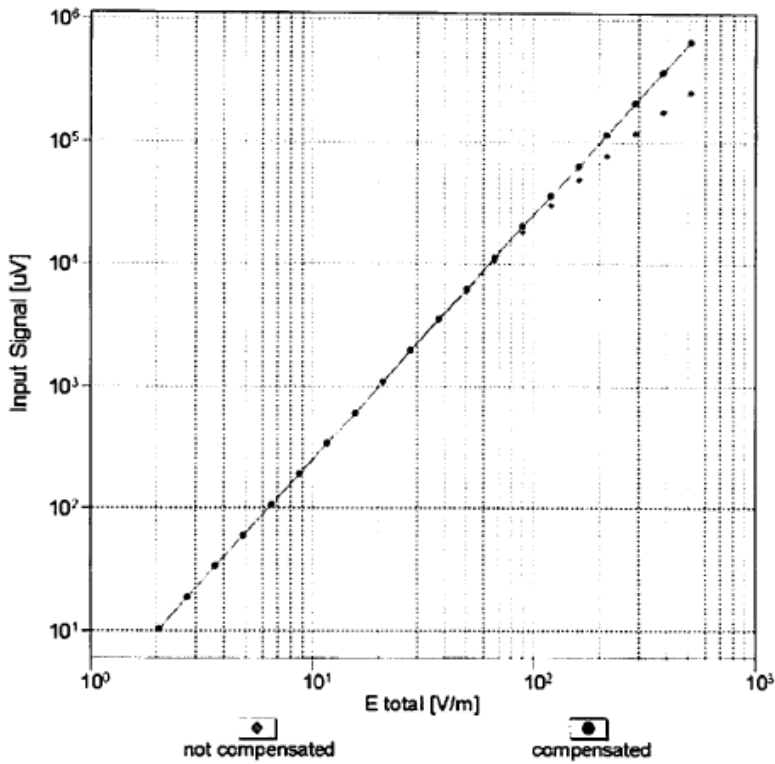

Uncertainty of Linearity Assessment: ± 0.6% (k=2)

ER3DV6- SN:2338

January 11, 2013

Deviation from Isotropy in Air Error (ϕ, θ), $f = 900$ MHz

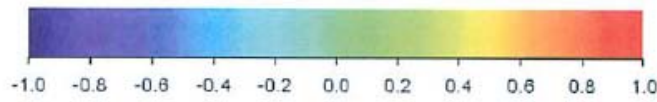
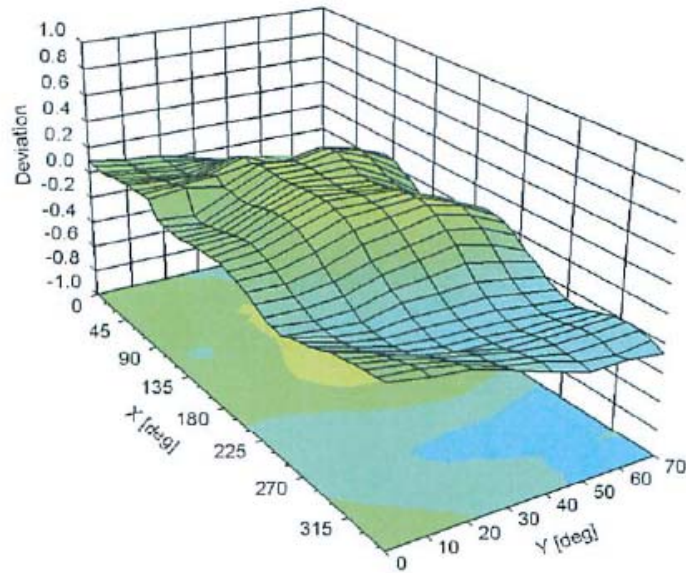

Uncertainty of Spherical Isotropy Assessment: $\pm 2.6\%$ ($k=2$)

ER3DV6- SN:2338

January 11, 2013

DASY/EASY - Parameters of Probe: ER3DV6 - SN:2338**Other Probe Parameters**

Sensor Arrangement	Rectangular
Connector Angle (°)	-42.2
Mechanical Surface Detection Mode	enabled
Optical Surface Detection Mode	disabled
Probe Overall Length	337 mm
Probe Body Diameter	10 mm
Tip Length	10 mm
Tip Diameter	8 mm
Probe Tip to Sensor X Calibration Point	2.5 mm
Probe Tip to Sensor Y Calibration Point	2.5 mm
Probe Tip to Sensor Z Calibration Point	2.5 mm

**Calibration Laboratory of
Schmid & Partner
Engineering AG**
Zeughausstrasse 43, 8004 Zurich, Switzerland



S Schweizerischer Kalbrierdienst
S Service suisse d'étalonnage
C Servizio svizzero di taratura
S Swiss Calibration Service

Accredited by the Swiss Accreditation Service (SAS)
The Swiss Accreditation Service is one of the signatories to the EA
Multilateral Agreement for the recognition of calibration certificates

Accreditation No.: **SCS 108**

Client **BACL**

Certificate No: **H3-6158_Jan13**

CALIBRATION CERTIFICATE

Object **H3DV6 - SN:6158**

Calibration procedure(s) **QA CAL-03.v6, QA CAL-25.v4
Calibration procedure for H-field probes optimized for close near field
evaluations in air**

Calibration date: **January 11, 2013**

This calibration certificate documents the traceability to national standards, which realize the physical units of measurements (SI).
The measurements and the uncertainties with confidence probability are given on the following pages and are part of the certificate.

All calibrations have been conducted in the closed laboratory facility: environment temperature (22 ± 3)°C and humidity < 70%.

Calibration Equipment used (M&TE critical for calibration)

Primary Standards	ID	Cal Date (Certificate No.)	Scheduled Calibration
Power meter E4419B	GB41293874	29-Mar-12 (No. 217-01508)	Apr-13
Power sensor E4412A	MY41498087	29-Mar-12 (No. 217-01508)	Apr-13
Reference 3 dB Attenuator	SN: S5054 (3c)	27-Mar-12 (No. 217-01531)	Apr-13
Reference 20 dB Attenuator	SN: S5086 (20b)	27-Mar-12 (No. 217-01529)	Apr-13
Reference 30 dB Attenuator	SN: S5129 (30b)	27-Mar-12 (No. 217-01532)	Apr-13
Reference Probe H3DV6	SN: 6182	12-Oct-12 (No. H3-6182_Oct12)	Oct-13
DAE4	SN: 789	18-Sep-12 (No. DAE4-789_Sep12)	Sep-13
Secondary Standards	ID	Check Date (in house)	Scheduled Check
RF generator HP 8648C	US3642U01700	4-Aug-99 (in house check Apr-11)	In house check: Apr-13
Network Analyzer HP 8753E	US37390585	18-Oct-01 (in house check Oct-12)	In house check: Oct-13

	Name	Function	Signature
Calibrated by:	Jeton Kastrati	Laboratory Technician	
Approved by:	Katja Pokovic	Technical Manager	

Issued: January 11, 2013

This calibration certificate shall not be reproduced except in full without written approval of the laboratory.

**Calibration Laboratory of
Schmid & Partner
Engineering AG**
Zeughausstrasse 43, 8004 Zurich, Switzerland



S Schweizerischer Kalibrierdienst
S Service suisse d'étalonnage
C Servizio svizzero di taratura
S Swiss Calibration Service

Accredited by the Swiss Accreditation Service (SAS)
The Swiss Accreditation Service is one of the signatories to the EA
Multilateral Agreement for the recognition of calibration certificates

Accreditation No.: **SCS 108**

Glossary:

NORM _{x,y,z}	sensitivity in free space
DCP	diode compression point
CF	crest factor (1/duty_cycle) of the RF signal
A, B, C, D	modulation dependent linearization parameters
Polarization φ	φ rotation around probe axis
Polarization ϑ	ϑ rotation around an axis that is in the plane normal to probe axis (at measurement center), i.e., $\vartheta = 0$ is normal to probe axis
Connector Angle	information used in DASY system to align probe sensor X to the robot coordinate system

Calibration is Performed According to the Following Standards:

- IEEE Std 1309-2005, " IEEE Standard for calibration of electromagnetic field sensors and probes, excluding antennas, from 9 kHz to 40 GHz", December 2005.
- CTIA Test Plan for Hearing Aid Compatibility, April 2010.

Methods Applied and Interpretation of Parameters:

- NORM_{x,y,z}**: Assessed for E-field polarization $\vartheta = 0$ for XY sensors and $\vartheta = 90$ for Z sensor ($f \leq 900$ MHz in TEM-cell; $f > 1800$ MHz: R22 waveguide).
- X, Y, Z(f)**: $X, Y, Z = X_0 a_1 a_2 \cdot \text{frequency_response}$ (see Frequency Response Chart).
- DCP_{x,y,z}**: DCP are numerical linearization parameters assessed based on the data of power sweep with CW signal (no uncertainty required). DCP does not depend on frequency nor media.
- PAR**: PAR is the Peak to Average Ratio that is not calibrated but determined based on the signal characteristics
- A_{x,y,z}; B_{x,y,z}; C_{x,y,z}; D_{x,y,z}; VR_{x,y,z}**: A, B, C, D are numerical linearization parameters assessed based on the data of power sweep for specific modulation signal. The parameters do not depend on frequency nor media. VR is the maximum calibration range expressed in RMS voltage across the diode.
- Spherical isotropy (3D deviation from isotropy)**: in a locally homogeneous field realized using an open waveguide setup.
- Sensor Offset**: The sensor offset corresponds to the offset of virtual measurement center from the probe tip (on probe axis). No tolerance required.
- Connector Angle**: The angle is assessed using the information gained by determining the $X_0 a_1 a_2$ (no uncertainty required).

H3DV6 – SN:6158

January 11, 2013

Probe H3DV6

SN:6158

Manufactured: June 22, 2004
Calibrated: January 11, 2013

Calibrated for DASY/EASY Systems
(Note: non-compatible with DASY2 system!)

H3DV6- SN:6158

January 11, 2013

DASY/EASY - Parameters of Probe: H3DV6 - SN:6158

Basic Calibration Parameters

		Sensor X	Sensor Y	Sensor Z	Unc (k=2)
Norm (A/m / $\sqrt{(mV)}$)	a0	2.63E-003	2.60E-003	2.96E-003	$\pm 5.1 \%$
Norm (A/m / $\sqrt{(mV)}$)	a1	-6.19E-005	-9.93E-005	-1.34E-004	$\pm 5.1 \%$
Norm (A/m / $\sqrt{(mV)}$)	a2	3.15E-005	3.76E-006	3.90E-005	$\pm 5.1 \%$
DCP (mV) ^B		93.7	91.9	92.2	

Modulation Calibration Parameters

UID	Communication System Name		A dB	B dB $\sqrt{\mu V}$	C	D dB	VR mV	Unc ^E (k=2)
0	CW	X	0.0	0.0	1.0	0.00	137.2	$\pm 2.7 \%$
		Y	0.0	0.0	1.0		139.8	
		Z	0.0	0.0	1.0		135.6	

The reported uncertainty of measurement is stated as the standard uncertainty of measurement multiplied by the coverage factor k=2, which for a normal distribution corresponds to a coverage probability of approximately 95%.

^B Numerical linearization parameter: uncertainty not required.

^E Uncertainty is determined using the max. deviation from linear response applying rectangular distribution and is expressed for the square of the field value.

H3DV6- SN:6158

January 11, 2013

Frequency Response of H-Field (TEM-Cell:ifi110 EXX, Waveguide: R22)

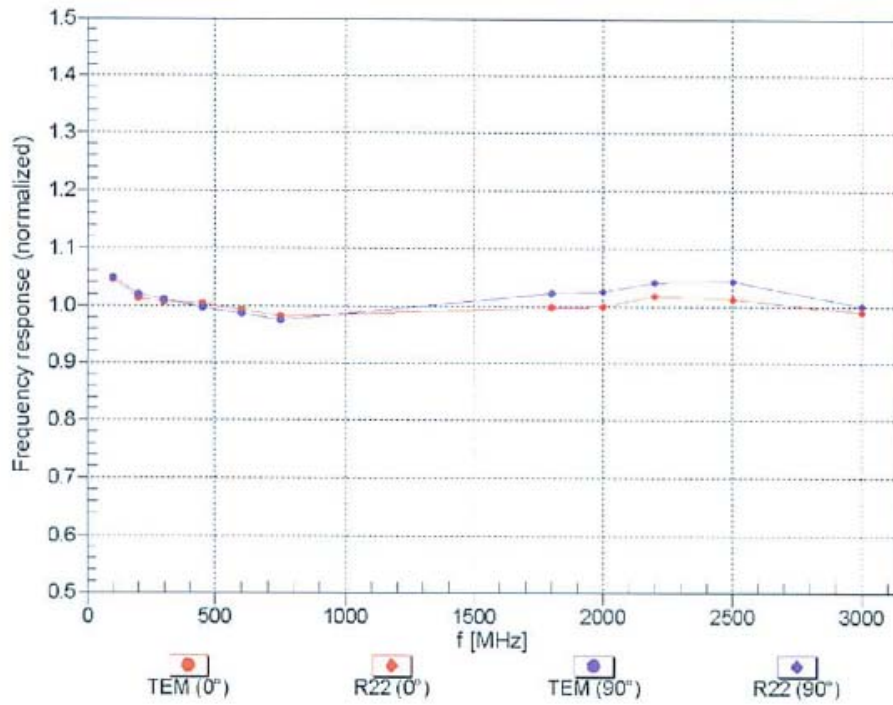

Uncertainty of Frequency Response of H-field: $\pm 6.3\%$ (k=2)

H3DV6- SN:6158

January 11, 2013

Receiving Pattern (ϕ), $\vartheta = 0^\circ$

f=600 MHz,TEM,0°



f=2500 MHz,R22,0°



Receiving Pattern (ϕ), $\vartheta = 90^\circ$

f=600 MHz,TEM,90°

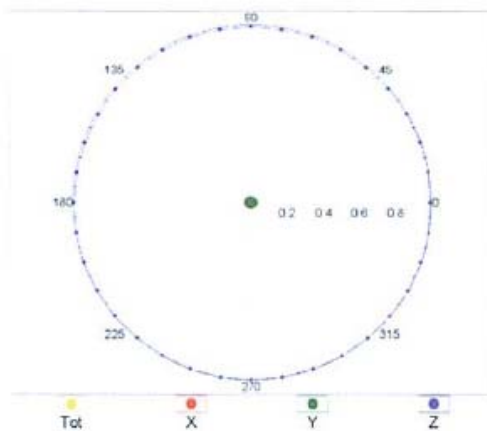

f=2500 MHz,R22,90°

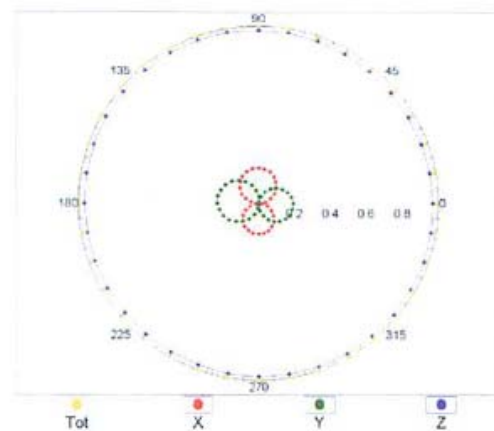

H3DV6- SN:6158

January 11, 2013

Receiving Pattern (ϕ), $\vartheta = 0^\circ$

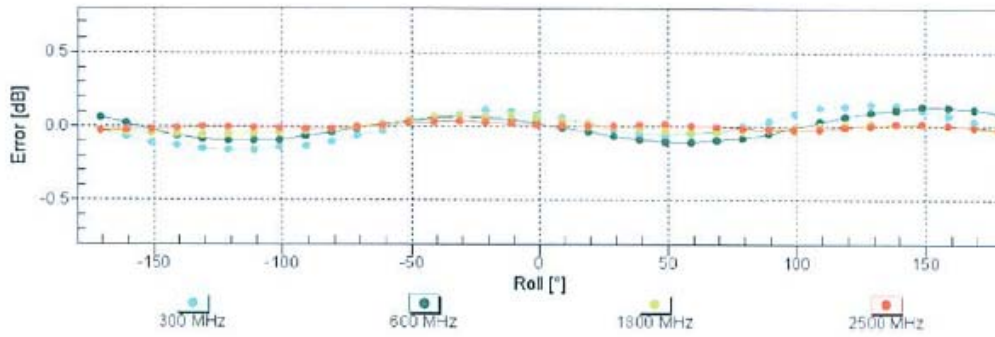

Uncertainty of Axial Isotropy Assessment: $\pm 0.5\%$ ($k=2$)

Receiving Pattern (ϕ), $\vartheta = 90^\circ$

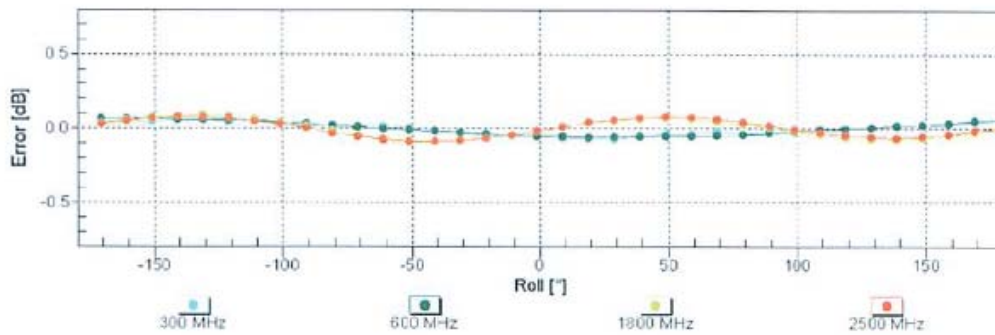

Uncertainty of Axial Isotropy Assessment: $\pm 0.5\%$ ($k=2$)

H3DV6- SN:6158

January 11, 2013

Dynamic Range f(H-field) (TEM cell, f = 900 MHz)

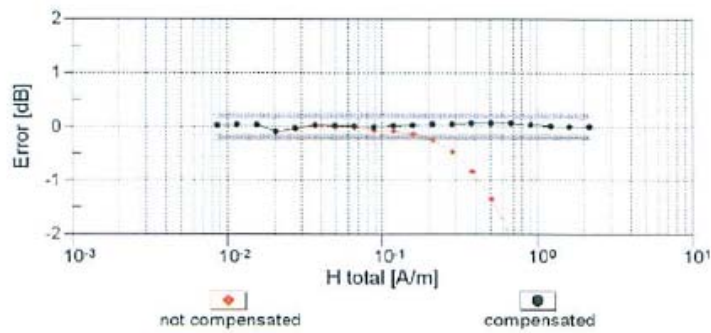
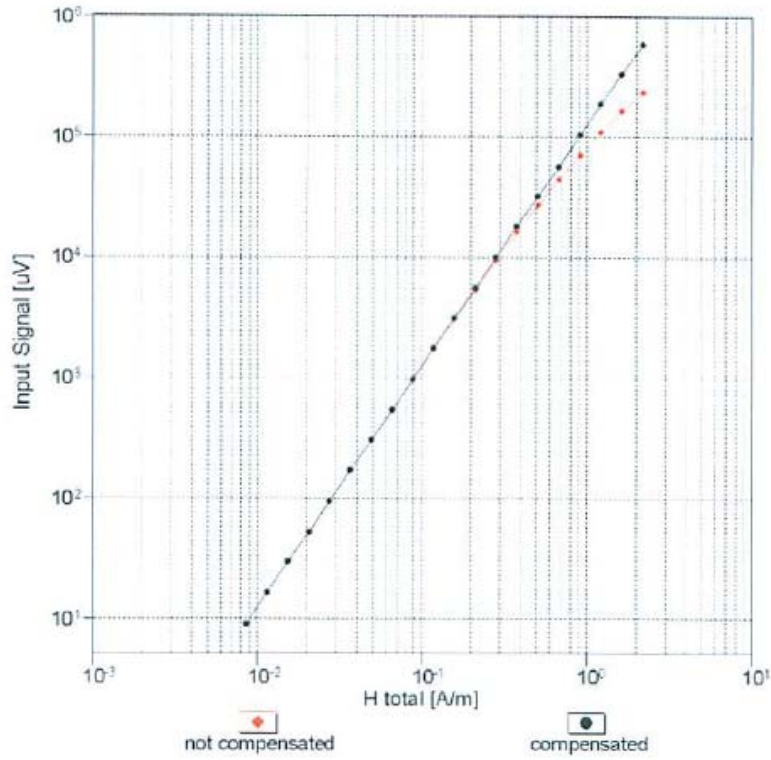

Uncertainty of Linearity Assessment: ± 0.6% (k=2)

H3DV6- SN:6158

January 11, 2013

Deviation from Isotropy in Air Error (ϕ, θ), $f = 900$ MHz

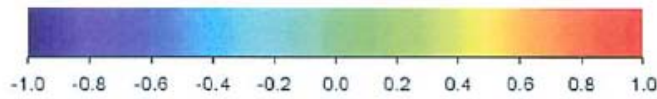
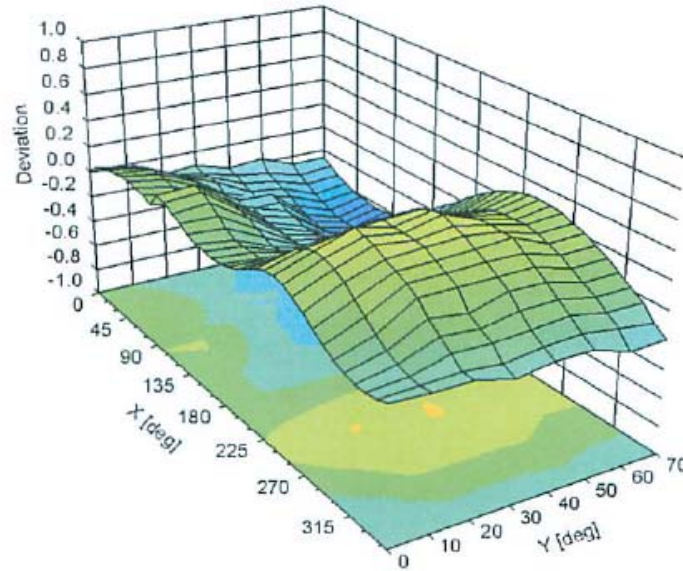

Uncertainty of Spherical Isotropy Assessment: $\pm 2.6\%$ ($k=2$)

H3DV6- SN:6158

January 11, 2013

DASY/EASY - Parameters of Probe: H3DV6 - SN:6158**Other Probe Parameters**

Sensor Arrangement	Rectangular
Connector Angle (°)	-81.1
Mechanical Surface Detection Mode	enabled
Optical Surface Detection Mode	disabled
Probe Overall Length	337 mm
Probe Body Diameter	10 mm
Tip Length	20 mm
Tip Diameter	6 mm
Probe Tip to Sensor X Calibration Point	3 mm
Probe Tip to Sensor Y Calibration Point	3 mm
Probe Tip to Sensor Z Calibration Point	3 mm

11 APPENDIX C – DIPOLE CALIBRATION CERTIFICATES

**Calibration Laboratory of
Schmid & Partner
Engineering AG**
Zeughausstrasse 43, 8004 Zurich, Switzerland



S Schweizerischer Kalibrierdienst
C Service suisse d'étalonnage
S Servizio svizzero di taratura
S Swiss Calibration Service

Accredited by the Swiss Accreditation Service (SAS)
The Swiss Accreditation Service is one of the signatories to the EA
Multilateral Agreement for the recognition of calibration certificates

Accreditation No.: **SCS 108**

Client **BACL**

Certificate No: **CD835V3-1012_Jan12**

CALIBRATION CERTIFICATE																																																			
Object	CD835V3 - SN: 1012																																																		
Calibration procedure(s)	QA CAL-20.v6 Calibration procedure for dipoles in air																																																		
Calibration date:	January 24, 2012																																																		
<p>This calibration certificate documents the traceability to national standards, which realize the physical units of measurements (SI). The measurements and the uncertainties with confidence probability are given on the following pages and are part of the certificate.</p> <p>All calibrations have been conducted in the closed laboratory facility: environment temperature (22 ± 3)°C and humidity < 70%.</p> <p>Calibration Equipment used (M&TE critical for calibration)</p> <table border="1"> <thead> <tr> <th>Primary Standards</th> <th>ID #</th> <th>Cal Date (Certificate No.)</th> <th>Scheduled Calibration</th> </tr> </thead> <tbody> <tr> <td>Power meter EPM-442A</td> <td>GB37480704</td> <td>05-Oct-11 (No. 217-01451)</td> <td>Oct-12</td> </tr> <tr> <td>Power sensor HP 8481A</td> <td>US37292783</td> <td>05-Oct-11 (No. 217-01451)</td> <td>Oct-12</td> </tr> <tr> <td>Probe ER3DV6</td> <td>SN: 2336</td> <td>29-Dec-11 (No. ER3-2336_Dec11)</td> <td>Dec-12</td> </tr> <tr> <td>Probe H3DV6</td> <td>SN: 6065</td> <td>29-Dec-11 (No. H3-6065_Dec11)</td> <td>Dec-12</td> </tr> <tr> <td>DAE4</td> <td>SN: 781</td> <td>20-Apr-11 (No. DAE4-781_Apr11)</td> <td>Apr-12</td> </tr> </tbody> </table> <table border="1"> <thead> <tr> <th>Secondary Standards</th> <th>ID #</th> <th>Check Date (in house)</th> <th>Scheduled Check</th> </tr> </thead> <tbody> <tr> <td>Power meter Agilent 4419B</td> <td>SN: GB42420191</td> <td>09-Oct-09 (in house check Oct-11)</td> <td>In house check: Oct-12</td> </tr> <tr> <td>Power sensor HP 8482H</td> <td>SN: 3318A09450</td> <td>09-Oct-09 (in house check Oct-11)</td> <td>In house check: Oct-12</td> </tr> <tr> <td>Power sensor HP 8482A</td> <td>SN: US37295597</td> <td>09-Oct-09 (in house check Oct-11)</td> <td>In house check: Oct-12</td> </tr> <tr> <td>Network Analyzer HP B753E</td> <td>US37390585</td> <td>18-Oct-01 (in house check Oct-11)</td> <td>In house check: Oct-12</td> </tr> <tr> <td>RF generator E4433B</td> <td>MY 41000675</td> <td>03-Nov-04 (in house check Oct-11)</td> <td>In house check: Oct-13</td> </tr> </tbody> </table>				Primary Standards	ID #	Cal Date (Certificate No.)	Scheduled Calibration	Power meter EPM-442A	GB37480704	05-Oct-11 (No. 217-01451)	Oct-12	Power sensor HP 8481A	US37292783	05-Oct-11 (No. 217-01451)	Oct-12	Probe ER3DV6	SN: 2336	29-Dec-11 (No. ER3-2336_Dec11)	Dec-12	Probe H3DV6	SN: 6065	29-Dec-11 (No. H3-6065_Dec11)	Dec-12	DAE4	SN: 781	20-Apr-11 (No. DAE4-781_Apr11)	Apr-12	Secondary Standards	ID #	Check Date (in house)	Scheduled Check	Power meter Agilent 4419B	SN: GB42420191	09-Oct-09 (in house check Oct-11)	In house check: Oct-12	Power sensor HP 8482H	SN: 3318A09450	09-Oct-09 (in house check Oct-11)	In house check: Oct-12	Power sensor HP 8482A	SN: US37295597	09-Oct-09 (in house check Oct-11)	In house check: Oct-12	Network Analyzer HP B753E	US37390585	18-Oct-01 (in house check Oct-11)	In house check: Oct-12	RF generator E4433B	MY 41000675	03-Nov-04 (in house check Oct-11)	In house check: Oct-13
Primary Standards	ID #	Cal Date (Certificate No.)	Scheduled Calibration																																																
Power meter EPM-442A	GB37480704	05-Oct-11 (No. 217-01451)	Oct-12																																																
Power sensor HP 8481A	US37292783	05-Oct-11 (No. 217-01451)	Oct-12																																																
Probe ER3DV6	SN: 2336	29-Dec-11 (No. ER3-2336_Dec11)	Dec-12																																																
Probe H3DV6	SN: 6065	29-Dec-11 (No. H3-6065_Dec11)	Dec-12																																																
DAE4	SN: 781	20-Apr-11 (No. DAE4-781_Apr11)	Apr-12																																																
Secondary Standards	ID #	Check Date (in house)	Scheduled Check																																																
Power meter Agilent 4419B	SN: GB42420191	09-Oct-09 (in house check Oct-11)	In house check: Oct-12																																																
Power sensor HP 8482H	SN: 3318A09450	09-Oct-09 (in house check Oct-11)	In house check: Oct-12																																																
Power sensor HP 8482A	SN: US37295597	09-Oct-09 (in house check Oct-11)	In house check: Oct-12																																																
Network Analyzer HP B753E	US37390585	18-Oct-01 (in house check Oct-11)	In house check: Oct-12																																																
RF generator E4433B	MY 41000675	03-Nov-04 (in house check Oct-11)	In house check: Oct-13																																																
Calibrated by:	Name Dimce Iliev	Function Laboratory Technician	Signature <i>D. Iliev</i>																																																
Approved by:	Fin Bornholt	R&D Director	<i>F. Bornholt</i>																																																
			Issued: January 25, 2012																																																
This calibration certificate shall not be reproduced except in full without written approval of the laboratory.																																																			

**Calibration Laboratory of
Schmid & Partner
Engineering AG**
Zeughausstrasse 43, 8004 Zurich, Switzerland



S Schweizerischer Kalibrierdienst
C Service suisse d'étalonnage
S Servizio svizzero di taratura
Swiss Calibration Service

Accredited by the Swiss Accreditation Service (SAS)
The Swiss Accreditation Service is one of the signatories to the EA
Multilateral Agreement for the recognition of calibration certificates

Accreditation No.: **SCS 108**

References

- [1] ANSI-C63.19-2007
American National Standard for Methods of Measurement of Compatibility between Wireless Communications Devices and Hearing Aids.

Methods Applied and Interpretation of Parameters:

- **Coordinate System:** y-axis is in the direction of the dipole arms. z-axis is from the basis of the antenna (mounted on the table) towards its feed point between the two dipole arms. x-axis is normal to the other axes. In coincidence with the standards [1], the measurement planes (probe sensor center) are selected to be at a distance of 10 mm above the top edge of the dipole arms.
- **Measurement Conditions:** Further details are available from the hardcopies at the end of the certificate. All figures stated in the certificate are valid at the frequency indicated. The forward power to the dipole connector is set with a calibrated power meter connected and monitored with an auxiliary power meter connected to a directional coupler. While the dipole under test is connected, the forward power is adjusted to the same level.
- **Antenna Positioning:** The dipole is mounted on a HAC Test Arch phantom using the matching dipole positioner with the arms horizontal and the feeding cable coming from the floor. The measurements are performed in a shielded room with absorbers around the setup to reduce the reflections. It is verified before the mounting of the dipole under the Test Arch phantom, that its arms are perfectly in a line. It is installed on the HAC dipole positioner with its arms parallel below the dielectric reference wire and able to move elastically in vertical direction without changing its relative position to the top center of the Test Arch phantom. The vertical distance to the probe is adjusted after dipole mounting with a DASY5 Surface Check job. Before the measurement, the distance between phantom surface and probe tip is verified. The proper measurement distance is selected by choosing the matching section of the HAC Test Arch phantom with the proper device reference point (upper surface of the dipole) and the matching grid reference point (tip of the probe) considering the probe sensor offset. The vertical distance to the probe is essential for the accuracy.
- **Feed Point Impedance and Return Loss:** These parameters are measured using a HP 8753E Vector Network Analyzer. The impedance is specified at the SMA connector of the dipole. The influence of reflections was eliminated by applying the averaging function while moving the dipole in the air, at least 70cm away from any obstacles.
- **E-field distribution:** E field is measured in the x-y-plane with an isotropic ER3D-field probe with 100 mW forward power to the antenna feed point. In accordance with [1], the scan area is 20mm wide, its length exceeds the dipole arm length (180 or 90mm). The sensor center is 10 mm (in z) above the top of the dipole arms. Two 3D maxima are available near the end of the dipole arms. Assuming the dipole arms are perfectly in one line, the average of these two maxima (in subgrid 2 and subgrid 8) is determined to compensate for any non-parallelity to the measurement plane as well as the sensor displacement. The E-field value stated as calibration value represents the maximum of the interpolated 3D-E-field, 10mm above the dipole surface.
- **H-field distribution:** H-field is measured with an isotropic H-field probe with 100mW forward power to the antenna feed point, in the x-y-plane. The scan area and sensor distance is equivalent to the E-field scan. The maximum of the field is available at the center (subgrid 5) above the feed point. The H-field value stated as calibration value represents the maximum of the interpolated H-field, 10mm above the dipole surface at the feed point.

Measurement Conditions

DASY system configuration, as far as not given on page 1.

DASY Version	DASY5	V52.8.0
Extrapolation	Advanced Extrapolation	
Phantom	HAC Test Arch	
Distance Dipole Top - Probe Center	10mm	
Scan resolution	dx, dy = 5 mm	
Frequency	835MHz \pm 1 MHz	
Input power drift	< 0.05 dB	

Maximum Field values

H-field 10 mm above dipole surface	condition	Interpolated maximum
Maximum measured	100 mW input power	0.470 A / m \pm 8.2 % (k=2)

E-field 10 mm above dipole surface	condition	Interpolated maximum
Maximum measured above high end	100 mW input power	171.1 V / m
Maximum measured above low end	100 mW input power	166.3 V / m
Averaged maximum above arm	100 mW input power	168.7 V / m \pm 12.8 % (k=2)

Appendix**Antenna Parameters**

Frequency	Return Loss	Impedance
800 MHz	14.9 dB	42.6 Ω - 15.1 j Ω
835 MHz	29.2 dB	49.6 Ω + 3.4 j Ω
900 MHz	16.7 dB	54.1 Ω - 14.9 j Ω
950 MHz	18.3 dB	43.9 Ω + 9.7 j Ω
960 MHz	14.7 dB	51.4 Ω + 19.0 j Ω

3.2 Antenna Design and Handling

The calibration dipole has a symmetric geometry with a built-in two stub matching network, which leads to the enhanced bandwidth.

The dipole is built of standard semirigid coaxial cable. The internal matching line is open ended. The antenna is therefore open for DC signals.

Do not apply force to dipole arms, as they are liable to bend. The soldered connections near the feedpoint may be damaged. After excessive mechanical stress or overheating, check the impedance characteristics to ensure that the internal matching network is not affected.

After long term use with 40W radiated power, only a slight warming of the dipole near the feedpoint can be measured.

Impedance Measurement Plot

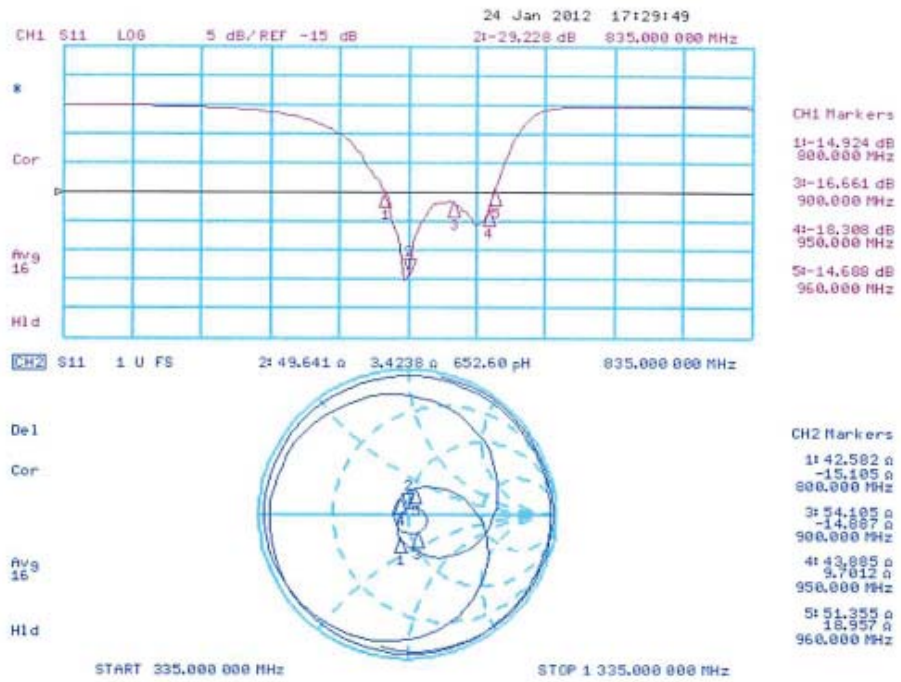

DASY5 H-field Result

Date: 24.01.2012

Test Laboratory: SPEAG Lab2

DUT: HAC-Dipole 835 MHz; Type: CD835V3; Serial: CD835V3 - SN: 1012

Communication System: CW; Frequency: 835 MHz
 Medium parameters used: $\sigma = 0$ mho/m, $\epsilon_r = 1$; $\rho = 1$ kg/m³
 Phantom section: RF Section
 Measurement Standard: DASY5 (IEEE/IEC/ANSI C63.19-2007)

DASY52 Configuration:

- Probe: H3DV6 - SN6065; ; Calibrated: 29.12.2011
- Sensor-Surface: (Fix Surface)
- Electronics: DAE4 Sn781; Calibrated: 20.04.2011
- Phantom: HAC Test Arch with AMCC; Type: SD HAC P01 BA; Serial: 1070
- DASY52 52.8.0(692); SEMCAD X 14.6.4(4989)

Dipole H-Field measurement @ 835MHz/H-Scan - 835MHz d=10mm/Hearing Aid Compatibility Test (41x361x1): Measurement grid: dx=5mm, dy=5mm

Device Reference Point: 0, 0, -6.3 mm
 Reference Value = 0.50 V/m; Power Drift = 0.00 dB
 PMR not calibrated. PMF = 1.000 is applied.
 H-field emissions = 0.47 A/m
 Near-field category: **M4 (AWF 0 dB)**

PMF scaled H-field

Grid 1 M4 0.39 A/m	Grid 2 M4 0.41 A/m	Grid 3 M4 0.39 A/m
Grid 4 M4 0.44 A/m	Grid 5 M4 0.47 A/m	Grid 6 M4 0.45 A/m
Grid 7 M4 0.39 A/m	Grid 8 M4 0.42 A/m	Grid 9 M4 0.40 A/m

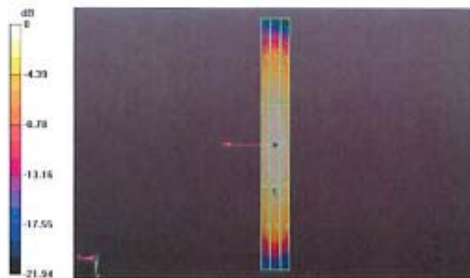

0 dB = 0.470A/m = -6.56 dB A/m

DASY5 E-field Result

Date: 24.01.2012

Test Laboratory: SPEAG Lab2

DUT: HAC-Dipole 835 MHz; Type: CD835V3; Serial: CD835V3 - SN: 1012

Communication System: CW; Frequency: 835 MHz
 Medium parameters used: $\sigma = 0$ mho/m, $\epsilon_r = 1$; $\rho = 1000$ kg/m³
 Phantom section: RF Section
 Measurement Standard: DASY5 (IEEE/IEC/ANSI C63.19-2007)

DASY52 Configuration:

- Probe: ER3DV6 - SN2336; ConvF(1, 1, 1); Calibrated: 29.12.2011
- Sensor-Surface: (Fix Surface)
- Electronics: DAE4 Sn781; Calibrated: 20.04.2011
- Phantom: HAC Test Arch with AMCC; Type: SD HAC P01 BA; Serial: 1070
- DASY52 52.8.0(692); SEMCAD X 14.6.4(4989)

Dipole E-Field measurement @ 835MHz/E-Scan - 835MHz d=10mm/Hearing Aid Compatibility Test (41x361x1): Measurement grid: dx=5mm, dy=5mm

Device Reference Point: 0, 0, -6.3 mm
 Reference Value = 111.2 V/m; Power Drift = -0.02 dB
 PMR not calibrated. PMF = 1.000 is applied.
 E-field emissions = 171.1 V/m
Near-field category: M4 (AWF 0 dB)

PMF scaled E-field

Grid 1 M4 162.5 V/m	Grid 2 M4 166.3 V/m	Grid 3 M4 159.6 V/m
Grid 4 M4 89.66 V/m	Grid 5 M4 91.57 V/m	Grid 6 M4 88.54 V/m
Grid 7 M4 164.5 V/m	Grid 8 M4 171.1 V/m	Grid 9 M4 166.8 V/m

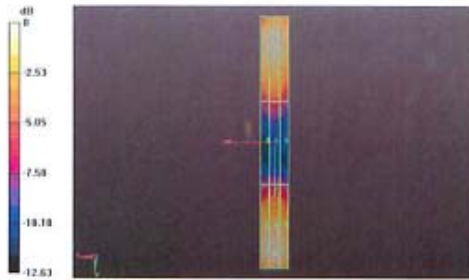

0 dB = 171.1V/m = 44.67 dB V/m

**Calibration Laboratory of
Schmid & Partner
Engineering AG**
Zeughausstrasse 43, 8004 Zurich, Switzerland



S Schweizerischer Kalibrierdienst
S Service suisse d'étalonnage
S Servizio svizzero di taratura
S Swiss Calibration Service

Accredited by the Swiss Accreditation Service (SAS)
The Swiss Accreditation Service is one of the signatories to the EA
Multilateral Agreement for the recognition of calibration certificates

Accreditation No.: **SCS 108**

Client **BACL**

Certificate No: **CD1880V3-1009_Jan12**

CALIBRATION CERTIFICATE

Object **CD1880V3 - SN: 1009**

Calibration procedure(s) **QA CAL-20.v6
Calibration procedure for dipoles in air**

Calibration date: **January 24, 2012**

This calibration certificate documents the traceability to national standards, which realize the physical units of measurements (SI).
The measurements and the uncertainties with confidence probability are given on the following pages and are part of the certificate.

All calibrations have been conducted in the closed laboratory facility: environment temperature (22 ± 3)°C and humidity < 70%.

Calibration Equipment used (M&TE critical for calibration)

Primary Standards	ID #	Cal Date (Certificate No.)	Scheduled Calibration
Power meter EPM-442A	GB37480704	05-Oct-11 (No. 217-01451)	Oct-12
Power sensor HP 8481A	US37292783	05-Oct-11 (No. 217-01451)	Oct-12
Probe ER3DV6	SN: 2336	29-Dec-11 (No. ER3-2336_Dec11)	Dec-12
Probe H3DV6	SN: 6065	29-Dec-11 (No. H3-6065_Dec11)	Dec-12
DAE4	SN: 781	20-Apr-11 (No. DAE4-781_Apr11)	Apr-12

Secondary Standards	ID #	Check Date (in house)	Scheduled Check
Power meter Agilent 4419B	SN: GB42420191	09-Oct-09 (in house check Oct-11)	in house check: Oct-12
Power sensor HP 8482H	SN: 3318A09450	09-Oct-09 (in house check Oct-11)	in house check: Oct-12
Power sensor HP 8482A	SN: US37295597	09-Oct-09 (in house check Oct-11)	in house check: Oct-12
Network Analyzer HP 8753E	US37390585	18-Oct-01 (in house check Oct-11)	in house check: Oct-12
RF generator E4433B	MY 41000675	03-Nov-04 (in house check Oct-11)	in house check: Oct-13

	Name	Function	Signature
Calibrated by:	Dimce Iliev	Laboratory Technician	<i>D. Iliev</i>
Approved by:	Fin Bomholt	R&D Director	<i>F. Bomholt</i>

Issued: January 25, 2012

This calibration certificate shall not be reproduced except in full without written approval of the laboratory.

**Calibration Laboratory of
Schmid & Partner
Engineering AG**
Zeughausstrasse 43, 8004 Zurich, Switzerland



S Schweizerischer Kalibrierdienst
C Service suisse d'étalonnage
S Servizio svizzero di taratura
S Swiss Calibration Service

Accredited by the Swiss Accreditation Service (SAS)
The Swiss Accreditation Service is one of the signatories to the EA
Multilateral Agreement for the recognition of calibration certificates

Accreditation No.: **SCS 108**

References

- [1] ANSI-C63.19-2007
American National Standard for Methods of Measurement of Compatibility between Wireless Communications Devices and Hearing Aids.

Methods Applied and Interpretation of Parameters:

- **Coordinate System:** y-axis is in the direction of the dipole arms. z-axis is from the basis of the antenna (mounted on the table) towards its feed point between the two dipole arms. x-axis is normal to the other axes. In coincidence with the standards [1], the measurement planes (probe sensor center) are selected to be at a distance of 10 mm above the top edge of the dipole arms.
- **Measurement Conditions:** Further details are available from the hardcopies at the end of the certificate. All figures stated in the certificate are valid at the frequency indicated. The forward power to the dipole connector is set with a calibrated power meter connected and monitored with an auxiliary power meter connected to a directional coupler. While the dipole under test is connected, the forward power is adjusted to the same level.
- **Antenna Positioning:** The dipole is mounted on a HAC Test Arch phantom using the matching dipole positioner with the arms horizontal and the feeding cable coming from the floor. The measurements are performed in a shielded room with absorbers around the setup to reduce the reflections. It is verified before the mounting of the dipole under the Test Arch phantom, that its arms are perfectly in a line. It is installed on the HAC dipole positioner with its arms parallel below the dielectric reference wire and able to move elastically in vertical direction without changing its relative position to the top center of the Test Arch phantom. The vertical distance to the probe is adjusted after dipole mounting with a DASY5 Surface Check job. Before the measurement, the distance between phantom surface and probe tip is verified. The proper measurement distance is selected by choosing the matching section of the HAC Test Arch phantom with the proper device reference point (upper surface of the dipole) and the matching grid reference point (tip of the probe) considering the probe sensor offset. The vertical distance to the probe is essential for the accuracy.
- **Feed Point Impedance and Return Loss:** These parameters are measured using a HP 8753E Vector Network Analyzer. The impedance is specified at the SMA connector of the dipole. The influence of reflections was eliminated by applying the averaging function while moving the dipole in the air, at least 70cm away from any obstacles.
- **E-field distribution:** E field is measured in the x-y-plane with an isotropic ER3D-field probe with 100 mW forward power to the antenna feed point. In accordance with [1], the scan area is 20mm wide, its length exceeds the dipole arm length (180 or 90mm). The sensor center is 10 mm (in z) above the top of the dipole arms. Two 3D maxima are available near the end of the dipole arms. Assuming the dipole arms are perfectly in one line, the average of these two maxima (in subgrid 2 and subgrid 8) is determined to compensate for any non-parallelity to the measurement plane as well as the sensor displacement. The E-field value stated as calibration value represents the maximum of the interpolated 3D-E-field, 10mm above the dipole surface.
- **H-field distribution:** H-field is measured with an isotropic H-field probe with 100mW forward power to the antenna feed point, in the x-y-plane. The scan area and sensor distance is equivalent to the E-field scan. The maximum of the field is available at the center (subgrid 5) above the feed point. The H-field value stated as calibration value represents the maximum of the interpolated H-field, 10mm above the dipole surface at the feed point.

Measurement Conditions

DASY system configuration, as far as not given on page 1.

DASY Version	DASY5	V52.8.0
Extrapolation	Advanced Extrapolation	
Phantom	HAC Test Arch	
Distance Dipole Top - Probe Center	10mm	
Scan resolution	dx, dy = 5 mm	
Frequency	1880MHz \pm 1 MHz	
Input power drift	< 0.05 dB	

Maximum Field values

H-field 10 mm above dipole surface	condition	interpolated maximum
Maximum measured	100 mW input power	0.472 A / m \pm 8.2 % (k=2)

E-field 10 mm above dipole surface	condition	interpolated maximum
Maximum measured above high end	100 mW input power	140.4 V / m
Maximum measured above low end	100 mW input power	138.1 V / m
Averaged maximum above arm	100 mW input power	139.3 V / m \pm 12.8 % (k=2)

Appendix**Antenna Parameters**

Frequency	Return Loss	Impedance
1730 MHz	28.2 dB	51.6 Ω + 3.6 j Ω
1880 MHz	21.2 dB	51.5 Ω + 8.7 j Ω
1900 MHz	21.8 dB	54.0 Ω + 7.4 j Ω
1950 MHz	26.9 dB	54.4 Ω + 1.7 j Ω
2000 MHz	22.9 dB	44.3 Ω + 3.7 j Ω

3.2 Antenna Design and Handling

The calibration dipole has a symmetric geometry with a built-in two stub matching network, which leads to the enhanced bandwidth.

The dipole is built of standard semirigid coaxial cable. The internal matching line is open ended. The antenna is therefore open for DC signals.

Do not apply force to dipole arms, as they are liable to bend. The soldered connections near the feedpoint may be damaged. After excessive mechanical stress or overheating, check the impedance characteristics to ensure that the internal matching network is not affected.

After long term use with 40W radiated power, only a slight warming of the dipole near the feedpoint can be measured.

Impedance Measurement Plot

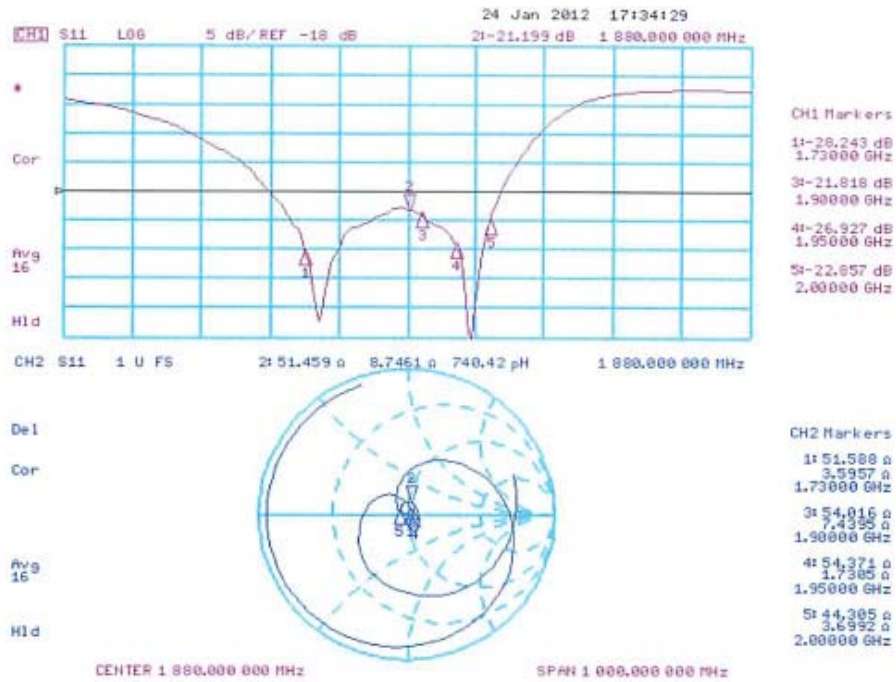

DASY5 H-field Result

Date: 24.01.2012

Test Laboratory: SPEAG Lab2

DUT: HAC Dipole 1880 MHz; Type: CD1880V3; Serial: CD1880V3 - SN: 1009

Communication System: CW; Frequency: 1880 MHz
Medium parameters used: $\sigma = 0$ mho/m, $\epsilon_r = 1$; $\rho = 1$ kg/m³
Phantom section: RF Section
Measurement Standard: DASY5 (IEEE/IEC/ANSI C63.19-2007)

DASY52 Configuration:

- Probe: H3DV6 - SN6065; ; Calibrated: 29.12.2011
- Sensor-Surface: (Fix Surface)
- Electronics: DAE4 Sn781; Calibrated: 20.04.2011
- Phantom: HAC Test Arch with AMCC; Type: SD HAC P01 BA; Serial: 1070
- DASY52 52.8.0(692); SEMCAD X 14.6.4(4989)

Dipole H-Field measurement @ 1880MHz/H-Scan - 1880MHz d=10mm/Hearing Aid Compatibility Test (41x181x1): Measurement grid: dx=5mm, dy=5mm

Device Reference Point: 0, 0, -6.3 mm
Reference Value = 0.50 V/m; Power Drift = -0.01 dB
PMR not calibrated. PMF = 1.000 is applied.
H-field emissions = 0.47 A/m
Near-field category: **M2 (AWF 0 dB)**

PMF scaled H-field

Grid 1 M2 0.41 A/m	Grid 2 M2 0.43 A/m	Grid 3 M2 0.41 A/m
Grid 4 M2 0.45 A/m	Grid 5 M2 0.47 A/m	Grid 6 M2 0.45 A/m
Grid 7 M2 0.41 A/m	Grid 8 M2 0.43 A/m	Grid 9 M2 0.42 A/m

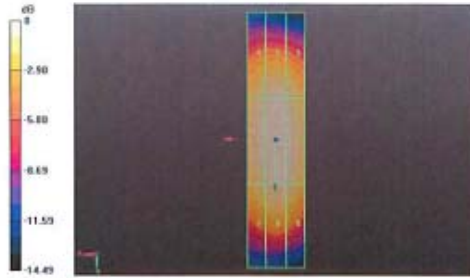

0 dB = 0.470A/m = -6.56 dB A/m

DASY5 E-field Result

Date: 24.01.2012

Test Laboratory: SPEAG Lab2

DUT: HAC Dipole 1880 MHz; Type: CD1880V3; Serial: CD1880V3 - SN: 1009

Communication System: CW; Frequency: 1880 MHz
 Medium parameters used: $\sigma = 0$ mho/m, $\epsilon_r = 1$; $\rho = 1000$ kg/m³
 Phantom section: RF Section
 Measurement Standard: DASY5 (IEEE/IEC/ANSI C63.19-2007)

DASY52 Configuration:

- Probe: ER3DV6 - SN2336; ConvF(1, 1, 1); Calibrated: 29.12.2011
- Sensor-Surface: (Fix Surface)
- Electronics: DAE4 Sn781; Calibrated: 20.04.2011
- Phantom: HAC Test Arch with AMCC; Type: SD HAC P01 BA; Serial: 1070
- DASY52 52.8.0(692); SEMCAD X 14.6.4(4989)

Dipole E-Field measurement @ 1880MHz/E-Scan - 1880MHz d=10mm/Hearing Aid Compatibility Test (41x181x1): Measurement grid: dx=5mm, dy=5mm

Device Reference Point: 0, 0, -6.3 mm
 Reference Value = 157.7 V/m; Power Drift = -0.00 dB
 PMR not calibrated. PMF = 1.000 is applied.
 E-field emissions = 140.4 V/m
Near-field category: M2 (AWF 0 dB)

PMF scaled E-field

Grid 1 M2 134.0 V/m	Grid 2 M2 138.1 V/m	Grid 3 M2 133.9 V/m
Grid 4 M3 90.05 V/m	Grid 5 M3 92.10 V/m	Grid 6 M3 88.07 V/m
Grid 7 M2 132.5 V/m	Grid 8 M2 140.4 V/m	Grid 9 M2 137.9 V/m

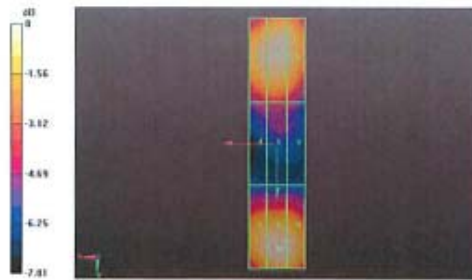

0 dB = 140.4V/m = 42.95 dB V/m

12 APPENDIX D – OUTPUT POWER MEASUREMENT

12.1 Test Block Diagram and Procedure

The RF output of the transmitter was connected to the input of the spectrum analyzer through sufficient attenuation.

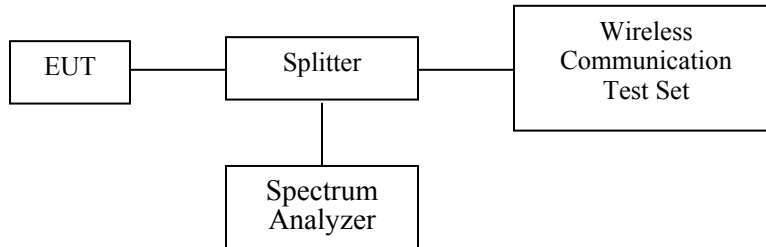

12.2 Test Equipment List and Details

Manufacturer	Description	Model No.	Serial No.	Calibration Due Date
Rohde & Schwarz	Analyzer Communication	CMU200	103492	2014-06-22
Agilent	Spectrum Analyzer	E4440A	US45303156	2014-08-09

12.3 Test Results

Band	Frequency (MHz)	GSM Conducted Output Power (dBm)
GSM850	824.2	32.48
	836.6	32.45
	848.8	32.40
PCS1900	1850.2	29.25
	1880.0	29.30
	1909.8	29.33

13 APPENDIX F – TEST SETUP PHOTOS

13.1 E-Field Setup View

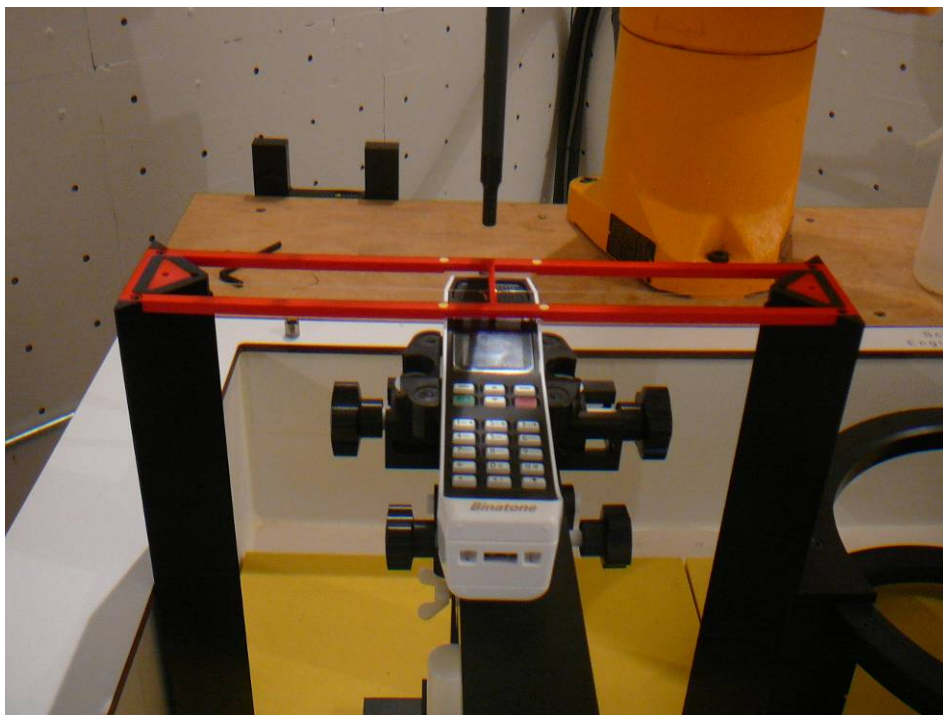

13.2 H-Field Setup View

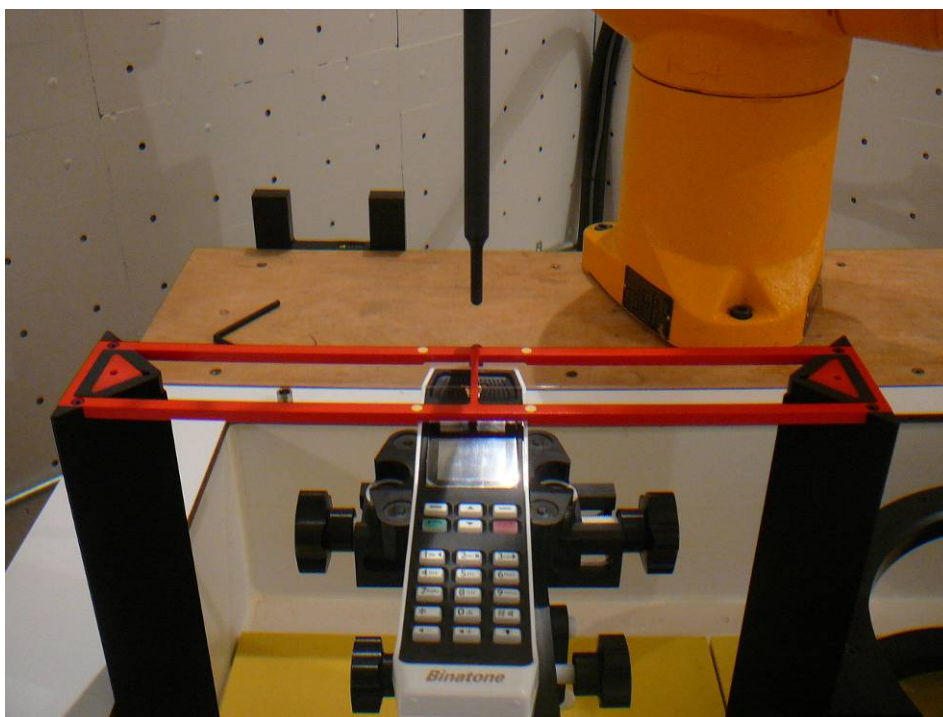

14 APPENDIX G – EUT PHOTOGRAPHS

14.1 EUT – Front View



14.2 EUT – Bottom View



14.3 EUT – Battery Compartment View

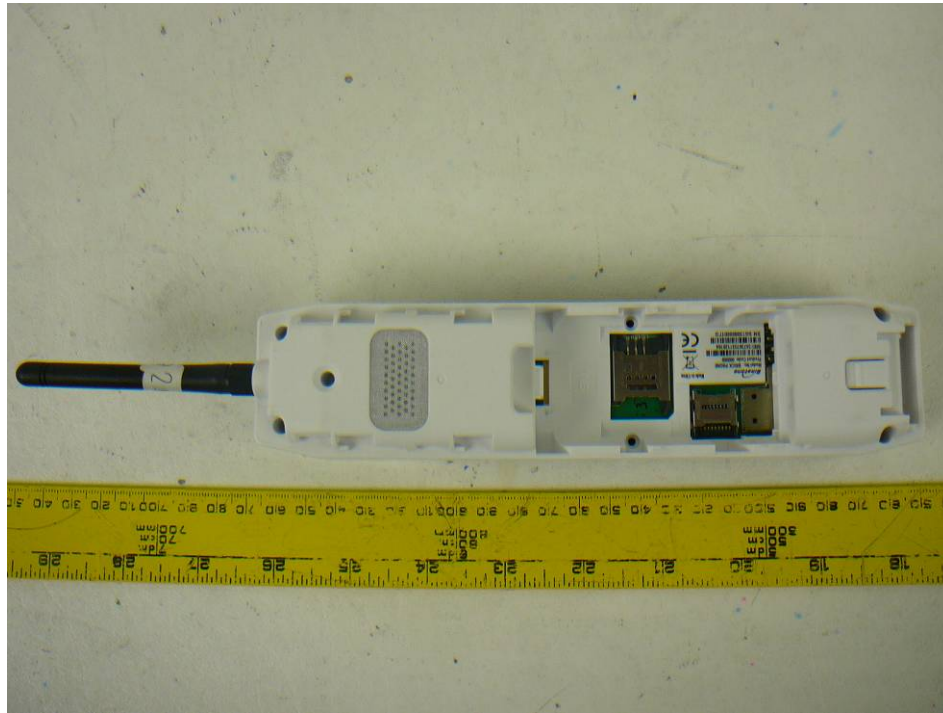

15 APPENDIX H - REFERENCES

- [1] ANSI C63.19:2007. American National Standard, Methods of Measurement of Compatibility between Wireless Communications Devices and Hearing Aids
- [2] CFR47, Part20.19, Federal Communications Commission (FCC), Hearing Aid-Compatible Mobile Handsets
- [3] FCC 08-68 A1, A2, A3, A4, A5, WT Docket 07-250, February 28, 2008.
- [4] FCC OET KDB 285076, Equipment Authorization Guidance for Hearing Aid Compability.

--- END OF REPORT ---