

FCC & IC TEST REPORT

Applicant: Binatone Electronics International Limited

Address of Applicant: Floor 23A, 9 Des Voeux Road West, Sheung Wan, Hong Kong

Equipment Under Test (EUT)

Product Name: DECT Phone

Model No.: Smart 63, KS7106

FCC ID: VLJ-SMART63

Canada IC: 4522A-SMART63

Applicable standards: FCC CFR Title 47 Part 15 Subpart D,
RSS - 213, Issue 2, RSS-Gen Issue 4

Date of sample receipt: 14 Oct., 2014

Date of Test: 14 Oct., 2014 to 30 Dec., 2014

Date of report issued: 30 Dec., 2014

Test Result: PASS*

* In the configuration tested, the EUT complied with the standards specified above.

Authorized Signature:



Bruce Zhang
Laboratory Manager

This report details the results of the testing carried out on one sample. The results contained in this test report do not relate to other samples of the same product and does not permit the use of the CCIS product certification mark. The manufacturer should ensure that all products in series production are in conformity with the product sample detailed in this report.

This report may only be reproduced and distributed in full. If the product in this report is used in any configuration other than that detailed in the report, the manufacturer must ensure the new system complies with all relevant standards.

This document cannot be reproduced except in full, without prior written approval of the Company. Any unauthorized alteration, forgery or falsification of the content or appearance of this document is unlawful and offenders may be prosecuted to the fullest extent of the law. Unless otherwise stated the results shown in this test report refer only to the sample(s) tested and such sample(s) are retained for 90 days only.

2 Version

Version No.	Date	Description
00	30 Dec., 2014	Original

Tested By:

Atomb Yang

Date:

30 Dec., 2014

Test Engineer

Reviewed By:

Wimer Zhang

Date:

30 Dec., 2014

Project Engineer

3 Contents

	Page
1 COVER PAGE	1
2 VERSION	2
3 CONTENTS.....	3
4 TEST SUMMARY	5
5 GENERAL INFORMATION	6
5.1 CLIENT INFORMATION.....	6
5.2 GENERAL DESCRIPTION OF E.U.T.....	6
5.3 RELATED SUBMITTAL(S) / GRANT (S).....	7
5.4 TEST METHODOLOGY.....	7
5.5 LABORATORY FACILITY.....	7
5.6 LABORATORY LOCATION	7
5.7 TEST INSTRUMENTS LIST.....	8
6 TEST CONFIGURATION AND CONDITIONS.....	9
6.1 EUT CONFIGURATION.....	9
6.2 CONFIGURATION OF TESTED SYSTEM.....	9
6.3 TEST ENVIRONMENTS	10
6.4 DESCRIPTION OF TEST MODES	10
6.5 TEST UNCERTAINTY	10
7 TEST RESULTS AND MEASUREMENT DATA.....	11
7.1 ANTENNA REQUIREMENT	11
7.1.1 Standard Applicable	11
7.1.2 Requirement.....	11
7.1.3 Description of Antenna Construction	11
7.1.4 Result	11
7.2 AC POWER LINE CONDUCTED EMISSION.....	12
7.2.1 Standard Applicable	12
7.2.2 Test Procedure	12
7.2.3 Limits.....	12
7.2.4 Results	12
7.2.5 Measurement Data.....	12
7.3 EMISSION BANDWIDTH	15
7.3.1 Standard Applicable	15
7.3.2 Test Procedure	15
7.3.3 Limits.....	15
7.3.4 Results	15
7.3.5 Measurement Data.....	15
7.4 PEAK TRANSMIT POWER	18
7.4.1 Standard Applicable	18
7.4.2 Test Procedure	18
7.4.3 Limits.....	18
7.4.4 Results	18
7.4.5 Measurement Data.....	18
7.5 POWER SPECTRAL DENSITY	20
7.5.1 Standard Applicable	20
7.5.2 Test Procedure	20
7.5.3 Limits.....	20
7.5.4 Results	20
7.5.5 Measurement Data.....	20
7.6 IN-BAND AND OUT-OF-BAND EMISSIONS	22
7.6.1 Standard Applicable	22
7.6.2 Test Procedure	22
7.6.3 Limits.....	22
7.6.4 Test Result	22

7.6.5	Measurement Data.....	22
7.7	CARRIER FREQUENCY STABILITY.....	27
7.7.1	Standard Applicable.....	27
7.7.2	Test Procedure.....	27
7.7.3	Limits.....	27
7.7.4	Test Result.....	27
7.7.5	Measurement Data.....	27
7.8	FRAME REPETITION STABILITY, PERIOD AND JITTER.....	28
7.8.1	Standard Applicable.....	28
7.8.2	Test Procedure.....	28
7.8.3	Limits.....	28
7.8.4	Test Result.....	28
7.8.5	Measurement Data.....	28
7.9	AUTOMATICALLY DISCONTINUE TRANSMISSION.....	29
7.9.1	Standard Applicable.....	29
7.9.2	Requirements.....	29
7.9.3	Results.....	29
7.9.4	Measurement Data.....	29
7.10	SPECIFIC REQUIREMENTS FOR DEVICES OPERATING IN THE 1920-1930MHZ SUB-BAND.....	30
7.10.1	Monitoring time.....	30
7.10.2	Monitoring Threshold, Lease Interfered Channel.....	31
7.10.3	Monitoring Threshold Bandwidth.....	32
7.10.4	Reaction Time and Monitoring Interval.....	33
7.10.5	Time and Spectrum Window Access Procedure.....	34
7.10.6	Acknowledgements and Transmission Duration.....	35
7.10.7	Dual Access Criteria Check.....	36
7.10.8	Alternative Monitoring Interval.....	36
7.10.9	Fair Access.....	36
8	TEST SETUP PHOTO.....	37
9	EUT CONSTRUCTIONAL DETAILS.....	39

4 Test Summary

Test Item	FCC Section	IC Section	Result
Antenna requirement	§ 15.317, § 15.203	RSS Gen, 7.1.2	PASS
AC power line conducted emission	§ 15.315, § 15.207(a)	RSS 213, 6.3	PASS
Emission bandwidth	§ 15.323(a)	RSS 213, 6.4	PASS
Peak transmit power	§ 15.319(c)&(e)	RSS 213, 6.5&4.1(e)	PASS
Power spectral density	§ 15.319(d)	RSS 213, 6.6	PASS
In-band and out-of-band emission	§ 15.323(d)	RSS 213, 6.7.1&6.7.2	PASS
Carrier frequency stability	§ 15.323(f)	RSS 213, 6.2	PASS
Frame repetition stability, period and jitter	§ 15.323(e)	RSS 213, 4.3.4(c)	PASS
Automatically discontinue transmission	§ 15.319(f)	RSS 213, 4.3.4(a)	PASS
Radiated spurious emission	§ 15.319(g), § 15.209(a)	RSS 213, 4.3.3 RSS Gen, 7.2.3	N/A*
Specific requirements for devices Operating in the 1920–1930MHz sub- band.	§ 15.323(c)	RSS 213, 4.3.4(b)	PASS

Remark:

N/A*: Not required if Conducted Out-of-Band Emissions test is passed.

5 General Information

5.1 Client Information

Applicant:	Binatone Electronics International Limited
Address of Applicant:	Floor 23A, 9 Des Voeux Road West, Sheung Wan, Hong Kong
Manufacturer:	ShenZhen Concox Information Technology Co., Ltd
Address of Manufacturer:	4F, Building B, Gaoxinqi Industrial Park, Liuxian 1st Road, District 67,Bao'an, Shenzhen, Guangdong, China
Factory:	Huizhou Goldenchip Electronics Co., Ltd
Address of Factory:	No. 12 Factory, Songyang Road, Zhongkai Hi-tech Development Zone, Huizhou City, Guangdong Province, China

5.2 General Description of E.U.T.

Product Name:	DECT Phone
Model No.:	Smart 63, KS7106
Power supply:	Rechargeable Li-ion Battery DC3.7V-1100mAh
Adapter:	Model:MLF-A00060501000U0021 Input:100-240VAC,50/60Hz 0.18A Output:5.0VDC MAX1A
Hardware Version:	VER04
Software Version:	DE3200A916
Technical Parameter:	
Frequency Range:	1921.536 MHz~1928.448 MHz
Number of channels:	5
Maximum Output Power:	95.72mW(Peak)
Modulation:	GFSK
Antenna Type:	Internal
Antenna Gain:	0 dBi
Remark:	The Model: Smart 63, KS7106 were identical inside, the electrical circuit design, layout, components used and internal wiring,with only difference being model name.

Channel List

UPCS Channel	Frequency(MHz)
Upper Band Edge	1930
0(Highest)	1928.448
1	1926.720
2(Middle)	1924.992
3	1923.264
4(Lowest)	1921.536
Lower Band Edge	1920

5.3 Related Submittal(s) / Grant (s)

The EUT is a portable device and is designed to be held to ear or worn in a belt clip when used. A test reports with the measured SAR values for both configurations are submitted with the application.

5.4 Test Methodology

ANSI C63.4: 2003	Methods of Measurement of Radio-Noise Emissions from Low Voltage Electrical and Electronic Equipment in the Range of 9 kHz to 40 GHz
ANSI 63.17: 2013	American National Standard Methods of Measurement of the Electromagnetic and Operational Compatibility of Unlicensed Personal Communications Services (UPCS) Devices

5.5 Laboratory Facility

The test facility is recognized, certified, or accredited by the following organizations:

- **FCC - Registration No.: 817957**
Shenzhen Zhongjian Nanfang Testing Co., Ltd. EMC Laboratory has been registered and fully described in a report filed with the (FCC) Federal Communications Commission. The acceptance letter from the FCC is maintained in out files. Registration 817957, February 27, 2012.
- **IC - Registration No.: 10106A-1**
The 3m Semi-anechoic chamber of Shenzhen Zhongjian Nanfang Testing Co., Ltd. has been Registered by Certification and Engineering Bureau of Industry Canada for radio equipment testing with Registration No.: 10106A-1.
- **CNAS - Registration No.: CNAS L6048**
Shenzhen Zhongjian Nanfang Testing Co., Ltd. is accredited to ISO/IEC 17025 :2005 General Requirements for the Competence of Testing and Calibration laboratories for the competence of testing. The Registration No. is CNAS L6048.

5.6 Laboratory Location

Shenzhen Zhongjian Nanfang Testing Co., Ltd.
 Address: No. B-C, 1/F., Building 2, Laodong No.2 Industrial Park, Xixiang Road,
 Bao'an District, Shenzhen, Guangdong, China
 Tel: +86-755-23118282
 Fax: +86-755-23116366

5.7 Test Instruments list

Item	Test Equipment	Manufacturer	Model No.	Inventory No.	Cal. Date (mm-dd-yy)	Cal. Due date (mm-dd-yy)
1	Loop antenna (9kHz-30MHz)	Laplace instrument	RF300	EMC0701	Aug. 01 2014	Mar. 31 2015
2	BiConiLog Antenna (30MHz-1GHz)	SCHWARZBECK MESS-ELEKTRONIK	VULB9163	CCIS0005	Apr. 19 2014	Apr. 19 2015
3	Horn Antenna (1-18GHz)	SCHWARZBECK MESS-ELEKTRONIK	BBHA9120D	CCIS0006	Apr. 19 2014	Apr. 19 2015
4	Horn Antenna (18-26.5GHz)	ETS-LINDGREN	3160	GTS217	Mar. 30 2014	Mar. 29 2015
5	Pre-amplifier (10kHz-1.3GHz)	HP	8447D	CCIS0003	Apr. 01 2014	Mar. 31 2015
6	Pre-amplifier (1GHz-18GHz)	Compliance Direction Systems Inc.	PAP-1G18	CCIS0011	June 09 2014	June 08 2015
7	Pre-amplifier (18-26GHz)	Rohde & Schwarz	AFS33-18002 650-30-8P-44	GTS218	Apr. 01 2014	Mar. 31 2015
8	Signal Analyzer (10Hz-3.5GHz)	Rohde & Schwarz	FSIQ3	CCIS0088	Apr. 19 2014	Apr. 19 2015
9	EMI Test Receiver (9kHz-3GHz)	Rohde & Schwarz	ESCI	CCIS0002	Apr. 10 2014	Apr. 10 2015
10	Spectrum Analyzer (9kHz-30GHz)	Rohde & Schwarz	FSP30	CCIS0023	Apr. 19 2014	Apr. 19 2015
11	Power Meter	Agilent	E4418B	GB42421076	Apr. 15 2014	Apr. 14 2015
12	Power Sensor	HP	8481A	US37293152	Apr. 15 2014	Apr. 14 2015
13	Signal Generator	Aero flex	IFR3413	341006/286	Apr. 15 2014	Apr. 14 2015
14	Signal Generator	Aero flex	IFR2026Q	112282/081	May. 10 2014	May. 09 2015
15	Vector Signal Generator	Agilent	E4438C	MY45093111	May. 10 2014	May. 09 2015
16	Digital Radio communication Tester	Rohde & Schwarz	CMD60	CCIS0149	Apr 01 2014	Mar. 31 2015

6 TEST CONFIGURATION AND CONDITIONS

6.1 EUT Configuration

The EUT is DECT portable part (PP), and is designed to operate together with a DECT fixed part (FP). In order to meet the testing requirements, the EUT was set to the test mode (TBR6 mode).

6.2 Configuration of Tested System

(A) RF Output Power, Power spectral density, Occupied Bandwidth, Conducted spurious emissions etc. conducted method items test setup

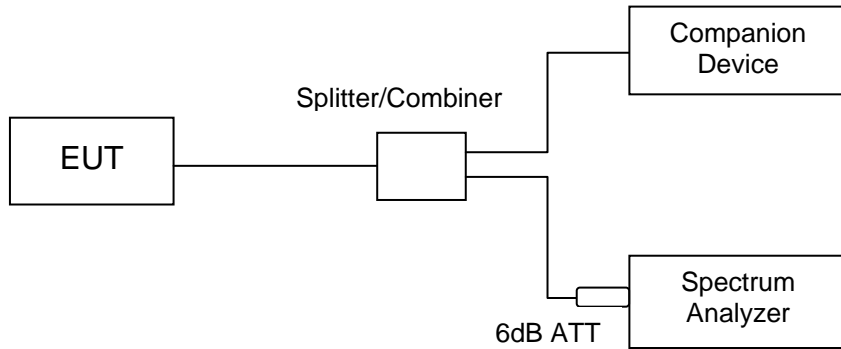

(B) Radiated emission test setup, Frequency below 1000MHz

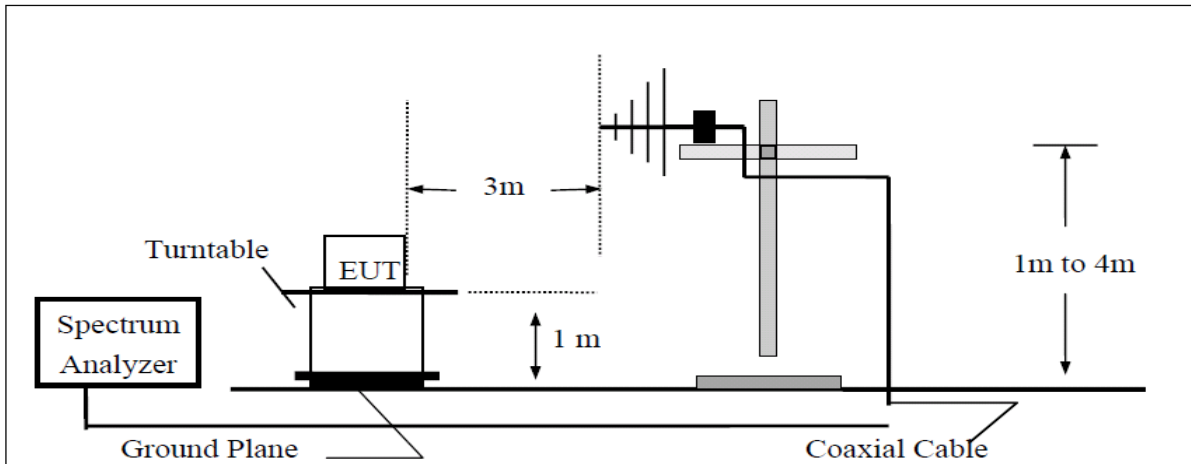

(C) Radiated Emission test setup Frequency over 1 GHz

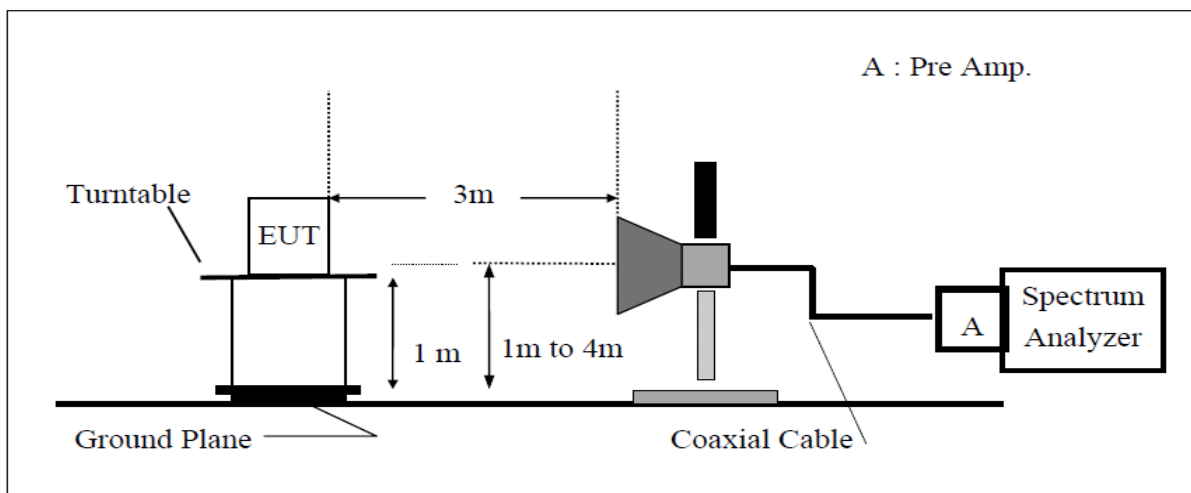

(D) AC Power line conducted emissions test setup

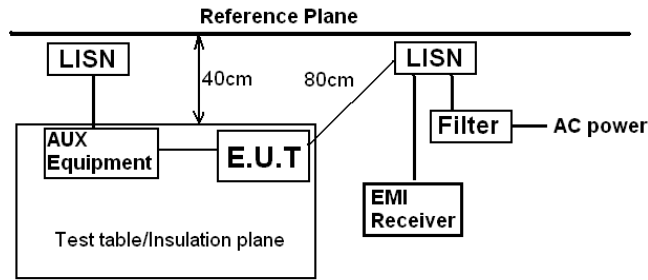

Remark
 E.U.T: Equipment Under Test
 LISN: Line Impedance Stabilization Network
 Test table height=0.8m

(E) Monitor test setup

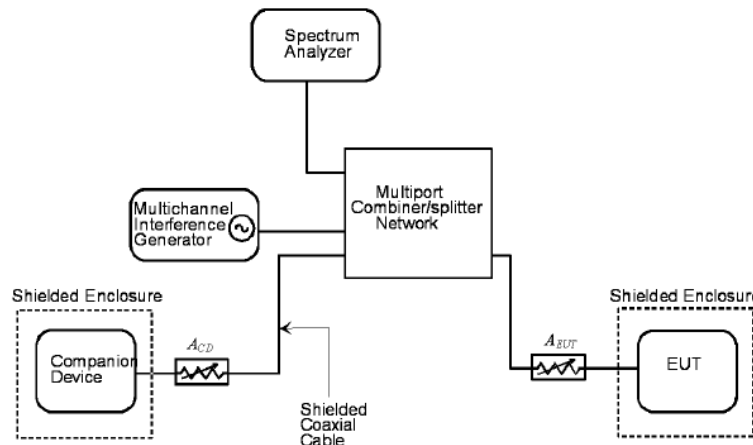

6.3 Test Environments

Condition	Minimum value	Maximum value
Barometric pressure	86 kPa	106 kPa
Temperature	15°C	30°C
Relative Humidity	25 %	75 %
Power supply range	±5% of rated voltages	
Normal Test Condition	1. Temperature: +15 °C to +30 °C; 2. Voltage is DC 3.7V	
Extreme Test Conditions	3. Temperatures: -20°C to +55°C. 4. Voltages: DC 3.145V to DC4.255V.	

6.4 Description of test modes

Test mode	Detail description of the test mode
TX mode	Keep the EUT in continuously transmitting mode

6.5 Test uncertainty

Test items	Uncertainty
AC power line conducted emission	±3.28 dB
Conducted method items	±0.96dB
Radiated method items	±4.88 dB

7 Test results and Measurement Data

7.1 Antenna Requirement

7.1.1 Standard Applicable

According to FCC part 15.203 and RSS-GEN section 7.1.2.

7.1.2 Requirement

According to FCC § 15.203, an intentional radiator shall be designed to ensure that no antenna other than that furnished by the responsible party shall be used with the device. The use of a permanently attached antenna or of an antenna that uses a unique coupling to the intentional radiator shall be considered sufficient to comply with the provisions of this Section. The manufacturer may design the unit so that a broken antenna can be replaced by the user, but the use of a standard antenna jack or electrical connector is prohibited.

7.1.3 Description of Antenna Construction

The antenna of EUT is an integral antenna which permanently attached, and the best case gain of the antenna is 0dBi. Details please refer to section 9.

7.1.4 Result

Meet the requirements.

7.2 AC Power Line Conducted Emission

7.2.1 Standard Applicable

According to FCC part 15.315, 15.207(a) and RSS-213 section 6.3

7.2.2 Test Procedure

1. The E.U.T and simulators are connected to the main power through a line impedance stabilization network (L.I.S.N.), which provides a 50ohm/50uH coupling impedance for the measuring equipment.
2. The peripheral devices are also connected to the main power through a LISN that provides a 50ohm/50uH coupling impedance with 50ohm termination. (Please refer to the block diagram of the test setup and photographs).
3. Both sides of A.C. line are checked for maximum conducted interference. In order to find the maximum emission, the relative positions of equipment and all of the interface cables must be changed according to ANSI C63.4: 2003 on conducted measurement.

7.2.3 Limits

Frequency range (MHz)	Limit (dBuV)	
	Quasi-peak	Average
0.15-0.5	66 to 56*	56 to 46*
0.5-5	56	46
5-30	60	50

7.2.4 Results

Meet the requirements

7.2.5 Measurement Data

See plots as below

Line

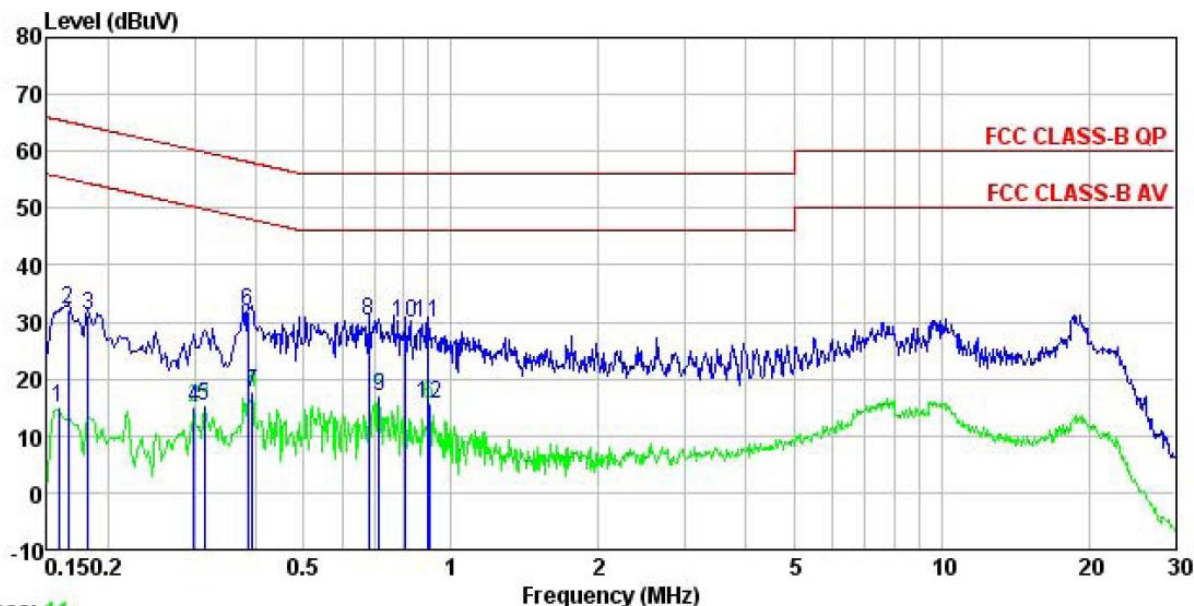

Trace: 11

Site : CCIS Shielding Room
 Condition : FCC CLASS-B QP LISN LINE
 Job. no : 848RF
 EUT : DECT Phone
 Model : Smart 63
 Test Mode : Handset Communication mode
 Power Rating : AC 120V/60Hz
 Environment : Temp: 23 °C Humi:56% Atmos:101KPa
 Test Engineer: A-bomb

	Read	LISN	Cable	Limit	Over			
Freq	Level	Factor	Loss	Line	Limit	Remark		
MHz	dBuV	dB	dB	dBuV	dBuV	dB		
1	0.158	14.52	0.27	0.00	14.79	55.56	-40.77	Average
2	0.166	31.80	0.27	0.00	32.07	65.16	-33.09	QP
3	0.182	30.82	0.28	0.00	31.10	64.42	-33.32	QP
4	0.299	14.78	0.26	0.00	15.04	50.28	-35.24	Average
5	0.313	15.08	0.26	0.00	15.34	49.88	-34.54	Average
6	0.385	31.71	0.28	0.00	31.99	58.17	-26.18	QP
7	0.393	17.26	0.28	0.00	17.54	47.99	-30.45	Average
8	0.679	29.89	0.23	0.00	30.12	56.00	-25.88	QP
9	0.712	16.54	0.22	0.00	16.76	46.00	-29.24	Average
10	0.809	29.61	0.23	0.00	29.84	56.00	-26.16	QP
11	0.894	29.58	0.24	0.00	29.82	56.00	-26.18	QP
12	0.904	15.30	0.24	0.00	15.54	46.00	-30.46	Average

Neutral

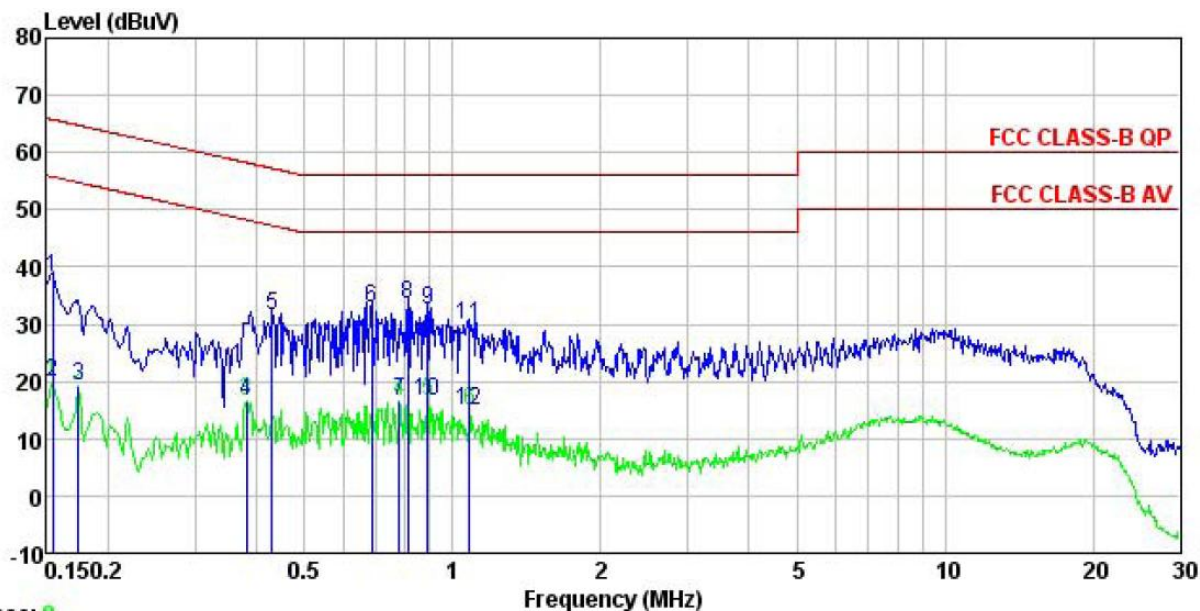

Trace: 9

Site : CCIS Shielding Room
 Condition : FCC CLASS-B QP LISN NEUTRAL
 Job. no : 848RF
 EUT : DECT Phone
 Model : Smart 63
 Test Mode : Handset Communication mode
 Power Rating : AC 120V/60Hz
 Environment : Temp: 23 °C Humi:56% Atmos:101KPa
 Test Engineer: A-bomb

	Read	LISN	Cable	Level	Limit	Over	
Freq	Level	Factor	Loss	Level	Line	Limit	Remark
MHz	dBuV	dB	dB	dBuV	dBuV	dB	
1	0.154	37.83	0.25	0.00	38.08	65.78	-27.70 QP
2	0.154	19.72	0.25	0.00	19.97	55.78	-35.81 Average
3	0.174	19.00	0.25	0.00	19.25	54.77	-35.52 Average
4	0.381	16.46	0.25	0.00	16.71	48.25	-31.54 Average
5	0.431	31.36	0.26	0.00	31.62	57.24	-25.62 QP
6	0.686	32.66	0.19	0.00	32.85	56.00	-23.15 QP
7	0.779	16.42	0.19	0.00	16.61	46.00	-29.39 Average
8	0.813	33.35	0.20	0.00	33.55	56.00	-22.45 QP
9	0.890	32.31	0.21	0.00	32.52	56.00	-23.48 QP
10	0.890	16.29	0.21	0.00	16.50	46.00	-29.50 Average
11	1.082	29.74	0.23	0.00	29.97	56.00	-26.03 QP
12	1.082	14.59	0.23	0.00	14.82	46.00	-31.18 Average

7.3 Emission Bandwidth

7.3.1 Standard Applicable

According to FCC part 15.323(a), RSS 213 section 6.4.

7.3.2 Test Procedure

According to ANSI 63.17: 2013 clause 6.1.3

7.3.3 Limits

The 26 dB and 99% Bandwidth B shall be larger than 50 kHz and less than 2.5 MHz

7.3.4 Results

Meet the requirements

7.3.5 Measurement Data

See plots as below

26 dB Emission Bandwidth Lowest channel

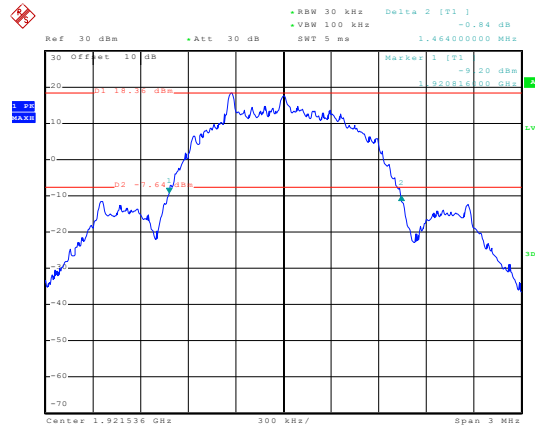

Date: 21.OCT.2014 21:11:13

Middle Channel

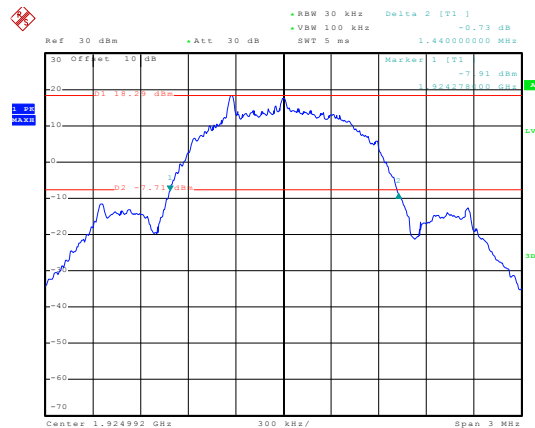

Date: 21.OCT.2014 21:51:05

Highest Channel

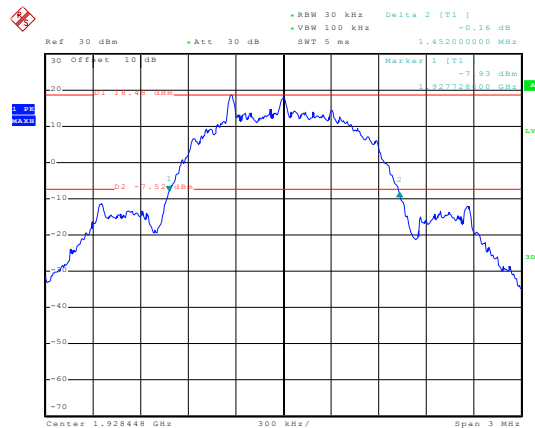

Date: 21.OCT.2014 21:18:19

99% Occupied Bandwidth Lowest channel

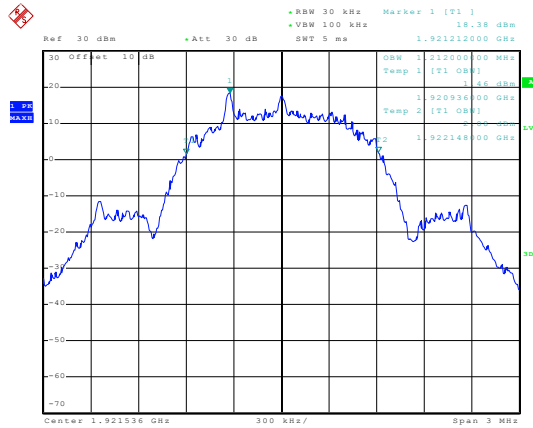

Date: 21.OCT.2014 21:12:14

Middle channel

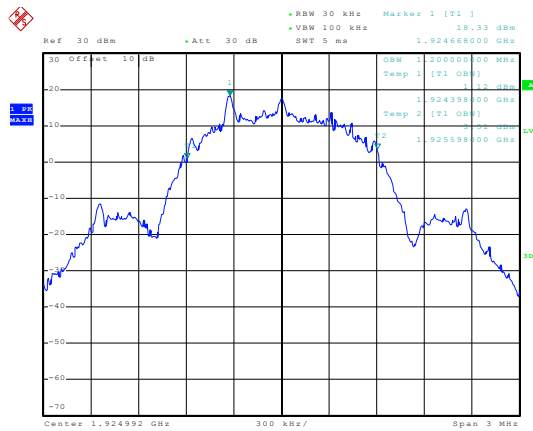

Date: 21.OCT.2014 21:52:24

Highest Channel

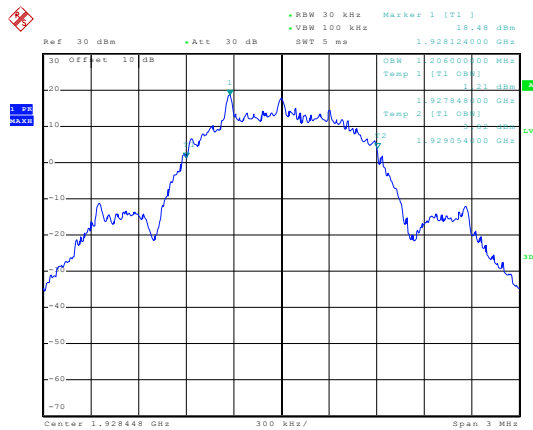

Date: 21.OCT.2014 21:20:02

7.4 Peak transmit power

7.4.1 Standard Applicable

According to FCC part 15.319(c) (e), RSS-213 section 6.5 and 4.1(e).

7.4.2 Test Procedure

According to ANSI 63.17: 2013 clause 6.1.2

7.4.3 Limits

Conducted: $100 \mu\text{W} \times \text{SQRT}(B)$ where B is the measured Emission Bandwidth in Hz

FCC 15.319(c)(e): 20.83 dBm (121.00 mW)

RSS-213, Issue 2: 20.42 dBm (110.09 mW)

The antenna gain is below 3 dBi, no reduction in transmit power is necessary.

7.4.4 Results

Meet the requirements

7.4.5 Measurement Data

See plots as below

Lowest Channel

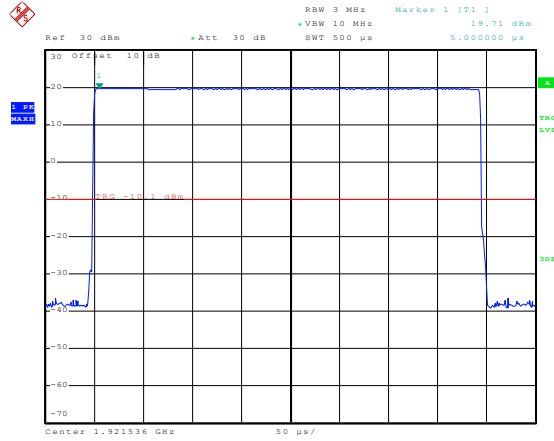

Date: 21.OCT.2014 21:24:43

Middle channel

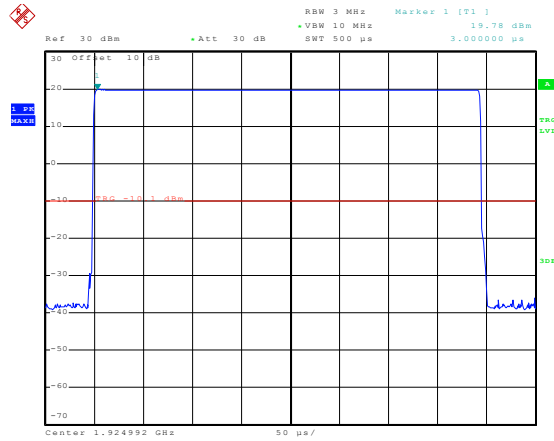

Date: 21.OCT.2014 21:23:57

Highest channel

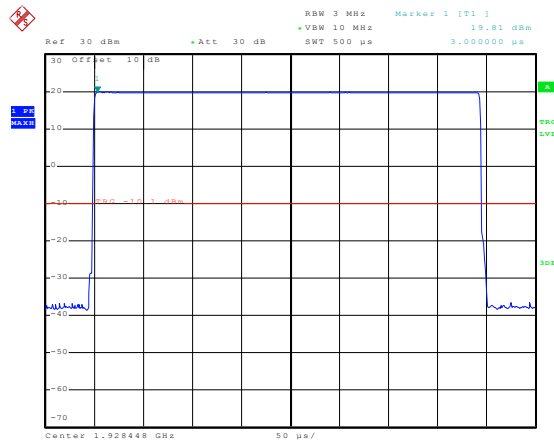

Date: 21.OCT.2014 21:23:10

7.5 Power spectral density

7.5.1 Standard Applicable

According to FCC part 15.319(d) and RSS-213 section 4.3.2.1

7.5.2 Test Procedure

According to ANSI 63.17: 2013 clause 6.1.5

7.5.3 Limits

The Power Spectral Density shall be less than 3 mW (4.77 dBm) when averaged over at least 100 sweeps.

7.5.4 Results

Meet the requirements

7.5.5 Measurement Data

See plots as below.

Lowest channel

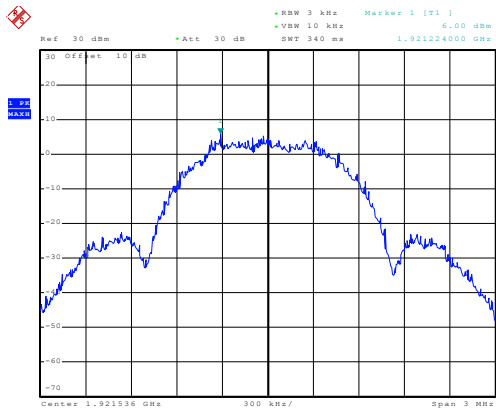

Date: 21.OCT.2014 21:05:44

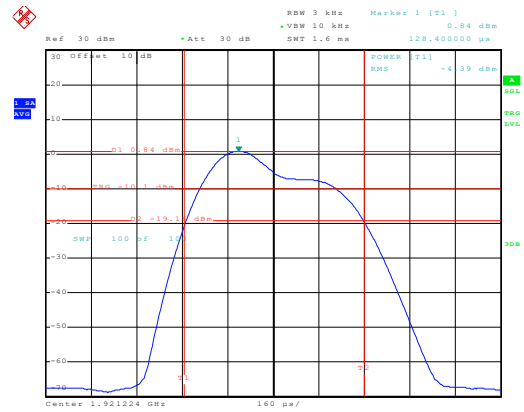

Date: 21.OCT.2014 21:07:14

Middle channel

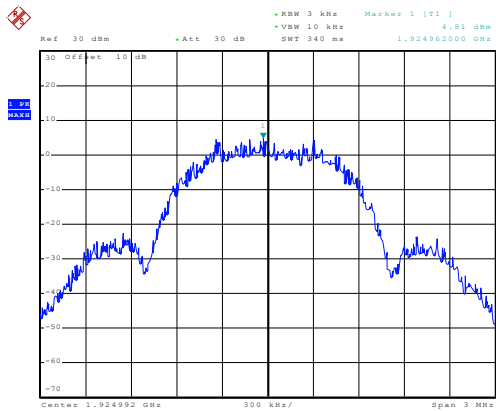

Date: 21.OCT.2014 20:54:06

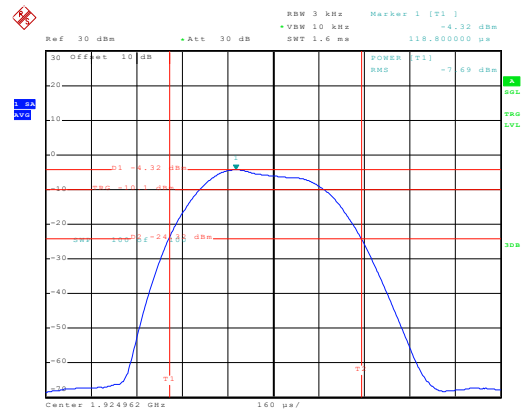

Date: 21.OCT.2014 20:58:48

Highest channel

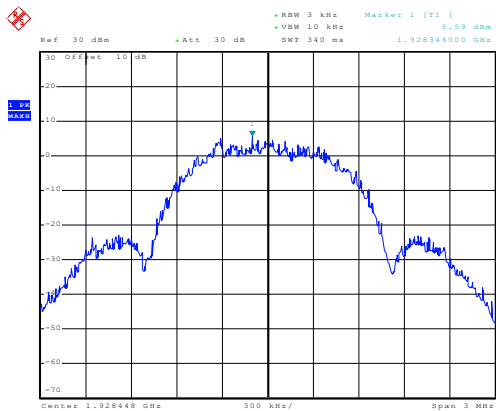

Date: 21.OCT.2014 20:35:32

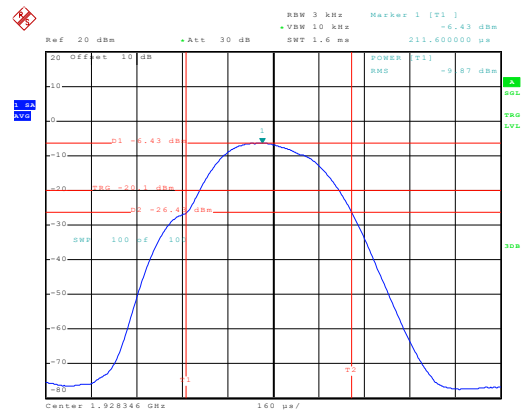

Date: 21.OCT.2014 20:42:36

7.6 In-band and Out-of-band emissions

7.6.1 Standard Applicable

According to FCC part 15.323(d), RSS-213 section 6.7.1 and 6.7.2

7.6.2 Test Procedure

According to ANSI 63.17: 2013 clause 6.1.6

7.6.3 Limits

In-Band Emissions:

$B < f \leq 2B$: at least 30 dB below max. permitted peak power

$2B < f \leq 3B$: at least 50 dB below max. permitted peak power

$3B < f \leq$ UPCS Band Edge: at least 60 dB below max. permitted peak power

Out-of-Band Emissions:

$f \leq 1.25\text{MHz}$ outside UPCS band: $\leq -9.5\text{dBm}$

$1.25\text{MHz} \leq f \leq 2.5\text{MHz}$ outside UPCS band: $\leq -29.5\text{ dBm}$

$f \geq 2.5\text{MHz}$ outside UPCS band: $\leq -39.5\text{ dBm}$

7.6.4 Test Result

Meet the requirements

7.6.5 Measurement Data

See plots as below

In-band emissions for FCC Lowest channel

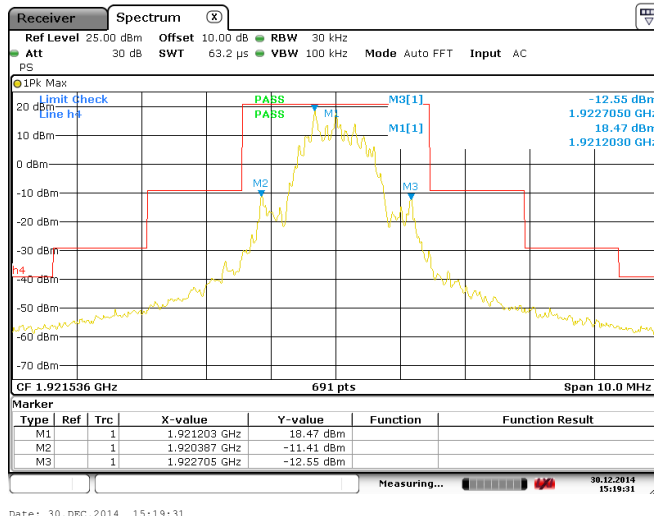

Middle channel

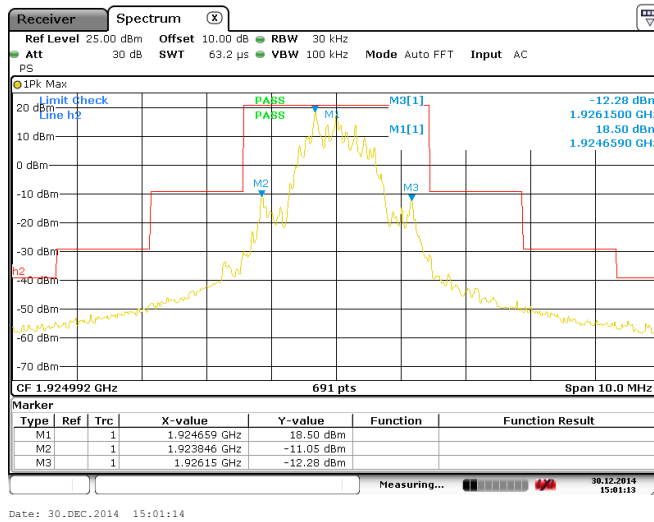

Highest channel

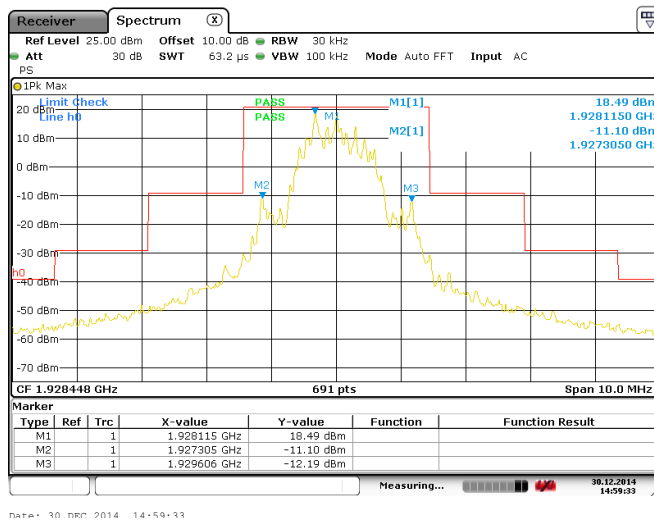

In-band emissions for IC Lowest channel

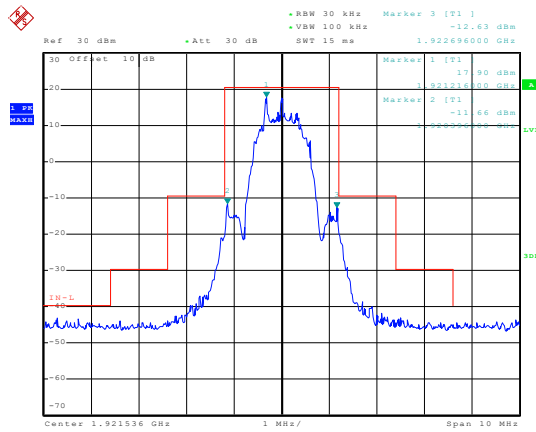

Date: 21.OCT.2014 22:44:31

Middle channel

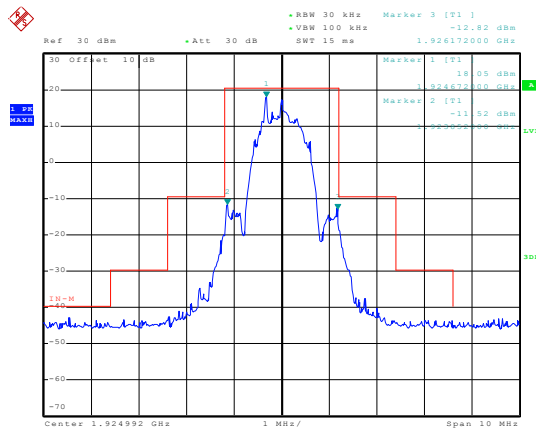

Date: 27.OCT.2014 21:40:24

Highest channel

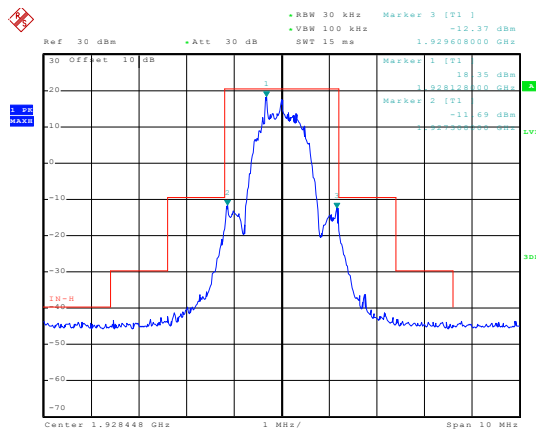

Date: 21.OCT.2014 22:43:14

Out-of-band emissions

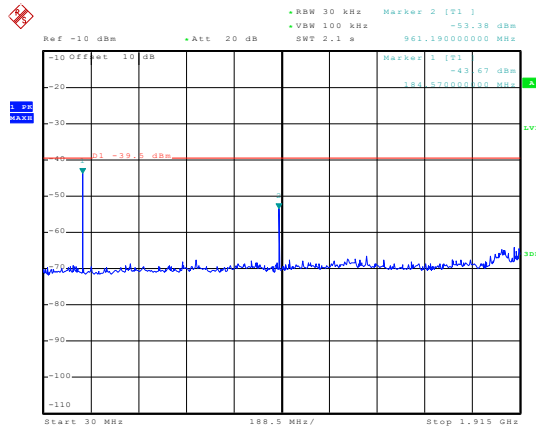

Date: 22.OCT.2014 14:42:00

30MHz-1915MHz

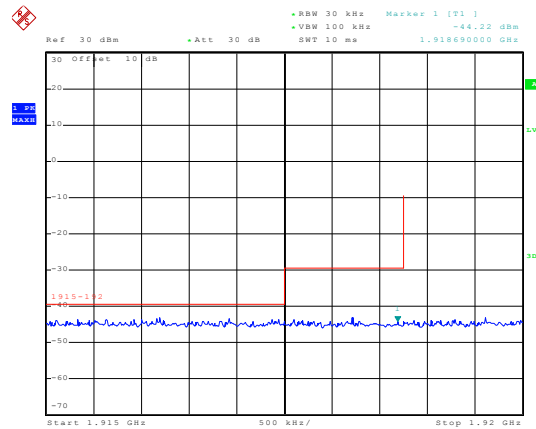

Date: 22.OCT.2014 14:35:54

1915MHz-1920MHz

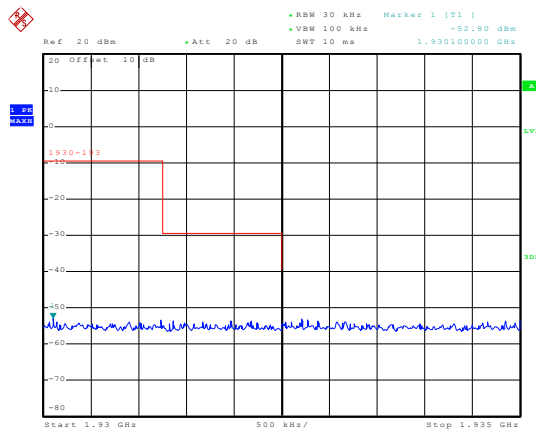

Date: 22.OCT.2014 14:57:40

1930MHz-1935MHz

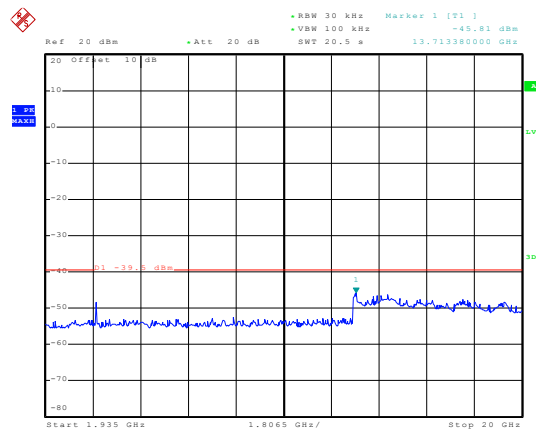

Date: 22.OCT.2014 14:59:27

1935MHz-20GHz

7.7 Carrier Frequency Stability

7.7.1 Standard Applicable

According to FCC part 15.323(f) and RSS-213 section 6.2

7.7.2 Test Procedure

According to ANSI 63.17: 2013 clause 6.2.1

7.7.3 Limits

±10 ppm

7.7.4 Test Result

Meet the requirements

7.7.5 Measurement Data

Frequency Stability over Power Supply Voltage at Nominal Temperature

Voltage	Channel Frequency	Difference	Deviation	Limits
V _{nom}	1924.992 MHz	/	/	±10 ppm
85% of V _{nom}	1924.992 MHz	/	/	
115% of V _{nom}	1924.992 MHz	/	/	

Note:

Deviation ppm = ((Mean – Measured Frequency) / Mean) x 10⁶

“/” means this test does not apply to the EUT that is capable only of operating from a battery.

Frequency Stability over Temperature

Temp.	Channel Frequency	Difference	Deviation	Limits
+20°C	1924.992 MHz	2 kHz	1.0 ppm	±10 ppm
-20°C	1924.992 MHz	-3 kHz	-1.6 ppm	
+50°C	1924.992 MHz	5 kHz	2.6 ppm	

7.8 Frame repetition Stability, period and jitter

7.8.1 Standard Applicable

According to FCC part 15.323(e) and RSS-213 section 4.3.4(c)

7.8.2 Test Procedure

According to ANSI 63.17: 2013 clause 6.2.2

7.8.3 Limits

±10 ppm for Frame Repetition Stability, 20 or 10 ms for frame period, 25 µs for max jitter.

7.8.4 Test Result

Meet the requirements

7.8.5 Measurement Data

Carrier Frequency (MHz)	Frame repetition (ppm)	Frame period (ms)	Max. pos. jitter (µs)	Max. neg.jiter (µs)
1924.448	1.99	10	0.09	-0.05

7.9 Automatically discontinue transmission

7.9.1 Standard Applicable

According to FCC part 15.319(f) and RSS-213 section 4.3.4(a)

7.9.2 Requirements

The device shall automatically discontinue transmission in case of either absence of information to transmit or operational failure. The provisions in this section are not intended to preclude transmission of control and signaling information or use of repetitive codes used by certain digital technologies to complete frame or burst intervals.

7.9.3 Results

Meet the requirements

7.9.4 Measurement Data

The EUT is a initiating device, and cannot transmits contrl and signaling information.

The following tests simulate the reaction of the EUT in case of either absence of information to transmit or operational failure after a connection with the companion device is established.

Number	Test Items	EUT Reaction	Verdict
1	Power removed from EUT	C	Pass
2	Switch off EUT	C	Pass
3	Hook-on by EUT	C	Pass
4	Power removed from companion device	A	Pass
5	Switchoff companion device	N/A	Pass
6	Hook-on by companion device	N/A	Pass

A - Connection breakdown, cease of all transmissions

B - Connection breakdown, EUT transmits control and signaling information

C - Connection breakdown, companion device transmits control and signaling information

N/A - Not Applicable (Companion device does not have On/ Off switch and cannot perform Hook-on)

7.10 Specific requirements for devices operating in the 1920-1930MHz sub-band

7.10.1 Monitoring time

Standard Applicable

According to FCC part 15.323(c)(1) and RSS-213 section 4.3.4(b)

Requirement

Immediately prior to initiating transmission, devices must monitor the combined time and spectrum windows in which they intend to transmit for a period of at least 10 milliseconds for systems designed to use a 10 milliseconds or shorter frame period or at least 20 milliseconds for systems designed to use a 20 milliseconds frame period.

Test Procedure

According to ANSI 63.17: 2013 clause 7.3.4

Result

Meet the requirements

Measurement Data

EUT monitors the combined time and spectrum window prior to initiation of transmission. The observation results as below

Channel Selection	Observation result	Verdict
1. Apply the interference on f_1 at level $T_U + U_M$, and no interference on f_2 . Initiate transmission and verify the transmission on f_2 .	EUT transmission on f_2	Pass
2. Apply interference on f_2 at a level of $TU + UM$, in-band, and immediately remove all interference from f_1 and immediately (but not sooner than 20 ms after the interference on f_2 is applied) cause the EUT to attempt transmission.	EUT transmission on f_1	Pass

7.10.2 Monitoring Threshold, Lease Interfered Channel

Standard Applicable

According to FCC part 15.323(c)(2)(5) and RSS-213 section 4.3.4(b)

Requirement

The monitoring threshold must not be more than 30 dB above the thermal noise power for a bandwidth equivalent to the emission bandwidth used by the device.

If access to spectrum is not available as determined by the above, and a minimum of 40 duplex system access channels are defined for the system, the time and spectrum windows with the lowest power level below a monitoring threshold of 50 dB above the thermal noise power determined for the emission bandwidth may be accessed.

Test procedure

Measurement method according to ANSI C63.17: 2013 clause 7.3.1, 7.3.2, 7.3.3 and 7.3.4

Test result

Meet the requirements

Measurement Data

Lower threshold: $TL = -174 + 10\log_{10}B + M_U + P_{MAX} - P_{EUT}$ (dBm)

Upper threshold: $TU = -174 + 10\log_{10}B + M_U + P_{MAX} - P_{EUT}$ (dBm)

Where: B=Emission bandwidth (Hz)

M_U =dB the threshold may exceed thermal noise (30 for TL & 50 for TU)

Calculated values

Threshold	FCC part 15D	RSS-213
Lower threshold	-81.8	-83.1
Upper threshold	N/A	-63.1

The Lower Threshold is applicable for systems which have defined less than 40 duplex system access channels. The Upper Threshold is applicable for systems with more than 40 duplex system access channels and that implements the Least Interfered Channel Procedure (LIC).

Upper Threshold has been removed from FCC 15D but still exists in the current Industry Canada RSS-213.

Limit

Threshold	FCC part 15D	RSS-213
Lower threshold + 6 dB	-75.8	-77.1
Upper threshold + 6 dB	N/A	-57.1

The Upper or Lower Threshold is found by the procedure defined in ANSI C63.17: 2013 clause 7.3.1 or 7.3.2.

Monitor Threshold	Measured level	FCC part 15D	RSS-213
Lower threshold	N/A	-75.8	-77.1
Upper threshold	-61.3	N/A	-57.1

For the EUT which support LIC there is no need to measure lower threshold because it is automatically met by LIC procedure

Least Interfered Channel (LIC) Procedure Test, FCC 15.323(c)(2) and (c)(5)

ANSI C63.17: 2013 clause 7.3.3 ref.	Observation	Verdict
b) f_1 TL + 13 dB, f_2 at TL + 6 dB	Transmission always on f_2	Pass
c) f_1 TL + 6 dB, f_2 at TL + 13 dB	Transmission always on f_1	Pass
d) f_1 TL + 7 dB, f_2 at TL	Transmission always on f_1	Pass
e) f_1 TL, f_2 at TL + 7 dB	Transmission always on f_1	Pass

7.10.3 Monitoring Threshold Bandwidth

Standard Applicable

According to FCC part 15.323(c)(7) and RSS-213 section 4.3.4(b)

Requirement

The monitoring system bandwidth must be equal to or greater than the emission bandwidth of the intended transmission.

Test procedure

Measurement method according to ANSI C63.17: 2013 clause 7.4

Test result

Meet the requirements

Measurement Data

This test is only required if a dedicated monitoring receiver is used. However, if the test is not carried out the manufacturer shall declare and provide proper evidence that the monitoring is made through the radio receiver used for communication.

Test performed	Observation	Verdict
Simple Compliance test, at $\pm 30\%$ of B	No transmissions	Pass
More Detailed Test, at -6 dB points	N/A	N/A
More Detailed Test, at -12 dB points	N/A	N/A

Notes:

1. The more detailed test must be pass at both the -6 and -12 dB points if the Simple Compliance test fails.
2. The Simple Compliance Test was performed with the level at $T_U + U_M + 10$ dB to check that the EUT did not transmit at all.
3. The tested EUT uses the same receiver for monitoring and communication, this test is therefore not required. However the test has been performed nonetheless and the test is passed.

7.10.4 Reaction Time and Monitoring Interval

Standard Applicable

According to FCC part 15.323(c)(1)(5)(7) and RSS-213 section 4.3.4(b)

Requirement

The monitoring system bandwidth must be equal to or greater than the emission bandwidth of the intended transmission and have a maximum reaction time less than $50 \times \text{SQRT}(1.25/\text{emission bandwidth in MHz})$ microseconds for signals at the applicable threshold level but shall not be required to be less than 50 microseconds.

If a signal is detected that is 6 dB or more above the applicable threshold level, the maximum reaction time shall be $35 \times \text{SQRT}(1.25/\text{emission bandwidth in MHz})$ microseconds but shall not be required to be less than 35 microseconds.

Test procedure

Measurement method according to ANSI C63.17: 2013 clause 7.5

Test result

Meet the requirements

Measurement Data

By administrative commands and out-of-operating region interference, the EUT is restricted to operate on a single carrier frequency.

Time-synchronized pulsed interference was then applied on the carrier at pulsed levels $T_U + U_M$ to check that the EUT does not transmit at all. The level was raised 6 dB for part d) with 35 μs pulses.

The pulses are synchronized with the EUT timeslots and applied centered within all timeslots.

Pulse Width, ref. to ANSI C63.17: 2013 clause 7.5	Observation	Verdict
c) > largest of 50 μs and $50 \times \text{SQRT}(1.25/B)$	No transmissions	Pass
d) > largest of 35 μs and $35 \times \text{SQRT}(1.25/B)$, and with interference level raised 6 dB	No transmissions	Pass

Notes:

Since B is larger than 1.25 MHz the test was performed with pulse lengths of 50 μs and 35 μs .

7.10.5 Time and Spectrum Window Access Procedure

Standard Applicable

According to FCC part 15.323(c)(4)(6) and RSS-213 section 4.3.4(b)

Requirement

FCC 15.323(c)(4):

Once access to specific combined time and spectrum windows is obtained an acknowledgement from a system participant must be received by the initiating transmitter within one second or transmission must cease. Periodic acknowledgements must be received at least every 30 seconds or transmission must cease.

Channels used exclusively for control and signaling information may transmit continuously for 30 seconds without receiving an acknowledgement, at which time the access criteria must be repeated.

FCC 15.323(c)(6):

If the selected combined time and spectrum windows are unavailable, the device may either monitor and select different windows or seek to use the same windows after waiting an amount of time, randomly chosen from a uniform random distribution between 10 and 150 milliseconds, commencing when the channel becomes available

Test procedure

Measurement method according to ANSI C63.17: 2013 clause 8.1

Test result

Meet the requirements

Measurement Data

This requirement is only for EUTs which transmit unacknowledged control and signaling information.

Access Criteria, ref. to ANSI C63.17: 2013 clause 8.1.1	Observation	Verdict
b) Check that the EUT transmits on the interference free time-slot	N/A	N/A
b) The EUT must terminate or pause in its repetitive transmission of the control and signaling channel on the open channel to repeat the access criteria not less frequently than every 30 s	N/A	N/A

If FCC 15.323(c)(6) option, **If Random Waiting Interval is NOT implemented**

Access Criteria, ref. to ANSI C63.17: 2013 clause 8.1.1	Observation	Verdict
b) Check that the EUT changes to an interference-free slot when interference is introduced on the time slot in use	N/A	N/A

If FCC 15.323(c)(6) option, **Only if Random Waiting Interval is implemented**

Access Criteria, ref. to ANSI C63.17: 2013 clause 8.1.1	Observation	Verdict
b-d) Check that the EUT uses random waiting interval before continuing transmission on an interfered time slot	N/A	N/A

Notes:

The tested EUT does not transmit unacknowledged control and signaling information.

7.10.6 Acknowledgements and Transmission Duration

Standard Applicable

According to FCC part 15.323(c)(3)(4) and RSS-213 section 4.3.4(b)

Requirement

Occupation of the same combined time and spectrum windows by a device or group of cooperating devices continuously over a period of time longer than 8 hours is not permitted without repeating the access criteria. Once access to specific combined time and spectrum windows is obtained an acknowledgement from a system participant must be received by the initiating transmitter within one second or transmission must cease.

Periodic acknowledgements must be received at least every 30 seconds or transmission must cease. Channels used exclusively for control and signaling information may transmit continuously for 30 seconds without receiving an acknowledgement, at which time the access criteria must be repeated.

Test procedure

Measurement method according to ANSI C63.17: 2013 clause 8.2

Test result

Meet the requirements

Measurement Data

During the test **Initial transmission without acknowledgements** the signal from the EUT to the companion device is blocked by circulators in addition to the tunable attenuator.

The test **Transmission time after loss of acknowledgements** is performed by cutting-off the signal from the companion device by a RF switch and measuring the time until the EUT stops transmitting.

The **Transmission Duration** test is performed by monitoring the slot in use and measuring the time until the EUT changes to a different slot.

Acknowledgements

Test ref. to ANSI C63.17: 2013 clause 8.2.1	Observation	Verdict
a) Initial transmission without acknowledgements	0.57s	Pass
c) Transmission time after loss of acknowledgements	10s	Pass

Transmission Duration

Test ref. to ANSI C63.17: 2013 clause 8.2.2	Observation	Verdict
b) Transmission duration on same time and frequency window	1 hour	Pass

7.10.7 Dual Access Criteria Check

Standard Applicable

According to FCC part 15.323(c)(10) and RSS-213 section 4.3.4(b)

Requirement

An initiating device may attempt to establish a duplex connection by monitoring both its intended transmits and receive time and spectrum windows. If both the intended transmit and receive time and spectrum windows meet the access criteria, then the initiating device can initiate a transmission in the intended transmit time and spectrum window. If the power detected by the responding device can be decoded as a duplex connection signal from the initiating device, then the responding device may immediately begin transmitting on the receive time and spectrum window monitored by the initiating device.

Test procedure

Measurement method according to ANSI C63.17: 2013 clause 8.3

Test result

Not tested. The manufacturer declares that this provision is not utilized by the EUT.

7.10.8 Alternative Monitoring Interval

Standard Applicable

According to FCC part 15.323(c)(11) and RSS-213 section 4.3.4(b)

Requirement

An initiating device that is prevented from monitoring during its intended transmit window due to monitoring system blocking from the transmissions of a co-located (within one meter) transmitter of the same system, may monitor the portions of the time and spectrum windows in which they intend to receive over a period of at least 10 milliseconds. The monitored time and spectrum window must total at least 50 percent of the 10 millisecond frame interval and the monitored spectrum must be within 1.25 MHz of the center frequency of channel(s) already occupied by that device or co-located co-operating devices. If the access criteria is met for the intended receive time and spectrum window under the above conditions, then transmission in the intended transmit window by the initiating device may commence.

Test procedure

Measurement method according to ANSI C63.17: 2013 clause 8.4

Test result

Not tested. The manufacturer declares that this provision is not utilized by the EUT.

7.10.9 Fair Access

Standard Applicable

According to FCC part 15.323(c)(12) and RSS-213 section 4.3.4(b)

Requirement

The provisions of (c)(10) or (c)(11) shall not be used to extend the range of spectrum occupied over space or time for the purpose of denying fair access to spectrum to other devices.

Test result

The manufacturer declares that this device does not use any mechanisms as provided by Part15.323 (c) (10) or (c) (11) to extend the range of spectrum occupied over space or time for the purpose of denying fail access to spectrum to other device.