

**FCC 47 CFR PART 15 SUBPART C &
INDUSTRY CANADA RSS-247 ISSUE 2 February 2017**

CERTIFICATION TEST REPORT

For

Product Name: Digital Video Baby Monitor (Parent Unit)

Model No.: MBP854CONNECTPU

Trademark: motorola

FCC ID: VLJ-MBP854V3PU

IC: 4522A-MBP854V3PU

HVIN: MBP854V3PU

Report No.: ES180725003W

Issue Date: July 7, 2018

Prepared for

Binatone Electronics International Ltd.

Floor 23A, 9 Des Voeux Road West, Sheung Wan, Hong Kong

Prepared by

EMTEK (SHENZHEN) CO., LTD.

Bldg 69, Majialong Industry Zone, Nanshan District, Shenzhen,
Guangdong, China

TEL: 86-755-26954280

FAX: 86-755-26954282

Table of Contents

1	TEST RESULT CERTIFICATION	3
2	EUT TECHNICAL DESCRIPTION	4
3	SUMMARY OF TEST RESULT.....	5
4	TEST METHODOLOGY	6
4.1	GENERAL DESCRIPTION OF APPLIED STANDARDS.....	6
4.2	MEASUREMENT EQUIPMENT USED.....	6
4.3	DESCRIPTION OF TEST MODES	7
5	FACILITIES AND ACCREDITATIONS	8
5.1	FACILITIES.....	8
5.2	LABORATORY ACCREDITATIONS AND LISTINGS.....	8
6	TEST SYSTEM UNCERTAINTY.....	9
7	SETUP OF EQUIPMENT UNDER TEST.....	10
7.1	RADIO FREQUENCY TEST SETUP 1.....	10
7.2	RADIO FREQUENCY TEST SETUP 2.....	10
7.3	CONDUCTED EMISSION TEST SETUP.....	12
7.4	BLOCK DIAGRAM CONFIGURATION OF TEST SYSTEM.....	13
7.5	SUPPORT EQUIPMENT	13
8	TEST REQUIREMENTS.....	14
8.1	20DB BANDWIDTH.....	14
8.2	99%BANDWIDTH.....	17
8.3	CARRIER FREQUENCY SEPARATION	18
8.4	NUMBER OF HOPPING FREQUENCIES	21
8.5	AVERAGE TIME OF OCCUPANCY (DWELL TIME).....	23
8.6	MAXIMUM PEAK CONDUCTED OUTPUT POWER AND EIRP POWER.....	27
8.7	CONDUCTED SUPRIOUS EMISSION.....	30
8.8	RADIATED SPURIOUS EMISSION	37
8.9	CONDUCTED EMISSION TEST	50
8.10	ANTENNA APPLICATION.....	55

1 TEST RESULT CERTIFICATION

Applicant:	Binatone Electronics International Ltd. Floor 23A, 9 Des Voeux Road West, Sheung Wan, Hong Kong
Manufacturer:	VTech (Dongguan) Telecommunications Ltd. VTech Science Park Xia Ling Bei Management Zone Liaobu, Dongguan 523411, Guangdong, China
Product Description:	Digital Video Baby Monitor (Parent Unit)
Model Number:	MBP854CONNECTPU

Measurement Procedure Used:

APPLICABLE STANDARDS	
STANDARD	TEST RESULT
FCC 47 CFR Part 2, Subpart J FCC 47 CFR Part 15, Subpart C RSS-Gen, Issue 5, April 2018 RSS-247 Issue2, February 2017	PASS

The above equipment was tested by EMTEK (SHENZHEN) CO., LTD. The test data, data evaluation, test procedures, and equipment configurations shown in this report were made in accordance with the procedures given in ANSI C63.10 (2013) and the energy emitted by the sample EUT tested as described in this report is in compliance with the requirements of FCC Rules Part 2, Part 15.247, IC RSS-247 IC RSS-GEN.

The test results of this report relate only to the tested sample identified in this report.

Date of Test : July 7, 2017 to September 15, 2017

Prepared by : *Yaping Shen*
Yaping Shen /Editor

Reviewer : *Joe Xia*
Joe Xia /Supervisor



Approve & Authorized Signer : *[Signature]*
Lisa Wang/Manager

2 EUT TECHNICAL DESCRIPTION

The EUT is a Digital Video Baby Monitor (Parent Unit) device, it supports general 2.4GHz wireless technology.

Characteristics	Description
Device Type	FHSS
Modulation:	GFSK
Operating Frequency Range(s):	2402.0 - 2477.0 MHz
Number of Channels:	22 channels
Channel Spacing	2/5 MHz
Transmit Power Max:	20.214dBm
Antenna Type	Integral Antenna
Antenna Gain	0 dBi
Operating Voltage	DC 5.0V@1500mA input via AC/DC adapter DC 3.8V 2000mAh input via internal Li-ion battery
AC/DC Adapter #1	Model: S012BEU0500150 Input: AC 100-240V~50/60Hz, 500mA Output: DC 5.0V~1500mA
AC/DC Adapter #2	Model: BLJ06W050150P1-U Input: 100-240V~50/60Hz, 0.2A Output: DC 5.0V~1500mA

Note: for more details, please refer to the User's manual of the EUT.

3 SUMMARY OF TEST RESULT

FCC Part Clause	Test Parameter	Verdict
FCC 15.247(a)(1) RSS-247.5.1(a)	20 dB Bandwidth	PASS
FCC 15.247(a)(1) RSS-247.5.1(b)	Carrier Frequency Separation	PASS
FCC 15.247(a)(1)(iii) RSS-247.5.1(d)	Number of Hopping Frequencies	PASS
FCC 15.247(a)(1)(iii) RSS-247.5.4(d)	Average Time of Occupancy (Dwell Time)	PASS
FCC 15.247(b)1 RSS-247.5.4(b)	Maximum Peak Conducted Output Power and EIRP Power	PASS
FCC 15.247(d) RSS-247 5.5	Conducted Spurious Emissions	PASS
FCC Part 15.247(d) & FCC Part 15.209 & FCC Part 15.205 RSS-247 Clause 3.3	Radiated Spurious Emissions	PASS
FCC 15.207 RSS-Gen 8.8	Conducted Emission	PASS
FCC 15.203 RSS-Gen 6.8	Antenna Application	PASS
RSS-Gen.6.7	99% Occupied Bandwidth	PASS
NOTE1: N/A (Not Applicable)		

4 TEST METHODOLOGY

4.1 GENERAL DESCRIPTION OF APPLIED STANDARDS

According to its specifications, the EUT must comply with the requirements of the following standards:

FCC 47 CFR Part 2, Subpart J
 FCC 47 CFR Part 15, Subpart C
 ANSI C63.10: 2013
 DA 00-705
 RSS-Gen, Issue 5, April 2018
 RSS-247, Issue 2 February 2017.

4.2 MEASUREMENT EQUIPMENT USED

4.2.1 Conducted Emission Test Equipment

EQUIPMENT TYPE	MFR	MODEL NUMBER	SERIAL NUMBER	LAST CAL.	DUE CAL.
Test Receiver	R&S	ESCS30	828985/018	05/20/2017	05/20/2018
L.I.S.N.	Schwarzbeck	NNLK8129	8129203	05/20/2017	05/20/2018
50Ω Coaxial Switch	Anritsu	MP59B	M20531	N/A	05/20/2018
Pulse Limiter	R&S	ESH3-Z2	100006	05/21/2017	05/20/2018

4.2.2 Radiated Emission Test Equipment

EQUIPMENT TYPE	MFR	MODEL NUMBER	SERIAL NUMBER	LAST CAL.	DUE CAL.
EMI Test Receiver	R&S	ESU	1302.6005.26	05/20/2017	05/20/2018
Pre-Amplifier	HP	8447D	2944A07999	05/20/2017	05/20/2018
Bilog Antenna	Schwarzbeck	VULB9163	142	05/20/2017	05/20/2018
Loop Antenna	ARA	PLA-1030/B	1029	05/20/2017	05/20/2018
Horn Antenna	Schwarzbeck	BBHA 9170	BBHA9170399	05/20/2017	05/20/2018
Horn Antenna	Schwarzbeck	BBHA 9120	D143	05/20/2017	05/20/2018
Cable	Schwarzbeck	AK9513	ACRX1	05/20/2017	05/20/2018
Cable	Rosenberger	N/A	FP2RX2	05/20/2017	05/20/2018
Cable	Schwarzbeck	AK9513	CRPX1	05/20/2017	05/20/2018
Cable	Schwarzbeck	AK9513	CRRX2	05/20/2017	05/20/2018

4.2.3 Radio Frequency Test Equipment

EQUIPMENT TYPE	MFR	MODEL NUMBER	SERIAL NUMBER	LAST CAL.	DUE CAL.
Spectrum Analyzer	Agilent	E4407B	88156318	05/20/2017	05/20/2018
Power meter	Anritsu	ML2495A	0824006	05/20/2017	05/20/2018
Power sensor	Anritsu	MA2411B	0738172	05/20/2017	05/20/2018
Spectrum Analyzer	Agilent	N9010A	My53470879	05/20/2017	05/20/2018

Remark: Each piece of equipment is scheduled for calibration once a year.

4.3 DESCRIPTION OF TEST MODES

The EUT has been tested under its typical operating condition.

The EUT configuration for testing is installed on RF field strength measurement to meet the Commissions requirement and operating in a manner which intends to maximize its emission characteristics in a continuous normal application.

The Transmitter was operated in the normal operating mode. The TX frequency was fixed which was for the purpose of the measurements.

Test of channel included the lowest and middle and highest frequency to perform the test, then record on this report.

Frequency and Channel list:

RF Channel	Frequency (MHz)	RF Channel	Frequency (MHz)	RF Channel	Frequency (MHz)
CH02	2402	CH30	2430	CH67	2467
CH04	2404	CH35	2435	CH69	2469
CH06	2406	CH40	2440	CH71	2471
CH08	2408	CH45	2445	CH73	2473
CH10	2410	CH50	2450	CH75	2475
CH15	2415	CH55	2455	CH77	2477
CH20	2420	CH60	2460	/	/
CH25	2425	CH65	2465	/	/

Test Frequency and channel:

Lowest Frequency		Middle Frequency		Highest Frequency	
Channel	Frequency (MHz)	Channel	Frequency (MHz)	Channel	Frequency (MHz)
CH02	2402	CH40	2440	CH77	2477

5 FACILITIES AND ACCREDITATIONS

5.1 FACILITIES

All measurement facilities used to collect the measurement data are located at

Bldg 69, Majialong Industry Zone District, Nanshan District, Shenzhen, China

The sites are constructed in conformance with the requirements of ANSI C63.7, ANSI C63.10 and CISPR Publication 22.

5.2 LABORATORY ACCREDITATIONS AND LISTINGS

Site Description

- EMC Lab.
- : Accredited by CNAS, 2016.10.24
The certificate is valid until 2022.10.28
The Laboratory has been assessed and proved to be in compliance with CNAS-CL01: 2006(identical to ISO/IEC17025: 2005)
The Certificate Registration Number is L2291

 - : Accredited by TUV Rheinland Shenzhen, 2010.5.25
The Laboratory has been assessed according to the requirements ISO/IEC 17025.

 - : Accredited by FCC
Designation Number: CN1204
Test Firm Registration Number: 882943.

 - : Accredited by Industry Canada, November 24, 2015
The Certificate Registration Number is 4480A-2

6 TEST SYSTEM UNCERTAINTY

The following measurement uncertainty levels have been estimated for tests performed on the apparatus:

Parameter	Uncertainty
Radio Frequency	$\pm 1 \times 10^{-5}$
Maximum Peak Output Power Test	$\pm 1.0\text{dB}$
Conducted Emissions Test	$\pm 2.0\text{dB}$
Radiated Emission Test	$\pm 2.0\text{dB}$
Occupied Bandwidth Test	$\pm 1.0\text{dB}$
Band Edge Test	$\pm 3\text{dB}$
All emission, radiated	$\pm 3\text{dB}$
Antenna Port Emission	$\pm 3\text{dB}$
Temperature	$\pm 0.5^\circ\text{C}$
Humidity	$\pm 3\%$

Measurement Uncertainty for a level of Confidence of 95%

7 SETUP OF EQUIPMENT UNDER TEST

7.1 RADIO FREQUENCY TEST SETUP 1

The EUT component's antenna ports of the EUT are connected to the measurement instrument per an appropriate attenuator. The EUT is controlled by PC/software to emit the specified signals for the purpose of measurements.

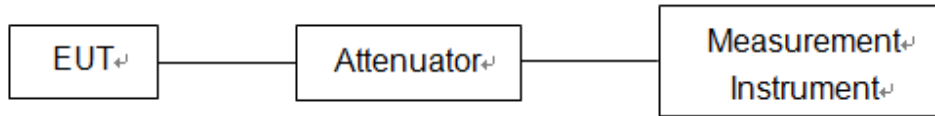

7.2 RADIO FREQUENCY TEST SETUP 2

The test site semi-anechoic chamber has met the requirement of NSA tolerance 4 dB according to the standards: ANSI C63.10. The test distance is 3m. The setup is according to the requirements in Section 13.1.4.1 of ANSI C63.10-2013 and CAN/CSA-CEI/IEC CISPR 22.

Below 30MHz:

The EUT is placed on a turntable 0.8 meters above the ground in the chamber, 3 meter away from the antenna (loop antenna). The Antenna should be positioned with its plane vertical at the specified distance from the EUT and rotated about its vertical axis for maximum response at each azimuth about the EUT. The center of the loop shall be 1 m above the ground. For certain applications, the loop antenna plane may also need to be positioned horizontally at the specified distance from the EUT.

Above 30MHz:

The EUT is placed on a turntable 0.8 meters above the ground in the chamber, 3 meter away from the antenna. The maximal emission value is acquired by adjusting the antenna height, polarisation and turntable azimuth. Normally, the height range of antenna is 1 m to 4 m, the azimuth range of turntable is 0° to 360°, and the receive antenna has two polarizations Vertical (V) and Horizontal (H).

Above 1GHz:

(Note: the FCC's permission to use 1.5 m as an alternative per TCBC Conf call of Dec. 2, 2014.)

The EUT is placed on a turntable 1.5 meters above the ground in the chamber, 3 meter away from the antenna. The maximal emission value is acquired by adjusting the antenna height, polarisation and turntable azimuth. Normally, the height range of antenna is 1 m to 4 m, the azimuth range of turntable is 0° to 360°, and the receive antenna has two polarizations Vertical (V) and Horizontal (H).

(a) Radiated Emission Test Set-Up, Frequency Below 30MHz

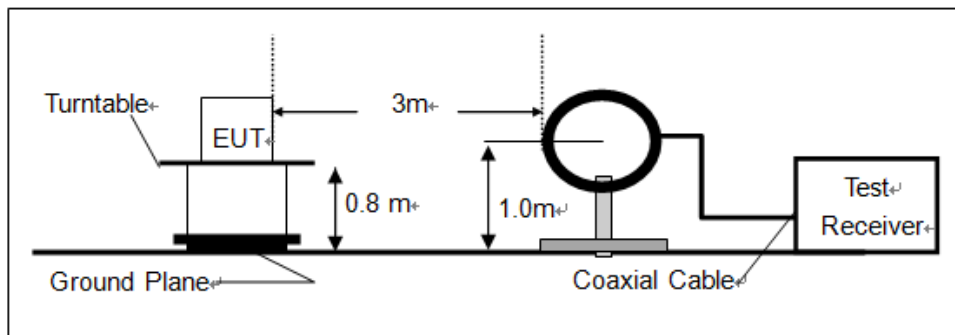

(b) Radiated Emission Test Set-Up, Frequency Below 1000MHz

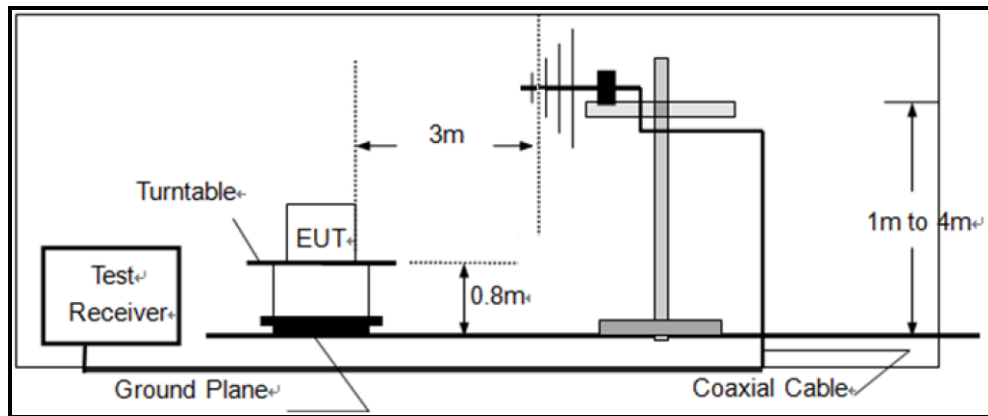

(c) Radiated Emission Test Set-Up, Frequency above 1000MHz

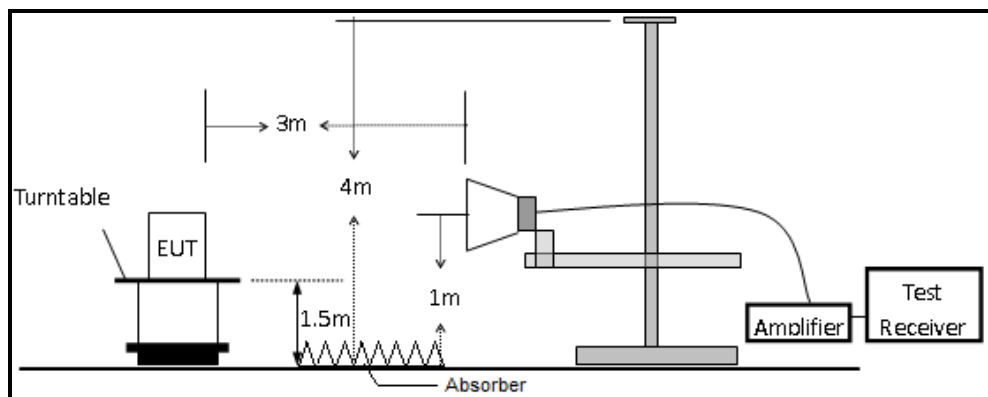

7.3 CONDUCTED EMISSION TEST SETUP

The mains cable of the EUT (Perfect Share Mini) must be connected to LISN. The LISN shall be placed 0.8 m from the boundary of EUT and bonded to a ground reference plane for LISN mounted on top of the ground reference plane. This distance is between the closest points of the LISN and the EUT. All other units of the EUT and associated equipment shall be at least 0.8m from the LISN.

Ground connections, where required for safety purposes, shall be connected to the reference ground point of the LISN and, where not otherwise provided or specified by the manufacturer, shall be of same length as the mains cable and run parallel to the mains connection at a separation distance of not more than 0.8 m.

According to the requirements in Section 13.1.4.1 of ANSI C63.10-2013 Conducted emissions from the EUT measured in the frequency range between 0.15 MHz and 30 MHz using CISPR Quasi-Peak and average detector mode.

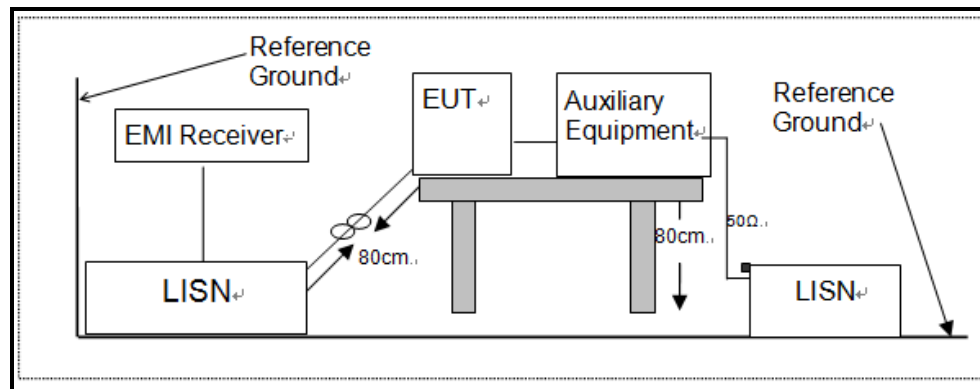

7.4 BLOCK DIAGRAM CONFIGURATION OF TEST SYSTEM

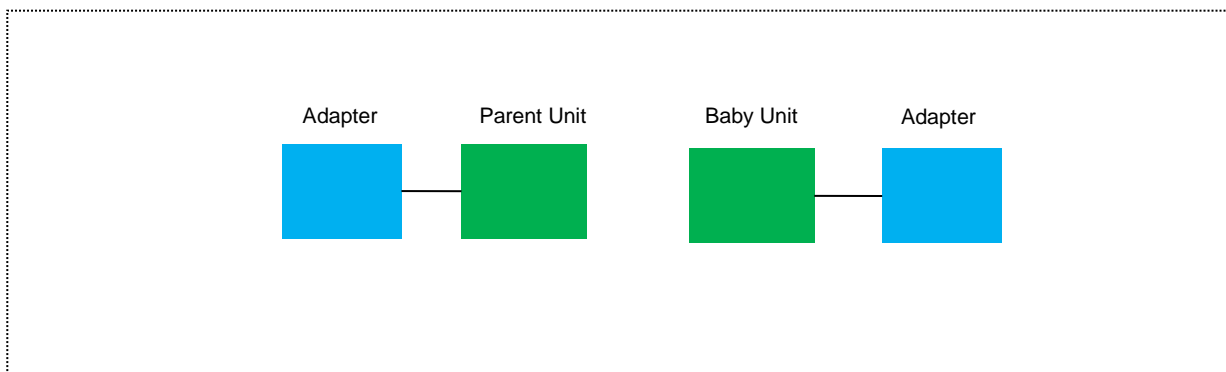

7.5 SUPPORT EQUIPMENT

Item	Equipment	Mfr/Brand	Model/Type No.	S/N	Note
1.	Digital Video Baby Monitor (Baby Unit)	motorola	MBP854CONNECTBU	N/A	N/A

Notes:

1. All the equipment/cables were placed in the worst-case configuration to maximize the emission during the test.
2. Grounding was established in accordance with the manufacturer's requirements and conditions for the intended use.

8 TEST REQUIREMENTS

8.1 20DB BANDWIDTH

8.1.1 Applicable Standard

According to FCC Part 15.247(a)(1) and RSS-247 Clause 5.1(a)

8.1.2 Conformance Limit

No limit requirement.

8.1.3 Test Configuration

Test according to clause 7.1 radio frequency test setup 1

8.1.4 Test Procedure

The EUT was operating in mode and controlled its channel. Printed out the test result from the spectrum by hard copy function.

The RF output of EUT was connected to the spectrum analyzer by RF cable and attenuator. The path loss was compensated to the results for each measurement.

Set to the maximum power setting and enable the EUT transmit continuously

Set RBW = 100 kHz.

Set the video bandwidth (VBW) =300 kHz.

Set Span= approximately 2 to 3 times the 20 dB bandwidth

Set Detector = Peak.

Set Trace mode = max hold.

Set Sweep = auto couple.

The EUT should be transmitting at its maximum data rate. Allow the trace to stabilize. Use the marker-to-peak function to set the marker to the peak of the emission. Use the marker-delta function to measure 20 dB down one side of the emission. Reset the markerdelta function, and move the marker to the other side of the emission, until it is (as close as possible to) even with the reference marker level. The marker-delta reading at this point is the 20 dB bandwidth of the emission.

If this value varies with different modes of operation (e.g., data rate, modulation format, etc.), repeat this test for each variation.

Measure and record the results in the test report.

Test Results

All Adapter have been tested, and the worst result(Adapter 1) was report as below:

Temperature:	24°C	Test Date:	July 13, 2017
Humidity:	53 %	Test By:	King Kong

Modulation Mode	Channel Number	Channel Frequency (MHz)	20dB Bandwidth (MHz)	Limit (MHz)	Verdict
GFSK	02	2402	2.008	N/A	PASS
	40	2440	2.088	N/A	PASS
	77	2477	2.081	N/A	PASS
Note: N/A (Not Applicable)					

Test Model

20dB Bandwidth
Channel 02: 2402MHz

GFSK Modulation

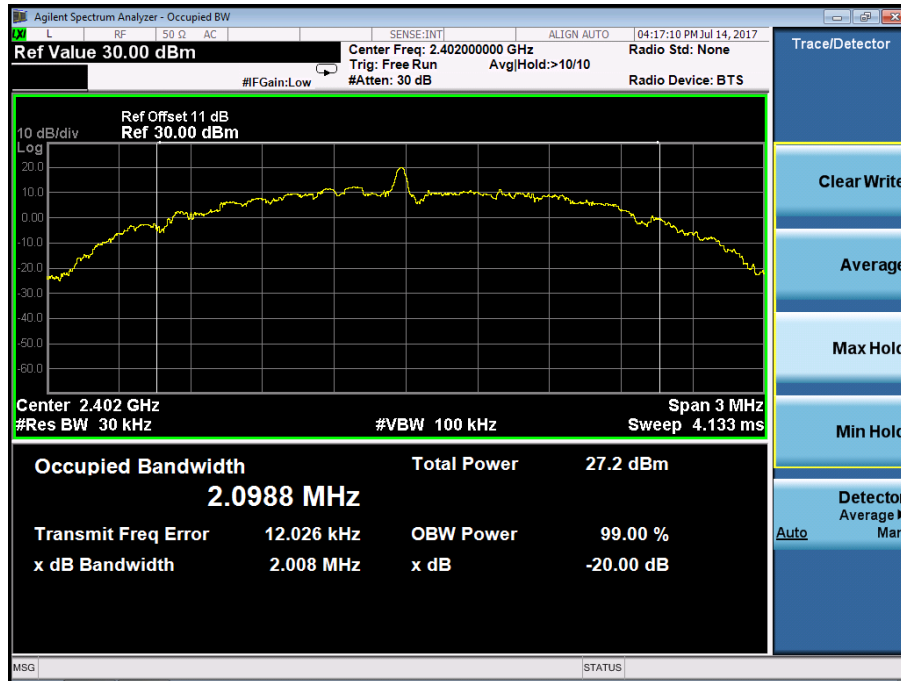

Test Model

20dB Bandwidth
Channel 40: 2440MHz

GFSK Modulation

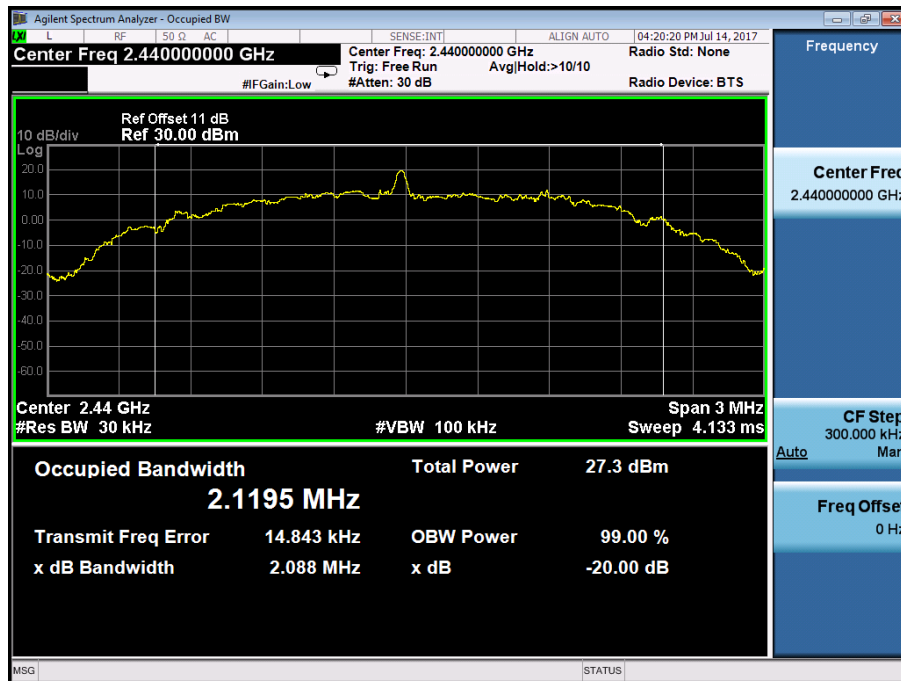

Test Model 20dB Bandwidth
Channel 77: 2477MHz GFSK Modulation

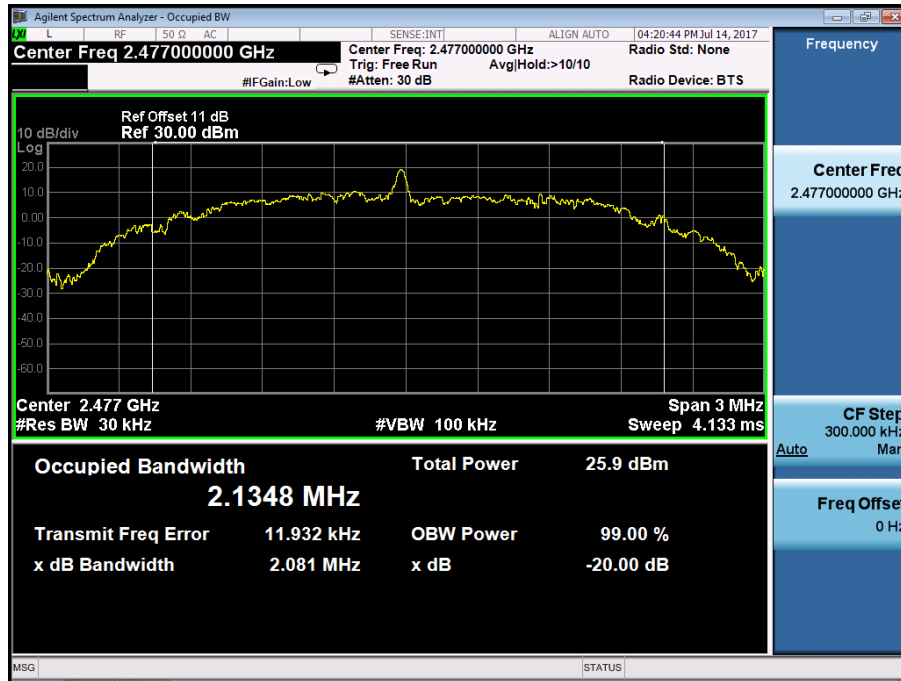

8.3 CARRIER FREQUENCY SEPARATION

8.3.1 Applicable Standard

According to FCC Part 15.247(a)(1) and RSS-247 Clause 5.1(b)

8.3.2 Conformance Limit

Frequency hopping systems operating in the 2400-2483.5MHz band shall have hopping channel carrier frequencies separated by a minimum of 25kHz or the 20dB bandwidth of the hopping channel, whichever is greater.

In case of an output power less than 125mW, the frequency hopping system may have channels separated by a minimum of 25kHz or two-thirds of the 20dB bandwidth of the hopping channel, whichever is greater.

8.3.3 Test Configuration

Test according to clause 7.1 radio frequency test setup 1

8.3.4 Test Procedure

- According to FCC Part15.247(a)(1)& According to RSS-247 Clause 5.1(b)
The EUT must have its hopping function enabled. Use the following spectrum analyzer settings:
Set the RBW =100kHz.
Set VBW =300kHz.
Set the span = wide enough to capture the peaks of two adjacent channels
Set Sweep time = auto couple.
Set Detector = peak.
Set Trace mode = max hold.
Allow the trace to stabilize. Use the marker-delta function to determine the separation between the peaks of the adjacent channels. The limit is specified in one of the subparagraphs of this Section. Submit this plot.

Test Results

All Adapter have been tested, and the worst result(Adapter 1) was report as below:

Temperature:	24°C	Test Date:	July 13, 2017
Humidity:	53 %	Test By:	King Kong

Modulation Mode	Channel Number	Channel Frequency (MHz)	Channel Seperation (MHz)	Limit (MHz)	Verdict
GFSK	02	2402	1.995	>1.34	PASS
	40	2440	4.995	>1.39	PASS
	77	2477	2.016	>1.39	PASS

Note: Limit = 20dB bandwidth * 2/3, if it is greater than 25kHz and the output power is less than 125mW (21dBm).

Test Model

Carrier Frequency Separation
Channel 02: 2402MHz

GFSK Modulation

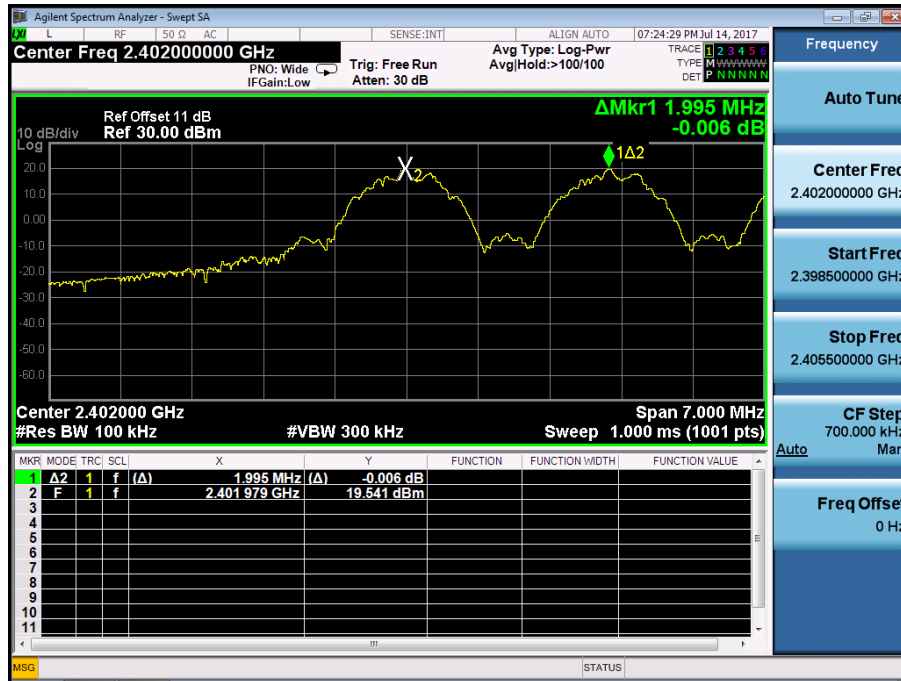

Test Model

Carrier Frequency Separation
Channel 40: 2440MHz

GFSK Modulation

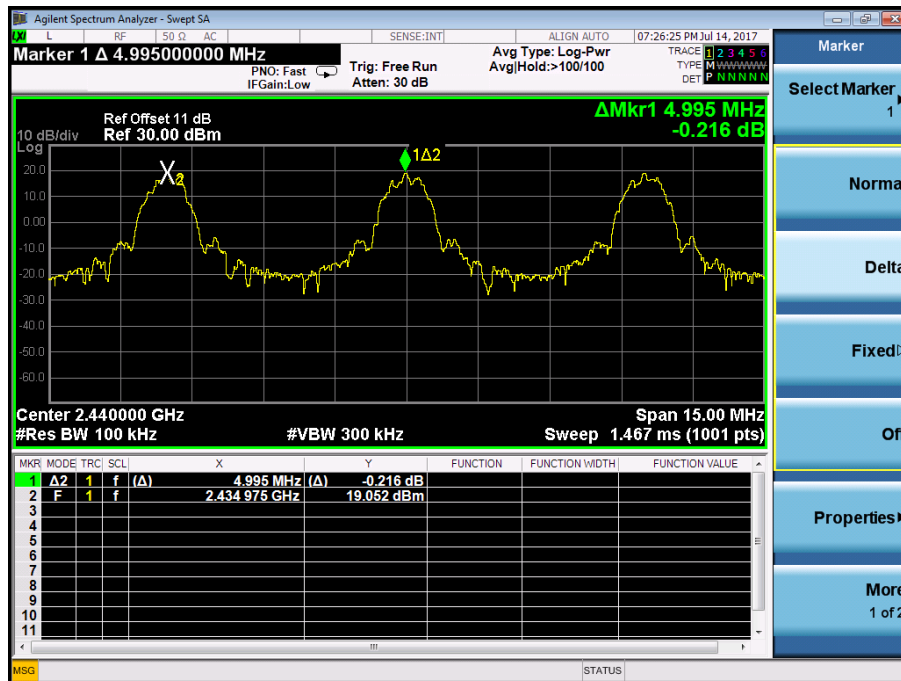

Test Model

Carrier Frequency Separation
Channel 77: 2477MHz

GFSK Modulation

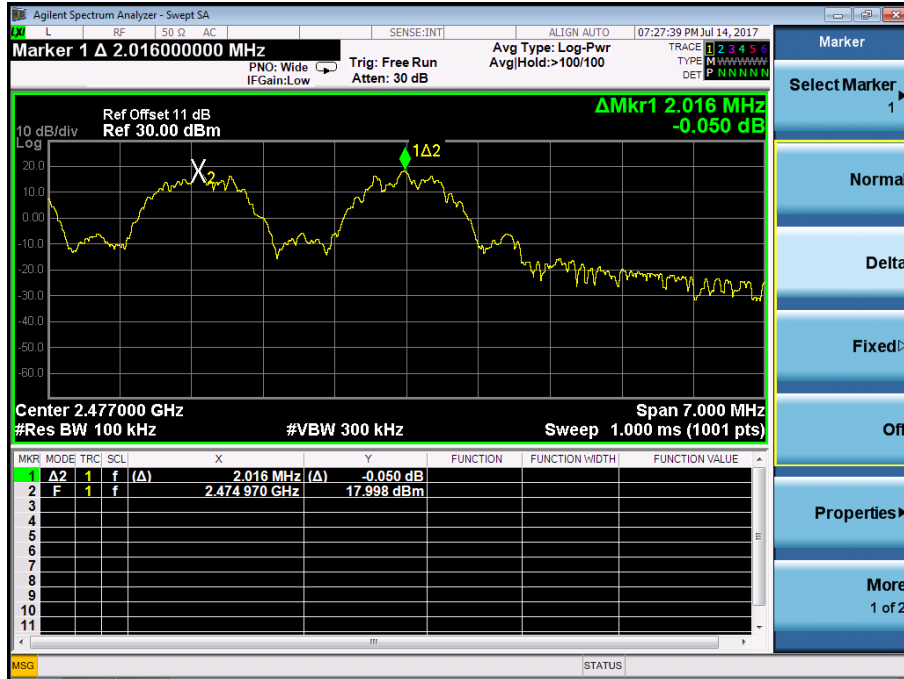

8.4 NUMBER OF HOPPING FREQUENCIES

8.4.1 Applicable Standard

According to FCC Part 15.247(a)(1)(iii) and RSS-247 Clause 5.1(d)

8.4.2 Conformance Limit

Frequency hopping systems operating in the 2400-2483.5MHz band shall use at least 15 channels.

8.4.3 Test Configuration

Test according to clause 7.1 radio frequency test setup 1

8.4.4 Test Procedure

According to FCC Part15.247(a)(1)(iii) and RSS-247 Clause 5.1(d)

The EUT must have its hopping function enabled. Use the following spectrum analyzer settings:

Span = the frequency band of operation (2400-2483.5MHz)

RBW \geq 100KHz

VBW \geq RBW

Sweep = auto

Detector function = peak

Trace = max hold

Allow the trace to stabilize. It may prove necessary to break the span up to sections, in order to clearly show all of the hopping frequencies.

Test Results

All Adapter have been tested, and the worst result(Adapter 1) was report as below:

Temperature:	24°C	Test Date:	July 13, 2017
Humidity:	53 %	Test By:	King Kong

Hopping Channel Frequency Range	Quantity of Hopping Channel	Quantity of Hopping Channel limit
2402 MHz-2477 MHz	22	> 15

Test Model Number Of Hopping Frequencies
Span: 2400-2483.5MHz

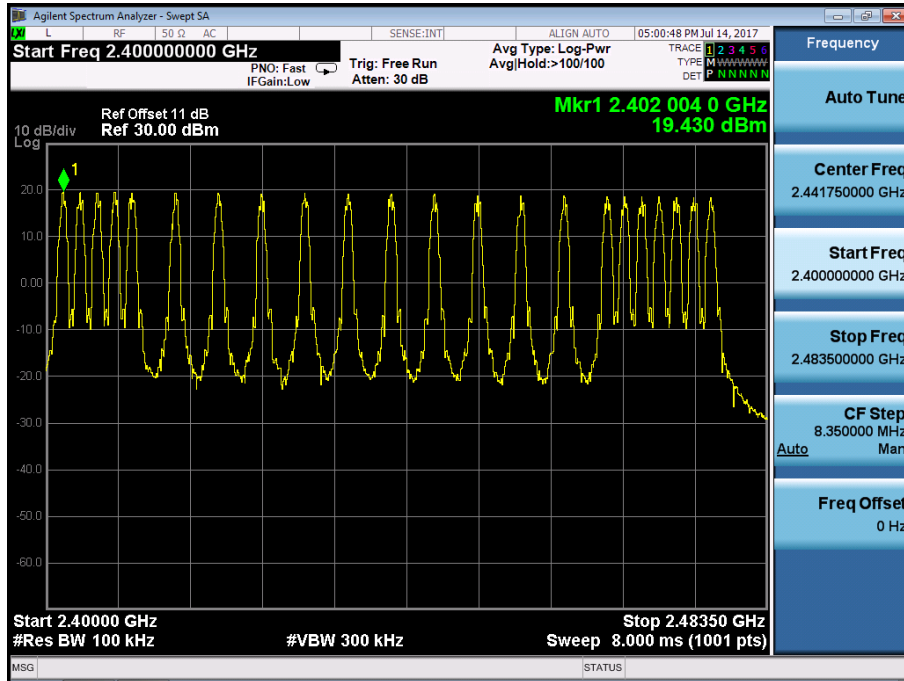

8.5 AVERAGE TIME OF OCCUPANCY (DWELL TIME)

8.5.1 Applicable Standard

According to FCC Part 15.247(a)(1)(iii) and RSS-247 Clause 5.4(d)

8.5.2 Conformance Limit

For frequency hopping systems operating in the 2400-2483.5MHz band, the average time of occupancy on any channel shall not be greater than 0.4s within a period of 0.4s multiplied by the number of hopping channels employed.

8.5.3 Test Configuration

Test according to clause 7.1 radio frequency test setup 1

8.5.4 Test Procedure

- According to FCC Part 15.247(a)(1)(iii) and IC RSS-247 Clause 5.4(d)

The EUT must have its hopping function enabled. Use the following spectrum analyzer settings:

Span = zero span, centered on a hopping channel

RBW = 1 MHz

VBW \geq RBW

Sweep = as necessary to capture the entire dwell time per hopping channel

Detector function = peak

Trace = max hold

If possible, use the marker-delta function to determine the dwell time. If this value varies with different modes of operation (e.g., data rate, modulation format, etc.), repeat this test for each variation. The limit is specified in one of the subparagraphs of this Section.

8.5.5 Test Results

All Adapter have been tested, and the worst result(Adapter 1) was report as below:

Temperature:	24°C	Test Date:	July 13, 2017
Humidity:	53 %	Test By:	King Kong

Modulation Mode	Channel Number	Channel Frequency (MHz)	Pluse width (ms)	Dwell Time (ms)	Limit (ms)	Verdict
GFSK	02	2402	0.220	28.60	<400	PASS
	40	2440	0.216	30.24	<400	PASS
	77	2477	0.216	28.08	<400	PASS
Note: Dwell Time(ms)= Pluse width(ms)* Pluse number Period(s)=0.4* number of hopping channels						

Test Model

AVERAGE TIME OF OCCUPANCY
Channel 02: 2402MHz

GFSK Modulation

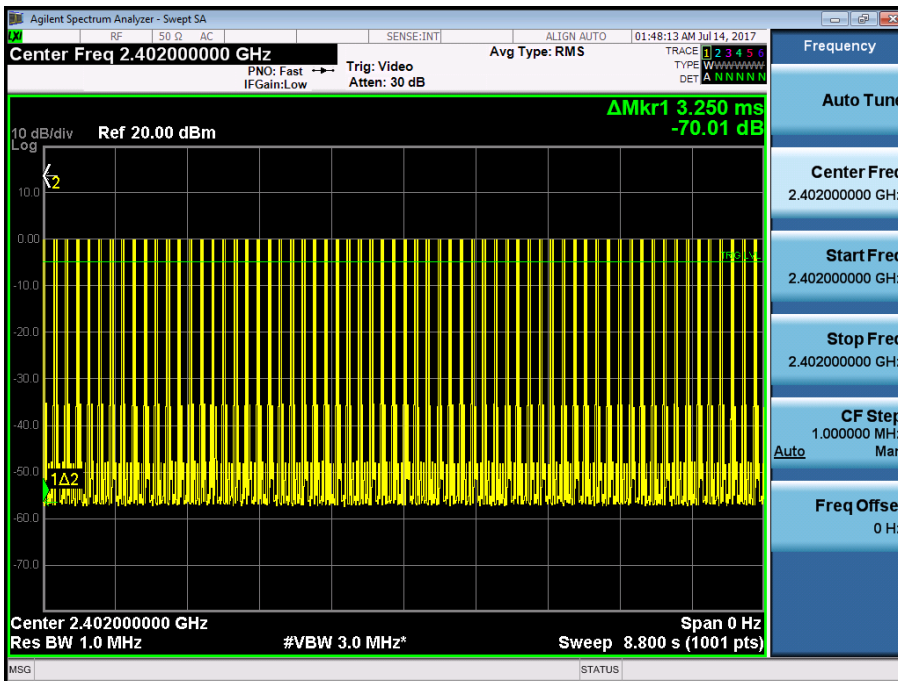
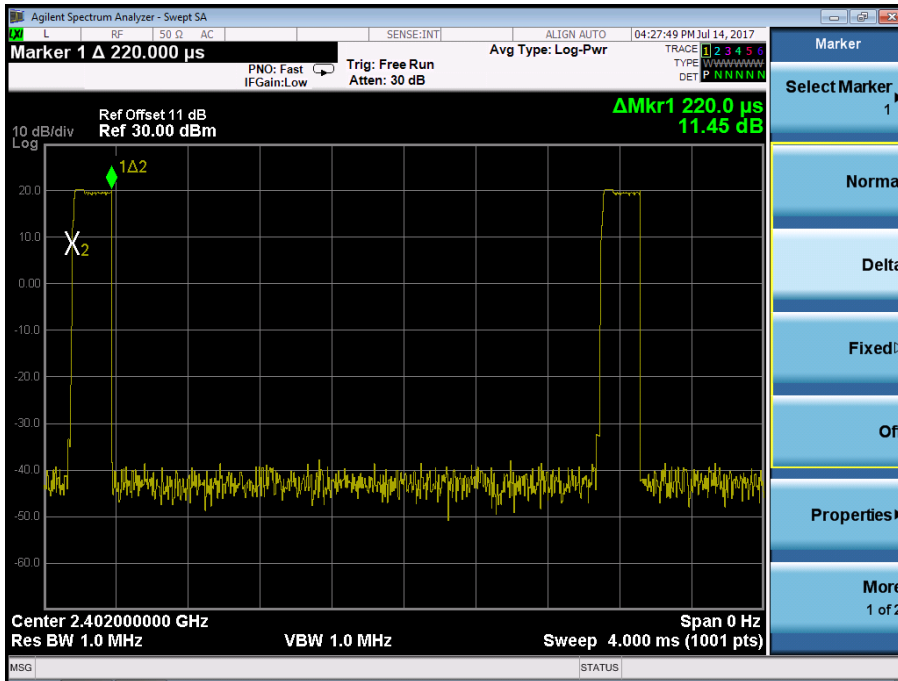

Test Model AVERAGE TIME OF OCCUPANCY
Channel 40: 2440MHz GFSK Modulation

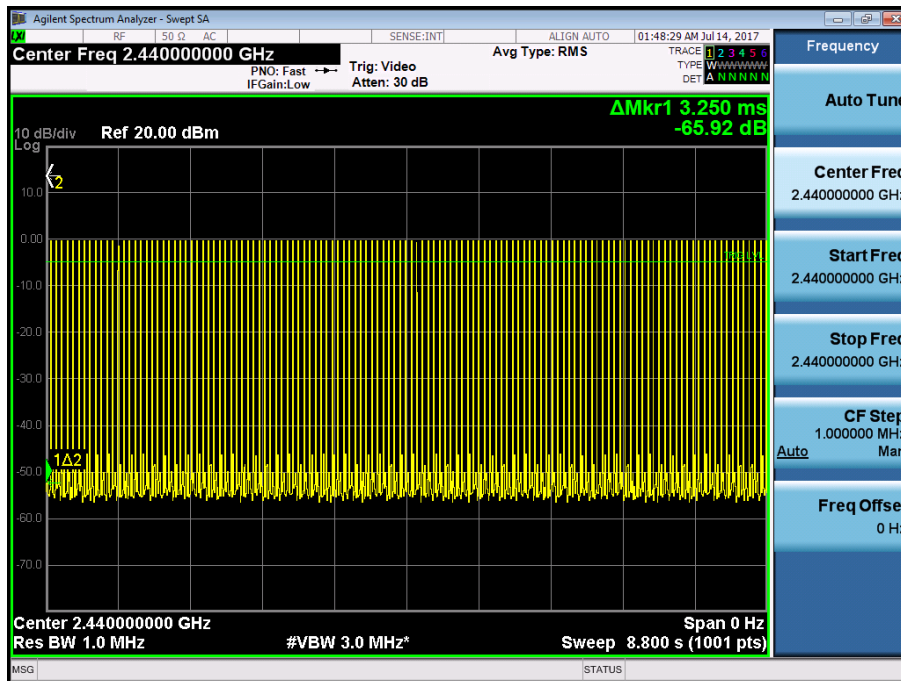
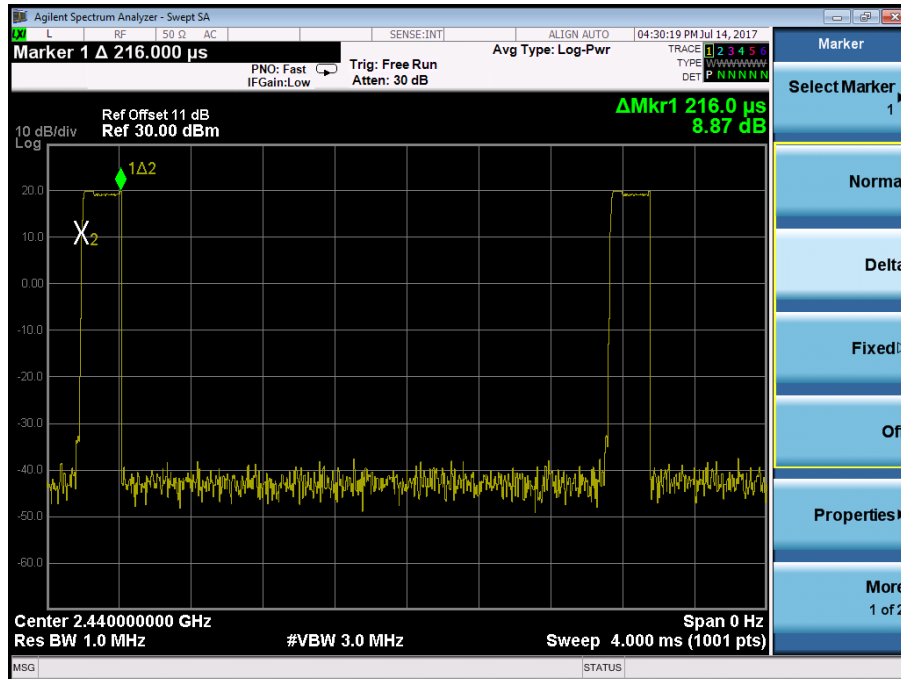

Test Model

AVERAGE TIME OF OCCUPANCY
Channel 77: 2477MHz

GFSK Modulation

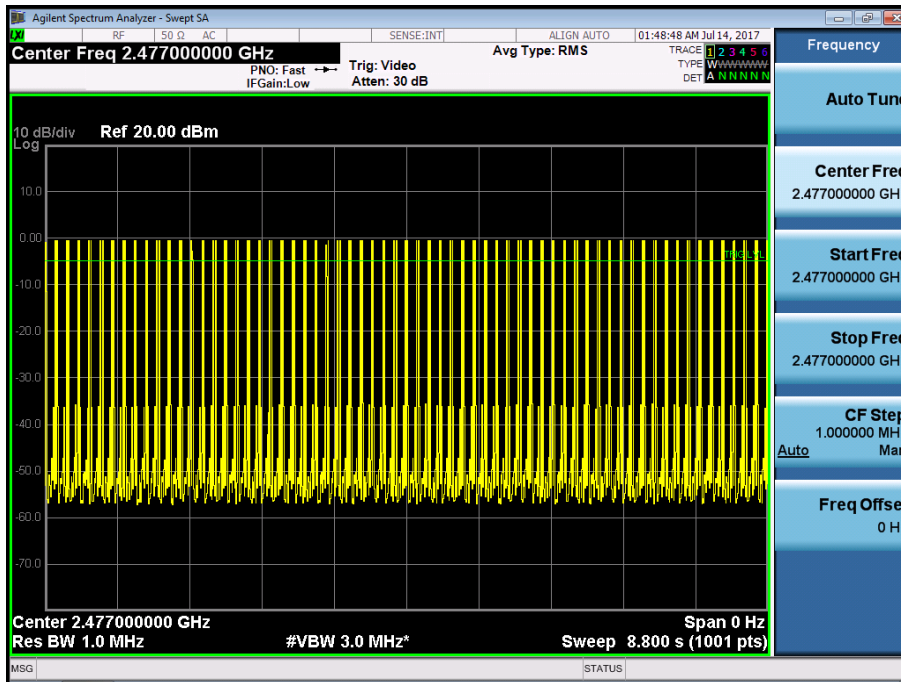
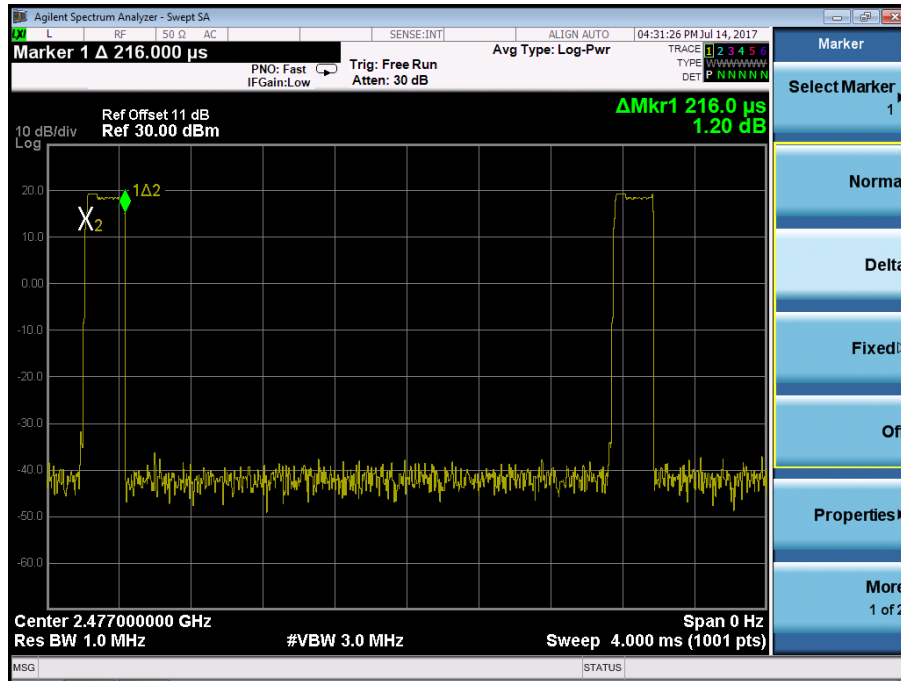

8.6 MAXIMUM PEAK CONDUCTED OUTPUT POWER AND EIRP POWER

8.6.1 Applicable Standard

According to FCC Part 15.247(b)(1) and RSS-247 Clause 5.4(b)

8.6.2 Conformance Limit

The max For frequency hopping systems operating in the 2400-2483.5 MHz band employing at least 75 non-overlapping hopping channels: 1 watt. For all other frequency hopping systems in the 2400-2483.5 MHz band: 0.125 watts.

8.6.3 Test Configuration

Test according to clause 7.1 radio frequency test setup 1

8.6.4 Test Procedure

- According to FCC Part15.247(b)(1) and RSS-247 Clause 5.4(b)

As an alternative to a peak power measurement, compliance with the limit can be based on a measurement of the maximum conducted output power.

Use the following spectrum analyzer settings:

Set Span = approximately 5 times the 20 dB bandwidth, centered on a hopping channel (about 10MHz)

Set RBW > the 20 dB bandwidth of the emission being measured (about 3MHz)

Set VBW ≥ RBW

Set Sweep = auto

Set Detector function = peak

Set Trace = max hold

Allow the trace to stabilize. Use the marker-to-peak function to set the marker to the peak of the emission to determine the peak amplitude level.

Test Results

All Adapter have been tested, and the worst result(Adapter 1) was report as below:

Temperature:	24°C	Test Date:	July 13, 2017
Humidity:	53 %	Test By:	King Kong

Operation Mode	Channel Number	Channel Frequency (MHz)	Max Peak Power (dBm)	Limit (dBm)	Verdict
GFSK	02	2402	19.371	21	PASS
	40	2440	19.892	21	PASS
	77	2477	20.214	21	PASS
Note: N/A					

Operation Mode	Channel Number	Channel Frequency (MHz)	EIRP (dBm)	Limit (dBm)	Verdict
GFSK	02	2402	19.371	36	PASS
	40	2440	19.892	36	PASS
	77	2477	20.214	36	PASS
Note: EIRP= Max Peak Power+Antenna Gain (0dBi)					

Test Model

Max Peak Power
Channel 02: 2402MHz

GFSK Modulation

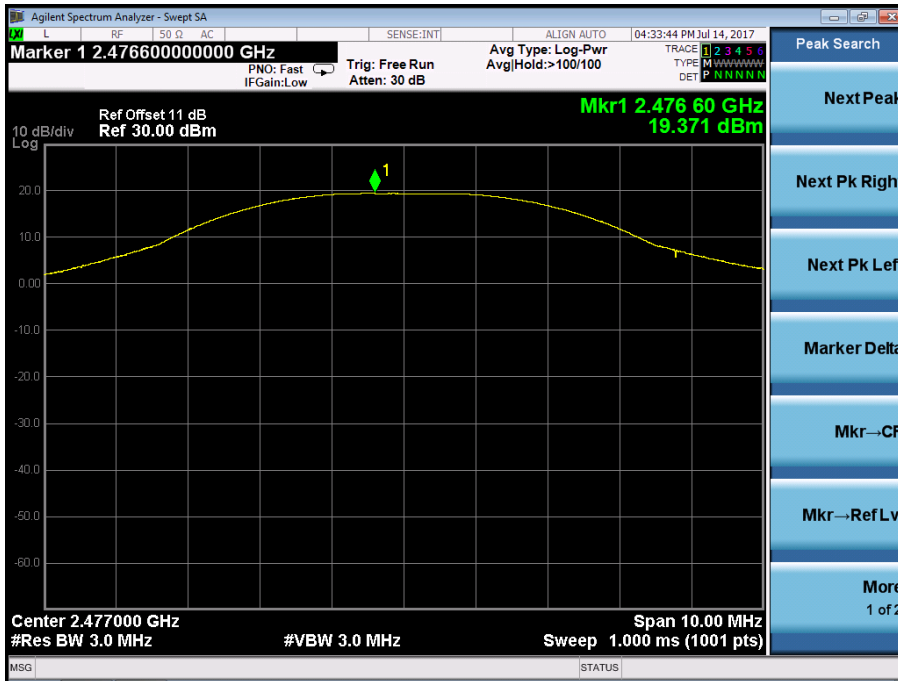

Test Model

Max Peak Power
Channel 40: 2440MHz

GFSK Modulation

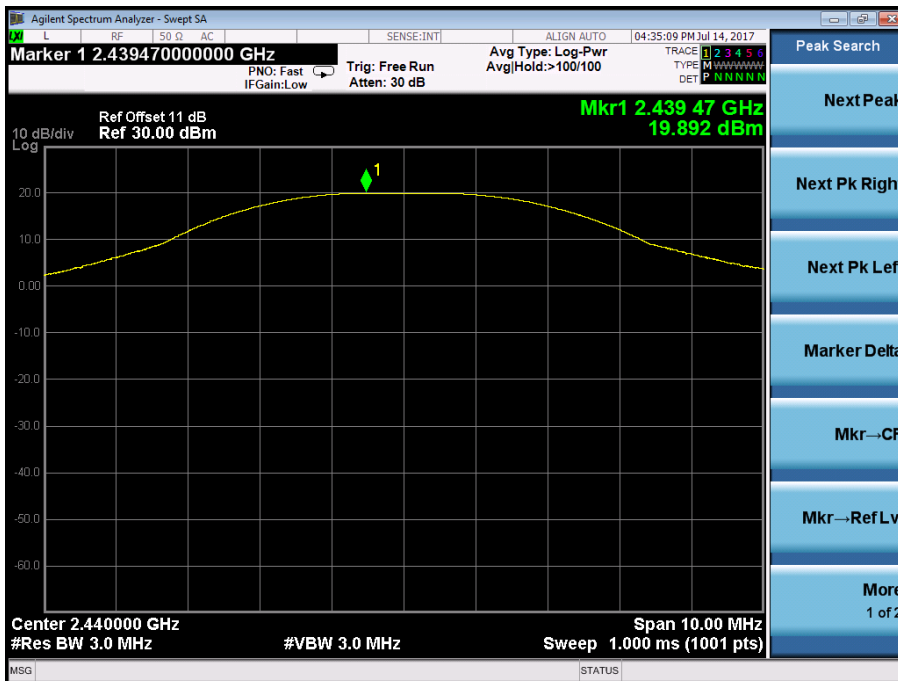

Test Model Max Peak Power
Channel 77: 2477MHz GFSK Modulation

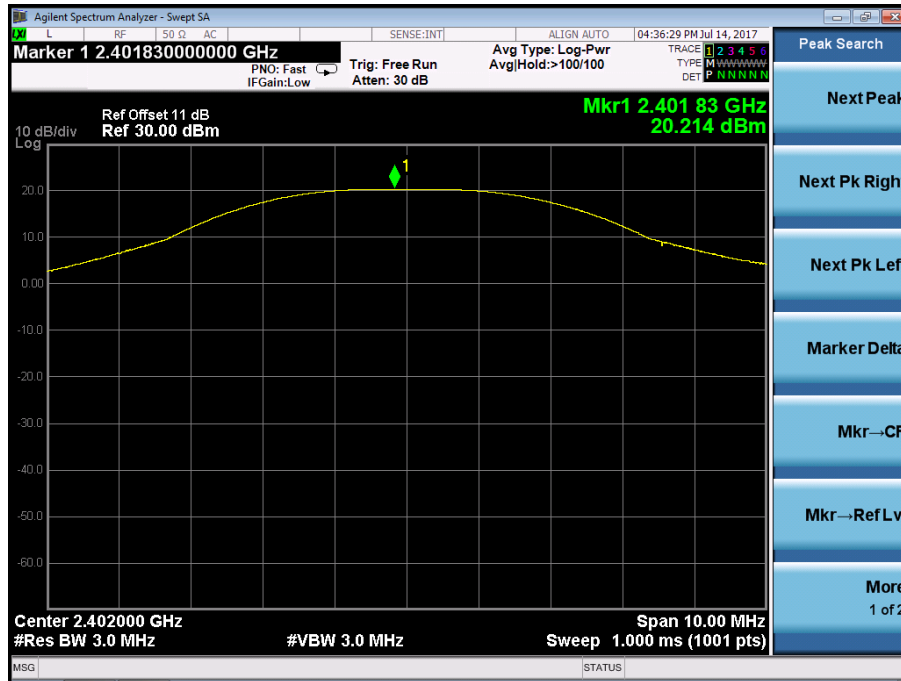

8.7 CONDUCTED SUPRIIOUS EMISSION

8.7.1 Applicable Standard

According to FCC Part 15.247(d) and RSS-Gen Clause 8.8

8.7.2 Conformance Limit

According to FCC Part 15.247(d) and RSS-Gen Clause 8.8

In any 100 kHz bandwidth outside the frequency band in which the spread spectrum intentional radiator is operating, the radio frequency power that is produced by the intentional radiator shall be at least 20 dB below that in the 100 kHz bandwidth within the band that contains the highest level of the desired power, based on either an RF conducted, provided the transmitter demonstrates compliance with the peak conducted power limits.

8.7.3 Test Configuration

Test according to clause 7.1 radio frequency test setup 1

8.7.4 Test Procedure

The transmitter output (antenna port) was connected to the spectrum analyzer

■ Reference level measurement

Establish a reference level by using the following procedure:

Set instrument center frequency to DSS channel center frequency.

Set Span = approximately 5 times the 20 dB bandwidth, centered on a hopping channel.

Set the RBW = 100 kHz. Set the VBW $\geq 3 \times$ RBW.

Set Detector = peak. Set Sweep time = auto couple.

Set Trace mode = max hold. Allow trace to fully stabilize.

Use the peak marker function to determine the maximum Maximum conduceted level.

Note that the channel found to contain the maximum conduceted level can be used to establish the reference level.

■ Band-edge Compliance of RF Conducted Emissions

Use the following spectrum analyzer settings:

Span = wide enough to capture the peak level of the emission operating on the channel closest to the band-edge, as well as any modulation products which fall outside of the authorized band of operation

Set RBW $\geq 1\%$ of the span=100kHz Set VBW \geq RBW

Set Sweep = auto Set Detector function = peak Set Trace = max hold

Allow the trace to stabilize. Set the marker on the emission at the bandedge, or on the highest modulation product outside of the band, if this level is greater than that at the bandedge. Enable the marker-delta function, then use the marker-to-peak function to move the marker to the peak of the in-band emission.

The marker-delta value now displayed must comply with the limit specified in this Section.

Now, using the same instrument settings, enable the hopping function of the EUT. Allow the trace to stabilize. Follow the same procedure listed above to determine if any spurious emissions caused by the hopping function also comply with the specified limit.

■ Conduceted Spurious RF Conducted Emission

Use the following spectrum analyzer settings:

Span = wide enough to capture the peak level of the in-band emission and all spurious emissions (e.g., harmonics) from the lowest frequency generated in the EUT up through the 10th harmonic.(30MHz to 25GHz). Set RBW = 100 kHz Set VBW \geq RBW

Set Sweep = auto Set Detector function = peak Set Trace = max hold

Allow the trace to stabilize. Set the marker on the peak of any spurious emission recorded. The level displayed must comply with the limit specified in this Section.

8.7.5 Test Results

All Adapter have been tested, and the worst result(Adapter 1) was report as below:

Test Model Maximum Conduceted Level RBW=100kHz
Channel 02: 2402MHz GFSK Modulation

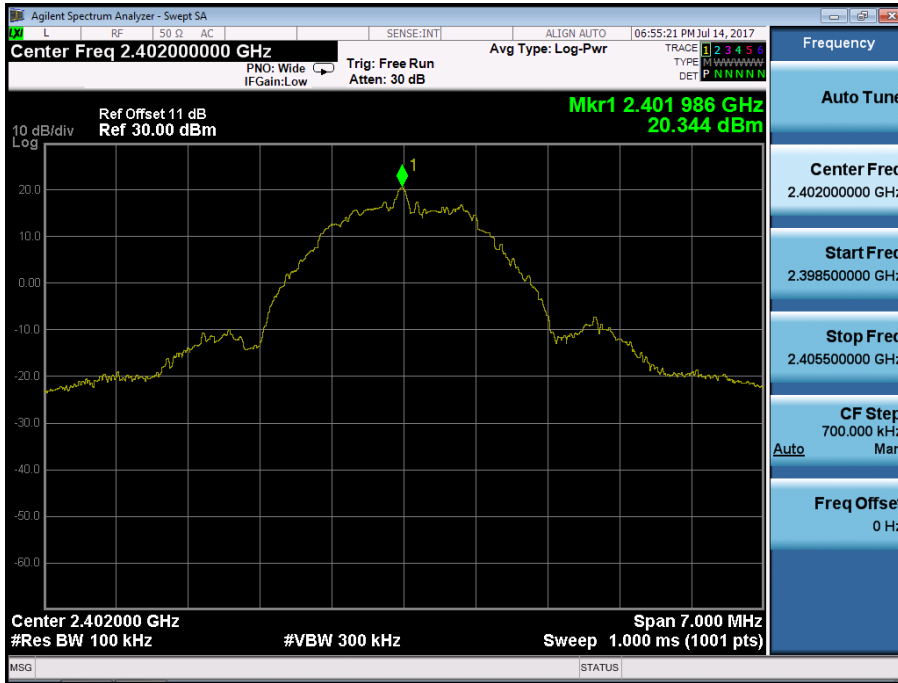

Test Model Conduceted Spurious RF Conducted Emission
Channel 02: 2402MHz GFSK Modulation



Test Model

Band-edge Conducted Emissions
Channel 02: 2402MHz

GFSK Modulation

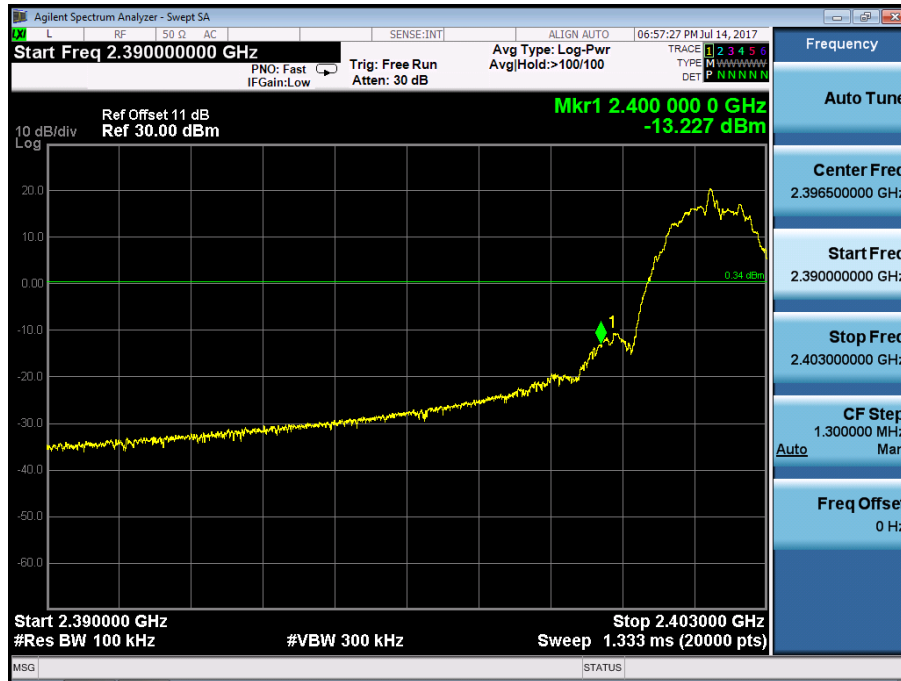

Test Model

Maximum Conduceted Level RBW=100kHz

Channel 40: 2440MHz

GFSK Modulation

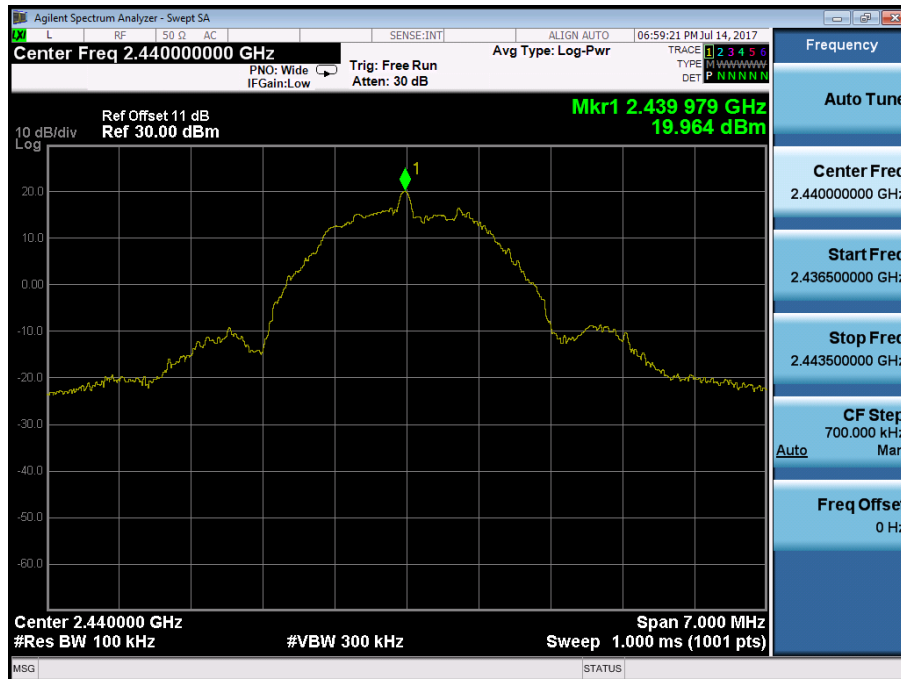

Test Model

Conduceted Spurious RF Conducted Emission
Channel 40: 2440MHz
GFSK Modulation



Test Model

Maximum Conduceted Level RBW=100kHz
Channel 77: 2477MHz
GFSK Modulation

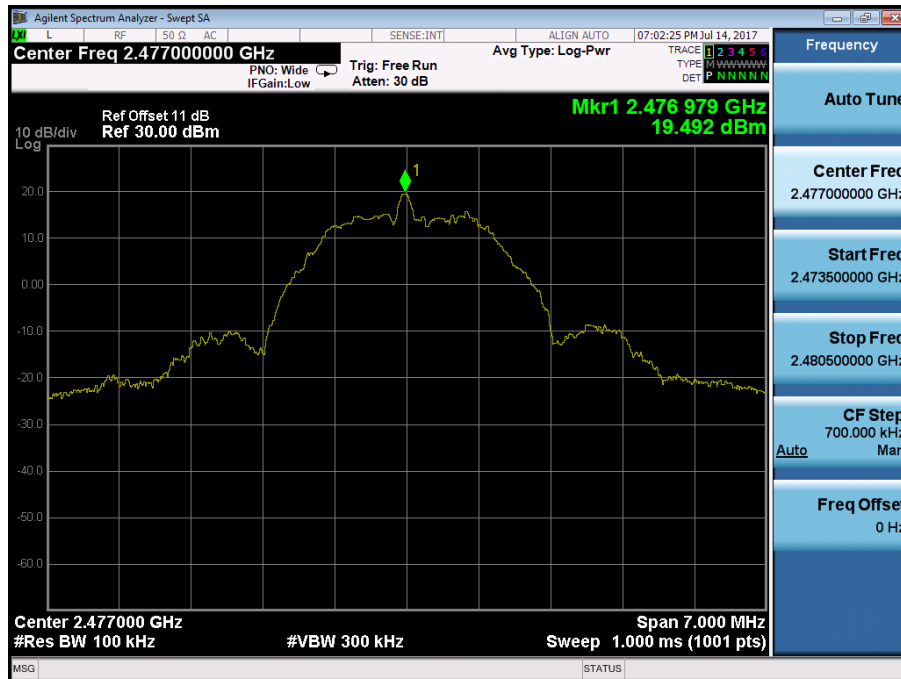

Test Model

Conducted Spurious RF Conducted Emission
Channel 77: 2477MHz
GFSK Modulation



Test Model

Band-edge Conducted Emissions
Channel 77: 2477MHz
GFSK Modulation

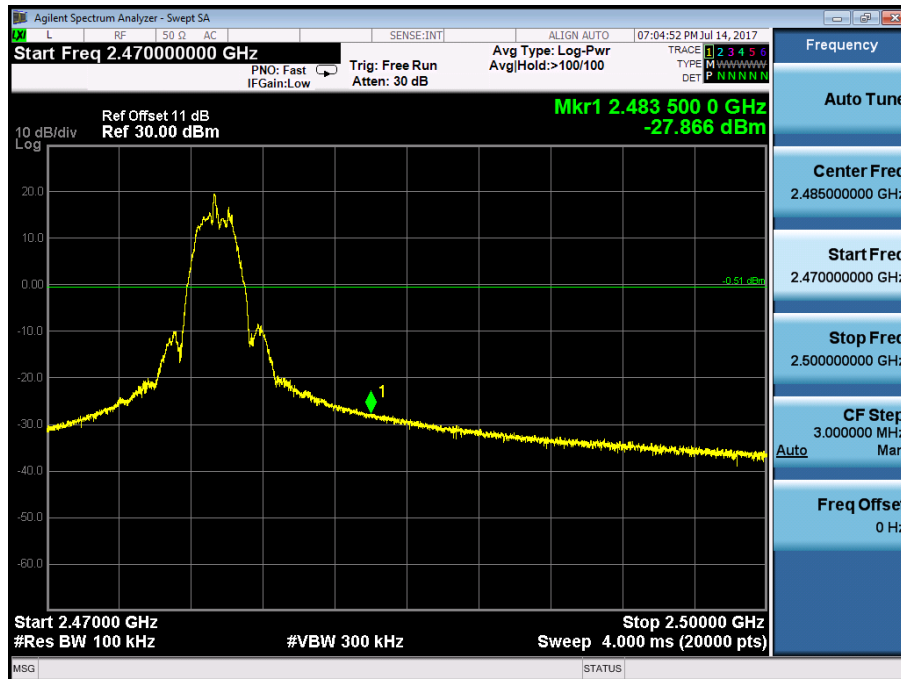

Test Model

Maximum Conducted Level RBW=100kHz
Hopping

GFSK Modulation

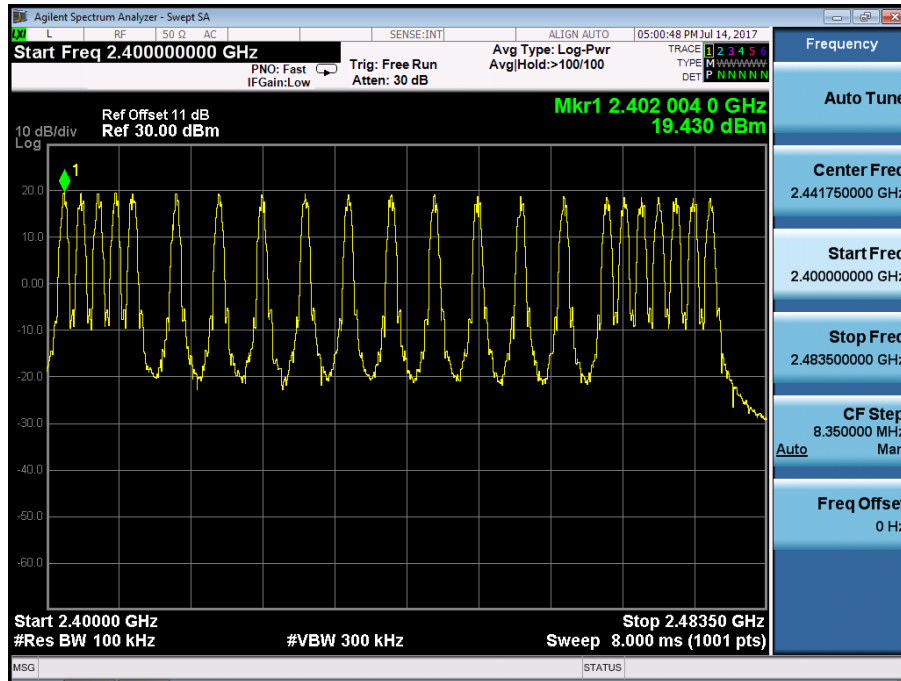

Test Model

Conducted Spurious RF Conducted Emission
Hopping

GFSK Modulation



Test Model

Band-edge Conducted Emissions
Hopping

GFSK Modulation

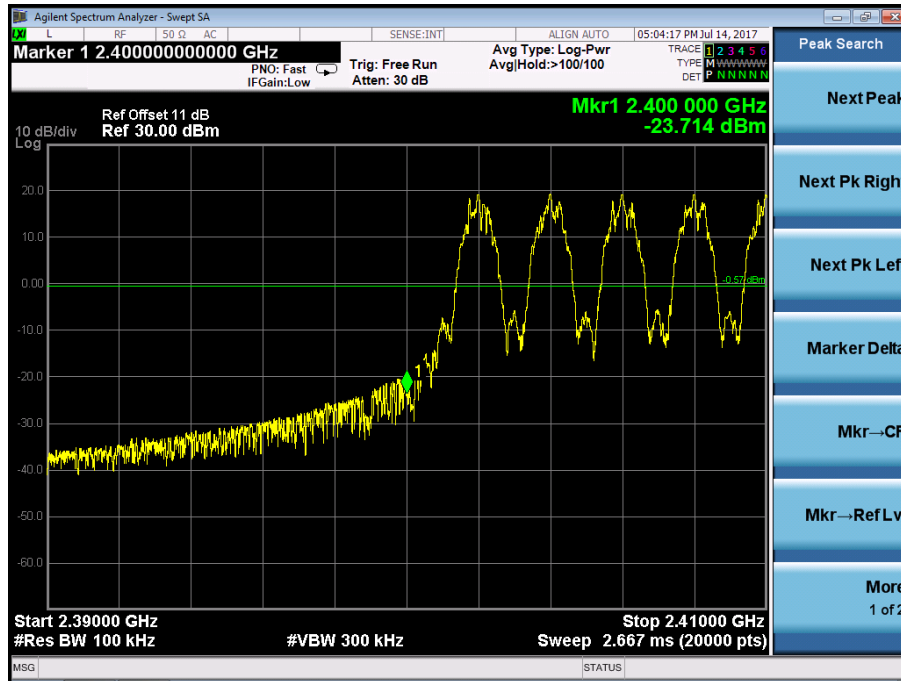

Test Model

Band-edge Conducted Emissions
Hopping

GFSK Modulation

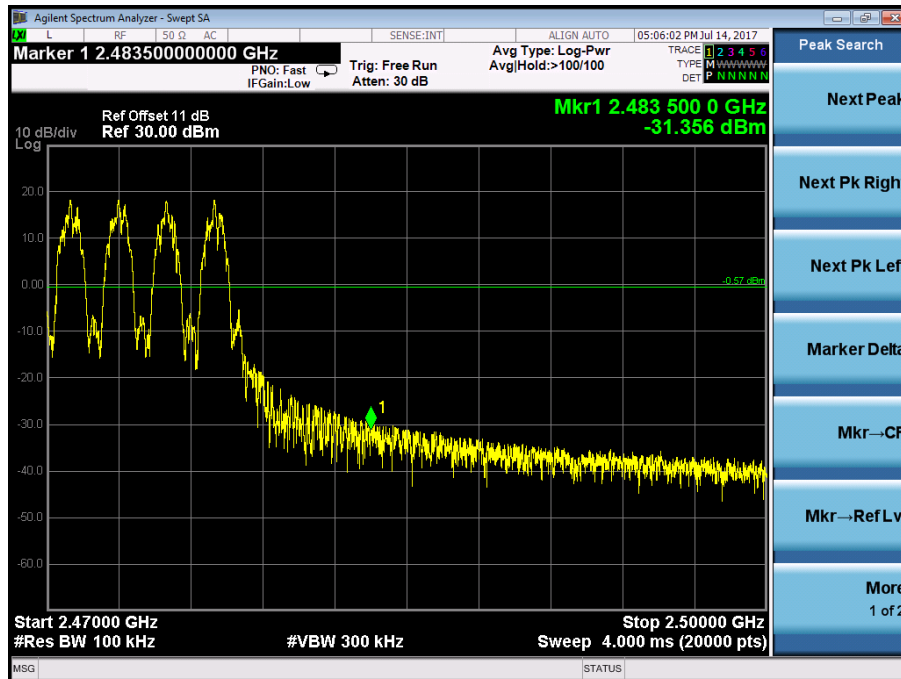

8.8 RADIATED SPURIOUS EMISSION

8.8.1 Applicable Standard

According to FCC Part 15.247(d), 15.209 and RSS-247 Clause 3.3

8.8.2 Conformance Limit

According to FCC Part 15.247(d): radiated emissions which fall in the restricted bands, as defined in §15.205(a), must also comply with the radiated emission limits specified in §15.209(a) (see §15.205(c)).
According to FCC Part 15.205, Restricted bands

MHz	MHz	MHz	GHz
0.090-0.110	16.42-16.423	399.9-410	4.5-5.15
10.495-0.505	16.69475-16.69525	608-614	5.35-5.46
2.1735-2.1905	16.80425-16.80475	960-1240	7.25-7.75
4.125-4.128	25.5-25.67	1300-1427	8.025-8.5
4.17725-4.17775	37.5-38.25	1435-1626.5	9.0-9.2
4.20725-4.20775	73-74.6	1645.5-1646.5	9.3-9.5
6.215-6.218	74.8-75.2	1660-1710	10.6-12.7
6.26775-6.26825	123-138	2200-2300	14.47-14.5
8.291-8.294	149.9-150.05	2310-2390	15.35-16.2
8.362-8.366	156.52475-156.52525	2483.5-2500	17.7-21.4
8.37625-8.38675	156.7-156.9	2690-2900	22.01-23.12
8.41425-8.41475	162.0125-167.17	3260-3267	23.6-24.0
12.29-12.293	167.72-173.2	3332-3339	31.2-31.8
12.51975-12.52025	240-285	3345.8-3358	36.43-36.5
12.57675-12.57725	322-335.4	3600-4400	(2)
13.36-13.41			

According to FCC Part 15.205, the level of any transmitter spurious emission in Restricted bands shall not exceed the level of the emission specified in the following table

Restricted Frequency(MHz)	Field Strength ($\mu\text{V/m}$)	Field Strength ($\text{dB}\mu\text{V/m}$)	Measurement Distance
0.009-0.490	2400/F(KHz)	20 log ($\mu\text{V/m}$)	300
0.490-1.705	24000/F(KHz)	20 log ($\mu\text{V/m}$)	30
1.705-30	30	29.5	30
30-88	100	40	3
88-216	150	43.5	3
216-960	200	46	3
Above 960	500	54	3

8.8.3 Test Configuration

Test according to clause 7.2 radio frequency test setup 2

8.8.4 Test Procedure

This test is required for any spurious emission that falls in a Restricted Band, as defined in Section 15.205. It must be performed with the highest gain of each type of antenna proposed for use with the EUT. Use the following spectrum analyzer settings:

For Above 1GHz:

The EUT was placed on a turn table which is 0.1m above ground plane.

Maximum procedure was performed on the highest emissions to ensure EUT compliance.

Span = wide enough to fully capture the emission being measured

RBW = 1 MHz

VBW \geq RBW

Sweep = auto

Detector function = peak

Trace = max hold

For Below 1GHz:

The EUT was placed on a turn table which is 0.1m above ground plane.

Maximum procedure was performed on the highest emissions to ensure EUT compliance.

Span = wide enough to fully capture the emission being measured

RBW = 100 kHz for

VBW ≥ RBW

Sweep = auto

Detector function = peak

Trace = max hold

For Below 30MHz:

The EUT was placed on a turn table which is 0.1m above ground plane.

Maximum procedure was performed on the highest emissions to ensure EUT compliance.

Span = wide enough to fully capture the emission being measured

RBW = 9kHz

VBW ≥ RBW

Sweep = auto

Detector function = peak

Trace = max hold

For Below 150KHz:

The EUT was placed on a turn table which is 0.1m above ground plane.

Maximum procedure was performed on the highest emissions to ensure EUT compliance.

Span = wide enough to fully capture the emission being measured

RBW = 200Hz

VBW ≥ RBW

Sweep = auto

Detector function = peak

Trace = max hold

Follow the guidelines in ANSI C63.10-2013 with respect to maximizing the emission by rotating the EUT, measuring the emission while the EUT is situated in three orthogonal planes (if appropriate), adjusting the measurement antenna height and polarization, etc. A pre-amp and a high pass filter are required for this test, in order to provide the measuring system with sufficient sensitivity. Allow the trace to stabilize. The peak reading of the emission, after being corrected by the antenna factor, cable loss, pre-amp gain, etc., is the peak field strength, which must comply with the limit specified in Section 15.35(b). Submit this data.

Now set the VBW to 10 Hz, while maintaining all of the other instrument settings. This peak level, once corrected, must comply with the limit specified in Section 15.209. If the dwell time per channel of the hopping signal is less than 100 ms, then the reading obtained with the 10 Hz VBW may be further adjusted by a “duty cycle correction factor”, derived from $20\log(\text{dwell time}/100 \text{ ms})$, in an effort to demonstrate compliance with the 15.209 limit. Submit this data.

Repeat above procedures until all frequency measured was complete.

8.8.5 Test Results

■ Spurious Emission below 30MHz (9KHz to 30MHz)

Temperature:	24°C	Test Date:	May 05, 2017
Humidity:	53 %	Test By:	KK
Test mode:	TX Mode		

Freq. (MHz)	Ant.Pol. H/V	Emission Level(dBuV/m)		Limit 3m(dBuV/m)		Over(dB)	
		PK	AV	PK	AV	PK	AV
--	--	--	--	--	--	--	--

Note: the amplitude of spurious emission that is attenuated by more than 20dB below the permissible limit has no need to be reported.

Distance extrapolation factor = $40\log(\text{Specific distance}/ \text{test distance})(\text{dB})$;

Limit line=Specific limits(dBuV) + distance extrapolation factor

■ Spurious Emission Above 1GHz (1GHz to 25GHz)

Temperature:	24°C	Test Date:	May 05, 2017
Humidity:	53 %	Test By:	King Kong
Test mode:	GFSK Modulation	Frequency:	Channel 02: 2402MHz

Freq. (MHz)	Ant.Pol. H/V	Emission Level(dBuV/m)		Limit 3m(dBuV/m)		Over(dB)	
		PK	AV	PK	AV	PK	AV
16079	V	50.48	35.20	74.00	54.00	-23.52	-18.8
23593	V	49.36	33.20	74.00	54.00	-24.64	-20.8
15943	H	50.75	35.70	74.00	54.00	-23.25	-18.3
25820	H	50.20	35.70	74.00	54.00	-23.8	-18.3

Temperature:	24°C	Test Date:	May 05, 2017
Humidity:	53 %	Test By:	King Kong
Test mode:	GFSK Modulation	Frequency:	Channel 40: 2440MHz

Freq. (MHz)	Ant.Pol. H/V	Emission Level(dBuV/m)		Limit 3m(dBuV/m)		Over(dB)	
		PK	AV	PK	AV	PK	AV
13342	V	51.98	36.40	74.00	54.00	-22.02	-17.6
26245	V	50.77	35.20	74.00	54.00	-23.23	-18.8
14940	H	51.40	36.20	74.00	54.00	-22.60	-17.8
25004	H	50.33	35.20	74.00	54.00	-23.67	-18.8

Temperature:	24°C	Test Date:	May 05, 2017
Humidity:	53 %	Test By:	King Kong
Test mode:	GFSK Modulation	Frequency:	Channel 77: 2477MHz

Freq. (MHz)	Ant.Pol. H/V	Emission Level(dBuV/m)		Limit 3m(dBuV/m)		Over(dB)	
		PK	AV	PK	AV	PK	AV
16844	V	52.27	36.40	74.00	54.00	-21.73	-17.6
24528	V	50.28	35.20	74.00	54.00	-23.72	-18.8
14328	H	50.36	35.20	74.00	54.00	-23.64	-18.8
24902	H	49.33	23.40	74.00	54.00	-24.67	-30.6

- Note:** (1) All Readings are Peak Value (VBW=3MHz) and Average Value (VBW=10Hz).
 (2) Emission Level= Reading Level+Probe Factor +Cable Loss.
 (3) Data of measurement within this frequency range shown " -- " in the table above means the reading of emissions are attenuated more than 20dB below the permissible limits or the field strength is too small to be measured.

■ Spurious Emission in Restricted Band 2310-2390MHz and 2483.5-2500MHz

Temperature:	24°C	Test Date:	May 08, 2017
Humidity:	53 %	Test By:	King Kong
Test mode:	GFSK Modulation	Frequency:	Channel 02: 2402MHz

Frequency (MHz)	Polarity H/V	PK(dBuV/m) (VBW=3MHz)	Limit 3m (dBuV/m)	Over(dB)	AV(dBuV/m) (VBW=3MHz)	Limit 3m (dBuV/m)	Over(dB)
2388.40	H	55.82	74.00	-18.18	41.20	54.00	-12.80
2388.88	V	52.65	74.00	-21.35	38.40	54.00	-15.60

Temperature:	24°C	Test Date:	May 08, 2017
Humidity:	53 %	Test By:	King Kong
Test mode:	GFSK Modulation	Frequency:	Channel 77: 2477MHz

Frequency (MHz)	Polarity H/V	PK(dBuV/m) (VBW=3MHz)	Limit 3m (dBuV/m)	Over(dB)	AV(dBuV/m) (VBW=3MHz)	Limit 3m (dBuV/m)	Over(dB)
2483.863	H	58.66	74.00	-15.34	43.40	54.00	-10.60
2483.863	V	51.88	74.00	-22.12	36.90	54.00	-17.10

Temperature:	24°C	Test Date:	May 08, 2017
Humidity:	53 %	Test By:	KK
Test mode:	GFSK Modulation	Frequency:	Hopping

Frequency (MHz)	Polarity H/V	PK(dBuV/m) (VBW=3MHz)	Limit 3m (dBuV/m)	Over(dB)	AV(dBuV/m) (VBW=3MHz)	Limit 3m (dBuV/m)	Over(dB)
2390.56	H	46.24	74.00	-27.76	34.25	54.00	-19.75
2360.92	V	47.98	74.00	-26.02	34.28	54.00	-19.72
2492.21	H	49.36	74.00	-24.64	36.97	54.00	-17.03
2483.50	V	55.97	74.00	-18.03	41.29	54.00	-12.71

- Note:**
- (1) All Readings are Peak Value (VBW=3MHz) and Average Value (VBW=10Hz).
 - (2) Emission Level= Reading Level+Probe Factor +Cable Loss.
 - (3) Data of measurement within this frequency range shown “ -- ” in the table above means the reading of emissions are attenuated more than 20dB below the permissible limits or the field strength is too small to be measured.

Test Model	Spurious Emission in Restricted Band 2310-2390MHz		
	Channel 02: 2402MHz	GFSK Modulation	H
	Test By: King Kong		

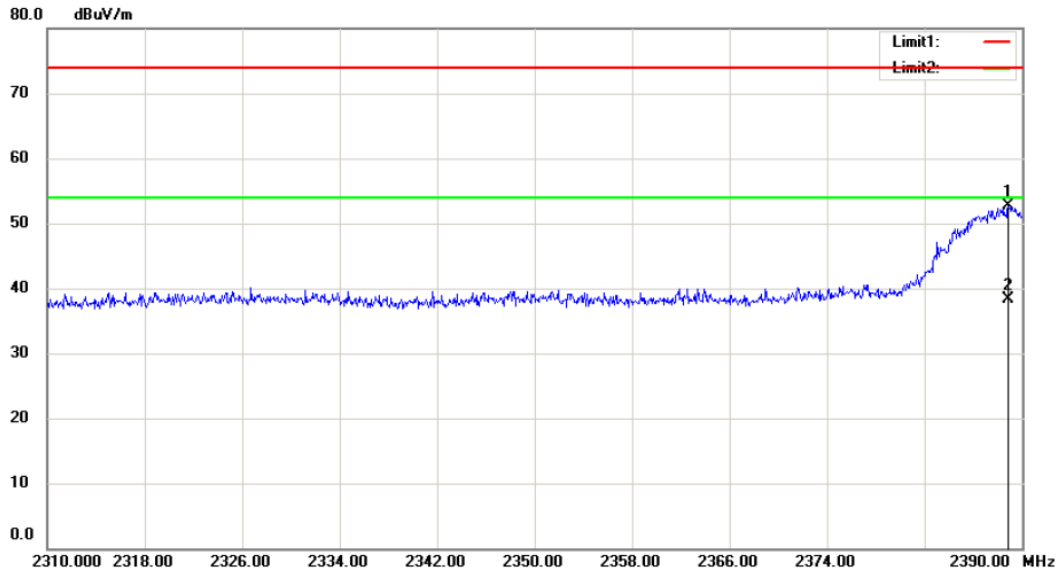

Test Model	Spurious Emission in Restricted Band 2310-2390MHz /v3.0		
	Channel 02: 2402MHz	GFSK Modulation	V
	Test By: King Kong		

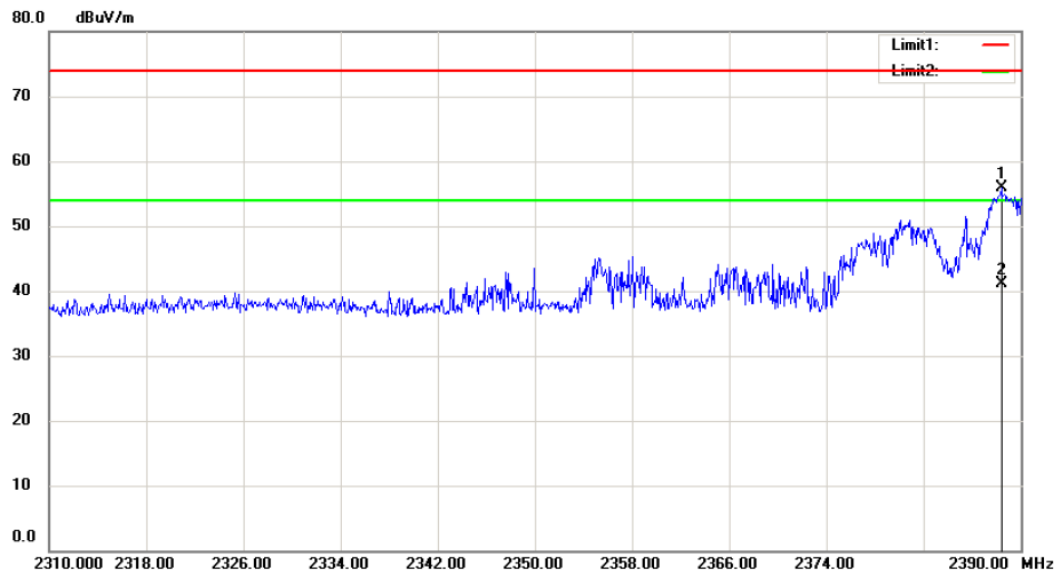

Test Model Spurious Emission in Restricted Band 2483.5-2500MHz
Channel 77: 2477MHz GFSK Modulation H
Test By: King Kong

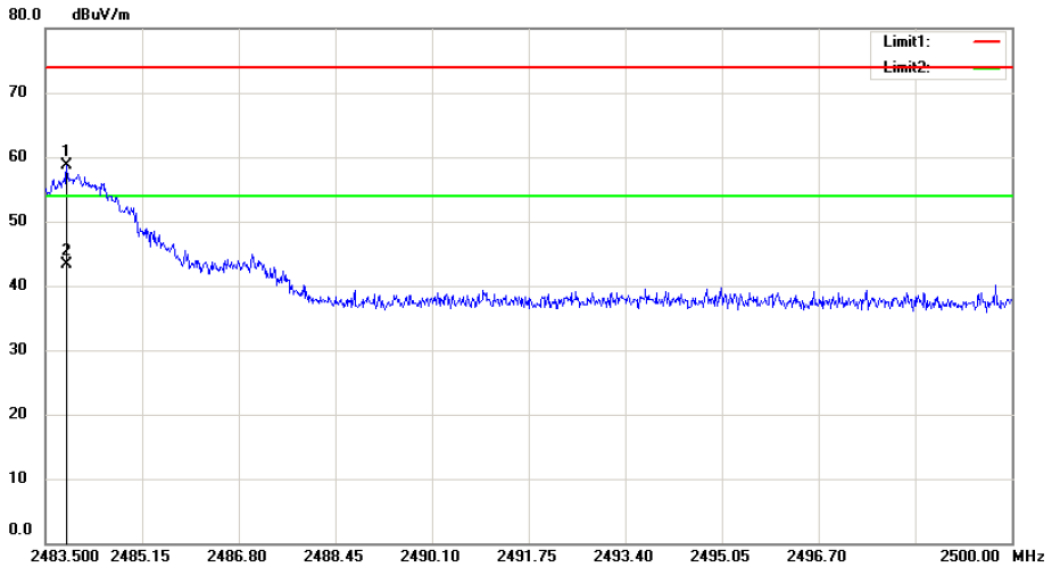

Test Model Spurious Emission in Restricted Band 2483.5-2500MHz
Channel 77: 2477MHz GFSK Modulation V
Test By: King Kong

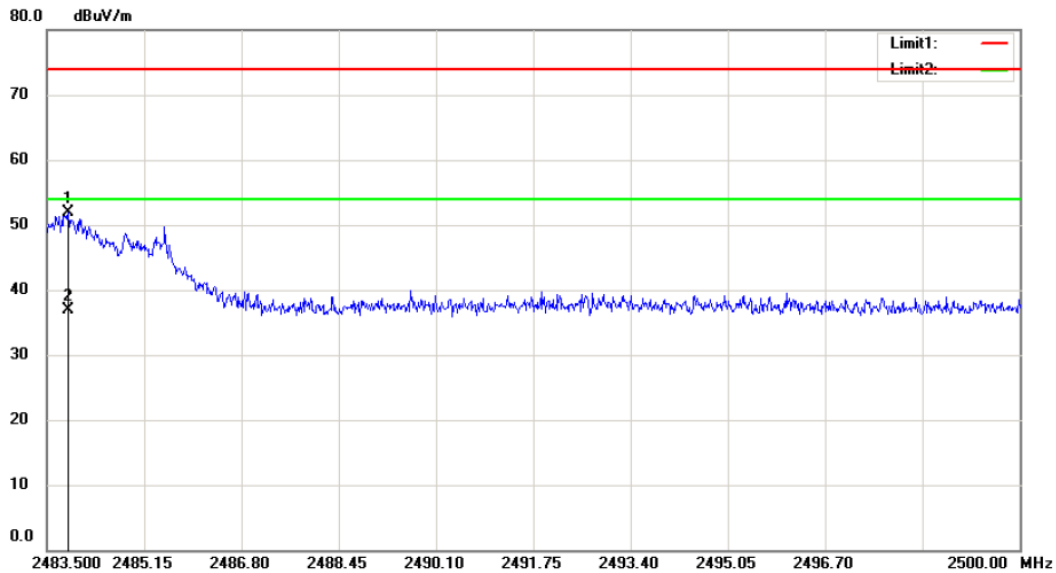

Spurious Emission in Restricted Band 2310-2390&2483.5-2500MHz
 Test Model Hopping GFSK Modulation H
 Test By: King Kong

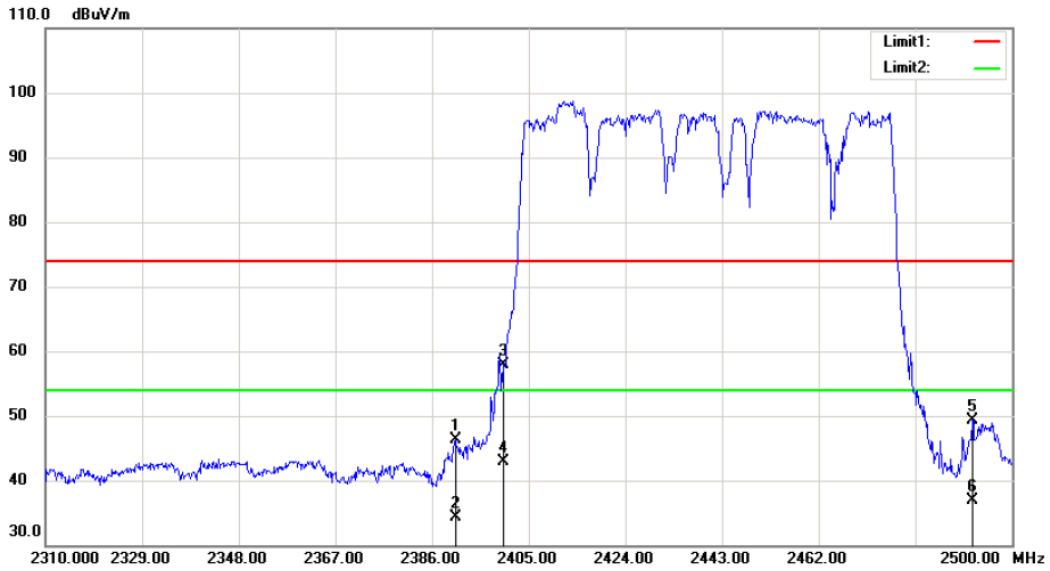

Spurious Emission in Restricted Band 2310-2390&2483.5-2500MHz
 Test Model Hopping GFSK Modulation V
 Test By: King Kong

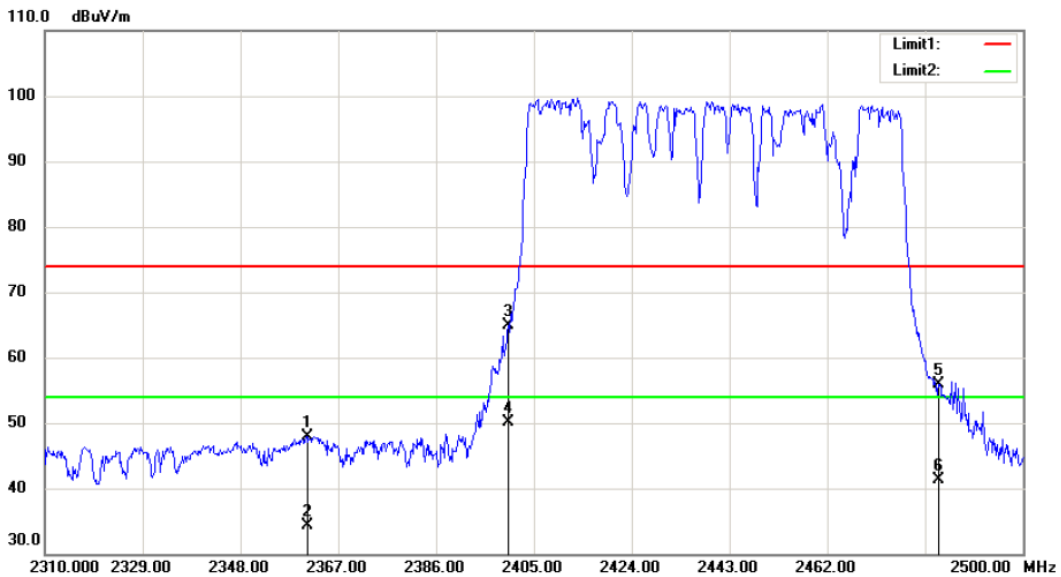

■ Spurious Emission below 1GHz (30MHz to 1GHz)

All Adapter have been tested, and the worst result(Adapter 1) was report as below:

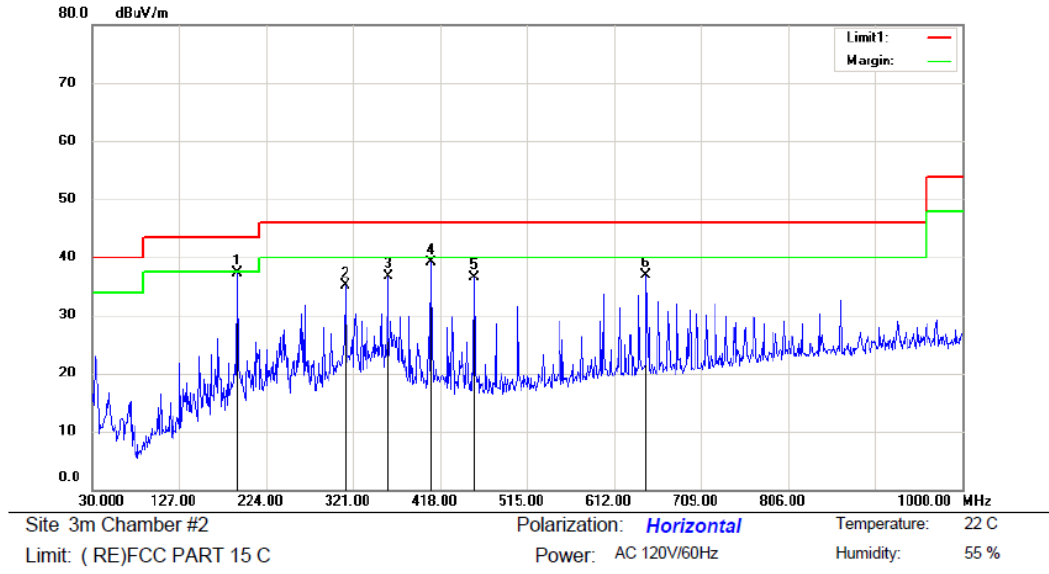

Mode: TX 2402
Note: PU(Tenpao)

No.	Mk.	Freq. MHz	Reading Level dBuV	Correct Factor dB	Measure- ment dBuV/m	Limit dBuV/m	Over dB	Antenna Height cm	Table Degree degree	Detector	Comment
1	*	191.9900	53.19	-15.79	37.40	43.50	-6.10	QP			
2		312.2700	45.83	-10.80	35.03	46.00	-10.97	QP			
3		359.8000	45.98	-9.18	36.80	46.00	-9.20	QP			
4		408.3000	47.49	-8.37	39.12	46.00	-6.88	QP			
5		455.8300	44.37	-7.81	36.56	46.00	-9.44	QP			
6		647.8900	40.66	-3.70	36.96	46.00	-9.04	QP			

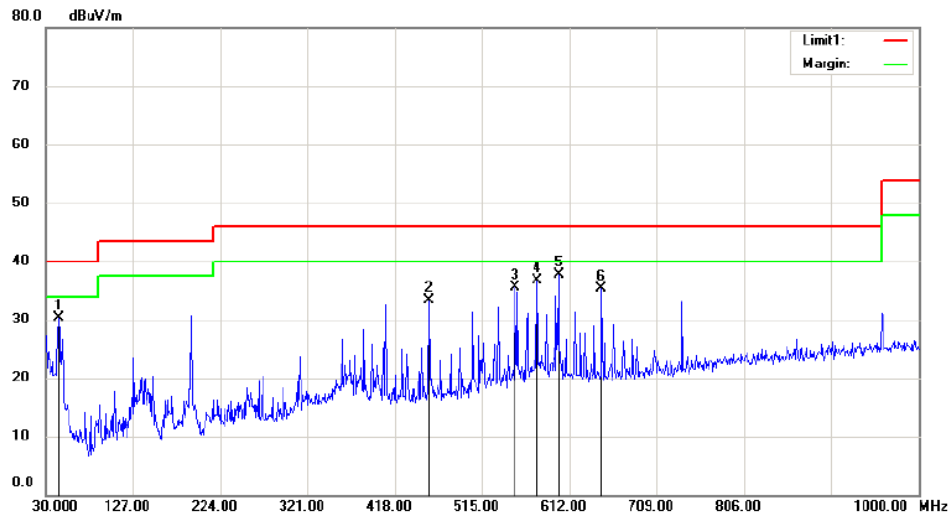

Site 3m Chamber #2 Polarization: **Vertical** Temperature: 22 C
 Limit: (RE)FCC PART 15 C Power: AC 120V/60Hz Humidity: 55 %

Mode: TX 2402
 Note: PU(Tenpao)

No.	Mk.	Freq.	Reading Level	Correct Factor	Measurement	Limit	Over	Antenna Height	Table Degree	
		MHz	dBuV	dB	dBuV/m	dBuV/m	dB	cm	degree	Comment
1		44.5500	44.03	-13.66	30.37	40.00	-9.63	QP		
2		455.8300	41.17	-7.81	33.36	46.00	-12.64	QP		
3		551.8600	41.14	-5.55	35.59	46.00	-10.41	QP		
4		576.1100	41.62	-4.99	36.63	46.00	-9.37	QP		
5	*	600.3600	42.20	-4.44	37.76	46.00	-8.24	QP		
6		647.8900	38.94	-3.70	35.24	46.00	-10.76	QP		

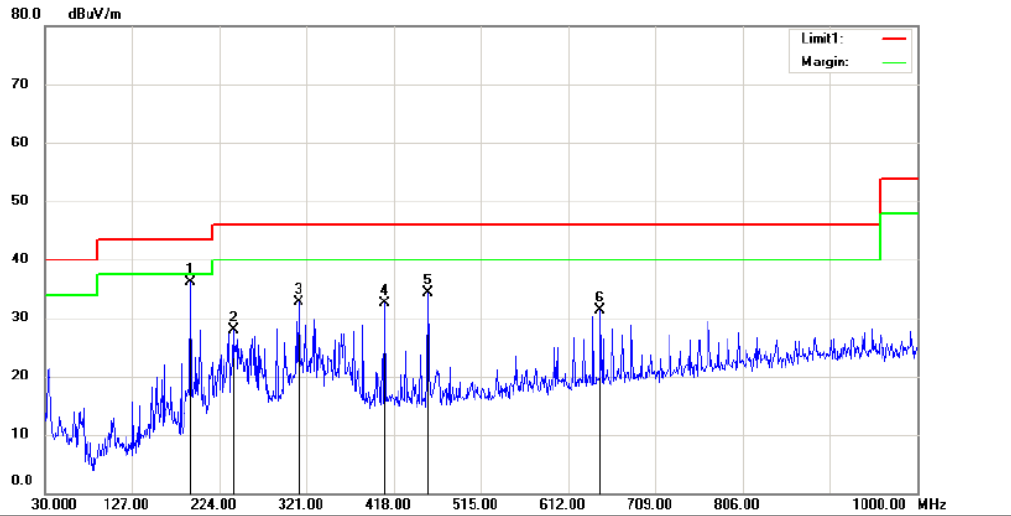

Site: 3m Chamber #2 Polarization: *Horizontal* Temperature: 22 C
 Limit: (RE)FCC PART 15 C Power: AC 120V/60Hz Humidity: 55 %

Mode: TX 2440
 Note: PU(Tenpao)

No.	Mk.	Freq.	Reading Level	Correct Factor	Measurement	Limit	Over	Antenna Height	Table Degree	
		MHz	dBuV	dB	dBuV/m	dBuV/m	dB	cm	degree	Comment
1	*	191.9900	51.94	-15.79	36.15	43.50	-7.35	QP		
2		239.5200	41.22	-13.32	27.90	46.00	-18.10	QP		
3		312.2700	43.52	-10.80	32.72	46.00	-13.28	QP		
4		408.3000	40.96	-8.37	32.59	46.00	-13.41	QP		
5		455.8300	42.20	-7.81	34.39	46.00	-11.61	QP		
6		647.8900	35.04	-3.70	31.34	46.00	-14.66	QP		

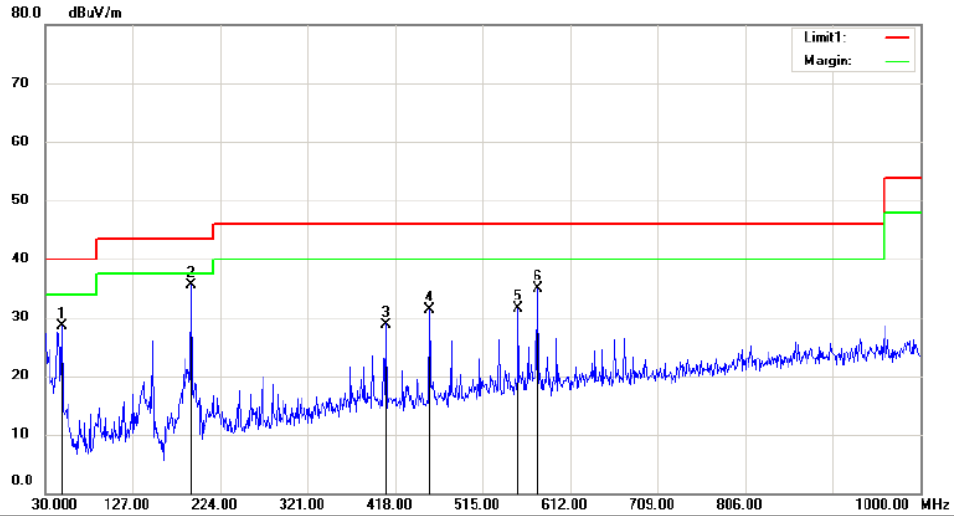

Site: 3m Chamber #2 Polarization: **Vertical** Temperature: 22 C
 Limit: (RE)FCC PART 15 C Power: AC 120V/60Hz Humidity: 55 %

Mode: TX 2440
 Note: PU(Tenpao)

No.	Mk.	Freq. MHz	Reading Level dBuV	Correct Factor dB	Measure- ment dBuV/m	Limit dBuV/m	Over dB	Antenna Height cm	Table Degree	Detector	Comment
1		48.4300	41.70	-13.12	28.58	40.00	-11.42			QP	
2	*	191.9900	51.35	-15.79	35.56	43.50	-7.94			QP	
3		408.3000	37.17	-8.37	28.80	46.00	-17.20			QP	
4		455.8300	39.16	-7.81	31.35	46.00	-14.65			QP	
5		554.7700	36.90	-5.48	31.42	46.00	-14.58			QP	
6		576.1100	39.93	-4.99	34.94	46.00	-11.06			QP	

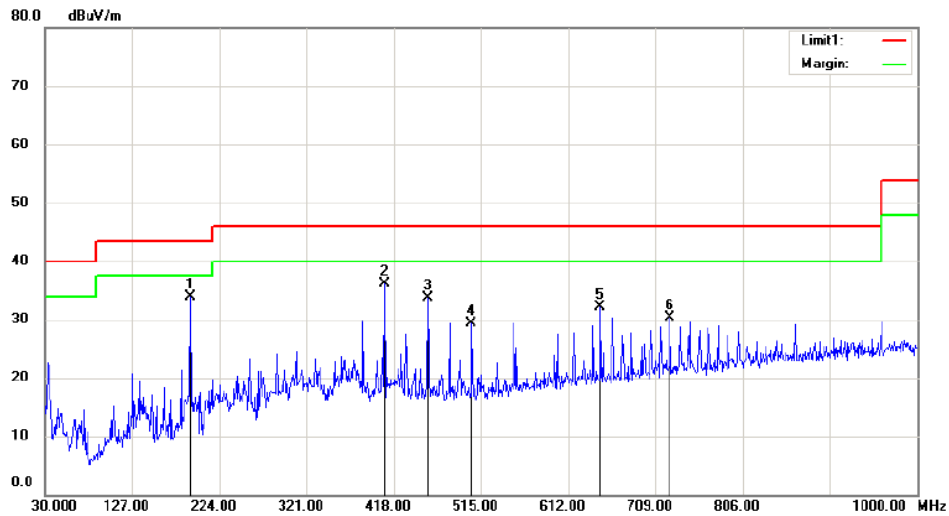

Site 3m Chamber #2 Polarization: *Horizontal* Temperature: 22 C
 Limit: (RE)FCC PART 15 C Power: AC 120V/60Hz Humidity: 55 %

Mode: TX 2477
 Note: PU(Tenpao)

No.	Mk.	Freq.	Reading Level	Correct Factor	Measurement	Limit	Over	Antenna Height	Table Degree	Comment
		MHz	dBuV	dB	dBuV/m	dBuV/m	dB	cm	degree	
1	*	191.9900	49.63	-15.79	33.84	43.50	-9.66	QP		
2		408.3000	44.46	-8.37	36.09	46.00	-9.91	QP		
3		455.8300	41.43	-7.81	33.62	46.00	-12.38	QP		
4		504.3300	35.95	-6.64	29.31	46.00	-16.69	QP		
5		647.8900	35.75	-3.70	32.05	46.00	-13.95	QP		
6		725.4900	32.82	-2.45	30.37	46.00	-15.63	QP		

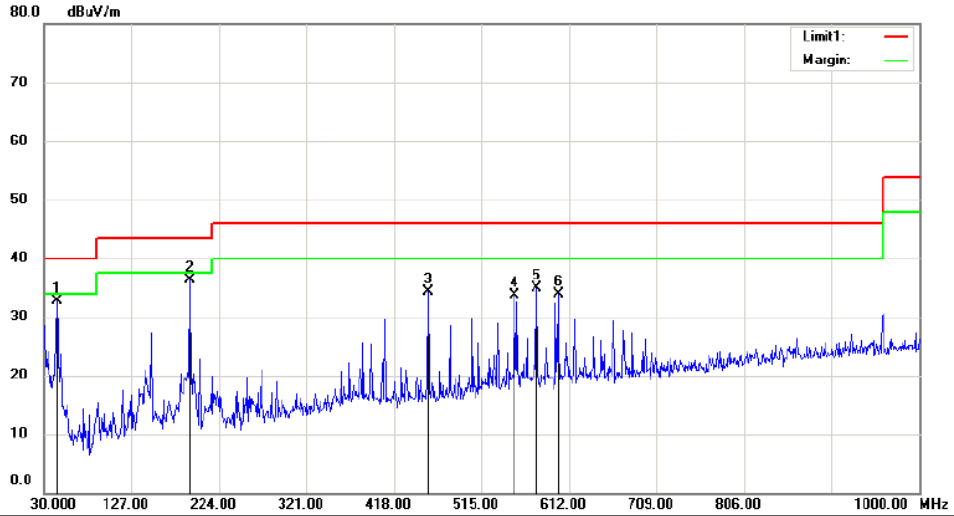

Site 3m Chamber #2 Polarization: *Vertical* Temperature: 22 C
 Limit: (RE)FCC PART 15 C Power: AC 120V/60Hz Humidity: 55 %

Mode: TX 2477
 Note: PU(Tenpao)

No.	Mk.	Freq.	Reading Level	Correct Factor	Measurement	Limit	Over	Antenna Height	Table Degree	Detector	Comment
		MHz	dBuV	dB	dBuV/m	dBuV/m	dB	cm	degree		
1		44.5500	46.31	-13.66	32.65	40.00	-7.35	QP			
2	*	191.9900	52.15	-15.79	36.36	43.50	-7.14	QP			
3		455.8300	42.12	-7.81	34.31	46.00	-11.69	QP			
4		551.8600	39.34	-5.55	33.79	46.00	-12.21	QP			
5		576.1100	39.92	-4.99	34.93	46.00	-11.07	QP			
6		600.3600	38.31	-4.44	33.87	46.00	-12.13	QP			

8.9 CONDUCTED EMISSION TEST

8.9.1 Applicable Standard

According to FCC Part 15.207(a) and RSS-Gen Clause 8.8

8.9.2 Conformance Limit

Conducted Emission Limit		
Frequency(MHz)	Quasi-peak	Average
0.15-0.5	66-56	56-46
0.5-5.0	56	46
5.0-30.0	60	50

Note: 1. The lower limit shall apply at the transition frequencies
 2. The limit decreases in line with the logarithm of the frequency in the range of 0.15 to 0.50MHz.

8.9.3 Test Configuration

Test according to clause 7.3 conducted emission test setup

8.9.4 Test Procedure

The EUT was placed on a table which is 0.1m above ground plane.
 Maximum procedure was performed on the highest emissions to ensure EUT compliance.
 Repeat above procedures until all frequency measured were complete.

8.9.5 Test Results

Pass

We test the EUT at 120V, and show the worst result as bellow.

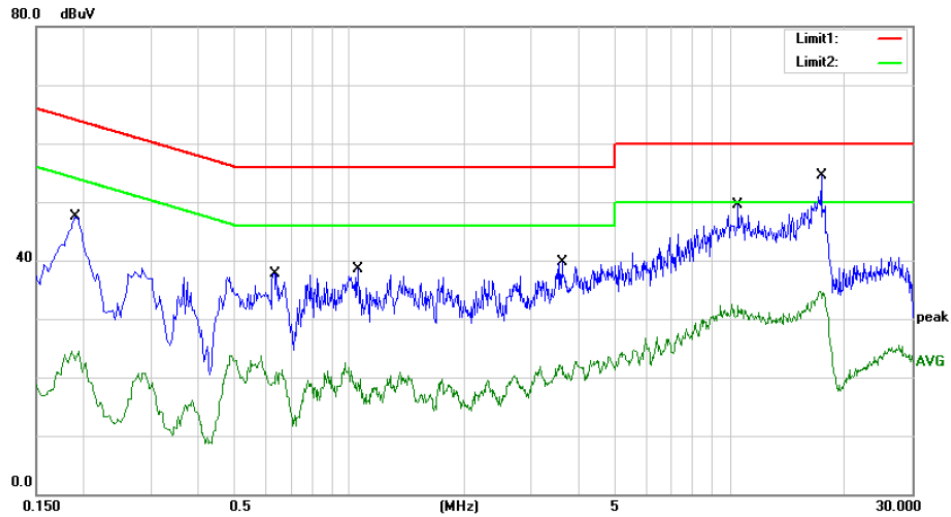

Site: Conduction #2 Phase: **L1** Temperature: 21C
 Limit: (CE)FCC PART 15 C Power: AC 120V/60Hz Humidity: 53 %

Mode: Charging+2.4G Wireless Connecting
 Note: PU(BLJ)

No. Mk.	Freq. MHz	Reading Level dBuV	Correct Factor dB	Measure- ment dBuV	Limit dBuV	Over dB	Detector	Comment
1	0.1900	37.86	9.63	47.49	64.04	-16.55	QP	
2	0.1900	14.89	9.63	24.52	54.04	-29.52	AVG	
3	0.6340	28.00	9.75	37.75	56.00	-18.25	QP	
4	0.6340	14.01	9.75	23.76	46.00	-22.24	AVG	
5	1.0540	28.59	9.85	38.44	56.00	-17.56	QP	
6	1.0540	12.58	9.85	22.43	46.00	-23.57	AVG	
7	3.6180	29.89	9.86	39.75	56.00	-16.25	QP	
8	3.6180	13.02	9.86	22.88	46.00	-23.12	AVG	
9	10.4660	38.86	10.69	49.55	60.00	-10.45	QP	
10	10.4660	21.91	10.69	32.60	50.00	-17.40	AVG	
11 *	17.3140	43.95	10.51	54.46	60.00	-5.54	QP	
12	17.3140	24.29	10.51	34.80	50.00	-15.20	AVG	



Site Conduction #2 Phase: **N** Temperature: 21C
 Limit: (CE)FCC PART 15 C Power: AC 120V/60Hz Humidity: 53 %

Mode: Charging+2.4G Wireless Connecting
 Note: PU(BLJ)

No. Mk.	Freq. MHz	Reading Level dBuV	Correct Factor dB	Measurement dBuV	Limit dBuV	Over dB	Detector	Comment
1	0.1900	37.35	9.63	46.98	64.04	-17.06	QP	
2	0.1900	14.52	9.63	24.15	54.04	-29.89	AVG	
3	0.2900	32.04	9.66	41.70	60.52	-18.82	QP	
4	0.2900	11.12	9.66	20.78	50.52	-29.74	AVG	
5	0.4820	28.94	9.71	38.65	56.30	-17.65	QP	
6	0.4820	10.42	9.71	20.13	46.30	-26.17	AVG	
7	0.6340	27.76	9.75	37.51	56.00	-18.49	QP	
8	0.6340	7.18	9.75	16.93	46.00	-29.07	AVG	
9	1.4260	26.31	9.85	36.16	56.00	-19.84	QP	
10	1.4260	5.15	9.85	15.00	46.00	-31.00	AVG	
11 *	17.3100	38.19	10.51	48.70	60.00	-11.30	QP	
12	17.3100	22.02	10.51	32.53	50.00	-17.47	AVG	

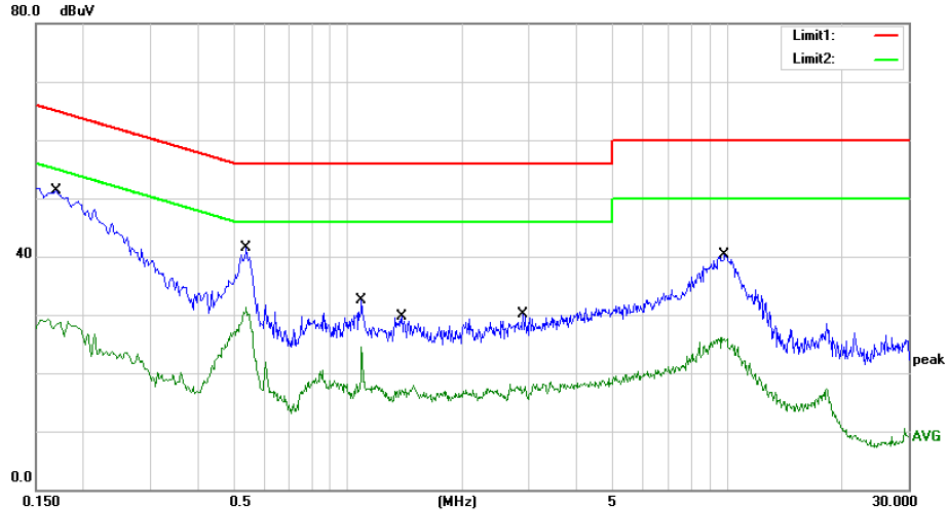

Site Conduction #2 Phase: **L1** Temperature: 21C
 Limit: (CE)FCC PART 15 C Power: AC 120V/60Hz Humidity: 53 %

Mode: Charging+2.4G Wireless Connecting
 Note: PU(Tenpao)

No.	Mk.	Freq. MHz	Reading	Correct	Measure-	Limit		Detector	Comment
			Level dBuV	Factor dB	ment dBuV	dBuV	dB		
1	*	0.1700	41.65	9.62	51.27	64.96	-13.69	QP	
2		0.1700	19.19	9.62	28.81	54.96	-26.15	AVG	
3		0.5380	31.74	9.72	41.46	56.00	-14.54	QP	
4		0.5380	21.55	9.72	31.27	46.00	-14.73	AVG	
5		1.0860	22.66	9.85	32.51	56.00	-23.49	QP	
6		1.0860	14.60	9.85	24.45	46.00	-21.55	AVG	
7		1.3860	19.91	9.85	29.76	56.00	-26.24	QP	
8		1.3860	8.09	9.85	17.94	46.00	-28.06	AVG	
9		2.8860	20.21	9.86	30.07	56.00	-25.93	QP	
10		2.8860	8.27	9.86	18.13	46.00	-27.87	AVG	
11		9.8220	29.67	10.65	40.32	60.00	-19.68	QP	
12		9.8220	15.52	10.65	26.17	50.00	-23.83	AVG	

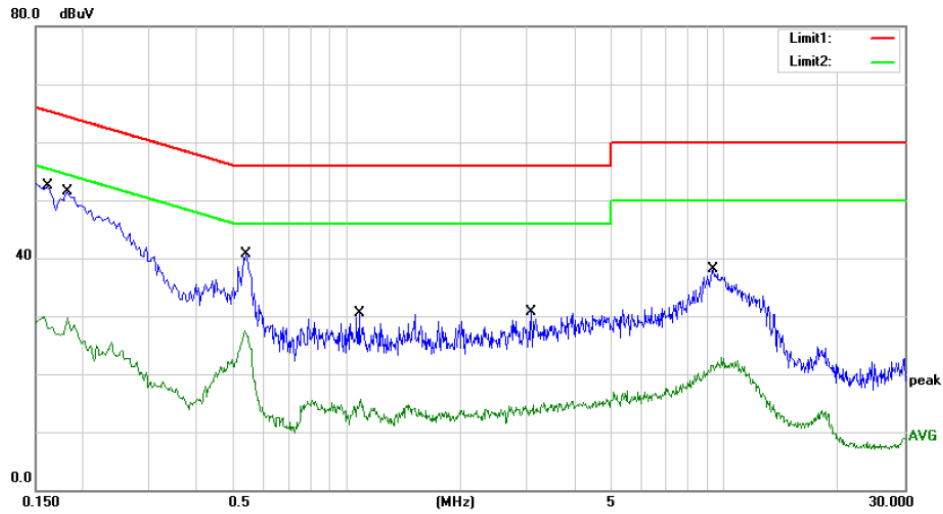

Site Conduction #2 Phase: *N* Temperature: 21C
 Limit: (CE)FCC PART 15 C Power: AC 120V/60Hz Humidity: 53 %

Mode: Charging+2.4G Wireless Connecting
 Note: PU(Tenpao)

No.	Mk.	Freq.	Reading	Correct	Measure-	Limit		Detector	Comment
		MHz	Level	Factor	ment	dBuV	dB		
1		0.1620	42.81	9.62	52.43	65.36	-12.93	QP	
2		0.1620	20.26	9.62	29.88	55.36	-25.48	AVG	
3	*	0.1820	41.97	9.63	51.60	64.39	-12.79	QP	
4		0.1820	20.10	9.63	29.73	54.39	-24.66	AVG	
5		0.5420	30.92	9.73	40.65	56.00	-15.35	QP	
6		0.5420	17.75	9.73	27.48	46.00	-18.52	AVG	
7		1.0820	20.60	9.85	30.45	56.00	-25.55	QP	
8		1.0820	5.76	9.85	15.61	46.00	-30.39	AVG	
9		3.0740	20.85	9.86	30.71	56.00	-25.29	QP	
10		3.0740	5.18	9.86	15.04	46.00	-30.96	AVG	
11		9.3260	27.61	10.52	38.13	60.00	-21.87	QP	
12		9.3260	12.41	10.52	22.93	50.00	-27.07	AVG	

8.10 ANTENNA APPLICATION

8.10.1 Antenna Requirement

Standard	Requirement
<p>FCC CRF Part 15.203 RSS-Gen 6.8</p>	<p>An intentional radiator shall be designed to ensure that no antenna other than that furnished by the responsible party shall be used with the device. The use of a permanently attached antenna or of an antenna that uses a unique coupling to the intentional radiator shall be considered sufficient to comply with the provisions of this section. The manufacturer may design the unit so that a broken antenna can be replaced by the user, but the use of a standard antenna jack or electrical connector is prohibited. This requirement does not apply to carrier current devices or to devices operated under the provisions of §15.211, §15.213, §15.217, §15.219, or §15.221. Further, this requirement does not apply to intentional radiators that must be professionally installed, such as perimeter protection systems and some field disturbance sensors, or to other intentional radiators which, in accordance with §15.31(d), must be measured at the installation site. However, the installer shall be responsible for ensuring that the proper antenna is employed so that the limits in this part are not exceeded.</p>

For intentional device, according to FCC 47 CFR Section 15.203 and IC RSS-Gen 6.7, an intentional radiator shall be designed to ensure that no antenna other than that furnished by the responsible party shall be used with the device. And according to FCC 47 CFR Section 15.247 (b) and IC RSS-Gen 6.7, if transmitting antennas of directional gain greater than 6dBi are used, the power shall be reduced by the amount in dB that the directional gain of the antenna exceeds 6dBi.

8.10.2 Result

PASS.

The EUT has 1 antenna: a Integral Antenna, the gain is 0 dBi

- Note:
- Antenna use a permanently attached antenna which is not replaceable.
 - Not using a standard antenna jack or electrical connector for antenna replacement
 - The antenna has to be professionally installed (please provide method of installation)

which in accordance to section 15.203, please refer to the internal photos.

-----END OF REPORT-----