

FCC/IC - TEST REPORT

Report Number : **68.950.16.672.03** Date of Issue: **October 28, 2018**

Model : **MBP49PU, MBP50PU, MBP36XLPU, MBP36XL-G2PU**

Product Type : **Digital Video Baby monitor**

Applicant : **Binatone Electronics International Limited**

Address : **Floor 23A, 9 Des Voeux Road West, Sheung Wan, Hong Kong**

Manufacturer : **Binatone Electronics International Limited**

Address : **Floor 23A, 9 Des Voeux Road West, Sheung Wan, Hong Kong**

Test Result : **Positive** **Negative**

Total pages including Appendices : **38**

TÜV SÜD Certification and Testing (China) Co., Ltd. Shenzhen Branch is a subcontractor to TÜV SÜD Product Service GmbH according to the principles outlined in ISO 17025.

TÜV SÜD Certification and Testing (China) Co., Ltd. Shenzhen Branch reports apply only to the specific samples tested under stated test conditions. Construction of the actual test samples has been documented. It is the manufacturer's responsibility to assure that additional production units of this model are manufactured with identical electrical and mechanical components. The manufacturer/importer is responsible to the Competent Authorities in Europe for any modifications made to the production units which result in non-compliance to the relevant regulations. TÜV SÜD Certification and Testing (China) Co., Ltd. Shenzhen Branch shall have no liability for any deductions, inferences or generalizations drawn by the client or others from TÜV SÜD Certification and Testing (China) Co., Ltd. Shenzhen Branch issued reports.

This report is the confidential property of the client. As a mutual protection to our clients, the public and ourselves, extracts from the test report shall not be reproduced except in full without our written approval



1 Table of Contents

1	Table of Contents	2
2	Details about the Test Laboratory	3
3	Description of the Equipment Under Test	4
4	Summary of Test Standards	5
5	Summary of Test Results.....	6
6	General Remarks	7
7	Test Setups	8
8	Systems test configuration.....	9
9	Technical Requirement.....	10
9.1	Conducted Emission	10
9.2	Conducted peak output power.....	15
9.3	20 dB bandwidth and 99% bandwidth.....	17
9.4	Carrier Frequency Separation	20
9.5	Number of hopping frequencies.....	22
9.6	Dwell Time	24
9.7	Spurious RF conducted emissions	26
9.8	Band edge testing	30
9.9	Spurious radiated emissions for transmitter.....	33
10	Test Equipment List.....	37
11	System Measurement Uncertainty	38



2 Details about the Test Laboratory

Details about the Test Laboratory

Test Site 1

Company name: TÜV SÜD Certification and Testing (China) Co., Ltd. Shenzhen Branch
Building 12&13, Zhiheng Wisdomland Business Park,
Nantou Checkpoint Road 2, Nanshan District,
Shenzhen City, 518052,
P. R. China

FCC Registration No.: 514049

IC Registration No: 10320A-1

Telephone: 86 755 8828 6998

Fax: 86 755 8828 5299

3 Description of the Equipment Under Test

Product: Digital Video Baby monitor

Model no.: MBP49PU, MBP50PU, MBP36XLPU, MBP36XL-G2PU

Brand Name: motorola

FCC ID: VLJ-MBP50PU

IC ID: 4522A-MBP50PU

Options and accessories: NIL

Rating: DC 3.7V 1880mAh Li-ion Battery or 5VDC, 1A Powered by external power supply
 Adapter Model: S006AKU0500100
 Adaptor Input: 100-240VAC, 50/60Hz; 200mA
 Adaptor Output: 5.0VDC, 1000mA

Adapter Model: S005BNU0500100
 Adaptor Input: 100-240VAC, 50/60Hz; 150mA
 Adaptor Output: 5.0VDC, 1000mA

RF Transmission Frequency: 2402-2479MHz

No. of Operated Channel: 23

Modulation: GFSK

Antenna Type: Integral Antenna

Antenna Gain: 0dBi

Description of the EUT: The Equipment Under Test (EUT) is a baby monitor operated at 2.4GHz

Remark 1: As per Client Declaration, all models are identical.

Channel List:

CH1=2402MHz	CH2=2404MHz	CH3=2406MHz
CH4=2408MHz	CH5=2410MHz	CH6=2415MHz
CH7=2420MHz	CH8=2425MHz	CH9=2430MHz
CH10=2435MHz	CH11=2440MHz	CH12=2445MHz
CH13=2450MHz	CH14=2455MHz	CH15=2460MHz
CH16=2465MHz	CH17=2467MHz	CH18=2469MHz
CH19=2471MHz	CH20=2473MHz	CH21=2475MHz
CH22=2477MHz	CH23=2479MHz	

Remark: The product will only use 22 Channels (from Channel 1 to Channel 22) under normal operating condition. The last one Channel (Channel 23) is only used in matching mode.

4 Summary of Test Standards

Test Standards	
FCC Part 15 Subpart C 10-1-2017 Edition	PART 15 - RADIO FREQUENCY DEVICES Subpart C - Intentional Radiators
RSS-Gen Issue 5 April 2018	General Requirements for the Certification of Radio Apparatus
RSS-247 Issue 2 Feb 2017	RSS-247 —Digital Transmission Systems (DTSs), Frequency Hopping Systems (FHSs) and Licence-Exempt Local Area Network (LE-LAN) Devices

All the test methods were according to KDB 558074 D01 15.247 Meas Guidance V05 released by FCC and C63.10 (2013).

5 Summary of Test Results

Technical Requirements					
FCC Part 15 Subpart C/RSS-Gen Issue 5/RSS-247 Issue 2					
Test Condition			Pages	Test Site	Test Result
§15.207	RSS-GEN 8.8	Conducted emission AC power port	10	Site 1	Pass
§15.247 (b) (1)	RSS-247 Clause 5.4(b)	Conducted peak output power	15	Site 1	Pass
§15.247(a)(1)	RSS-GEN 6.7 RSS-247 Clause 5.1(a)	20dB bandwidth&99% bandwidth	17	Site 1	Pass
§15.247(a)(1)	RSS-247 Clause 5.1(b)	Carrier frequency separation	20	Site 1	Pass
§15.247(a)(1)(iii)	RSS-247 Clause 5.1(d)	Number of hopping frequencies	22	Site 1	Pass
§15.247(a)(1)(iii)	RSS-247 Clause 5.1(d)	Dwell Time	24	Site 1	Pass
§15.247(a)(2)	RSS-247 Clause 5.2(a)	6dB bandwidth	---	---	N/A
§15.247(e)	RSS-247 Clause 5.2(b)	Power spectral density	---	---	N/A
§15.247(d)	RSS-247 Clause 5.5	Spurious RF conducted emissions	26	Site 1	Pass
§15.247(d)	RSS-247 Clause 5.5	Band edge	30	Site 1	Pass
§15.247(d) & §15.209	RSS-247 Clause 5.5 & RSS-GEN 6.13 RSS-GEN 8.9 RSS-GEN 8.10	Spurious radiated emissions for transmitter	33	Site 1	Pass
§15.203	RSS-GEN 6.8	Antenna requirement	See note 2		Pass

Note 1: N/A=Not Applicable.

Note 2: The EUT uses an integral antenna, which gain is 0dBi. In accordance to §15.203 and § RSSGEN 6.8, it is considered sufficiently to comply with the provisions of this section.



6 General Remarks

Remarks

This submittal(s) (test report) is based on report 68.950.16.672.02 for added a new adapter and updating the MBP49PU PCB Antenna change to a folded antenna, audio speaker AMP U8 part move to down, DC to DC U5 power part move to down to left and USB2 Change to J4 port. the PCB material is totally same as before, and RF module including output power, hardware and software is totally same as before. so only Spurious radiated emissions for transmitter and conducted Emission update in this report.

This report is intended for FCC ID: VLJ-MBP50PU and IC: 4522A-MBP50PU complies with Section 15.207, 15.209, 15.205, 15.247 of the FCC Part 15, Subpart C Rules and RSS-Gen and RSS-247 Issue 2 Feb 2017.

SUMMARY:

All tests according to the regulations cited on page 5 were

- Performed
- **Not** Performed

The Equipment Under Test

- **Fulfills** the general approval requirements.
- **Does not** fulfill the general approval requirements.

Sample Received Date: September 30, 2017

Testing Start Date: September 30, 2017

Testing End Date: October 28, 2018

TÜV SÜD Certification and Testing (China) Co., Ltd. Shenzhen Branch

Reviewed by:

Prepared by:

Tested by:



Laurent Yuan
EMC Project Manager

Aaron Lai
EMC Project Engineer

Louise Liu
EMC Test Engineer

7 Test Setups

7.1 AC Power Line Conducted Emission test setups

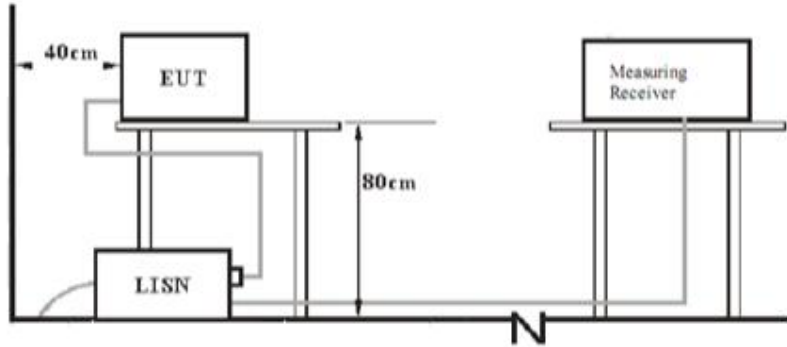

7.2 Radiated test setups

Below 1GHz:

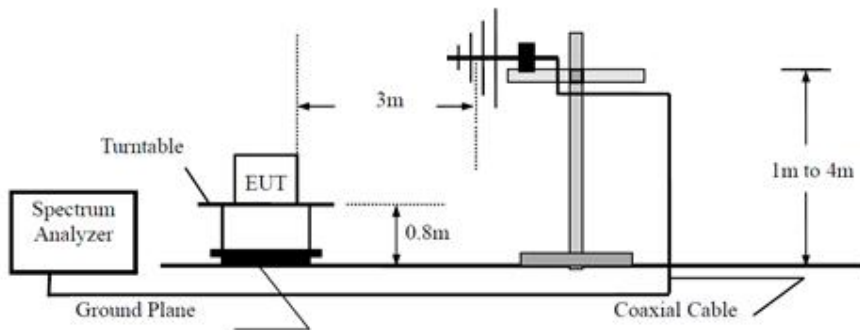

Above 1GHz:

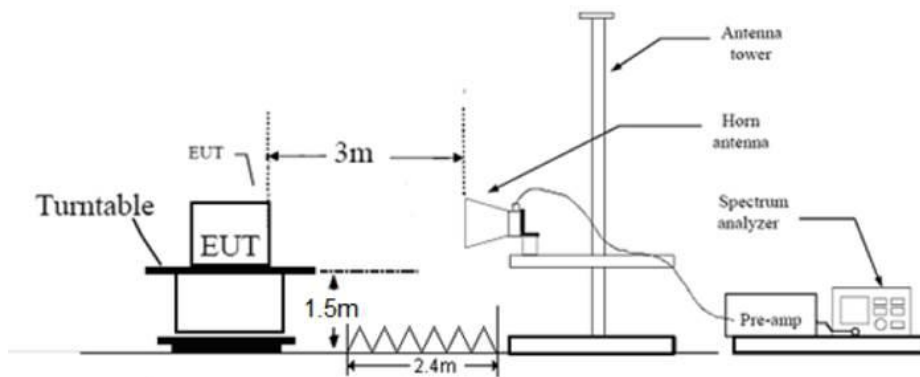

7.3 Conducted RF test setups

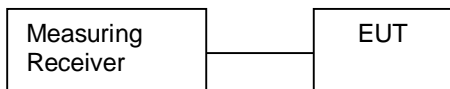

8 Systems test configuration

Auxiliary Equipment Used during Test:

DESCRIPTION	MANUFACTURER	MODEL NO.(SHIELD)	S/N(LENGTH)
Notebook	Lenovo	X240	---

The system was configured to hopping mode and non-hopping mode.

Hopping mode: typical working mode (normal hopping status)

Non-hopping mode: The system was configured to operate at a signal channel transmitting. The test software allows the configuration and operation at the worst-case duty and the highest transmit power

9 Technical Requirement

9.1 Conducted Emission

Test Method

1. The EUT was placed on a table, which is 0.8m above ground plane
2. The power line of the EUT is connected to the AC mains through an Artificial Mains Network (A.M.N.).
3. Maximum procedure was performed to ensure EUT compliance
4. A EMI test receiver is used to test the emissions from both sides of AC line

Limit

According to §15.207 & RSS-GEN A8.8, conducted emissions limit as below:

Frequency MHz	QP Limit dB μ V	AV Limit dB μ V
0.150-0.500	66-56*	56-46*
0.500-5	56	46
5-30	60	50

Decreasing linearly with logarithm of the frequency

Product Type : Digital Video Baby monitor
 M/N : MBP49PU
 Operating Condition : Normal Working
 Test Specification : Line
 Comment : AC 120V/60Hz (Adapter model: S006AKU0500100)

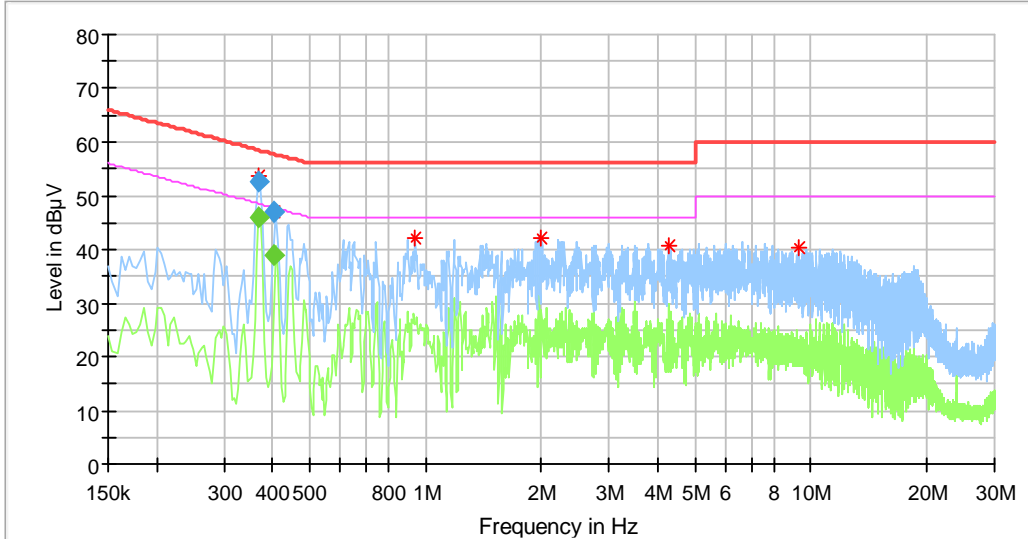

Frequency (MHz)	MaxPeak (dBµV)	Average (dBµV)	Limit (dBµV)	Margin (dB)	Line	Corr. (dB)
0.369500	---	46.13	48.51	2.38	L1	10.8
0.369500	52.53	---	58.51	5.98	L1	10.8
0.405500	47.01	---	57.73	10.72	L1	11.6
0.942000	41.96	---	56.00	14.04	L1	10.2
2.002000	42.09	---	56.00	13.91	L1	10.3
4.302000	40.71	---	56.00	15.29	L1	10.3
9.278000	40.37	---	60.00	19.63	L1	10.6

Product Type : Digital Video Baby monitor
 M/N : MBP49PU
 Operating Condition : Normal Working
 Test Specification : Neutral
 Comment : AC 120V/60Hz (Adapter model: S006AKU0500100)

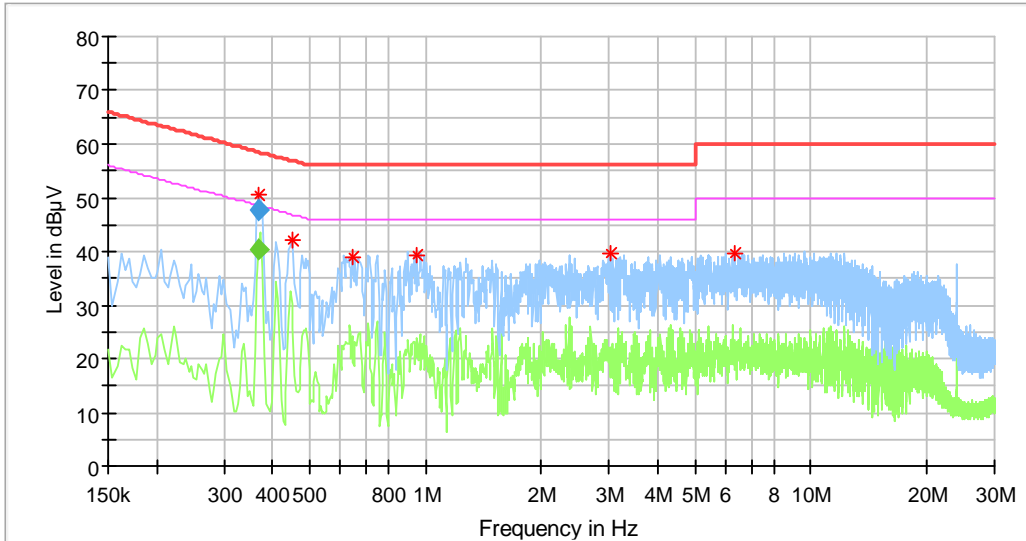

Frequency (MHz)	MaxPeak (dBµV)	Average (dBµV)	Limit (dBµV)	Margin (dB)	Line	Corr. (dB)
0.369500	50.49	---	58.41	7.92	N	10.3
0.450000	41.94	---	56.88	14.94	N	10.3
0.646000	38.86	---	56.00	17.14	N	10.4
0.946000	39.42	---	56.00	16.58	N	10.4
3.022000	39.59	---	56.00	16.41	N	10.5
6.318000	39.57	---	60.00	20.43	N	10.7



Product Type : Digital Video Baby monitor
 M/N : MBP49PU
 Operating Condition : Normal Working
 Test Specification : Line
 Comment : AC 120V/60Hz (Adapter model: S005BNU0500100)

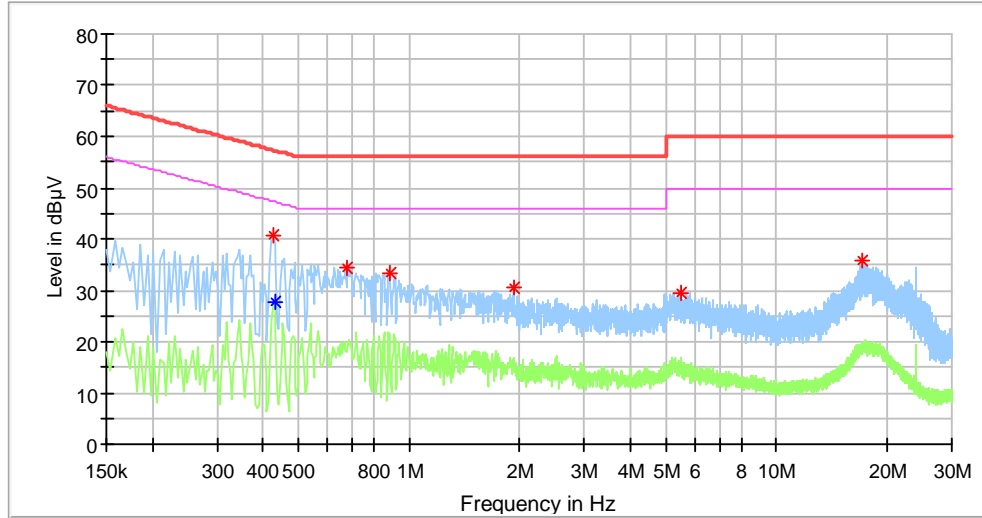

Frequency (MHz)	MaxPeak (dBµV)	Average (dBµV)	Limit (dBµV)	Margin (dB)	Line	Corr. (dB)
0.426000	40.84	---	57.33	16.49	L1	11.3
0.430000	---	27.57	47.25	19.68	L1	11.3
0.678000	34.56	---	56.00	21.44	L1	10.2
0.886000	33.19	---	56.00	22.81	L1	10.2
1.918000	30.43	---	56.00	25.57	L1	10.3
5.462000	29.45	---	60.00	30.55	L1	10.4
17.166000	35.86	---	60.00	24.14	L1	10.8

Product Type : Digital Video Baby monitor
 M/N : MBP49PU
 Operating Condition : Normal Working
 Test Specification : Neutral
 Comment : AC 120V/60Hz (Adapter model: S005BNU0500100)

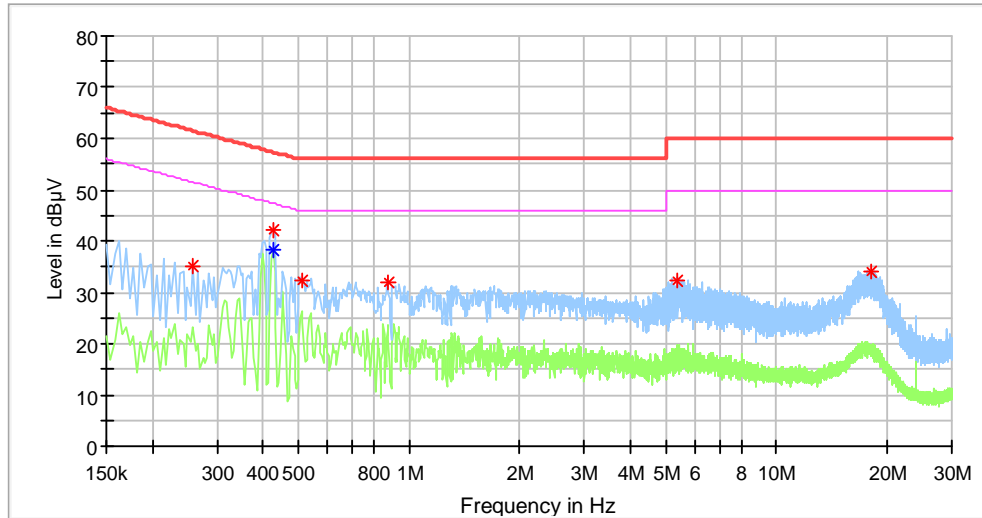

Frequency (MHz)	MaxPeak (dBµV)	Average (dBµV)	Limit (dBµV)	Margin (dB)	Line	Corr. (dB)
0.258000	35.25	---	61.50	26.25	N	10.3
0.426000	---	38.17	47.33	9.16	N	10.3
0.426000	42.25	---	57.33	15.08	N	10.3
0.514000	32.41	---	56.00	23.59	N	10.4
0.874000	32.08	---	56.00	23.92	N	10.4
5.342000	32.16	---	60.00	27.84	N	10.6
18.062000	33.98	---	60.00	26.02	N	11.4



9.2 Conducted peak output power

Test Method

1. Use the following spectrum analyzer settings:
 Span = approximately 5 times the 20 dB bandwidth, centered on a hopping channel
 RBW > the 20 dB bandwidth of the emission being measured, VBW ≥ RBW,
 Sweep = auto, Detector function = peak, Trace = max hold
2. Add a correction factor to the display.
3. Allow the trace to stabilize. Use the marker-to-peak function to set the marker to the peak of the emission. The indicated level is the peak output power

Limits

According to §15.247 (b) (1) & RSS-247 5.4(4), conducted peak output power limit as below:

Frequency Range MHz	Limit W	Limit dBm
2400-2483.5	≤1	≤30



Conducted peak output power

GFSK modulation Test Result

Frequency MHz	Conducted Peak Output Power dBm	Result
Low channel 2402MHz	15.88	Pass
Middle channel 2440MHz	16.30	Pass
High channel 2477MHz	16.39	Pass



9.3 20 dB bandwidth and 99% bandwidth

Test Method

1. Check the calibration of the measuring instrument using either an internal calibrator or a known signal from an external generator.
2. Position the EUT without connection to measurement instrument. Turn on the EUT and connect it to measurement instrument. Then set it to any one convenient frequency within its operating range. Set a reference level on the measuring instrument equal to the highest peak value.
3. Measure the frequency difference of two frequencies that were attenuated 20 dB from the reference level. Record the frequency difference as the emission bandwidth.
4. Repeat above procedures until all frequencies measured were complete.

Limit

Limit [kHz]

N/A

20 dB bandwidth and 99% bandwidth

GFSK Modulation test result

Frequency MHz	20 dB Bandwidth kHz	99% bandwidth kHz	Limit kHz	Result
2402	2663.0	2445.7	--	Pass
2440	2721.0	2474.7	--	Pass
2477	2751.0	2518.1	--	Pass

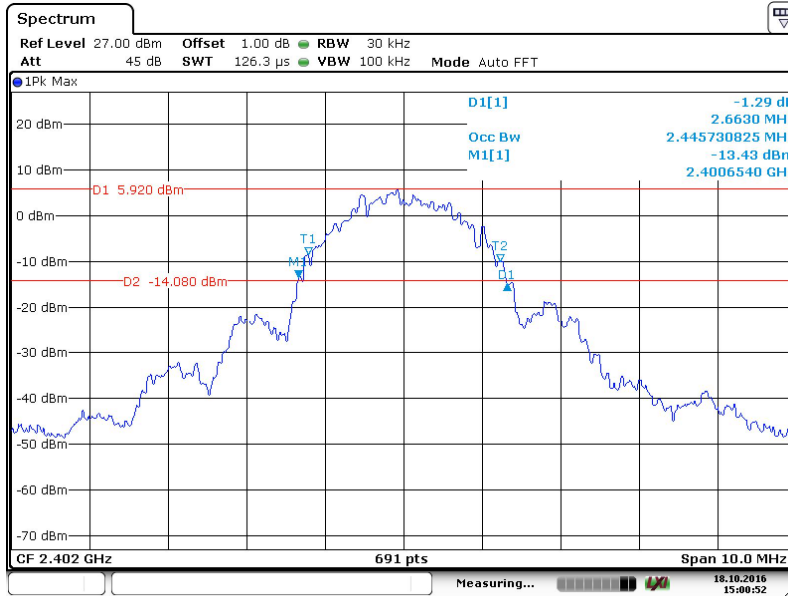

Date: 18.OCT.2016 15:00:51

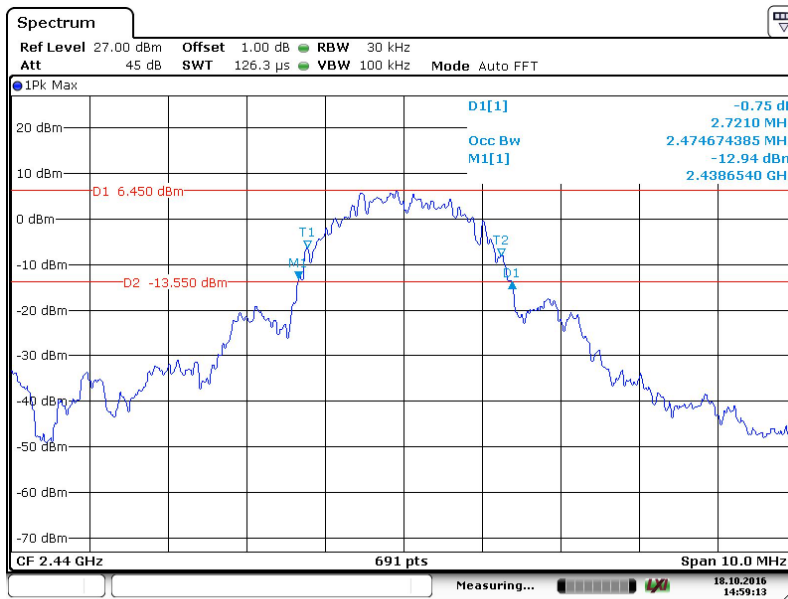

Date: 18.OCT.2016 14:59:14

20 dB bandwidth and 99% bandwidth

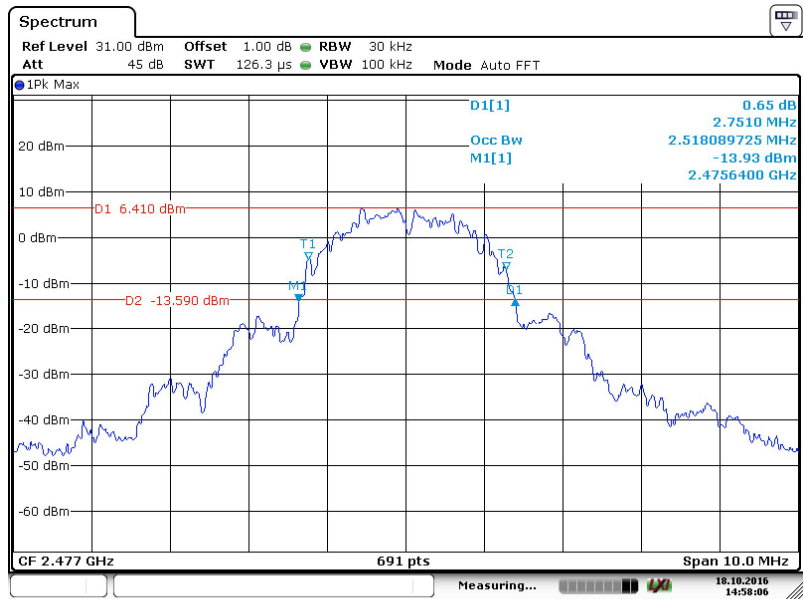

Date: 18.OCT.2016 14:58:07



9.4 Carrier Frequency Separation

Test Method

1. Use the following spectrum analyzer settings:
Span = wide enough to capture the peaks of two adjacent channels, RBW \geq 1% of the span, VBW) \geq RBW, Sweep = auto, Detector function = peak
2. By using the Max-Hold function record the separation of two adjacent channels.
3. Measure the frequency difference of these two adjacent channels by spectrum analyzer marker function.
4. Repeat above procedures until all frequencies measured were complete.

Limit

$$\frac{\text{Limit}}{\text{kHz}} \geq 25\text{kHz or } 2/3 \text{ of the } 20 \text{ dB bandwidth which is greater}$$

GFSK Modulation Limit

Frequency MHz	2/3 of 20 dB Bandwidth kHz
2402	1775.3
2440	1814.0
2477	1834.0

Carrier Frequency Separation

Test result: The measurement was performed with the typical configuration (normal hopping status), here GFSK modulation mode was used to show compliance.

GFSK Modulation test result

Frequency MHz	Carrier Frequency Separation kHz	Result
2402	2005.8	Pass
2440	5014.0	

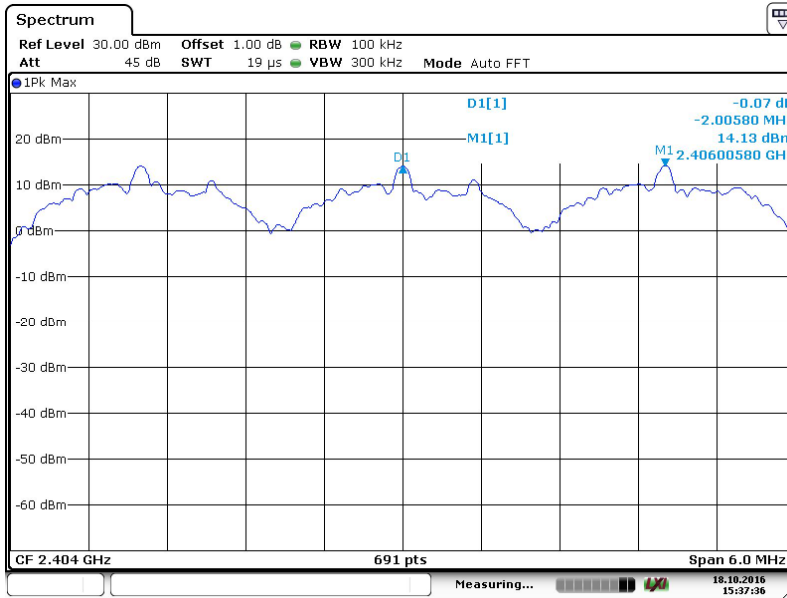

Date: 18.OCT.2016 15:37:37

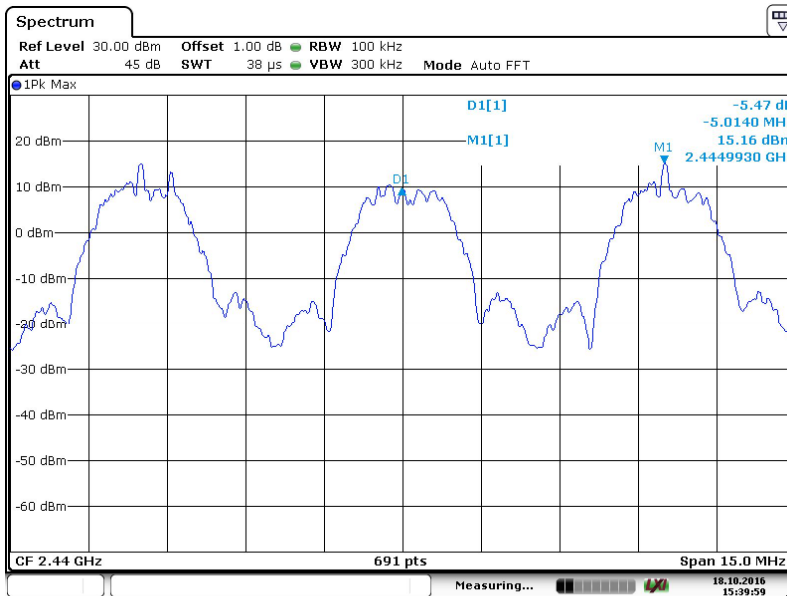

Date: 18.OCT.2016 15:39:59

9.5 Number of hopping frequencies

Test Method

1. Use the following spectrum analyzer settings:
Span = wide enough to capture the peaks of two adjacent channels, RBW \geq 1% of the span, VBW \geq RBW, Sweep = auto, Detector function = peak
2. Set the spectrum analyzer on Max-Hold Mode, and then keep the EUT in hopping mode.
3. Record all the signals from each channel until each one has been recorded.
4. Repeat above procedures until all frequencies measured were complete.

Limit

**Limit
number**
—————
 ≥ 15

Number of hopping frequencies

Test result: The measurement was performed with the typical configuration (normal hopping status), Here GFSK modulation mode was used to show compliance.

Number of hopping frequencies	Result
23	Pass

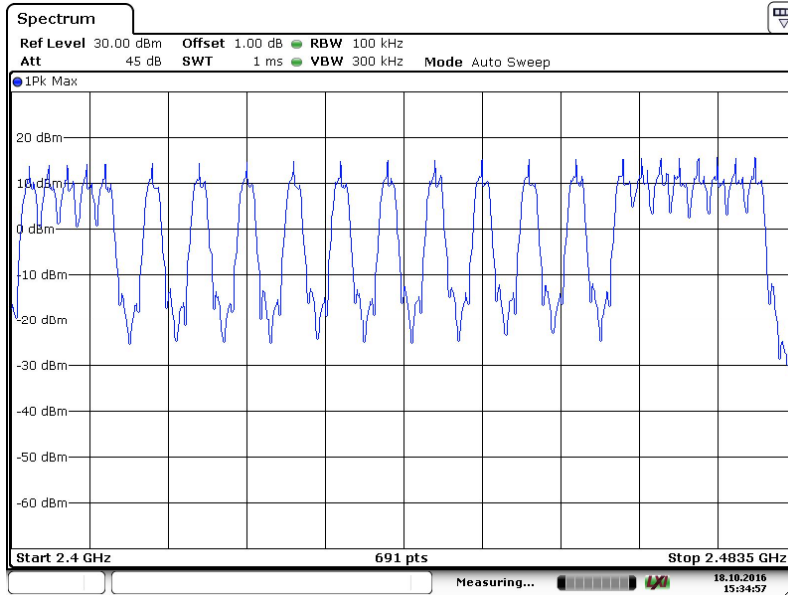

Date: 18.OCT.2016 15:34:57

Remark: The product will only use 22 Channels (from Channel 1 to Channel 22) under normal operating condition. The last one Channel (Channel 23) is only used in matching mode.



9.6 Dwell Time

Test Method

1. Connect EUT antenna terminal to the spectrum analyzer with a low loss cable.
Equipment mode: Spectrum analyzer
2. RBW: 1MHz; VBW: 1MHz; SPAN: Zero Span
3. Adjust the center frequency of spectrum analyzer on any frequency be measured.
4. Measure the Dwell Time by spectrum analyzer Marker function.
5. Repeat above procedures until all frequencies measured were complete.

Limit

According to §15.247(a)(1)(iii) & RSS-210 A8.1(c) The average time of occupancy on any frequency shall not be greater than 0.4 seconds within a period of 0.4 seconds multiplied by the number of hopping channels employed.

Dwell time

The maximum dwell time shall be 0.4 s.

We test Low frequency, middle frequency and high frequency, only worse case recorded in the report.

The Dwell Time = Burst Width * Total Hops. The detailed calculations are showed as follows:

The duration for dwell time calculation: $0.4 [s] * \text{hopping number} = 0.4 [s] * 22 [ch] = 8.8 [s*ch]$;

The burst width, which is directly measured, refers to the duration on one channel hop.

The maximum number of hopping channels in 8.8s = $30 * (8.8/2) = 132$

Test Result

Modulation	Frequency	Reading (ms)	Total Hops	Test Result (ms)	Limit (ms)	Result
GFSK	2440MHz	0.239	132	31.55	< 400	Pass

GFSK Modulation-2440MHz

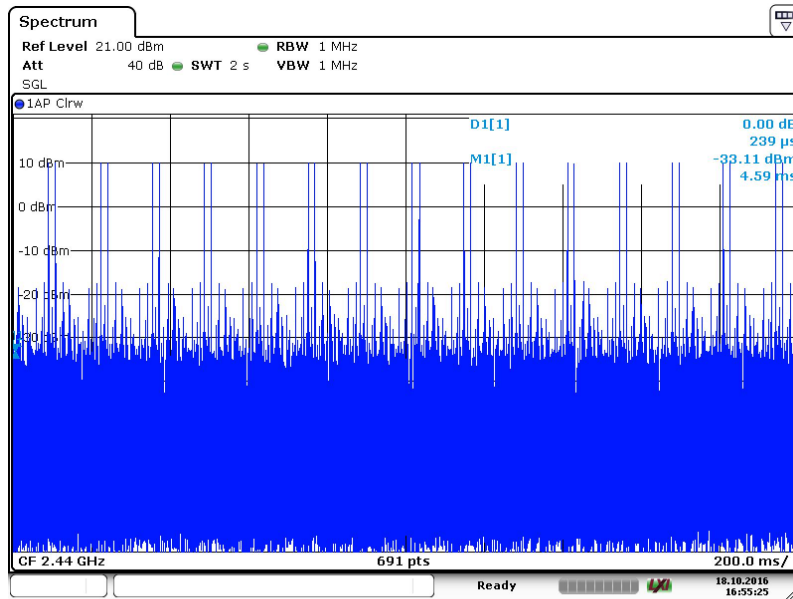

Date: 18.OCT.2016 16:55:25

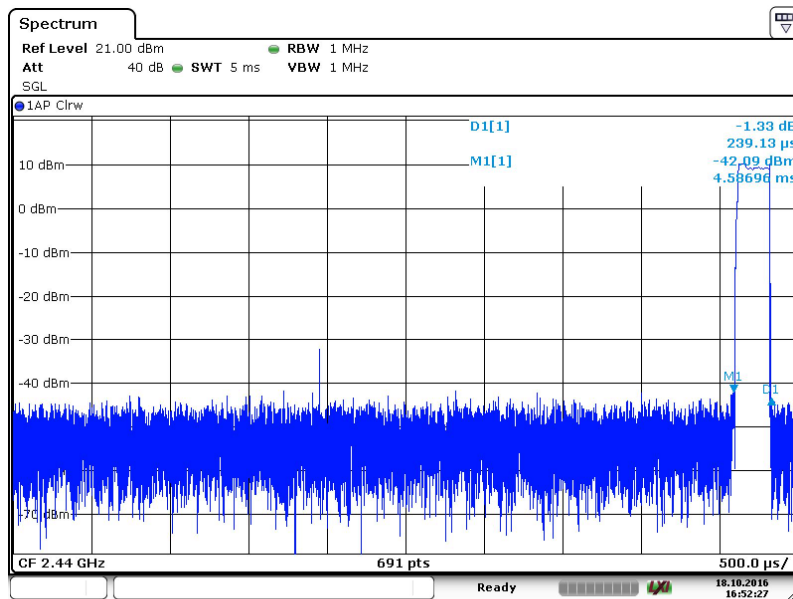

Date: 18.OCT.2016 16:52:27



9.7 Spurious RF conducted emissions

Test Method

1. Use the following spectrum analyzer settings:
 Span = wide enough to capture the peak level of the in-band emission and all spurious emissions (e.g., harmonics) from the lowest frequency generated in the EUT up through the 10th harmonic. Typically, several plots are required to cover this entire span.
 RBW = 100 kHz, VBW ≥ RBW, Sweep = auto, Detector function = peak, Trace = max hold
2. Allow the trace to stabilize. Set the marker on the peak of any spurious emission recorded.
3. The level displayed must comply with the limit specified in this Section. Submit these plots.
4. Repeat above procedures until all frequencies measured were complete.

Limit

Frequency Range MHz	Limit (dBc)
30-25000	-20

Spurious RF conducted emissions

2402MHz

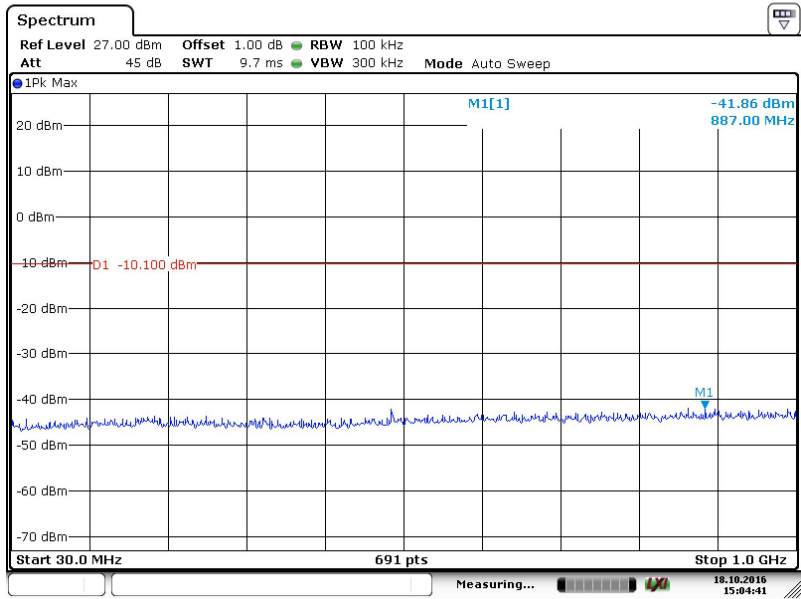

Date: 18.OCT.2016 15:04:41

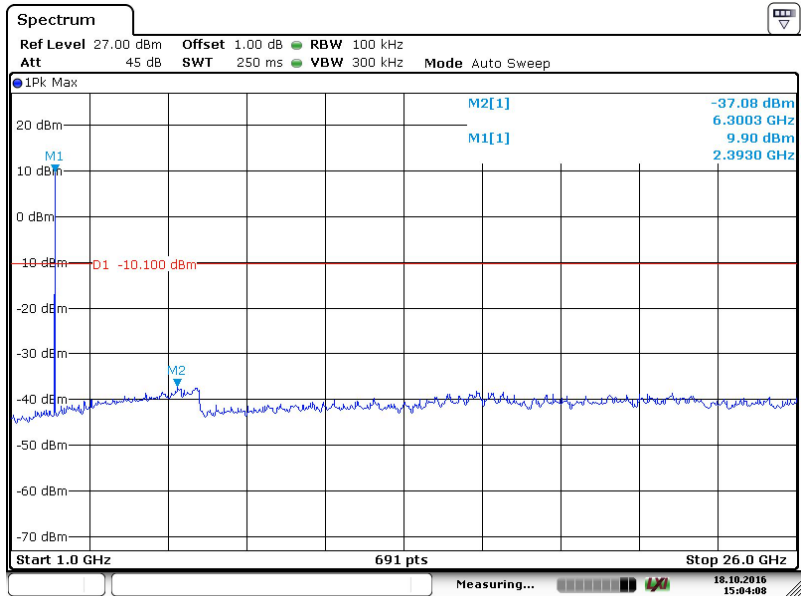

Date: 18.OCT.2016 15:04:09

Spurious RF conducted emissions

2440MHz

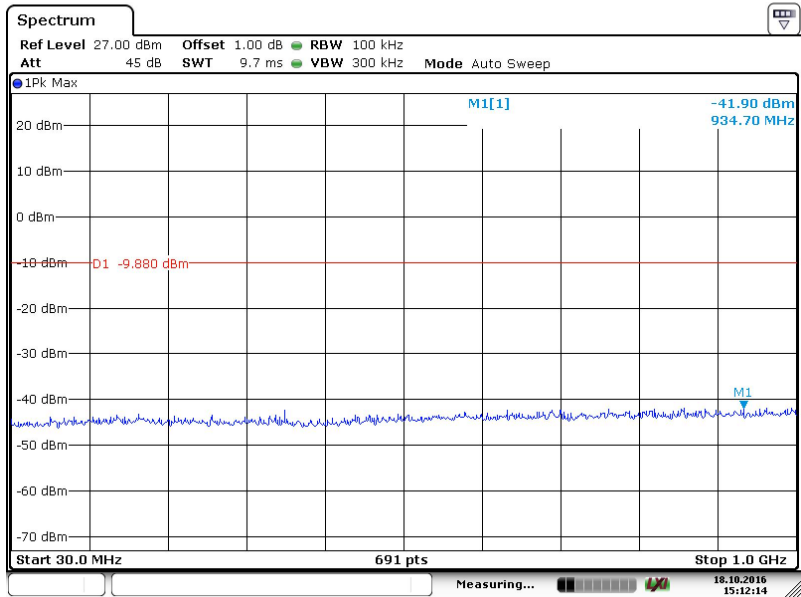

Date: 18.OCT.2016 15:12:14

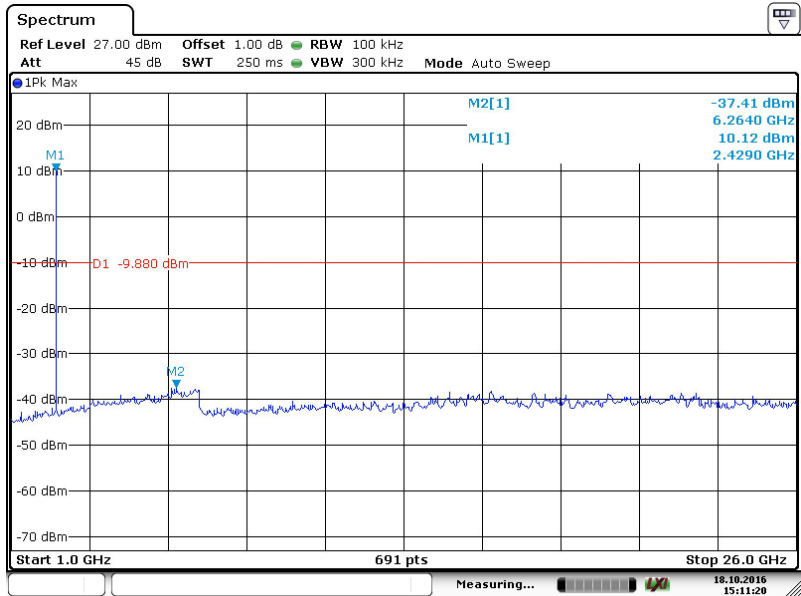

Date: 18.OCT.2016 15:11:20

Spurious RF conducted emissions

2477MHz

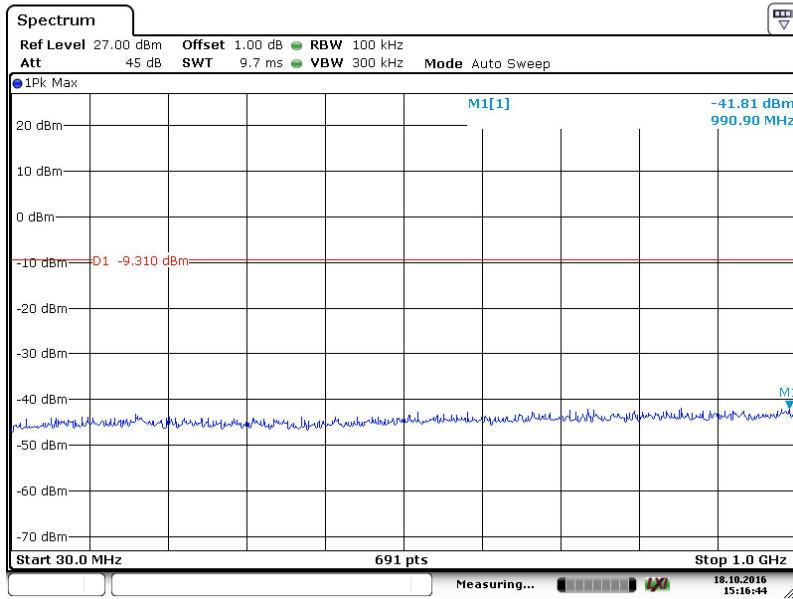

Date: 18.OCT.2016 15:16:44

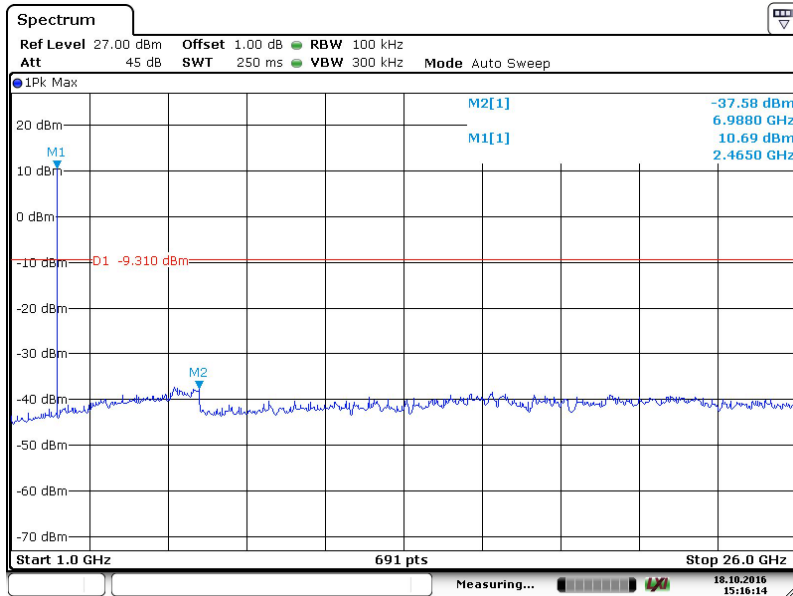

Date: 18.OCT.2016 15:16:14

9.8 Band edge testing

Test Method

- 1 Use the following spectrum analyzer settings:
Span = wide enough to capture the peak level of the in-band emission and all spurious
RBW = 100 kHz, VBW \geq RBW, Sweep = auto, Detector function = peak, Trace = max hold
- 2 Allow the trace to stabilize, use the peak and delta measurement to record the result.
- 3 The level displayed must comply with the limit specified in this Section. .
- 4 Repeat the test at the hopping off and hopping on mode, submit all the plots.

Limit:

According to §15.247(d) & RSS-210 A8.5, in any 100 kHz bandwidth outside the frequency bands in which the spread spectrum intentional radiator is operating, the radio frequency power that is produced by the intentional radiator shall be at least 20 dB below that in the 100 kHz bandwidth within the band that contains the highest level of the desired power, based on either an RF conducted or a radiated measurement, provided the transmitter demonstrates compliance with the peak conducted power limits. In addition, radiated emissions which fall in the restricted bands, as defined in §15.205(a) and RSS-Gen7.2.2, must also comply with the radiated emission limits specified in 15.209(a) (see Section 15.205(c)) and RSS-Gen.

Band edge testing

GFSK Modulation Test Result:

Hopping On:

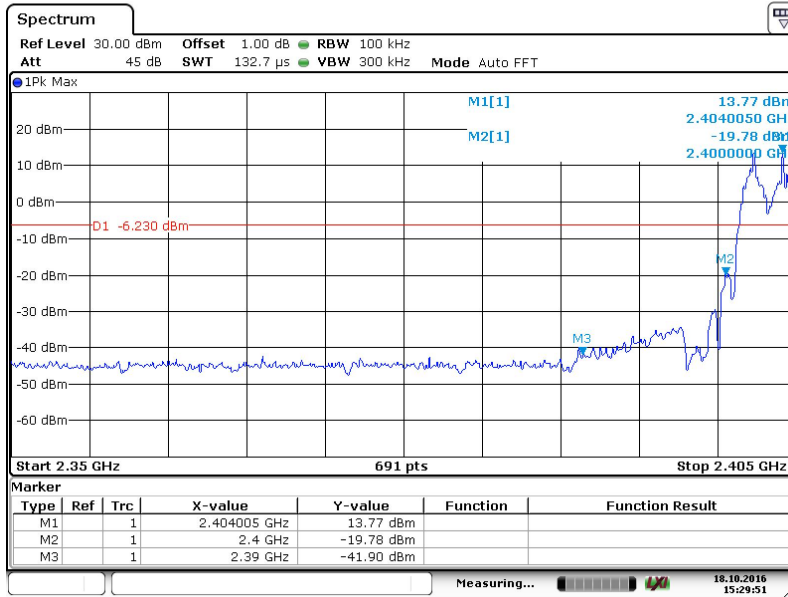

Date: 18.OCT.2016 15:29:51

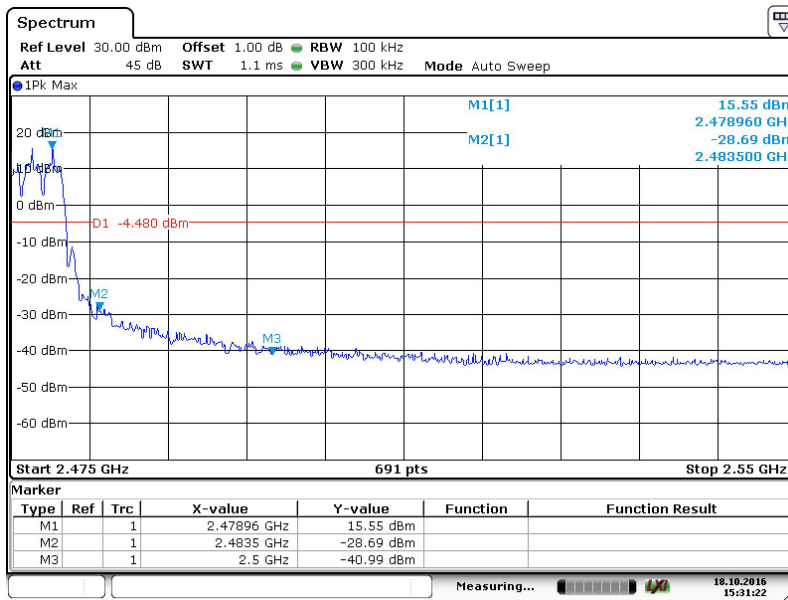

Date: 18.OCT.2016 15:31:22

Hopping Off:

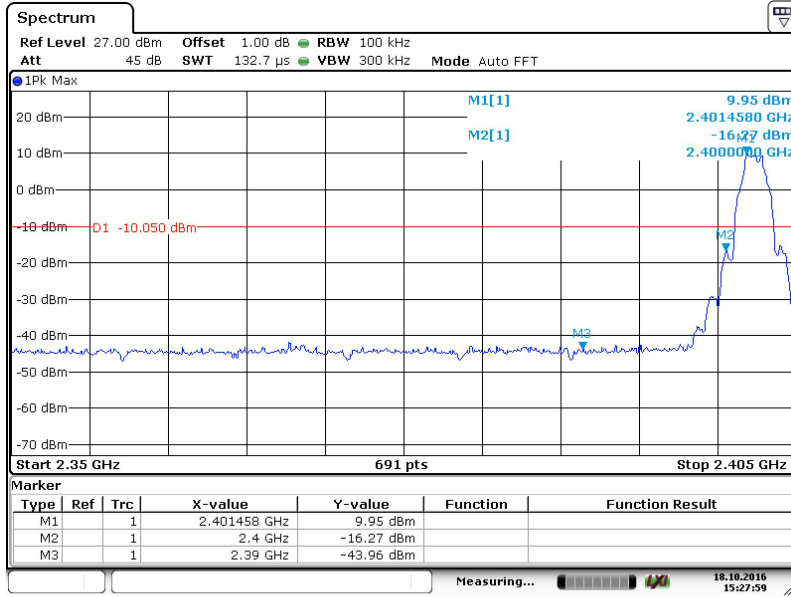

Date: 18.OCT.2016 15:27:59

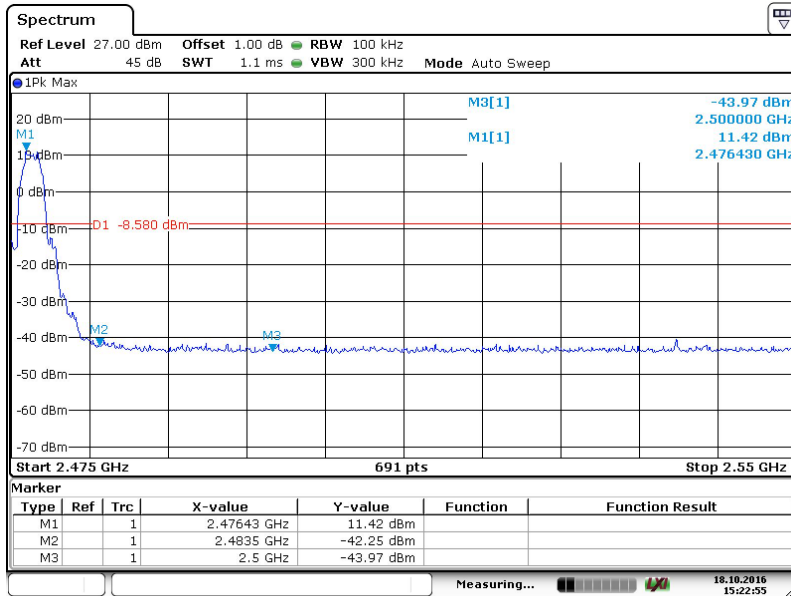

Date: 18.OCT.2016 15:22:55

9.9 Spurious radiated emissions for transmitter

Test Method

1. The EUT was placed on a turn table which is 1.5m above ground plane for above 1GHz and 0.8m above ground for below 1GHz at 3meter chamber room for test. The table was rotated 360 degrees to determine the position of the highest radiation.
2. The EUT was set 3 meters away from the interference – receiving antenna, which was mounted on the top of a variable – height antenna tower.
3. The height of antenna is varied from one meter to four meters above the ground to determine the maximum value of the field strength. Both horizontal and vertical polarizations of the antenna are set to make the measurement.
4. For each suspected emission, the EUT was arranged to its worst case and then the antenna was tuned to heights from 1 meter to 4 meters and the rotatable table was turned
5. Use the following spectrum analyzer settings According to C63.10:
For Above 1GHz
Span = wide enough to capture the peak level of the in-band emission and all spurious
RBW = 1MHz, VBW \geq RBW for peak measurement and VBW = 10Hz for average measurement, Sweep = auto, Detector function = peak, Trace = max hold.
For Below 1GHz
Use the following spectrum analyzer settings:
Span = wide enough to capture the peak level of the in-band emission and all spurious
RBW = 100 KHz, VBW \geq RBW for peak measurement, Sweep = auto, Detector function = peak, Trace = max hold.

Note:

1. The resolution bandwidth and video bandwidth of test receiver/spectrum analyzer is 120 KHz for Quasi-peak detection (QP) at frequency below 1GHz.
2. The resolution bandwidth of test receiver/spectrum analyzer is 1MHz and the video bandwidth is 3MHz for peak detection (PK) at frequency above 1GHz.
3. The resolution bandwidth of test receiver/spectrum analyzer is 1MHz and the video bandwidth is 3MHz for RMS Average ((duty cycle < 98%) for Average detection (AV) at frequency above 1GHz, then the measurement results was added to a correction factor (20log(1/duty cycle)).
4. The resolution bandwidth of test receiver/spectrum analyzer is 1MHz and the video bandwidth is 10Hz (duty cycle > 98%) for Average detection (AV) at frequency above 1GHz.

Limit

According to part 15.247(d), the radio emission outside the operating frequency band shall be at least 20 dB below that in the 100 kHz bandwidth within the band that contains the highest level of the desired power. Radiated emissions which fall in the restricted bands, as defined in section 15.205, must comply with the radiated emission limits specified in section 15.209.

Frequency MHz	Field Strength uV/m	Field Strength dB μ V/m	Detector
30-88	100	40	QP
88-216	150	43.5	QP
216-960	200	46	QP
960-1000	500	54	QP
Above 1000	500	54	AV
Above 1000	5000	74	PK

Spurious radiated emissions for transmitter

According to C63.10, if the peak (or quasi-peak) measured value complies with the average limit, it is unnecessary to perform an average measurement, so AV emission value did not show in below table if the peak value complies with average limit.

The only worse case (which is subject to the maximum EIRP, GFSK mode) test result is listed in the report.

Transmitting spurious emission test result as below:

Mode GFSK Modulation 2402MHz Test Result

Adapter Model: S005BNU0500100

Frequency	Emission Level	Polarization	Limit	Detector	Margin	Result
MHz	dBuV/m		dBuV/m		dBuV/m	
144.035625	30.41	Horizontal	43.50	QP	13.09	Pass
624.185625	34.11	Horizontal	46.00	QP	11.89	Pass
935.070625	34.76	Horizontal	46.00	QP	11.24	Pass
144.035625	31.78	Vertical	43.50	QP	11.72	Pass
240.065625	35.83	Vertical	46.00	QP	10.17	Pass
360.103125	36.16	Vertical	46.00	QP	9.84	Pass

Mode GFSK Modulation 2402MHz Test Result

Adapter Model: S006AKU0500100

Frequency	Emission Level	Polarization	Limit	Detector	Margin	Result
MHz	dBuV/m		dBuV/m		dBuV/m	
44.765556	24.74	Horizontal	40.00	QP	24.74	Pass
200.019444	19.95	Horizontal	43.50	QP	19.95	Pass
384.103889	12.53	Horizontal	46.00	QP	12.53	Pass
648.159444	13.28	Horizontal	46.00	QP	13.28	Pass
944.871667	14.93	Horizontal	46.00	QP	14.93	Pass
47.675556	17.41	Vertical	40.00	QP	22.59	Pass
272.015000	24.97	Vertical	46.00	QP	21.03	Pass
384.050000	28.86	Vertical	46.00	QP	17.14	Pass
648.159444	25.32	Vertical	46.00	QP	20.68	Pass
941.530556	31.70	Vertical	46.00	QP	14.30	Pass
4804.687500	43.74	Horizontal	74.00	PK	30.26	Pass
7508.437500	38.85	Horizontal	74.00	PK	35.15	Pass
11143.593750	42.38	Horizontal	74.00	PK	31.62	Pass
4802.812500	35.30	Vertical	74.00	PK	38.70	Pass
6500.625000	39.03	Vertical	74.00	PK	34.97	Pass
11093.437500	42.21	Vertical	74.00	PK	31.79	Pass

Mode GFSK Modulation 2440MHz Test Result
Adapter Model: S006AKU0500100

Frequency	Emission Level	Polarization	Limit	Detector	Margin	Result
MHz	dBuV/m		dBuV/m		dBuV/m	
4878.750000	48.26	Horizontal	74.00	PK	25.74	Pass
9295.312500	41.65	Horizontal	74.00	PK	32.35	Pass
12438.281250	44.25	Horizontal	74.00	PK	29.75	Pass
4880.625000	37.41	Vertical	74.00	PK	36.59	Pass
7546.406250	39.68	Vertical	74.00	PK	34.32	Pass
12821.718750	44.64	Vertical	74.00	PK	29.36	Pass

Bluetooth Mode GFSK Modulation 2477MHz Test Result
Adapter Model: S006AKU0500100

Frequency	Emission Level	Polarization	Limit	Detector	Margin	Result
MHz	dBuV/m		dBuV/m		dBuV/m	
4957.03125	52.41	Horizontal	74.00	PK	21.59	Pass
10137.1875	41.91	Horizontal	74.00	PK	32.09	Pass
12397.9687	47.74	Horizontal	74.00	PK	26.26	Pass
7434.84375	43.86	Vertical	74.00	PK	30.14	Pass
12391.8750	51.87	Vertical	74.00	PK	22.13	Pass
14877.1875	51.10	Vertical	74.00	PK	22.90	Pass

Remark: Testing is carried out with frequency rang 30MHz to 18GHz, the detected values which are noise floor or below the limit 30dB will not be recorded.

10 Test Equipment List

List of Test Instruments

DESCRIPTION	MANUFACTURER	MODEL NO.	SERIAL NO.	CAL. DUE DATE
EMI Test Receiver	Rohde & Schwarz	ESR 26	101269	2019-7-6
Trilog Super Broadband Test Antenna	Schwarzbeck	VULB 9163	707	2019-6-28
Horn Antenna	Rohde & Schwarz	HF907	102294	2019-6-28
Pre-amplifier	Rohde & Schwarz	SCU 18	102230	2019-7-6
Signal Generator	Rohde & Schwarz	SMY01	839369/005	2019-7-6
Attenuator	Agilent	8491A	MY39264334	2019-7-6
3m Semi-anechoic chamber	TDK	9X6X6	----	2020-7-7
Test software	Rohde & Schwarz	EMC32	Version 9.15.00	N/A

DESCRIPTION	MANUFACTURER	MODEL NO.	SERIAL NO.	CAL. DUE DATE
EMI Test Receiver	Rohde & Schwarz	ESR 3	101782	2019-7-6
LISN	Rohde & Schwarz	ENV4200	100249	2019-7-6
LISN	Rohde & Schwarz	ENV432	101318	2019-7-6
LISN	Rohde & Schwarz	ENV216	100326	2019-7-6
ISN	Rohde & Schwarz	ENY81	100177	2019-7-6
ISN	Rohde & Schwarz	ENY81-CA6	101664	2019-7-6
High Voltage Probe	Rohde & Schwarz	TK9420(VT9420)	9420-584	2019-6-30
RF Current Probe	Rohde & Schwarz	EZ-17	100816	2019-6-30
Attenuator	Shanghai Huaxiang	TS2-26-3	080928189	2019-7-6
Test software	Rohde & Schwarz	EMC32	Version9.15.00	N/A

11 System Measurement Uncertainty

For a 95% confidence level, the measurement expanded uncertainties for defined systems, in accordance with the recommendations of ISO 17025 were:

System Measurement Uncertainty	
Test Items	Extended Uncertainty
Uncertainty for Radiated Spurious Emission 25MHz-3000MHz	Horizontal: 4.80dB; Vertical: 4.87dB;
Uncertainty for Radiated Spurious Emission 3000MHz-18000MHz	Horizontal: 4.59dB; Vertical: 4.58dB;
Uncertainty for Radiated Spurious Emission 18000MHz-40000MHz	Horizontal: 5.05dB; Vertical: 5.04dB;
Uncertainty for Conducted RF test with TS 8997	RF Power Conducted: 1.16dB Frequency test involved: 0.6×10 ⁻⁷ or 1%
Uncertainty for Conducted Emission 150kHz-30MHz (for test using AMN ENV432 or ENV4200)	3.21dB