



Valued Quality. Delivered.

TEST REPORT

Report Number: 16051965HKG-002

Application
for
Original Grant of 47 CFR Part 15 Certification
New Family of RSS-247 Issue 1 Equipment Certification

Video Baby Monitor - Parent Unit

FCC ID: VLJ-MBP482PU

IC: 4522A-MBP482PU

Prepared and Checked by:

Approved by:

Signed on File

Lee Shui Tim, Tim
Lead Engineer

Koo Wai Ip
Assistant Supervisor
June 15, 2016

- Intertek's standard Terms and Conditions can be obtained at our website: <http://www.intertek.com/terms/>.
- The test report only allows to be revised within the retention period unless further standard or the requirement was noticed.
- This report is for the exclusive use of Intertek's Client and is provided pursuant to the agreement between Intertek and its Client. Intertek's responsibility and liability are limited to the terms and conditions of the agreement. Intertek assumes no liability to any party, other than to the Client in accordance with the agreement, for any loss, expense or damage occasioned by the use of this report. Only the Client is authorized to permit copying or distribution of this report and then only in its entirety. Any use of the Intertek name or one of its marks for the sale or advertisement of the tested material, product or service must first be approved in writing by Intertek. The observations and test results in this report are relevant only to the sample tested. This report by itself does not imply that the material, product, or service is or has ever been under an Intertek certification program.
- © 2016 Intertek

Intertek Testing Services Hong Kong Ltd.

2/F., Garment Centre, 576 Castle Peak Road, Kowloon, Hong Kong.
Tel: (852) 2173 8888 Fax: (852) 2785 5487 Website: www.hk.intertek-etlsemko.com

INTERTEK TESTING SERVICES

GENERAL INFORMATION

Applicant Name:	Binatone Electronics International Limited
Applicant Address:	Floor 23A, 9 Des Voeux Road West, Sheung Wan, Hong Kong
FCC Specification Standard:	FCC Part 15, October 1, 2014 Edition
FCC ID:	VLJ-MBP482PU
FCC Model(s):	MBP482PU
IC Specification Standard:	RSS-247 Issue 1, May 2015 RSS-Gen Issue 4, December 2014
IC:	4522A-MBP482PU
IC HVIN:	MBP482PU
IC PMN:	MBP482, MBP482-2, MBP482-3, MBP482-4
Type of EUT:	Spread Spectrum Transmitter
Description of EUT:	Video Baby Monitor - Parent Unit
Serial Number:	N/A
Sample Receipt Date:	May 25, 2016
Date of Test:	May 26, 2016 to June 15, 2016
Report Date:	June 15, 2016
Environmental Conditions:	Temperature: +10 to 40°C Humidity: 10 to 90%

INTERTEK TESTING SERVICES

Table of Contents

1.0 Test Results Summary & Statement of Compliance	4
1.1 Summary of Test Results	4
1.2 Statement of Compliance	4
2.0 General Description	6
2.1 Product Description	6
2.2 Test Methodology	6
2.3 Test Facility	6
3.0 System Test Configuration	8
3.1 Justification	8
3.2 EUT Exercising Software	9
3.3 Details of EUT and Description of Accessories	10
3.4 Measurement Uncertainty	10
4.0 Test Results	12
4.1 Maximum Conducted Output Power at Antenna Terminals	12
4.2 Maximum 20 dB RF Bandwidth	15
4.3 Minimum Number of Hopping Frequencies	18
4.4 Minimum Hopping Channel Carrier Frequency Separation	21
4.5 Average Channel Occupancy Time	23
4.6 Out of Band Conducted Emissions	26
4.7 Field Strength Calculation	31
4.8 Transmitter Radiated Emissions in Restricted Bands and Spurious Emissions	32
4.8.1 Radiated Emission Configuration Photograph	33
4.8.2 Radiated Emission Data	33
4.8.3 Radiated Emission Test Setup	34
4.8.4 Transmitter Duty Cycle Calculation	39
4.9 AC Power Line Conducted Emission	41
4.9.1 AC Power Line Conducted Emission Configuration Photograph	41
4.9.2 AC Power Line Conducted Emission Data	41
5.0 Equipment List	45

INTERTEK TESTING SERVICES

**EXHIBIT 1
TEST RESULTS SUMMARY & STATEMENT OF COMPLIANCE**

INTERTEK TESTING SERVICES

1.0 Test Results Summary & Statement of Compliance

1.1 Summary of Test Results

Test Items	FCC Part 15 Section	RSS-247/ RSS-Gen# Section	Results	Details see section
Antenna Requirement	15.203	7.1.2 [#]	Pass	2.1
Max. Conducted Output Power	15.247(b)(1)	5.1(2)	Pass	4.1
Max. 20dB RF Bandwidth	15.247(a)(1)(iii)	5.1(1)	Pass	4.2
Min. No. of Hopping Frequencies	15.247(a)(1)(iii)	5.1(3)	Pass	4.3
Min. Hopping Channel Carrier Frequency Separation	15.247(a)(1)	5.1	Pass	4.4
Average Time of Occupancy	15.247(a)(1)(iii)	5.1(3)	Pass	4.5
Out of Band Antenna Conducted Emission	15.247(d)	5.5	Pass	4.6
Radiated Emission in Restricted Bands and Spurious Emissions	15.247(d) & 15.109	5.4	Pass	4.8
AC Power Line Conducted Emission	15.207 & 15.107	7.2.4 [#]	Pass	4.9

Note: Pursuant to FCC Part 15 Section 15.215(c), the 20dB bandwidth of the emission was contained within the frequency band designated (mentioned as above) which the EUT operated. The effects, if any, from frequency sweeping, frequency hopping, other modulation techniques and frequency stability over expected variations in temperature and supply voltage were considered.

1.2 Statement of Compliance

The equipment under test is found to be complying with the following standards:

FCC Part 15, October 1, 2014 Edition
RSS-247 Issue 1, May 2015
RSS-Gen Issue 4, November 2014

INTERTEK TESTING SERVICES

**EXHIBIT 2
GENERAL DESCRIPTION**

INTERTEK TESTING SERVICES

2.0 General Description

2.1 Product Description

The MBP482PU is a 2.4GHz Frequency Hopping Spread Spectrum Video Baby Monitor - Parent Unit. It operates at frequency range of 2407.5MHz to 2475MHz. There are total 21 channels. The Parent Unit is powered by an adaptor 100-120VAC to 6.0VDC 400mA and/or powered by a "Ni-MH" type rechargeable battery pack (3.6V 800mAh).

The antenna(s) used in the Parent Unit is integral, and the test sample is a prototype.

For FCC and IC, commercial name: MBP482, MBP482-2, MBP482-3 and MBP482-4 are the same as the Model: MBP482PU in electronics/electrical designs including software & firmware, PCB layout and construction design/physical design/enclosure. The only differences between these commercial names are color and number of parent unit in packaging to be sold for marketing purpose

The circuit description and frequency hopping algorithm are saved with filename: descri.pdf.

2.2 Test Methodology

Both AC power line-conducted and radiated emission measurements were performed according to the procedures in ANSI C63.4 (2014). Preliminary radiated scans and all radiated measurements were performed in radiated emission test sites. All Radiated tests were performed at an antenna to EUT distance of 3 meters, unless stated otherwise in the "**Justification Section**" of this Application. Antenna port conducted measurements were performed according to ANSI C63.10 (2013). All other measurements were made in accordance with the procedures in 47 CFR Part 2.

2.3 Test Facility

The radiated emission test site, AC power line conducted measurement facility and antenna port conducted measurement facility used to collect the radiated data, AC Power Line conducted data, and conductive data are at Intertek Testing Services Hong Kong Ltd., which is located at Workshop No. 3, G/F., World-Wide Industrial Centre, 43-47 Shan Mei Street, Fo Tan, Sha Tin, N.T., Hong Kong. This test facility and site measurement data have been fully placed on file with FCC and Industry Canada No. 2042V.

INTERTEK TESTING SERVICES

**EXHIBIT 3
SYSTEM TEST CONFIGURATION**

INTERTEK TESTING SERVICES

3.0 System Test Configuration

3.1 Justification

For radiated emissions testing, the equipment under test (EUT) was setup to transmit / receive continuously to simplify the measurement methodology. Care was taken to ensure proper power supply voltages during testing. During testing, all cables (if any) were manipulated to produce worst case emissions.

The Parent Unit was powered by a 100-120VAC to 6.0VDC 400mA adaptor and/or powered by a "Ni-MH" type rechargeable battery pack (3.6V 800mAh).

For the measurements, the EUT was attached to a plastic stand if necessary and placed on the wooden turntable. If the base unit attached to peripherals, they were connected and operational (as typical as possible). The parent unit was remotely located as far from the antenna and the base as possible to ensure full power transmission from the parent unit. Else, the base was wired to transmit full power with modulation.

The signal was maximized through rotation and placement in the three orthogonal axes. The antenna height and polarization were varied during the search for maximum signal level. The antenna height was varied from 1 to 4 meters. Radiated emissions were taken at three meters unless the signal level was too low for measurement at that distance. If necessary, a pre-amplifier was used and/or the test was conducted at a closer distance.

For any intentional radiator powered by AC power line, measurements of the radiated signal level of the fundamental frequency component of the emission was performed with the supply voltage varied between 85% and 115% of the nominal rated supply voltage.

For transmitter radiated measurement, the spectrum analyzer resolution bandwidth was 100 kHz for frequencies below 1000 MHz. The resolution bandwidth was 1 MHz for frequencies above 1000 MHz.

Radiated emission measurement for transmitter were performed from the lowest radio frequency signal generated in the device which is greater than 9 kHz to the tenth harmonic of the highest fundamental frequency or to 40 GHz, whichever is lower.

Emission that are directly caused by digital circuits in the transmit path and transmitter portion were measured, and the limit are according to FCC Part 15 Section 15.209. Digital circuitry used to control additional functions other than the operation of the transmitter is subject to FCC Part Section 15.109 Limits.

INTERTEK TESTING SERVICES

3.1 Justification - Cont'd

Detector function for radiated emissions was in peak mode. Average readings, when required, were taken by measuring the duty cycle of the equipment under test and subtracting the corresponding amount in dB from the measured peak readings. A detailed description for the calculation of the average factor can be found in section 4.8.3.

Determination of pulse desensitization was made according to *Hewlett Packard Application Note 150-2, Spectrum Analysis... Pulsed RF*. The effective period (Teff) was referred to Exhibit 4.8.3. With the resolution bandwidth 1MHz and spectrum analyzer IF bandwidth 3dB, the pulse desensitization factor was 0dB.

For AC line conducted emission test, the EUT along with its peripherals were placed on a 1.0m(W)x1.5m(L) and 0.8m in height wooden table and the EUT was adjusted to maintain a 0.4 meter space from a vertical reference plane. The EUT was connected to power mains through a line impedance stabilization network (LISN), which provided 50ohm coupling impedance for measuring instrument. The LISN housing, measuring instrument case, reference ground plane, and vertical ground plane were bounded together. The excess power cable between the EUT and the LISN was bundled.

All connecting cables of EUT and peripherals were manipulated to find the maximum emission.

All relevant operation modes have been tested, and the worst case data is included in this report.

3.2 EUT Exercising Software

The EUT exercise program used during radiated and conducted testing was designed to exercise the various system components in a manner similar to a typical use.

INTERTEK TESTING SERVICES

3.3 Details of EUT and Description of Accessories

Details of EUT:

An AC adaptor and/or a battery (provided with the unit) were used to power the device. Their description are listed below.

- (1) An AC adaptor (100-120VAC 60Hz 150mA to 6VDC 400mA, Model: S003AKU0600040, Brand: Ten Pao) (Supplied by Client)
- (2) A "Ni-MH" type rechargeable battery pack (3.6V 800mAh, Model: BT166342/BT266342, Brand: GPI) (Supplied by Client).

Description of Accessories:

- (1) Baby Unit, Model: MBP482BU, FCC ID: VLJ-MBP482BU (Provided by Client)

3.4 Measurement Uncertainty

When determining of the test conclusion, the Measurement Uncertainty of test at a level of confidence of 95% has been considered. The values of the Measurement uncertainty for radiated emission test and RF conducted measurement test are $\pm 5.3\text{dB}$ and $\pm 0.99\text{dB}$ respectively. The value of the Measurement uncertainty for conducted emission test is $\pm 4.2\text{dB}$.

INTERTEK TESTING SERVICES

**EXHIBIT 4
TEST RESULTS**

INTERTEK TESTING SERVICES

4.0 Test Results

4.1 Maximum Conducted Output Power at Antenna Terminals

- The antenna power of the EUT was connected to the input of a power meter. Power was read directly and cable loss correction was added to the reading to obtain power at the EUT antenna terminals.
- The antenna port of the EUT was connected to the input of a spectrum analyzer. The analyzer was set for RBW>20dB bandwidth and power was read directly in dBm. External attenuation and cable loss were compensated for using the OFFSET function of the analyser.

Antenna Gain = 0dBi		
Frequency (MHz)	Output in dBm	Output in mW
Low Channel: 2407.5	17.12	51.523
Middle Channel: 2441.25	16.30	42.658
High Channel: 2475	15.47	35.237

Cable loss / external attenuation : 0.5 dB

Cable loss, external attenuation: included in OFFSET function
 added to SA raw reading

dBm max. output level = 17.12 dBm

Limits:

- 0.125W (21dBm) for antennas with gains of 6dBi or less
- 0.25W (24dBm) for antennas with gains of 6dBi or less
- 1W (30dBm) for antennas with gains of 6dBi or less
- ___W (___dBm) for antennas with gains more than 6dBi

The plots of conducted output power are saved as below.

INTERTEK TESTING SERVICES

Plots of conducted output power Lowest Channel

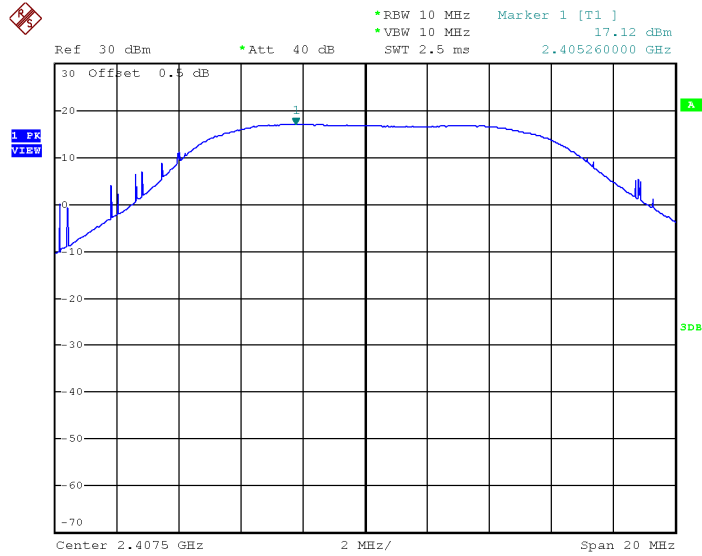

Date: 22.JUN.2016 11:29:18

Middle Channel

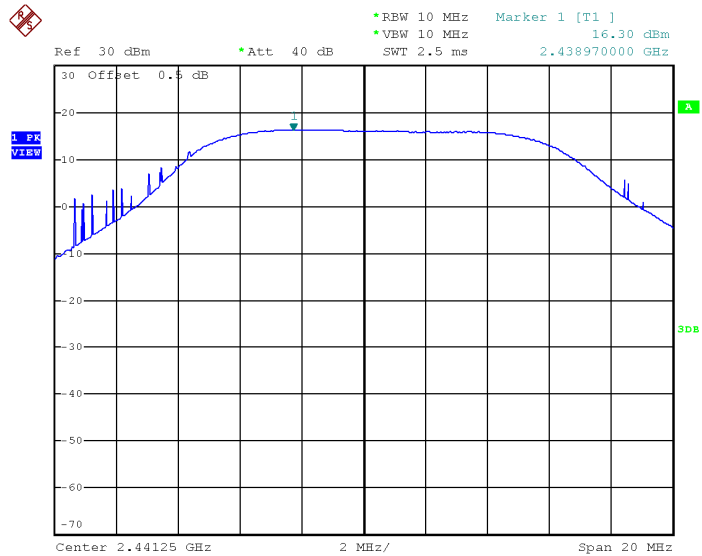

Date: 22.JUN.2016 11:44:33

INTERTEK TESTING SERVICES

Plots of conducted output power

Highest Channel

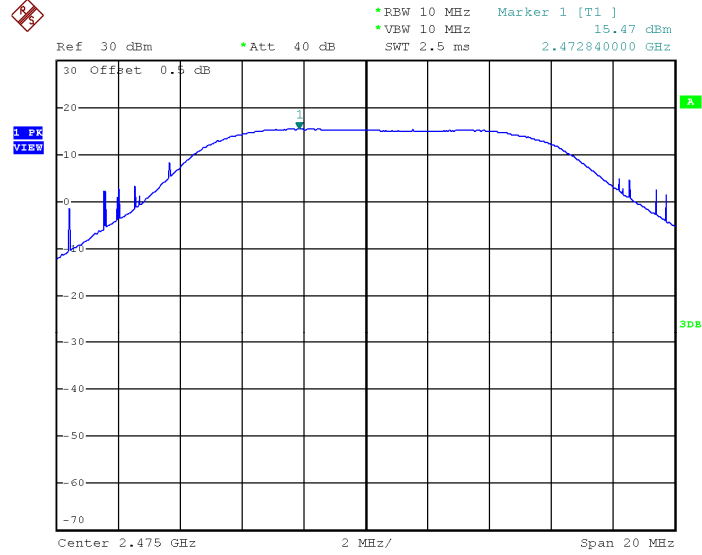

Date: 22.JUN.2016 12:00:28

INTERTEK TESTING SERVICES

4.2 Maximum 20 dB RF Bandwidth

The antenna port of the EUT was connected to the input of a spectrum analyzer. Analyzer RES BW was chosen so that the display was a result of the hopping channel modulation. For each RF output channel investigated, the spectrum analyzer center frequency was set to the channel carrier. A PEAK output reading was taken, a DISPLAY line was drawn 20 dB lower than PEAK level. The 20 dB bandwidth was determined from where the channel output spectrum intersected the display line.

Frequency (MHz)	20 dB Bandwidth (kHz)
Low Channel: 2407.5	3960
Middle Channel: 2441.25	3680
High Channel: 2475	3660

Limits

- $\leq 500\text{kHz}$ for 902-928MHz
- N/A for 2400-2483.5MHz
- $\leq 1\text{MHz}$ for 5725-5850MHz

The plots of 20dB RF bandwidth and occupied bandwidth are saved as below.

INTERTEK TESTING SERVICES

Plots of 20dB RF bandwidth Lowest Channel

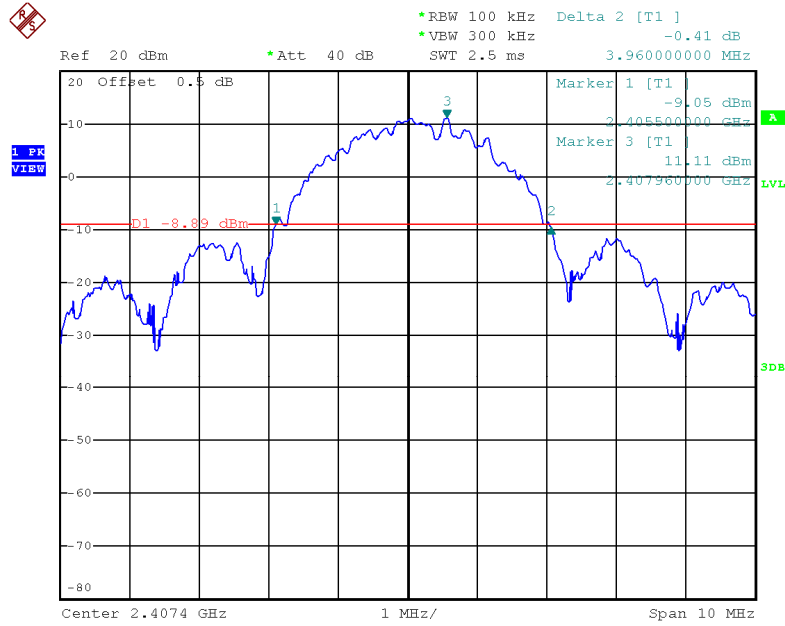

Date: 13.JUN.2016 12:09:32

Middle Channel

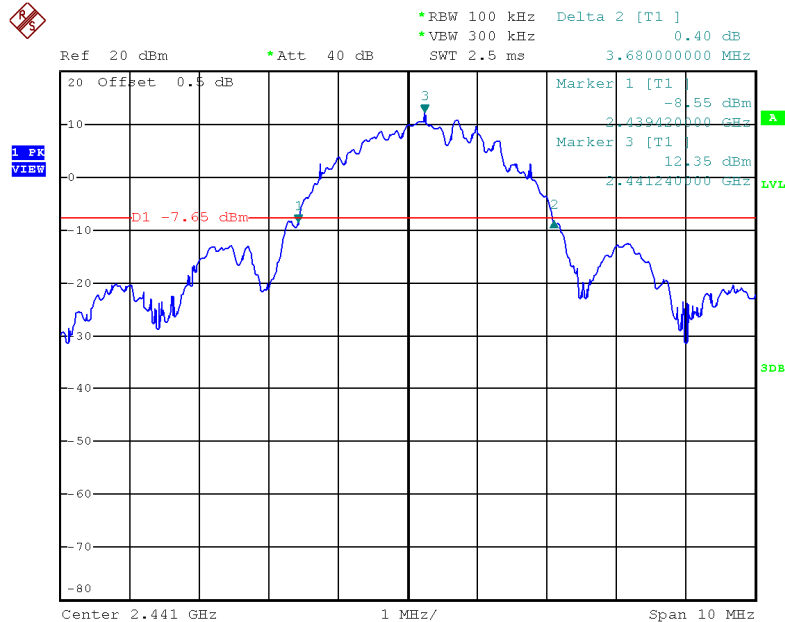

Date: 13.JUN.2016 12:07:58

INTERTEK TESTING SERVICES

Highest Channel

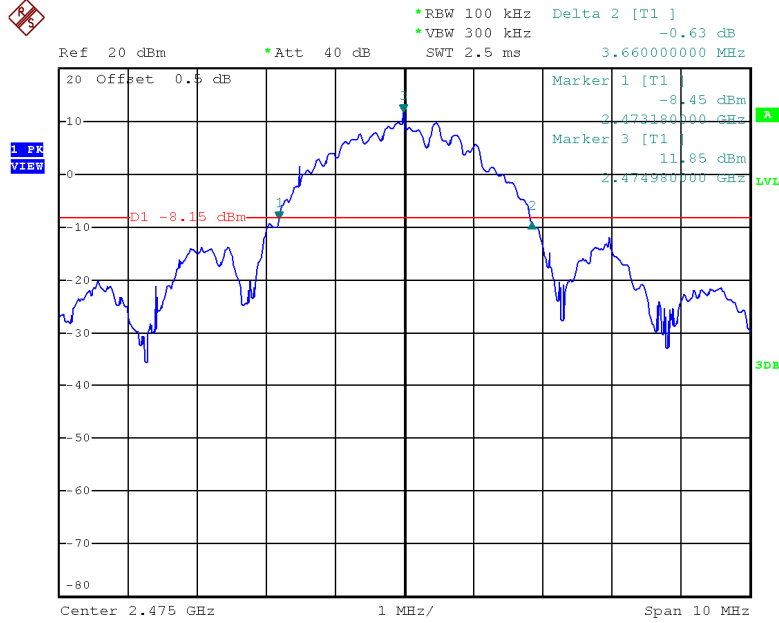

Date: 13.JUN.2016 12:10:56

INTERTEK TESTING SERVICES

4.3 Minimum Number of Hopping Frequencies

With the analyzer set to MAX HOLD readings were taken for 2-3 minutes in each band. The channel peaks so recorded were added together, and the total number compared to the minimum number of channels required in the regulation.

No. of hopping channels	16
-------------------------	----

Minimum Requirements:

- at least 50 hopping channels for 902MHz-928MHz (20 dB bandwidth of hopping channel < 250kHz)
- at least 25 hopping channels for 902MHz-928MHz (20 dB bandwidth of hopping channel \geq 250kHz)
- at least 15 hopping channels for 2400MHz-2483.5MHz.
- at least 75 hopping channels for 5725MHz-5850MHz.

The plots of number of hopping frequencies are saved as below.

INTERTEK TESTING SERVICES

Plots of number of hopping frequencies

Plot A

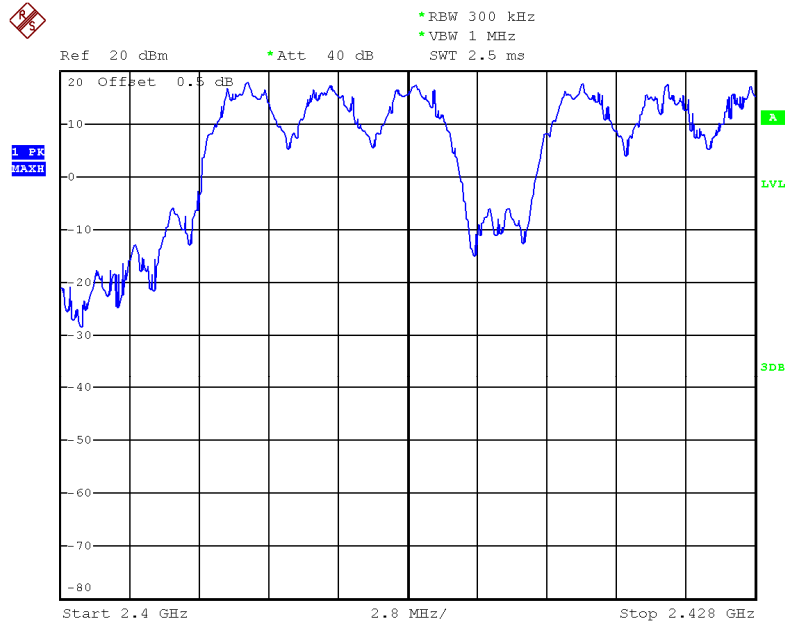

Date: 13.JUN.2016 12:21:44

Plot B

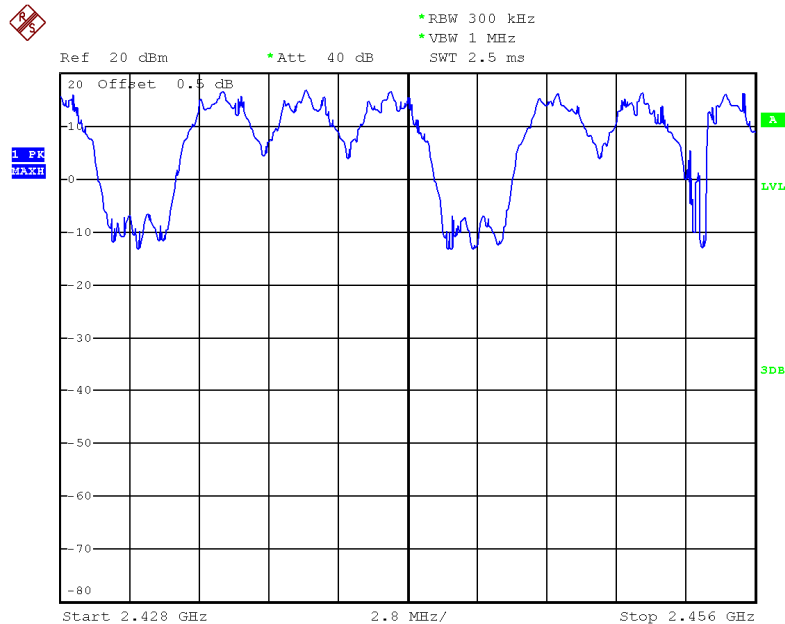

Date: 13.JUN.2016 12:34:45

INTERTEK TESTING SERVICES

Plot C

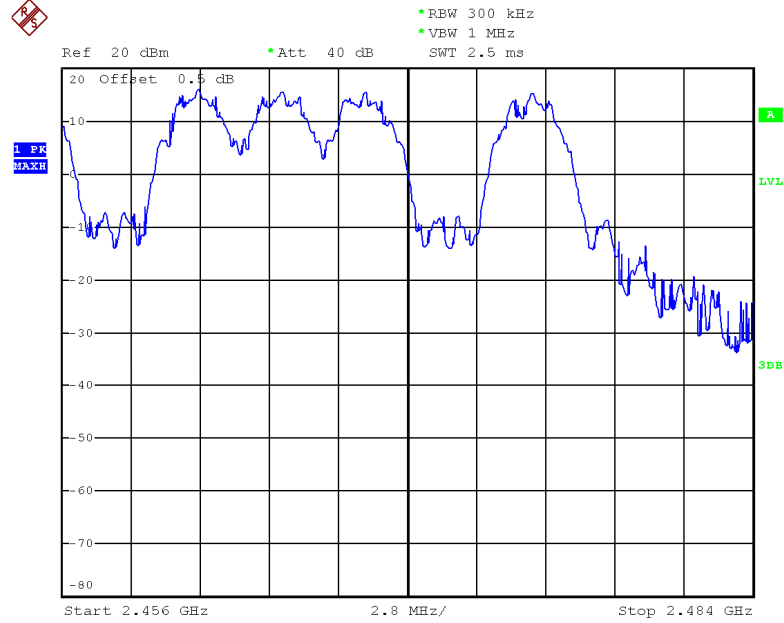

Date: 13.JUN.2016 12:39:40

INTERTEK TESTING SERVICES

4.4 Minimum Hopping Channel Carrier Frequency Separation

Using the DELTA MARKER function of the analyzer, the frequency separation between two adjacent channels was measured and met the requirement.

Channel Separation (Channel <u>1</u> & Channel <u>2</u>)	3380kHz
---	---------

Limits:

The channel separation must be larger than:

- 25 kHz
- 20 dB bandwidth of hopping channel: ___Hz
- 2/3 of 20dB bandwidth of hopping channel: 2640 kHz

The plot(s) of hopping channel carrier frequency separation is saved as below.

INTERTEK TESTING SERVICES

Plots of hopping channel carrier frequency separation

Between channel 2 and channel 3

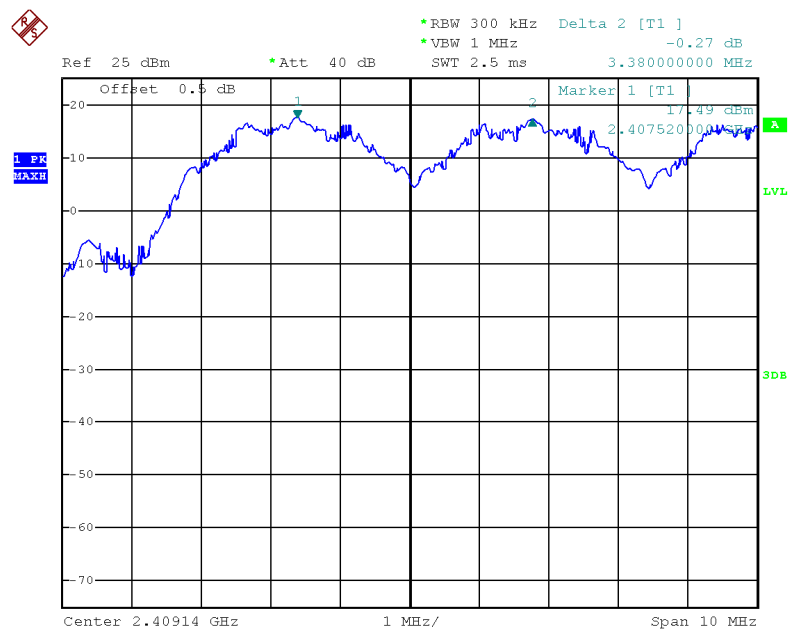

Date: 13.JUN.2016 14:30:59

INTERTEK TESTING SERVICES

4.5 Average Channel Occupancy Time

The spectrum analyzer center frequency was set to one of the known hopping channels. The SWEEP was set to 10ms, the SPAN was set to ZERO SPAN, and the TRIGGER was set to VIDEO. The time duration of the transmission so captured was measured with the MARKER DELTA function.

The SWEEP was then set to the time required by the regulation (20 seconds for 902-928 MHz devices, if the 20dB bandwidth is less than 250kHz, 10 seconds for 902-928 MHz if the 20dB bandwidth is or greater than 250kHz, "0.4 seconds x Number of hopping channels employed" seconds for 2400-2483.5 MHz, 30 seconds for 5725-5850 MHz). The analyzer was set to SINGLE SWEEP, the total ON time was added and compared against the limit (0.4 seconds).

Parent Unit (worst-case:)	
Average Occupancy Time = 0.1128 ms x 11 x 5	6.204 ms

Limits:

Average 0.4 seconds maximum occupancy in:

- 6.4 seconds (0.4 sec. x 16) for 2400MHz-2483.5MHz
- 20 seconds for 902MHz-928MHz \geq 50 hopping channels
- 10 seconds for 902MHz-928MHz \geq 25 hopping channels
- 30 seconds for 5725-5850MHz

The plots of average channel occupancy time are saved as below.

INTERTEK TESTING SERVICES

Plots of average channel occupancy time

Plot A, TX time for on pulse

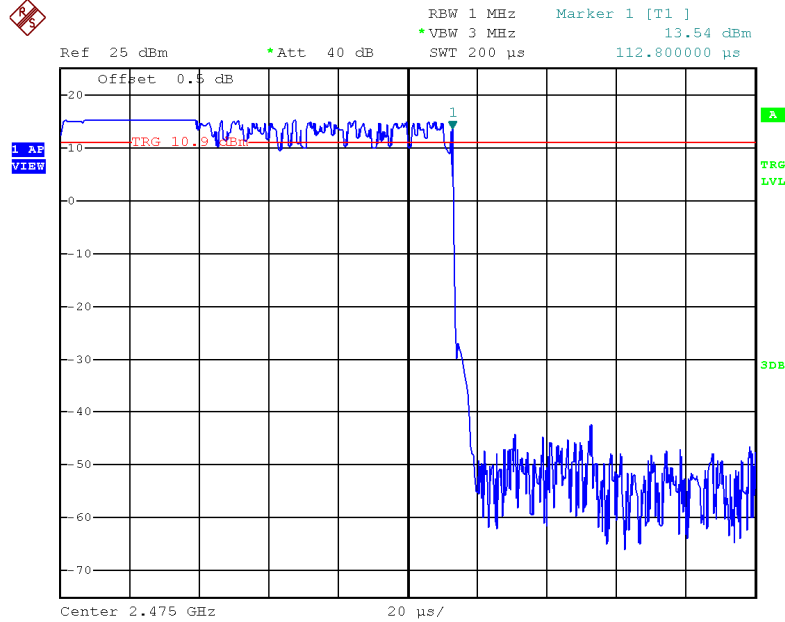

Date: 13.JUN.2016 14:37:24

Plot B, No. of TX in 6.4s

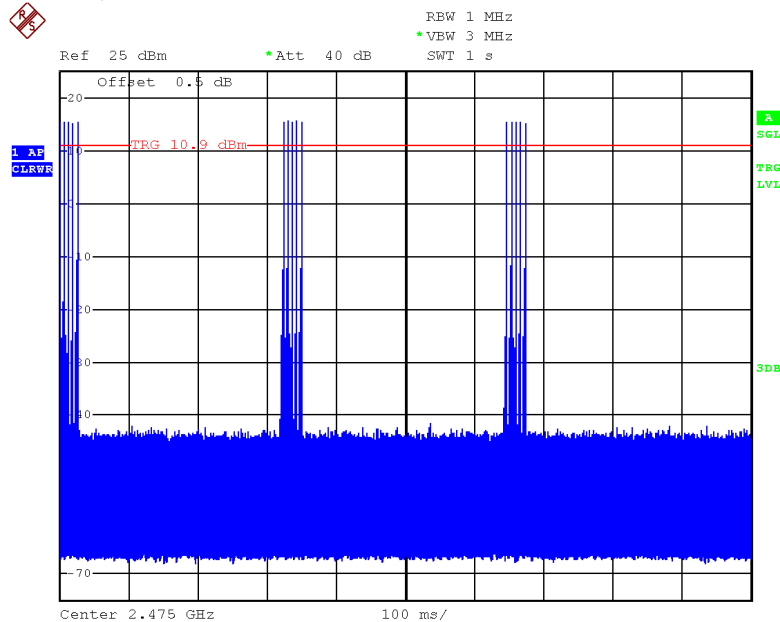

Date: 13.JUN.2016 14:35:27

INTERTEK TESTING SERVICES

Plots of average channel occupancy time

Plot C, No. of TX in 6.4s

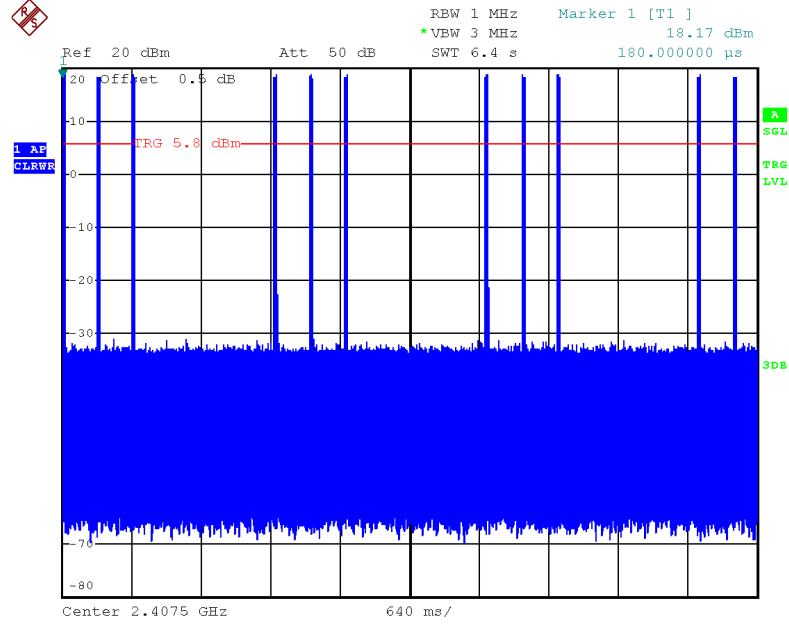

Date: 14.JUN.2016 15:19:27

INTERTEK TESTING SERVICES

4.6 Out of Band Conducted Emissions

In any 100 kHz bandwidth outside the EUT passband, the RF power produced by the modulation products of the spreading sequence, the information sequence, and the carrier frequency shall be at least 20 dB below that of the maximum in-band 100 kHz emission.

The plot(s) of bandedge compliance is shown the worst-case which has been already considered between enable and disable the hopping function of the EUT.

Limits:

All spurious emission and up to the tenth harmonic was measured and they were found to be at least 20 dB below the highest level of the desired power in the passband.

The plots of out of band conducted emissions and bandedge are saved as below.

INTERTEK TESTING SERVICES

Plots of out of band conducted emissions Lowest channel, Plot 1

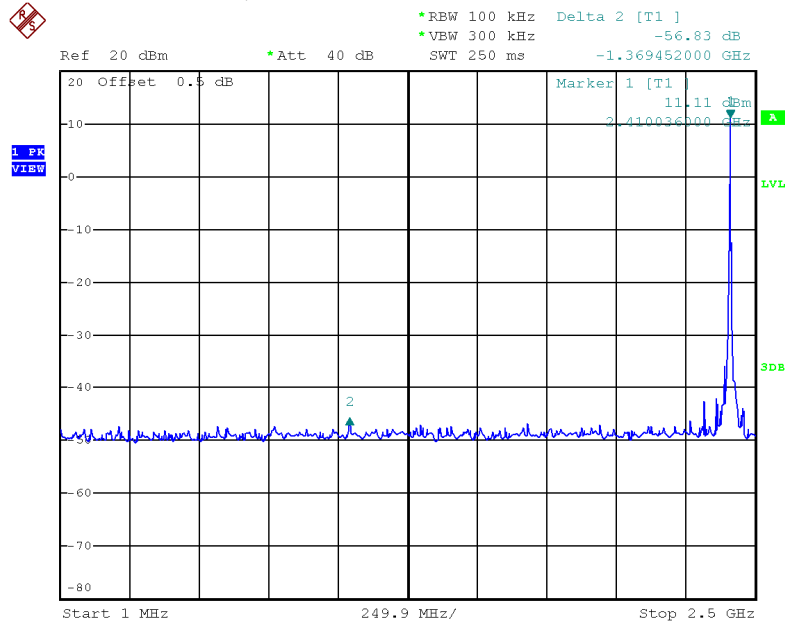

Date: 13.JUN.2016 12:04:06

Lowest channel, Plot 2

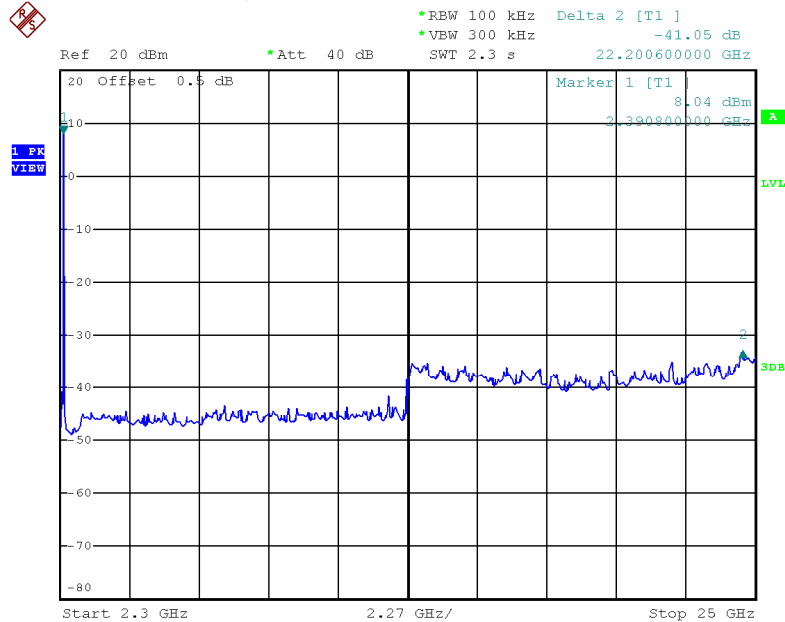

Date: 13.JUN.2016 12:02:10

INTERTEK TESTING SERVICES

Plots of out of band conducted emissions Middle channel, Plot 1

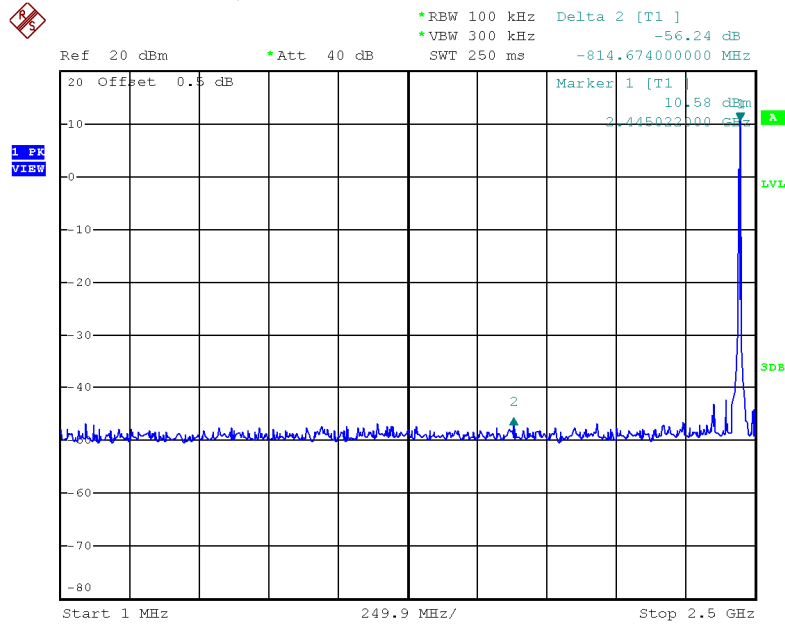

Date: 13.JUN.2016 12:04:50

Middle channel, Plot 2

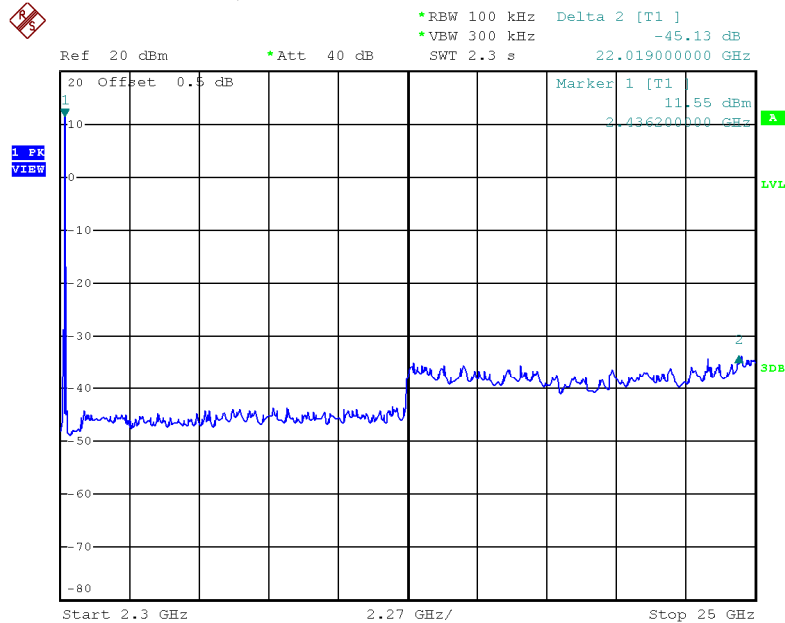

Date: 13.JUN.2016 12:00:54

INTERTEK TESTING SERVICES

Plots of out of band conducted emissions Highest channel, Plot 1

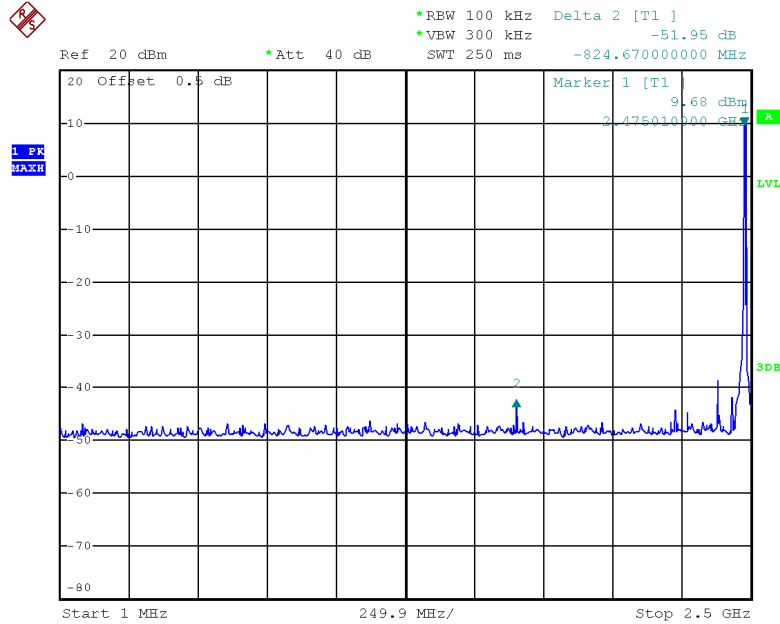

Date: 13.JUN.2016 11:58:56

Highest channel, Plot 2

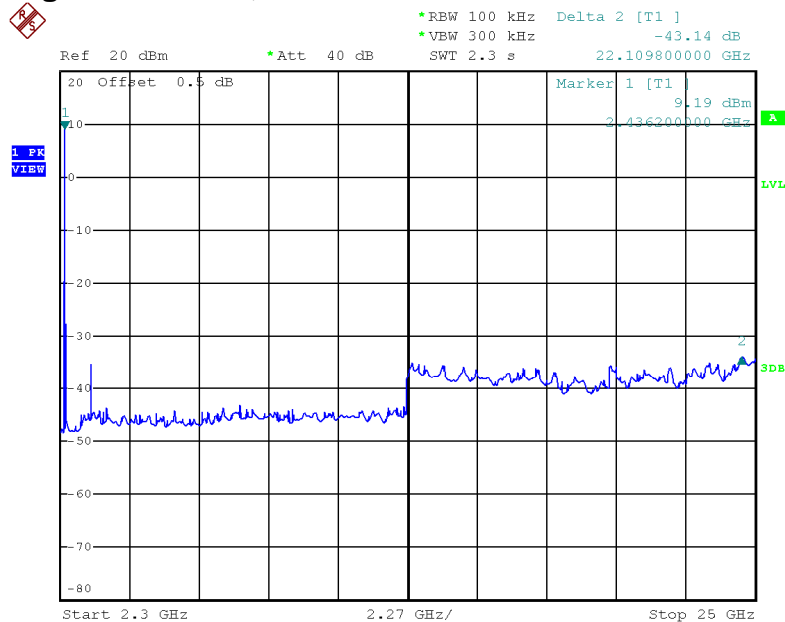

Date: 13.JUN.2016 11:59:51

INTERTEK TESTING SERVICES

Plots of bandedge Lowest bandedge

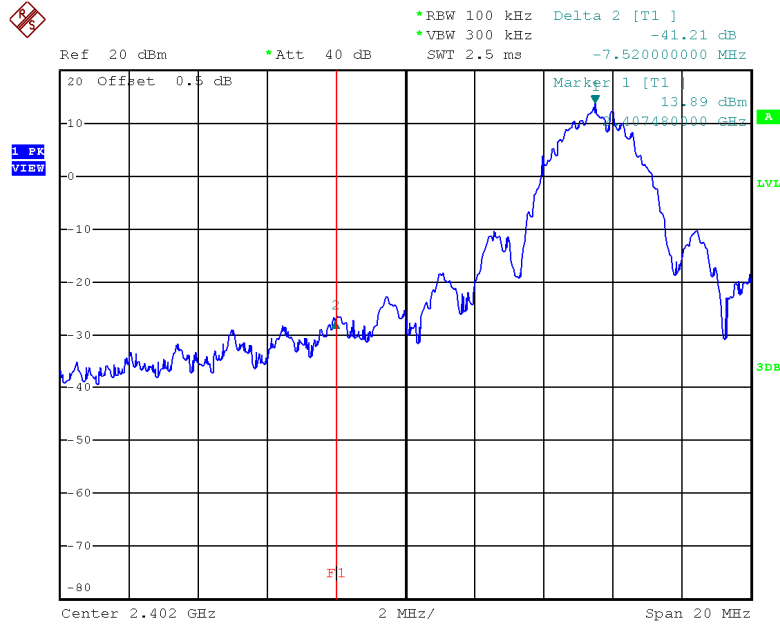

Date: 13.JUN.2016 11:53:02

Highest bandedge

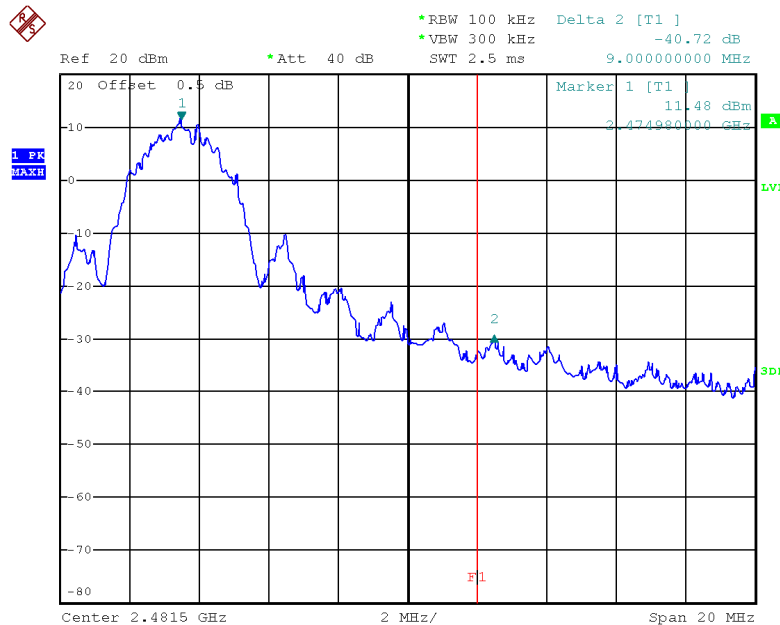

Date: 13.JUN.2016 11:57:06

INTERTEK TESTING SERVICES

4.7 Field Strength Calculation

The field strength is calculated by adding the reading on the Spectrum Analyzer to the factors associated with preamplifiers (if any), antennas, cables, pulse desensitization and average factors (when specified limit is in average and measurements are made with peak detectors). A sample calculation is included below.

$$FS = RA + AF + CF - AG + PD + AV$$

where

- FS = Field Strength in dB μ V/m
- RA = Receiver Amplitude (including preamplifier) in dB μ V
- CF = Cable Attenuation Factor in dB
- AF = Antenna Factor in dB
- AG = Amplifier Gain in dB
- PD = Pulse Desensitization in dB
- AV = Average Factor in -dB

In the radiated emission table which follows, the reading shown on the data table may reflect the preamplifier gain. An example of the calculations, where the reading does not reflect the preamplifier gain, follows:

$$FS = RA + AF + CF - AG + PD + AV$$

Example

Assume a receiver reading of 62.0 dB μ V is obtained. The antenna factor of 7.4 dB and cable factor of 1.6 dB is added. The amplifier gain of 29 dB is subtracted. The pulse desensitization factor of the spectrum analyzer was 0 dB, and the resultant average factor was -10 dB. The net field strength for comparison to the appropriate emission limit is 32 dB μ V/m. This value in dB μ V/m was converted to its corresponding level in μ V/m.

$$\begin{aligned} RA &= 62.0 \text{ dB}\mu\text{V} \\ AF &= 7.4 \text{ dB} \\ CF &= 1.6 \text{ dB} \\ AG &= 29 \text{ dB} \\ PD &= 0 \text{ dB} \\ AV &= -10 \text{ dB} \\ FS &= 62 + 7.4 + 1.6 - 29 + 0 + (-10) = 32 \text{ dB}\mu\text{V/m} \end{aligned}$$

$$\text{Level in } \mu\text{V/m} = \text{Common Antilogarithm} [(32 \text{ dB}\mu\text{V/m})/20] = 39.8 \mu\text{V/m}$$

INTERTEK TESTING SERVICES

4.8 Transmitter Radiated Emissions in Restricted Bands and Spurious Emissions

Data is included of the worst case configuration (the configuration which resulted in the highest emission levels). A sample calculation, configuration photographs and data tables of the emissions are included.

The data on the following pages list the significant emission frequencies, the limit and the margin of compliance.

INTERTEK TESTING SERVICES

4.8.1 Radiated Emission Configuration Photograph

Worst Case Restricted Band Radiated Emission
at

672.019 MHz

The worst case radiated emission configuration photographs are attached in the Appendix and saved with filename: config photos.pdf

4.8.2 Radiated Emission Data

The data in tables 1-4 list the significant emission frequencies, the limit and the margin of compliance.

Judgement -

Passed by 7.4 dB margin

INTERTEK TESTING SERVICES

4.8.3 Radiated Emission Test Setup

The figure below shows the test setup, which is utilized to make these measurements.

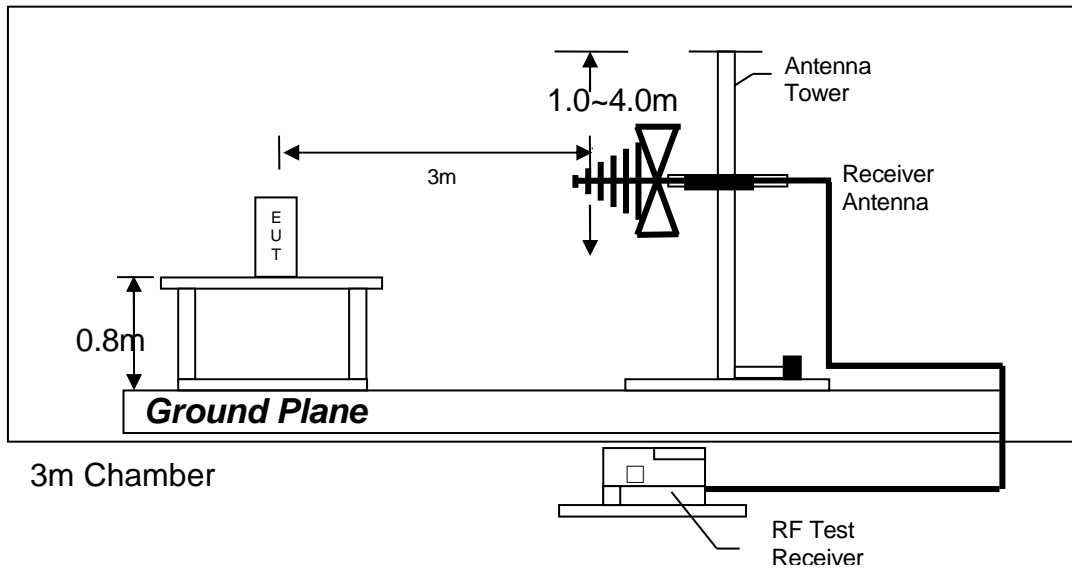

Test setup of radiated emissions up to 1GHz

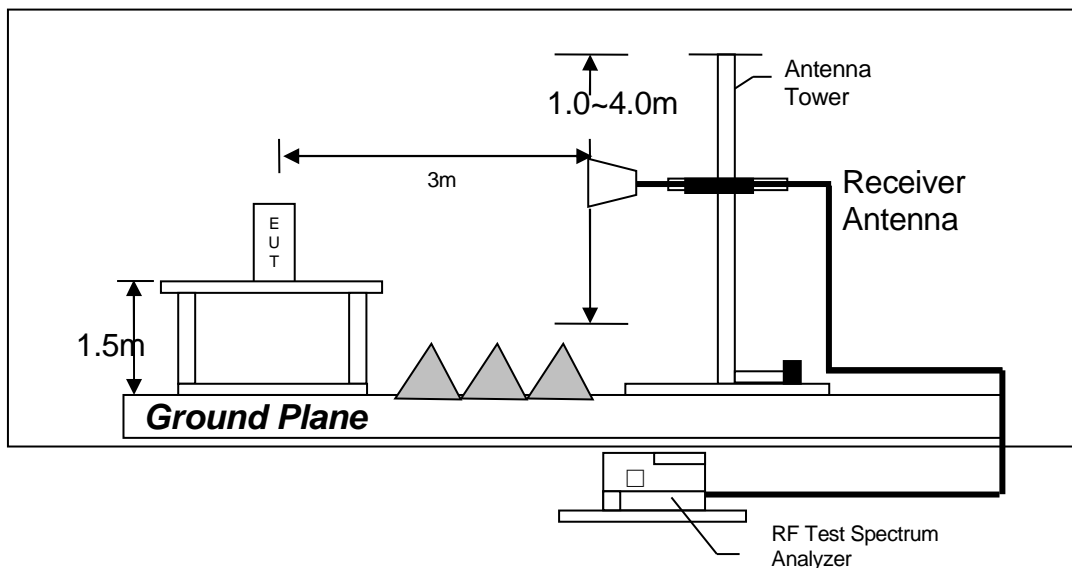

Test setup of radiated emissions above 1GHz

INTERTEK TESTING SERVICES

Mode: TX-Channel 00

Table 1

Radiated Emission Data

Polarization	Frequency (MHz)	Reading (dB μ V)	Pre-Amp Gain (dB)	Antenna Factor (dB)	Average Factor (dB)	Calculated at 3m (dB μ V/m)	Average Limit at 3m (dB μ V/m)	Margin (dB)
V	2390.000	56.2	33	29.4	44.97	7.6	54.0	-46.4
V	4815.000	52.5	33	34.9	44.97	9.4	54.0	-44.6
V	12037.500	48.0	33	40.5	44.97	10.5	54.0	-43.5

Polarization	Frequency (MHz)	Reading (dB μ V)	Pre-Amp Gain (dB)	Antenna Factor (dB)	Net at 3m - Peak (dB μ V/m)	Peak Limit at 3m (dB μ V/m)	Margin (dB)
V	2390.000	56.2	33	29.4	52.6	74.0	-21.4
V	4815.000	52.5	33	34.9	54.4	74.0	-19.6
V	12037.500	48.0	33	40.5	55.5	74.0	-18.5

- NOTES:
1. Peak detector is used for the emission measurement.
 2. All measurements were made at 3 meters. Radiated emissions not detected at the 3-meter distance were measured at 0.3-meter and an inverse proportional extrapolation was performed to compare the signal level to the 3-meter limit. No other radiated emissions than those reported were detected at a test distance of 0.3-meter.
 3. Negative value in the margin column shows emission below limit.
 4. Horn antenna is used for the emission over 1000MHz.
 5. Emission (the row indicated by **bold italic**) within the restricted band meets the requirement of FCC Part 15 Section 15.205 / RSS-247 Section 3.3.

INTERTEK TESTING SERVICES

Mode: TX-Channel 10

Table 2

Radiated Emission Data

Polarization	Frequency (MHz)	Reading (dB μ V)	Pre-Amp Gain (dB)	Antenna Factor (dB)	Average Factor (dB)	Calculated at 3m (dB μ V/m)	Average Limit at 3m (dB μ V/m)	Margin (dB)
V	4882.500	52.8	33	34.9	44.97	9.7	54.0	-44.3
V	7323.750	50.9	33	37.9	44.97	10.8	54.0	-43.2
V	12206.250	48.2	33	40.5	44.97	10.7	54.0	-43.3

Polarization	Frequency (MHz)	Reading (dB μ V)	Pre-Amp Gain (dB)	Antenna Factor (dB)	Net at 3m - Peak (dB μ V/m)	Peak Limit at 3m (dB μ V/m)	Margin (dB)
V	4882.500	52.8	33	34.9	54.7	74.0	-19.3
V	7323.750	50.9	33	37.9	55.8	74.0	-18.2
V	12206.250	48.2	33	40.5	55.7	74.0	-18.3

- NOTES:
1. Peak detector is used for the emission measurement.
 2. All measurements were made at 3 meters. Radiated emissions not detected at the 3-meter distance were measured at 0.3-meter and an inverse proportional extrapolation was performed to compare the signal level to the 3-meter limit. No other radiated emissions than those reported were detected at a test distance of 0.3-meter.
 3. Negative value in the margin column shows emission below limit.
 4. Horn antenna is used for the emission over 1000MHz.
 5. Emission (the row indicated by **bold italic**) within the restricted band meets the requirement of FCC Part 15 Section 15.205 / RSS-247 Section 3.3.

INTERTEK TESTING SERVICES

Mode: TX-Channel 20

Table 3

Radiated Emission Data

Polarization	Frequency (MHz)	Reading (dB μ V)	Pre-Amp Gain (dB)	Antenna Factor (dB)	Average Factor (dB)	Calculated at 3m (dB μ V/m)	Average Limit at 3m (dB μ V/m)	Margin (dB)
V	<i>2483.500</i>	<i>56.3</i>	<i>33</i>	<i>29.4</i>	<i>44.97</i>	<i>7.7</i>	<i>54.0</i>	<i>-46.3</i>
V	<i>4950.000</i>	<i>52.7</i>	<i>33</i>	<i>34.9</i>	<i>44.97</i>	<i>9.6</i>	<i>54.0</i>	<i>-44.4</i>
V	<i>7425.000</i>	<i>50.8</i>	<i>33</i>	<i>37.9</i>	<i>44.97</i>	<i>10.7</i>	<i>54.0</i>	<i>-43.3</i>
V	<i>12375.000</i>	<i>48.2</i>	<i>33</i>	<i>40.5</i>	<i>44.97</i>	<i>10.7</i>	<i>54.0</i>	<i>-43.3</i>

Polarization	Frequency (MHz)	Reading (dB μ V)	Pre-Amp Gain (dB)	Antenna Factor (dB)	Net at 3m - Peak (dB μ V/m)	Peak Limit at 3m (dB μ V/m)	Margin (dB)
V	<i>2483.500</i>	<i>56.3</i>	<i>33</i>	<i>29.4</i>	<i>52.7</i>	<i>74.0</i>	<i>-21.3</i>
V	<i>4950.000</i>	<i>52.7</i>	<i>33</i>	<i>34.9</i>	<i>54.6</i>	<i>74.0</i>	<i>-19.4</i>
V	<i>7425.000</i>	<i>50.8</i>	<i>33</i>	<i>37.9</i>	<i>55.7</i>	<i>74.0</i>	<i>-18.3</i>
V	<i>12375.000</i>	<i>48.2</i>	<i>33</i>	<i>40.5</i>	<i>55.7</i>	<i>74.0</i>	<i>-18.3</i>

- NOTES:
1. Peak detector is used for the emission measurement.
 2. All measurements were made at 3 meters. Radiated emissions not detected at the 3-meter distance were measured at 0.3-meter and an inverse proportional extrapolation was performed to compare the signal level to the 3-meter limit. No other radiated emissions than those reported were detected at a test distance of 0.3-meter.
 3. Negative value in the margin column shows emission below limit.
 4. Horn antenna is used for the emission over 1000MHz.
 5. Emission (the row indicated by ***bold italic***) within the restricted band meets the requirement of FCC Part 15 Section 15.205 / RSS-247 Section 3.3.

INTERTEK TESTING SERVICES

Mode: Live

Table 4

Radiated Emission Data

Polarization	Frequency (MHz)	Reading (dB μ V)	Pre-amp (dB)	Antenna Factor (dB)	Net at 3m (dB μ V/m)	Limit at 3m (dB μ V/m)	Margin (dB)
V	31.334	26.7	16	10.0	20.7	40.0	-19.3
V	59.949	25.3	16	10.0	19.3	40.0	-20.7
V	131.971	23.9	16	14.0	21.9	43.5	-21.6
H	240.005	22.6	16	19.0	25.6	46.0	-20.4
H	335.914	19.9	16	24.0	27.9	46.0	-18.1
H	431.944	21.9	16	25.0	30.9	46.0	-15.1
H	575.989	18.1	16	28.0	30.1	46.0	-15.9
H	672.019	25.6	16	29.0	38.6	46.0	-7.4
H	768.049	19.4	16	31.0	34.4	46.0	-11.6
H	864.079	17.1	16	31.0	32.1	46.0	-13.9

- NOTES:
1. Quasi-peak detector is used for the emission measurement.
 2. All measurements were made at 3 meters. Radiated emissions not detected at the 3-meter distance were measured at 0.3-meter and an inverse proportional extrapolation was performed to compare the signal level to the 3-meter limit. No other radiated emissions than those reported were detected at a test distance of 0.3-meter.
 3. Negative value in the margin column shows emission below limit.
 4. Emission (the row indicated by ***bold italic***) within the restricted band meets the requirement of FCC Part 15 Section 15.205 / RSS-247 Section 3.3.

INTERTEK TESTING SERVICES

4.8.4 Transmitter Duty Cycle Calculation

$$\begin{aligned}\text{Duty Cycle (DC)} &= \text{Maximum On time in } 100\text{ms}/100\text{ms} \\ &= (0.1128\text{ms} \times 5)/100\text{ms}\end{aligned}$$

$$\begin{aligned}\text{Average Factor (AF)} &= 20 \log (\text{DC}) \\ &= 20 * \log (0.00564) \\ &= -44.97\text{dB}\end{aligned}$$

The EUT antenna output port was connected to the input of the spectrum analyzer. The analyzer center frequency was set to EUT RF channel carrier. The SPAN function on the analyzer was set to ZERO. The transmitter ON time was determined from the resultant time-amplitude display.

Please refer to the attached plot(s) for more details.

INTERTEK TESTING SERVICES

Plots of transmitter On time Plot A, Tx on time

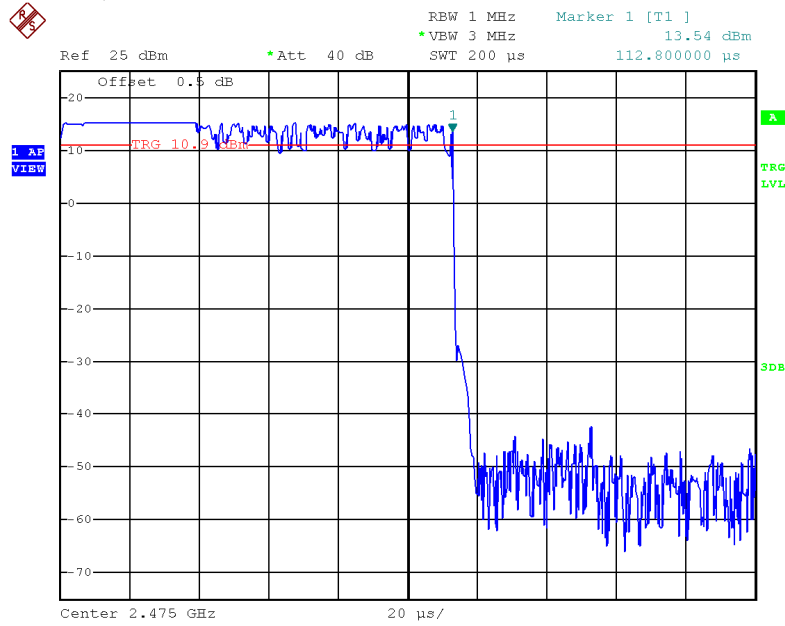

Date: 13.JUN.2016 14:37:24

Plot B, Tx time in 100ms

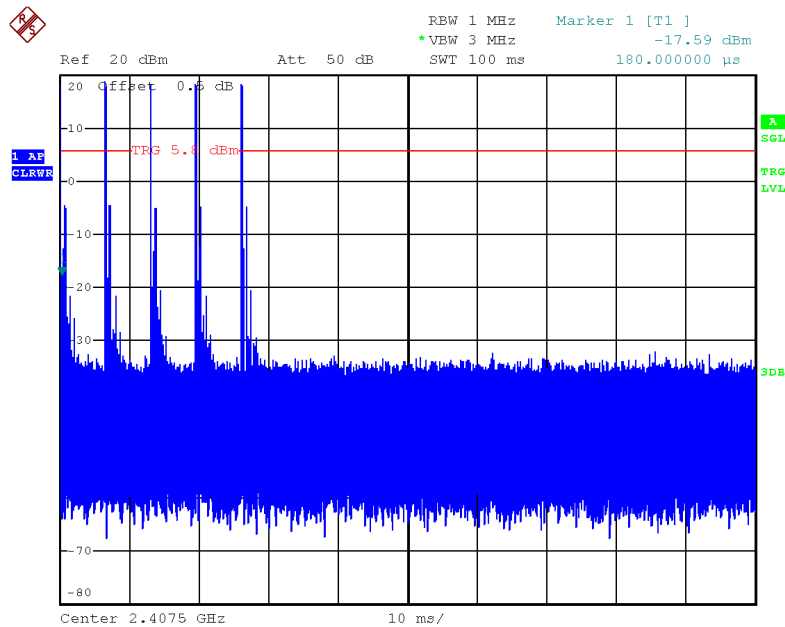

Date: 14.JUN.2016 15:20:26

INTERTEK TESTING SERVICES

4.9 AC Power Line Conducted Emission

- Not applicable – EUT is only powered by battery for operation.
- EUT connects to AC power line. Emission Data is listed in following pages.

- Base Unit connects to AC power line and has transmission. Handset connects to AC power line but has no transmission. Emission Data of Base Unit is listed in following pages.

4.9.1 AC Power Line Conducted Emission Configuration Photograph

Worst Case Line-Conducted Configuration
at

2.292 MHz

The worst case line conducted configuration photographs are attached in the Appendix and saved with filename: config photos.pdf

4.9.2 AC Power Line Conducted Emission Data

The plot(s) and data in the following pages list the significant emission frequencies, the limit and the margin of compliance.

Passed by 11.58 dB margin compare with average limit

INTERTEK TESTING SERVICES

Worst Case: Live Mode (Video On)



RBW 9 kHz
MT 1 s

Att 10 dB AUTO PREAMP OFF

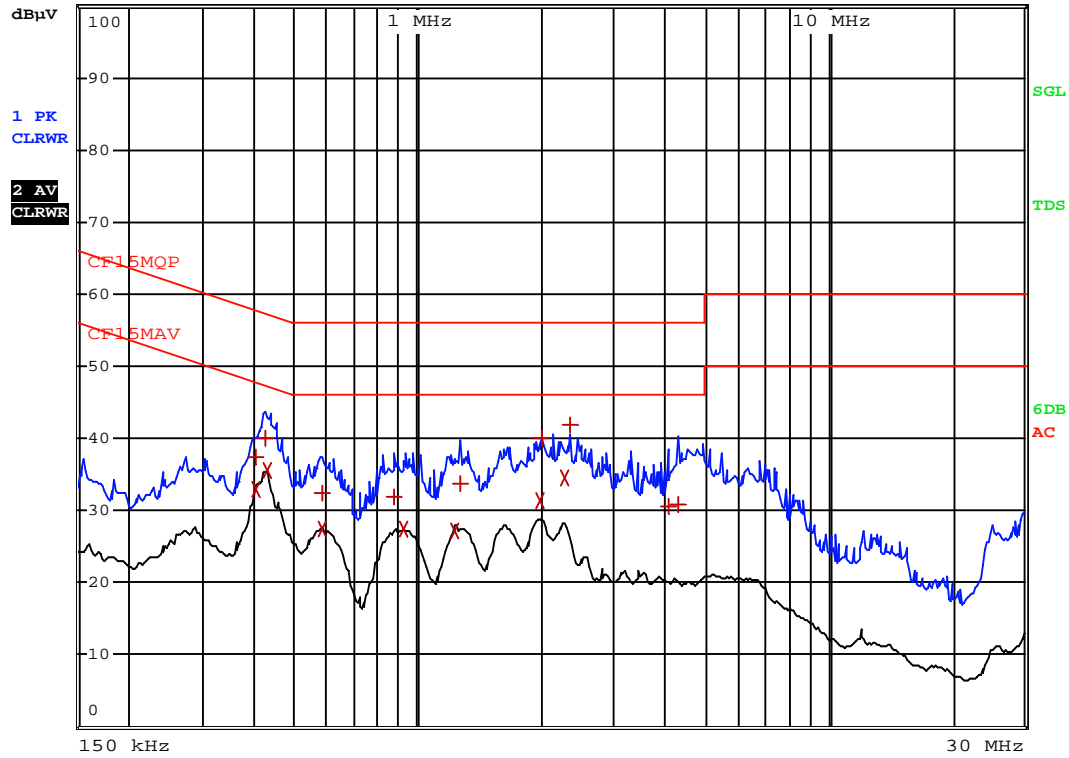

Date: 13.JUN.2016 11:58:04

INTERTEK TESTING SERVICES

Worst Case: Live Mode (Video On)

EDIT PEAK LIST (Final Measurement Results)

Trace1: CF15MQP
Trace2: CF15MAV
Trace3: ---

	TRACE	FREQUENCY	LEVEL dB μ V		DELTA LIMIT dB
1	Quasi Peak	402 kHz	37.44	L1	-20.36
2	CISPR Average	402 kHz	32.98	L1	-14.83
1	Quasi Peak	424.5 kHz	40.06	L1	-17.29
2	CISPR Average	429 kHz	35.45	L1	-11.81
1	Quasi Peak	586.5 kHz	32.50	L1	-23.49
2	CISPR Average	586.5 kHz	27.51	L1	-18.48
1	Quasi Peak	879 kHz	31.98	N	-24.01
2	CISPR Average	928.5 kHz	27.34	L1	-18.65
2	CISPR Average	1.2345 MHz	27.23	L1	-18.76
1	Quasi Peak	1.275 MHz	33.78	N	-22.22
2	CISPR Average	1.9905 MHz	31.46	N	-14.53
1	Quasi Peak	2.0085 MHz	39.90	N	-16.09
2	CISPR Average	2.292 MHz	34.41	N	-11.58
1	Quasi Peak	2.355 MHz	41.88	N	-14.11
1	Quasi Peak	4.1055 MHz	30.54	N	-25.45
1	Quasi Peak	4.2945 MHz	30.79	N	-25.20

Date: 13.JUN.2016 11:57:54

INTERTEK TESTING SERVICES

**EXHIBIT 5
EQUIPMENT LIST**

INTERTEK TESTING SERVICES

5.0 Equipment List

1) Radiated Emissions Test

Equipment	EMI Test Receiver	Spectrum Analyzer	Biconical Antenna
Registration No.	EW-3156	EW-2249	EW-3061
Manufacturer	R&S	R&S	EMCO
Model No.	ESR26	FSP30	3412E
Calibration Date	Nov 3, 2015	Nov. 27, 2015	Jul. 22, 2015
Calibration Due Date	Nov 3, 2016	Nov. 27, 2016	Jul. 22, 2016

Equipment	Log Periodic Antenna	Pyramidal Horn Antenna (18.0 - 26.5)GHz
Registration No.	EW-1133	EW-0905
Manufacturer	EMCO	EMCO
Model No.	3115	3160-09
Calibration Date	Nov. 05, 2015	Feb. 12, 2016
Calibration Due Date	May 05, 2017	Aug 12, 2017

2) Conducted Emissions Test

Equipment	EMI Test Receiver	LISN
Registration No.	EW-3095	EW-2501
Manufacturer	R&S	R&S
Model No.	ESCI	ENV-216
Calibration Date	Nov. 05, 2015	Jan. 28, 2016
Calibration Due Date	Nov. 05, 2016	Jan. 28, 2017

3) Conductive Measurement Test

Equipment	Spectrum Analyzer
Registration No.	EW-2466
Manufacturer	R&S
Model No.	FSP30
Calibration Date	Sep. 16, 2015
Calibration Due Date	Aug. 20, 2016

END OF TEST REPORT