

**FCC Part 15 C Notice**

CAUTION: Changes or modifications not expressly approved by the party responsible for compliance could void the user's authority to operate the equipment.

NOTE: This equipment has been tested and found to comply with the limits for a Class B digital device, pursuant to Part 15 of the FCC Rules. These limits are designed to provide reasonable protection against harmful interference in a residential installation. This equipment generates, uses and can radiate radio frequency energy and, if not installed and used in accordance with the instructions, may cause harmful interference to radio communications. However, there is no guarantee that interference will not occur in a particular installation. If this equipment does cause harmful interference to radio or television reception, which can be determined by turning the equipment off and on, the user is encouraged to try to correct the interference by one or more of the following measures:

- Reorient or relocate the receiving antenna.
- Increase the separation between the equipment and receiver.
- Connect the equipment into an outlet on a circuit different from that to which the receiver is connected.
- Consult the dealer or experienced radio/TV technician for help.

This device complies with Part 15 of the FCC Rules. Operation is subject to the following two conditions : (1) This device may not cause harmful interference, and

(2) this device must accept any interference received, including interference that may cause undesired operation.

\*This device complies with FCC and IC radiation exposure limits set forth for an uncontrolled environment. The device should be installed and operated with a minimum distance of 20cm between the radiator and your body. This device must not be collocated or operating in conjunction with any other antenna or transmitter.

**INDUSTRY CANADA NOTICE: CANADA ONLY.**

This device complies with Industry Canada licence-exempt RSS standard(s). Operation is subject to the following two conditions: (1) this device may not cause interference, and (2) this device must accept any interference, including interference that may cause undesired operation of the device.

Le présent appareil est conforme aux CNR d'Industrie Canada applicables aux appareils radio exempts de licence. L'exploitation est autorisée aux deux conditions suivantes : (1) l'appareil ne doit pas produire de brouillage, et (2) l'utilisateur de l'appareil doit accepter tout brouillage radioélectrique subi, même si le brouillage est susceptible d'en compromettre le fonctionnement.

**WARNING!**  
**AVERTISSEMENT:**  
**¡ADVERTENCIA!**

CHOKING HAZARD - Small parts.  
Not suitable for children under 3 years.  
CHOKING HAZARD - Pièces de petite taille. N'est pas conçu pour des enfants de moins de 3 ans.  
PELIGRO DE ASFIXIA - Partes pequeñas. No apto para niños menores de 3 años.

**microSDHC CLASS 6**

Requires Class 6 or higher microSDHC card (not included)

microSDHC Logo is a trademark of SD-3C, LLC.

Conforms to safety requirements of FCC.

PROPEL RC™ and SKY MASTER™ are trademarks of Rooftop Brands.

8619 Wall street, Suite 400, Austin, TX 78754 tel: 949.566.9573

© 2016 Rooftop Brands™. All Rights Reserved. www.propelrc.com. Made in China

CAN ICES-3(B)/NMB-3(B)



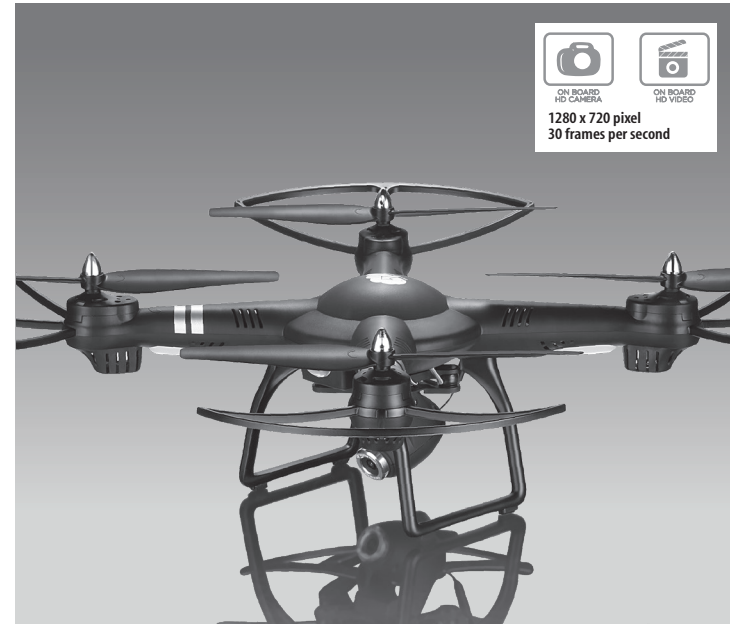



**SKY MASTER™ + FPV**  
2.4GHz Quadcopter With HD Camera

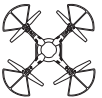

**INSTRUCTION BOOKLET**

**WARNING:** Never leave product charging unattended for extended periods of time. Always disconnect Sky Master™ battery from charger immediately after it is fully charged. Please refer to enclosed safety instructions.

**PACKAGE CONTAINS:**

 Sky Master™
  2.4G Wireless Controller
  Spare Parts
  AC Charger & Li-Poly Rechargeable Battery
  Phone Holder
  USB Card Reader
  Instruction Manual

Colors and styles may slightly vary.

 PROPEL

## TABLE OF CONTENTS

Product Features .....	2
Remote Control Battery Installation .....	2
Charging Your Sky Master™ Battery .....	2
Sky Master™ Quadcopter Diagram .....	3
Sky Master™ Remote Control Diagram .....	3
Sky Master™ Remote LCD Diagram .....	3
Flight Preparation .....	4
Syncing Your Sky Master™ .....	4
Flying Tips .....	4
Recognizing The Front & Back Of The Sky Master™ .....	5
How To Start/Stop Rotors .....	5
Auto Land Button .....	5
4 Channel Flight Control .....	5
Adjusting Trim .....	6
Calibrating the Sky Master™ .....	7
Flight Practice .....	7
Speed Select Button .....	7
Headless Mode Button .....	7
How to Perform 360° Stunt Rolls .....	8
Using Your On-Board Camera and Video Recorder .....	9
Using Your On-Board Camera and Video Recorder .....	10
Live Video Streaming Setup .....	11
Trouble Shooting .....	13
Replacing The Propeller Blades .....	13
Attaching the Blade Guards .....	14
Skymaster™ Warnings .....	14
Battery Warnings .....	14
Care and Maintenance .....	14
FCC Information .....	15

Thank you for purchasing the Sky Master™ 2.4 Ghz Quadcopter. Please read this instruction booklet as it contains valuable information on how to properly fly and care for your Sky Master™ Drone.

## FEATURES

- 6 Axis Gyro For Extremely Stable Flight and Maneuverability
- Wide Range Digital Radio Allows Flight Range Up To 500 Feet
- Takes Video and Still Shots With Onboard Camera
- 3 Speed Settings From Beginner To Advanced Pilots
- 360 Degree Push Button Stunt Rolls
- Air pressure sensors lock flight altitude for stable video footage
- Automatically lands with the push of a button
- 2.4 Ghz Controller, Replaceable Li-poly Battery and Additional Replacement Parts Included.

## REMOTE CONTROL BATTERY INSTALLATION

1. Remove the battery cover from the back of the controller as shown in diagram A.
2. Install 4 "AA" fresh alkaline batteries into the controller as shown in diagram B. Make sure to install batteries to their correct polarity. Do not mix old and new batteries or battery types.
3. Replace the battery cover.

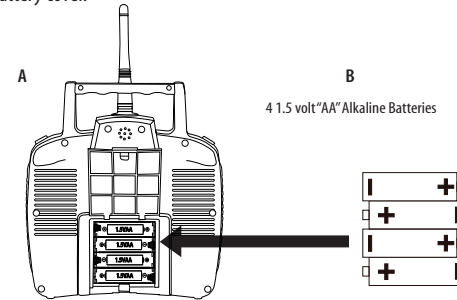

## CHARGING YOUR SKY MASTER™ LI-POLY BATTERY

1. Connect the battery to the charging box. Plug the adapter into the charging box and plug into standard outlet (see diagram C).  
CAUTION: improper connection may damage the Sky Master™ battery.
2. The indicator light will glow Red while the unit is charging. When the Red Led light turns off, your battery has a complete charge.
3. Average charging time is around 100 minutes to fully charged.
4. A full charge will allow for about 7-10 minutes of flight time depending on environment and user input.

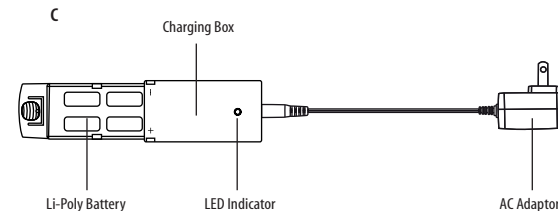

**IMPORTANT: ALWAYS REMEMBER TO UNPLUG YOUR CHARGING CORD WHEN NOT IN USE!**

### SKY MASTER™ QUADROPTER DIAGRAM

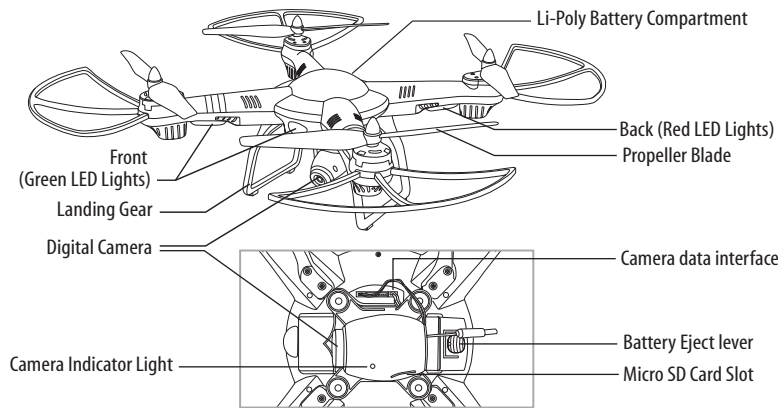

### SKY MASTER™ REMOTE DIAGRAM

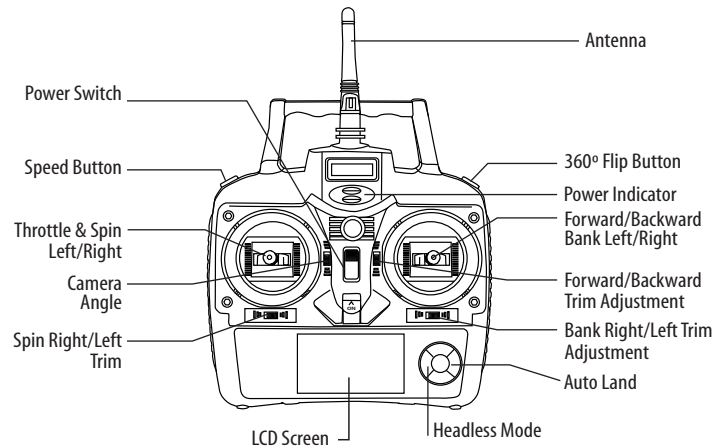

### SKY MASTER™ REMOTE LCD DIAGRAM

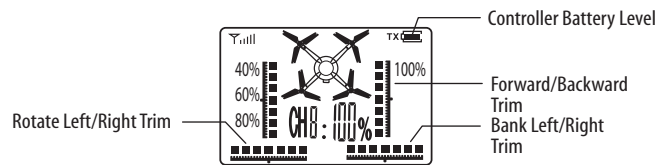

### WARNING

**DO NOT FLY YOUR SKY MASTER™ IN FOUL WEATHER!**



### FLIGHT PREPARATION

- Verify that there are 4 "AA" batteries inside the remote control unit and the Sky Master™ has been fully charged.
- Make sure your Sky Master™ and controller are both turned on.
- Make sure to be in a large space with an open radius of at least 200 feet.
- Make sure the empty space has no obstacles. Set your Sky Master™ on a clean flat surface before take-off.

**DO NOT ATTEMPT TO FLY YOUR SKY MASTER™ IF THERE IS RAIN, SNOW, HEAVY WINDS, THUNDER OR LIGHTNING OUTDOORS. IT COULD DAMAGE YOUR PRODUCT AND POSSIBLY EVEN CAUSE BODILY HARM.**

### SYNCING YOUR SKY MASTER™

**Important!** When syncing your Sky Master™ quadcopter with the controller always make sure that the quadcopter is on a flat level surface and that your digital trim settings are in the center position. This insures that the 6 Axis gyro is properly programmed to mimic your trim settings.

Your Sky Master™ utilizes an automatic 2.4G channel selection system that allows up to 8 people to fly side by side in the same wireless range with no interference.

#### Syncing your aircraft:

1. Before starting, make sure that the power on your controller is in the OFF position and the Sky Master™ battery is not inserted. Make sure that there are no other 2.4Ghz devices in the area as well .
2. Connect the battery to the Sky Master™ and set it down on a flat surface. The LED indicator lights of the Sky Master™ should begin to flash (see diagram D).
3. Next turn ON the remote controller. After hearing a series of beeps, the Sky Master's™ flashing LED lights will change to a solid glow signaling that the drone and controller have been synced. If this does not happen, repeat all steps above.

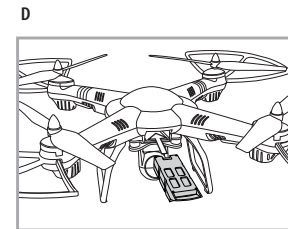

### FLYING TIPS

- It is recommended that you operate the Sky Master™ outdoors in a wide space. The ideal space should have a 200 foot radius.
- Parental guidance or adult supervision is suggested at all times.
- If you are flying the Sky Master™ with others, make sure all spectators are behind you.
- For best performance, it is recommended that you operate the Sky Master™ in zero wind conditions. Wind can greatly affect the performance of the aircraft or cause injury.

## RECOGNIZING THE FRONT & BACK OF THE SKY MASTER™

Even though the Sky Master™ has four rotors there is still a front or "forward" facing direction and "back" or backwards facing direction. The front of the Quadcopter displays GREEN LED lights and the back of the Quadcopter displays RED LED lights when activated (see diagram E).

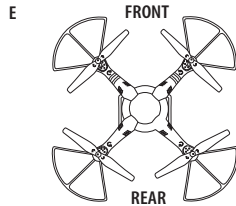

## HOW TO START/STOP ROTORS

Make sure you have properly synced the Sky Master™ and the power is on.

- To start and stop the rotors simply move the two control sticks simultaneously down and to the outside corners.

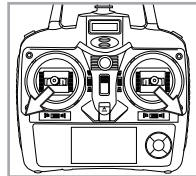

- Once the rotors begin to spin release the control sticks and they will return to the center position. Now you are ready for take-off.

## AUTO LAND BUTTON

The Sky Master™ has an auto land feature which allows you to land automatically. Simply press the Auto Land button and your Sky Master™ will begin to land itself (see diagram below).

Note: you can still control the direction while auto landing to avoid obstacles

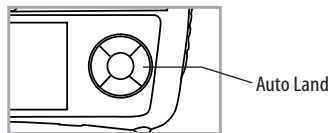

## 4 CHANNEL FLIGHT CONTROL

Below is a list of basic flight functions for your long-range remote control Sky Master™. While learning to fly your Sky Master™ it is best to start with a large space until you get used to the basic controls. As you master flying your Sky Master™ you can move to more advanced maneuvering techniques. Practice makes perfect! When you have these basic steps down you can move to the next level.

Move the left Throttle stick up to increase the speed and the Sky Master™ will accelerate and ascend.  
Move the left Throttle stick down to decrease the speed and the Sky Master™ will decelerate and descend (see diagram F).

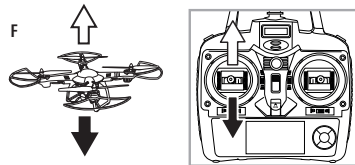

Move the left Throttle stick left while in flight and the Sky Master™ will rotate left.  
Move the left Throttle stick right and the Sky Master™ will rotate right (see diagram G).

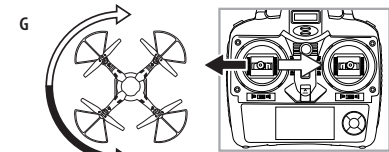

Move the right Direction Stick up while in flight and the Sky Master™ will move forward.  
Move the right Direction Control down while in flight and the Sky Master™ will move backward (see diagram H).

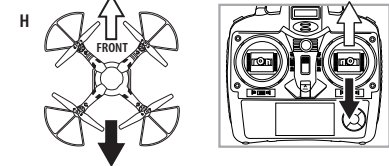

Move the right Direction Stick left and the Sky Master™ will bank to the left.  
Move the right Direction Stick right and the Sky Master™ will bank to the right (see diagram I).

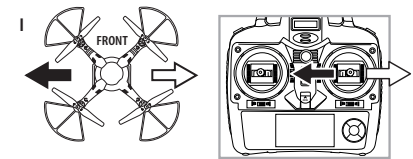

## ADJUSTING TRIM

From time to time you may have to adjust the TRIM buttons to ensure the Sky Master™ will hover in mid-air and respond accurately to your commands (make all trim adjustments while the drone is in the air).

### Forward/Backward Trim

- If your Sky Master™ drifts forward, push and release the BACKWARD TRIM button back repeatedly until the motion stops and proper flight is maintained (see diagram J).
- If your Sky Master™ drifts backwards, push and release the FORWARD TRIM button forward in the same manner until the problem is resolved.

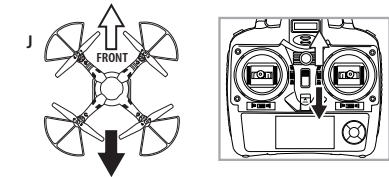

### Right/Left Bank Trim

- If your Sky Master™ drifts left, push and release the RIGHT TRIM button back repeatedly until the motion stops and proper flight is maintained (see diagram K).
- If your Sky Master™ drifts right, push and release the LEFT TRIM button in the same manner until the problem is resolved.

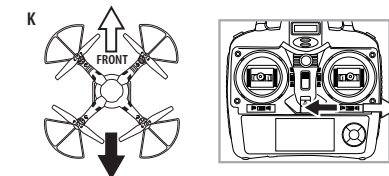

### Right/Left Spin Trim

- If your Sky Master™ spins left, push and release the RIGHT SPIN TRIM button back repeatedly until the motion stops and proper flight is maintained (see diagram L).
- If your Sky Master™ spins right, push and release the LEFT SPIN TRIM button in the same manner until the problem is resolved (see diagram M).

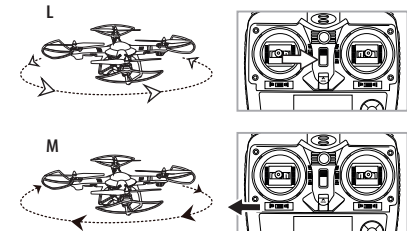

## CALIBRATING THE SKY MASTER™

NOTE: Your Sky Master™ comes pre-calibrated out of the box so you are ready to fly.

After several crashes and shock to your gyro sensors, you may notice that your drone is drifting and not holding its center position as well as it used to.

This most likely means that you need to recalibrate the 6 axis gyro. Please follow the simple instructions below.

1. Gently set your Sky Master™ on the flat surface.
2. Make sure the Sky Master™ is on and that the controller is synced (refer to syncing pg 4.). Do not start the blades. Instead move both the throttle and control stick down and to the left corner and hold them there for 5 seconds (See Diagram N). You will see the lights on the drone rapidly flash and stop. Once the lights stop flashing you have completed your calibration and are ready to fly!

**TROUBLE SHOOTING:** If you do not see the lights flash, turn off your controller take out the battery in the Drone and Start again. Always make sure to put your battery in first, then turn on your controller. Push the left throttle stick up all the way and then pull back down again. When you hear the beep the Sky Master™ is synced to the controller and you are ready to calibrate.

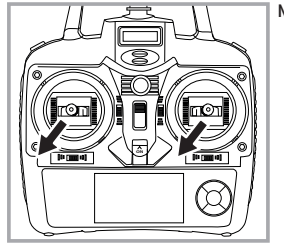

## FLIGHT PRACTICE

To master flying your aircraft try practicing the exercises shown below. Start with simple vertical takeoffs, landings, and left/right turning and rotating. Once those are mastered move on to square and cross maneuvers. Good luck and have fun!

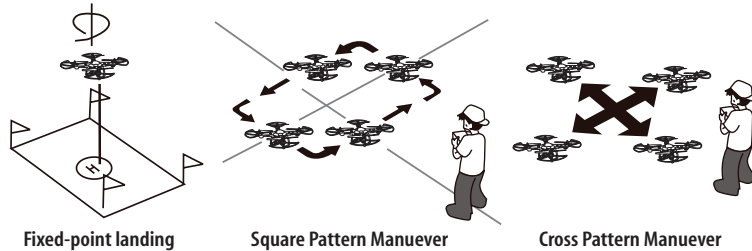

## SPEED SELECT BUTTON

The Sky Master™ has 4 speed settings; 40%, 60%, 80% and 100%. The Default setting when you first turn on your Sky Master™ is the 40% speed mode. To increase the speed simply press the Speed button (see remote diagram on pg 3) you will hear 1 beep and the speed changed to higher level speed, the current speed will continuously flashing on the LCD screen. Speed settings can be set before flight or during the flight.

## HEADLESS MODE BUTTON

You can maintain orientation of your Sky Master™ during flight.

1. Once the Sky Master™ is activated press the headless mode button (see controller on pg.3) to activate the internal compass.
2. The flying orientation is now locked to match the direction control lever.

## HOW TO PERFORM 360° STUNT ROLLS

Performing 360° stunt rolls with the Sky Master™ is as easy as 1-2-3:

1. Hover the Sky Master™ in still position making sure that you have at least 5 feet of clearance above and below the quadcopter.
2. Press and release the 360° stunt button and you will enter the stunt roll mode which is indicated by a rapid beeping (see diagram O).
3. Determine which direction you want it to flip and quickly push the right control stick in the direction you want to flip your Cloud Force (see diagram P). You have 4 choices a) Forward Roll, b) Backwards roll, c) Right side roll, d) Left side roll.

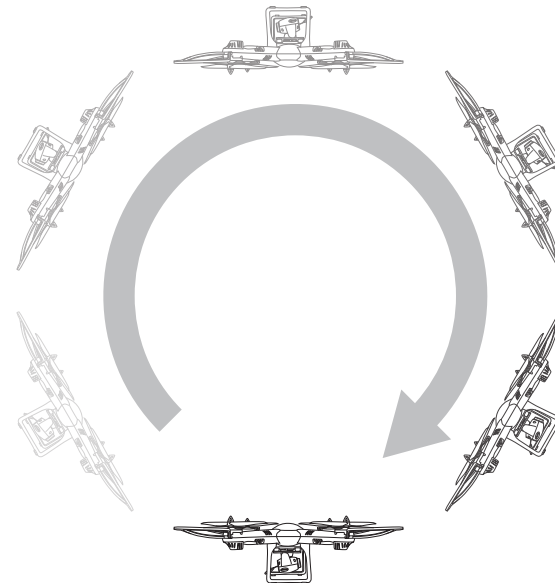
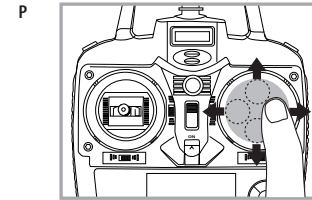
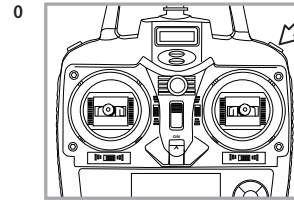

## USING YOUR ON-BOARD CAMERA AND VIDEO RECORDER

Your Sky Master™ comes equipped with an onboard digital camera that takes both video and still photographs. To enable usage of the same, download the free APP on your compatible mobile device. This will also allow you to shoot, record and stream using the on board camera. For more details refer to page 11.

Now you can have hours of fun creating aerial photography and videos for family and friends.

### GETTING STARTED

The camera enables recording directly to your mobile device (standard definition) and onto a microSDHC card (High Definition). Note: You can directly download the High Definition videos from the microSDHC card to your compatible mobile device.

### RECORDING TO microSDHC card

To use with a microSDHC card you will need:

1. One microSDHC card (not included)
2. One microSDHC card reader (included)
3. A Computer with a USB port and Windows Media Player or other Media player that can play AVI files (not included).

### FORMATTING YOUR microSDHC card

Before you can begin to take videos or digital photographs you must first format your microSDHC card. To format your microSDHC card simply place the microSDHC card into the included USB SD card reader and plug it into your computer's USB port (See diagram W1 and W2 below). After a few moments an icon will appear on your Desktop. Right click on the Icon and follow instructions to format your microSDHC card.

### INSTALLING THE microSDHC card IN YOUR SKY MASTER™

- Place the formatted microSDHC card into the side of the Sky Master™'s digital camera port (see diagram Q below). Push gently until you hear and feel the microSDHC card "click" into the digital camera slot.
- Turn the Sky Master™ on and make sure that it is both fully charged and properly synced to the Controller (see HOW TO SYNC YOUR QUADROPTER on page 4).

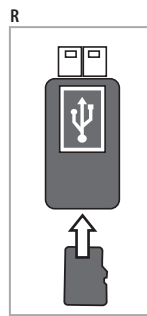
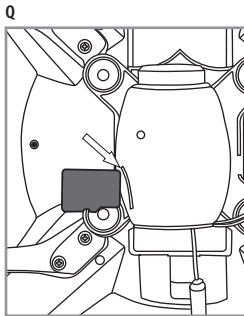

### REMOVING YOUR microSDHC card

To remove your microSDHC card push in gently on the back of the SD card with your thumb or forefinger until you hear and feel a "clicking sound". The microSDHC card will "pop-out" slightly and is ready for removal. Simply grab and pull gently away from the Sky Master™'s camera port to remove the card. Always store your microSDHC card in a clean, safe and cool environment.

### DOWNLOADING AND CLEARING SPACE ON YOUR microSDHC card

Plug your microSDHC card into the microSDHC card reader and connect to your computer. It is best to always download all your videos and pictures on to your computer and not store this data on your microSDHC card. After downloading your photos and videos, follow your computer's instructions to "delete" files on your microSDHC card.

**Note: The Sky Master™ + FPV can record video files up to 2 minutes of length. When attempting to record longer videos, it will automatically split the video into multiple files, each approximately 2 minutes in length. Still photos are recorded simultaneously on device and microSDHC card when inserted, but Videos are recorded only onto SD card when included. To record onto phone directly make sure to remove microSDHC card from the quadcopter camera.**

## LIVE VIDEO STREAMING SETUP

Your Sky Master™ comes equipped with an onboard digital camera that takes both video and still photographs to your mobile devices.

### WHAT YOU WILL NEED TO GET STARTED USING YOUR CAMERA

1. One Apple or Android phone\* (not included)
2. Propel Sky Master™ APP installed (app store or Android market available)

### PHONE HOLDER AND PHONE INSTALLATION

Insert the included phone holder hook (a) to the slots on the top of the controller properly, see the illustration below. When you install the phone holder correctly you can use it to hold your phone (see diagram S)

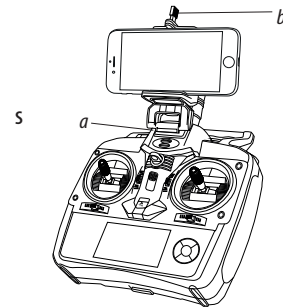

### PROPEL SKY MASTER™ FPV APP INSTALLATION

1. Make sure you are using a compatible Android™ or Apple® iOS device.
2. Make sure your device has access to the Internet.
3. For Apple® iOS devices, within the App Store, search and select “Propel Sky Master”. Hit the Install button and the “Propel Sky Master” App should download and install automatically.
4. For Android™ OS devices, visit the Google Play store and search for “Propel Sky Master”. Selecting the “Propel Sky Master” App will download the App and automatically install it on your device.
5. After the “Propel Sky Master” App is installed, it should create an icon on your screen. Click the “Propel Sky Master” icon to run the App to make sure that it has installed correctly on your device. If not, please delete and repeat the process again.

### PAIRING SKY MASTER™ TO YOUR COMPATIBLE DEVICE

1. After completely charging your Sky Master™ battery, install the battery to your Sky Master™.
2. In the Settings menu of your mobile device, locate the Wi-Fi option.
3. Turn ON the Wi-Fi option.
4. Select “Propel Sky Master” from the Wi-Fi list. Wait for your Sky Master™ to be connected. Return to the Main Menu.

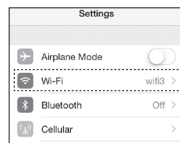

Note: Apple® devices require the use of iOS 7.0 or higher.  
 ANDROID™ devices require the use of OS 4.2.2 or higher.

## QUICK START

1. When you install the App correctly and have paired to the drone successfully, you can hit the “Propel Sky Master” App icon. Tap “START” on the bottom right hand side of the screen. You should see the real-time video from your Sky Master’s camera.
2. This App also allows you to control your Sky Master™ by your mobile device. To activate the control sticks, tap the “ON” button at the top right hand side of the screen. This will start the Sky Master’s motors and show the control sticks. You can now use your device as a traditional controller.

## DETAILED APP OVERVIEW

3. Please see images below for a detailed App overview. This overview is also available under the “HELP” icon in the home screen of the App.

### HOME PAGE



### CONTROL INTERFACE

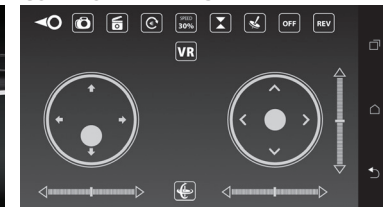

### HELP PAGE 1



### HELP PAGE 2

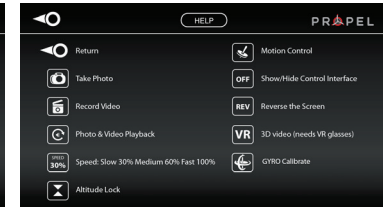

### HELP PAGE 3

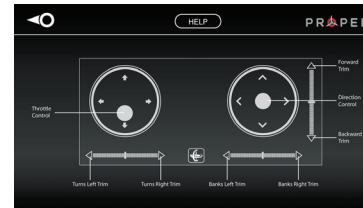

4. If you're still encountering difficulties please contact our customer service department at +1.949.566.9573.

**IMPORTANT NOTICE :** You can not take photos and videos at the same time. When you are in video mode your camera/ photo button is disabled. If you want to take photos you must first turn off video mode.

## TROUBLESHOOTING YOUR SKY MASTER™

PROBLEM	POSSIBLE REASON	SOLUTION
No Power in Controller	1. Power switched off 2. Polarity is reversed 3. Batteries may be dead	1. Switch the ON/OFF switch to ON 2. Make sure all batteries are installed correctly (see diagram B) 3. Replace batteries
Remote Not Properly Responding	1. Remote is switched off 2. Sky Master™ battery is not connected 3. Too windy 4. The remote is not synced	1. Switch the ON/OFF switch to ON 2. Connect the battery to Sky Master™ 3. Windy conditions severely impair the operation of the Sky Master™ 4. Re-sync the remote
Aircraft Won't lift off	1. Rotor speed too slow 2. Aircraft not fully charged	1. Push throttle lever forward 2. Recharge your Sky Master™
Aircraft Descends Too Fast	1. Moving the throttle too quickly	1. Control the throttle slower and smoother
Aircraft Not Responding	1. Gyroscopes not functioning	1. Turn ON the Sky Master™ and Reset the Gyros (see diagram P)
Loss of Sky Master™ Control	1. Aircraft is out of range of remote	1. Keep the aircraft within a 300 foot radius of the remote

## REPLACING THE PROPELLER BLADES

**NOTE : Always disconnect the battery before replacing the propeller blades.**

Your Sky Master™ propeller system is a precision instrument that may need repair or replacement from time to time for optimal flight function. Crash landing from high-speed aerial flights may cause damage to your Sky Master™ propellers.

The Sky Master™ has four propeller blades, two on the front and two on the back. Each one of these propellers is marked with either A or B on the underside.

1. When replacing the propeller blades, carefully unscrew the broken propeller from the rotor shaft.
2. Replace the damaged blade with the correct new blade. Ensure that the identification letter on the broken blade and on the new blade are the same before screwing back on (See diagram U).

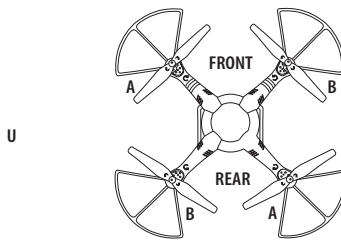

## ATTACHING THE BLADE GUARDS

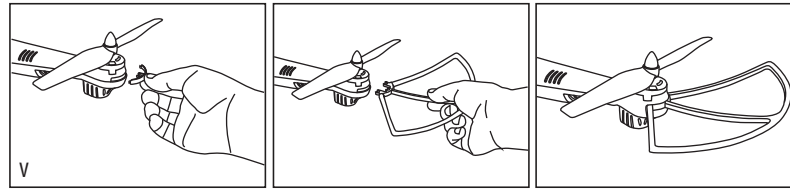

Your Sky Master™ is equipped with 4 blade guards for beginner flying. These can be easily removed and re-attached when needed. To attach the blade guard, remove the clip parts from the body as shown on diagram V, insert each guard into the socket on the body near the propeller as shown. Push the blade guards all the way into place on the slots and adjust to ensure they have been locked in securely.

## SKY MASTER™ WARNING:

The Sky Master™ is designed for OUTDOOR use only. The Sky Master™ blades revolve at high speeds and can cause damage to the user, spectators and animals. Stand away from the Sky Master™ to reduce the risk of getting into the flight path. Warn spectators that you will be flying your Sky Master™ so that they are aware of its position. Before flight, inspect the rotor blades to make certain that the blades are securely fastened to the Sky Master™.

### WARNING!

- Choking/Cutting Hazard. Small Parts/Sharp Rotor Blades.
- Keep hands, hair and loose clothing away from the propeller when the power switch is turned to the ON position.
- Turn off the transmitter and Sky Master™ when not in use.
- The included charger is built specifically for the Sky Master™ Li-Poly battery. Do not use it to charge any other battery.
- New alkaline batteries are recommended for maximum performance.
- Parental supervision recommended when flying Sky Master™.

## BATTERY WARNINGS

### RECHARGEABLE BATTERY:

This Sky Master™ uses a Li-Poly rechargeable battery. If battery no longer stays charged, dispose of battery properly according to local disposal requirements.

### CONTROLLER BATTERIES:

Remote control requires 4 "AA" batteries (not included). Please read the important battery safety warning below.

- Do not mix alkaline, standard (carbon-zinc) and rechargeable batteries (Nickel Metal Hydride).
- Do not mix old and new batteries.
- Non-rechargeable batteries are not to be recharged.
- Rechargeable batteries are to be removed from the item before being charged (if removable).
- Rechargeable batteries are only to be charged under adult supervision.
- Exhausted batteries should be removed immediately and must be recycled or disposed of properly according to state or local government ordinances and regulations.
- The supply terminals are not to be short-circuited.
- Only batteries of the same or equivalent type as recommended are to be used.
- Batteries are to be inserted with the correct polarity (see inside booklet for diagram).
- Do not dispose batteries in a fire - batteries may leak or explode.

## CARE AND MAINTENANCE

- Always remove the batteries from the wireless remote control when it is not being used for an extended period of time.
- To clean, gently wipe the remote control and Sky Master™ with a clean damp cloth.
- Keep the toy away from direct heat or sunlight.
- Do not submerge the toy into water. This can damage the unit beyond repair.
- Parental guidance recommended when installing or replacing the batteries.