

FCC Part 15 C Notice

CAUTION: Changes or modifications not expressly approved by the party responsible for compliance could void the user's authority to operate the equipment.

NOTE: This equipment has been tested and found to comply with the limits for a Class B digital device, pursuant to Part 15 of the FCC Rules. These limits are designed to provide reasonable protection against harmful interference in a residential installation. This equipment generates, uses and can radiate radio frequency energy and, if not installed and used in accordance with the instructions, may cause harmful interference to radio communications. However, there is no guarantee that interference will not occur in a particular installation. If this equipment does cause harmful interference to radio or television reception, which can be determined by turning the equipment off and on, the user is encouraged to try to correct the interference by one or more of the following measures:

- Reorient or relocate the receiving antenna.
- Increase the separation between the equipment and receiver.
- Connect the equipment into an outlet on a circuit different from that to which the receiver is connected.
- Consult the dealer or experienced radio/TV technician for help.

This device complies with Part 15 of the FCC Rules. Operation is subject to the following two conditions :

- (1) This device may not cause harmful interference, and
- (2) this device must accept any interference received, including interference that may cause undesired operation.

FCC RF exposure statements

This Transmitter must not be co - located or operating in conjunction with any other antenna or transmitter.

This equipment complies with FCC RF radiation exposure limits set forth for an uncontrolled environment. This equipment should be installed and operated with a minimum distance of 20 centimeters between the radiator and your body or nearby persons.

INDUSTRY CANADA NOTICE: CANADA ONLY.

This device complies with Industry Canada licence-exempt RSS standard(s). Operation is subject to the following two conditions: (1) this device may not cause interference, and (2) this device must accept any interference, including interference that may cause undesired operation of the device.

Le présent appareil est conforme aux CNR d'Industrie Canada applicables aux appareils radio exempts de licence. L'exploitation est autorisée aux deux conditions suivantes: (1) l'appareil ne doit pas produire de brouillage, et (2) l'utilisateur de l'appareil doit accepter tout brouillage radioélectrique subi, même si le brouillage est susceptible d'en compromettre le fonctionnement.

CAN ICES-3 (B)/NMB-3(B)

This product meets the applicable Innovation, Science and Economic Development Canada technical specifications.

Ce produit répond aux spécifications techniques pertinentes d'Innovation, Science et Développement économique applicables.



Conforms to safety requirements of FCC, RSS247, RSS210.

©2018 Rooftop Brands™ All rights reserved

Tel: + (1) 949-566-9573 • www.propelrc.com

Made in China
v2.0

AERO X
Folding HD Streaming Drone



ON BOARD HD CAMERA
ON BOARD HD VIDEO
1280 x 720 pixel
30 frames per second

INSTRUCTION BOOKLET

WARNING: Never leave product charging unattended for extended periods of time. Always disconnect the battery from charger immediately after the battery is fully charged. Please refer to enclosed safety instructions.

PACKAGE CONTAINS:

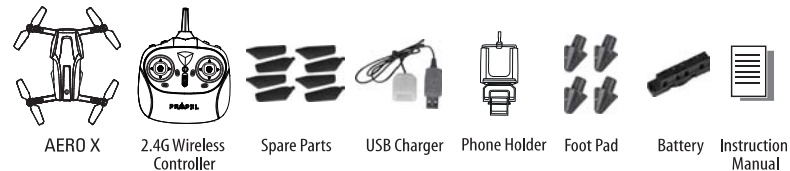

Colors and styles may vary slightly .



TABLE OF CONTENTS

Features	2
Remote Control Battery Installation	2
Charging the AERO X Li-Poly Battery	2
Install The Aircraft Battery	2
How to Expand and Fold Your Aero X	2
AERO X Diagram	3
Control Diagram	3
Flight Preparation	4
Syncing Your AERO X	4
Now You Are Ready To Fly	5
Recognizing The Front & Rear Of The AERO X	5
Starting/Stopping The Rotors	5
Manual Start/Stop	5
Auto Start/Land	5
Speed Select Button	6
3 Channel VS 4 Channel Flying	6
3 Channel Flight Control	6
4 Channel Flight Control	7
Flight Practice	7
Adjusting The Trim	8
Calibrating The AERO X	9
How To Perform 360° Stunt Rolls	9
Live Video Streaming Setup	10
Propel AERO X WiFi APP Installation	10
Pairing AERO X to Your Compatible Device	10
Quick Start	11
Detailed APP Overview	11
Troubleshooting Your AERO X	12
Replacing The Propeller Blades	13
Warnings	14
Battery Warnings	14
Care and Maintenance	14
FCC Information	15

Thank you for purchasing the AERO X 2.4 Ghz Quadcopter. Please read this instruction booklet as it contains valuable information on how to properly fly and care your AERO X.

FEATURES

- Compact Fold-In Design allows for easy Portability
- Air Pressure Sensor Locks Flight Altitude for Stable Video Footage
- Takes Video and Still Pictures With On Board HD Camera
- 6 Axis Gyro for Extremely Stable Flight and Maneuverability
- 3 Speed Settings for Suit Beginner to More Advanced Pilots
- Wide Range Digital Radio Allows Flight Range Up To 300 Feet

REMOTE CONTROL BATTERY INSTALLATION

1. Slide off the battery cover from the back of the controller.
2. Install 4 fresh "AA" alkaline batteries into the controller as shown in diagram A. Replace the battery cover.
3. Turn over the controller and push the power button up. If the power indicator turns on you have installed your batteries properly.

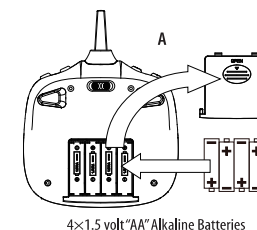

CHARGING THE AERO X LI-POLY BATTERY

1. Plug the USB charger into the USB port of the computer or other USB charger. (see diagram B)
- Note: The red LED indicator will light on.**
2. Connect the battery to the socket on the USB charging cable, the red LED indicator will light off. When charging is completed, the red LED indicator will light on again.
3. Average charging time is approximately 100 minutes. A fully charged drone can fly for approximately 7 minutes depending on environment and user input.

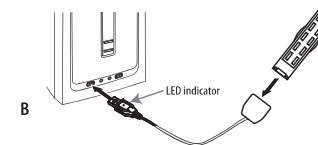

INSTALL THE AIRCRAFT BATTERY

Put the battery into the battery compartment then lock the 2 ends with the battery locks. (see diagram C)

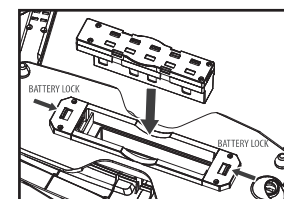

HOW TO EXPAND AND FOLD YOUR AERO X

Before flying your Aero X, you need to expand the foldable arms out. Turn your Aero X over, bottom side facing you, pull and expand the 4 arms as shown in the diagram below carefully. Make sure the arms are fully expanded to the position. After flying your Aero X, it is recommended to fold all 4 arms back in. When expanding or folding your Aero X, make sure to be gentle. (see diagram D)

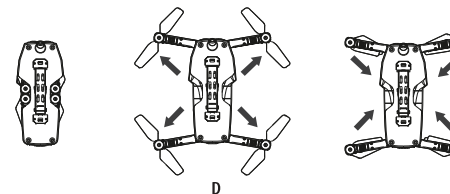

AERO X DIAGRAM

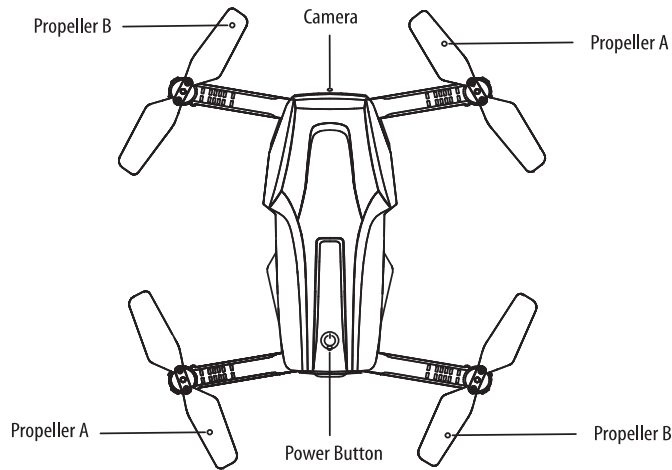

CONTROLLER DIAGRAM

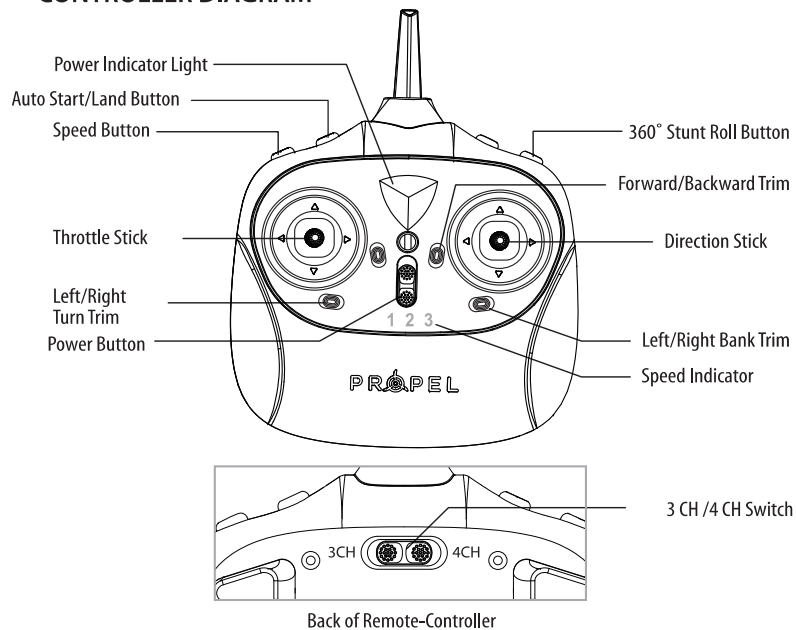

WARNING

DO NOT FLY YOUR AERO X IN FOUL WEATHER!



FLIGHT PREPARATION

- Verify that there are 4 "AA" batteries inside the remote control unit and the AERO X battery has been fully charged.
- Make sure to be in a large open space preferably a field or a park with an open radius of at least 200 feet.
- Make sure to start your drone on a clean flat level surface before take-off.
- **IMPORTANT! Until you have experience in flying your AERO X, it is not advised to use in any rate of wind. Pick a day with zero wind or extremely light wind condition when learning how to fly.**

SYNCING YOUR AERO X

Important! When syncing your AERO X with the controller always make sure that the drone is on a flat level surface and that your digital trim settings are in the center position.

1. Before starting, make sure that the power switch on your controller is off and the battery is removed from the AERO X. Make sure that there are no other 2.4G devices in the area.
2. Insert the battery into the AERO X and set it down on a flat level surface. Push down the power button and hold for a few seconds (see diagram D1). The red and white LED lights on the drone should begin to flash rapidly.
3. Quickly turn ON the remote and you will notice that the top red LED light on the face of the controller should also be flashing. The lights on the drone will start flash slower.
4. Push the throttle stick all the way up until it stops and then pull it back all the way down to the bottom (see diagram below). When pushing the stick up or pulling the stick down you should hear a high-pitched beep both ways. The indicating lights on the drone and controller will stop flashing and stay solid on. You have successfully synced your AERO X and are ready to fly. If this doesn't happen, repeat steps 1-4 again.

- **TIP 1: Try not to leave too much time between putting your battery into the drone and turning on the controller or your syncing window will time-out.**
- **TIP 2: Syncing your drone indoors or in the shade will make it easier to see the LED light indicators on both the controller and the drone.**

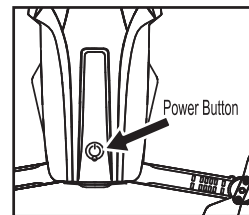

D1

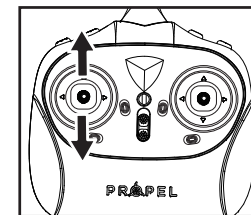

Move the control stick all the way up and all the way down, you should hear two beeps.

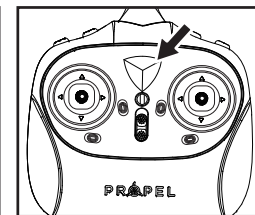

The flashing red LED light will become solid when you are synced.

NOW YOU ARE READY TO FLY!

If you have successfully synced your AERO X to your controller as explained on page 4 you are now ready to fly. Before beginning to fly your drone you should familiarize yourself with how to start and stop the rotors, how to use your auto land feature and how the controls work so please carefully read and familiarize yourself with various control features explained in the next few pages. Once again as a beginner pilot you should learn how to control your drone in a large open field or park on a day with zero or very light wind. Do not try to fly your AERO X too high until you become a more experience pilot.

RECOGNIZING THE FRONT & REAR OF THE AERO X

Even though the AERO X has four rotors there is still a front or "forward" facing direction and "rear" or backwards facing direction. The front and forward facing direction of the AERO X is the side with two white light (see diagram E). The rear and backward facing direction of the Quadcopter is the side with one red (see diagram E).

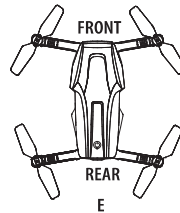

STARTING/STOPPING THE ROTORS

Note: You can start/stop your AERO X manually or automatically. Please follow one of the steps below to operate accordingly. Make sure you have properly synced the AERO X and the power stays on.

MANUAL START/STOP

- To start the rotors simply move the two control sticks both down and out (see diagram), hold until the rotors start spinning. Now release both sticks to the neutral position and push the throttle up to take off.
- To stop the rotors, after starting them you can simply wait about 10 seconds, and they will stop automatically. Or move both sticks down and out again to stop immediately. After take off, you can simply pull the throttle all the way down and land.

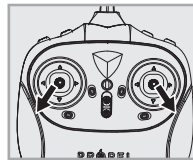

AUTO START/LAND

The AERO X has an auto start/land feature which allows you to start/land automatically. Simply press the **AUTO START / LAND** button on the top of the controller and your AERO X will begin taking off/landing (see diagram below).

NOTE: You can still control the direction while auto starting/landing to avoid obstacles.

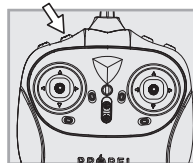

SPEED SELECT BUTTON

The AERO X has 3 speed settings; 1 (SLOW), 2 (MEDIUM) and 3 (HIGH). The Default setting when you first turn on your AERO X is the 1 (SLOW) speed mode. To increase the speed simply trigger the speed setting button (see remote diagram on pg 3) you will hear beeping sounds and the speed setting indicator on the face of the controller will show you what speed setting you are on. Speed settings can be set before flight or during the flight.

3 CHANNEL VS 4 CHANNEL FLYING

Propels unique "switch-blade" technology allows you to choose between 3ch or 4ch flight control modes. Most people with no experience in flying multi copters may find 3ch easier to learn at first as controls are set up to simply move forward, back, turn left and turn right. 4channel flying gives the operator ultimate control by adding two more dimensions of flight, banking left and banking right.

To change to 3 Channel mode:

Switch the 3/4 CH button to left side on the back of controller (see remote diagram on pg 3), you will hear 3 "beeps" indicating the AERO X now is set to 3 CH mode.

To change to 4 Channel mode:

Switch the 3/4 CH button to right side on the back of controller (see remote diagram on pg 3), you will hear 4 "beeps" indicating the AERO X now is set to 4 CH mode.

3 CHANNEL FLIGHT CONTROL

Below is a list of basic flight functions for your long-range remote to control the AERO X. While learning to fly your AERO X it is best to start in a large space with the drone facing away from you until you get used to the basic controls. As you master flying your AERO X you can move to more advanced maneuvering techniques. Practice makes perfect! When you have these basic steps down you can move to the next level.

Move the left Throttle stick up to increase the propeller speed and the AERO X will accelerate and ascend.

Move the left Throttle stick down to decrease the propeller speed and the AERO X will decelerate and descend (see diagram F).

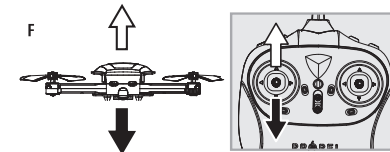

While in the air, move the right Direction Stick up and the AERO X will move forward.

Move the right Direction Control down and the AERO X will move backward (see diagram G).

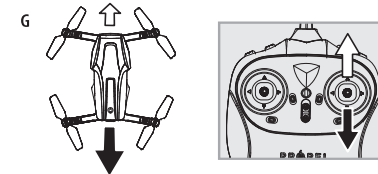

While in the air, move the right Direction Control left and the AERO X will spin to the left.

Move the right Direction Control right and the AERO X will spin to the right (see diagram H).

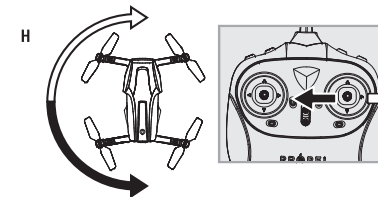

4 CHANNEL FLIGHT CONTROL

Below is a list of basic flight functions for your long-range remote to control the AERO X. While learning to fly your AERO X it is best to start in a large space with the drone facing away from you until you get used to the basic controls. As you master flying your AERO X you can move to more advanced maneuvering techniques. Practice makes perfect!

Move the left Throttle stick up to increase the propeller speed and the AERO X will accelerate and ascend.

Move the left Throttle stick down to decrease the propeller speed and the AERO X will decelerate and descend (see diagram I).

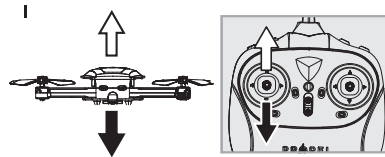

While in the air, move the left Throttle stick left and the AERO X will rotate left.

Move the left Throttle stick right and the AERO X will rotate right (see diagram J).

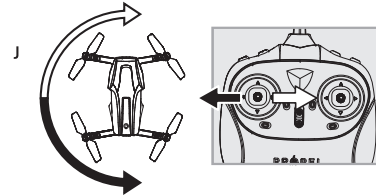

While in the air, move the right Direction Stick up and the AERO X will move forward.

Move the right Direction Control down and the AERO X will move backward (see diagram K).

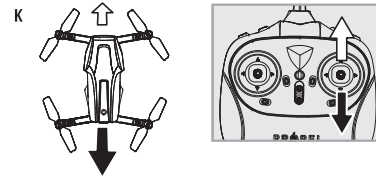

While in the air, move the right Direction Control left and the AERO X will bank to the left.

Move the right Direction Control right and the AERO X will bank to the right (see diagram L).

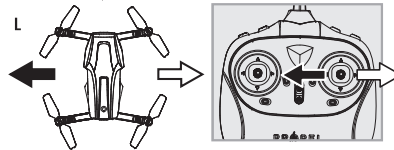

FLIGHT PRACTICE

To master flying your aircraft try practicing the exercises shown below. Start with simple vertical takeoffs, landings, and left/right turning and rotating. Once those are mastered move on to square and cross maneuvers. Good luck and have fun!

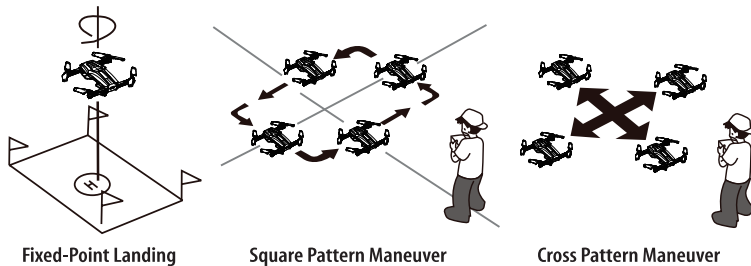

ADJUSTING THE TRIM

NOTE: The AERO X is already properly trimmed and calibrated right out of the box and should not require any trim adjustments before flying. Some more experienced pilots may want to adjust trim settings for their style of flying. After several crashes you may need to adjust trim settings for the AERO X to be more balanced.

Forward/Backward Trim

- If your AERO X drifts forward while in the air, push and release the FORWARD/BACKWARD TRIM button backward repeatedly until the motion stops and proper flight is maintained (see diagram M).
- If your AERO X drifts backwards, push and release the FORWARD/BACKWARD TRIM button forward in the same manner until the problem is resolved.

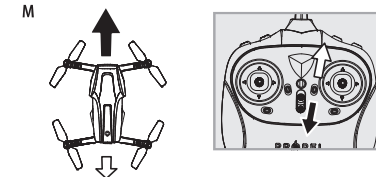

Bank Right/Left Trim

- If your AERO X drifts / banks left while in the air, push and release the BANKS TRIM button to the right side repeatedly until the motion stops and proper flight is maintained (see diagram N).
- If your AERO X drifts right, push and release the BANKS TRIM button to left side in the same manner until the problem is resolved.

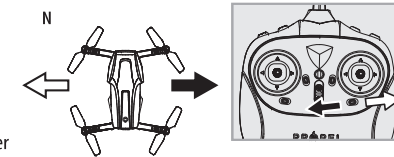

Spin Left Trim

- If your AERO X spins left while in the air, push and release the LEFT/RIGHT TURN TRIM button to the right side repeatedly until the motion stops and proper flight is maintained (see diagram O).

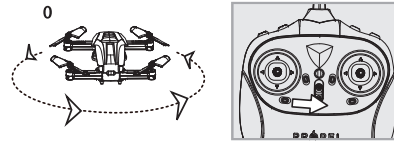

Spin Right Trim

- If your AERO X spins right while in the air, push and release the LEFT/RIGHT TURN TRIM button to the left side until the problem is resolved (see diagram P).

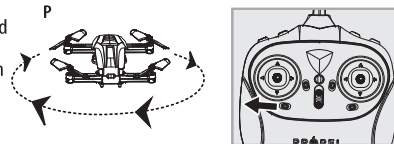

NOTE: The use of the Trim buttons utilizes sounds. A single long Beep indicates the product is center trimmed. Long beeping after press the trim button indicates the product is trimmed to the maximum on a particular side.

CALIBRATING THE AERO X

NOTE: Your AERO X comes pre-calibrated out of the box so you are ready to fly.

After several crashes and shocks to your gyro sensors, you may notice that your drone is drifting and can not hold its center position as well as it used to.

This most likely means that you need to recalibrate your AERO X. Please follow the simple instructions below.

1. Place the AERO X on a flat level surface
2. Make sure the AERO X is on and that the controller is synced (refer to syncing pg 4). Do not start the blades. Instead move both the throttle and control stick down and to the right corner and hold them there for 5 seconds (see diagram R). You will see the lights on the drone rapidly flash and stop. Once the lights stop flashing you have completed your calibration and are ready to fly!

TROUBLE SHOOTING: If you do not see the lights flash, first remove the battery from the drone then turn off your controller and start again. Always make sure to put your battery in first, then turn on your controller. Push the left throttle stick up all the way and then pull back down again. When you hear the beep the AERO X is synced to the controller and you are ready to calibrate.

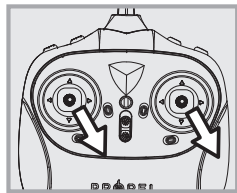

R

HOW TO PERFORM 360° STUNT ROLLS

Performing 360° stunt rolls with the AERO X is as easy as 1-2-3:

1. Hover the AERO X in still position making sure that you have at least 5 feet of clearance above and below the quadcopter. Set the speed settings to mode 2 or 3.
2. Press the 360 stunt button down and you will enter the stunt roll mode which is indicated by rapid beeping (see diagram S) sounds.
3. Determine which direction you want it to flip and quickly push the right control stick in the direction you want to flip your AERO X (see diagram T). You have 2 choices a) Right side roll, b) Left side roll.

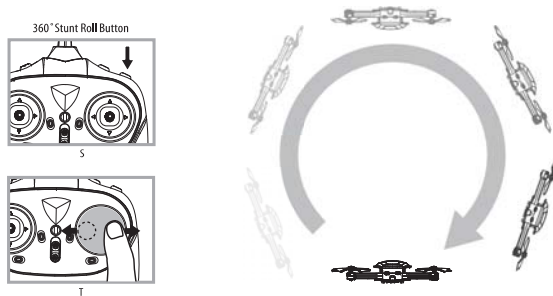

NOTE: To exit the stunt roll mode without flip, you can press the button again. The beeping sound will stop.

LIVE VIDEO STREAMING SETUP

Your AERO X comes equipped with an onboard digital camera that takes both video and still photographs to your mobile devices.

WHAT YOU WILL NEED TO GET STARTED USING YOUR CAMERA

1. One Apple or Android phone* (not included)
2. Propel 1780 APP installed (app store or Android market available)

PHONE HOLDER AND PHONE INSTALLATION

Insert the included phone holder hook (a) to the slots on the top of the controller properly, see the illustration below. When you install the phone holder correctly you can use it to hold your phone (see diagram U)

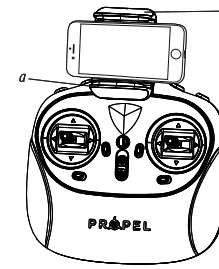

U

PROPEL AERO X WiFi APP INSTALLATION

1. Make sure you are using a compatible Android™ or Apple® iOS device.
2. Make sure your device has access to the Internet.
3. For Apple® iOS devices, within the App Store, search and select "Propel 1780". Hit the Install button and the "Propel 1780" App should download and install automatically.
4. For Android™ OS devices, visit the Google Play store and search for "Propel 1780". Selecting the "Propel 1780" App will download the App and automatically install it on your device.
5. After the "Propel 1780" App is installed, it should create an icon on your screen. Click the "Propel 1780" icon to run the App to make sure that it has installed correctly on your device. If not, please delete and repeat the process again.

PAIRING AERO X TO YOUR COMPATIBLE DEVICE

1. After completely charging your AERO X battery, install the battery to your AERO X (refer to the user manual).
2. In the Settings menu of your device, locate the Wi-Fi option.
3. Turn ON the Wi-Fi option.
4. Select "Propel 1780" from the Wi-Fi list. Wait for your AERO X to be connected. Return to the Main Menu.



Settings



Propel 1780

Note: Apple® devices require the use of iOS 7.0 or higher.

ANDROID™ devices require the use of OS 4.2.2 or higher.

QUICK START

1. After you install the App correctly and have paired to the drone successfully, you can open the "Propel 1780" App icon. Tap "START" on the bottom right hand side of the screen. You should see the real-time video streaming from your AERO X's camera.
2. This App also allows you to control your AERO X by your mobile device. To activate the control sticks, tap the "ON" button at the top right hand side of the screen. This will switch the control from your traditional controller to your compatible device. Now click "A" to start the motors. The control sticks will show up in the screen for your fly control and you can now use your device as a traditional controller. Or you can click "A" to auto launch your AERO X in the air and then use your device as a traditional controller. Click this button again, your AERO X will automatically land on the floor.
3. You can click "📷" to take still pictures. Pictures will be stored into your mobile device. To record videos, you can click "📹". There will be a timer start running on the screen, indicating the recording is on. The video footage will also be stored into your mobile device. Click "📁" you can see 2 folders, pictures and videos, you can find the pictures and videos you took with your Aero X.

Note: You can also using the controller Camer/Video button to control taking pictures and recording videos. Short press to take pictures and long press to record video. The LED lights will indicate in the same way as you use the APP controlling. Only when you connect your mobile device to your Aero X, the pictures or video footages will be recorded.

DETAILED APP OVERVIEW

3. Please see images below for a detailed App overview. This overview is also available under the "HELP" icon in the home screen of the App.

HOME PAGE



CONTROL STICKS

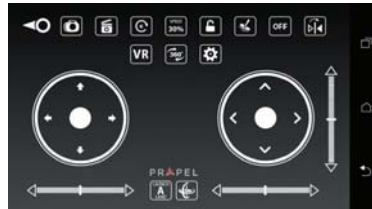

HELP PAGE 1



HELP PAGE 2



HELP PAGE 3



CAMERA SETTINGS



4. If you're still encountering difficulties please contact our customer service department at +1-949-566-9573(USA)

TROUBLESHOOTING YOUR AERO X

PROBLEM	POSSIBLE CAUSE	POSSIBLE SOLUTION
No Power	1. Power switched off 2. Polarity is reversed 3. Batteries may be low or in need of charging	1. Switch the ON/OFF switch to ON 2. Make sure all batteries are installed correctly (see diagram A) 3. Replace batteries
Aircraft Not Responding	1. Remote is switched off 2. Battery power in remote is too weak 3. The remote is not properly synced 4. Out of control range	1. Switch the ON/OFF switch to ON 2. Replace remote batteries 3. Re-sync the remote 4. Do not fly beyond 500 feet
Aircraft Won't lift off	1. Rotor speed too slow 2. Aircraft not fully charged 3. Obstruction of rotors	1. Push throttle lever forward 2. Recharge your AERO X 3. Check rotors for hair or other obstructions
Aircraft Spins, can not be trimmed	Rotor deformation or bad motor	Replace the damaged rotor (You may need to consult with a Propel customer service personnel)
Aircraft Tilt to one direction	Aircraft did not calibrate properly	Restart the aircraft and controller, properly calibrate it on a flat level surface
Altitude Hold height are not stable (up and down constantly)	Aircraft vibrates too much	Check the propeller deformation

REPLACING THE PROPELLER BLADES

Your AERO X's propeller system is a precision instrument that may need repair or replacement from time to time for optimal flight function. Crash landing at high-speed may cause damage to your AERO X's propellers.

1. The AERO X has four sets blades, two sets blades with indication number B & A on front, and two sets blades with indication number A & B on the rear (see the diagram V).
2. When replacing the propeller blades, make sure to match the indication markings on the blades.
3. Unscrew and take off the damaged blade.
4. Replace with new correct blade.

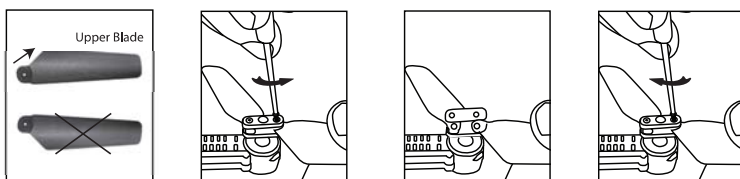

Blade Front Left = B
Blade Front Right = A

Blade Back Left = A
Blade Back Right = B

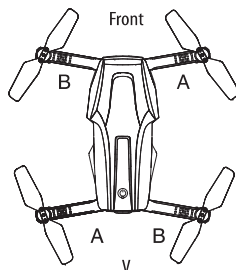

5. Click the blade guard into the place and then secure it with the screw.

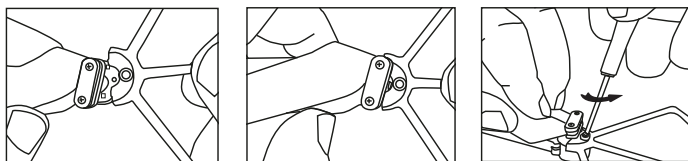

AERO X WARNING:

The AERO X is designed for OUTDOOR use. The AERO X's blades revolve at high speeds and can cause damage to the user, spectators and animals. Stand away from the AERO X to reduce the risk of getting into the flight path. Warn spectators that you will be flying your AERO X so that they are aware of its position. Before flight, inspect the rotor blades to make certain that the blades are securely fastened to the AERO X.

WARNING!

- Choking/Cutting Hazard. Small Parts/Sharp Rotor Blades.
- Keep hands, hair and loose clothing away from the propeller when the power switch is turned to the ON position.
- Turn off the transmitter and AERO X power switches when not in use.
- The included charger is built specifically for the AERO X Li-Poly battery. Do not use it to charge any other battery.
- New alkaline batteries are recommended for maximum performance.
- Parental supervision recommended when flying AERO X.

BATTERY WARNINGS

RECHARGEABLE BATTERY:

This AERO X uses a Li-Poly rechargeable battery. If battery no longer stays charged, dispose of battery properly according to local disposal requirements.

CONTROLLER BATTERIES:

Remote control requires 4 "AA" batteries (not included).

Please read the important battery safety warning below.

- Do not mix alkaline, standard (carbon-zinc) and rechargeable batteries (Nickel Metal Hydride).
- Do not mix old and new batteries.
- Non-rechargeable batteries are not to be recharged.
- Rechargeable batteries are to be removed from the item before being charged (if removable).
- Rechargeable batteries are only to be charged under adult supervision.
- Exhausted batteries should be removed immediately and must be recycled or disposed of properly according to state or local government ordinances and regulations.
- The supply terminals are not to be short-circuited.
- Only batteries of the same or equivalent type as recommended are to be used.
- Batteries are to be inserted with the correct polarity (see inside booklet for diagram).
- Do not dispose batteries in a fire - batteries may leak or explode.

CARE AND MAINTENANCE

- Always remove the batteries from the wireless remote control when it is not being used for an extended period of time.
- To clean, gently wipe the remote control and AERO X with a clean damp cloth.
- Keep the toy away from direct heat or sunlight.
- Do not submerge the toy into water. This can damage the unit beyond repair.
- Parental guidance recommended when installing or replacing the batteries.