

Trim size 4.5 x 6.875 in.
Spread size 9 x 6.875 in.

PROPEL

PROPEL

FCC Part 15 C Notice

CAUTION: Changes or modifications not expressly approved by the party responsible for compliance could void the user's authority to operate the equipment.

NOTE: This equipment has been tested and found to comply with the limits for a Class B digital device, pursuant to Part 15 of the FCC Rules. These limits are designed to provide reasonable protection against harmful interference in a residential installation. This equipment generates, uses and can radiate radio frequency energy and, if not installed and used in accordance with the instructions, may cause harmful interference to radio communications. However, there is no guarantee that interference will not occur in a particular installation. If this equipment does cause harmful interference to radio or television reception, which can be determined by turning the equipment off and on, the user is encouraged to try to correct the interference by one or more of the following measures:

- Reorient or relocate the receiving antenna.
- Increase the separation between the equipment and receiver.
- Connect the equipment into an outlet on a circuit different from that to which the receiver is connected.
- Consult the dealer or experienced radio/TV technician for help.

This device complies with Part 15 of the FCC Rules. Operation is subject to the following two conditions :

- (1) This device may not cause harmful interference, and
- (2) this device must accept any interference received, including interference that may cause undesired operation.



Conforms to safety requirements of ASTM, CPSIA and FCC.

©2016 Rooftop Brands™ All rights reserved
Tel: + (1) 949-566-9573 • www.propelrc.com

Made in China

ATOM™ FPV MICRO DRONE

Indoor / Outdoor Wireless Quadcopter



INSTRUCTION BOOKLET

WARNING: Never leave product charging unattended for extended periods of time. Always disconnect the ATOM™ FPV from charger immediately after it is fully charged. Please refer to enclosed safety instructions.

PACKAGE CONTAINS:



ATOM™ FPV



2.4G Wireless Controller



VR BOX



Spare Parts



USB charging cord



Instruction Manual

Colors and styles may slightly vary.

TABLE OF CONTENTS

Product Features	2
Remote Control Battery Installation	2
Charging Your ATOM™ FPV	2
ATOM™ FPV Diagram	3
Remote Control Diagram	3
Synching Your ATOM™ FPV	4
Preparing For Flight	4
Flying Tips	4
Recognizing The Front & Back Of The ATOM™ FPV	5
How To Start/Stop Rotors	5
Auto Land Button	5
Flight Controls	6
Understanding Trim Adjustments	6
Level Surface Gyro Calibration	7
Low Battery Warning	7
Switching To High Speed Mode	7
Performing A 360° Stunt Roll	8
Live Video Streaming	9
Using VR Glasses	10
Trouble Shooting	11
Replacing The Propeller Blades	11
Warnings	12
Battery Warnings	12
Care and Maintenance	12
FCC Information	15

Thank you for purchasing the ATOM™ FPV 2.4 Ghz Mini Quadrocopter. Please read this instruction booklet as it contains valuable information on how to properly fly and care for your ATOM™ FPV Drone.

FEATURES

- On Board Camera Records High-definition Video and Captures Still Pictures.
- Streams Video to Your Mobile Device.
- Real VR glasses takes you into the fresh new world than ever before!
- 6 AXIS GYRO KEEPS THE atom fpv STABLE IN ALL CONDITIONS.
- Air pressure sensor locks flight altitude.
- Push button 360° aerial stunts.
- Automatically start and lands with push of a button.
- 3 different speed settings for beginner to advanced quadrocopter pilots.

REMOTE CONTROL BATTERY INSTALLATION

1. Unscrew the battery cover from the back of the controller as shown in diagram A.
2. Install 2 fresh "AA" alkaline batteries into the controller as shown in diagram B.
3. Replace the battery cover and secure it.
4. Switch the On/Off switch to the ON position the red LED will flash and you will hear two beeps if the batteries are installed correctly.

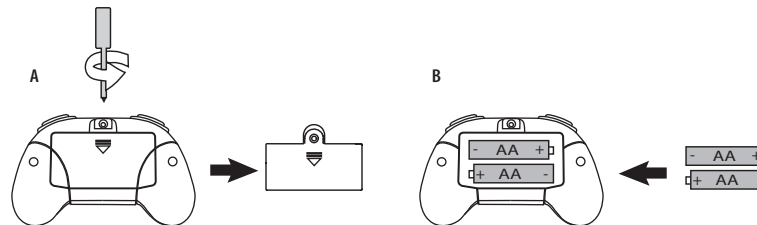

CHARGING YOUR ATOM™ FPV

1. Switch the quadrocopter Off. Connect the power cable to the unit making sure the arrow side of the connector is on top side facing the top of the ATOM™ FPV (see diagrams C1 and C2).
CAUTION: The USB plug fits the charging socket only in one way. Do not force it. Improper connection will damage the ATOM™ FPV.
2. Connect the USB end of the cable to your computer's USB port (see diagram D).
3. The red LED on the USB plug lights up when charging is complete. Average charging time is 30 minutes.
Note: If the red LED lights up, either the charging is complete or the USB plug is not properly connected.
A full charge will allow for about 5 minutes of flight time depending on environment and user input.

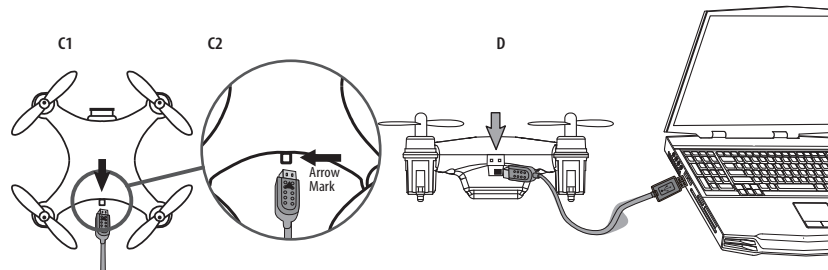

IMPORTANT: ALWAYS REMEMBER TO UNPLUG YOUR CHARGING CORD WHEN NOT IN USE!

ATOM™ FPV DIAGRAM

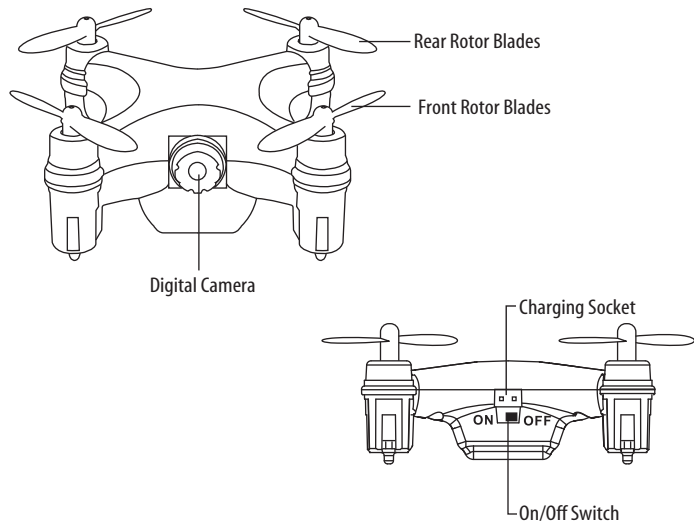

ATOM™ FPV REMOTE DIAGRAM

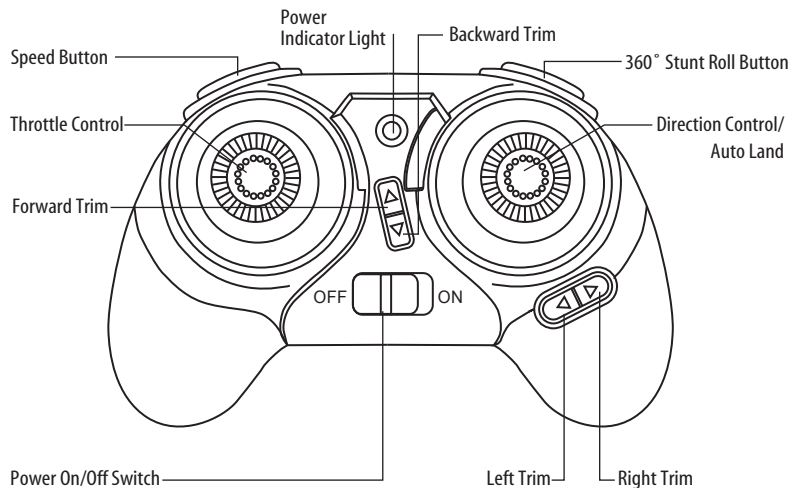

WARNING

DO NOT FLY YOUR ATOM™ FPV IN FOUL WEATHER!



SYNCING YOUR ATOM™ FPV

Important! When syncing your ATOM™ FPV quadcopter with the controller always make sure that the quadcopter is on a flat level surface and that your digital trim settings are in the center position. This ensures that the 6 Axis gyro is properly programmed to mimic your trim settings.

Your ATOM™ FPV utilizes an automatic 2.4G channel selection system that allows up to 8 people to fly side by side in the same wireless range with no interference.

For One-Person Play:

1. Before starting, make sure that the power on both your controller and ATOM™ FPV are in the OFF position. Make sure that there are no other 2.4G devices in the area as well.
2. Turn ON the ATOM™ FPV and set it down on a flat surface. The LED indicator lights of the ATOM™ FPV should begin to flash rapidly.
3. Turn ON the remote, you will hear two beeps. The ATOM™ FPV's LED lights should now flash slowly. Push the throttle on the left all the way forward (1 beep) and then pull the throttle all the way back. A 2nd beep will sound and the lights should turn to solid. This indicates your controller and the quadcopter are successfully synced. If not, repeat above steps.

For Multi Person Play:

4. Before starting, make sure that the power on all ATOM™ FPV drones and Controllers are in the OFF position. Make sure that there are no other 2.4G devices in the area.
5. Each person will have to sync their ATOM™ FPV individually at a different time to avoid interference. Follow steps 1 to 3 above making sure that no one else is syncing at the same time.
6. After syncing a player's ATOM™ FPV, it should be left ON until all players have synced their ATOM™ FPV quadcopters.
7. Should there be a mistake or interference, all players must turn off their controllers and ATOM™ FPV quadcopters for up to 60 seconds and then begin the process again.

PREPARING FOR FLIGHT

- Verify that there are 2 "AA" batteries inside the remote control unit and the ATOM™ FPV has been fully charged.
- Make sure your ATOM™ FPV and controller are both turned on.
- Make sure to be in a large space with an open radius of at least 50 feet.
- Make sure the empty space has no obstacles and water close by. Set your ATOM™ FPV on a clean flat surface before take-off.

DO NOT ATTEMPT TO FLY YOUR ATOM™ FPV IF THERE IS RAIN, SNOW, HEAVY WINDS, THUNDER OR LIGHTNING OUTDOORS. IT COULD DAMAGE YOUR PRODUCT AND POSSIBLY EVEN CAUSE BODILY HARM.

FLYING TIPS

- It is recommended that you operate the ATOM™ FPV in a wide open space. The ideal space should have a 200 foot radius.
- Parental guidance or adult supervision is suggested at all times.
- If you are flying the ATOM™ FPV with others, make sure all spectators are behind you.
- For best performance, it is recommended that you operate the ATOM™ FPV in zero wind conditions, as wind can greatly affect the performance of the aircraft.

RECOGNIZING THE FRONT & BACK OF THE ATOM™ FPV

Even though the ATOM™ FPV has four rotors, there is still a "front" or forward facing direction and "back" or backwards facing direction. The front and forward facing direction of the ATOM™ FPV is the side with two gray propellers (see diagram E). The rear and backwards facing of the Quadcopter is the side with two red propellers (see diagram E).

NOTE: The front of the Quadcopter displays WHITE LED lights and the back of the Quadcopter displays RED LED lights.

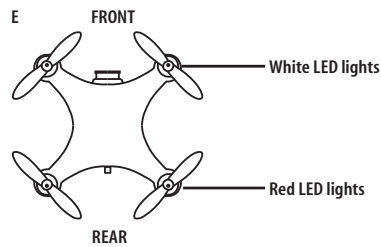

HOW TO START/STOP ROTORS

Make sure you have properly synced the ATOM™ FPV and the power is on.

- To start and stop the rotors simply move the two control sticks simultaneously down and to the outside corners and release (see illustration below).

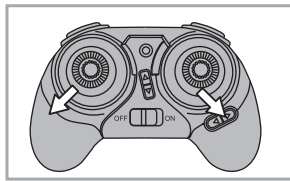

- The rotors should begin to spin and now you are ready for take-off. To shut off the rotors just simply move the control sticks simultaneously down and to the outside corners and release again.

AUTO LAND BUTTON

The ATOM™ FPV has an auto land feature which allows you to land automatically. Simply press the right control stick down for 1.5 seconds and your ATOM™ FPV will begin land itself (see diagram below).

Note: you can still control the direction while auto landing to avoid obstacles

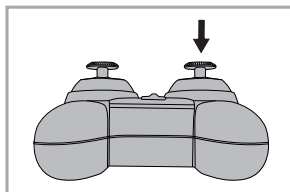

FLIGHT CONTROLS

Below is a list of basic flight functions for your long-range remote control ATOM™ FPV. While learning to fly your ATOM™ FPV it is best to start in a large space until you get used to the basic controls. As you master flying your ATOM™ FPV you can move to more advanced maneuvering techniques. Practice makes perfect! When you have these basic steps down you can move to the next level.

Move the left Throttle stick upwards to increase the speed of the propellers and the ATOM™ FPV will accelerate upwards and ascend.

Move the left Throttle stick down to decrease the speed and the ATOM™ FPV will decelerate and descend (see diagram F).

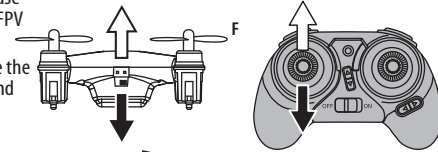

While in the air, move the left Throttle stick left and the ATOM™ FPV will rotate left.

Move the left Throttle stick right and the ATOM™ FPV will rotate right (see diagram G).

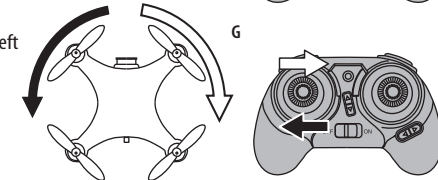

While in the air, move the right Direction Stick up and the ATOM™ FPV will move forward.

Move the right Direction Stick down and the ATOM™ FPV will move backward (see diagram H).

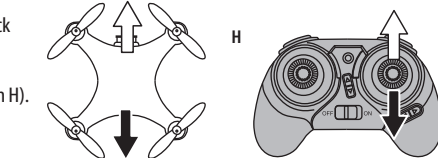

While in the air, move the right Direction Stick left and the ATOM™ FPV will bank to the left.

Move the right Direction Stick right and the ATOM™ FPV will bank to the right (see diagram I).

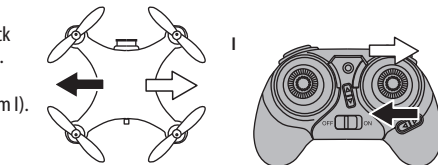

UNDERSTANDING TRIM ADJUSTMENTS

Forward/Backward Trim

- If your ATOM™ FPV is drifting forwards or backwards, you may need to adjust the FORWARD/BACKWARD TRIM (see diagram J).
- If your ATOM™ FPV drifts forward, push and release the BACKWARD TRIM button back repeatedly until the motion stops and proper flight is maintained.
- If your ATOM™ FPV drifts backwards, push and release the FORWARD TRIM button forward in the same manner until the problem is resolved.
- From time to time you may have to adjust the FORWARD or BACKWARD TRIM buttons to ensure the ATOM™ FPV will hover in mid-air and respond accurately to your commands.

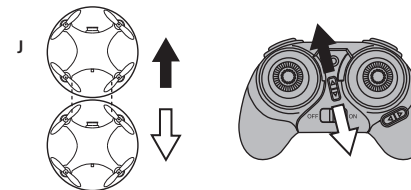

Right/Left Trim

- If your ATOM™ FPV is drifting left or right, you may need to adjust the LEFT/RIGHT TRIM button (see diagram K).
- If your ATOM™ FPV drifts left, push and release the RIGHT TRIM button repeatedly until the motion stops and proper flight is maintained.
- If your ATOM™ FPV drifts right, push and release the LEFT TRIM button in the same manner until the problem is resolved.
- From time to time you may have to adjust the LEFT or RIGHT TRIM buttons to ensure the ATOM™ FPV will hover in mid-air and respond accurately to your commands.

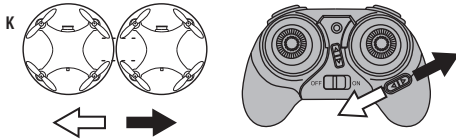

LEVEL SURFACE GYRO CALIBRATION

If the aircraft becomes unstable during the course of flying, or after a crash, you may need to recalibrate the onboard gyro chip. To do so, place the ATOM™ FPV on a flat level surface. Start by syncing the controller with the quadcopter. Next, pull both of the control sticks on the remote down and to the left (approximately 45°) at the same time. The LEDs on the ATOM™ FPV will flash quickly and then remain solid. This indicates your aircraft has been stabilized (see diagram L).

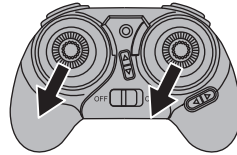

LOW BATTERY WARNING

If the power indicator LED on the remote lights up it means you are running at low voltage and need to land the aircraft slowly and replace the batteries in the controller. If the LED lights on the quadcopter begin flashing it means you are running at low voltage and you need to land the aircraft slowly and recharge the quadcopter unit.

WARNING: Do not attempt a 360° flip when you are given a low voltage warning

SWITCHING TO HIGH SPEED MODE

To change the ATOM™ FPV's flight speed from the default (low speed) to high speed flight mode:

1. Turn on the remote.
2. Depress the speed button on the top left side you will hear two beeps indicating your drone change to high speed mode (see diagram I).
3. To switch back to low speed press the speed button again.
4. Speed mode returns to low speed once the remote is turned off.

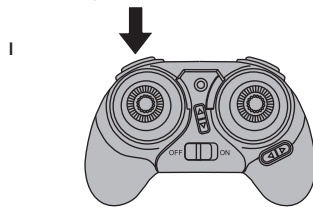

PERFORMING A 360° STUNT ROLL

Once the ATOM™ FPV is airborne,

1. Press the 360° stunt roll button.
2. Move the lever in the direction you wish to perform the 360° roll (see diagram Q).

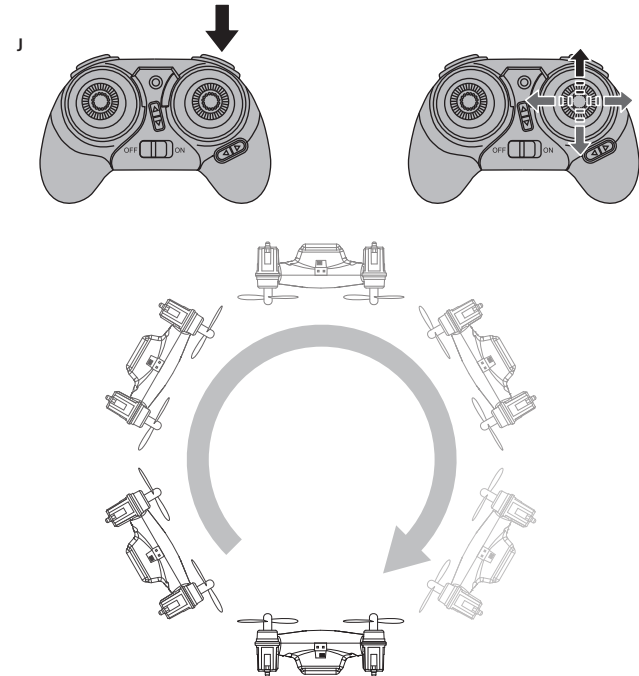

LIVE VIDEO STREAMING

Your ATOM™ FPV comes equipped with an onboard digital camera that takes both video and still photographs to your mobile devices. Now you can have hours of fun creating aerial photography and videos for family and friends.

WHAT YOU WILL NEED TO GET STARTED USING YOUR CAMERA

1. One Apple or Android phone* (not included)
2. Propel ATOM™ FPV APP installed (app store or Android market available)

PROPEL ATOM™ FPV APP INSTALLATION

1. Make sure you are using a compatible Android™ or Apple® iOS device.
2. Make sure your device has access to the Internet.
3. For Apple® iOS devices, within the App Store, search and select “PPL ATOM™ FPV”. Hit the Install button and the “PPL ATOM™ FPV” App should download and install automatically.
4. For Android™ OS devices, visit the Google Play store and search for “PPL ATOM™ FPV”. Selecting the “PPL ATOM™ FPV” App will download the App and automatically install it on your device.
5. After the “PPL ATOM™ FPV” App is installed, it should create an icon on your screen. Click the “PPL ATOM™ FPV” icon to run the App to make sure that it has installed correctly on your device. If not, please delete and repeat the process again.

PAIRING ATOM™ FPV TO YOUR COMPATIBLE DEVICE

1. After completely charging your ATOM™ FPV battery, install the battery to your ATOM™ FPV.
2. In the Settings menu of your mobile device, locate the Wi-Fi option.
3. Turn ON the Wi-Fi option.
4. Select “propel ATOM™ FPV” from the Wi-Fi list. Wait for your ATOM™ FPV to be connected. Return to the Main Menu.



Settings

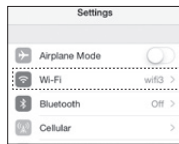

PPLATOMFPV

Note: Apple® devices require the use of iOS 7.0 or higher.

ANDROID™ devices require the use of OS 4.2.2 or higher.

QUICK START

1. When you install the App correctly and have paired to the drone successfully, you can hit the “PPL ATOM™ FPV” App icon. Tap “START” on the bottom right hand side of the screen. You should see the real-time video from your ATOM™ FPV 's camera.
2. This App allows you to control your ATOM™ FPV to take photo or record video by your mobile device. Note: all the photos and videos will be stored in your mobile device, you can review the photos and videos on your mobile device by using this App.

DETAILED APP OVERVIEW

3. Please see images below for a detailed App overview. This overview is also available under the “HELP” icon in the home screen of the App.

HOME PAGE



CONTROL INTERFACE



HELP PAGE 1



HELP PAGE 2

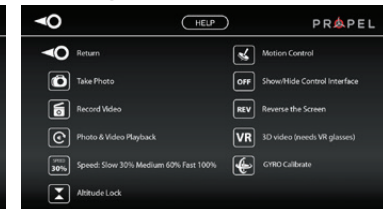

HELP PAGE 3

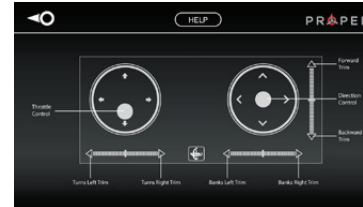

4. If you're still encountering difficulties please contact our customer service department at +1.949.566.9573.

IMPORTANT NOTICE : You can not take photos and videos at the same time. When you are in video mode your camera/ photo button is disabled. If you want to take photos you must first turn off video mode.

USING VR GLASSES

1. PHONE INSTALLATION

Open the VR Glasses phone holder and then place your compatible mobile device into the position, go to the App and start VR option

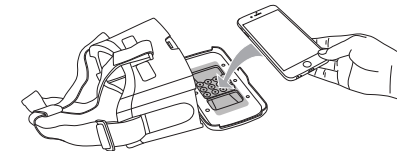

2. WEAR YOUR VR GLASSES

Wear the VR glasses and make a comfortable adjustment to have your fun!

Note: Please do not wear the VR glasses too long time.

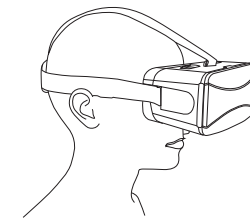

TROUBLESHOOTING YOUR ATOM™ FPV

PROBLEM	POSSIBLE REASON	SOLUTION
NO POWER	1. Power switched off 2. Polarity is reversed 3. Batteries may be dead	1. Switch the ON/OFF switch to ON 2. Make sure all batteries are installed correctly (see diagram B) 3. Replace batteries
Remote Not Responding	1. Remote is switched off 2. ATOM™ FPV is switched off 3. Too windy 4. The Remote light is flashing	1. Switch the ON/OFF switch to ON 2. Switch the ON/OFF switch to ON 3. Windy conditions severely affect the operation of the ATOM™ FPV 4. Replace batteries
Drone Won't lift off	1. Rotor speed too slow 2. Drone not fully charged	1. Push throttle lever forward 2. Recharge your ATOM™ FPV
Drone Descends Too Fast	1. Moving the throttle too quickly	1. Control the throttle slower and smoother
Drone Not Responding	1. Gyroscopes not functioning	1. Turn on the ATOM™ FPV and Reset the Gyros (see diagram L)
Loss of ATOM™ FPV Control	1. Drone is out of range of remote	1. Keep the drone within a 20 meter radius of the remote

REPLACING THE PROPELLER BLADES

Your ATOM™ FPV propeller system is a precision instrument that may need repair or replacement from time to time for optimal flight function. Crash landing from high-speed aerial flights may cause damage to your ATOM™ FPV's propellers.

1. ATOM™ FPV have four blades, two gray propellers on the front, and two red propellers on the back. Please note that the blades and the ATOM™ FPV are labeled with an embossed A or B (see the diagram S).
2. When replacing the propeller blades, gently remove the blade from the rotor shaft. Make sure to match both the color of the blade and the indication letter on the blade with the letter on the aircraft.
3. Replace the damaged blade with the correct blade.

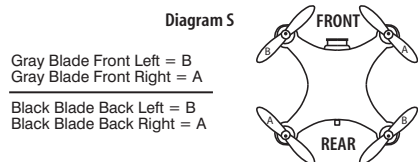

ATOM™ FPV WARNING:

The ATOM™ FPV is designed for INDOOR or OUTDOOR flight. ATOM™ FPV's blades revolve at high speeds and can cause damage to the user, spectators and animals. Stand away from the ATOM™ FPV to reduce the risk of getting into the flight path. Warn spectators that you will be flying your ATOM™ FPV so that they are aware of its position. Before flight, inspect the rotor blades to make certain that the blades are securely fastened to the ATOM™ FPV.

WARNING!

- Choking/Cutting Hazard. Small Parts/Sharp Rotor Blades.
- Keep hands, hair and loose clothing away from the propeller when the power switch is turned to the ON position.
- Turn off the transmitter and ATOM™ FPV power switches when not in use.
- The included charger is built specifically for the ATOM™ FPV Li-Poly battery. Do not use it to charge any other battery.
- New alkaline batteries are recommended for maximum performance.
- Parental supervision recommended when flying ATOM™ FPV

BATTERY WARNINGS

RECHARGEABLE BATTERY:

This ATOM™ FPV uses a Li-Poly rechargeable battery. If battery no longer stays charged, dispose of battery properly according to local disposal requirements.

CONTROLLER BATTERIES:

Remote control requires 2 "AA" batteries (not included). Please read the important battery safety warning below.

- Do not mix alkaline, standard (carbon-zinc) and rechargeable batteries (Nickel Metal Hydride).
- Do not mix old and new batteries.
- Non-rechargeable batteries are not to be recharged.
- Rechargeable batteries are to be removed from the item before being charged (if removable).
- Rechargeable batteries are only to be charged under adult supervision.
- Exhausted batteries should be removed immediately and must be recycled or disposed of properly according to state or local government ordinances and regulations.
- The supply terminals are not to be short-circuited.
- Only batteries of the same or equivalent type as recommended are to be used.
- Batteries are to be inserted with the correct polarity (see inside booklet for diagram).
- Do not dispose batteries in a fire - batteries may leak or explode.

CARE AND MAINTENANCE

- Always remove the batteries from the wireless 2.4G remote control when it is not being used for an extended period of time.
- To clean, gently wipe the remote control and ATOM™ FPV with a clean damp cloth.
- Keep the toy away from direct heat or sunlight.
- Do not submerge the toy into water. This can damage the unit beyond repair.
- Parental guidance recommended when installing or replacing the batteries.