

FCC Part 15 C Notice

CAUTION: Changes or modifications not expressly approved by the party responsible for compliance could void the user's authority to operate the equipment.

NOTE: This equipment has been tested and found to comply with the limits for a Class B digital device, pursuant to Part 15 of the FCC Rules. These limits are designed to provide reasonable protection against harmful interference in a residential installation. This equipment generates, uses and can radiate radio frequency energy and, if not installed and used in accordance with the instructions, may cause harmful interference to radio communications. However, there is no guarantee that interference will not occur in a particular installation. If this equipment does cause harmful interference to radio or television reception, which can be determined by turning the equipment off and on, the user is encouraged to try to correct the interference by one or more of the following measures:

- Reorient or relocate the receiving antenna.
- Increase the separation between the equipment and receiver.
- Connect the equipment into an outlet on a circuit different from that to which the receiver is connected.
- Consult the dealer or experienced radio/TV technician for help.

This device complies with Part 15 of the FCC Rules. Operation is subject to the following two conditions :

- (1) This device may not cause harmful interference, and
- (2) this device must accept any interference received, including interference that may cause undesired operation.



Conforms to safety requirements of FCC.

8619 Wall street, Suite 400, Austin, TX 78754

© 2016 Rooftop Brands™. All Rights Reserved. www.propelrc.com.

Made in China

SKY RAIDER™

2.4Ghz Indoor / Outdoor Battling Quadcopter



INSTRUCTION BOOKLET

WARNING: Never leave product charging unattended for extended periods of time. Always disconnect the battery from charger immediately after the battery is fully charged. Please refer to enclosed safety instructions.

PACKAGE CONTAINS:



Sky Raider™



2.4G Wireless Controller



Spare Parts



USB Charger & Li-Poly Rechargeable Battery



Instruction Manual

Colors and styles may vary.

PROPEL

TABLE OF CONTENTS

Features	2
Remote Control Battery Installation	2
Charging the Sky Raider's Li-Poly Battery	2
Sky Raider™ Battery Installation	2
Sky Raider™ Diagram	3
Remote Control Diagram	3
Flight Preparation	4
Syncing Your Sky Raider™	4
Now You Are Ready To Fly	5
Recognizing The Front & Back of The Sky Raider™	5
Speed Select Button	5
Reverse Button	5
Headless Mode Button	5
Flight Control	6
Flight Practice	6
Adjusting The Trim	7
Calibrating The Sky Raider™	8
Interactive Battle Modes	8
How To Perform 360° Stunt Rolls	9
Troubleshooting Your Sky Raider™	10
Replacing The Propeller Blades	10
Warnings	11
Battery Warnings	11
Care and Maintenance	11
FCC Information	12

Thank you for purchasing the Sky Raider™ 2.4 Ghz High-Performance Stunt Drone. Please read this instruction booklet as it contains valuable information on how to properly fly and care for your Sky Raider™.

FEATURES

- 6 axis gyro keeps the Sky Raider™ stable in all conditions.
- Push button 360° aerial stunts.
- 2 speed settings for beginner to advanced quadcopter pilots.
- Laser battle game with other Sky Raider™ battling drones.
- On board 2.4Ghz digital spread spectrum allows up to 8 players to battle simultaneously.

REMOTE CONTROL BATTERY INSTALLATION

1. Unscrew the security screw and remove the battery cover from the back of the controller.
2. Install 3 "AA" alkaline batteries into the controller as shown in diagram A.
3. Replace the battery cover and security it.
4. Switch the controller power on you will see the indicator lights up and feel a vibration if the batteries were installed properly.

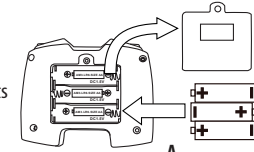

CHARGING THE SKY RAIDER'S LI-POLY BATTERY

1. Connect the battery to the USB charger as shown (see illustration B).
Caution: The USB plug fits the charging socket only in one way. Do not force it.
2. Next, connect the USB charger to your computer's USB port (see diagram C). The LED lights will flash a few times then stay solid while charging.
Caution: Only use this charger with a computer USB port! Do not attempt to use other USB charging devices.
3. The red LED on the USB plug lights off when charging is complete (See diagram D).
Note: If the red LED lights off, either the charging is complete or the USB plug is not properly connected.
4. Average charging time is approximately 40 minutes. A fully charged drone can fly for approximately 5-6 minutes depending on environment and user input.
Note: If plug the USB cord in without connect battery, the red LED light will keep flashing.



IMPORTANT: ALWAYS REMEMBER TO UNPLUG YOUR CHARGING CORD WHEN NOT IN USE!

SKY RAIDER™ BATTERY INSTALLATION

1. Pull the Sky Raider's battery compartment lock and Connect the power cord as shown on diagram E,
2. Slide the battery into Sky Raider™ battery compartment and close the battery compartment cover (see diagram F).
3. Turn on the ON/OFF switch of the Sky Raider™, the LED lights should flashing indicates you install the battery properly.

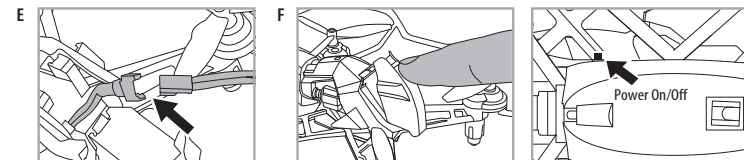

SKY RAIDER™ DIAGRAM

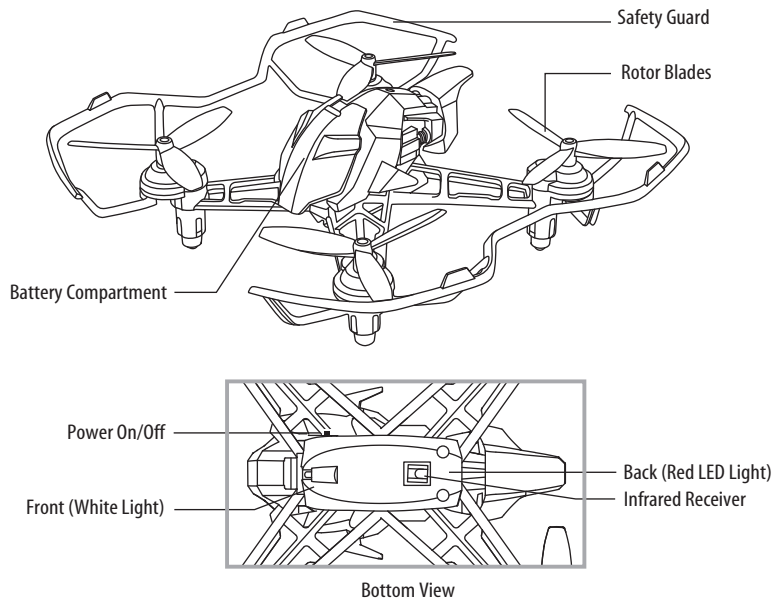

CONTROLLER DIAGRAM

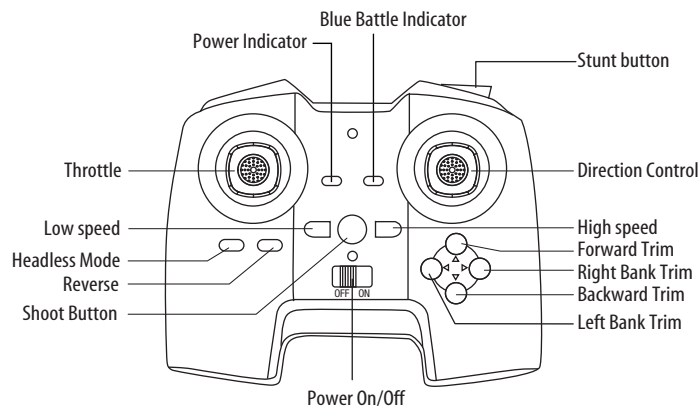

WARNING

DO NOT FLY YOUR SKY RAIDER™ IN FOUL WEATHER!



FLIGHT PREPARATION

- Verify that there are 3 "AA" batteries installed the remote control unit and the Sky Raider™ battery has been fully charged.
- Make sure to be in a large open space preferably a field or a park with an open radius of at least 200 feet.
- Make sure to start your drone on a clean flat level surface before take-off.
- **IMPORTANT! Until you have experience in flying your Sky Raider™, it is not advised to use in any rate of wind. Wait until a zero wind day or extremely light wind when learning how to fly.**

SYNCING YOUR SKY RAIDER™

Important! When syncing your Sky Raider™ with the controller always make sure that the drone is on a flat level surface and that your digital trim settings are in the center position. This insures that the 6 Axis gyro is properly programmed to respond to your trim settings. Your Sky Raider™ utilizes an automatic 2.4G channel selection system that allows up to 8 people to fly side by side in the same wireless range with no interference.

1. Before starting, make sure that the power switch is off both on your controller and the Sky Raider™. Make sure that there are no other 2.4G devices in the area.
2. Turn on your Sky Raider™ and set it down on a flat surface. The red and white LED lights of the drone should begin to flash repeatedly.
3. Quickly turn ON the remote and you will notice that the red LED light on the face of the controller should light up and stay solid. The "Battle Indicator" will flash once then off. The lights on the drone will flash slower.
4. Push the left control stick all the way up until it stops and then pull it back all the way down to the bottom (see illustration below). You will hear 2 high-pitched beeps when pulling the throttle up and down. The lights on the drone should stop flashing and become solid. If the lights on both the drone and the controller have stopped flashing and become solid you have successfully synced your Sky Raider™ and are ready to fly. If the lights on the controller or the drone are still flashing repeat steps 1-4 again.

TIP 1: try not to leave too much time between turning on the drone and the controller or your syncing window will time-out.

TIP 2: Syncing your drone indoors or in the shade will make it easier to see the LED light indicators on both the controller and the drone.

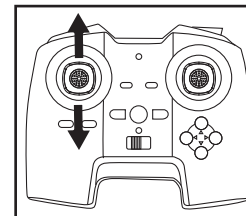

move the control stick all the way up and all the way down you should hear a beep

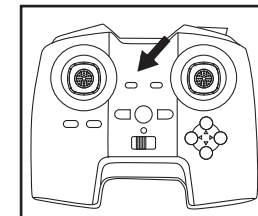

the flashing red LED light will become solid when you are synced

NOW YOU ARE READY TO FLY!

If you have successfully synced your Sky Raider™ to your controller as explained on page 4 you are now ready to fly. Before beginning to fly your drone you should familiarize yourself with how the controls work so please carefully read and familiarize yourself with various control features explain in the next two pages. Once again as a beginner pilot you should learn how to control your drone in a large open field or park on a day with zero or very light wind. Do not try to fly your Sky Raider™ too high until you become a more experience pilot.

RECOGNIZING THE FRONT & BACK OF THE SKY RAIDER™

Even though the Sky Raider™ has four rotors there is still a front or "forward" facing direction and "back" or backwards facing direction. The forward Front and forward facing direction of the Sky Raider™ is the side with two gray blades (see diagram G). The rear and back of the Quadcopter is the side with two black propellers (see diagram G).

NOTE: The front of the Quadcopter also displays **WHITE LED** light and the back of the Quadcopter displays **RED LED** lights.

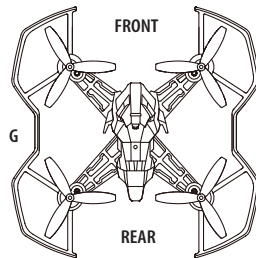

SPEED SELECT BUTTON

The Sky Raider™ has 2 speed settings; SLOW, and HIGH. The Default setting when you first turn on your Sky Raider™ is the SLOW speed mode. To increase the speed simply press the Speed setting button (see remote diagram on pg 3) you will hear 2 beeps and the speed changed to HIGH speed. Speed settings can be set before flight or during the flight.

REVERSE BUTTON

The Sky Raider™ has an REVERSE feature which allows you to operate your drone fly backward automatically. Simply press the REVERSE Button and your Sky Raider™ will begin fly backward. To exit the reverse mode simply press the REVERSE Button again or push the direction control stick to any direction.

HEADLESS MODE BUTTON

You can maintain orientation of your Sky Raider™ during flight.

1. Once the Sky Raider™ is activated press the headless mode button (see controller on pg.3) to activate the internal compass.
2. The flying orientation is now locked to match the direction control lever.

Note: Before switch to "headless Mode", you need place the drone straight ahead right in front of you, Calibrate it first then press the headless mode button.

FLIGHT CONTROL

Below is a list of basic flight functions for your long-range remote to control the Sky Raider™. While learning to fly your Sky Raider™ it is best to start in a large space until you get used to the basic controls. As you master flying your Sky Raider™ you can move to more advanced maneuvering techniques. Practice makes perfect!

Move the left Throttle stick up to increase the propeller speed and the Sky Raider™ will accelerate and ascend.

Move the left Throttle stick down to decrease the propeller speed and the Sky Raider™ will decelerate and descend (see diagram H).

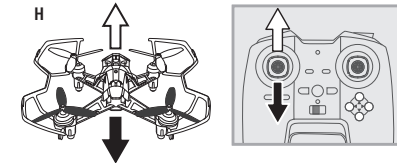

While in the air, move the left Throttle stick left and the Sky Raider™ will rotate left.

Move the left Throttle stick right and the Sky Raider™ will rotate right (see diagram I).

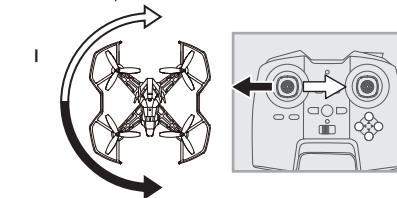

While in the air, move the right Direction Stick up and the Sky Raider™ will move forward.

Move the right Direction Control down and the Sky Raider™ will move backward (see diagram J).

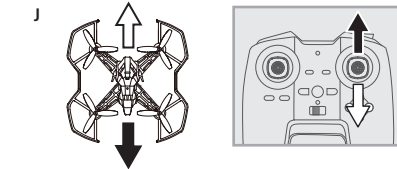

While in the air, move the right Direction Control left and the Sky Raider™ will bank to the left.

Move the right Direction Control right and the Sky Raider™ will bank to the right (see diagram K).

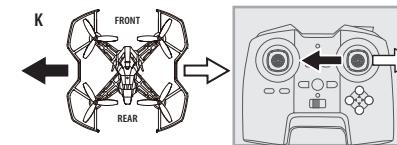

FLIGHT PRACTICE

To master flying your aircraft try practicing the excersizes shown below. Start with simple vertical takeoffs, landings, and left/right turning and rotating. Once those are mastered move on to square and cross maneuvers. Good luck and have fun!

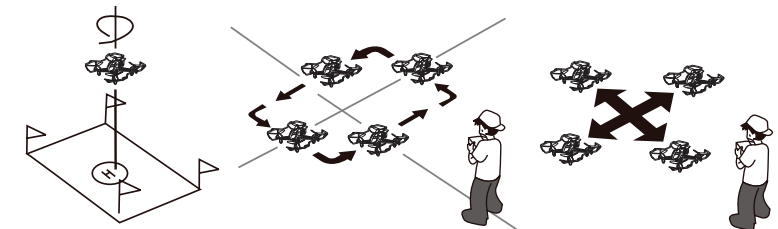

Fixed-point landing

Square Pattern Maneuver

Cross Pattern Maneuver

ADJUSTING THE TRIM

NOTE: The Sky Raider™ is already properly trimmed and calibrated right out of the box and should not require any trim adjustments before flying. Some more experienced pilots may want to adjust trim settings for their style of flying. After several crashes you may need to adjust trim settings for the Sky Raider™ to be more balanced.

Forward/Backward Trim

- If your Sky Raider™ drifts forward while in the air, push and release the BACKWARD TRIM button back repeatedly until the motion stops and proper flight is maintained (see diagram L).
- If your Sky Raider™ drifts backwards, push and release the FORWARD TRIM button forward in the same manner until the problem is resolved.

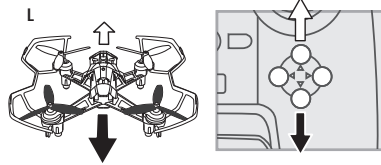

Bank Right/Left Trim

- If your Sky Raider™ drifts left while in the air, push and release the RIGHT TRIM button back repeatedly until the motion stops and proper flight is maintained (see diagram M).
- If your Sky Raider™ drifts right, push and release the LEFT TRIM button in the same manner until the problem is resolved.

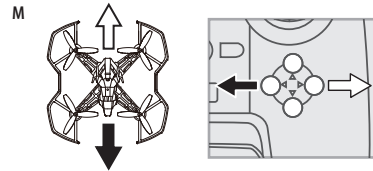

NOTE: The use of the Trim buttons utilizes sounds. A single long Beep indicates the product is center trimmed. If there is no beep sound after press the trim button, it indicates the maximum rang of the trim on a particular side.

CALIBRATING THE SKY RAIDER™

NOTE: Your Sky Raider™ comes pre-calibrated out of the box so you are ready to fly.

After several crashes and shock to your gyro sensors, you may notice that your drone is drifting and not holding its center position as well as it used to.

This most likely means that you need to recalibrate the 6 axis gyro. Please follow the simple instructions below.

1. Place the Sky Raider™ on a flat ground or any other flat stable surface.
2. Make sure the Sky Raider™ is on and that the controller is synced (refer to syncing pg 4.). Do not start the blades. Move both the throttle and control stick down and to the left corner and hold them there for 5 seconds(See Diagram P). You will see the lights on the drone rapidly flash and stop. Once the lights stop flashing you have completed your calibration and are ready to fly!

TROUBLE SHOOTING: If you do not see the lights flash, turn off your controller take out the battery in the Drone and Start again. Always make sure to put your battery in the copter first, then turn on your controller. Push the left throttle stick up all the way and then pull back down all the way. When you hear the beep the Sky Raider™ is synced to the controller and you are ready to calibrate.

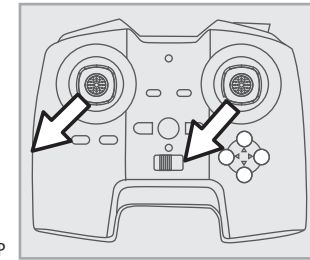

INTERACTIVE BATTLE MODES

Get ready for aerial combat missions with your friends (Note Requires additional Sky Raider™).

PREPARATION FOR MISSION:

1. Make sure all battling quadcopters are fully charged, properly synced and ready to fly (refer to SYNCING YOUR Sky Raider™).

READY, AIM, FIRE!

1. While your Sky Raider™'s in flight, aim the front side of your Sky Raider™ to your opponent's Sky Raider™ and press the SHOOT button on the face of your remote control.
 2. If you score first hit, your opponent's remote control will vibrate one short time, the Sky Raider™ will swing one time, in the mean time the indicator lights will flash one time from the next strike.
 3. If you score second hit, your opponent's remote control will vibrate two short times, the Sky Raider™ will swing one time, in the mean time the indicator lights will flash two times from the next strike.
- THREE STRIKES YOU'RE OUT!
4. On the third direct hit, your opponent's remote control will vibrate one long time, your opponent's Sky Raider™ indicator lights will continuously flash and your opponent will not be able to control the quadcopter. The quadcopter will gradually descend safely to the ground. Mission accomplished!
 5. Once the quadcopter fully stops, your opponent can pull the throttle all the way down to recover (reset) and will be ready for the next dogfight.

HOW TO PERFORM 360° STUNT ROLLS

Performing 360° stunt rolls with the Sky Raider™ is as easy as 1-2-3:

1. Hover the Sky Raider™ in still position making sure that you have at least 5 feet of clearance above and below the quadcopter.
2. Press and release the 360° stunt button and you will enter the stunt roll mode the controller will start beeping. (see diagram Q1).
3. Determine which direction you want it to flip and quickly push the right control stick in the direction you want to flip your Sky Raider™ (see diagram Q2). You have 4 choices a) Forward Roll, b) Backwards roll, c) Right side roll, d) Left side roll. After stunt roll, it will automatically exit the stunt mode.
4. To exit the Stunt Roll mode manually, simply Press and release the button again. The controller will stop beeping.

360° Stunt Roll Button

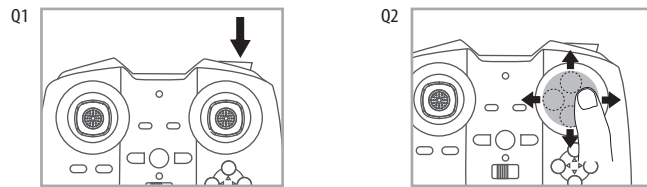

TROUBLESHOOTING YOUR SKY RAIDER™

PROBLEM	POSSIBLE CAUSE	POSSIBLE SOLUTION
No Power	<ol style="list-style-type: none"> 1. Power switched off 2. Polarity is reversed 3. Batteries may be low or in need of charging 	<ol style="list-style-type: none"> 1. Switch the ON/OFF switch to ON 2. Make sure all batteries are installed correctly (see diagram A on pg.2) 3. Replace batteries
Drone Not Responding	<ol style="list-style-type: none"> 1. Remote is switched off 2. battery power in remote is too weak 3. The remote is not properly synced 4. Out of control range 	<ol style="list-style-type: none"> 1. Switch the ON/OFF switch to ON 2. Connect the battery to Sky Raider™ 3. Re-sync the remote 4. Do not fly beyond 500 feet
Drone Won't lift off	<ol style="list-style-type: none"> 1. Rotor speed too slow 2. Drone not fully charged 3. Obstruction of rotors 	<ol style="list-style-type: none"> 1. Push throttle lever forward 2. Recharge your Sky Raider™ 3. Check rotors for hair or other obstructions
Drone Descends Too Fast	Moving the throttle down too quickly flying in high wind or bad weather	Control the throttle slower, use auto land feature, Do not fly in bad weather

If you continue to encounter problems call our customers service line at (949) 566-9573 Ext 1 for assistance.

REPLACING THE PROPELLER BLADES

Your Sky Raider's propeller system is a precision instrument that may need repair or replacement from time to time for optimal flight function. Crash landing at high-speed may cause damage to your Sky Raider's propellers.

1. The Sky Raider™ has four blades, two gray blades in the front, and two black blades in the back (see the diagram S).
2. When replacing the propeller blades, make sure to match both the color of the blade and the indication letter on the blade.
3. Replace the damaged blade with the correct blade.

Gray Blade Front Left = L
Gray Blade Front Right = R

Black Blade Back Left = R
Black Blade Back Right = L

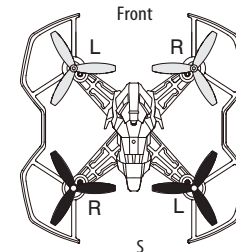

SKY RAIDER™ WARNING:

The Sky Raider™ is designed for indoor & outdoor use. The Sky Raider's blades revolve at high speeds and can cause damage to the user, spectators and animals. Stand away from the Sky Raider™ to reduce the risk of getting into the flight path. Warn spectators that you will be flying your Sky Raider™ so that they are aware of its position. Before flight, inspect the rotor blades to make sure that the blades are securely fastened to the Sky Raider™.

WARNING!

- Choking/Cutting Hazard. Small Parts/Sharp Rotor Blades.
- Keep hands, hair and loose clothing away from the propeller when the power switch is turned to the ON position.
- Turn off the transmitter and Sky Raider™ power switches when not in use.
- The included charger is built specifically for the Sky Raider™ Li-Poly battery. Do not use it to charge any other battery.
- New alkaline batteries are recommended for maximum performance.
- Parental supervision recommended when flying Sky Raider™.

BATTERY WARNINGS

RECHARGEABLE BATTERY:

This Sky Raider™ uses a Li-Poly rechargeable battery. If battery no longer stays charged, dispose of battery properly according to local disposal requirements.

CONTROLLER BATTERIES:

Remote control requires 3 "AA" batteries (not included).

Please read the important battery safety warning below.

- Do not mix alkaline, standard (carbon-zinc) and rechargeable batteries (Nickel Metal Hydride).
- Do not mix old and new batteries.
- Non-rechargeable batteries are not to be recharged.
- Rechargeable batteries are to be removed from the item before being charged (if removable).
- Rechargeable batteries are only to be charged under adult supervision.
- Exhausted batteries should be removed immediately and must be recycled or disposed of properly according to state or local government ordinances and regulations.
- The supply terminals are not to be short-circuited.
- Only batteries of the same or equivalent type as recommended are to be used.
- Batteries are to be inserted with the correct polarity (see inside booklet for diagram).
- Do not dispose batteries in a fire - batteries may leak or explode.

CARE AND MAINTENANCE

- Always remove the batteries from the wireless remote control when it is not being used for an extended period of time.
- To clean, gently wipe the remote control and Sky Raider™ with a clean damp cloth.
- Keep the toy away from direct heat or sunlight.
- Do not submerge the toy into water. This can damage the unit beyond repair.
- Parental guidance recommended when installing or replacing the batteries.