

**FCC Part 15 Notice**

CAUTION: Changes or modifications not expressly approved by the party responsible for compliance could void the user's authority to operate the equipment.

NOTE: This equipment has been tested and found to comply with the limits for a Class B digital device, pursuant to Part 15 of the FCC Rules. These limits are designed to provide reasonable protection against harmful interference in a residential installation. This equipment generates, uses and can radiate radio frequency energy and, if not installed and used in accordance with the instructions, may cause harmful interference to radio communications. However, there is no guarantee that interference will not occur in a particular installation. If this equipment does cause harmful interference to radio or television reception, which can be determined by turning the equipment off and on, the user is encouraged to try to correct the interference by one or more of the following measures:

- Reorient or relocate the receiving antenna.
- Increase the separation between the equipment and receiver.
- Connect the equipment into an outlet on a circuit different from that to which the receiver is connected.
- Consult the dealer or experienced radio/TV technician for help.

This device complies with Part 15 of the FCC Rules. Operation is subject to the following two conditions :

- (1) This device may not cause harmful interference, and
- (2) this device must accept any interference received, including interference that may cause undesired operation.



Conforms to safety requirements of ASTM, CPSIA and FCC.

©2015 Rooftop Brands™ All rights reserved  
Tel: + (1) 949-566-9573 • www.propelrc.com

Made in China

# SPYDER X™

Palm Sized High Performance "Stunt" Drone

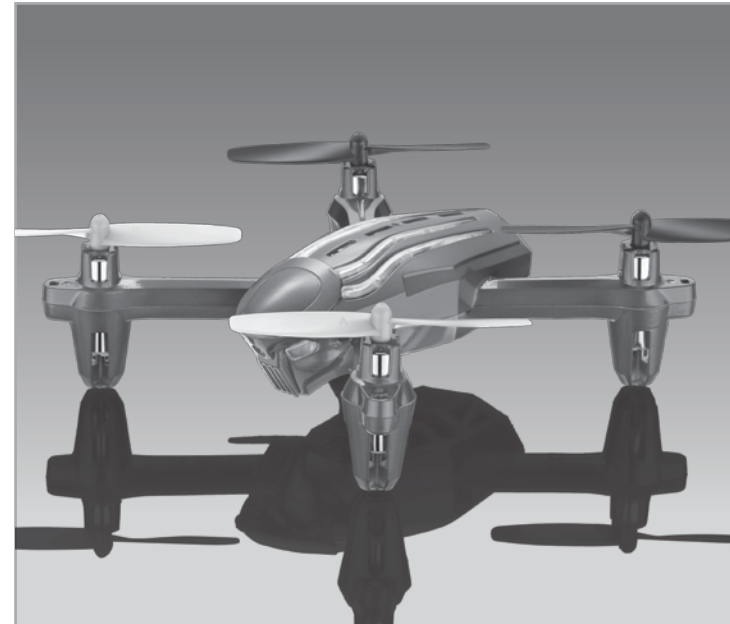

**INSTRUCTION BOOKLET**

**WARNING:** Never leave product charging unattended for extended periods of time. Always disconnect Spyder X™ from charger immediately after the Spyder X™ is fully charged. Please refer to enclosed safety instructions.

**PACKAGE CONTAINS:**



Spyder X™



2.4G Wireless Controller



Spare Parts



USB charging cord



Instruction Manual

Colors and styles may slightly vary.

## TABLE OF CONTENTS

Product Features .....	2
Remote Control Battery Installation .....	2
Charging Your Spyder X™ Battery .....	2
Spyder X™ Quadcopter Diagram .....	3
Remote Control Diagram .....	3
Flight Preparation .....	4
Syncing Your Spyder X™ .....	4
Flying Tips .....	4
Recognizing The Front & Back Of The Spyder X™ .....	5
4 Channel Flight Control .....	5
Adjusting Trim .....	6
Level Surface Calibration .....	6
Flight Environment .....	6
Flight Practice .....	7
Performing A 360° Stunt Flip .....	7
Trouble Shooting .....	8
Replacing The Propeller Blades .....	9
Warnings .....	10
Battery Warnings .....	10
Care and Maintenance .....	10
FCC Information .....	11

## FEATURES

- 6 axis gyro high-speed aircraft for incredible maneuvers including 360° aerial stunts!
- Built-in 6axis gyro chip for extremely stable flight and maneuverability.
- 2.4 Ghz, remote allows flight range up to 300 feet and multiple player use.

## REMOTE CONTROL BATTERY INSTALLATION

1. Remove the battery cover from the back of the controller as shown in diagram A.
2. Install 6“AA” fresh alkaline batteries into the controller as shown in diagram B. Make sure to install batteries to their correct polarity. Do not mix old and new batteries or battery types.
3. Replace the battery cover.

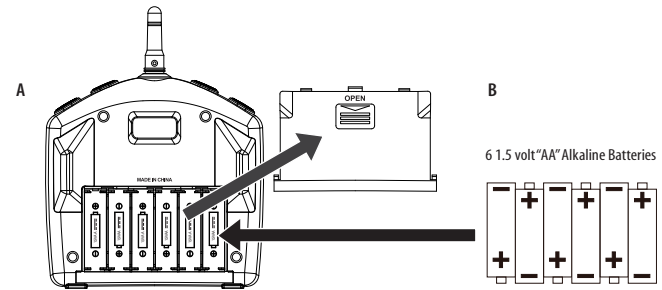

## CHARGING YOUR SPYDER X™ BATTERY

1. Turn the Spyder X™ over and carefully remove the battery (see diagram C).
2. Connect the battery to the female connector end of the USB cable. Connect the universal end of the USB cable to your computer's USB port (see diagram D).  
CAUTION: improper connection may damage the Spyder X™.
3. Average charging time is 70 minutes, RED LED indicator goes off when charging and will turn RED when battery is fully charged.  
A full charge will allow for about 5-6 minutes of flight time depending on environment and user input.

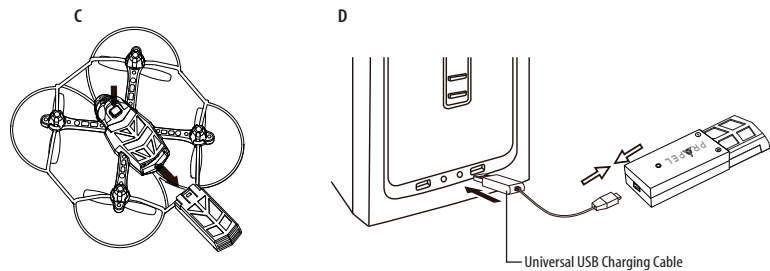

Thank you for purchasing the Spyder X™ 2.4 Ghz Quadcopter. Please read this instruction booklet as it contains valuable information on how to properly fly and care for your Spyder X™ Drone.

**IMPORTANT: ALWAYS REMEMBER TO UNPLUG YOUR CHARGING CORD WHEN NOT IN USE!**

## SPYDER X™ QUADROCOPTER DIAGRAM

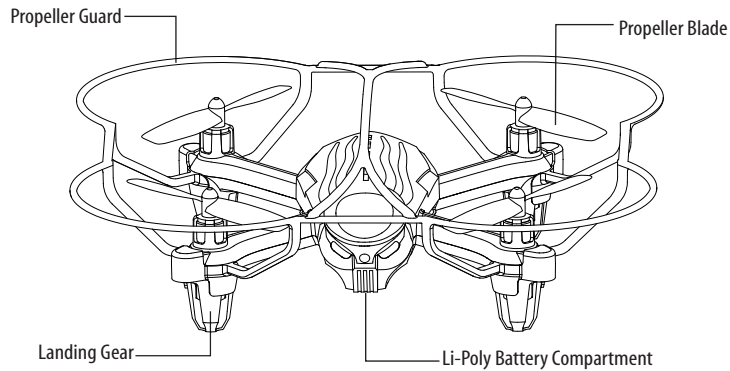

## SPYDER X™ REMOTE DIAGRAM

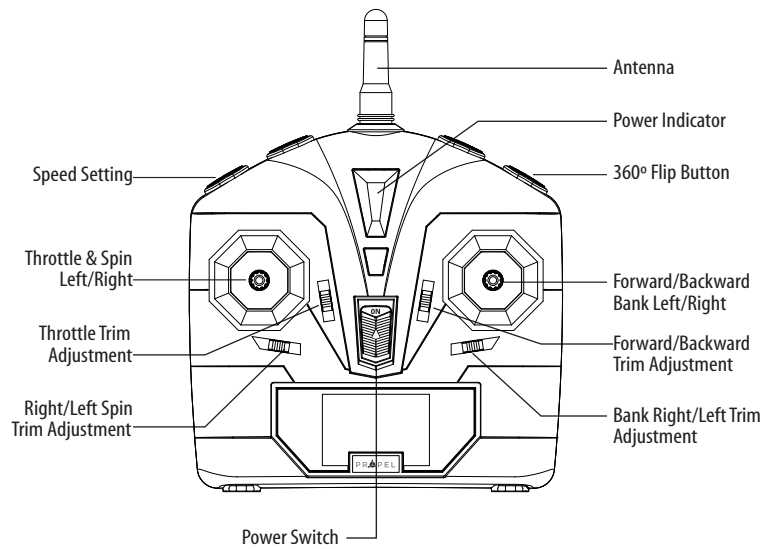

## WARNING

**DO NOT FLY YOUR SPYDER X™ IN FOUL WEATHER!**



## FLIGHT PREPARATION

- Verify that there are 6 "AA" batteries inside the remote control unit and the Spyder X™ has been fully charged.
- Make sure your Spyder X™ and controller are both turned on.
- Make sure to be in a large space with an open radius of at least 100 feet.
- Make sure the empty space has no obstacles. Set your Spyder X™ on a clean flat surface before take-off.

**DO NOT ATTEMPT TO FLY YOUR SPYDER X™ IF THERE IS RAIN, SNOW, HEAVY WINDS, THUNDER OR LIGHTNING OUTDOORS. IT COULD DAMAGE YOUR PRODUCT AND POSSIBLY EVEN CAUSE BODILY HARM.**

## SYNCING YOUR SPYDER X™

**Important!** When syncing your SPYDER X™ quadcopter with the controller always make sure that the quadcopter is on a flat level surface and that your digital trim settings are in the center position. This insures that the 6 Axis gyro is properly programmed to mimic your trim settings.

Your Spyder X™ utilizes an automatic 2.4G channel selection system that allows up to 8 people to fly side by side in the same wireless range with no interference.

### Syncing your aircraft:

1. Before starting, make sure that the power on your controller is in the OFF position and the Spyder X™ wire leads are not connected. Make sure that there are no other 2.4G devices in the area as well.
2. Connect the battery wire lead to the Spyder X™ lead and set it down on a flat surface. The LED indicator lights of the Spyder X™ should begin to flash (see diagram E).
3. Turn ON the remote, you will hear a beep, the Spyder X™'s flashing LED lights should change to solid, push the throttle on the left all the way forward and then slowly pull the throttle all the way back. You will hear 2 beeps and your controller should now have a solid red light. If not, repeat the above steps.

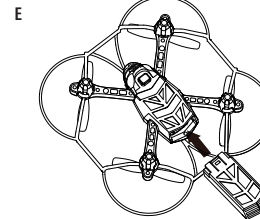

## FLYING TIPS

- It is recommended that you operate the Spyder X™ in a wide space. The ideal space should have a 200 foot radius.
- Parental guidance or adult supervision is suggested at all times.
- If you are flying the Spyder X™ with others, make sure all spectators are behind you.
- For best performance, it is recommended that you operate the Spyder X™ in zero wind conditions. Wind can greatly affect the performance of the aircraft or cause injury.

## RECOGNIZING THE FRONT & BACK OF THE SPYDER X™

Even though the Spyder X™ has four rotors there is still a front or "forward" facing direction and "back" or backwards facing direction. The front of the Quadcopter displays BLUE LED lights and the back of the Quadcopter displays RED LED lights when activated (see diagram F).

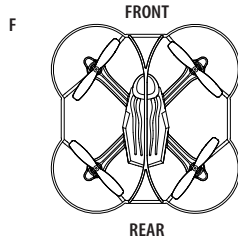

## 4 CHANNEL FLIGHT CONTROL

Below is a list of basic flight functions for your long-range remote control Spyder X™. While learning to fly your Spyder X™ it is best to start with a large space until you get used to the basic controls. As you master flying your Spyder X™ you can move to more advanced maneuvering techniques. Practice makes a perfect! When you have these basic steps done you can move to the next level.

Move the left Throttle stick up to increase the speed and the Spyder X™ will accelerate and ascend.

Move the left Throttle stick down to decrease the speed and the Spyder X™ will decelerate and descend (see diagram G).

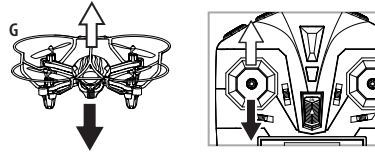

Move the left Throttle stick left and the Spyder X™ will rotate left.

Move the left Throttle stick right and the Spyder X™ will rotate right (see diagram H).

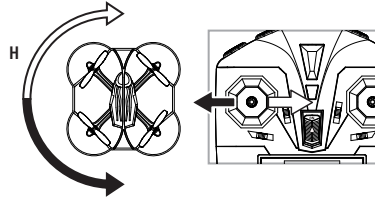

Move the right Direction Stick up while in flight and the Spyder X™ will move forward.

Move the right Direction Control down while in flight and the Spyder X™ will move backward (see diagram I).

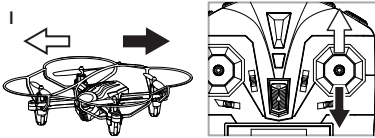

Move the right Direction Control left and the Spyder X™ will bank to the left.

Move the right Direction Control right and the Spyder X™ will bank to the right (see diagram J).

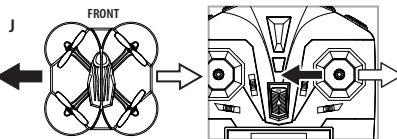

## ADJUSTING TRIM

From time to time you may have to adjust the TRIM buttons to ensure the Spyder X™ will hover in mid-air and respond accurately to your commands.

### Forward/Backward Trim

- If your Spyder X™ drifts forward, push and release the BACKWARD TRIM button back repeatedly until the motion stops and proper flight is maintained (see diagram K).
- If your Spyder X™ drifts backwards, push and release the FORWARD TRIM button forward in the same manner until the problem is resolved.

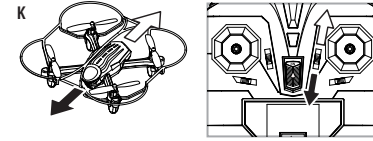

### Right/Left Trim

- If your Spyder X™ drifts left, push and release the RIGHT TRIM button back repeatedly until the motion stops and proper flight is maintained (see diagram L).
- If your Spyder X™ drifts right, push and release the LEFT TRIM button in the same manner until the problem is resolved.

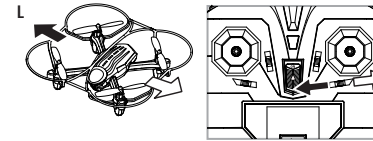

### Right/Left Spin Trim

- If your Spyder X™ spins left, push and release the RIGHT SPIN TRIM button back repeatedly until the motion stops and proper flight is maintained (see diagram M).

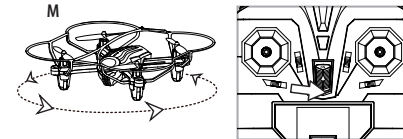

- If your Spyder X™ spins right, push and release the LEFT SPIN TRIM button in the same manner until the problem is resolved (see diagram N).

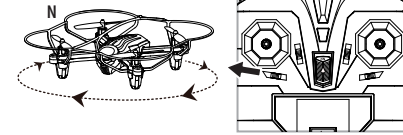

## SPEED SELECT BUTTON

The Spyder X™ has 3 speed settings; SLOW (40%), MEDIUM (70%) and HIGH (100%). The Default setting when you first turn on your Spyder X™ is the SLOW (40%) speed mode. Change the speed to MEDIUM you simply press the Speed setting button (see remote diagram on pg 3) you will hear two beeps that means your Spyder X™ speed on MEDIUM (70%) setting. Change the speed to HIGH (100%) you press the Speed setting button you will hear three beeps that mean your Spyder X™ speed on HIGH (100%) setting. You will be notice what speed you are on base on the beeps, one for SLOW, TWO for MEDIUM, THREE for High. Speed settings can be set before flight or during the flight.

## LEVEL SURFACE CALIBRATION

If the aircraft becomes unstable during the course of flying, you may need to restabilize the internal gyros.

To do this place the Spyder X™ on a level surface, SET THE SPEED SETTING TO 100% (you will hear three beeps) then pull both of the control levers on the remote down and to the left (approximately 45°) at the same time. The LEDs on the Spyder X™ will flash quickly and then remain solid, this indicates your aircraft has been stabilized (see diagram O).

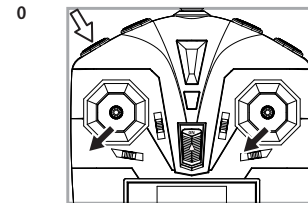

## FLIGHT PRACTICE

To master flying your aircraft try practicing the exercises shown below. Start with simple vertical takeoffs, landings, and left/right turning and rotating. Once those are mastered move on to square and cross maneuvers. Good luck and have fun!

Fixed-point revolving

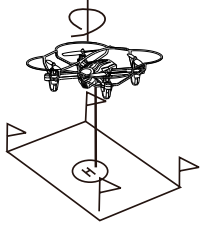

Fixed-point landing

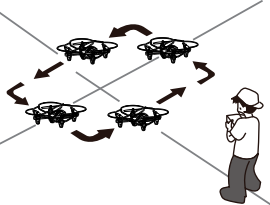

Square Pattern Maneuver

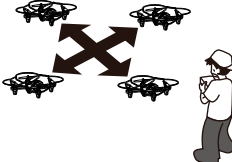

Cross Pattern Maneuver

## PERFORMING 360° STUNT FLIPS

After you have mastered flying the Spyder X™ you are ready to try flips. Once the Spyder X™ is hovering at least 3 meters (about 10 feet) off the ground trigger the 360° Flip Button (see diagram P1) and push the right lever forward slightly and let go. The Spyder X™ will instantly perform a forward flip. To perform a backwards or side flip press and hold the 360° Flip Button and push the right lever in the direction you wish to flip just as you did for the forward flip (see diagram P2 & P3).

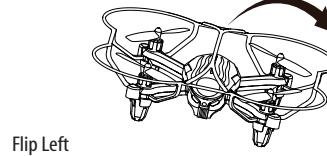
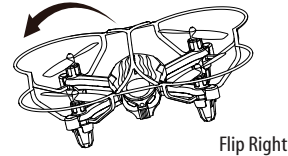
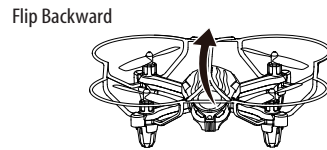
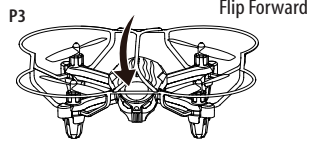
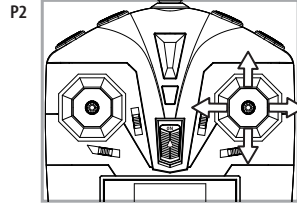
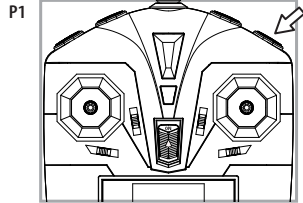

## TROUBLESHOOTING YOUR SPYDER X™

PROBLEM	POSSIBLE REASON	SOLUTION
No Power	<ol style="list-style-type: none"> <li>1. Power switched off</li> <li>2. Polarity is reversed</li> <li>3. Batteries may be dead</li> </ol>	<ol style="list-style-type: none"> <li>1. Switch the ON/OFF switch to ON</li> <li>2. Make sure all batteries are installed correctly (see diagram B)</li> <li>3. Replace batteries</li> </ol>
Remote Not Responding	<ol style="list-style-type: none"> <li>1. Remote is switched off</li> <li>2. Spyder X™ battery is not connected</li> <li>3. Too windy</li> <li>4. The remote is not synced</li> </ol>	<ol style="list-style-type: none"> <li>1. Switch the ON/OFF switch to ON</li> <li>2. Switch the ON/OFF switch to ON</li> <li>3. Windy conditions severely impair the operation of the Spyder X™</li> <li>4. Re-sync the remote</li> </ol>
Aircraft Won't lift off	<ol style="list-style-type: none"> <li>1. Rotor speed too slow</li> <li>2. Aircraft not fully charged</li> </ol>	<ol style="list-style-type: none"> <li>1. Push throttle lever forward</li> <li>2. Recharge your Spyder X™</li> </ol>
Aircraft Descends Too Fast	<ol style="list-style-type: none"> <li>1. Moving the throttle too quickly</li> </ol>	<ol style="list-style-type: none"> <li>1. Control the throttle slower and smoother</li> </ol>
Aircraft Not Responding	<ol style="list-style-type: none"> <li>1. Gyroscopes not functioning</li> </ol>	<ol style="list-style-type: none"> <li>1. Turn of the Spyder X™ and Reset the Gyro (see diagram L)</li> </ol>
Loss of Spyder X™ Control	<ol style="list-style-type: none"> <li>1. Aircraft is out of range of remote</li> </ol>	<ol style="list-style-type: none"> <li>1. Keep the aircraft within a 300 Feet radius of the remote</li> </ol>

## REPLACING THE PROPELLER BLADES

Your Spyder X™ propeller system is a precision instrument that may need repair or replacement from time to time for optimal flight function. Crash landing from high-speed aerial flights may cause damage to your Spyder X™ propellers.

1. Spyder X™ have four blades, two on the front, and two on the back.  
Always disconnect the battery before replacing the propeller blades.  
Please note that the blades and the Spyder X™ are labeled with an embossed A or B (see diagram Q).
2. When replacing the propeller blades, gently remove the blade from the rotor shaft.
3. Replace the damaged blade with the correct blade. Make sure to match the indication letter on the blade with the letter on the aircraft as shown in diagram Q.

Diagram Q

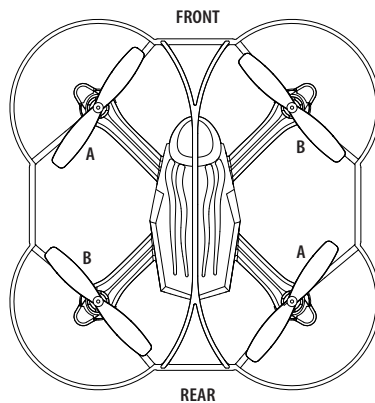

## SPYDER X™ WARNING:

The Spyder X™ is designed for INDOOR or OUTDOOR. Spyder X™ blades revolve at high speeds and can cause damage to the user, spectators and animals. Stand away from the Spyder X™ to reduce the risk of getting into the flight path. Warn spectators that you will be flying your Spyder X™ so that they are aware of its position. Before flight, inspect the rotor blades to make certain that the blades are securely fastened to the Spyder X™.

### WARNING!

- Choking/Cutting Hazard. Small Parts/Sharp Rotor Blades.
- Keep hands, hair and loose clothing away from the propeller when the power switch is turned to the ON position.
- Turn off the transmitter and Spyder X™ power switches when not in use.
- The included charger is built specifically for the Spyder X™ Li-Poly battery. Do not use it to charge any other battery.
- New alkaline batteries are recommended for maximum performance.
- Parental supervision recommended when flying Spyder X™.

## BATTERY WARNINGS

### RECHARGEABLE BATTERY:

This Spyder X™ uses a Li-Poly rechargeable battery. If battery no longer stays charged, dispose of battery properly according to local disposal requirements.

### CONTROLLER BATTERIES:

Remote control requires 6 "AA" batteries (not included). Please read the important battery safety warning below.

- Do not mix alkaline, standard (carbon-zinc) and rechargeable batteries (Nickel Metal Hydride).
- Do not mix old and new batteries.
- Non-rechargeable batteries are not to be recharged.
- Rechargeable batteries are to be removed from the item before being charged (if removable).
- Rechargeable batteries are only to be charged under adult supervision.
- Exhausted batteries should be removed immediately and must be recycled or disposed of properly according to state or local government ordinances and regulations.
- The supply terminals are not to be short-circuited.
- Only batteries of the same or equivalent type as recommended are to be used.
- Batteries are to be inserted with the correct polarity (see inside booklet for diagram).
- Do not dispose batteries in a fire - batteries may leak or explode.

## CARE AND MAINTENANCE

- Always remove the batteries from the wireless remote control when it is not being used for an extended period of time.
- To clean, gently wipe the remote control and Spyder X™ with a clean damp cloth.
- Keep the toy away from direct heat or sunlight.
- Do not submerge the toy into water. This can damage the unit beyond repair.
- Parental guidance recommended when installing or replacing the batteries.