

Masimo Corporation

Model: RAD7CA

Evaluated to the following SAR Specifications:

FCC 2.1093:2012
Health Safety Code 6:2009

Report No. MASI0103

Report Prepared By



www.nwemc.com
1-888-EMI-CERT

© 2012 Northwest EMC, Inc

SAR Evaluation Report

Certificate of Evaluation

Last Date of Test: May 21, 2012

Masimo Corporation

Model: RAD7CA

Applicable Standards			
Test Description	Specification	Test Method	Pass/Fail
SAR Evaluation	FCC 2.1093:2012 FCC 15.247:2012 FCC 15.407:2012	FCC OET 65C:2001	Pass
		IEEE Std 1528:2003	
		FCC KDB 447498 D01 v04	
		FCC KDB 248227 D01 v01r02	
		FCC KDB 865664	
Health Safety Code 6:2009	RSS-102, Issue 4:2010	Pass	

Highest SAR Values				
Frequency Band (GHz)	Head 1g (W/kg)	Body 1g (W/kg)	Limit 1g (W/kg)	Exposure Environment
2.4	N/A	0.113	1.6	General Population Uncontrolled
5.2 & 5.8	N/A	0.511		

Modifications made to the product
See the Modifications section of this report

Test Facility

The measurement facility used to collect the data is located at:

Northwest EMC, Inc.
22975 NW Evergreen Parkway, Suite 400
Hillsboro, OR 97124

Phone: (503) 844-4066 Fax: 844-3826

Approved By:



Don Facteau, IS Manager



NVLAP Lab Code: 200630-0

This report must not be used to claim product certification, approval, or endorsement by NVLAP, NIST, or any agency of the federal government of the United States of America.

Product compliance is the responsibility of the client, therefore the tests and equipment modes of operation represented in this report were agreed upon by the client, prior to testing. This Report may only be duplicated in its entirety. The results of this test pertain only to the sample(s) tested. The specific description is noted in each of the individual sections of the test report supporting this certificate of test.

Revision Number	Description	Date	Page Number
00			

Barometric Pressure

The recorded barometric pressure has been normalized to sea level.

United States

FCC - Designated by the FCC as a Telecommunications Certification Body (TCB). Certification chambers, Open Area Test Sites, and conducted measurement facilities are listed with the FCC.

A2LA - Accredited by A2LA to ISO / IEC Guide 65 as a product certifier. This allows Northwest EMC to certify transmitters to FCC and IC specifications.

NVLAP - Each laboratory is accredited by NVLAP to ISO 17025. The scope includes radio, ITE, and medical standards from around the world. See: <http://www.nwemc.com/accreditations/>

Canada

IC - Recognized by Industry Canada as a Certification Body (CB). Certification chambers and Open Area Test Sites are filed with IC.

European Union

European Commission – Validated by the European Commission as a Conformity Assessment Body (CAB) under the EMC directive and as a Notified Body under the R&TTE Directive.

Australia/New Zealand

ACMA - Recognized by ACMA as a CAB for the acceptance of test data.

Korea

KCC / RRA - Recognized by KCC's RRA as a CAB for the acceptance of test data.

Japan

VCCI - Associate Member of the VCCI. Conducted and radiated measurement facilities are registered.

Taiwan

BSMI – Recognized by BSMI as a CAB for the acceptance of test data.

NCC - Recognized by NCC as a CAB for the acceptance of test data.

Singapore

IDA – Recognized by IDA as a CAB for the acceptance of test data.

Hong Kong

OFTA – Recognized by OFTA as a CAB for the acceptance of test data.

Vietnam

MIC – Recognized by MIC as a CAB for the acceptance of test data.

Russia

GOST – Accredited by Certinform VNIINMASH, CERTINFO, SAMTES, and Federal CHEC to perform EMC and Hygienic testing for Information Technology products to GOST standards.



Oregon Labs EV01-EV12 22975 NW Evergreen Pkwy, #400 Hillsboro, OR 97124 (503) 844-4066	California Labs OC01-OC13 41 Tesla Irvine, CA 92618 (949) 861-8918	New York Labs WA01-WA04 4939 Jordan Rd. Elbridge, NY 13060 (315) 685-0796	Minnesota Labs MN01-MN08 9349 W Broadway Ave. Brooklyn Park, MN 55445 (763) 425-2281	Washington Labs SU01-SU07 14128 339 th Ave. SE Sultan, WA 98294 (360) 793-8675
VCCI				
C-1071, R-1025, G-84, C-2687, T-1658, R-2318	R-1943, G-85, C-2766, T-1659, G-548		R-3125, G-86, G-141, C-3464, T-1634	R-871, G-83, C-3265, T-1511
Industry Canada				
2834D-1, 2834D-2	2834B-1, 2834B-2, 2834B-3		2834E-1	2834C-1

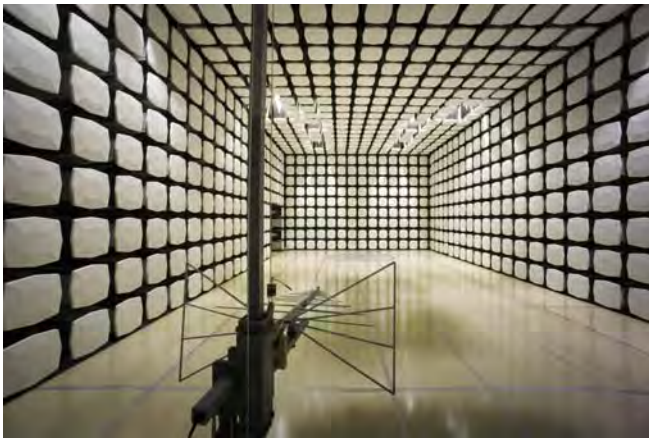

Party Requesting the Test

Company Name:	Masimo Corporation
Address:	40 Parker
City, State, Zip:	Irvine, CA 92618
Test Requested By:	Michael Clark
Model:	RAD7CA
First Date of Test:	May 8, 2012
Last Date of Test:	May 21, 2012
Receipt Date of Samples:	May 8, 2012
Equipment Design Stage:	Production
Equipment Condition:	No Damage

Information Provided by the Party Requesting the Test

Functional Description of the EUT (Equipment Under Test)

The EUT is the Masimo Model RAD7CA Pulse CO-Oximeter containing an 802.11 a/b/g radio. The RAD7CA is a handheld pulse CO-Oximeter with a LCD display. The radio interface allows wireless connection to Patient Safety Net and other wireless systems. The RAD7CA is only used in a clinic or hospital environment. The hardware design limits wireless transmission to patient telemetry data only. No other type of data transmission is possible. Kirby Dotson, Manager Instrument Hardware at Masimo, attests that the maximum duty cycle is about 6%:

“The software sends 120bytes @ 62.5 Hz for 7500 bytes per second or 60K bits/sec. Worst duty cycle will be when in 1.1Mbit/sec mode which is 60K/1.1M for a duty cycle of about 6%.”

The RAD7CA uses two transmitting chip antennas, one each side of the unit. Kirby Dotson of Masimo also attests that the RAD7CA uses “Switched Antenna Diversity” as defined by FCC KDB 248227, Foot note 1 on page 2:

“Switched diversity used in 802.11 a/b/g devices typically allows transmission from one of two antennas in a random manner, according to the received signal quality of each antenna and the diversity algorithm implemented for the specific product.”

The frequency range of the 802.11a/b/g radio in the RAD7CA:

- 2412 – 2462 MHz
- 5180 – 5240 MHz
- 5745 – 5825 MHz

In normal operation, the RAD7CA can be placed in the Masimo Model RDS series docking station. This provides battery charging and wired connection to other devices. In this configuration, it will be used 20cm or greater from the user’s head or torso and can be considered a mobile device. However, when removed from the RDS docking station, it can be used in a stand-alone configuration. Primarily, it will be used as a handheld device, but it is also possible for the RAD7CA to be placed next to the patient’s torso. No body worn accessories are sold or approved by Masimo, so a worst case spacing of 0 cm is used for this SAR evaluation. The RAD7CA does not contain a microphone, nor would it be possible to install VOIP software on the device, so use near the head is not considered.

A patient cable will always be attached during use. A SP02 cable was connected to the RAD7CA during the entire SAR evaluation.

When used in a stand-alone configuration, the RAD7CA is powered by a lithium-ion battery, Model 32794.

Overview of the SAR Evaluation**Objective**

To demonstrate compliance with the SAR requirements of FCC 2.1093 and Canada's Health Safety Code 6. This evaluation will be used to support an original Grant of Certification for FCC ID: VKF-RAD7CA, and IC: 7362A-RAD7CA..

Scope

The SAR evaluation documented in this report is for the Masimo Model RAD7CA, containing an 802.11a/b/g radio.

CONFIGURATION 1 MASI0103

EUT			
Description	Manufacturer	Model/Part Number	Serial Number
Patient Monitor	Masimo Corporation	RAD7CA	E 1208400623
Battery	Masimo Corporation	32794	P1209000073
SPO2 Sensor	Masimo Corporation	None	None

Cables					
Description	Shielded	Ferrite	Length	Connection 1	Connection 2
SPO2 Cable	No	No	3.0m	Patient Monitor	SPO2 Sensor

Equipment modifications					
Item	Date	Test	Modification	Note	Disposition of EUT
1	5/8/2012	SAR Evaluation	Tested as delivered to Test Station.	No EMI suppression devices were added or modified during this test.	EUT remained at Northwest EMC following the test.
2	5/21/2012	SAR Evaluation	Tested as delivered to Test Station.	No EMI suppression devices were added or modified during this test.	Scheduled testing was completed.

2.4 and 5 GHz Bands

Per FCC KDB 248227, the conducted output power was measured at the “default test channels” and at the “required test channels” in each band. Measurements were made while the EUT transmitted at the lowest, middle and the highest data rates for each channel.

Per FCC KDB 248227, among the channels required for normal testing, SAR must be measured on the highest output channel (highlighted). When the SAR measured on the highest output channel is >0.8 W/kg, SAR evaluation for the other required test channels is necessary.

Output power measurements are on the following pages.

EUT: RAD7CA		Work Order: MASI0103
Serial Number: E 1208400623		Date: 05/08/12
Customer: Masimo Corporation		Temperature: 24°
Attendees: None		Humidity: 37%
Project: None		Barometric Pres.: 30.12 in
Tested by: Rod Peloquin	EUT Power	Battery
Job Site: EV06		
TEST SPECIFICATIONS		
FCC 2.1093:2012		Test Method
		FCC OET 65C:2001
COMMENTS		
Conducted output power		
DEVIATIONS FROM TEST STANDARD		
None		
Configuration #	2	<i>Rod Peloquin</i> Signature

Channel	Frequency (MHz)	Data Rate (Mbps)	Modulation	Conducted Power (Average)			
				Antenna Port 1		Antenna Port 2	
				dBm	W	dBm	W
1	2412	1	BPSK	17.4	0.055	17.5	0.057
		11	CCK	17.4	0.055	17.5	0.056
		6	OFDM	16.0	0.040	16.0	0.039
		36	OFDM	15.3	0.033	15.2	0.033
		54	OFDM	14.8	0.030	14.9	0.031
6	2437	1	BPSK	17.7	0.058	17.8	0.060
		11	CCK	17.7	0.058	17.7	0.059
		6	OFDM	16.2	0.042	16.2	0.041
		36	OFDM	15.4	0.035	15.4	0.035
		54	OFDM	15.1	0.033	15.1	0.032
11	2462	1	BPSK	17.8	0.060	17.8	0.060
		11	CCK	17.7	0.059	17.8	0.060
		6	OFDM	16.3	0.043	16.4	0.044
		36	OFDM	15.5	0.036	15.6	0.036
		54	OFDM	15.3	0.033	15.3	0.034

EUT: RAD7CA		Work Order: MASI0103
Serial Number: E 1208400623		Date: 05/08/12
Customer: Masimo Corporation		Temperature: 24°
Attendees: None		Humidity: 37%
Project: None		Barometric Pres.: 30.12 in
Tested by: Rod Peloquin	EUT Power	Battery
Job Site: EV06		
TEST SPECIFICATIONS		
FCC 2.1093:2012		Test Method
		FCC OET 65C:2001
COMMENTS		
Conducted output power		
DEVIATIONS FROM TEST STANDARD		
None		
Configuration #	2	<i>Rod Peloquin</i> Signature

Channel	Frequency (MHz)	Data Rate (Mbps)	Modulation	Conducted Power (Average)			
				Antenna Port 1		Antenna Port 2	
				dBm	W	dBm	W
36	5180	6	OFDM	12.7	0.019	11.9	0.016
		54	OFDM	12.6	0.018	11.9	0.016
40	5200	6	OFDM	12.7	0.019	12.2	0.017
		54	OFDM	12.6	0.018	12.2	0.016
44	5220	6	OFDM	12.6	0.018	12.3	0.017
		54	OFDM	12.6	0.018	12.3	0.017
48	5240	6	OFDM	13.1	0.020	12.7	0.019
		54	OFDM	13.0	0.020	12.7	0.018
149	5745	6	OFDM	7.7	0.006	7.5	0.006
		54	OFDM	7.7	0.006	7.5	0.006
153	5765	6	OFDM	7.1	0.005	7.6	0.006
		54	OFDM	7.1	0.005	7.5	0.006
157	5785	6	OFDM	6.7	0.005	7.7	0.006
		54	OFDM	6.7	0.005	7.6	0.006
161	5805	6	OFDM	6.5	0.004	7.6	0.006
		54	OFDM	6.5	0.004	7.6	0.006
165	5825	6	OFDM	6.5	0.005	7.6	0.006
		54	OFDM	6.6	0.005	7.6	0.006

Characterization of tissue-equivalent liquid dielectric properties

Per IEEE 1528: 2003, Section 5.2.2, the permittivity and conductivity of the tissue material should be measured at least within 24 hours of any full-compliance test. The measured values must be within +/- 5% of the target values. The temperature variation in the liquid during SAR measurements must be within +/- 2 degrees C of that recorded when the dielectric properties were measured.

The dielectric parameters of the tissue-equivalent liquids were measured within 24 hours of testing using the HP85070E dielectric probe kit. The dielectric measurements were made at 50 MHz intervals. The attached data sheets show that the dielectric parameters of the liquid were within the required 5% tolerances.

Target values of dielectric parameters

Per FCC OET 65C, Appendix C:

“The head tissue dielectric parameters recommended by the IEEE SCC-34/SC-2 in P1528 have been incorporated in the following table. These head parameters are derived from planar layer models simulating the highest expected SAR for the dielectric properties and tissue thickness variations in a human head. Other head and body tissue parameters that have not been specified in P1528 are derived from the tissue dielectric parameters computed from the 4-Cole-Cole equations and extrapolated according to the head parameters specified in P1528.”

Target Frequency (MHz)	Head		Body	
	ϵ_r	σ (S/m)	ϵ_r	σ (S/m)
150	52.3	0.76	61.9	0.80
300	45.3	0.87	58.2	0.92
450	43.5	0.87	56.7	0.94
835	41.5	0.90	55.2	0.97
900	41.5	0.97	55.0	1.05
915	41.5	0.98	55.0	1.06
1450	40.5	1.20	54.0	1.30
1610	40.3	1.29	53.8	1.40
1800 – 2000	40.0	1.40	53.3	1.52
2450	39.2	1.80	52.7	1.95
3000	38.5	2.40	52.0	2.73
5800	35.3	5.27	48.2	6.00

(ϵ_r = relative permittivity, σ = conductivity and $\rho = 1000 \text{ kg/m}^3$)

Composition of Ingredients for Liquid Tissue Phantoms

Northwest EMC uses tissue-equivalent liquids prepared by SPEAG and confirmed by them to be within +/- 5% from the target values. Their recipes are based upon the following formulations as found in FCC OET 65C, Appendix C:

“The following tissue formulations are provided for reference only as some of the parameters have not been thoroughly verified. The composition of ingredients may be modified accordingly to achieve the desired target tissue parameters required for routine SAR evaluation.”

Ingredients (% by weight)	Frequency (MHz)									
	450		835		915		1900		2450	
Tissue Type	Head	Body	Head	Body	Head	Body	Head	Body	Head	Body
Water	38.56	51.16	41.45	52.4	41.05	56.0	54.9	40.4	62.7	73.2
Salt (NaCl)	3.95	1.49	1.45	1.4	1.35	0.76	0.18	0.5	0.5	0.04
Sugar	56.32	46.78	56.0	45.0	56.5	41.76	0.0	58.0	0.0	0.0
HEC	0.98	0.52	1.0	1.0	1.0	1.21	0.0	1.0	0.0	0.0
Bactericide	0.19	0.05	0.1	0.1	0.1	0.27	0.0	0.1	0.0	0.0
Triton X-100	0.0	0.0	0.0	0.0	0.0	0.0	0.0	0.0	36.8	0.0
DGBE	0.0	0.0	0.0	0.0	0.0	0.0	44.92	0.0	0.0	26.7
Dielectric Constant	43.42	58.0	42.54	56.1	42.0	56.8	39.9	54.0	39.8	52.5
Conductivity (S/m)	0.85	0.83	0.91	0.95	1.0	1.07	1.42	1.45	1.88	1.78

Salt: 99⁺% Pure Sodium Chloride

Sugar: 98⁺% Pure Sucrose

Water: De-ionized, 16 M Ω ⁺ resistivity

HEC: Hydroxyethyl Cellulose

DGBE: 99⁺% Di(ethylene glycol) butyl ether, [2-(2-butoxyethoxy)ethanol]

Triton X-100 (ultra pure): Polyethylene glycol mono [4-(1,1, 3, 3-tetramethylbutyl)phenyl]ether

EMC**Tissue - Equivalent Liquid**

EUT: MSL2450	Work Order: MASI0103
Serial Number: SAM	Date: 05/08/2012
Customer: Masimo Corporation	Temperature (°C): 24.8
Attendees: None	Humidity: 36.2
Project: None	Barometric Pres. (mb): 1018
Tested by: Ethan Schoonover	Power: None
Job Site: Cal Lab	
TEST SPECIFICATIONS	
FCC 2.1093:2011	Test Method
	FCC OET 65C:2001
COMMENTS	
None	
DEVIATIONS FROM TEST STANDARD	
None	
Configuration #	None
Signature 	
Tissue: MSL2450	
Liquid Temperature (°C): 22.3	

Frequency (GHz)	Actual Values		Target Values		Deviation (%)	
	Relative Permittivity	Conductivity	Relative Permittivity	Conductivity	Relative Permittivity	Conductivity
2450	50.331	2.026	52.700	1.950	4.50	-3.91

1900.0	52.4	1.328
1925.0	52.3	1.357
1950.0	52.2	1.387
1975.0	52.1	1.417
2000.0	52.0	1.450
2025.0	51.9	1.482
2050.0	51.8	1.515
2075.0	51.7	1.546
2100.0	51.6	1.576
2125.0	51.5	1.605
2150.0	51.4	1.635
2175.0	51.3	1.666
2200.0	51.2	1.697
2225.0	51.1	1.729
2250.0	51.1	1.762
2275.0	51.0	1.793
2300.0	50.9	1.825
2325.0	50.8	1.859
2350.0	50.7	1.892
2375.0	50.6	1.925
2400.0	50.5	1.959
2425.0	50.4	1.992
2450.0	50.3	2.026
2475.0	50.2	2.061
2500.0	50.1	2.095
2525.0	50.0	2.131
2550.0	49.9	2.166
2575.0	49.8	2.202
2600.0	49.7	2.237
2625.0	49.6	2.272
2650.0	49.5	2.308
2675.0	49.4	2.344
2700.0	49.3	2.380

EMC**Tissue - Equivalent Liquid**

EUT: MSL501	Work Order: MASI0103
Serial Number: SAV	Date: 05/10/2012
Customer: Masimo Corporation	Temperature (°C): 23.4
Attendees: None	Humidity: 36%
Project: None	Barometric Pres. (mb): 1029
Tested by: Ethan Schoonover	Power: None
	Job Site: Cal Lab
TEST SPECIFICATIONS	
FCC 2.1093:2011	Test Method: FCC OET 65C:2001
COMMENTS	
None	
DEVIATIONS FROM TEST STANDARD	
None	
Configuration #	None
Signature 	
Tissue: MSL501 Liquid Temperature (°C): 22.2	

Frequency (GHz)	Actual Values		Target Values		Deviation (%)	
	Relative Permittivity	Conductivity	Relative Permittivity	Conductivity	Relative Permittivity	Conductivity
5800	46.707	5.856	48.200	6.000	3.10	2.40
3400.0	49.6	2.978				
3500.0	49.5	3.071				
3600.0	49.5	3.169				
3700.0	49.4	3.278				
3800.0	49.2	3.372				
3900.0	49.1	3.465				
4000.0	49.1	3.570				
4100.0	48.9	3.671				
4200.0	48.8	3.785				
4300.0	48.7	3.901				
4400.0	48.7	4.026				
4500.0	48.6	4.142				
4600.0	48.5	4.266				
4700.0	48.3	4.387				
4800.0	48.2	4.517				
4850.0	48.1	4.575				
4900.0	48.1	4.634				
4950.0	48.0	4.690				
5000.0	47.9	4.846				
5050.0	47.9	4.824				
5100.0	47.7	4.970				
5150.0	47.7	4.954				
5200.0	47.6	5.106				
5250.0	47.6	5.086				
5300.0	47.5	5.289				
5350.0	47.4	5.218				
5400.0	47.3	5.374				
5450.0	47.2	5.363				
5500.0	47.2	5.427				
5550.0	47.2	5.495				
5600.0	47.1	5.562				
5650.0	47.0	5.640				
5700.0	46.9	5.705				
5750.0	46.8	5.770				
5800.0	46.7	5.856				
5850.0	46.6	5.932				
5900.0	46.7	6.010				

Requirement

Per IEEE 1528, Section 8.2.1, "System checks are performed prior to compliance tests and the results must always be within $\pm 10\%$ of the target value corresponding to the test frequency, liquid, and the source used. The target values are 1 g or 10 g averaged SAR values measured on systems having current system validation and calibration status, and using the system check setup as shown in Figure 14. These target values should be determined using a standard source."

Test Description

Within 24 hours of a measurement, Northwest EMC used the system validation kit (calibrated reference dipole) to test whether the system was operating within its specifications. The validation was performed in the indicated bands by making SAR measurements of the reference dipole with the phantom filled with the tissue-equivalent liquid. First, a signal generator and power amplifier were used to produce a 100mW level as measured with a power meter at the antenna terminals of the dipole. Then, the reference dipole was positioned below the bottom of the phantom and centered with its axis parallel to the longest side of the phantom. A low loss and low relative permittivity spacer was used to establish the correct distance between the center axis of the reference dipole and the liquid.

For the reference dipoles, the spacing distance s is given by:

$s = 15\text{mm}, \pm 0.2\text{mm}$ for $300\text{MHz} \leq f \leq 1000 \text{ MHz}$:

$s = 10\text{mm}, \pm 0.2\text{mm}$ for $1000\text{MHz} \leq f \leq 6000\text{MHz}$

The measured 1 g and 10 g spatial average SAR values were normalized to a 1W dipole input power for comparison to the calibration data. The results are summarized in the attached table. The deviation is less than 10% in all cases, indicating that the system performance check was within tolerance.

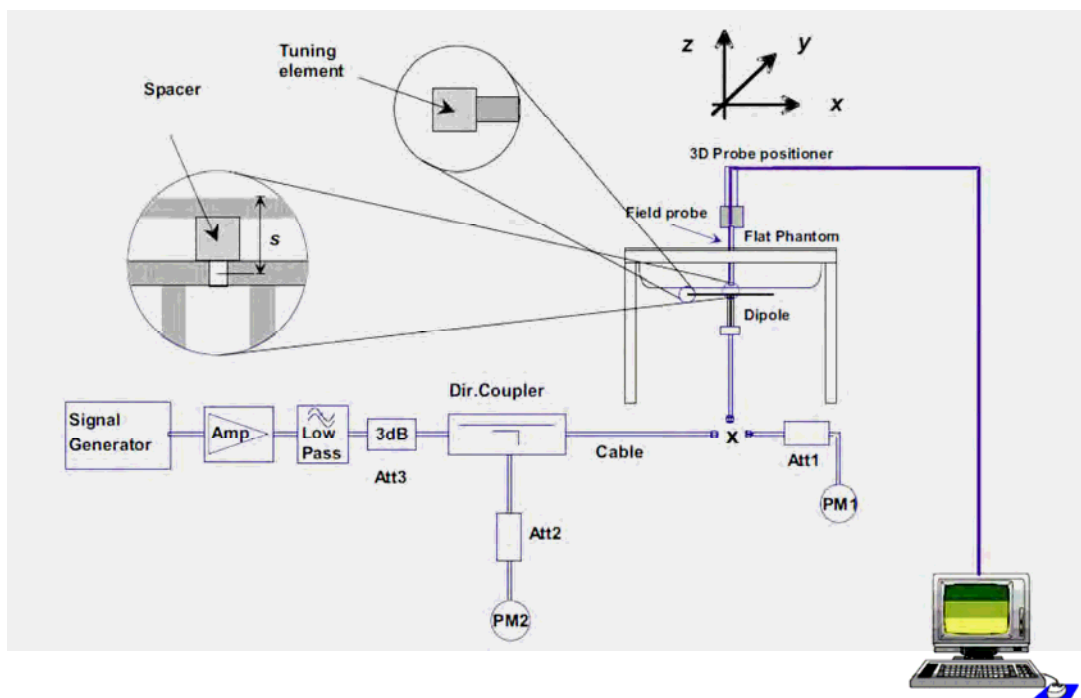

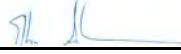
EUT:	System Verifications	Work Order:	MASI0103
Serial Number:	Various	Date:	See Data Sheets
Customer:	Masimo Corporation	Temperature:	See Data Sheets
Attendees:	None	Humidity:	See Data Sheets
Project:	None	Barometric Pres.:	See Data Sheets
Tested by:	Ethan Schoonover	Job Site:	EV08
TEST SPECIFICATIONS		Test Method	
FCC 2.1093:2011		FCC OET 65C:2001	
Health Safety Code 6:2009		IEEE Std 1528:2003	
		RSS-102, Issue 4:2010	
COMMENTS			
None			
DEVIATIONS FROM TEST STANDARD			
No Deviations			
Configuration #	NA	Signature 	

Date	Liquid part number and frequency	Conducted Power into the Dipole (dBm)	Correction Factor	1g Measured	10g Measured	1g Normalized to 1W	10g Normalized to 1W	Target 1g (Normalized to 1W) - Get from Dipole cal cert	Target 10g (Normalized to 1W) - Get from Dipole cal cert	% difference 1g	% difference 10 g	Comments
5/9/2012	MSL2450 2450MHZ	20.00	10.00	5.28	2.43	52.80	24.30	50.40	23.70	4.76	2.53	
5/10/2012	MSL501 5200MHZ	18.44	14.32	5.50	1.58	78.77	22.63	76.50	21.60	2.97	4.76	
5/10/2012	MSL501 5500MHZ	18.40	14.45	5.29	1.50	76.46	21.68	83.30	23.40	-8.21	-7.34	
5/10/2012	MSL501 5800MHZ	16.80	20.89	3.43	0.97	71.66	20.31	78.00	21.90	-8.12	-7.27	

Room Temperature (°C):	23.8	Humidity (%):	36.2	Test Date:	05/09/12
Liquid Temperature (°C):	22.3	Barometric Pressure (mb):	1018	Tested by:	Ethan Schoonover

MSL2450 System Check

DUT: Dipole 2450 MHz D2450V2; Type: D2450V2; Serial: D2450V2 -

Communication System: CW; Communication System Band: D2450 (2450.0 MHz); Frequency: 2450 MHz; Communication System PAR: 0 dB; PMF: 1
 Medium parameters used: $f = 2450$ MHz; $\sigma = 2.026$ mho/m; $\epsilon_r = 50.331$; $\rho = 1000$ kg/m³, Medium parameters used: $\sigma = 0$ mho/m, $\epsilon_r = 1$; $\rho = 1000$ kg/m³
 Phantom section: Flat Section
 Measurement Standard: DASYS5 (IEEE/IEC/ANSI C63.19-2007)

DASY Configuration:

DASY52 52.8.1(838); SEMCAD X 14.6.5(6469)

System Check/System Check/Area Scan (51x61x1): Measurement grid: dx=10mm, dy=10mm

Maximum value of SAR (interpolated) = 5.53 mW/g

System Check/System Check/Z Scan (1x1x21): Measurement grid: dx=20mm, dy=20mm, dz=5mm

Maximum value of Total (measured) = 72.83 V/m

System Check/System Check/Zoom Scan (7x7x7) (7x7x7)/Cube 0: Measurement grid: dx=5mm, dy=5mm, dz=5mm

Reference Value = 50.681 V/m; Power Drift = -0.00 dB

Peak SAR (extrapolated) = 10.892 mW/g

SAR(1 g) = 5.28 mW/g; SAR(10 g) = 2.43 mW/g

Maximum value of SAR (measured) = 5.22 mW/g

Date/Time: 5/9/2012 3:54:09 PM

Test Laboratory: Northwest EMC Inc.

DUT: Dipole 2450 MHz D2450V2; Type: D2450V2; Serial: D2450V2 -

Communication System: CW; Communication System Band: D2450 (2450.0 MHz); Frequency: 2450 MHz; Communication System PAR: 0 dB; PMF: 1
 Medium parameters used: $f = 2450$ MHz; $\sigma = 2.026$ mho/m; $\epsilon_r = 50.331$; $\rho = 1000$ kg/m³
 Phantom section: Flat Section
 Measurement Standard: DASYS5 (IEEE/IEC/ANSI C63.19-2007)

DASY Configuration:

DASY52 52.8.1(838); SEMCAD X 14.6.5(6469)

System Check/System Check/Z Scan (1x1x21): Measurement grid: dx=20mm, dy=20mm, dz=5mm

Maximum value of SAR (measured) = 10.7 mW/g

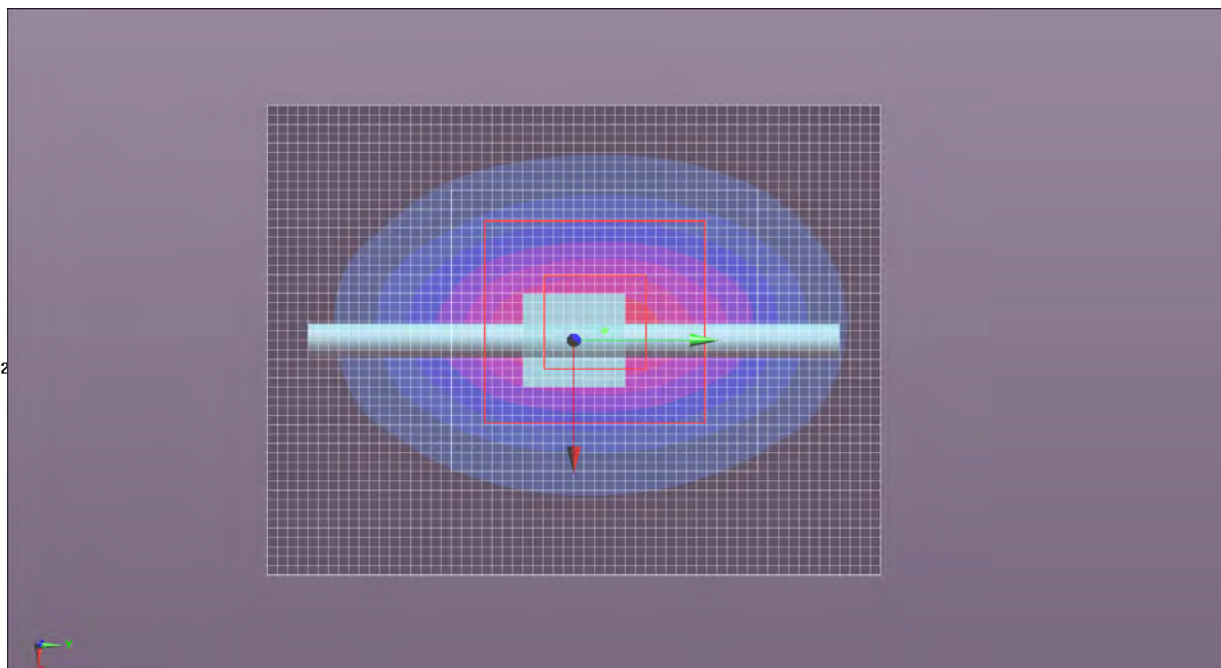
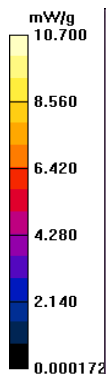

Room Temperature (°C):	23.4	Humidity (%):	36	Test Date:	05/10/12
Liquid Temperature (°C):	22.2	Barometric Pressure (mb):	1029	Tested by:	Ethan Schoonover

MSL5200 System Check

DUT: Dipole D5GHzV2; Type: D5GHzV2; Serial: D5GHzV2 -

Communication System: CW; Communication System Band: D5GHz (5000.0 - 6000.0 MHz); Frequency: 5200 MHz; Communication System PAR: 0 dB; PMF: 1
 Medium parameters used: $f = 5200$ MHz; $\sigma = 5.106$ mho/m; $\epsilon_r = 47.64$; $\rho = 1000$ kg/m³, Medium parameters used: $\sigma = 0$ mho/m, $\epsilon_r = 1$; $\rho = 1000$ kg/m³
 Phantom section: Flat Section
 Measurement Standard: DASYS5 (IEEE/IEC/ANSI C63.19-2007)

DASY Configuration:

DASY52 52.8.1(838); SEMCAD X 14.6.5(6469)

System Check/System Check - Low Channel/Zoom Scan (7x9x7) (8x8x9)/Cube 0: Measurement grid: dx=4mm, dy=4mm, dz=2.5mm

Reference Value = 49.026 V/m; Power Drift = 0.07 dB

Peak SAR (extrapolated) = 20.445 mW/g

SAR(1 g) = 5.5 mW/g; SAR(10 g) = 1.58 mW/g

Maximum value of SAR (measured) = 11.5 mW/g

System Check/System Check - Low Channel/Area Scan (51x61x1): Measurement grid: dx=10mm, dy=10mm

Maximum value of SAR (interpolated) = 11.8 mW/g

System Check/System Check - Low Channel/Z Scan (1x1x21): Measurement grid: dx=20mm, dy=20mm, dz=5mm

Maximum value of Total (measured) = 49.43 V/m

Date/Time: 5/10/2012 10:15:29 AM

Test Laboratory: Northwest EMC Inc.

DUT: Dipole D5GHzV2; Type: D5GHzV2; Serial: D5GHzV2 -

Communication System: CW; Communication System Band: D5GHz (5000.0 - 6000.0 MHz); Frequency: 5200 MHz; Communication System PAR: 0 dB; PMF: 1
 Medium parameters used: $f = 5200$ MHz; $\sigma = 5.106$ mho/m; $\epsilon_r = 47.64$; $\rho = 1000$ kg/m³
 Phantom section: Flat Section
 Measurement Standard: DASYS5 (IEEE/IEC/ANSI C63.19-2007)

DASY Configuration:

DASY52 52.8.1(838); SEMCAD X 14.6.5(6469)

System Check/System Check - Low Channel/Z Scan (1x1x21): Measurement grid: dx=20mm, dy=20mm, dz=5mm

Maximum value of SAR (measured) = 12.5 mW/g

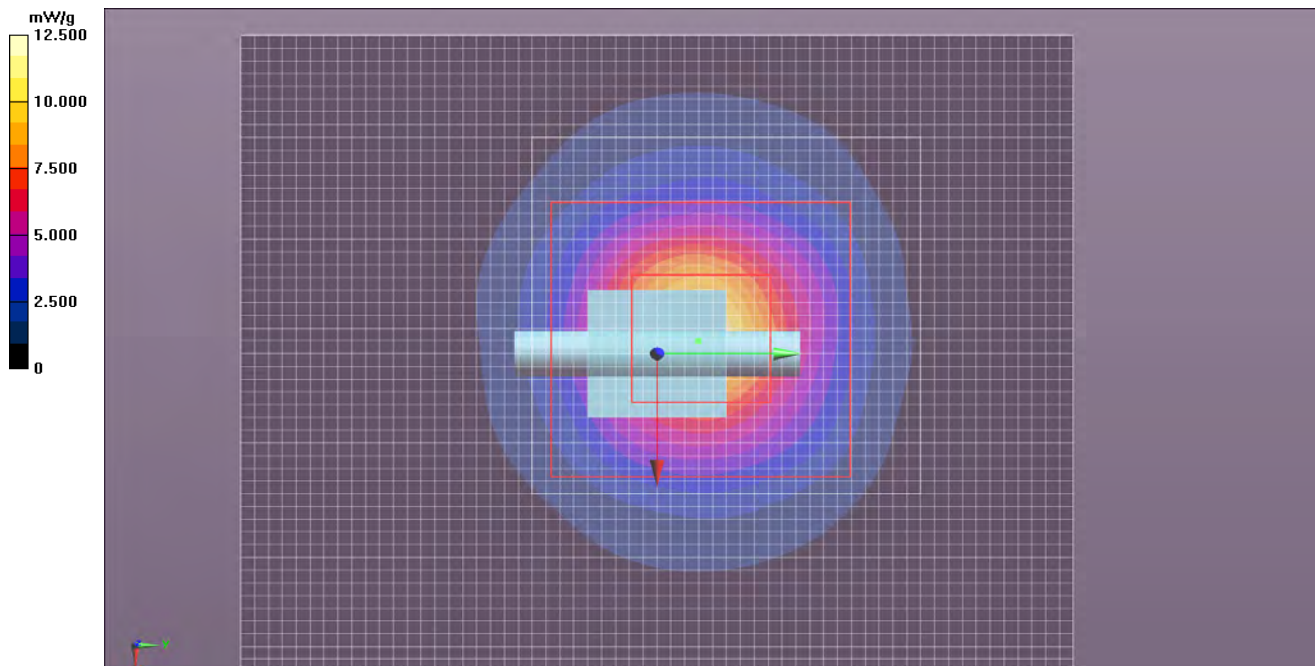

Room Temperature (°C):	23.4	Humidity (%):	36	Test Date:	05/10/12
Liquid Temperature (°C):	22.2	Barometric Pressure (mb):	1029	Tested by:	Ethan Schoonover

MSL5500 System Check

DUT: Dipole D5GHzV2; Type: D5GHzV2; Serial: D5GHzV2 -

Communication System: CW; Communication System Band: D5GHz (5000.0 - 6000.0 MHz); Frequency: 5500 MHz; Communication System PAR: 0 dB; PMF: 1
 Medium parameters used: $f = 5500$ MHz; $\sigma = 5.427$ mho/m; $\epsilon_r = 47.237$; $\rho = 1000$ kg/m³, Medium parameters used: $\sigma = 0$ mho/m, $\epsilon_r = 1$; $\rho = 1000$ kg/m³
 Phantom section: Flat Section
 Measurement Standard: DASYS5 (IEEE/IEC/ANSI C63.19-2007)

DASY Configuration:

DASY52 52.8.1(838); SEMCAD X 14.6.5(6469)

System Check/System Check - Mid Channel/Area Scan (51x61x1): Measurement grid: dx=10mm, dy=10mm

Maximum value of SAR (interpolated) = 11.9 mW/g

System Check/System Check - Mid Channel/Zoom Scan (7x9x7) (8x8x9)/Cube 0: Measurement grid: dx=4mm, dy=4mm, dz=2.5mm

Reference Value = 47.249 V/m; Power Drift = 0.11 dB

Peak SAR (extrapolated) = 20.312 mW/g

SAR(1 g) = 5.29 mW/g; SAR(10 g) = 1.5 mW/g

Maximum value of SAR (measured) = 11.2 mW/g

System Check/System Check - Mid Channel/Z Scan (1x1x21): Measurement grid: dx=20mm, dy=20mm, dz=5mm

Maximum value of Total (measured) = 47.87 V/m

Date/Time: 5/10/2012 11:22:23 AM

Test Laboratory: Northwest EMC Inc.

DUT: Dipole D5GHzV2; Type: D5GHzV2; Serial: D5GHzV2 -

Communication System: CW; Communication System Band: D5GHz (5000.0 - 6000.0 MHz); Frequency: 5800 MHz; Communication System PAR: 0 dB; PMF: 1
 Medium parameters used: $f = 5800$ MHz; $\sigma = 5.856$ mho/m; $\epsilon_r = 46.707$; $\rho = 1000$ kg/m³
 Phantom section: Flat Section
 Measurement Standard: DASYS5 (IEEE/IEC/ANSI C63.19-2007)

DASY Configuration:

DASY52 52.8.1(838); SEMCAD X 14.6.5(6469)

System Check/System Check - High Channel/Z Scan (1x1x21): Measurement grid: dx=20mm, dy=20mm, dz=5mm

Maximum value of SAR (measured) = 5.50 mW/g

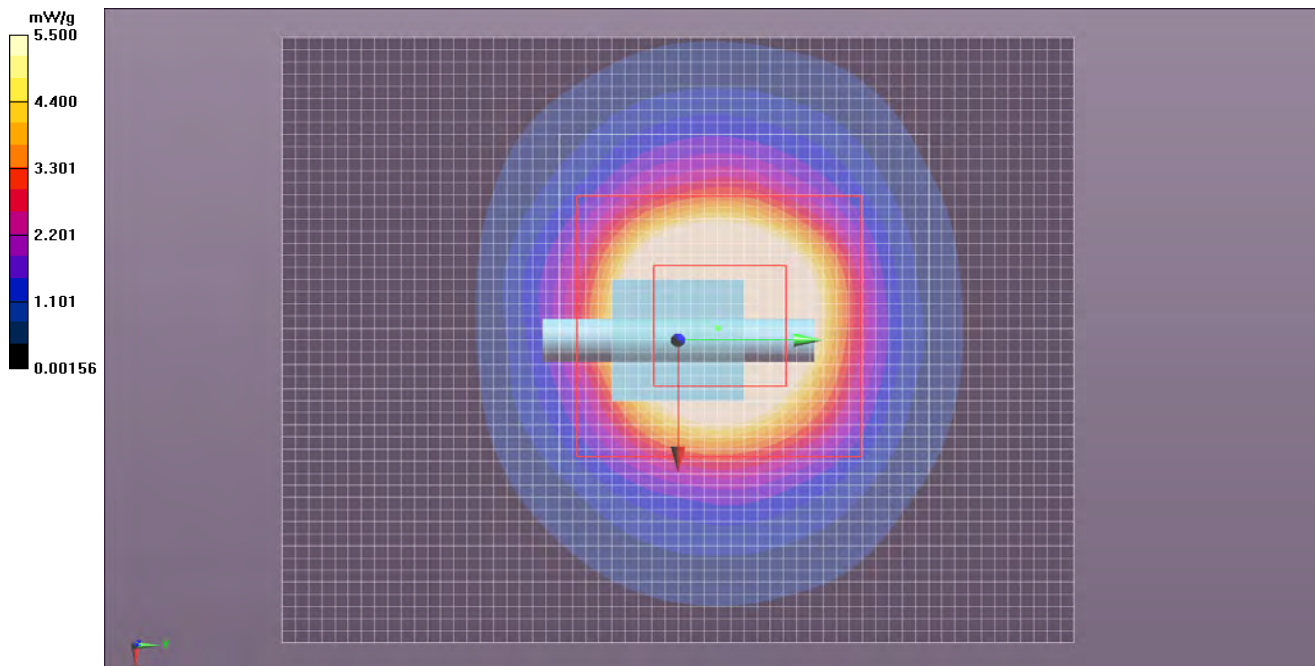

Room Temperature (°C):	23.4	Humidity (%):	36	Test Date:	05/10/12
Liquid Temperature (°C):	22.2	Barometric Pressure (mb):	1029	Tested by:	Ethan Schoonover

MSL5800 System Check

DUT: Dipole D5GHzV2; Type: D5GHzV2; Serial: D5GHzV2 -

Communication System: CW; Communication System Band: D5GHz (5000.0 - 6000.0 MHz); Frequency: 5800 MHz; Communication System PAR: 0 dB; PMF: 1
 Medium parameters used: $f = 5800$ MHz; $\sigma = 5.856$ mho/m; $\epsilon_r = 46.707$; $\rho = 1000$ kg/m³, Medium parameters used: $\sigma = 0$ mho/m, $\epsilon_r = 1$; $\rho = 1000$ kg/m³
 Phantom section: Flat Section
 Measurement Standard: DASYS5 (IEEE/IEC/ANSI C63.19-2007)

DASY Configuration:

DASY52 52.8.1(838); SEMCAD X 14.6.5(6469)

System Check/System Check - High Channel/Area Scan (51x61x1): Measurement grid: dx=10mm, dy=10mm
 Maximum value of SAR (interpolated) = 7.65 mW/g

System Check/System Check - High Channel/Z Scan (1x1x21): Measurement grid: dx=20mm, dy=20mm, dz=5mm
 Maximum value of Total (measured) = 30.65 V/m

System Check/System Check - High Channel/Zoom Scan (7x9x7) (9x9x9)/Cube 0: Measurement grid: dx=4mm, dy=4mm, dz=2.5mm
 Reference Value = 30.270 V/m; Power Drift = 0.11 dB
 Peak SAR (extrapolated) = 13.530 mW/g
SAR(1 g) = 3.43 mW/g; SAR(10 g) = 0.972 mW/g
 Maximum value of SAR (measured) = 7.34 mW/g

Date/Time: 5/10/2012 11:22:23 AM

Test Laboratory: Northwest EMC Inc.

DUT: Dipole D5GHzV2; Type: D5GHzV2; Serial: D5GHzV2 -

Communication System: CW; Communication System Band: D5GHz (5000.0 - 6000.0 MHz); Frequency: 5800 MHz; Communication System PAR: 0 dB; PMF: 1
 Medium parameters used: $f = 5800$ MHz; $\sigma = 5.856$ mho/m; $\epsilon_r = 46.707$; $\rho = 1000$ kg/m³
 Phantom section: Flat Section
 Measurement Standard: DASYS5 (IEEE/IEC/ANSI C63.19-2007)

DASY Configuration:

DASY52 52.8.1(838); SEMCAD X 14.6.5(6469)

System Check/System Check - High Channel/Z Scan (1x1x21): Measurement grid: dx=20mm, dy=20mm, dz=5mm
 Maximum value of SAR (measured) = 5.50 mW/g

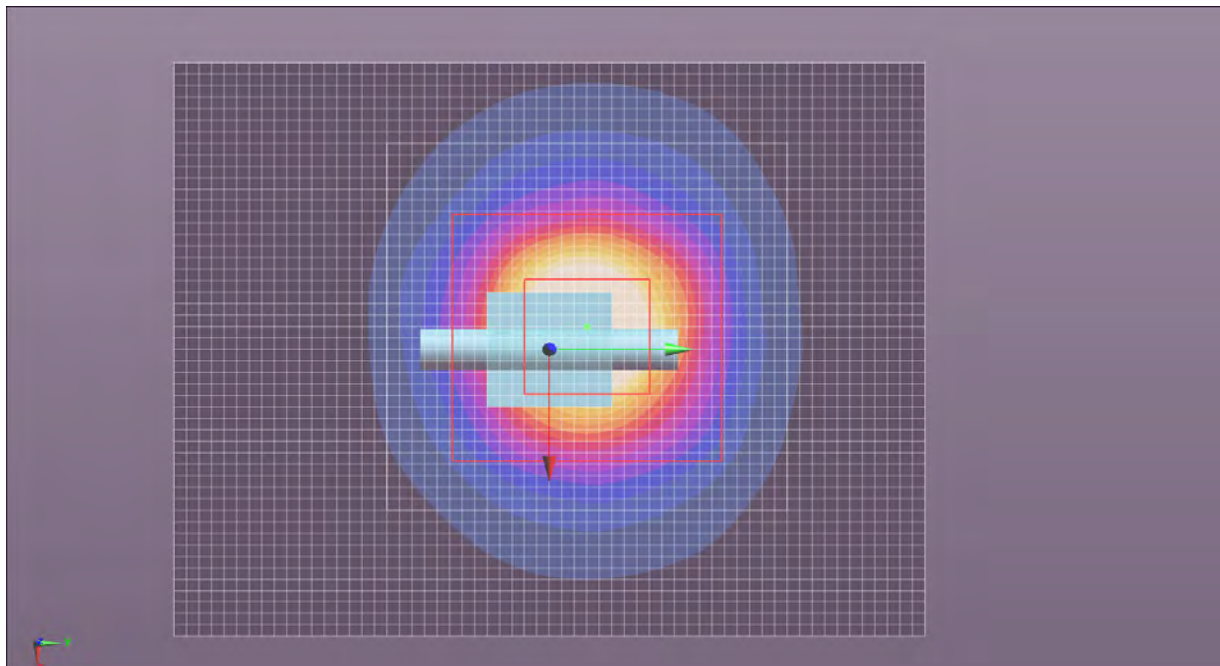
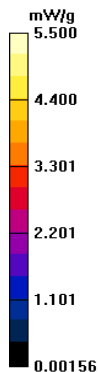

Test Configurations

In normal operation, the RAD7CA can be placed in the Masimo Model RDS series docking station. This provides battery charging and wired connection to other devices. In this configuration, it will be used 20cm or greater from the user's head or torso and can be considered a mobile device. However, when removed from the RDS docking station, it can be used in a stand-alone configuration. Primarily, it will be used as a handheld device, but it is also possible for the RAD7CA to be placed next to the patient's torso. No body worn accessories are sold or approved by Masimo, so a worst case spacing of 0 cm is used for this SAR evaluation. The RAD7CA does not contain a microphone, nor would it be possible to install VOIP software on the device, so use near the head is not considered.

A patient cable will always be attached during use. A SP02 cable was connected to the RAD7CA during the entire SAR evaluation.

When used in a stand-alone configuration, the RAD7CA is powered by a lithium-ion battery, Model 32794.

Switched Diversity

The RAD7CA uses two transmitting chip antennas, one on each side of the unit. Kirby Dotson of Masimo also attests that the RAD7CA uses "Switched Antenna Diversity" as defined by FCC KDB 248227, Foot note 1 on page 2:

"Switched diversity used in 802.11 a/b/g devices typically allows transmission from one of two antennas in a random manner, according to the received signal quality of each antenna and the diversity algorithm implemented for the specific product."

Per KDB 248227, each transmitting antenna was tested independently, one at a time, on all the required test channels. The measured SAR for each diversity antenna was scaled to a duty factor of 75%. Both measured and scaled SAR values are included in the test results.

Duty Factor

All testing was performed with the EUT configured in a worst-case configuration and operating mode to produce the highest SAR levels. The EUT used Masimo test software that permitted the selection of transmit channel, modulation type, and data rate. It operated continuously at nearly 100% duty cycle.

In normal operation, the radio interface allows wireless connection to Patient Safety Net and other wireless systems. The RAD7CA is only used in a clinic or hospital environment. The hardware design limits wireless transmission to patient telemetry data only. No other type of data transmission is possible. Kirby Dotson, Manager Instrument Hardware at Masimo, attests that the maximum duty cycle is about 6%:

"The software sends 120bytes @ 62.5 Hz for 7500 bytes per second or 60K bits/sec. Worst duty cycle will be when in 1.1Mbit/sec mode which is 60K/1.1M for a duty cycle of about 6%."

Per KDB 248227, duty factor scaling was applied to data in the 2.4 GHz band after SAR linearity was confirmed. SAR was measured at approximately 100%, 50% and 30% duty factor in the high SAR region in the 2.4 GHz band. A scaling factor of 0.07 was applied to the SAR values

measured at a 100% duty factor. Both measured and scaled SAR values are included in the test results.

Summary

The following tables summarize the measured SAR values.

Per FCC KDB 248227, among the channels required for normal testing, SAR must be measured on the channel with the highest conducted output power. When the SAR measured on the highest output channel is >0.8 W/kg, SAR evaluation for the other required test channels is necessary.

SAR TEST DATA

EUT: RAD7CA	Work Order: MASI0103
Serial Number: E 1208400623	Date: See Data Sheets
Customer: Masimo Corporation	Temperature: See Data Sheets
Attendees: None	Humidity: See Data Sheets
Project: None	Barometric Pres.: See Data Sheets
Tested by: Ethan Schoonover	Job Site: EV08
TEST SPECIFICATIONS	
Test Method	
FCC 2.1093:2011	FCC OET 65C:2001
FCC 15.247:2011	IEEE Std 1528:2003
FCC 15.407:2001	FCC KDB 447498 D01 v04
Health Safety Code 6:2009	FCC KDB 248227 D01 V01r02
	FCC KDB 865664
	RSS-102, Issue 4:2010
COMMENTS	
No body worn holsters, pouches, or lanyards. Tested at 0cm spacing, 100% duty cycle	
DEVIATIONS FROM TEST STANDARD	
No Deviations	
Configuration #	1
	Signature 

Test Configuration	Frequency Band	Transmit Frequency (MHz)	Transmit Channel	Data Rate (Mbps)	Transmit Mode	Body-Worn Accessory	Accessory	EUT Position	Power Drift During Test (dB)	Measured 1g SAR Level (mW/g)	Test #
Body - Antenna 1	5200	5240	48	6	OFDM	None	Patient Leads	Left	-0.06	0.511	9
	5200	5240	48	6	OFDM	None	Patient Leads	Back	0.06	0.369	10
	5200	5240	48	6	OFDM	None	Patient Leads	Right	Note 2	Note 1	11
	5200	5240	48	6	OFDM	None	Patient Leads	Front	Note 2	Note 1	12
Body - Antenna 2	5200	5240	48	6	OFDM	None	Patient Leads	Left	Note 2	Note 1	13
	5200	5240	48	6	OFDM	None	Patient Leads	Back	0	0.245	14
	5200	5240	48	6	OFDM	None	Patient Leads	Right	0	0.372	15
	5200	5240	48	6	OFDM	None	Patient Leads	Front	Note 2	Note 1	16
Body - Antenna 1	5800	5745	149	6	OFDM	None	Patient Leads	Left	0.14	0.414	17
	5800	5745	149	6	OFDM	None	Patient Leads	Back	0.01	0.3	18
	5800	5745	149	6	OFDM	None	Patient Leads	Right	Note 2	Note 1	19
	5800	5745	149	6	OFDM	None	Patient Leads	Front	Note 2	Note 1	20
Body - Antenna 2	5800	5785	157	6	OFDM	None	Patient Leads	Left	Note 2	Note 1	21
	5800	5785	157	6	OFDM	None	Patient Leads	Back	0.07	0.183	22
	5800	5785	157	6	OFDM	None	Patient Leads	Right	-0.01	0.301	23
	5800	5785	157	6	OFDM	None	Patient Leads	Front	Note 2	Note 1	24

Note 1: Zoom scan measurement was not performed because the area scan results were less than 0.04 mW/g

Note 2: Power drift measurement was not performed because the area scan results were less than 0.04 mW/g

Room Temperature (°C):	26	Humidity (%):	28.3	Test Date:	05/10/12
Liquid Temperature (°C):	22.9	Barometric Pressure (mb):	1029	Tested by:	Ethan Schoonover

5G Body Test 9

DUT: Patient Monitor; Type: RAD7CA; Serial: E 1208400623

Communication System: CW; Communication System Band: D5GHz (5000.0 - 6000.0 MHz); Frequency: 5240 MHz; Communication System PAR: 0 dB; PMF: 1
 Medium parameters used (interpolated): $f = 5240$ MHz; $\sigma = 5.09$ mho/m; $\epsilon_r = 47.594$; $\rho = 1000$ kg/m³, Medium parameters used: $\sigma = 0$ mho/m, $\epsilon_r = 1$; $\rho = 1000$ kg/m³
 Phantom section: Flat Section
 Measurement Standard: DASYS (IEEE/IEC/ANSI C63.19-2007)

DASY Configuration:

DASY52 52.8.1(838); SEMCAD X 14.6.5(6469)

Body/Body/Reference scan (41x91x1): Measurement grid: dx=30mm, dy=30mm

[Info: Interpolated medium parameters used for SAR evaluation.](#)

Maximum value of SAR (interpolated) = 0.804 mW/g

Body/Body/Area scan (81x81x1): Measurement grid: dx=10mm, dy=10mm

[Info: Interpolated medium parameters used for SAR evaluation.](#)

Maximum value of SAR (interpolated) = 0.919 mW/g

Body/Body/Zoom Scan (9x9x9)/Cube 0: Measurement grid: dx=4mm, dy=4mm, dz=2.5mm

Reference Value = 14.579 V/m; Power Drift = -0.06 dB

Peak SAR (extrapolated) = 1.817 mW/g

SAR(1 g) = 0.511 mW/g; SAR(10 g) = 0.165 mW/g

[Info: Interpolated medium parameters used for SAR evaluation.](#)

Maximum value of SAR (measured) = 1.00 mW/g

Body/Body/Z Scan (1x1x21): Measurement grid: dx=20mm, dy=20mm, dz=5mm

[Info: Interpolated medium parameters used for SAR evaluation.](#)

Maximum value of Total (measured) = 6.808 V/m

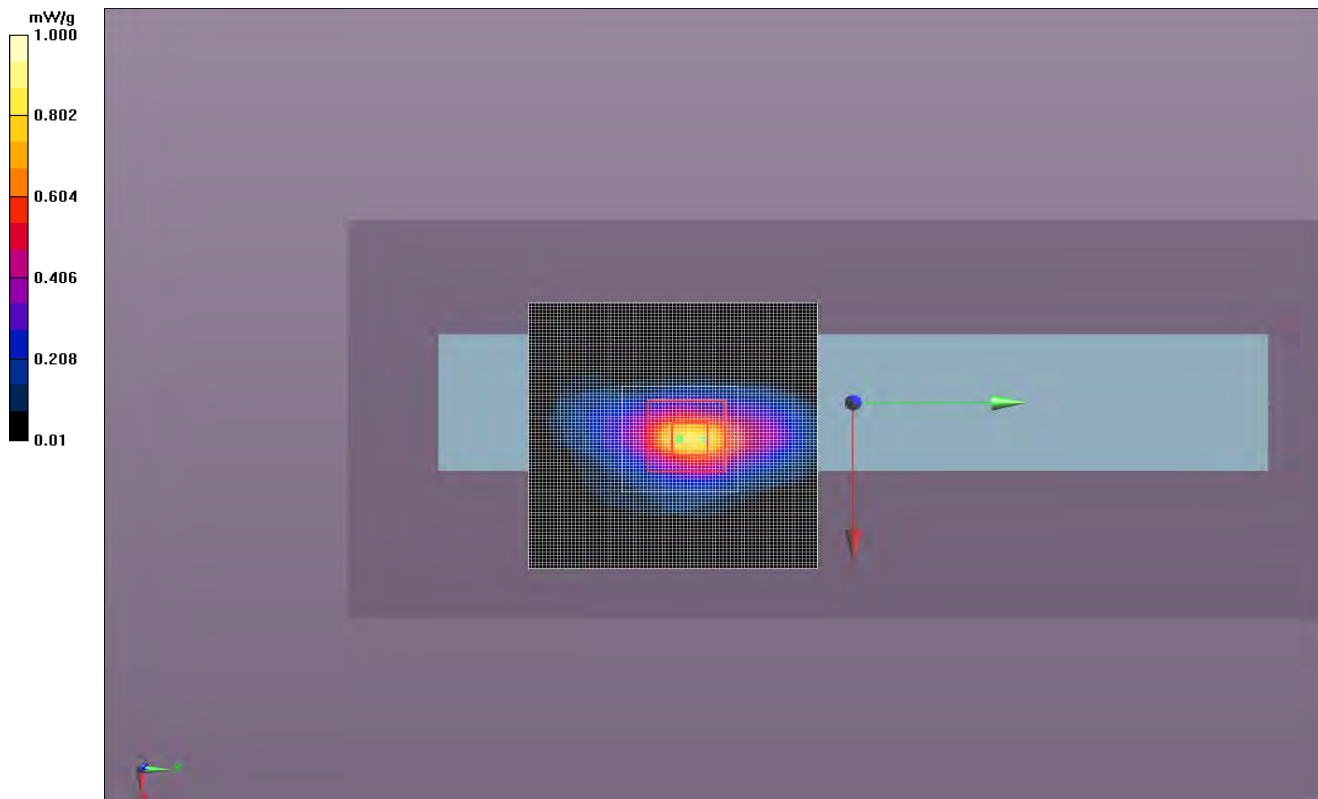

Room Temperature (°C):	23.7	Humidity (%):	30.6	Test Date:	05/10/12
Liquid Temperature (°C):	22.6	Barometric Pressure (mb):	1029	Tested by:	Ethan Schoonover

5G Body Test 10

DUT: Patient Monitor; Type: RAD7CA; Serial: E 1208400623

Communication System: CW; Communication System Band: D5GHz (5000.0 - 6000.0 MHz); Frequency: 5240 MHz; Communication System PAR: 0 dB; PMF: 1
 Medium parameters used (interpolated): $f = 5240$ MHz; $\sigma = 5.09$ mho/m; $\epsilon_r = 47.594$; $\rho = 1000$ kg/m³, Medium parameters used: $\sigma = 0$ mho/m, $\epsilon_r = 1$; $\rho = 1000$ kg/m³
 Phantom section: Flat Section
 Measurement Standard: DASYS (IEEE/IEC/ANSI C63.19-2007)

DASY Configuration:

DASY52 52.8.1(838); SEMCAD X 14.6.5(6469)

Body/Body/Reference scan (41x91x1): Measurement grid: dx=30mm, dy=30mm

[Info: Interpolated medium parameters used for SAR evaluation.](#)

Maximum value of SAR (interpolated) = 0.407 mW/g

Body/Body/Area scan (81x81x1): Measurement grid: dx=10mm, dy=10mm

[Info: Interpolated medium parameters used for SAR evaluation.](#)

Maximum value of SAR (interpolated) = 0.667 mW/g

Body/Body/Zoom Scan (10x10x9)/Cube 0: Measurement grid: dx=4mm, dy=4mm, dz=2.5mm

Reference Value = 12.181 V/m; Power Drift = 0.06 dB

Peak SAR (extrapolated) = 1.122 mW/g

SAR(1 g) = 0.369 mW/g; SAR(10 g) = 0.154 mW/g

[Info: Interpolated medium parameters used for SAR evaluation.](#)

Maximum value of SAR (measured) = 0.686 mW/g

Body/Body/Z Scan (1x1x21): Measurement grid: dx=20mm, dy=20mm, dz=5mm

[Info: Interpolated medium parameters used for SAR evaluation.](#)

Maximum value of Total (measured) = 5.530 V/m

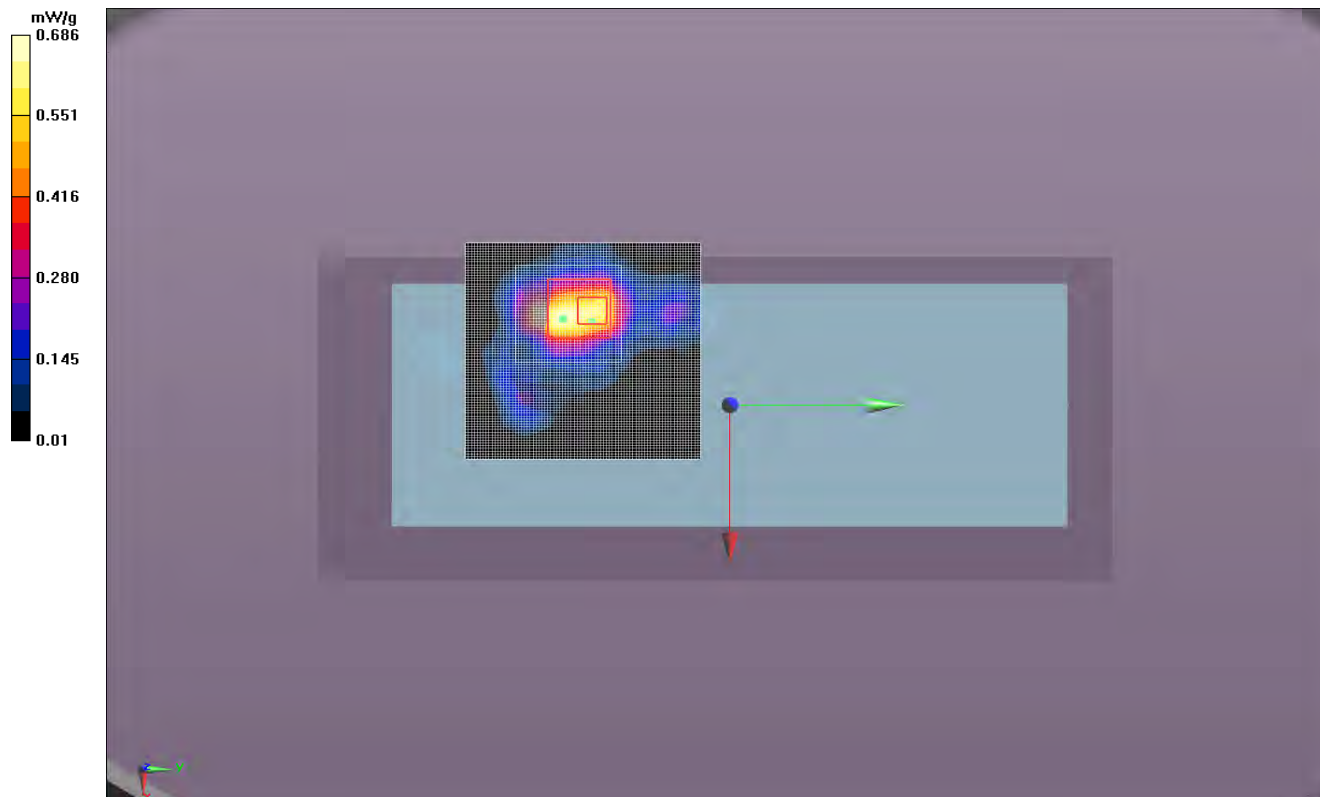

EMC

SAR TEST DATA

Room Temperature (°C):	23.1	Humidity (%):	34.6	Test Date:	05/10/12
Liquid Temperature (°C):	22.8	Barometric Pressure (mb):	1029	Tested by:	Ethan Schoonover

5G Body Test 11

DUT: Patient Monitor; Type: RAD7CA; Serial: E 1208400623

Communication System: CW; Communication System Band: D5GHz (5000.0 - 6000.0 MHz); Frequency: 5240 MHz; Communication System PAR: 0 dB; PMF: 1
 Medium parameters used (interpolated): $f = 5240$ MHz; $\sigma = 5.09$ mho/m; $\epsilon_r = 47.594$; $\rho = 1000$ kg/m³, Medium parameters used: $\sigma = 0$ mho/m, $\epsilon_r = 1$; $\rho = 1000$ kg/m³
 Phantom section: Flat Section
 Measurement Standard: DASYS (IEEE/IEC/ANSI C63.19-2007)

DASY Configuration:

DASY52 52.8.1(838); SEMCAD X 14.6.5(6469)

Body/Body/Reference scan (41x91x1): Measurement grid: dx=30mm, dy=30mm

[Info: Interpolated medium parameters used for SAR evaluation.](#)

Maximum value of SAR (interpolated) = 0.0130 mW/g

Body/Body/Area scan (81x81x1): Measurement grid: dx=10mm, dy=10mm

[Info: Interpolated medium parameters used for SAR evaluation.](#)

Maximum value of SAR (interpolated) = 0.0160 mW/g

Body/Body/Z Scan (1x1x21): Measurement grid: dx=20mm, dy=20mm, dz=5mm

[Info: Interpolated medium parameters used for SAR evaluation.](#)

Maximum value of Total (measured) = 00 V/m

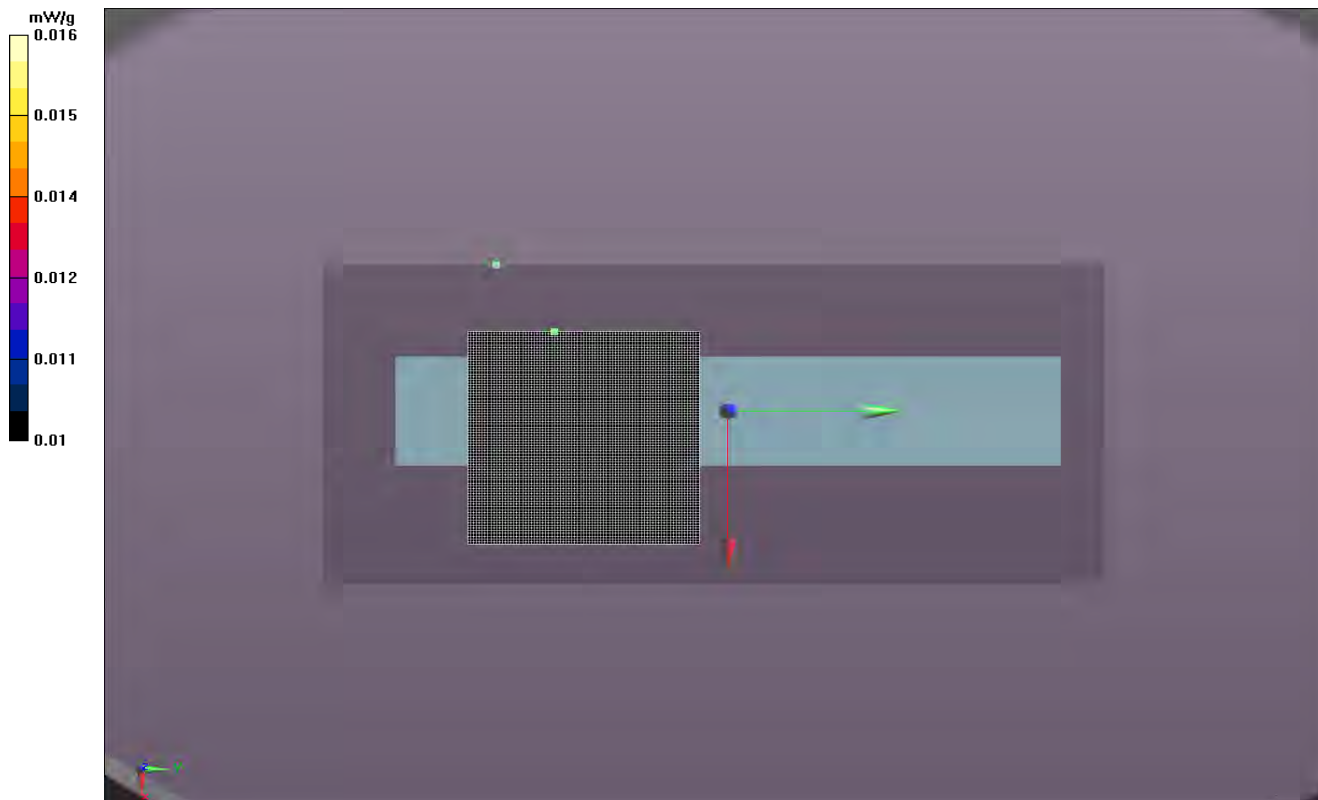

EMC

SAR TEST DATA

Room Temperature (°C):	22.8	Humidity (%):	34.9	Test Date:	05/10/12
Liquid Temperature (°C):	22.7	Barometric Pressure (mb):	1029	Tested by:	Ethan Schoonover

5G Body Test 12

DUT: Patient Monitor; Type: RAD7CA; Serial: E 1208400623

Communication System: CW; Communication System Band: D5GHz (5000.0 - 6000.0 MHz); Frequency: 5240 MHz; Communication System PAR: 0 dB; PMF: 1
 Medium parameters used (interpolated): $f = 5240$ MHz; $\sigma = 5.09$ mho/m; $\epsilon_r = 47.594$; $\rho = 1000$ kg/m³, Medium parameters used: $\sigma = 0$ mho/m, $\epsilon_r = 1$; $\rho = 1000$ kg/m³
 Phantom section: Flat Section
 Measurement Standard: DASYS (IEEE/IEC/ANSI C63.19-2007)

DASY Configuration:

DASY52 52.8.1(838); SEMCAD X 14.6.5(6469)

Body/Body/Reference scan (41x91x1): Measurement grid: dx=30mm, dy=30mm

[Info: Interpolated medium parameters used for SAR evaluation.](#)

Maximum value of SAR (interpolated) = 00 mW/g

Body/Body/Area scan (81x81x1): Measurement grid: dx=10mm, dy=10mm

[Info: Interpolated medium parameters used for SAR evaluation.](#)

Maximum value of SAR (interpolated) = 0.00624 mW/g

Body/Body/Z Scan (1x1x21): Measurement grid: dx=20mm, dy=20mm, dz=5mm

[Info: Interpolated medium parameters used for SAR evaluation.](#)

Maximum value of Total (measured) = 00 V/m

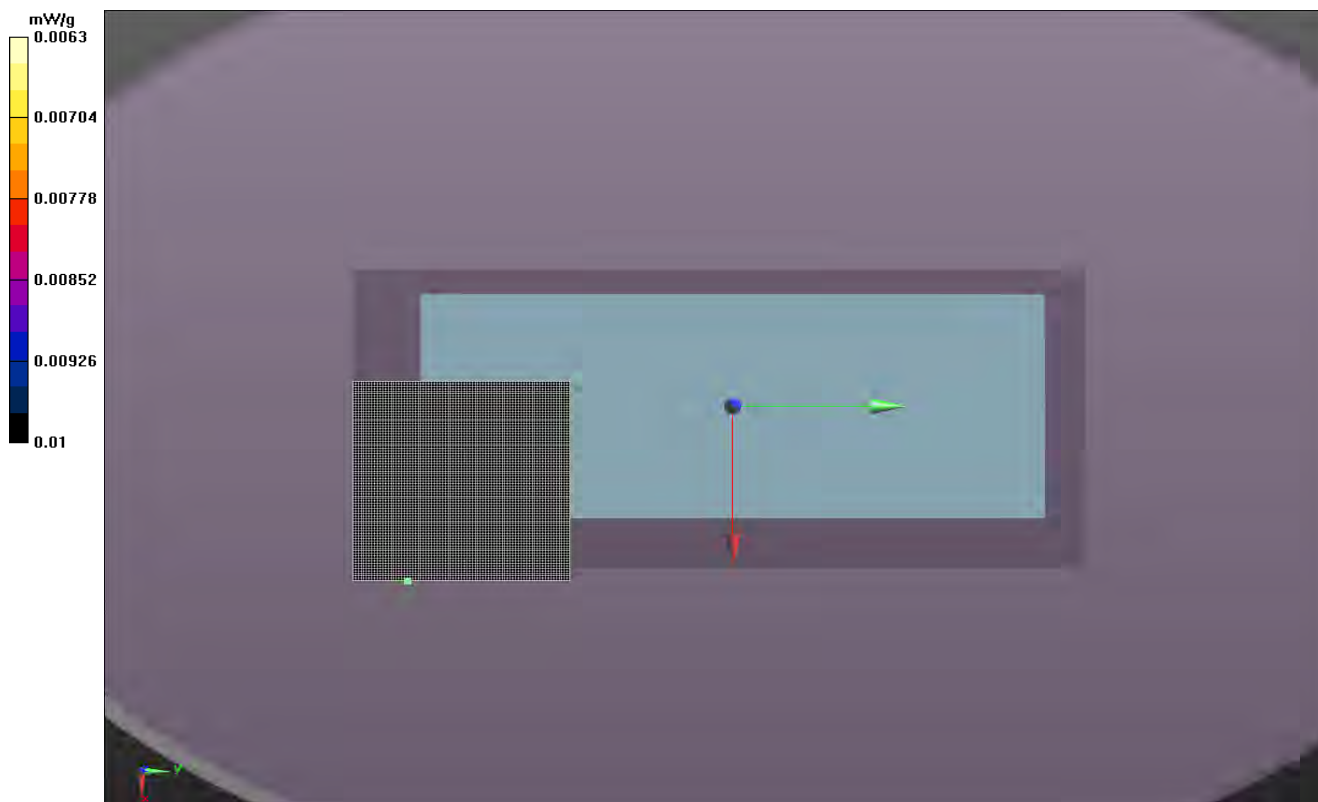

Room Temperature (°C):	21.7	Humidity (%):	34.7	Test Date:	05/10/12
Liquid Temperature (°C):	22.5	Barometric Pressure (mb):	1029	Tested by:	Ethan Schoonover

5G Body Test 13

DUT: Patient Monitor; Type: RAD7CA; Serial: E 1208400623

Communication System: CW; Communication System Band: D5GHz (5000.0 - 6000.0 MHz); Frequency: 5240 MHz; Communication System PAR: 0 dB; PMF: 1
 Medium parameters used (interpolated): $f = 5240$ MHz; $\sigma = 5.09$ mho/m; $\epsilon_r = 47.594$; $\rho = 1000$ kg/m³, Medium parameters used: $\sigma = 0$ mho/m, $\epsilon_r = 1$; $\rho = 1000$ kg/m³
 Phantom section: Flat Section
 Measurement Standard: DASYS (IEEE/IEC/ANSI C63.19-2007)

DASY Configuration:

DASY52 52.8.1(838); SEMCAD X 14.6.5(6469)

Body/Body/Reference scan (41x91x1): Measurement grid: dx=30mm, dy=30mm

[Info: Interpolated medium parameters used for SAR evaluation.](#)

Maximum value of SAR (interpolated) = 00 mW/g

Body/Body/Area scan (81x81x1): Measurement grid: dx=10mm, dy=10mm

[Info: Interpolated medium parameters used for SAR evaluation.](#)

Maximum value of SAR (interpolated) = 0.0159 mW/g

Body/Body/Z Scan (1x1x21): Measurement grid: dx=20mm, dy=20mm, dz=5mm

[Info: Interpolated medium parameters used for SAR evaluation.](#)

Maximum value of Total (measured) = 00 V/m

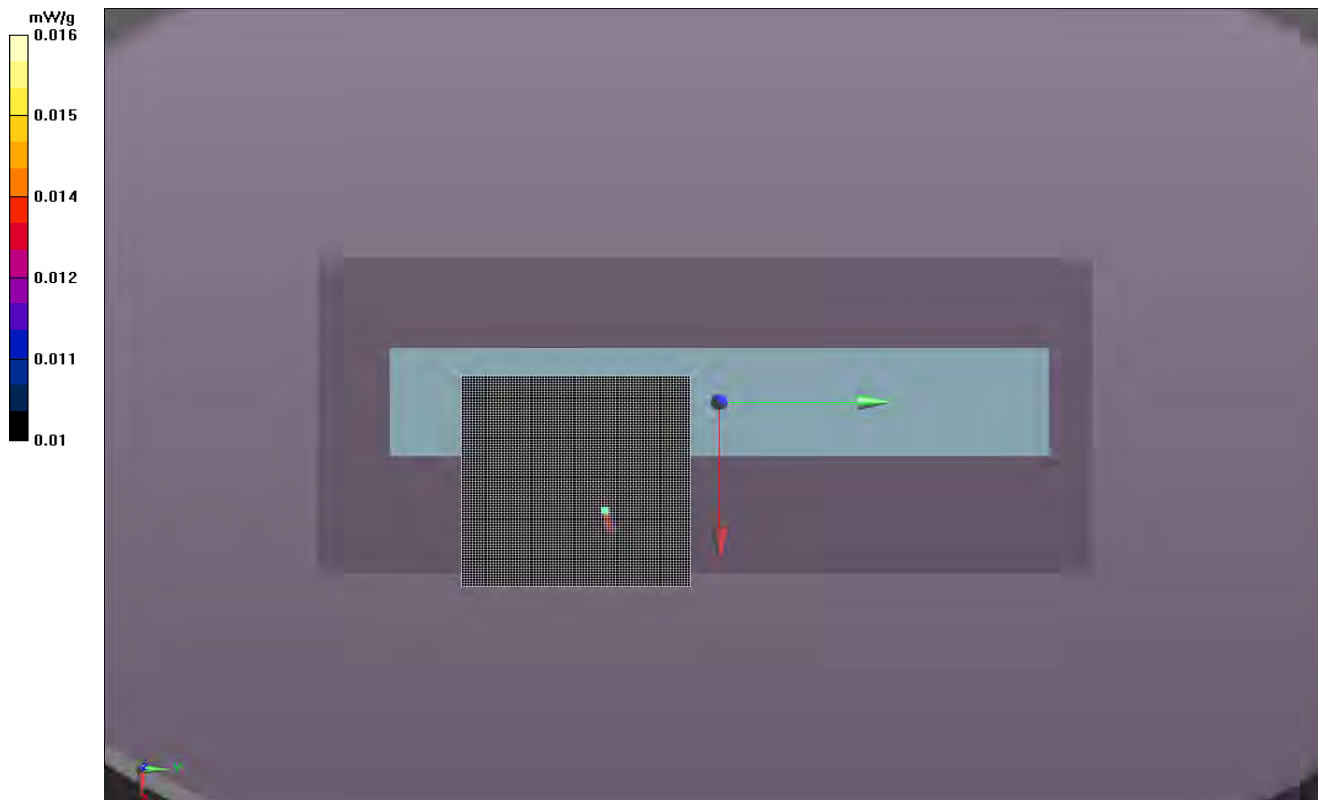

Room Temperature (°C):	22.4	Humidity (%):	32.9	Test Date:	05/10/12
Liquid Temperature (°C):	22.1	Barometric Pressure (mb):	1029	Tested by:	Ethan Schoonover

5G Body Test 14

DUT: Patient Monitor; Type: RAD7CA; Serial: E 1208400623

Communication System: CW; Communication System Band: D5GHz (5000.0 - 6000.0 MHz); Frequency: 5240 MHz; Communication System PAR: 0 dB; PMF: 1
 Medium parameters used (interpolated): $f = 5240$ MHz; $\sigma = 5.09$ mho/m; $\epsilon_r = 47.594$; $\rho = 1000$ kg/m³, Medium parameters used: $\sigma = 0$ mho/m, $\epsilon_r = 1$; $\rho = 1000$ kg/m³
 Phantom section: Flat Section
 Measurement Standard: DASYS (IEEE/IEC/ANSI C63.19-2007)

DASY Configuration:

DASY52 52.8.1(838); SEMCAD X 14.6.5(6469)

Body/Body/Reference scan (41x91x1): Measurement grid: dx=30mm, dy=30mm

[Info: Interpolated medium parameters used for SAR evaluation.](#)

Maximum value of SAR (interpolated) = 0.264 mW/g

Body/Body/Area scan (81x81x1): Measurement grid: dx=10mm, dy=10mm

[Info: Interpolated medium parameters used for SAR evaluation.](#)

Maximum value of SAR (interpolated) = 0.480 mW/g

Body/Body/Zoom Scan (9x9x9)/Cube 0: Measurement grid: dx=4mm, dy=4mm, dz=2.5mm

Reference Value = 10.716 V/m; Power Drift = -0.00 dB

Peak SAR (extrapolated) = 0.806 mW/g

SAR(1 g) = 0.245 mW/g; SAR(10 g) = 0.086 mW/g

[Info: Interpolated medium parameters used for SAR evaluation.](#)

Maximum value of SAR (measured) = 0.473 mW/g

Body/Body/Z Scan (1x1x21): Measurement grid: dx=20mm, dy=20mm, dz=5mm

[Info: Interpolated medium parameters used for SAR evaluation.](#)

Maximum value of Total (measured) = 4.792 V/m

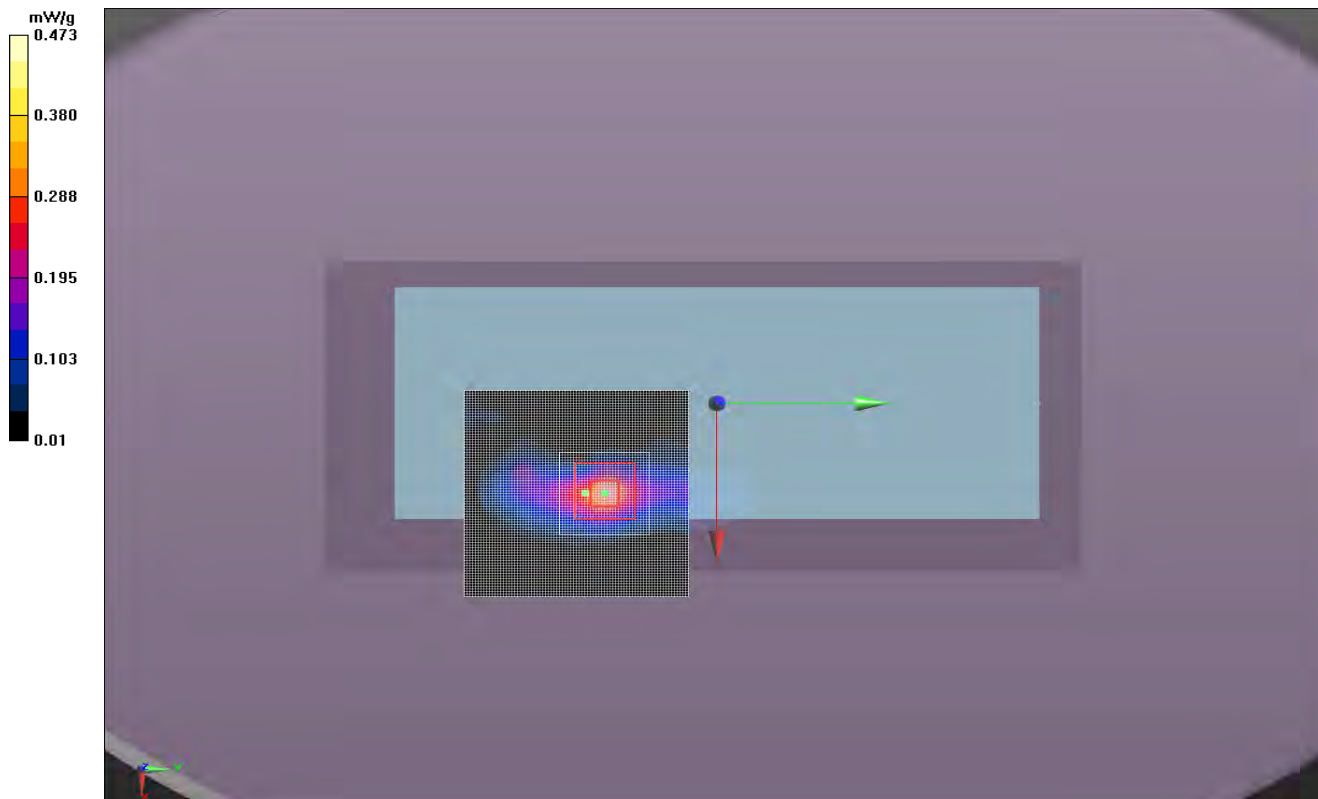

Room Temperature (°C):	20.6	Humidity (%):	40.2	Test Date:	05/10/12
Liquid Temperature (°C):	22.3	Barometric Pressure (mb):	1029	Tested by:	Ethan Schoonover

5G Body Test 15

DUT: Patient Monitor; Type: RAD7CA; Serial: E 1208400623

Communication System: CW; Communication System Band: D5GHz (5000.0 - 6000.0 MHz); Frequency: 5240 MHz; Communication System PAR: 0 dB; PMF: 1
 Medium parameters used (interpolated): $f = 5240$ MHz; $\sigma = 5.09$ mho/m; $\epsilon_r = 47.594$; $\rho = 1000$ kg/m³, Medium parameters used: $\sigma = 0$ mho/m, $\epsilon_r = 1$; $\rho = 1000$ kg/m³
 Phantom section: Flat Section
 Measurement Standard: DASYS (IEEE/IEC/ANSI C63.19-2007)

DASY Configuration:

DASY52 52.8.1(838); SEMCAD X 14.6.5(6469)

Body/Body/Reference scan (41x91x1): Measurement grid: dx=30mm, dy=30mm

[Info: Interpolated medium parameters used for SAR evaluation.](#)

Maximum value of SAR (interpolated) = 0.199 mW/g

Body/Body/Area scan (81x81x1): Measurement grid: dx=10mm, dy=10mm

[Info: Interpolated medium parameters used for SAR evaluation.](#)

Maximum value of SAR (interpolated) = 0.743 mW/g

Body/Body/Zoom Scan (9x9x9)/Cube 0: Measurement grid: dx=4mm, dy=4mm, dz=2.5mm

Reference Value = 13.380 V/m; Power Drift = -0.22 dB

Peak SAR (extrapolated) = 1.438 mW/g

SAR(1 g) = 0.372 mW/g; SAR(10 g) = 0.103 mW/g

[Info: Interpolated medium parameters used for SAR evaluation.](#)

Maximum value of SAR (measured) = 0.714 mW/g

Body/Body/Z Scan (1x1x21): Measurement grid: dx=20mm, dy=20mm, dz=5mm

[Info: Interpolated medium parameters used for SAR evaluation.](#)

Maximum value of Total (measured) = 5.742 V/m

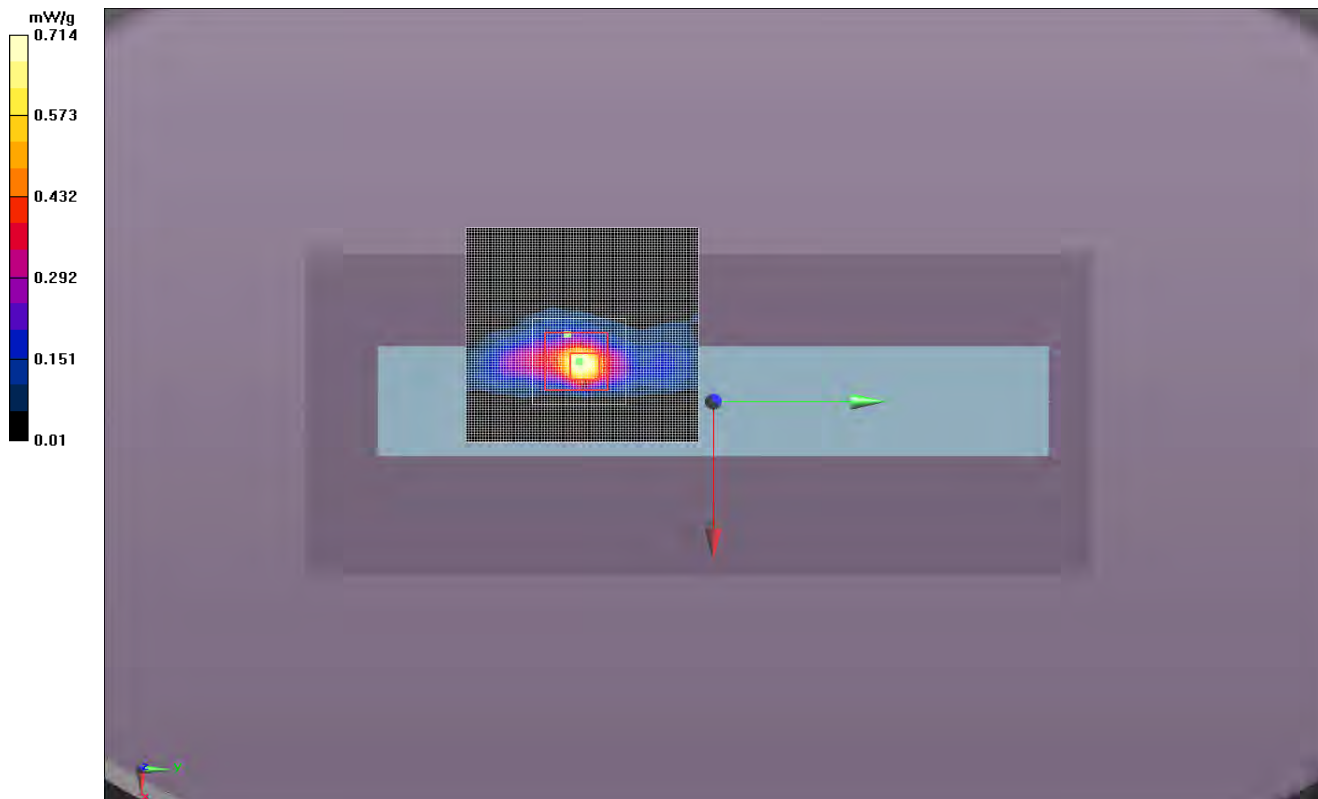

Room Temperature (°C):	23	Humidity (%):	35.2	Test Date:	05/10/12
Liquid Temperature (°C):	22.5	Barometric Pressure (mb):	1029	Tested by:	Ethan Schoonover

5G Body Test 16

DUT: Patient Monitor; Type: RAD7CA; Serial: E 1208400623

Communication System: CW; Communication System Band: D5GHz (5000.0 - 6000.0 MHz); Frequency: 5240 MHz; Communication System PAR: 0 dB; PMF: 1
Medium parameters used (interpolated): $f = 5240$ MHz; $\sigma = 5.09$ mho/m; $\epsilon_r = 47.594$; $\rho = 1000$ kg/m³
Phantom section: Flat Section
Measurement Standard: DASYS (IEEE/IEC/ANSI C63.19-2007)

DASY Configuration:

DASY52 52.8.1(838); SEMCAD X 14.6.5(6469)

Body/Body/Reference scan (41x91x1): Measurement grid: dx=30mm, dy=30mm

[Info: Interpolated medium parameters used for SAR evaluation.](#)

Maximum value of SAR (interpolated) = 0.0452 mW/g

Body/Body/Area scan (81x81x1): Measurement grid: dx=10mm, dy=10mm

[Info: Interpolated medium parameters used for SAR evaluation.](#)

Maximum value of SAR (interpolated) = 0.0244 mW/g

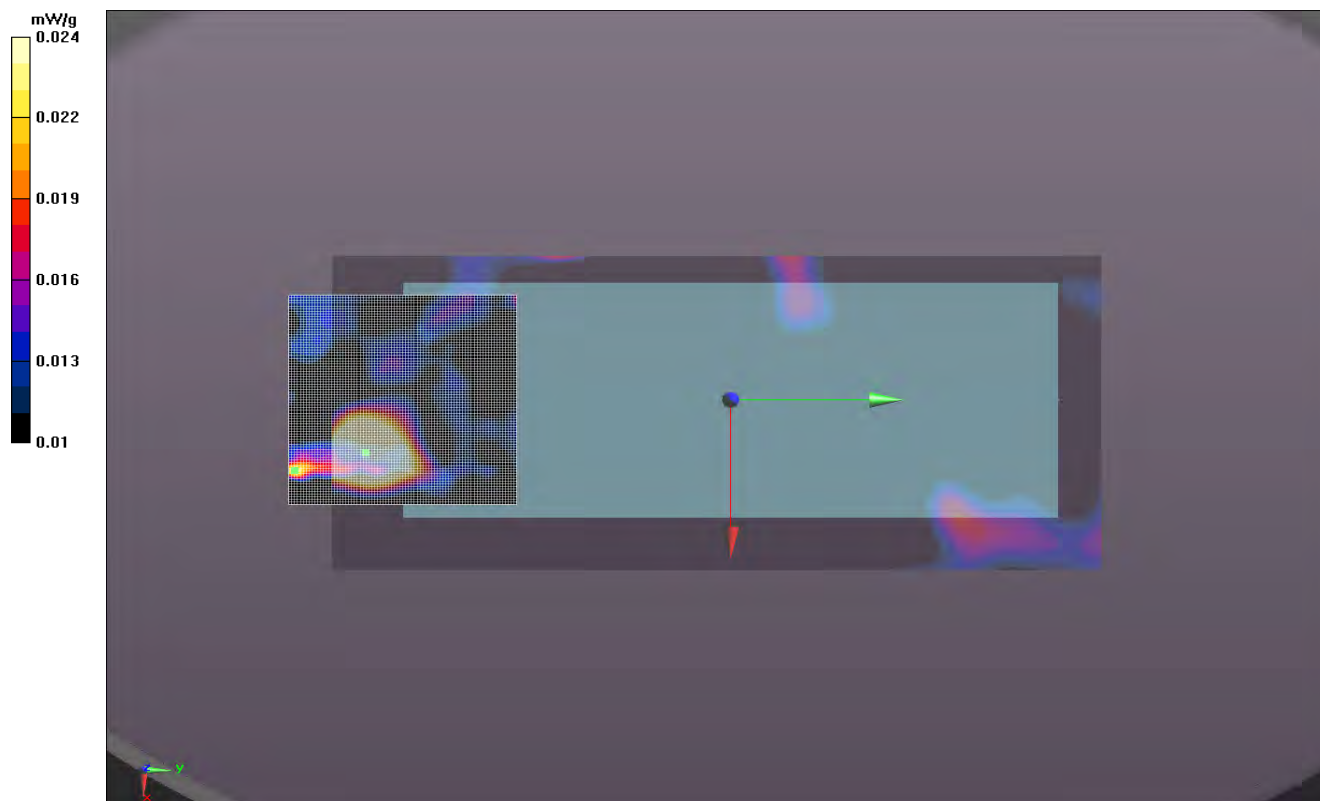

Room Temperature (°C):	21.2	Humidity (%):	36.2	Test Date:	05/10/12
Liquid Temperature (°C):	21.7	Barometric Pressure (mb):	1029	Tested by:	Ethan Schoonover

5G Body Test 17

DUT: Patient Monitor; Type: RAD7CA; Serial: E 1208400623

Communication System: CW; Communication System Band: D5GHz (5000.0 - 6000.0 MHz); Frequency: 5745 MHz; Communication System PAR: 0 dB; PMF: 1
 Medium parameters used (interpolated): $f = 5745$ MHz; $\sigma = 5.763$ mho/m; $\epsilon_r = 46.822$; $\rho = 1000$ kg/m³, Medium parameters used: $\sigma = 0$ mho/m, $\epsilon_r = 1$; $\rho = 1000$ kg/m³
 Phantom section: Flat Section
 Measurement Standard: DASYS (IEEE/IEC/ANSI C63.19-2007)

DASY Configuration:

DASY52 52.8.1(838); SEMCAD X 14.6.5(6469)

Body/Body/Reference scan (41x91x1): Measurement grid: dx=30mm, dy=30mm

[Info: Interpolated medium parameters used for SAR evaluation.](#)

Maximum value of SAR (interpolated) = 0.577 mW/g

Body/Body/Area scan (81x81x1): Measurement grid: dx=10mm, dy=10mm

[Info: Interpolated medium parameters used for SAR evaluation.](#)

Maximum value of SAR (interpolated) = 0.807 mW/g

Body/Body/Zoom Scan (9x9x9)/Cube 0: Measurement grid: dx=4mm, dy=4mm, dz=2.5mm

Reference Value = 12.877 V/m; Power Drift = 0.14 dB

Peak SAR (extrapolated) = 1.678 mW/g

SAR(1 g) = 0.414 mW/g; SAR(10 g) = 0.124 mW/g

[Info: Interpolated medium parameters used for SAR evaluation.](#)

Maximum value of SAR (measured) = 0.848 mW/g

Body/Body/Z Scan (1x1x21): Measurement grid: dx=20mm, dy=20mm, dz=5mm

[Info: Interpolated medium parameters used for SAR evaluation.](#)

Maximum value of Total (measured) = 5.541 V/m

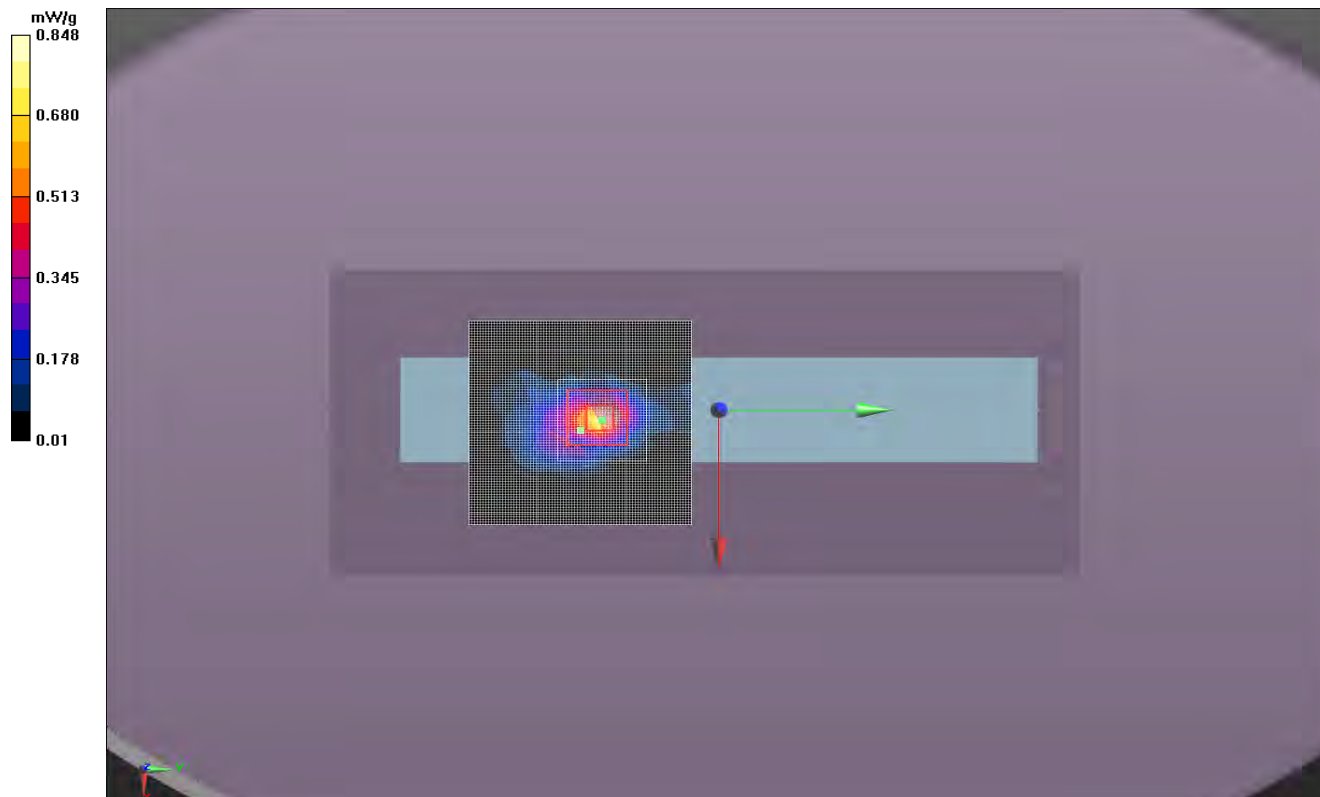

Room Temperature (°C):	21.3	Humidity (%):	34.6	Test Date:	05/10/12
Liquid Temperature (°C):	21.8	Barometric Pressure (mb):	1029	Tested by:	Ethan Schoonover

5G Body Test 18

DUT: Patient Monitor; Type: RAD7CA; Serial: E 1208400623

Communication System: CW; Communication System Band: D5GHz (5000.0 - 6000.0 MHz); Frequency: 5745 MHz; Communication System PAR: 0 dB; PMF: 1
 Medium parameters used (interpolated): $f = 5745$ MHz; $\sigma = 5.763$ mho/m; $\epsilon_r = 46.822$; $\rho = 1000$ kg/m³, Medium parameters used: $\sigma = 0$ mho/m, $\epsilon_r = 1$; $\rho = 1000$ kg/m³
 Phantom section: Flat Section
 Measurement Standard: DASYS (IEEE/IEC/ANSI C63.19-2007)

DASY Configuration:

DASY52 52.8.1(838); SEMCAD X 14.6.5(6469)

Body/Body/Reference scan (41x91x1): Measurement grid: dx=30mm, dy=30mm

[Info: Interpolated medium parameters used for SAR evaluation.](#)

Maximum value of SAR (interpolated) = 0.150 mW/g

Body/Body/Area scan (81x81x1): Measurement grid: dx=10mm, dy=10mm

[Info: Interpolated medium parameters used for SAR evaluation.](#)

Maximum value of SAR (interpolated) = 0.592 mW/g

Body/Body/Zoom Scan (9x9x9)/Cube 0: Measurement grid: dx=4mm, dy=4mm, dz=2.5mm

Reference Value = 10.844 V/m; Power Drift = 0.01 dB

Peak SAR (extrapolated) = 1.057 mW/g

SAR(1 g) = 0.300 mW/g; SAR(10 g) = 0.095 mW/g

[Info: Interpolated medium parameters used for SAR evaluation.](#)

Maximum value of SAR (measured) = 0.611 mW/g

Body/Body/Z Scan (1x1x21): Measurement grid: dx=20mm, dy=20mm, dz=5mm

[Info: Interpolated medium parameters used for SAR evaluation.](#)

Maximum value of Total (measured) = 4.630 V/m

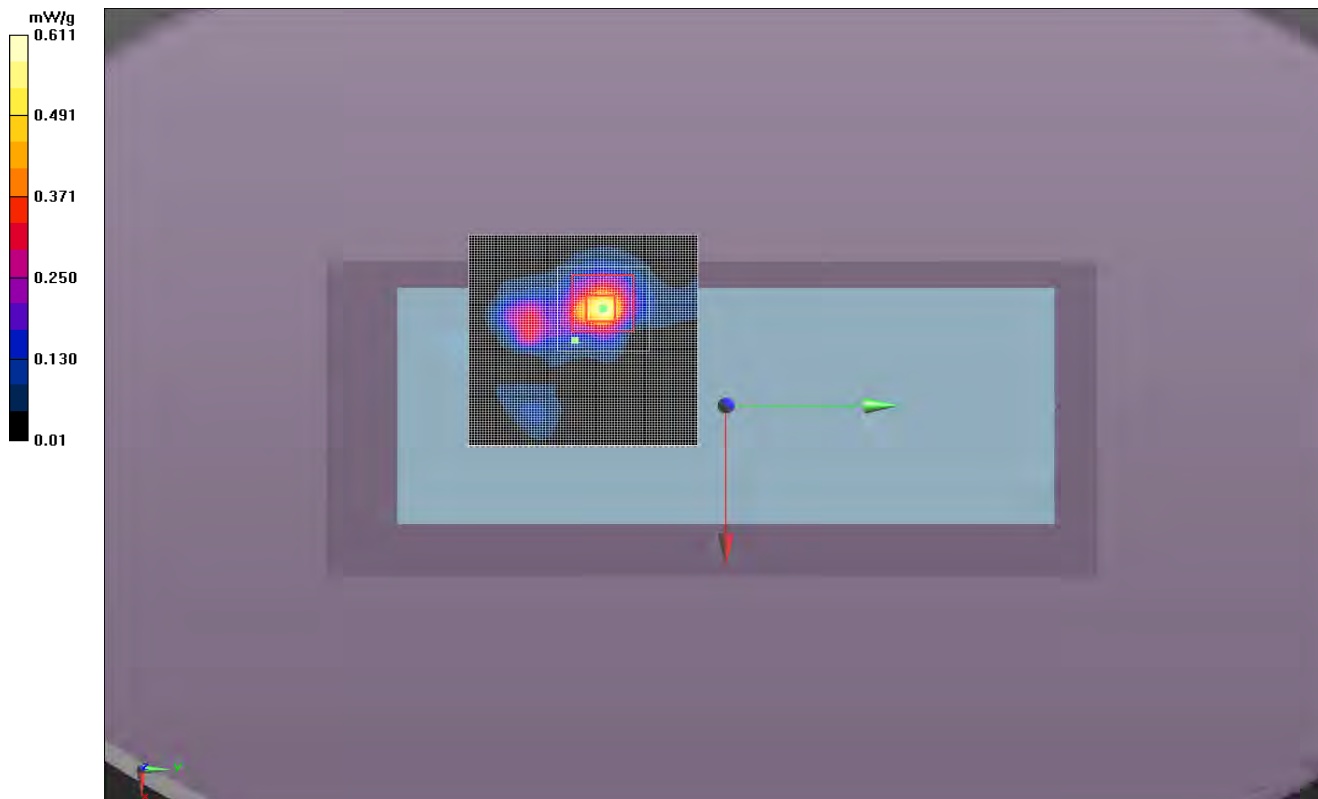

EMC

SAR TEST DATA

Room Temperature (°C):	24	Humidity (%):	29.5	Test Date:	05/11/12
Liquid Temperature (°C):	23.2	Barometric Pressure (mb):	1029	Tested by:	Ethan Schoonover

5G Body Test 19

DUT: Patient Monitor; Type: RAD7CA; Serial: E 1208400623

Communication System: CW; Communication System Band: D5GHz (5000.0 - 6000.0 MHz); Frequency: 5745 MHz; Communication System PAR: 0 dB; PMF: 1
 Medium parameters used (interpolated): $f = 5745$ MHz; $\sigma = 5.763$ mho/m; $\epsilon_r = 46.822$; $\rho = 1000$ kg/m³
 Phantom section: Flat Section
 Measurement Standard: DASYS (IEEE/IEC/ANSI C63.19-2007)

DASY Configuration:

DASY52 52.8.1(838); SEMCAD X 14.6.5(6469)

Body/Body/Reference scan (41x91x1): Measurement grid: dx=30mm, dy=30mm

[Info: Interpolated medium parameters used for SAR evaluation.](#)

Maximum value of SAR (interpolated) = 0.192 mW/g

Body/Body/Area scan (81x81x1): Measurement grid: dx=10mm, dy=10mm

[Info: Interpolated medium parameters used for SAR evaluation.](#)

Maximum value of SAR (interpolated) = 0.00612 mW/g

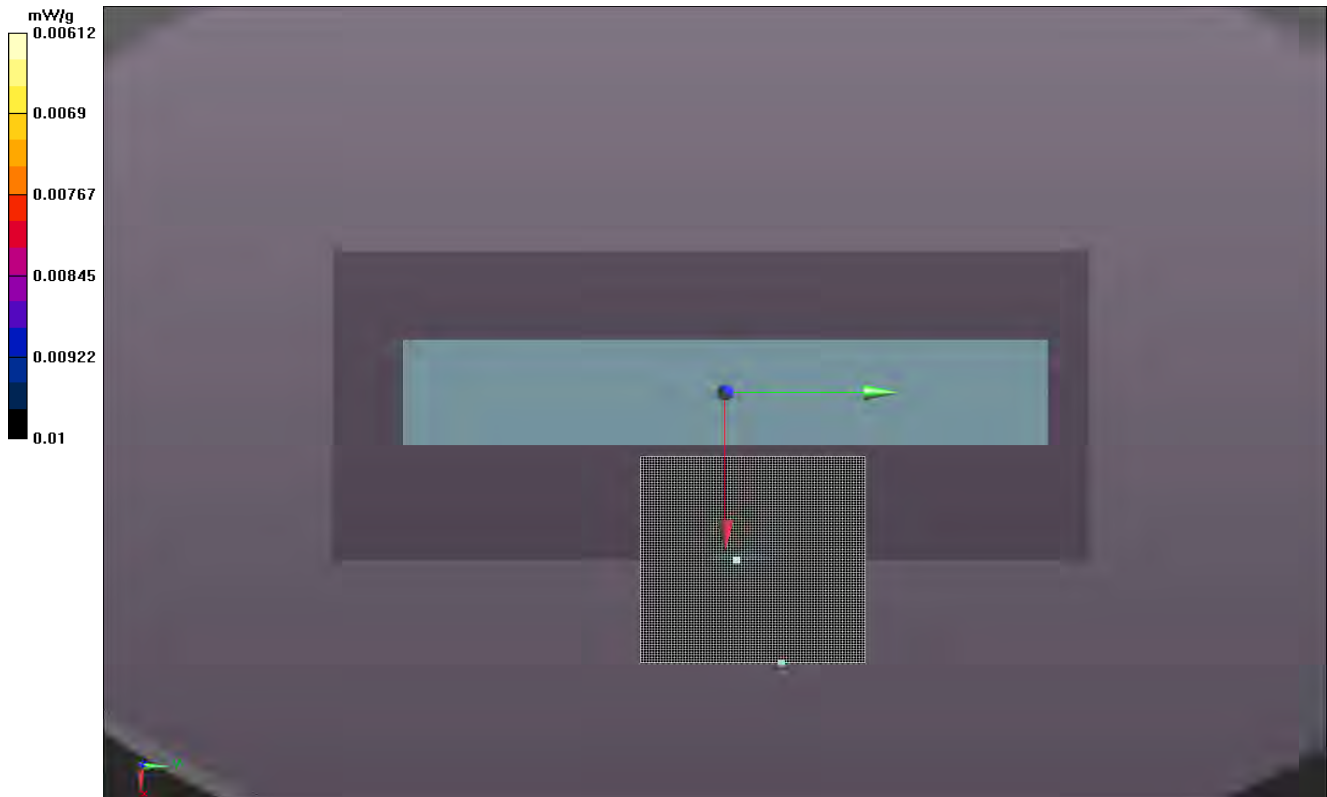

Room Temperature (°C):	21	Humidity (%):	35.9	Test Date:	05/10/12
Liquid Temperature (°C):	21.8	Barometric Pressure (mb):	1029	Tested by:	Ethan Schoonover

5G Body Test 20

DUT: Patient Monitor; Type: RAD7CA; Serial: E 1208400623

Communication System: CW; Communication System Band: D5GHz (5000.0 - 6000.0 MHz); Frequency: 5745 MHz; Communication System PAR: 0 dB; PMF: 1
Medium parameters used (interpolated): $f = 5745$ MHz; $\sigma = 5.763$ mho/m; $\epsilon_r = 46.822$; $\rho = 1000$ kg/m³
Phantom section: Flat Section
Measurement Standard: DASYS (IEEE/IEC/ANSI C63.19-2007)

DASY Configuration:

DASY52 52.8.1(838); SEMCAD X 14.6.5(6469)

Body/Body/Reference scan (41x91x1): Measurement grid: dx=30mm, dy=30mm

[Info: Interpolated medium parameters used for SAR evaluation.](#)

Maximum value of SAR (interpolated) = 0.0311 mW/g

Body/Body/Area scan (81x81x1): Measurement grid: dx=10mm, dy=10mm

[Info: Interpolated medium parameters used for SAR evaluation.](#)

Maximum value of SAR (interpolated) = 0.0373 mW/g

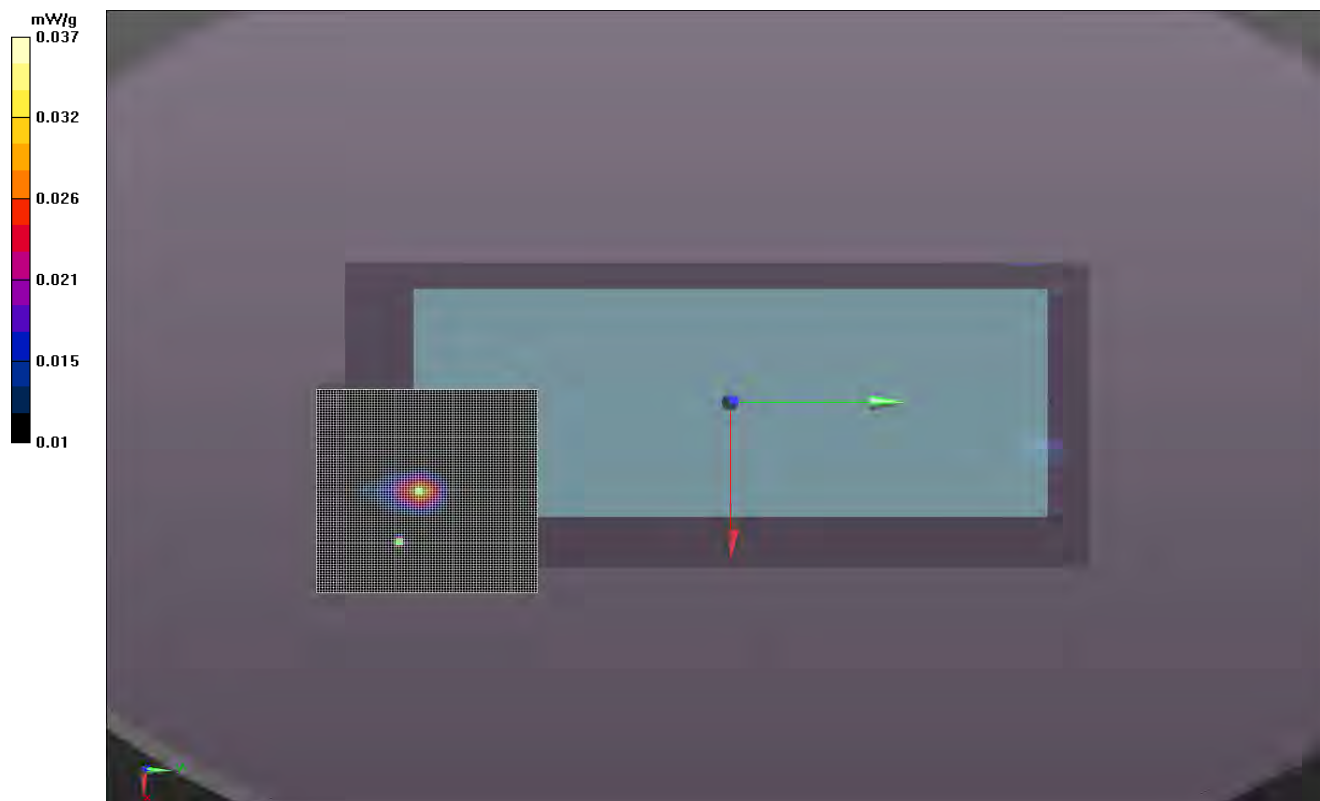

Room Temperature (°C):	23.8	Humidity (%):	30.8	Test Date:	05/11/12
Liquid Temperature (°C):	23.2	Barometric Pressure (mb):	1029	Tested by:	Ethan Schoonover

5G Body Test 21

DUT: Patient Monitor; Type: RAD7CA; Serial: E 1208400623

Communication System: CW; Communication System Band: D5GHz (5000.0 - 6000.0 MHz); Frequency: 5785 MHz; Communication System PAR: 0 dB; PMF: 1
Medium parameters used (interpolated): $f = 5785$ MHz; $\sigma = 5.83$ mho/m; $\epsilon_r = 46.739$; $\rho = 1000$ kg/m³
Phantom section: Flat Section
Measurement Standard: DASYS (IEEE/IEC/ANSI C63.19-2007)

DASY Configuration:

DASY52 52.8.1(838); SEMCAD X 14.6.5(6469)

Body/Body/Reference scan (41x91x1): Measurement grid: dx=30mm, dy=30mm

[Info: Interpolated medium parameters used for SAR evaluation.](#)
Maximum value of SAR (interpolated) = 0.00153 mW/g

Body/Body/Area scan (81x81x1): Measurement grid: dx=10mm, dy=10mm

[Info: Interpolated medium parameters used for SAR evaluation.](#)
Maximum value of SAR (interpolated) = 0.0131 mW/g

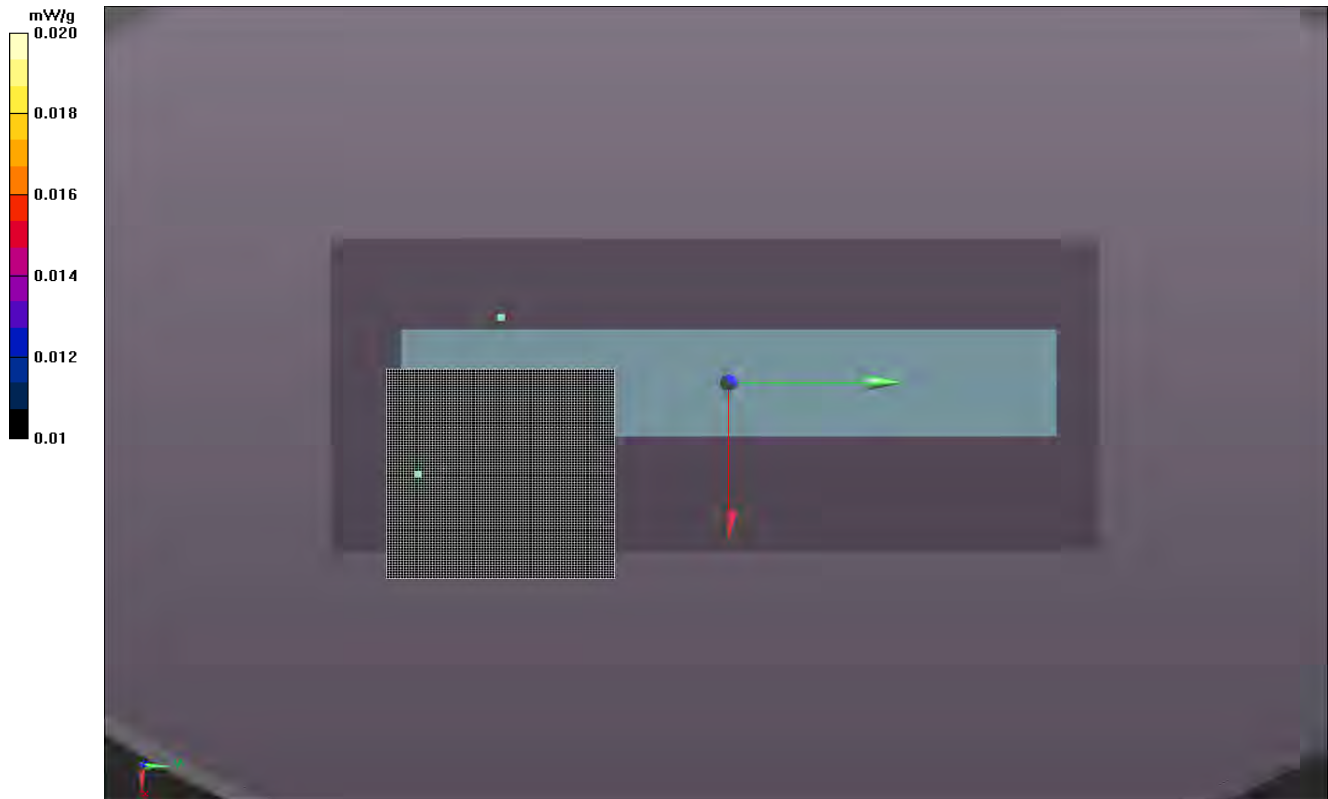

Room Temperature (°C):	23.8	Humidity (%):	30.8	Test Date:	05/11/12
Liquid Temperature (°C):	23.2	Barometric Pressure (mb):	1029	Tested by:	Ethan Schoonover

5G Body Test 22

DUT: Patient Monitor; Type: RAD7CA; Serial: E 1208400623

Communication System: CW; Communication System Band: D5GHz (5000.0 - 6000.0 MHz); Frequency: 5785 MHz; Communication System PAR: 0 dB; PMF: 1
 Medium parameters used (interpolated): $f = 5785$ MHz; $\sigma = 5.83$ mho/m; $\epsilon_r = 46.739$; $\rho = 1000$ kg/m³, Medium parameters used: $\sigma = 0$ mho/m, $\epsilon_r = 1$; $\rho = 1000$ kg/m³
 Phantom section: Flat Section
 Measurement Standard: DASYS (IEEE/IEC/ANSI C63.19-2007)

DASY Configuration:

DASY52 52.8.1(838); SEMCAD X 14.6.5(6469)

Body/Body/Reference scan (41x91x1): Measurement grid: dx=30mm, dy=30mm

[Info: Interpolated medium parameters used for SAR evaluation.](#)

Maximum value of SAR (interpolated) = 0.217 mW/g

Body/Body/Area scan (81x81x1): Measurement grid: dx=10mm, dy=10mm

[Info: Interpolated medium parameters used for SAR evaluation.](#)

Maximum value of SAR (interpolated) = 0.458 mW/g

Body/Body/Zoom Scan (9x9x9)/Cube 0: Measurement grid: dx=4mm, dy=4mm, dz=2.5mm

Reference Value = 8.625 V/m; Power Drift = 0.07 dB

Peak SAR (extrapolated) = 1.118 mW/g

SAR(1 g) = 0.183 mW/g; SAR(10 g) = 0.059 mW/g

[Info: Interpolated medium parameters used for SAR evaluation.](#)

Maximum value of SAR (measured) = 0.362 mW/g

Body/Body/Z Scan (1x1x21): Measurement grid: dx=20mm, dy=20mm, dz=5mm

[Info: Interpolated medium parameters used for SAR evaluation.](#)

Maximum value of Total (measured) = 3.347 V/m

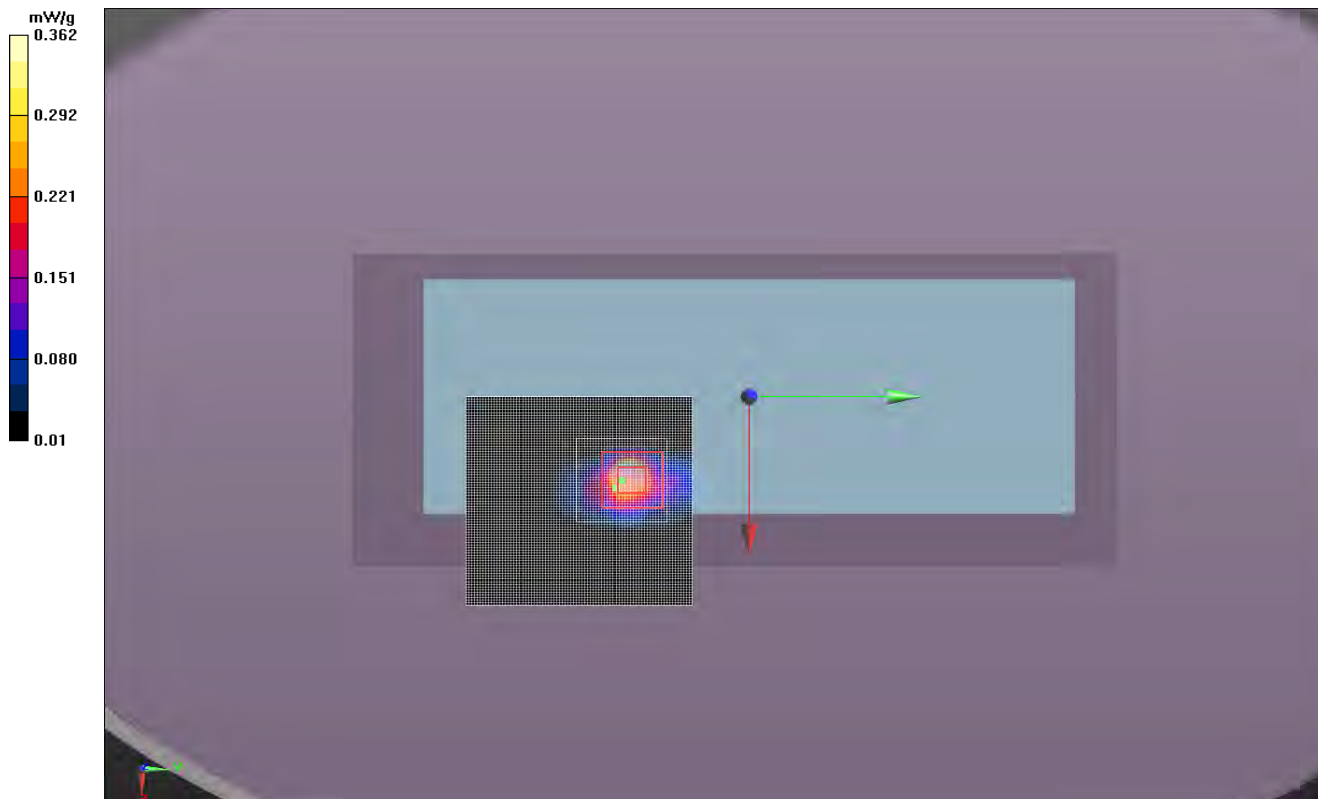

Room Temperature (°C):	23.1	Humidity (%):	31.5	Test Date:	05/11/12
Liquid Temperature (°C):	22.9	Barometric Pressure (mb):	1029	Tested by:	Ethan Schoonover

5G Body Test 23

DUT: Patient Monitor; Type: RAD7CA; Serial: E 1208400623

Communication System: CW; Communication System Band: D5GHz (5000.0 - 6000.0 MHz); Frequency: 5785 MHz; Communication System PAR: 0 dB; PMF: 1
 Medium parameters used (interpolated): $f = 5785$ MHz; $\sigma = 5.83$ mho/m; $\epsilon_r = 46.739$; $\rho = 1000$ kg/m³, Medium parameters used: $\sigma = 0$ mho/m, $\epsilon_r = 1$; $\rho = 1000$ kg/m³
 Phantom section: Flat Section
 Measurement Standard: DASy5 (IEEE/IEC/ANSI C63.19-2007)

DASY Configuration:

DASY52 52.8.1(838); SEMCAD X 14.6.5(6469)

Body/Body/Reference scan (41x91x1): Measurement grid: dx=30mm, dy=30mm

[Info: Interpolated medium parameters used for SAR evaluation.](#)

Maximum value of SAR (interpolated) = 0.0842 mW/g

Body/Body/Area scan (81x81x1): Measurement grid: dx=10mm, dy=10mm

[Info: Interpolated medium parameters used for SAR evaluation.](#)

Maximum value of SAR (interpolated) = 0.624 mW/g

Body/Body/Zoom Scan (9x9x9)/Cube 0: Measurement grid: dx=4mm, dy=4mm, dz=2.5mm

Reference Value = 11.092 V/m; Power Drift = -0.01 dB

Peak SAR (extrapolated) = 1.182 mW/g

SAR(1 g) = 0.301 mW/g; SAR(10 g) = 0.084 mW/g

[Info: Interpolated medium parameters used for SAR evaluation.](#)

Maximum value of SAR (measured) = 0.659 mW/g

Body/Body/Z Scan (1x1x21): Measurement grid: dx=20mm, dy=20mm, dz=5mm

[Info: Interpolated medium parameters used for SAR evaluation.](#)

Maximum value of Total (measured) = 4.889 V/m

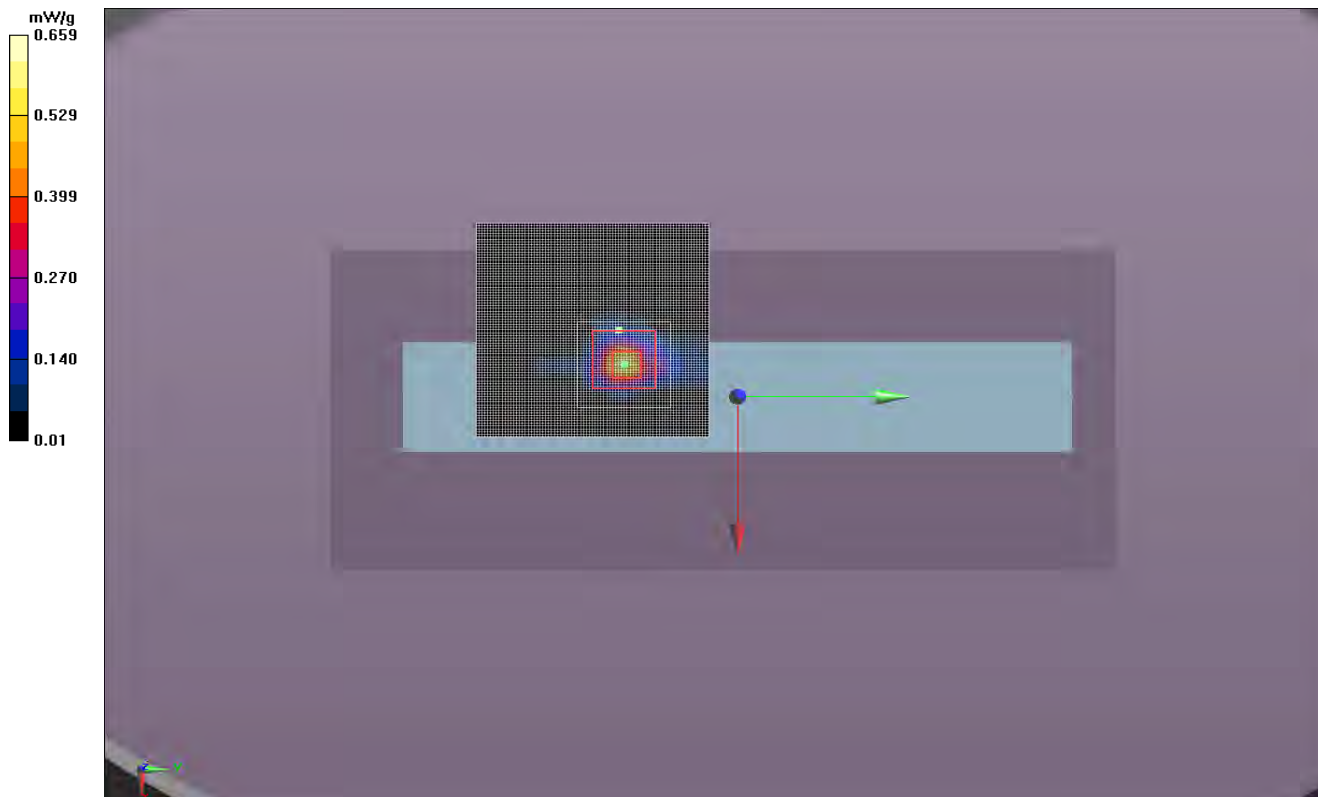

Room Temperature (°C):	23.1	Humidity (%):	32.2	Test Date:	05/11/12
Liquid Temperature (°C):	22.6	Barometric Pressure (mb):	1029	Tested by:	Ethan Schoonover

5G Body Test 24

DUT: Patient Monitor; Type: RAD7CA; Serial: E 1208400623

Communication System: CW; Communication System Band: D5GHz (5000.0 - 6000.0 MHz); Frequency: 5785 MHz; Communication System PAR: 0 dB; PMF: 1
Medium parameters used (interpolated): $f = 5785$ MHz; $\sigma = 5.83$ mho/m; $\epsilon_r = 46.739$; $\rho = 1000$ kg/m³
Phantom section: Flat Section
Measurement Standard: DASYS (IEEE/IEC/ANSI C63.19-2007)

DASY Configuration:

DASY52 52.8.1(838); SEMCAD X 14.6.5(6469)

Body/Body/Reference scan (41x91x1): Measurement grid: dx=30mm, dy=30mm

[Info: Interpolated medium parameters used for SAR evaluation.](#)

Maximum value of SAR (interpolated) = 00 mW/g

Body/Body/Area scan (81x81x1): Measurement grid: dx=10mm, dy=10mm

[Info: Interpolated medium parameters used for SAR evaluation.](#)

Maximum value of SAR (interpolated) = 0.0316 mW/g

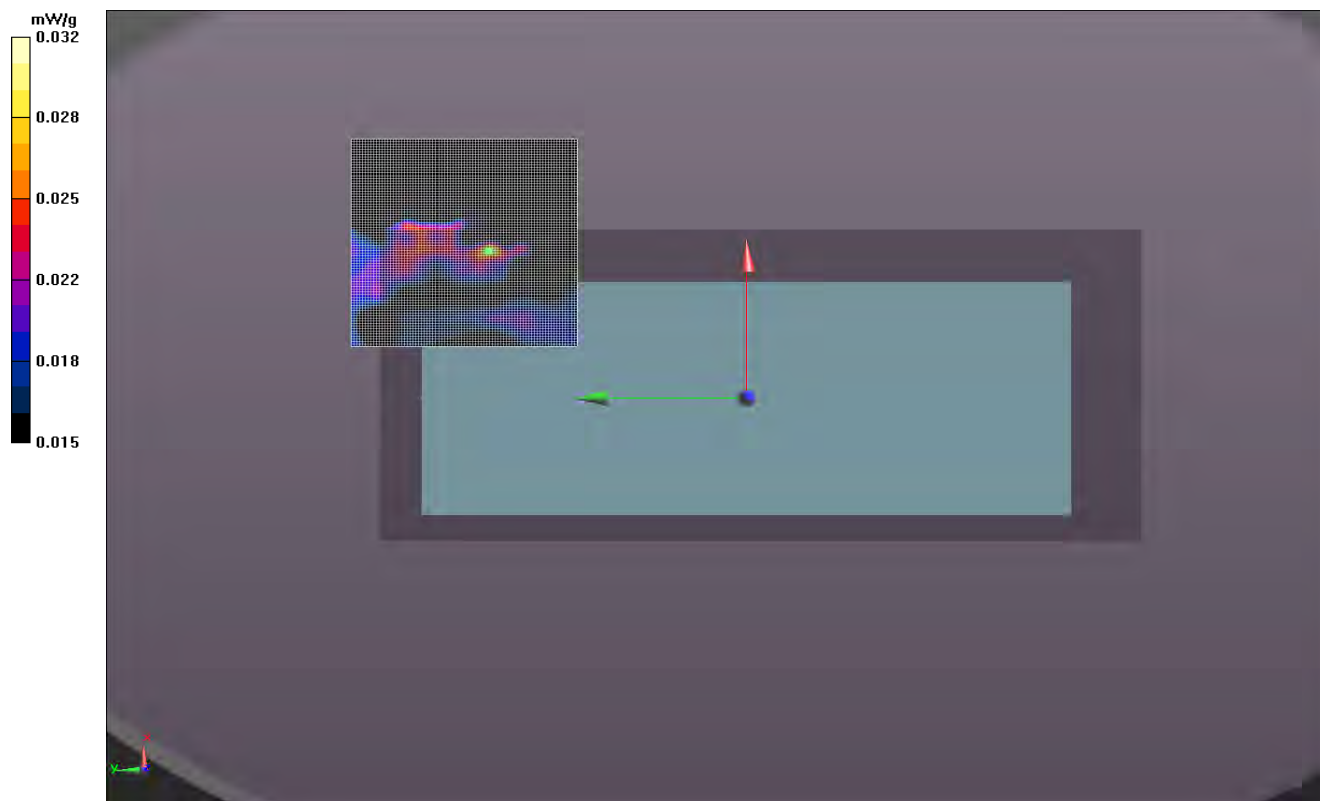

EMC

SAR TEST DATA

Room Temperature (°C):	26	Humidity (%):	28.3	Test Date:	05/10/12
Liquid Temperature (°C):	22.9	Barometric Pressure (mb):	1029	Tested by:	Ethan Schoonover

Body Test # 9

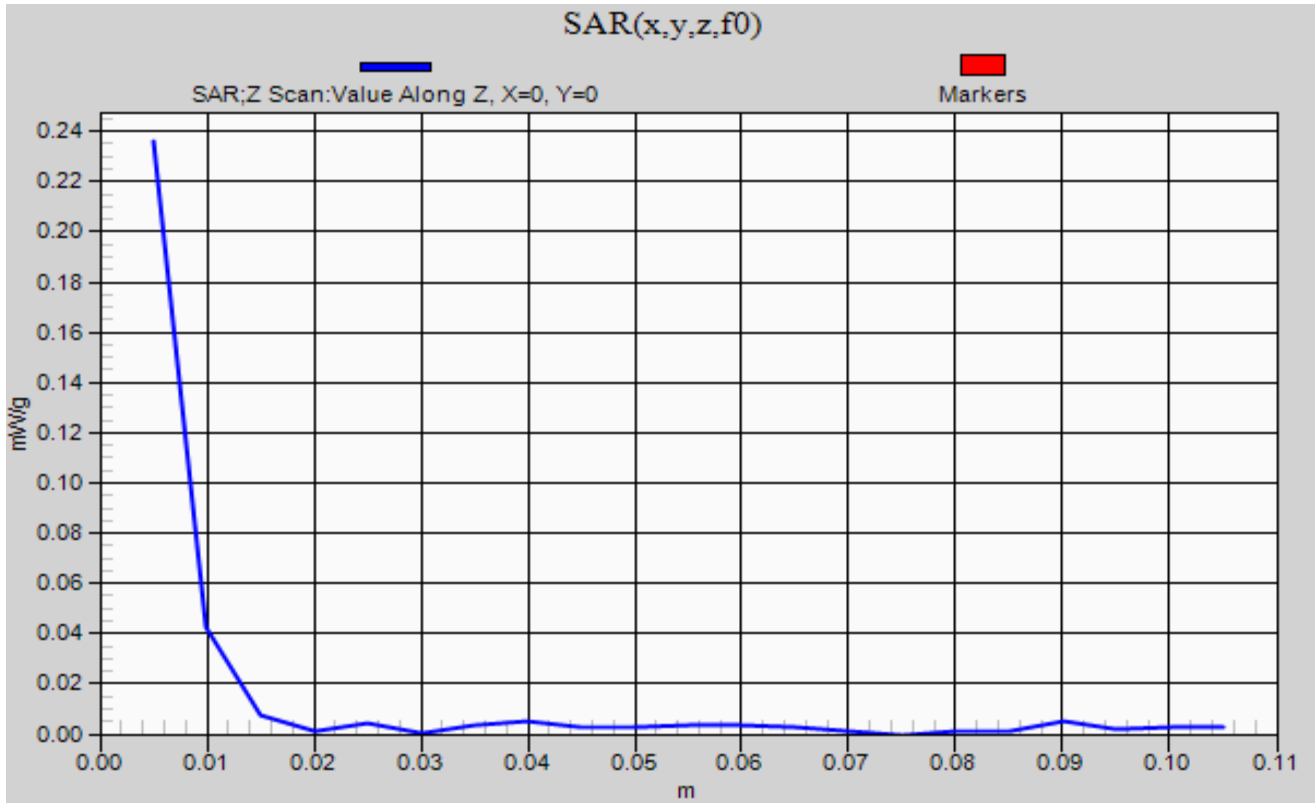

SAR TEST DATA

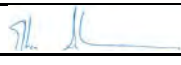
EUT: RAD7CA	Work Order: MASI0103
Serial Number: E 1208400623	Date: See Data Sheets
Customer: Masimo Corporation	Temperature: See Data Sheets
Attendees: None	Humidity: See Data Sheets
Project: None	Barometric Pres.: See Data Sheets
Tested by: Ethan Schoonover	Job Site: EV08
TEST SPECIFICATIONS	
FCC 2.1093:2011	FCC OET 65C:2001
FCC 15.247:2011	IEEE Std 1528:2003
FCC 15.407:2001	FCC KDB 447498 D01 v04
Health Safety Code 6:2009	FCC KDB 248227 D01 V01r02
	FCC KDB 865664
	RSS-102, Issue 4:2010
COMMENTS	
No body worn holsters, pouches, or lanyards. Tested at 0cm spacing, 100% duty cycle	
DEVIATIONS FROM TEST STANDARD	
No Deviations	
Configuration #	1
	Signature 

Test Configuration	Frequency Band	Transmit Frequency (MHz)	Transmit Channel	Data Rate (Mbps)	Transmit Mode	Accessory	EUT Position	Power Drift During Test (dB)	Measured 1g SAR Level (mW/g)	Scaled to 75% due to Antenna Switched Diversity ^{Note 3} (mW/g)	Scaled to 6% Duty Cycle ^{Note 4} (mW/g)	Test #
Body - Antenna 1	2450	2462	11	1	BPSK	Patient Leads	Right	Note 2	Note 1	N/A	N/A	1
	2450	2462	11	1	BPSK	Patient Leads	Back	-0.02	0.422	0.317	0.022	2
	2450	2462	11	1	BPSK	Patient Leads	Left	0.05	1.45	1.088	0.076	3
	2450	2437	6	1	BPSK	Patient Leads	Left	0.14	1.46	1.095	0.077	3b
	2450	2412	1	1	BPSK	Patient Leads	Left	0.16	1.63	1.223	0.086	3c
	2450	2462	11	1	BPSK	Patient Leads	Front	Note 2	Note 1	N/A	N/A	4
Body - Antenna 2	2450	2462	11	1	BPSK	Patient Leads	Left	Note 2	Note 1	N/A	N/A	5
	2450	2462	11	1	BPSK	Patient Leads	Back	0.12	0.466	0.350	0.024	6
	2450	2462	11	1	BPSK	Patient Leads	Right	0.19	2.15	1.613	0.113	7
	2450	2412	1	1	BPSK	Patient Leads	Right	0.11	1.77	1.328	0.093	7b
	2450	2437	6	1	BPSK	Patient Leads	Right	0.24	1.95	1.463	0.102	7c
	2450	2462	11	1	BPSK	Patient Leads	Front	Note 2	Note 1	N/A	N/A	8

Note 1: Zoom scan measurement was not performed because the area scan results were less than 0.06 mW/g

Note 2: Power drift measurement was not performed because the area scan results were less than 0.06 mW/g

Note 3: Measured SAR multiplied by a scale factor of 0.75

Note 4: Measured SAR after it has been scaled for Antenna Switched Diversity, multiplied by a scale factor of 0.07

Room Temperature (°C):	22.3	Humidity (%):	37.2	Test Date:	05/09/12
Liquid Temperature (°C):	21.7	Barometric Pressure (mb):	1018	Tested by:	Ethan Schoonover

2450M Body Test 1

DUT: Patient Monitor; Type: RAD7CA; Serial: E 1208400623

Communication System: CW; Communication System Band: D2450 (2450.0 MHz); Frequency: 2462 MHz; Communication System PAR: 0 dB; PMF: 1

Medium parameters used (interpolated): $f = 2462$ MHz; $\sigma = 2.043$ mho/m; $\epsilon_r = 50.278$; $\rho = 1000$ kg/m³

Phantom section: Flat Section

Measurement Standard: DASYS (IEEE/IEC/ANSI C63.19-2007)

DASY Configuration:

DASY52 52.8.1(838); SEMCAD X 14.6.5(6469)

Body/Body/Reference scan (41x91x1): Measurement grid: dx=30mm, dy=30mm

[Info: Interpolated medium parameters used for SAR evaluation.](#)

Maximum value of SAR (interpolated) = 0.0471 mW/g

Body/Body/Area scan (71x71x1): Measurement grid: dx=15mm, dy=15mm

[Info: Interpolated medium parameters used for SAR evaluation.](#)

Maximum value of SAR (interpolated) = 0.0578 mW/g

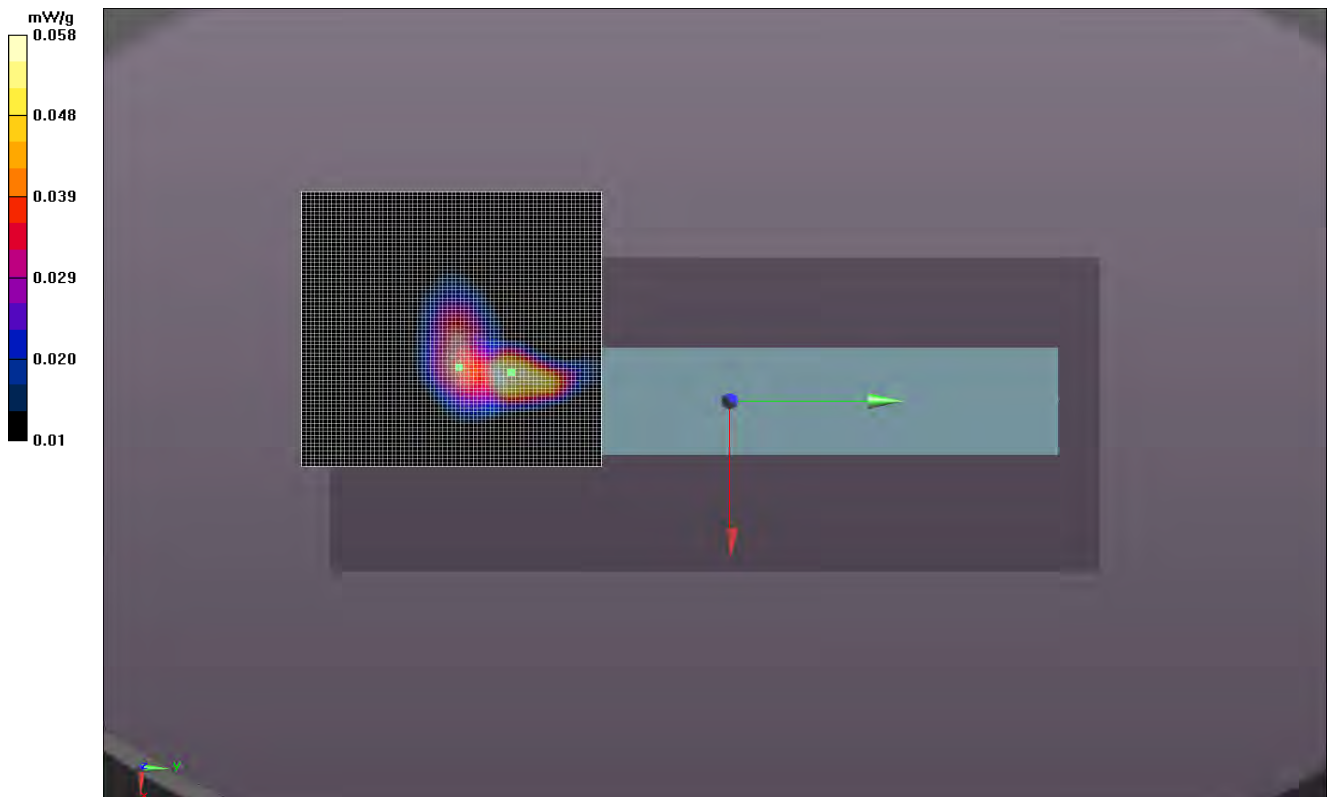

Room Temperature (°C):	24.9	Humidity (%):	39.3	Test Date:	05/09/12
Liquid Temperature (°C):	20.5	Barometric Pressure (mb):	1018	Tested by:	Rod Munro

2450M Body Test 2

DUT: Patient Monitor; Type: RAD7CA; Serial: E 1208400623

Communication System: CW; Communication System Band: D2450 (2450.0 MHz); Frequency: 2462 MHz; Communication System PAR: 0 dB; PMF: 1
 Medium parameters used: $\sigma = 0$ mho/m, $\epsilon_r = 1$; $\rho = 1000$ kg/m³, Medium parameters used (interpolated): $f = 2462$ MHz; $\sigma = 2.043$ mho/m; $\epsilon_r = 50.278$; $\rho = 1000$ kg/m³
 Phantom section: Flat Section
 Measurement Standard: DASYS5 (IEEE/IEC/ANSI C63.19-2007)

DASY Configuration:

DASY52 52.8.1(838); SEMCAD X 14.6.5(6469)

Body/Body/Z Scan (1x1x21): Measurement grid: dx=20mm, dy=20mm, dz=5mm

[Info: Interpolated medium parameters used for SAR evaluation.](#)

Maximum value of Total (measured) = 11.57 V/m

Body/Body/Reference scan (41x91x1): Measurement grid: dx=30mm, dy=30mm

[Info: Interpolated medium parameters used for SAR evaluation.](#)

Maximum value of SAR (interpolated) = 0.359 mW/g

Body/Body/Area scan (71x71x1): Measurement grid: dx=15mm, dy=15mm

[Info: Interpolated medium parameters used for SAR evaluation.](#)

Maximum value of SAR (interpolated) = 0.529 mW/g

Body/Body/Zoom Scan (7x7x7)/Cube 0: Measurement grid: dx=5mm, dy=5mm, dz=5mm

DUT: Patient Monitor; Type: RAD7CA; Serial: E 1208400623

Peak SAR (extrapolated) = 0.873 mW/g

Reference Value = 14.618 V/m; Power Drift = -0.02 dB

SAR(1 g) = 0.422 mW/g; SAR(10 g) = 0.199 mW/g

[Info: Interpolated medium parameters used for SAR evaluation.](#)

Maximum value of SAR (measured) = 0.540 mW/g

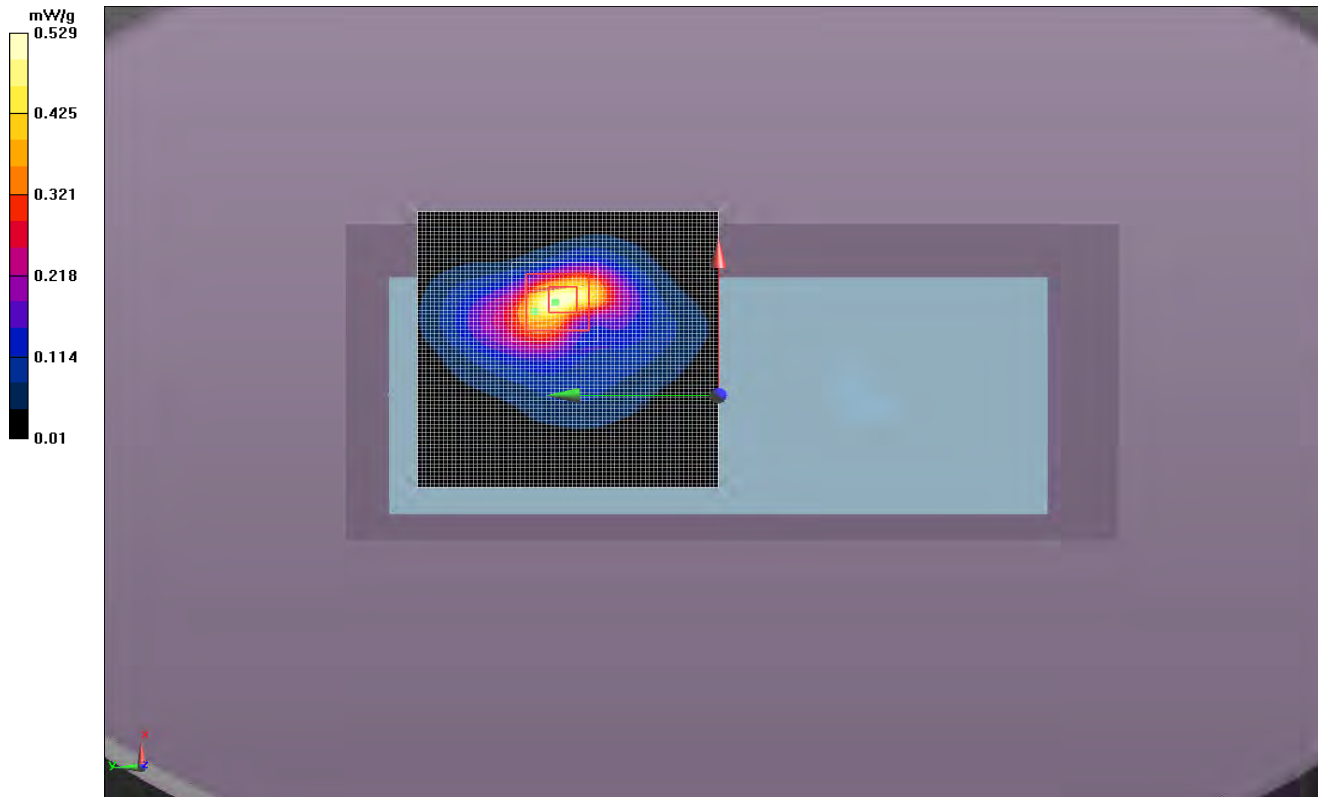

Room Temperature (°C):	22.3	Humidity (%):	37.2	Test Date:	05/09/12
Liquid Temperature (°C):	21.7	Barometric Pressure (mb):	1018	Tested by:	Ethan Schoonover

2450M Body Test 3

DUT: Patient Monitor; Type: RAD7CA; Serial: E 1208400623

Communication System: CW; Communication System Band: D2450 (2450.0 MHz); Frequency: 2462 MHz; Communication System PAR: 0 dB; PMF: 1
 Medium parameters used: $\sigma = 0$ mho/m, $\epsilon_r = 1$; $\rho = 1000$ kg/m³, Medium parameters used (interpolated): $f = 2462$ MHz; $\sigma = 2.043$ mho/m; $\epsilon_r = 50.278$; $\rho = 1000$ kg/m³
 Phantom section: Flat Section
 Measurement Standard: DASYS5 (IEEE/IEC/ANSI C63.19-2007)

DASY Configuration:

DASY52 52.8.1(838); SEMCAD X 14.6.5(6469)

Body/Body/Z Scan (1x1x21): Measurement grid: dx=20mm, dy=20mm, dz=5mm

[Info: Interpolated medium parameters used for SAR evaluation.](#)

Maximum value of Total (measured) = 21.05 V/m

Body/Body/Reference scan (41x91x1): Measurement grid: dx=30mm, dy=30mm

[Info: Interpolated medium parameters used for SAR evaluation.](#)

Maximum value of SAR (interpolated) = 1.65 mW/g

Body/Body/Area scan (71x71x1): Measurement grid: dx=15mm, dy=15mm

[Info: Interpolated medium parameters used for SAR evaluation.](#)

Maximum value of SAR (interpolated) = 1.84 mW/g

Body/Body/Zoom Scan (7x8x7)/Cube 0: Measurement grid: dx=5mm, dy=5mm, dz=5mm

DUT: Patient Monitor; Type: RAD7CA; Serial: E 1208400623

Reference Value = 28.427 V/m; Power Drift = 0.05 dB

Peak SAR (extrapolated) = 3.593 mW/g

SAR(1 g) = 1.45 mW/g; SAR(10 g) = 0.567 mW/g

[Info: Interpolated medium parameters used for SAR evaluation.](#)

Maximum value of SAR (measured) = 2.10 mW/g

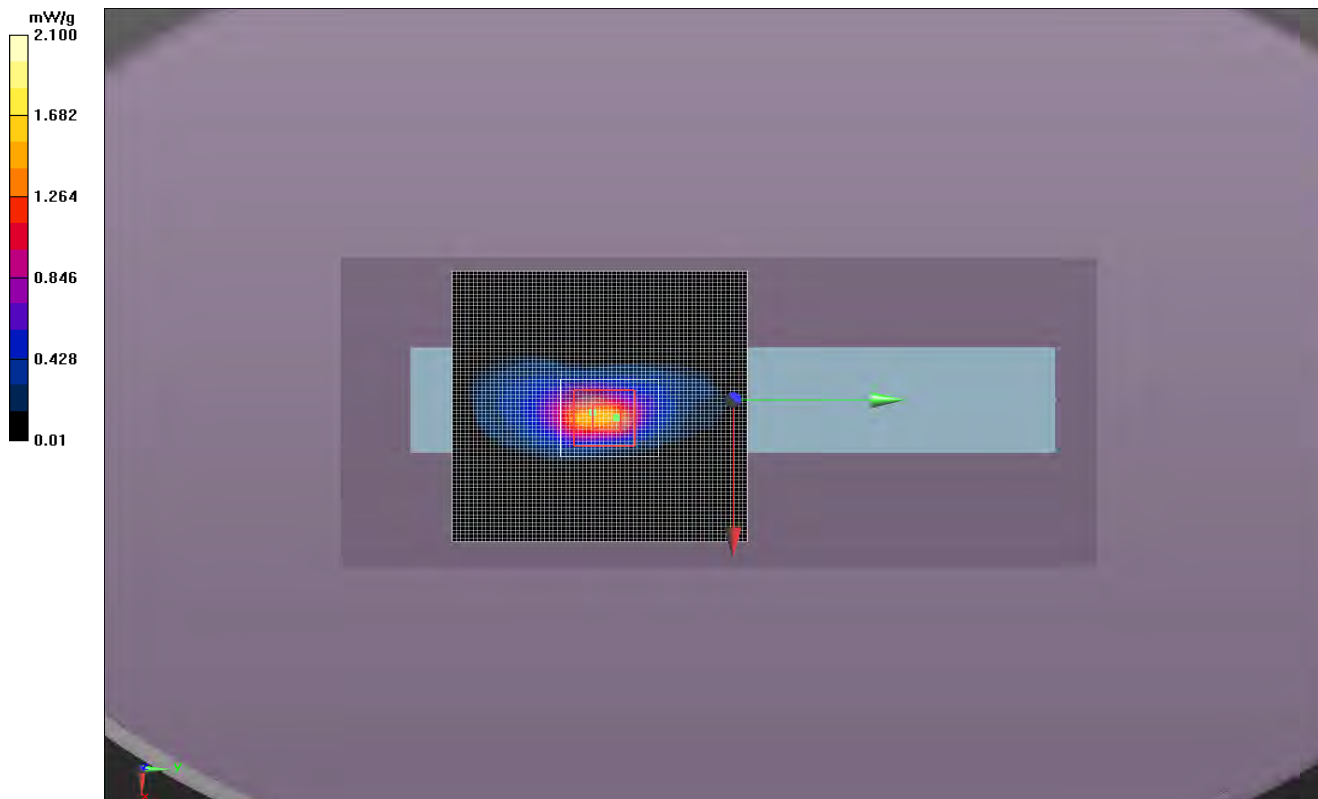

Room Temperature (°C):	22.3	Humidity (%):	37.2	Test Date:	05/09/12
Liquid Temperature (°C):	21.7	Barometric Pressure (mb):	1018	Tested by:	Ethan Schoonover

2450M Body Test 3b

DUT: Patient Monitor; Type: RAD7CA; Serial: E 1208400623

Communication System: CW; Communication System Band: D2450 (2450.0 MHz); Frequency: 2437 MHz; Communication System PAR: 0 dB; PMF: 1
 Medium parameters used: $\sigma = 0$ mho/m, $\epsilon_r = 1$; $\rho = 1000$ kg/m³, Medium parameters used (interpolated): $f = 2437$ MHz; $\sigma = 2.009$ mho/m; $\epsilon_r = 50.379$; $\rho = 1000$ kg/m³
 Phantom section: Flat Section
 Measurement Standard: DASYS5 (IEEE/IEC/ANSI C63.19-2007)

DASY Configuration:

DASY52 52.8.1(838); SEMCAD X 14.6.5(6469)

Body/Body/Z Scan (1x1x21): Measurement grid: dx=20mm, dy=20mm, dz=5mm

[Info: Interpolated medium parameters used for SAR evaluation.](#)

Maximum value of Total (measured) = 21.06 V/m

Body/Body/Reference scan (41x91x1): Measurement grid: dx=30mm, dy=30mm

[Info: Interpolated medium parameters used for SAR evaluation.](#)

Maximum value of SAR (interpolated) = 1.97 mW/g

Body/Body/Area scan (71x71x1): Measurement grid: dx=15mm, dy=15mm

[Info: Interpolated medium parameters used for SAR evaluation.](#)

Maximum value of SAR (interpolated) = 1.56 mW/g

Body/Body/Zoom Scan (7x8x7)/Cube 0: Measurement grid: dx=5mm, dy=5mm, dz=5mm

DUT: Patient Monitor; Type: RAD7CA; Serial: E 1208400623

Reference Value = 26.550 V/m; Power Drift = 0.14 dB

Peak SAR (extrapolated) = 3.661 mW/g

SAR(1 g) = 1.46 mW/g; SAR(10 g) = 0.568 mW/g

[Info: Interpolated medium parameters used for SAR evaluation.](#)

Maximum value of SAR (measured) = 2.12 mW/g

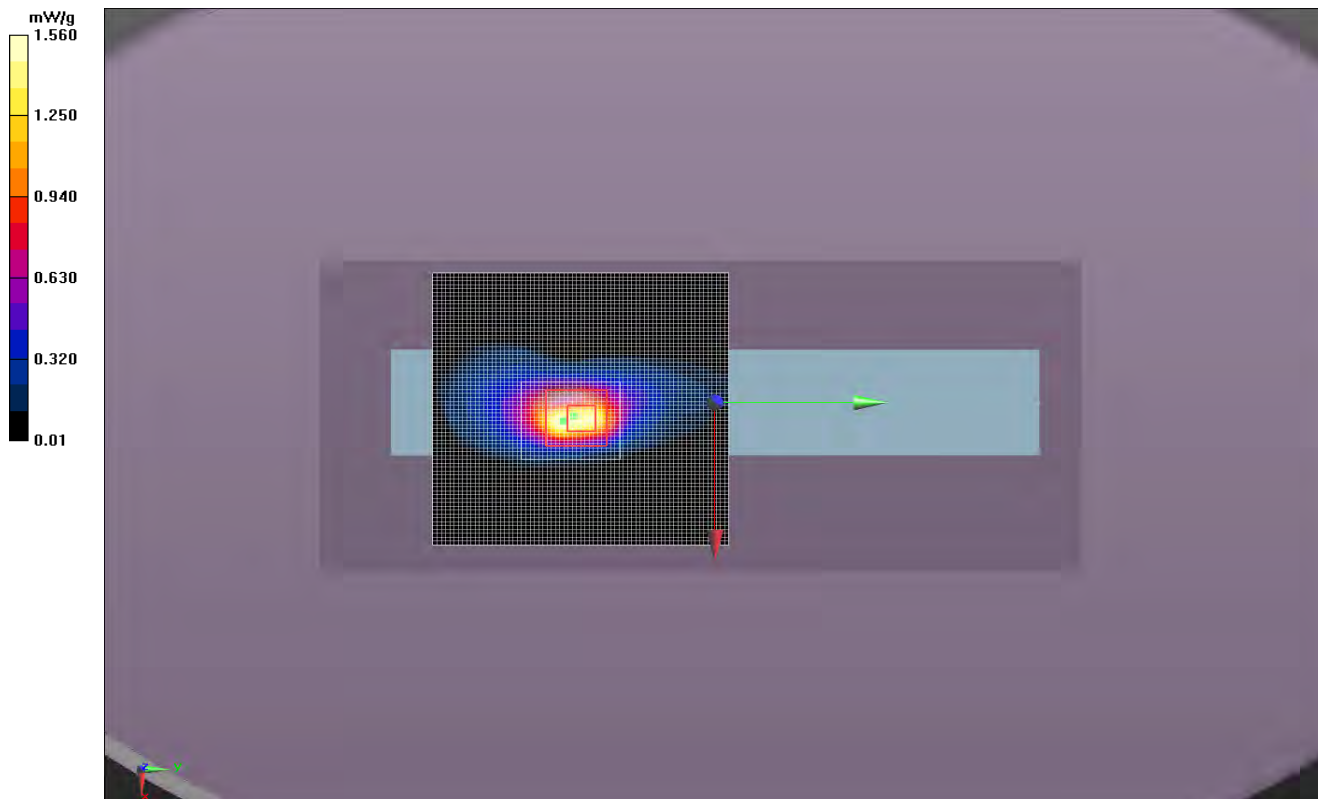

Room Temperature (°C):	22.3	Humidity (%):	37.2	Test Date:	05/09/12
Liquid Temperature (°C):	21.7	Barometric Pressure (mb):	1018	Tested by:	Ethan Schoonover

2450M Body Test 3c

DUT: Patient Monitor; Type: RAD7CA; Serial: E 1208400623

Communication System: CW; Communication System Band: D2450 (2450.0 MHz); Frequency: 2412 MHz; Communication System PAR: 0 dB; PMF: 1
 Medium parameters used: $\sigma = 0$ mho/m, $\epsilon_r = 1$; $\rho = 1000$ kg/m³, Medium parameters used (interpolated): $f = 2412$ MHz; $\sigma = 1.975$ mho/m; $\epsilon_r = 50.474$; $\rho = 1000$ kg/m³
 Phantom section: Flat Section
 Measurement Standard: DASYS5 (IEEE/IEC/ANSI C63.19-2007)

DASY Configuration:

DASY52 52.8.1(838); SEMCAD X 14.6.5(6469)

Body/Body/Z Scan (1x1x21): Measurement grid: dx=20mm, dy=20mm, dz=5mm

[Info: Interpolated medium parameters used for SAR evaluation.](#)

Maximum value of Total (measured) = 21.96 V/m

Body/Body/Reference scan (41x91x1): Measurement grid: dx=30mm, dy=30mm

[Info: Interpolated medium parameters used for SAR evaluation.](#)

Maximum value of SAR (interpolated) = 2.34 mW/g

Body/Body/Area scan (71x71x1): Measurement grid: dx=15mm, dy=15mm

[Info: Interpolated medium parameters used for SAR evaluation.](#)

Maximum value of SAR (interpolated) = 1.46 mW/g

Body/Body/Zoom Scan (8x8x7)/Cube 0: Measurement grid: dx=5mm, dy=5mm, dz=5mm

DUT: Patient Monitor; Type: RAD7CA; Serial: E 1208400623

Reference Value = 25.132 V/m; Power Drift = 0.16 dB

Peak SAR (extrapolated) = 4.103 mW/g

SAR(1 g) = 1.63 mW/g; SAR(10 g) = 0.630 mW/g

[Info: Interpolated medium parameters used for SAR evaluation.](#)

Maximum value of SAR (measured) = 2.14 mW/g

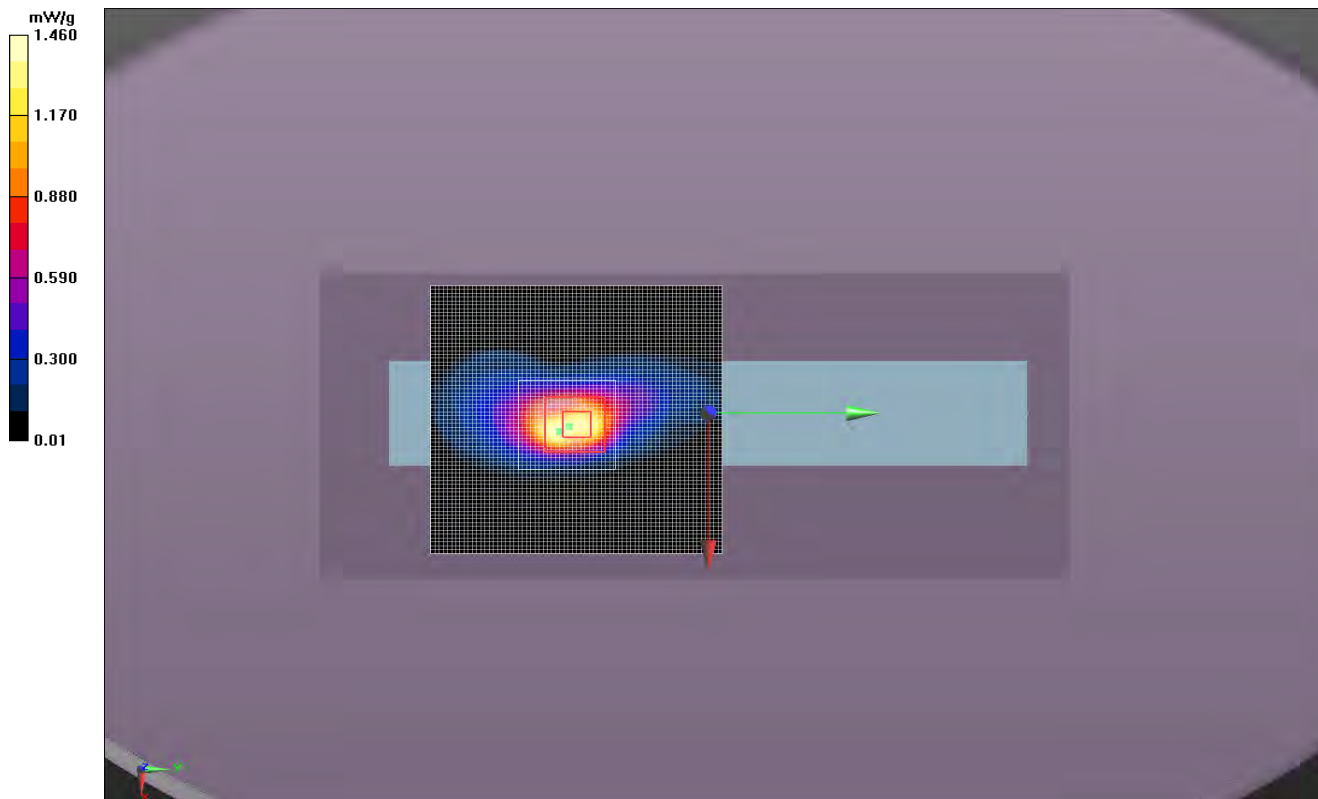

Room Temperature (°C):	20.8	Humidity (%):	39.6	Test Date:	05/09/12
Liquid Temperature (°C):	21	Barometric Pressure (mb):	1018	Tested by:	Rod Munro

2450M Body Test 4

DUT: Patient Monitor; Type: RAD7CA; Serial: E 1208400623

Communication System: CW; Communication System Band: D2450 (2450.0 MHz); Frequency: 2462 MHz; Communication System PAR: 0 dB; PMF: 1
 Medium parameters used: $\sigma = 0$ mho/m, $\epsilon_r = 1$; $\rho = 1000$ kg/m³, Medium parameters used (interpolated): $f = 2462$ MHz; $\sigma = 2.043$ mho/m; $\epsilon_r = 50.278$; $\rho = 1000$ kg/m³
 Phantom section: Flat Section
 Measurement Standard: DASYS5 (IEEE/IEC/ANSI C63.19-2007)

DASY Configuration:

DASY52 52.8.1(838); SEMCAD X 14.6.5(6469)

Body/Body/Z Scan (1x1x21): Measurement grid: dx=20mm, dy=20mm, dz=5mm

[Info: Interpolated medium parameters used for SAR evaluation.](#)

Maximum value of Total (measured) = 2.350 V/m

Body/Body/Reference scan (41x91x1): Measurement grid: dx=30mm, dy=30mm

[Info: Interpolated medium parameters used for SAR evaluation.](#)

Maximum value of SAR (interpolated) = 0.0232 mW/g

Body/Body/Area scan (71x71x1): Measurement grid: dx=15mm, dy=15mm

[Info: Interpolated medium parameters used for SAR evaluation.](#)

Maximum value of SAR (interpolated) = 0.0260 mW/g

Body/Body/Zoom Scan (8x7x7)/Cube 0: Measurement grid: dx=5mm, dy=5mm, dz=5mm

DUT: Patient Monitor; Type: RAD7CA; Serial: E 1208400623

Peak SAR (extrapolated) = 0.072 mW/g

SAR(1 g) = 0.020 mW/g; SAR(10 g) = 0.010 mW/g

[Info: Interpolated medium parameters used for SAR evaluation.](#)

Maximum value of SAR (measured) = 0.0720 mW/g

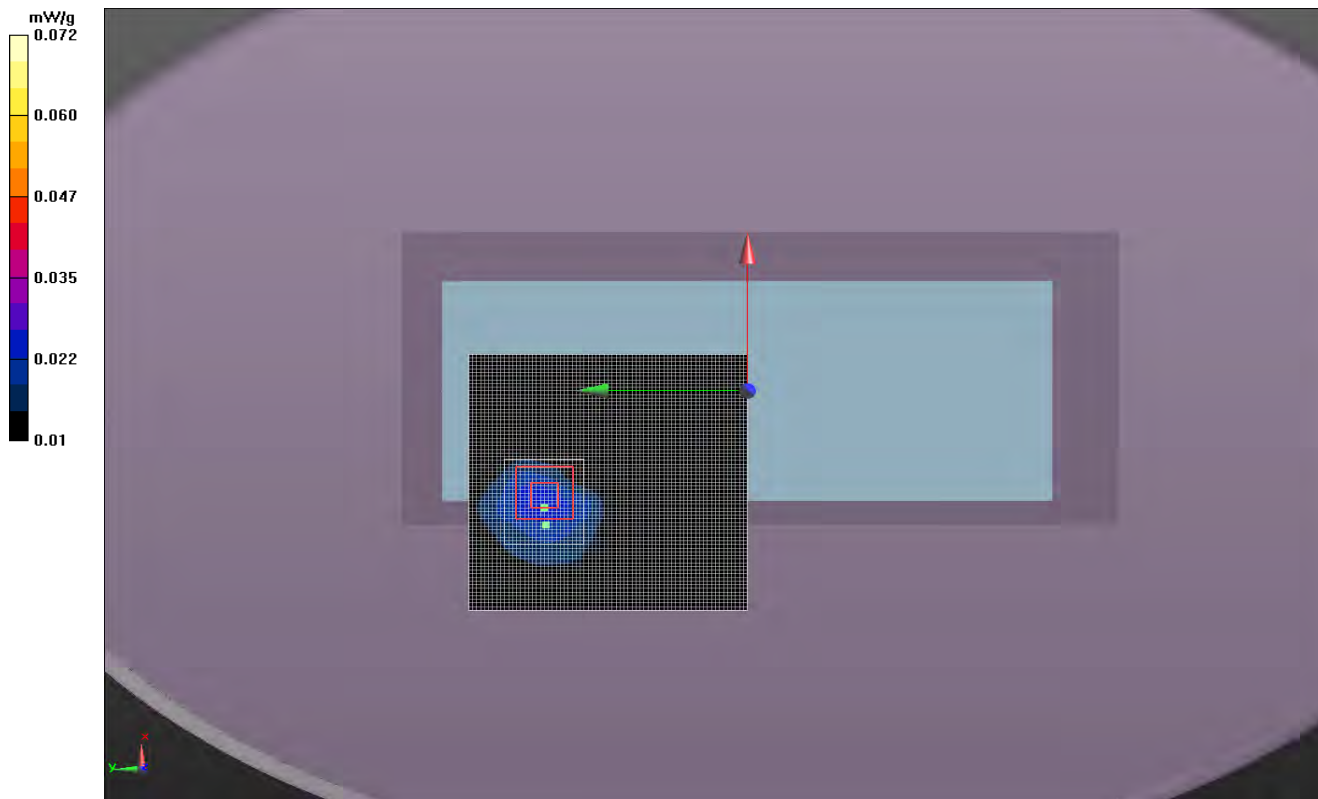

Room Temperature (°C):	23.5	Humidity (%):	39.3	Test Date:	05/09/12
Liquid Temperature (°C):	21.9	Barometric Pressure (mb):	1018	Tested by:	Ethan Schoonover

2450M Body Test 5

DUT: Patient Monitor; Type: RAD7CA; Serial: E 1208400623

Communication System: CW; Communication System Band: D2450 (2450.0 MHz); Frequency: 2462 MHz; Communication System PAR: 0 dB; PMF: 1
Medium parameters used (interpolated): $f = 2462$ MHz; $\sigma = 2.043$ mho/m; $\epsilon_r = 50.278$; $\rho = 1000$ kg/m³
Phantom section: Flat Section
Measurement Standard: DASYS (IEEE/IEC/ANSI C63.19-2007)

DASY Configuration:

DASY52 52.8.1(838); SEMCAD X 14.6.5(6469)

Body/Body/Reference scan (41x91x1): Measurement grid: dx=30mm, dy=30mm

[Info: Interpolated medium parameters used for SAR evaluation.](#)

Maximum value of SAR (interpolated) = 0.0139 mW/g

Body/Body/Area scan (71x71x1): Measurement grid: dx=15mm, dy=15mm

[Info: Interpolated medium parameters used for SAR evaluation.](#)

Maximum value of SAR (interpolated) = 0.0247 mW/g

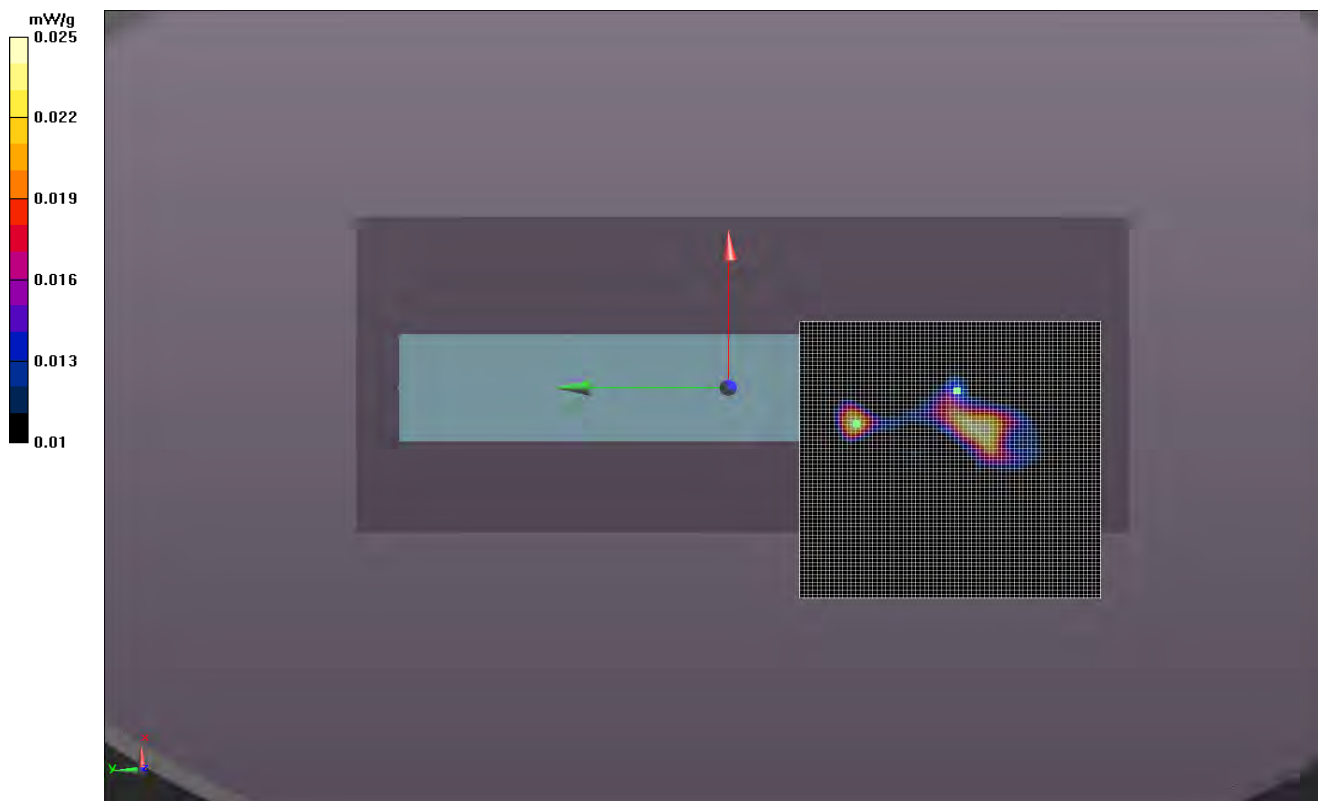

Room Temperature (°C):	22.7	Humidity (%):	36.6	Test Date:	05/09/12
Liquid Temperature (°C):	21.8	Barometric Pressure (mb):	1018	Tested by:	Ethan Schoonover

2450M Body Test 6

DUT: Patient Monitor; Type: RAD7CA; Serial: E 1208400623

Communication System: CW; Communication System Band: D2450 (2450.0 MHz); Frequency: 2462 MHz; Communication System PAR: 0 dB; PMF: 1
 Medium parameters used: $\sigma = 0$ mho/m, $\epsilon_r = 1$; $\rho = 1000$ kg/m³, Medium parameters used (interpolated): $f = 2462$ MHz; $\sigma = 2.043$ mho/m; $\epsilon_r = 50.278$; $\rho = 1000$ kg/m³
 Phantom section: Flat Section
 Measurement Standard: DASYS (IEEE/IEC/ANSI C63.19-2007)

DASY Configuration:

DASY52 52.8.1(838); SEMCAD X 14.6.5(6469)

Body/Body/Z Scan (1x1x21): Measurement grid: dx=20mm, dy=20mm, dz=5mm

[Info: Interpolated medium parameters used for SAR evaluation.](#)

Maximum value of Total (measured) = 12.21 V/m

Body/Body/Reference scan (41x91x1): Measurement grid: dx=30mm, dy=30mm

[Info: Interpolated medium parameters used for SAR evaluation.](#)

Maximum value of SAR (interpolated) = 0.402 mW/g

Body/Body/Area scan (71x71x1): Measurement grid: dx=15mm, dy=15mm

[Info: Interpolated medium parameters used for SAR evaluation.](#)

Maximum value of SAR (interpolated) = 0.481 mW/g

Body/Body/Zoom Scan (7x7x7)/Cube 0: Measurement grid: dx=5mm, dy=5mm, dz=5mm

DUT: Patient Monitor; Type: RAD7CA; Serial: E 1208400623

Reference Value = 14.553 V/m; Power Drift = 0.12 dB

Peak SAR (extrapolated) = 0.975 mW/g

SAR(1 g) = 0.466 mW/g; SAR(10 g) = 0.207 mW/g

[Info: Interpolated medium parameters used for SAR evaluation.](#)

Maximum value of SAR (measured) = 0.593 mW/g

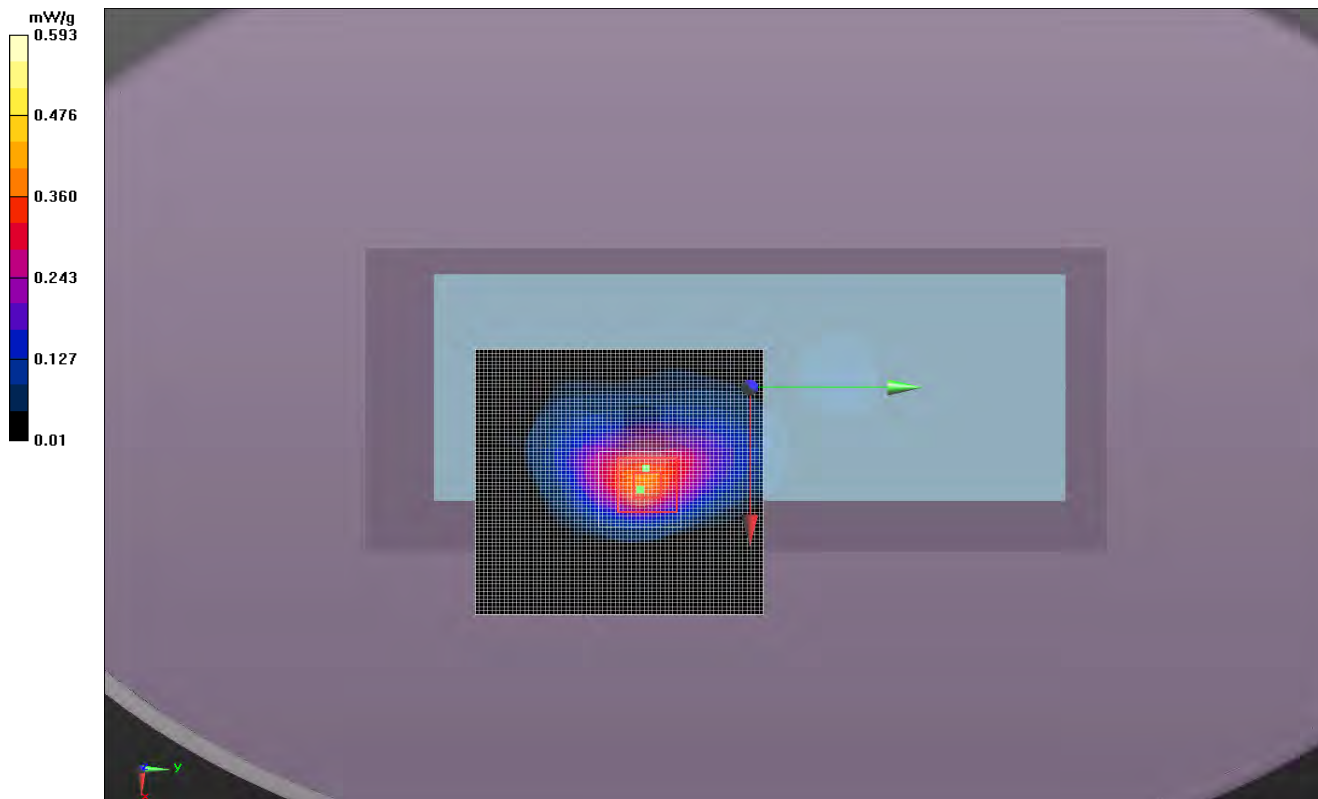

Room Temperature (°C):	23.5	Humidity (%):	34.3	Test Date:	05/09/12
Liquid Temperature (°C):	21.9	Barometric Pressure (mb):	1018	Tested by:	Ethan Schoonover

2450M Body Test 7

DUT: Patient Monitor; Type: RAD7CA; Serial: E 1208400623

Communication System: CW; Communication System Band: D2450 (2450.0 MHz); Frequency: 2462 MHz; Communication System PAR: 0 dB; PMF: 1
 Medium parameters used: $\sigma = 0$ mho/m, $\epsilon_r = 1$; $\rho = 1000$ kg/m³, Medium parameters used (interpolated): $f = 2462$ MHz; $\sigma = 2.043$ mho/m; $\epsilon_r = 50.278$; $\rho = 1000$ kg/m³
 Phantom section: Flat Section
 Measurement Standard: DASYS5 (IEEE/IEC/ANSI C63.19-2007)

DASY Configuration:

DASY52 52.8.1(838); SEMCAD X 14.6.5(6469)

Body/Body/Z Scan (1x1x21): Measurement grid: dx=20mm, dy=20mm, dz=5mm

[Info: Interpolated medium parameters used for SAR evaluation.](#)

Maximum value of Total (measured) = 22.91 V/m

Body/Body/Reference scan (41x91x1): Measurement grid: dx=30mm, dy=30mm

[Info: Interpolated medium parameters used for SAR evaluation.](#)

Maximum value of SAR (interpolated) = 0.502 mW/g

Body/Body/Area scan (71x71x1): Measurement grid: dx=15mm, dy=15mm

[Info: Interpolated medium parameters used for SAR evaluation.](#)

Maximum value of SAR (interpolated) = 2.29 mW/g

Body/Body/Zoom Scan (8x8x7)/Cube 0: Measurement grid: dx=5mm, dy=5mm, dz=5mm

DUT: Patient Monitor; Type: RAD7CA; Serial: E 1208400623

Reference Value = 33.222 V/m; Power Drift = 0.19 dB

Peak SAR (extrapolated) = 5.425 mW/g

SAR(1 g) = 2.15 mW/g; SAR(10 g) = 0.838 mW/g

[Info: Interpolated medium parameters used for SAR evaluation.](#)

Maximum value of SAR (measured) = 2.86 mW/g

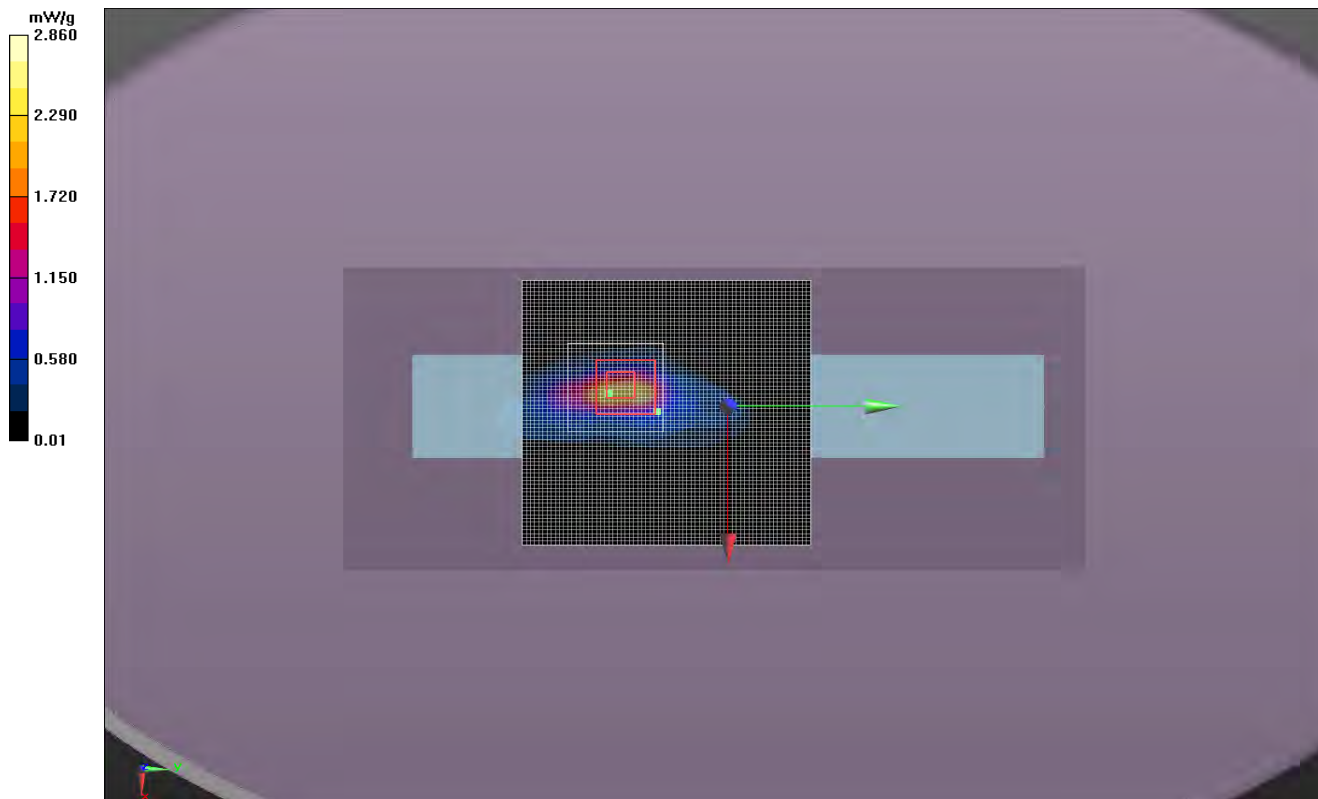

Room Temperature (°C):	24.3	Humidity (%):	36.1	Test Date:	05/09/12
Liquid Temperature (°C):	21.4	Barometric Pressure (mb):	1018	Tested by:	Rod Munro

2450M Body Test 7b

DUT: Patient Monitor; Type: RAD7CA; Serial: E 1208400623

Communication System: CW; Communication System Band: D2450 (2450.0 MHz); Frequency: 2412 MHz; Communication System PAR: 0 dB; PMF: 1
 Medium parameters used: $\sigma = 0$ mho/m, $\epsilon_r = 1$; $\rho = 1000$ kg/m³, Medium parameters used (interpolated): $f = 2412$ MHz; $\sigma = 1.975$ mho/m; $\epsilon_r = 50.474$; $\rho = 1000$ kg/m³
 Phantom section: Flat Section
 Measurement Standard: DASYS5 (IEEE/IEC/ANSI C63.19-2007)

DASY Configuration:

DASY52 52.8.1(838); SEMCAD X 14.6.5(6469)

Body/Body/Z Scan (1x1x21): Measurement grid: dx=20mm, dy=20mm, dz=5mm

[Info: Interpolated medium parameters used for SAR evaluation.](#)

Maximum value of Total (measured) = 22.68 V/m

Body/Body/Reference scan (41x91x1): Measurement grid: dx=30mm, dy=30mm

[Info: Interpolated medium parameters used for SAR evaluation.](#)

Maximum value of SAR (interpolated) = 0.363 mW/g

Body/Body/Area scan (71x71x1): Measurement grid: dx=15mm, dy=15mm

[Info: Interpolated medium parameters used for SAR evaluation.](#)

Maximum value of SAR (interpolated) = 1.51 mW/g

Body/Body/Zoom Scan (7x7x7)/Cube 0: Measurement grid: dx=5mm, dy=5mm, dz=5mm

DUT: Patient Monitor; Type: RAD7CA; Serial: E 1208400623

Reference Value = 25.851 V/m; Power Drift = 0.11 dB

Peak SAR (extrapolated) = 4.541 mW/g

SAR(1 g) = 1.77 mW/g; SAR(10 g) = 0.685 mW/g

[Info: Interpolated medium parameters used for SAR evaluation.](#)

Maximum value of SAR (measured) = 2.37 mW/g

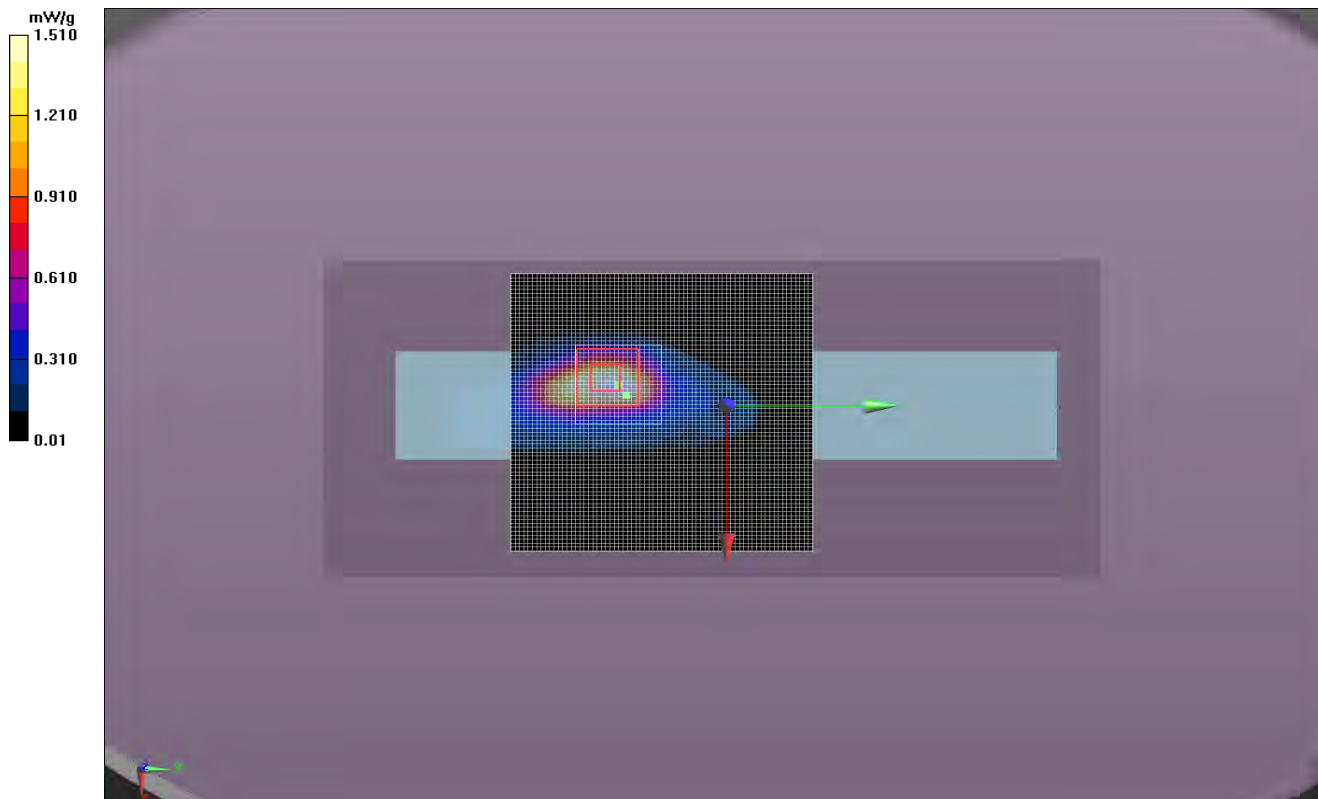

Room Temperature (°C):	24.3	Humidity (%):	36.1	Test Date:	05/09/12
Liquid Temperature (°C):	21.4	Barometric Pressure (mb):	1018	Tested by:	Rod Munro

2450M Body Test 7c

DUT: Patient Monitor; Type: RAD7CA; Serial: E 1208400623

Communication System: CW; Communication System Band: D2450 (2450.0 MHz); Frequency: 2437 MHz; Communication System PAR: 0 dB; PMF: 1
 Medium parameters used: $\sigma = 0$ mho/m, $\epsilon_r = 1$; $\rho = 1000$ kg/m³, Medium parameters used (interpolated): $f = 2437$ MHz; $\sigma = 2.009$ mho/m; $\epsilon_r = 50.379$; $\rho = 1000$ kg/m³
 Phantom section: Flat Section
 Measurement Standard: DASYS5 (IEEE/IEC/ANSI C63.19-2007)

DASY Configuration:

DASY52 52.8.1(838); SEMCAD X 14.6.5(6469)

Body/Body/Z Scan (1x1x21): Measurement grid: dx=20mm, dy=20mm, dz=5mm

[Info: Interpolated medium parameters used for SAR evaluation.](#)

Maximum value of Total (measured) = 22.68 V/m

Body/Body/Reference scan (41x91x1): Measurement grid: dx=30mm, dy=30mm

[Info: Interpolated medium parameters used for SAR evaluation.](#)

Maximum value of SAR (interpolated) = 0.360 mW/g

Body/Body/Area scan (71x71x1): Measurement grid: dx=15mm, dy=15mm

[Info: Interpolated medium parameters used for SAR evaluation.](#)

Maximum value of SAR (interpolated) = 1.83 mW/g

Body/Body/Zoom Scan (7x7x7)/Cube 0: Measurement grid: dx=5mm, dy=5mm, dz=5mm

DUT: Patient Monitor; Type: RAD7CA; Serial: E 1208400623

Reference Value = 30.362 V/m; Power Drift = 0.24 dB

Peak SAR (extrapolated) = 5.173 mW/g

SAR(1 g) = 1.95 mW/g; SAR(10 g) = 0.745 mW/g

[Info: Interpolated medium parameters used for SAR evaluation.](#)

Maximum value of SAR (measured) = 2.68 mW/g

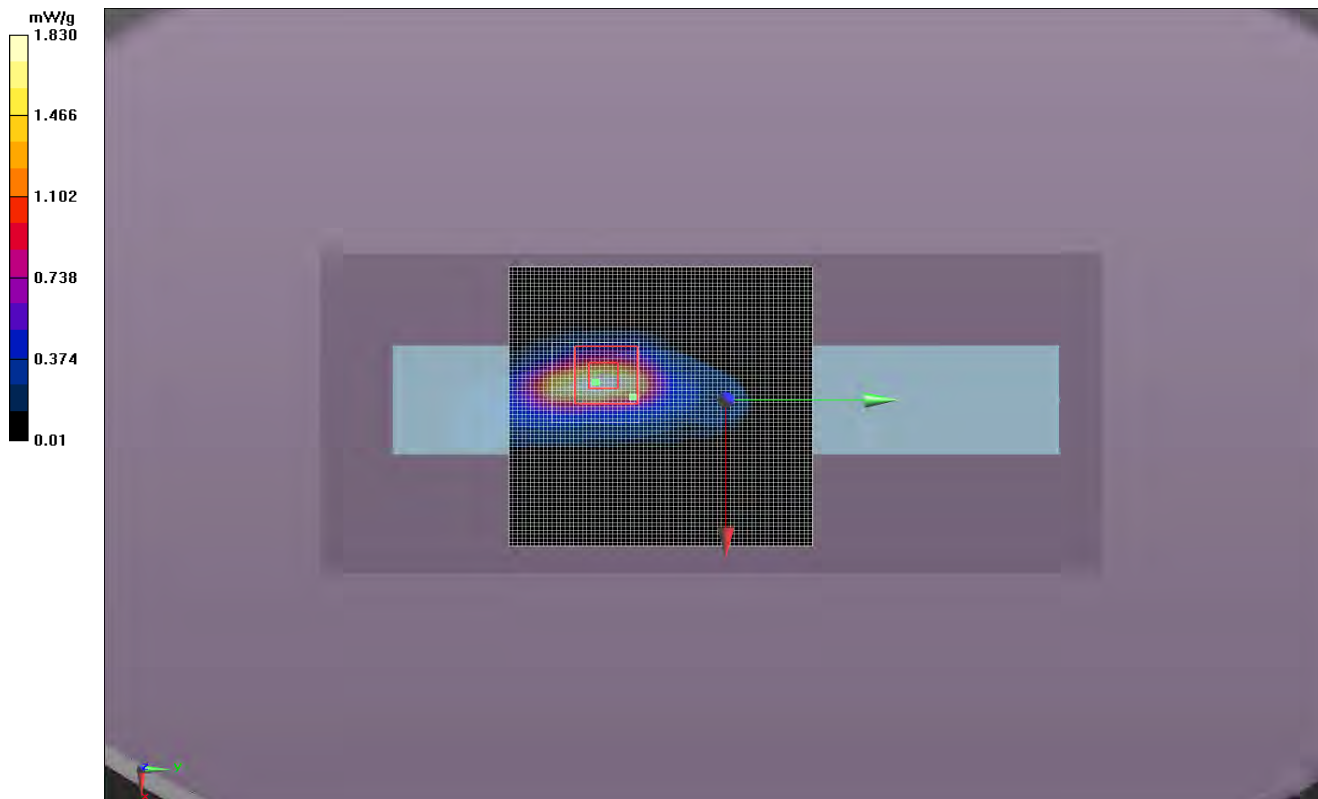

Room Temperature (°C):	22.7	Humidity (%):	36.6	Test Date:	05/09/12
Liquid Temperature (°C):	21.8	Barometric Pressure (mb):	1018	Tested by:	Ethan Schoonover

2450M Body Test 8

DUT: Patient Monitor; Type: RAD7CA; Serial: E 1208400623

Communication System: CW; Communication System Band: D2450 (2450.0 MHz); Frequency: 2462 MHz; Communication System PAR: 0 dB; PMF: 1
Medium parameters used (interpolated): $f = 2462$ MHz; $\sigma = 2.043$ mho/m; $\epsilon_r = 50.278$; $\rho = 1000$ kg/m³
Phantom section: Flat Section
Measurement Standard: DASYS (IEEE/IEC/ANSI C63.19-2007)

DASY Configuration:

DASY52 52.8.1(838); SEMCAD X 14.6.5(6469)

Body/Body/Reference scan (41x91x1): Measurement grid: dx=30mm, dy=30mm

[Info: Interpolated medium parameters used for SAR evaluation.](#)

Maximum value of SAR (interpolated) = 0.0709 mW/g

Body/Body/Area scan (71x71x1): Measurement grid: dx=15mm, dy=15mm

[Info: Interpolated medium parameters used for SAR evaluation.](#)

Maximum value of SAR (interpolated) = 0.0600 mW/g

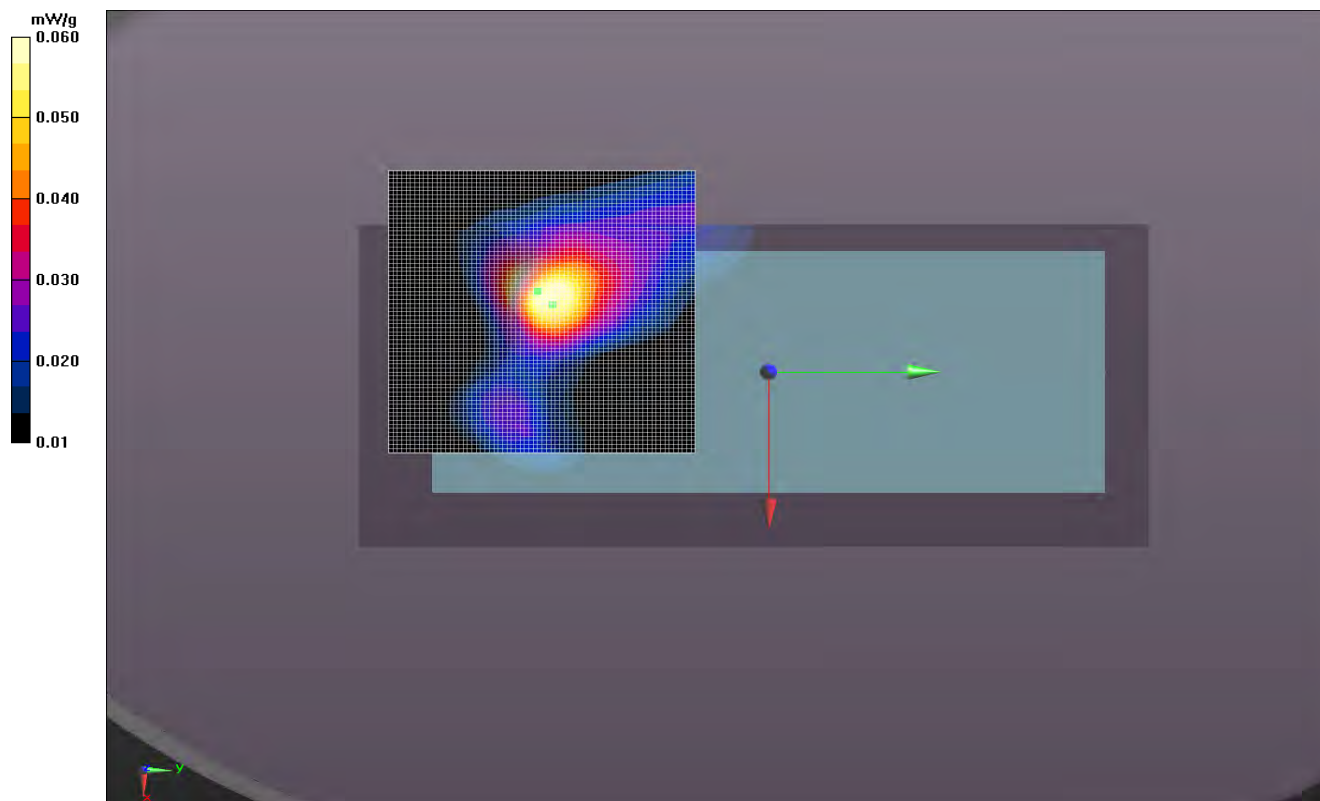



EMC

SAR TEST DATA

Room Temperature (°C):	23.5	Humidity (%):	34.3	Test Date:	05/09/12
Liquid Temperature (°C):	21.9	Barometric Pressure (mb):	1018	Tested by:	Ethan Schoonover

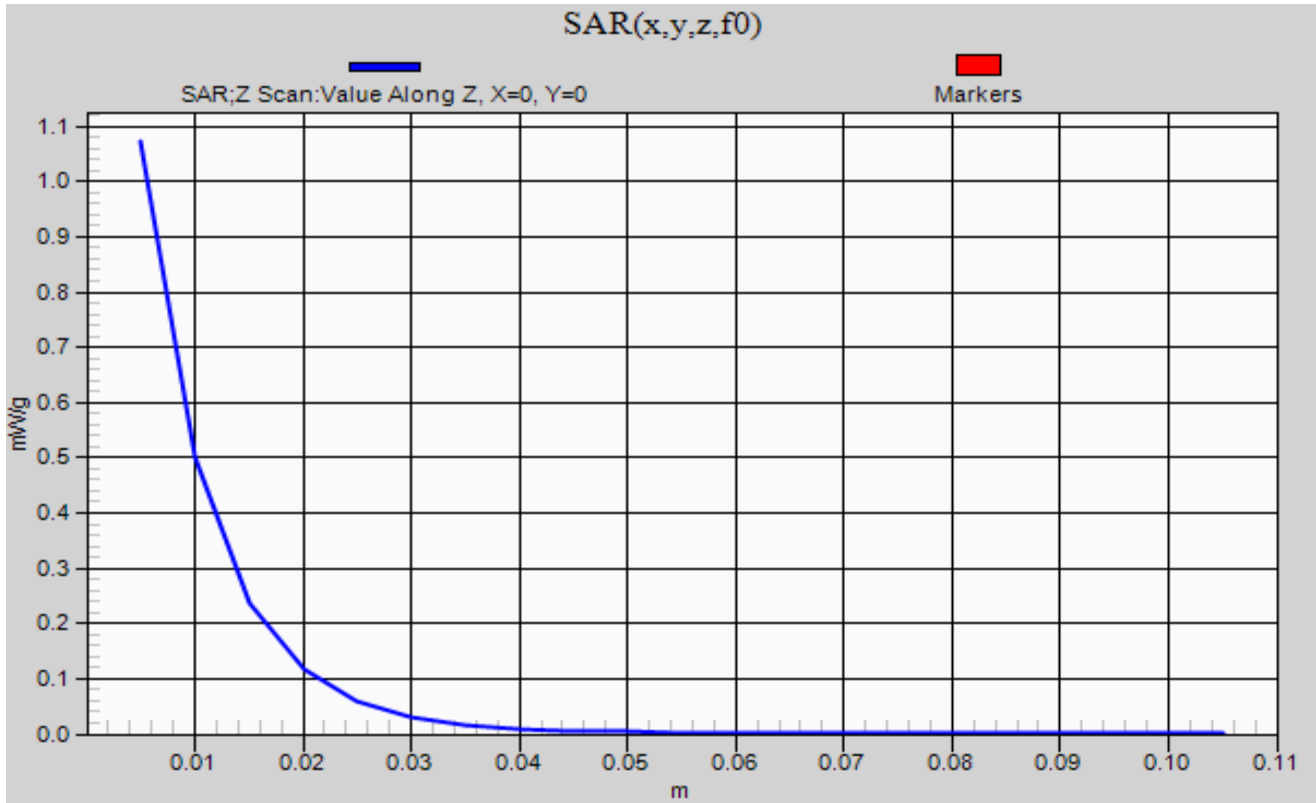
Body Test # 7



NORTHWEST EMC		SAR TEST DATA		SAR 2012.02.08
EUT:	RAD7CA	Work Order:	MASI0103	
Serial Number:	E 1208400623	Date:	See Data Sheets	
Customer:	Masimo Corporation	Temperature:	See Data Sheets	
Attendees:	None	Humidity:	See Data Sheets	
Project:	None	Barometric Pres.:	See Data Sheets	
Tested by:	Ethan Schoonover	Job Site:	EV08	
TEST SPECIFICATIONS		Test Method		
FCC 2.1093:2011	FCC OET 65C:2001			
FCC 15.247:2011	IEEE Std 1528:2003			
FCC 15.407:2001	FCC KDB 447498 D01 v04			
Health Safety Code 6:2009	FCC KDB 248227 D01 V01r02			
	FCC KDB 865664			
	RSS-102, Issue 4:2010			
COMMENTS				
No body worn holsters, pouches, or lanyards. Tested at 0cm spacing				
DEVIATIONS FROM TEST STANDARD				
No Deviations				
Configuration #	1	Signature 		

Test Configuration	Frequency Band	Transmit Frequency (MHz)	Transmit Channel	Data Rate (Mbps)	Transmit Mode	Accessory	EUT Position	SAR Drift During Test (dB)	Measured 1g SAR Level (mW/g)	Duty Cycle (%)	Scale Factor	Test #
Body - Antenna 1	2450	2412	1	1	BPSK	Patient Leads	Left	0.16	1.63	100	0.00	3c
	2450	2412	1	1	BPSK	Patient Leads	Left	0.03	0.91	50	0.56	3g
	2450	2412	1	1	BPSK	Patient Leads	Left	0.21	0.608	30	0.37	3f
Body - Antenna 2	2450	2462	11	1	BPSK	Patient Leads	Right	0.19	2.15	100	0.00	7
	2450	2462	11	1	BPSK	Patient Leads	Right	-0.25	1.24	50	0.58	7d
	2450	2462	11	1	BPSK	Patient Leads	Right	-0.23	0.625	30	0.29	7e

Scale Factor for 6% Duty Cycle 0.07

Per KDB 248227, the linear scaling of the duty factor was verified by measuring in the high SAR region at 100%, 50%, and 30% (25% not achievable with the test software). The results show a linear reduction in SAR that corresponds to the duty cycle that was tested. Since the values were slightly higher than the duty cycle, a Scale factor of 0.07 was chosen for a 6% duty cycle.

Room Temperature (°C):	22.3	Humidity (%):	37.2	Test Date:	05/09/12
Liquid Temperature (°C):	21.7	Barometric Pressure (mb):	1018	Tested by:	Ethan Schoonover

2450M Body Test 3c

DUT: Patient Monitor; Type: RAD7CA; Serial: E 1208400623

Communication System: CW; Communication System Band: D2450 (2450.0 MHz); Frequency: 2412 MHz; Communication System PAR: 0 dB; PMF: 1
 Medium parameters used: $\sigma = 0$ mho/m, $\epsilon_r = 1$; $\rho = 1000$ kg/m³, Medium parameters used (interpolated): $f = 2412$ MHz; $\sigma = 1.975$ mho/m; $\epsilon_r = 50.474$; $\rho = 1000$ kg/m³
 Phantom section: Flat Section
 Measurement Standard: DASYS5 (IEEE/IEC/ANSI C63.19-2007)

DASY Configuration:

DASY52 52.8.1(838); SEMCAD X 14.6.5(6469)

Body/Body/Z Scan (1x1x21): Measurement grid: dx=20mm, dy=20mm, dz=5mm

[Info: Interpolated medium parameters used for SAR evaluation.](#)

Maximum value of Total (measured) = 21.96 V/m

Body/Body/Reference scan (41x91x1): Measurement grid: dx=30mm, dy=30mm

[Info: Interpolated medium parameters used for SAR evaluation.](#)

Maximum value of SAR (interpolated) = 2.34 mW/g

Body/Body/Area scan (71x71x1): Measurement grid: dx=15mm, dy=15mm

[Info: Interpolated medium parameters used for SAR evaluation.](#)

Maximum value of SAR (interpolated) = 1.46 mW/g

Body/Body/Zoom Scan (8x8x7)/Cube 0: Measurement grid: dx=5mm, dy=5mm, dz=5mm

DUT: Patient Monitor; Type: RAD7CA; Serial: E 1208400623

Reference Value = 25.132 V/m; Power Drift = 0.16 dB

Peak SAR (extrapolated) = 4.103 mW/g

SAR(1 g) = 1.63 mW/g; SAR(10 g) = 0.630 mW/g

[Info: Interpolated medium parameters used for SAR evaluation.](#)

Maximum value of SAR (measured) = 2.14 mW/g

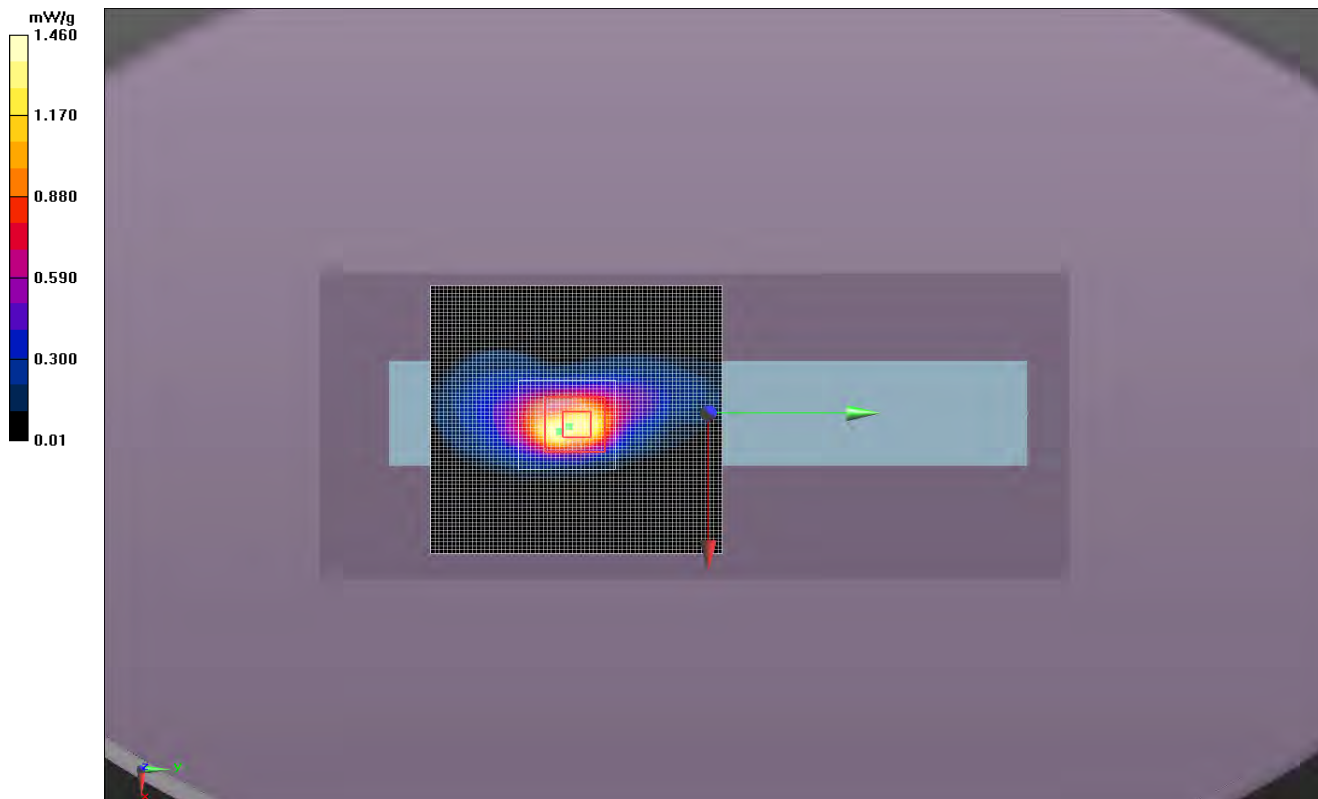

Room Temperature (°C):	23.7	Humidity (%):	39.6	Test Date:	05/21/12
Liquid Temperature (°C):	22.9	Barometric Pressure (mb):	1012	Tested by:	Ethan Schoonover

2450M Body Test 3g

DUT: Patient Monitor; Type: RAD7CA; Serial: E 1208400623

Communication System: CW; Communication System Band: D2450 (2450.0 MHz); Frequency: 2412 MHz; Communication System PAR: 0 dB; PMF: 1
 Medium parameters used: $\sigma = 0$ mho/m, $\epsilon_r = 1$; $\rho = 1000$ kg/m³, Medium parameters used (interpolated): $f = 2412$ MHz; $\sigma = 1.839$ mho/m; $\epsilon_r = 51.461$; $\rho = 1000$ kg/m³
 Phantom section: Flat Section
 Measurement Standard: DASYS (IEEE/IEC/ANSI C63.19-2007)

DASY Configuration:

DASY52 52.8.1(838); SEMCAD X 14.6.5(6469)

Body/Body/Z Scan (1x1x21): Measurement grid: dx=20mm, dy=20mm, dz=5mm

[Info: Interpolated medium parameters used for SAR evaluation.](#)

Maximum value of Total (measured) = 17.85 V/m

Body/Body/Reference scan (41x91x1): Measurement grid: dx=30mm, dy=30mm

[Info: Interpolated medium parameters used for SAR evaluation.](#)

Maximum value of SAR (interpolated) = 0.983 mW/g

Body/Body/Area scan (71x71x1): Measurement grid: dx=15mm, dy=15mm

[Info: Interpolated medium parameters used for SAR evaluation.](#)

Maximum value of SAR (interpolated) = 1.36 mW/g

Body/Body/Zoom Scan (7x7x7)/Cube 0: Measurement grid: dx=5mm, dy=5mm, dz=5mm

Reference Value = 26.561 V/m; Power Drift = 0.03 dB

Peak SAR (extrapolated) = 2.215 mW/g

SAR(1 g) = 0.910 mW/g; SAR(10 g) = 0.363 mW/g

[Info: Interpolated medium parameters used for SAR evaluation.](#)

Maximum value of SAR (measured) = 1.33 mW/g

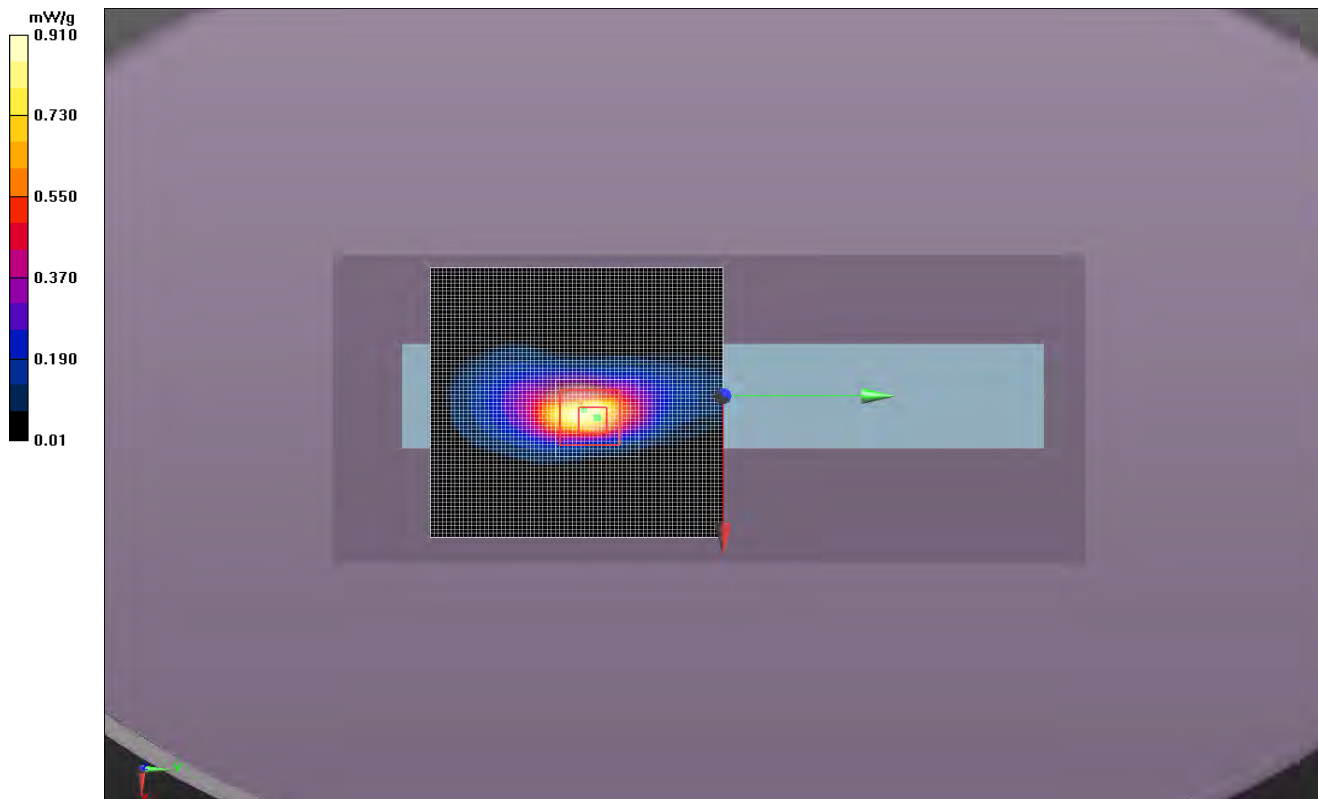

Room Temperature (°C):	23.7	Humidity (%):	39.6	Test Date:	05/21/12
Liquid Temperature (°C):	22.9	Barometric Pressure (mb):	1012	Tested by:	Ethan Schoonover

2450M Body Test 3f

DUT: Patient Monitor; Type: RAD7CA; Serial: E 1208400623

Communication System: CW; Communication System Band: D2450 (2450.0 MHz); Frequency: 2412 MHz; Communication System PAR: 0 dB; PMF: 1
 Medium parameters used: $\sigma = 0$ mho/m, $\epsilon_r = 1$; $\rho = 1000$ kg/m³, Medium parameters used (interpolated): $f = 2412$ MHz; $\sigma = 1.839$ mho/m; $\epsilon_r = 51.461$; $\rho = 1000$ kg/m³
 Phantom section: Flat Section
 Measurement Standard: DASYS5 (IEEE/IEC/ANSI C63.19-2007)

DASY Configuration:

DASY52 52.8.1(838); SEMCAD X 14.6.5(6469)

Body/Body/Z Scan (1x1x21): Measurement grid: dx=20mm, dy=20mm, dz=5mm

[Info: Interpolated medium parameters used for SAR evaluation.](#)

Maximum value of Total (measured) = 14.77 V/m

Body/Body/Reference scan (41x91x1): Measurement grid: dx=30mm, dy=30mm

[Info: Interpolated medium parameters used for SAR evaluation.](#)

Maximum value of SAR (interpolated) = 0.856 mW/g

Body/Body/Area scan (71x71x1): Measurement grid: dx=15mm, dy=15mm

[Info: Interpolated medium parameters used for SAR evaluation.](#)

Maximum value of SAR (interpolated) = 0.531 mW/g

Body/Body/Zoom Scan (7x7x7)/Cube 0: Measurement grid: dx=5mm, dy=5mm, dz=5mm

Reference Value = 14.615 V/m; Power Drift = 0.21 dB

Peak SAR (extrapolated) = 1.489 mW/g

SAR(1 g) = 0.608 mW/g; SAR(10 g) = 0.238 mW/g

[Info: Interpolated medium parameters used for SAR evaluation.](#)

Maximum value of SAR (measured) = 0.835 mW/g

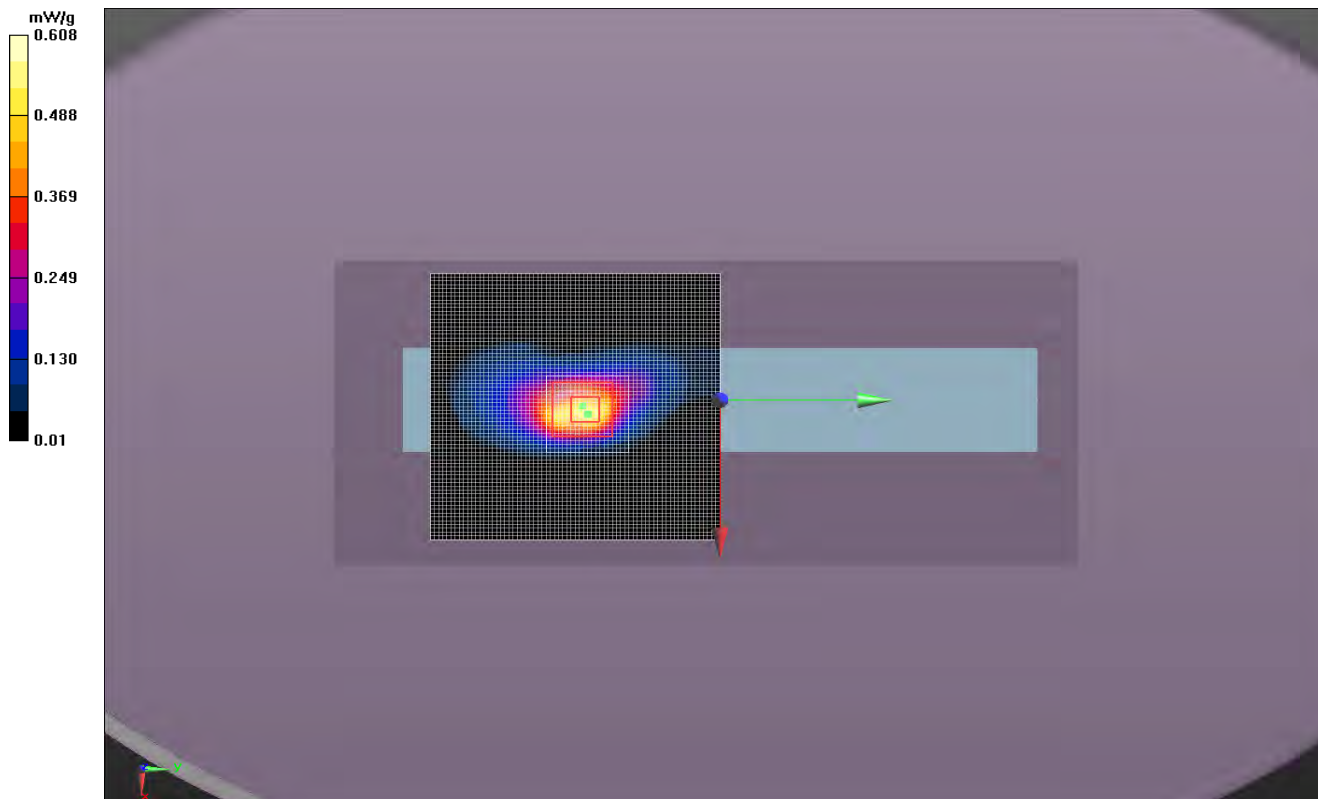

Room Temperature (°C):	23.5	Humidity (%):	34.3	Test Date:	05/09/12
Liquid Temperature (°C):	21.9	Barometric Pressure (mb):	1018	Tested by:	Ethan Schoonover

2450M Body Test 7

DUT: Patient Monitor; Type: RAD7CA; Serial: E 1208400623

Communication System: CW; Communication System Band: D2450 (2450.0 MHz); Frequency: 2462 MHz; Communication System PAR: 0 dB; PMF: 1
 Medium parameters used: $\sigma = 0$ mho/m, $\epsilon_r = 1$; $\rho = 1000$ kg/m³, Medium parameters used (interpolated): $f = 2462$ MHz; $\sigma = 2.043$ mho/m; $\epsilon_r = 50.278$; $\rho = 1000$ kg/m³
 Phantom section: Flat Section
 Measurement Standard: DASYS5 (IEEE/IEC/ANSI C63.19-2007)

DASY Configuration:

DASY52 52.8.1(838); SEMCAD X 14.6.5(6469)

Body/Body/Z Scan (1x1x21): Measurement grid: dx=20mm, dy=20mm, dz=5mm

[Info: Interpolated medium parameters used for SAR evaluation.](#)

Maximum value of Total (measured) = 22.91 V/m

Body/Body/Reference scan (41x91x1): Measurement grid: dx=30mm, dy=30mm

[Info: Interpolated medium parameters used for SAR evaluation.](#)

Maximum value of SAR (interpolated) = 0.502 mW/g

Body/Body/Area scan (71x71x1): Measurement grid: dx=15mm, dy=15mm

[Info: Interpolated medium parameters used for SAR evaluation.](#)

Maximum value of SAR (interpolated) = 2.29 mW/g

Body/Body/Zoom Scan (8x8x7)/Cube 0: Measurement grid: dx=5mm, dy=5mm, dz=5mm

DUT: Patient Monitor; Type: RAD7CA; Serial: E 1208400623

Reference Value = 33.222 V/m; Power Drift = 0.19 dB

Peak SAR (extrapolated) = 5.425 mW/g

SAR(1 g) = 2.15 mW/g; SAR(10 g) = 0.838 mW/g

[Info: Interpolated medium parameters used for SAR evaluation.](#)

Maximum value of SAR (measured) = 2.86 mW/g

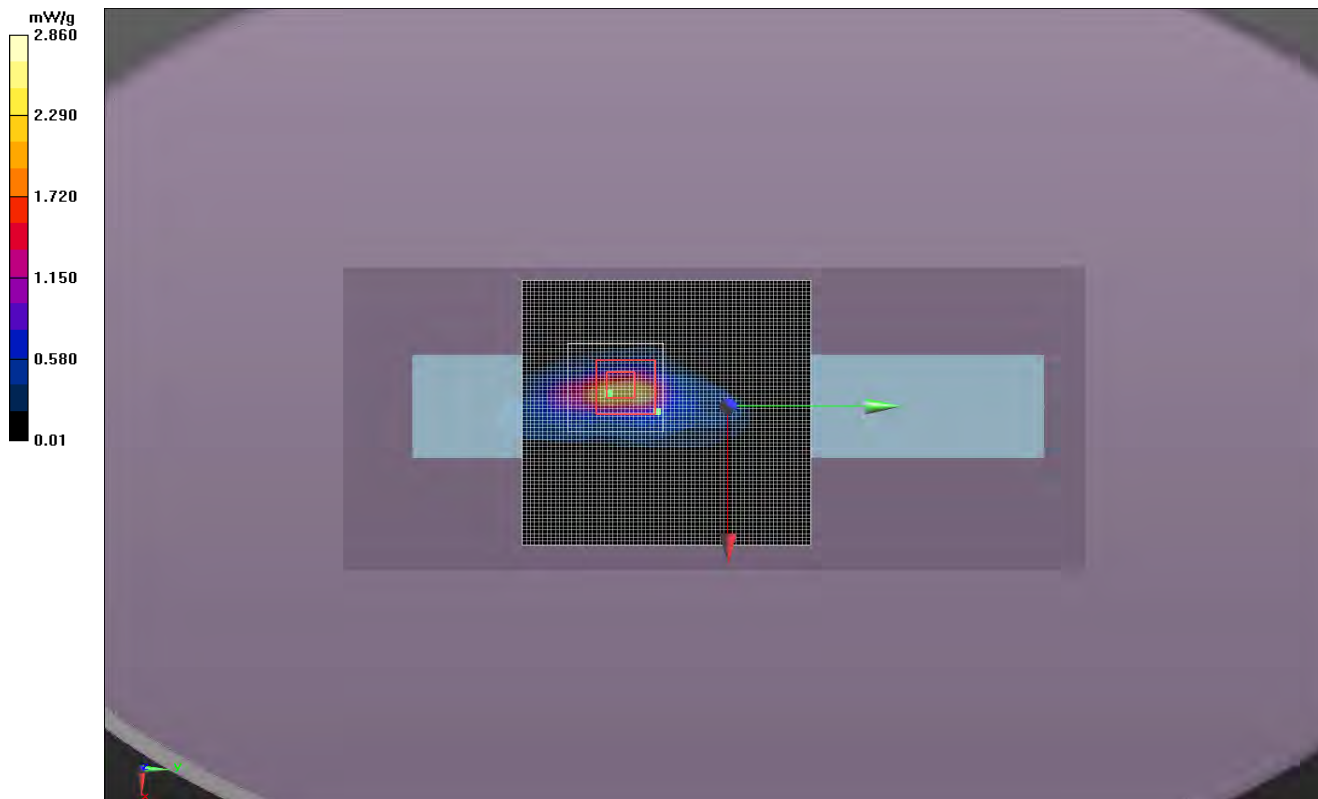

Room Temperature (°C):	23.7	Humidity (%):	39.6	Test Date:	05/21/12
Liquid Temperature (°C):	22.9	Barometric Pressure (mb):	1012	Tested by:	Ethan Schoonover

2450M Body Test 7d

DUT: Patient Monitor; Type: RAD7CA; Serial: E 1208400623

Communication System: CW; Communication System Band: D2450 (2450.0 MHz); Frequency: 2462 MHz; Communication System PAR: 0 dB; PMF: 1
 Medium parameters used: $\sigma = 0$ mho/m, $\epsilon_r = 1$; $\rho = 1000$ kg/m³, Medium parameters used (interpolated): $f = 2462$ MHz; $\sigma = 1.936$ mho/m; $\epsilon_r = 50.907$; $\rho = 1000$ kg/m³
 Phantom section: Flat Section
 Measurement Standard: DASYS (IEEE/IEC/ANSI C63.19-2007)

DASY Configuration:

DASY52 52.8.1(838); SEMCAD X 14.6.5(6469)

Body/Body/Z Scan (1x1x21): Measurement grid: dx=20mm, dy=20mm, dz=5mm

[Info: Interpolated medium parameters used for SAR evaluation.](#)

Maximum value of Total (measured) = 20.17 V/m

Body/Body/Reference scan (41x91x1): Measurement grid: dx=30mm, dy=30mm

[Info: Interpolated medium parameters used for SAR evaluation.](#)

Maximum value of SAR (interpolated) = 0.443 mW/g

Body/Body/Area scan (71x71x1): Measurement grid: dx=15mm, dy=15mm

[Info: Interpolated medium parameters used for SAR evaluation.](#)

Maximum value of SAR (interpolated) = 1.34 mW/g

Body/Body/Zoom Scan (7x7x7)/Cube 0: Measurement grid: dx=5mm, dy=5mm, dz=5mm

Reference Value = 21.623 V/m; Power Drift = -0.25 dB

Peak SAR (extrapolated) = 3.141 mW/g

SAR(1 g) = 1.24 mW/g; SAR(10 g) = 0.489 mW/g

[Info: Interpolated medium parameters used for SAR evaluation.](#)

Maximum value of SAR (measured) = 1.80 mW/g

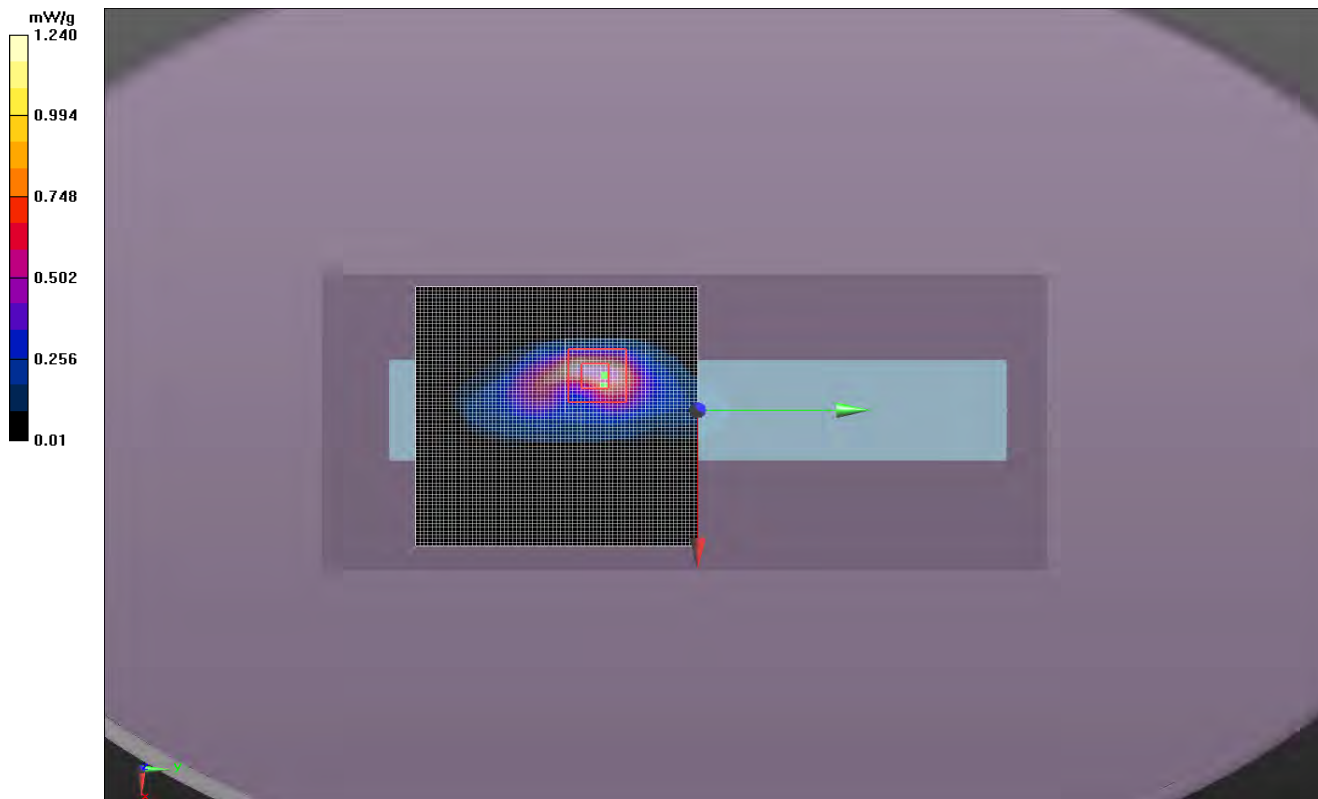

Room Temperature (°C):	23.7	Humidity (%):	39.6	Test Date:	05/21/12
Liquid Temperature (°C):	22.9	Barometric Pressure (mb):	1012	Tested by:	Ethan Schoonover

2450M Body Test 7e

DUT: Patient Monitor; Type: RAD7CA; Serial: E 1208400623

Communication System: CW; Communication System Band: D2450 (2450.0 MHz); Frequency: 2462 MHz; Communication System PAR: 0 dB; PMF: 1
 Medium parameters used: $\sigma = 0$ mho/m, $\epsilon_r = 1$; $\rho = 1000$ kg/m³, Medium parameters used (interpolated): $f = 2462$ MHz; $\sigma = 1.936$ mho/m; $\epsilon_r = 50.907$; $\rho = 1000$ kg/m³
 Phantom section: Flat Section
 Measurement Standard: DASYS (IEEE/IEC/ANSI C63.19-2007)

DASY Configuration:

DASY52 52.8.1(838); SEMCAD X 14.6.5(6469)

Body/Body/Z Scan (1x1x21): Measurement grid: dx=20mm, dy=20mm, dz=5mm

[Info: Interpolated medium parameters used for SAR evaluation.](#)

Maximum value of Total (measured) = 14.10 V/m

Body/Body/Reference scan (41x91x1): Measurement grid: dx=30mm, dy=30mm

[Info: Interpolated medium parameters used for SAR evaluation.](#)

Maximum value of SAR (interpolated) = 0.222 mW/g

Body/Body/Area scan (71x71x1): Measurement grid: dx=15mm, dy=15mm

[Info: Interpolated medium parameters used for SAR evaluation.](#)

Maximum value of SAR (interpolated) = 0.598 mW/g

Body/Body/Zoom Scan (7x7x7)/Cube 0: Measurement grid: dx=5mm, dy=5mm, dz=5mm

Reference Value = 15.009 V/m; Power Drift = -0.23 dB

Peak SAR (extrapolated) = 1.581 mW/g

SAR(1 g) = 0.625 mW/g; SAR(10 g) = 0.250 mW/g

[Info: Interpolated medium parameters used for SAR evaluation.](#)

Maximum value of SAR (measured) = 0.898 mW/g

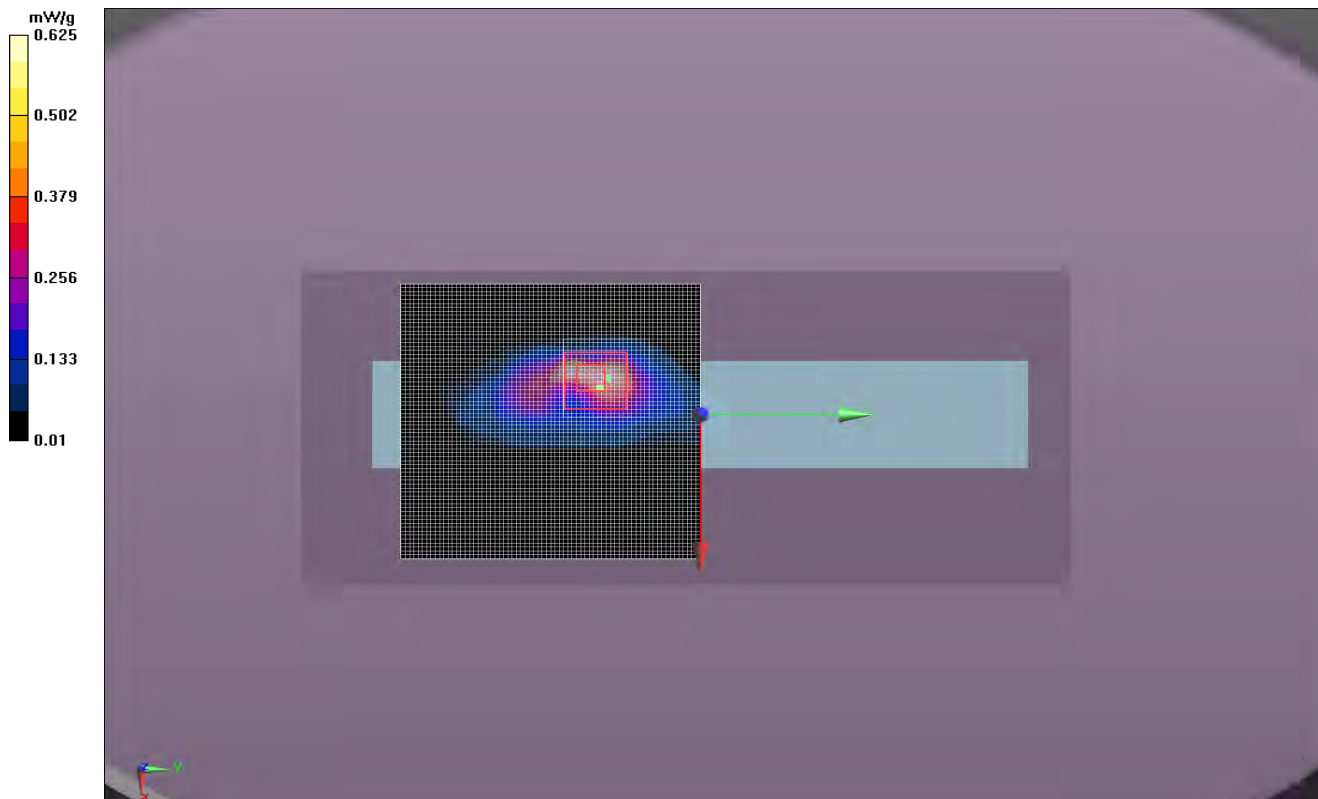

EUT: RAD7CA	Work Order: MASI0103
Serial Number: E 1208400623	Date: See Data Sheets
Customer: Masimo Corporation	Temperature: See Data Sheets
Attendees: None	Humidity: See Data Sheets
Project: None	Barometric Pres.: See Data Sheets
Tested by: Ethan Schoonover	Job Site: EV08

TEST SPECIFICATIONS	Test Method
FCC 2.1093:2011	FCC OET 65C:2001
FCC 15.247:2011	IEEE Std 1528:2003
FCC 15.407:2001	FCC KDB 447498 D01 v04
Health Safety Code 6:2009	FCC KDB 248227 D01 V01r02
	FCC KDB 865664
	RSS-102, Issue 4:2010

COMMENTS
None

DEVIATIONS FROM TEST STANDARD

Configuration #	1	Signature 
-----------------	---	---

Channel		Pulse Width	Period	Number of Pulses	Value (%)	Limit	Result
High	100% Duty Cycle	8.402 mS	8.513 mS	1	0.987	N/A	N/A
High				5		N/A	N/A
High	50% Duty Cycle	1.045 mS	8.513 mS	1	0.51	N/A	N/A
High				5		N/A	N/A
High	30% Duty Cycle	406.7 uS	8.513 mS	1	0.288	N/A	N/A
High				5		N/A	N/A

This data was taken to confirm that the test software achieved the target duty cycle values of 100, 50, and 30%. Note that 25% as specified by KDB 248227 was not achievable.

High						
	Pulse Width	Period	Number of Pulses	Value (%)	Limit	Result
	8.402 mS	8.513 mS	1	98.70%	N/A	N/A

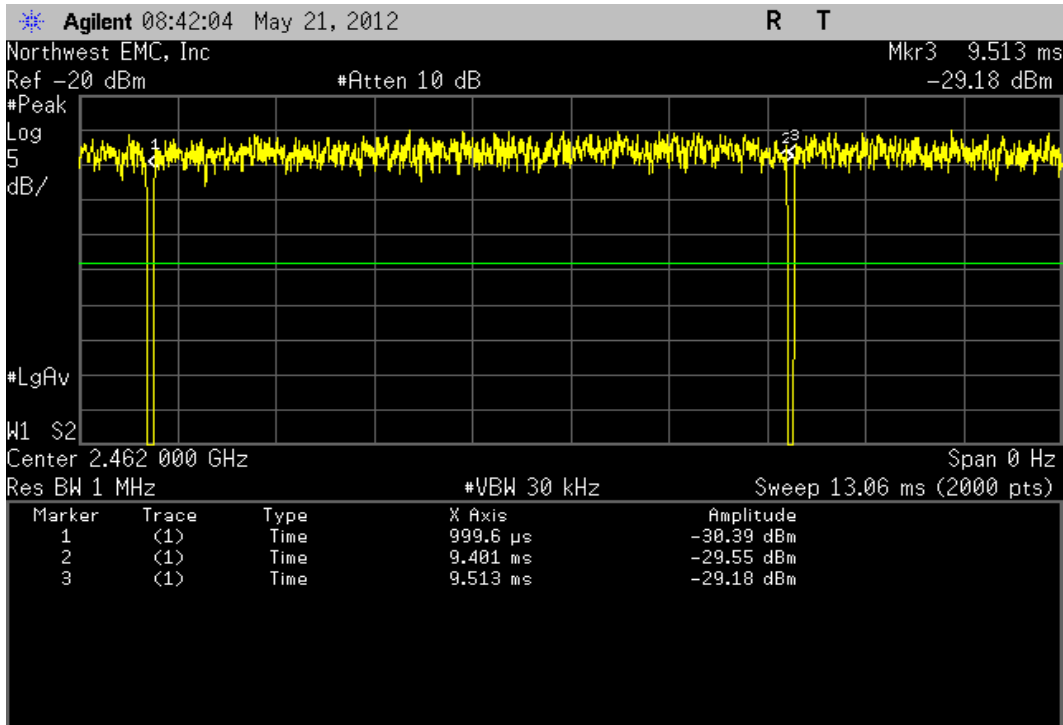

High						
	Pulse Width	Period	Number of Pulses	Value (%)	Limit	Result
			5		N/A	N/A

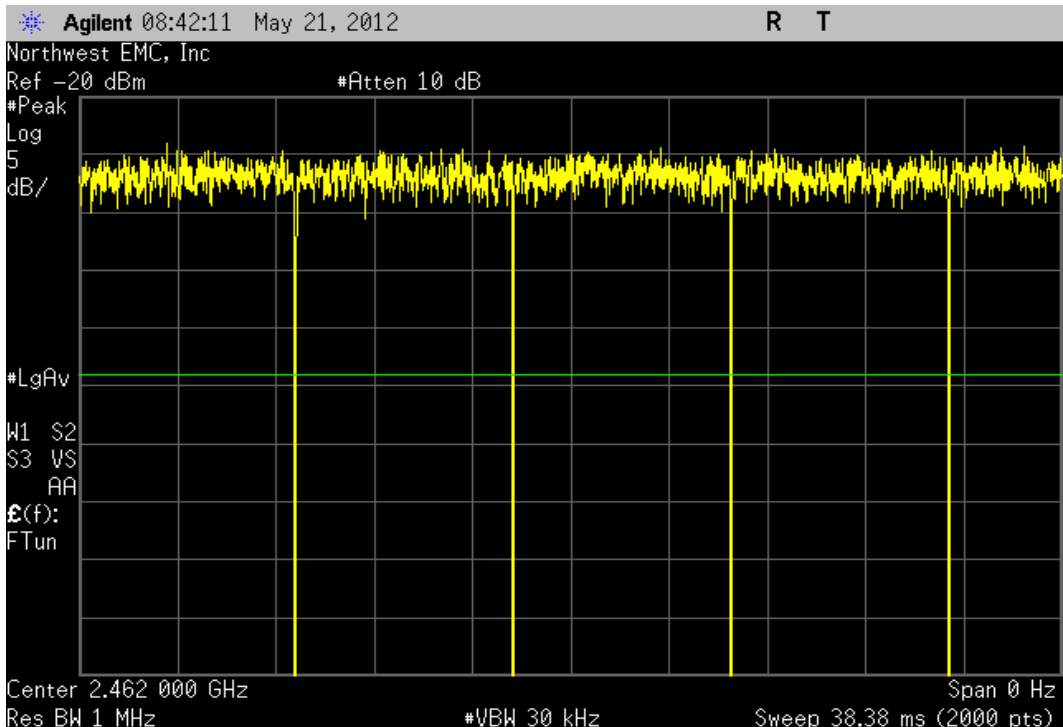

High						
	Pulse Width	Period	Number of Pulses	Value (%)	Limit	Result
	1.045 mS	2.05 mS	1	51%	N/A	N/A

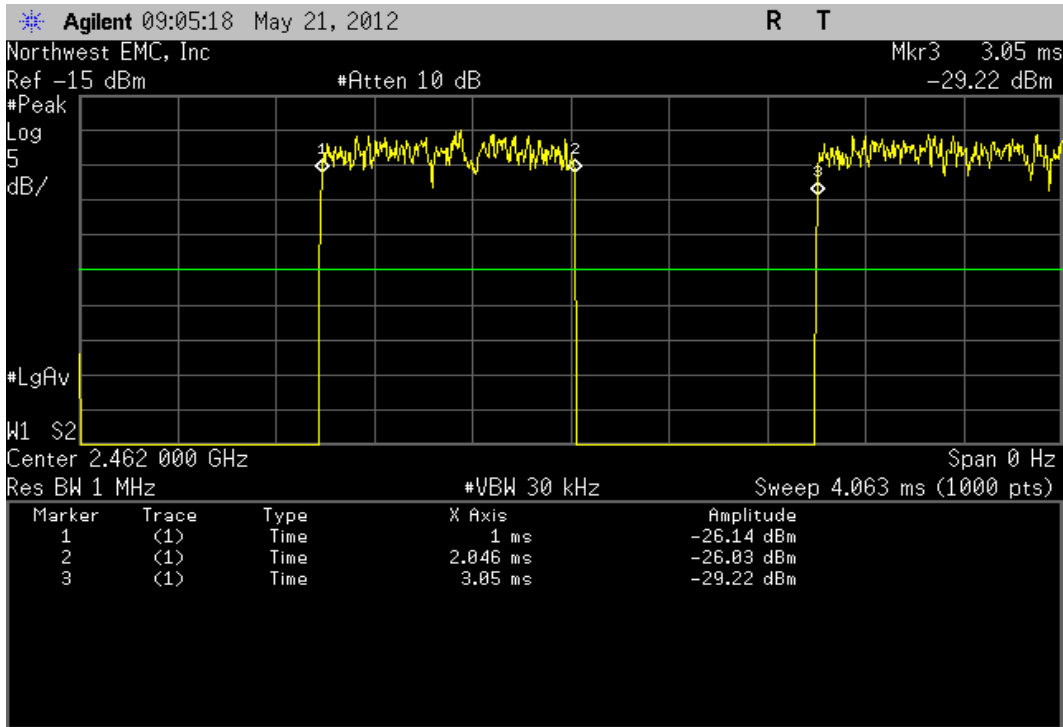

High						
	Pulse Width	Period	Number of Pulses	Value (%)	Limit	Result
			5		N/A	N/A

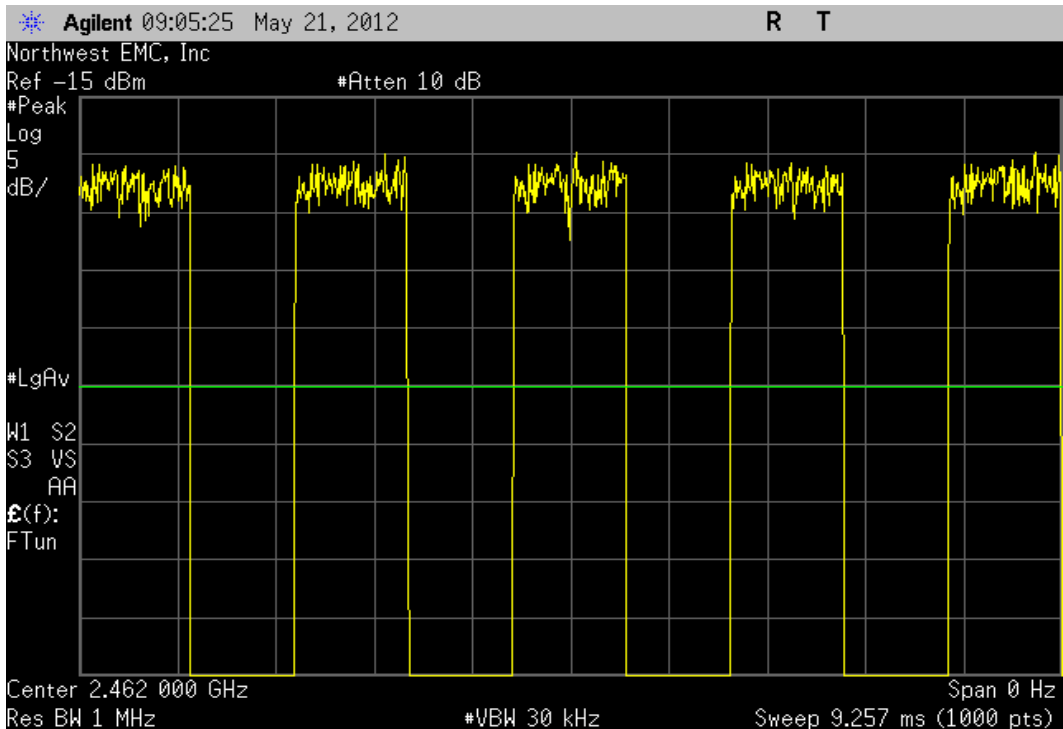

High						
	Pulse Width	Period	Number of Pulses	Value (%)	Limit	Result
	406.7 uS	1.411 ms	1	28.80%	N/A	N/A

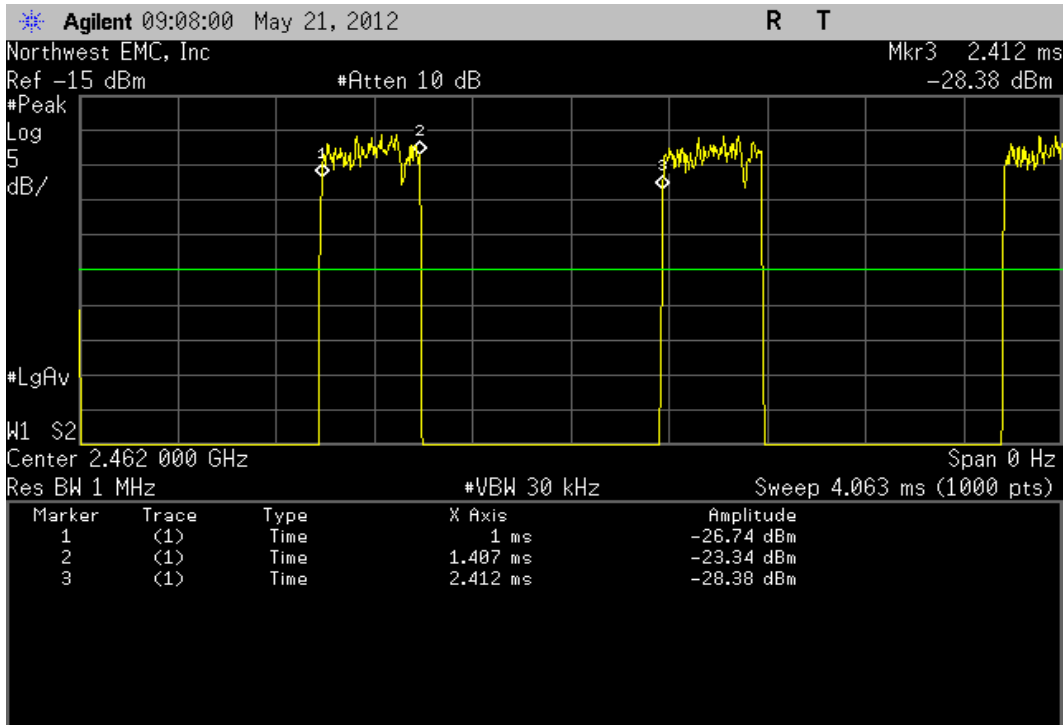

High						
	Pulse Width	Period	Number of Pulses	Value (%)	Limit	Result
			5		N/A	N/A

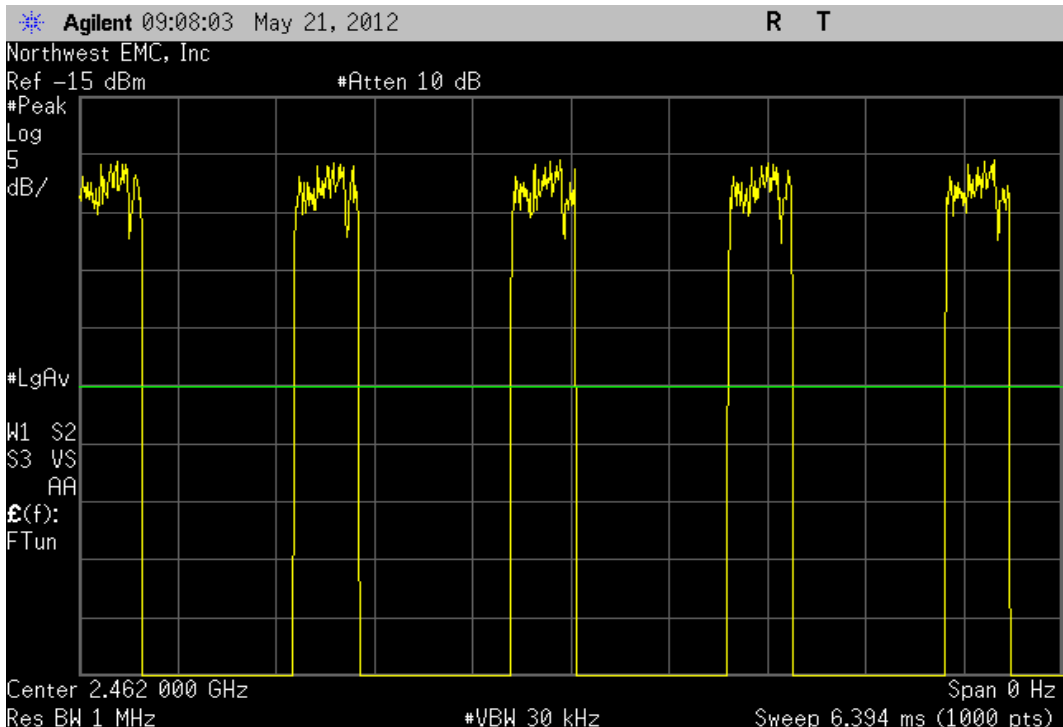

SAR Measurement System

Schmid & Partner Engineering AG, DASY52

Northwest EMC selected the leader in SAR evaluation systems to provide the measurement tools for this evaluation. SPEAG's DASY52 is the fastest and most accurate scanner on the market. It is fully compatible with all world-wide standards for transmitters operating at the ear or within 20cm of the body. It provides full compatibility with IEC 62209-1, IEC 62209-2, IEEE 1528 as well as national adaptations such as FCC OET-65c and Korean Std. MIC #2000-93

The DASY52 system for performing compliance tests consists of the following items:

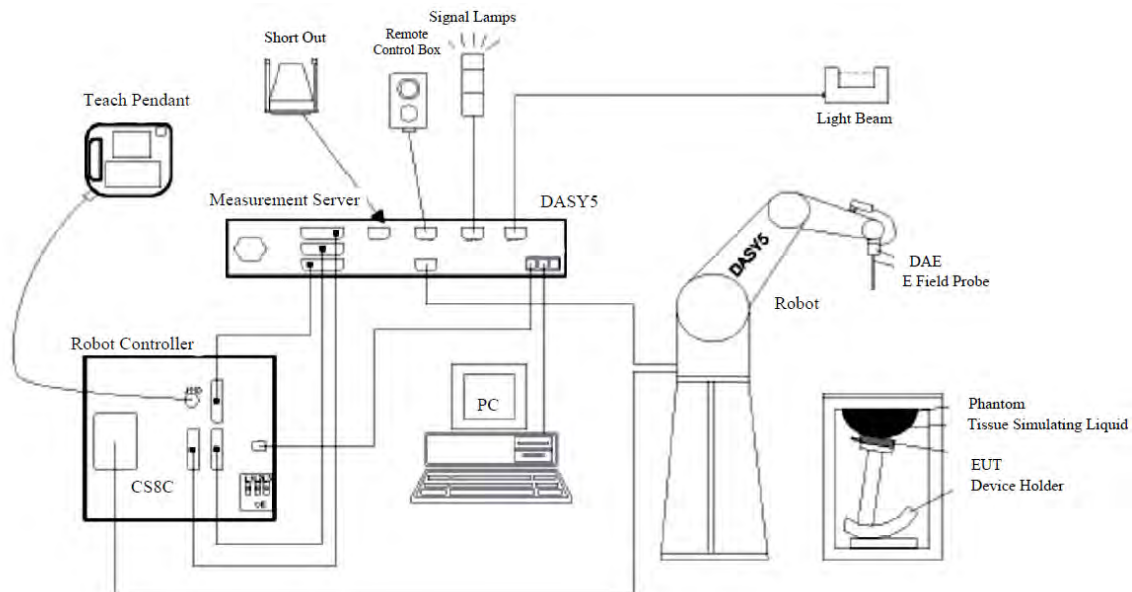

- A standard high precision 6-axis robot (Staubli TX=RX family) with controller, teach pendant and software. An arm extension for accommodating the data acquisition electronics (DAE).
- An isotropic field probe optimized and calibrated for the targeted measurement.
- A data acquisition electronics (DAE) which performs the signal amplification, signal multiplexing, AD-conversion, offset measurements, mechanical surface detection, collision detection, etc. The unit is battery powered with standard or rechargeable batteries. The signal is optically transmitted to the EOC.
- The Electro-optical converter (EOC) performs the conversion from optical to electrical signals for the digital communication to the DAE. To use optical surface detection, a special version of the EOC is required. The EOC signal is transmitted to the measurement server.
- The function of the measurement server is to perform the time critical tasks such as signal filtering, control of the robot operation and fast movement interrupts.
- The Light Beam used is for probe alignment. This improves the (absolute) accuracy of the probe positioning.
- A computer running WinXP and the DASY5 software.
- Remote control and teach pendant as well as additional circuitry for robot safety such as warning lamps, etc.
- The SAM twin phantom, oval flat phantom, device holder, tissue simulating liquids, and validation dipole kits.

Test Site

Northwest EMC, Lab EV08

The SAR measurement system is located in a semi-anechoic chamber. This provides an ambient free environment that also eliminates reflections.

The chamber is 12 ft wide by 16 ft long x 8 ft high. A dedicated HVAC unit provides +/- 1 degree C temperature control.



TEST EQUIPMENT

Description	Manufacturer	Model	ID	Last Cal.	Interval
Robot Arm	Staeubli	TX60LSPEAG	SAA	NCR	0 mo
Phantom, Twin SAM (Head)	SPEAG	QD 000 P40 CC	SAB	NCR	0 mo
Phantom, 2mm Oval ELI4 (Body)	SPEAG	QD OVA 001 BB	SAC	NCR	0 mo
Light Beam Unit	SPEAG	SE UKS 030 AA	SAD	NCR	0 mo
SAR Probe	SPEAG	EX3DV4	SAG	11/17/2011	12 mo
DAE	Schid & Partner Engineering	SD 000 D04 EJ	SAH	11/8/2011	12 mo
Robot Controller	Staeubli	CS8C	SAI	NCR	0 mo
Robot Chasis and power Supply	Staeubli	N/A	SAJ	NCR	0 mo
DASY5 Measurement Server	Staeubli	DAYS5	SAK	NCR	0 mo
Body Solution	SPEAG	MSL 2450	SAM	Within 24 hours of a measurement	
Body Solution	SPEAG	MSL 501	SAV		
Device Holder	SPEAG	N/A	SAW		
Antenna, Dipole 2450MHz SAR	SPEAG	D2450V2	ADL	12/9/2011	12 mo
Antenna, Dipole 5.1-5.8GHz SAR	SPEAG	D5GHzV2	ADM	12/14/2011	12 mo
Network Analyzer	Hewlett Packard	N5230A	NAD	8/3/2011	12 mo
Dielectric Probe Kit	Agilent	85070E	IPP	9/8/2010	24 mo
Power Meter	Agilent	N1913A	SQR	6/6/2011	24 mo
Power Sensor	Agilent	E9300H	SQO	6/6/2011	24 mo
MXG Analog Signal Generator	Agilent	N5181A	TIG	NCR	0 mo
Broadband Amplifier, SMA, 2000-8000 MHz	Mini Circuits	ZVE-3W-83+	TTA	NCR	0 mo
Humidity Temperature Meter	Omegaette	HH311	DTX	3/29/2011	24 mo
Humidity Temperature Meter	Omegaette	HH311	DTY	3/29/2011	24 mo

Measurement Uncertainty Budgets per IEEE 1528:2003

300 – 3000 MHz range

Uncertainty Component	Tolerance (+/- %)	Probability Distribution	Divisor	c_i (1g)	c_i (10g)	u_i (1g) (+/-%)	u_i (10g) (+/-%)	v_i
Measurement System								
Probe calibration (k=1)	5.5	normal	1	1	1	5.5	5.5	∞
Axial isotropy	4.7	rectangular	1.732	0.707	0.707	1.9	1.9	∞
Hemispherical isotropy	9.6	rectangular	1.732	0.707	0.707	3.9	3.9	∞
Boundary effect	1.0	rectangular	1.732	1	1	0.6	0.6	∞
Linearity	4.7	rectangular	1.732	1	1	2.7	2.7	∞
System detection limits	1.0	rectangular	1.732	1	1	0.6	0.6	∞
Readout electronics	0.3	normal	1	1	1	0.3	0.3	∞
Response time	0.8	rectangular	1.732	1	1	0.5	0.5	∞
Integration time	2.6	rectangular	1.732	1	1	1.5	1.5	∞
RF ambient conditions - noise	1.7	rectangular	1.732	1	1	1.0	1.0	∞
RF Ambient Reflections	0.0	rectangular	1.732	1	1	0.0	0.0	∞
Probe positioner mechanical tolerance	0.4	rectangular	1.732	1	1	0.2	0.2	∞
Probe positioner with respect to phantom shell	2.9	rectangular	1.732	1	1	1.7	1.7	∞
Extrapolation, interpolation, and integration algorithms for max. SAR evaluation	1.0	rectangular	1.732	1	1	0.6	0.6	∞
Test Sample Related								
Device Positioning	2.9	normal	1	1	1	2.9	2.9	145
Device Holder	3.6	normal	1	1	1	3.6	3.6	5
Power Drift	5.0	rectangular	1.732	1	1	2.9	2.9	∞
Phantom and tissue parameters								
Phantom Uncertainty - shell thickness tolerances	4.0	rectangular	1.732	1	1	2.3	2.3	∞
Liquid conductivity - deviation from target values	5.0	rectangular	1.732	0.64	0.43	1.8	1.2	∞
Liquid conductivity - measurement uncertainty	6.5	normal	1	0.64	0.43	4.2	2.8	∞
Liquid permittivity - deviation from target values	5.0	rectangular	1.732	0.6	0.49	1.7	1.4	∞
Liquid permittivity - measurement uncertainty	3.2	normal	1	0.6	0.49	1.9	1.6	∞
Combined Standard Uncertainty	RSS					11.2	10.6	387
Expanded Measurement Uncertainty (95% Confidence/	normal (k=2)					22.5	21.2	

3 – 6 GHz range

Uncertainty Component	Tolerance (+/- %)	Probability Distribution	Divisor	c_i (1g)	c_i (10g)	u_i (1g) (+/-%)	u_i (10g) (+/-%)	v_i
Measurement System								
Probe calibration (k=1)	6.55	normal	1	1	1	6.6	6.6	∞
Axial isotropy	4.7	rectangular	1.732	0.707	0.707	1.9	1.9	∞
Hemispherical isotropy	9.6	rectangular	1.732	0.707	0.707	3.9	3.9	∞
Boundary effect	2.0	rectangular	1.732	1	1	1.2	1.2	∞
Linearity	4.7	rectangular	1.732	1	1	2.7	2.7	∞
System detection limits	1.0	rectangular	1.732	1	1	0.6	0.6	∞
Readout electronics	0.3	normal	1	1	1	0.3	0.3	∞
Response time	0.8	rectangular	1.732	1	1	0.5	0.5	∞
Integration time	2.6	rectangular	1.732	1	1	1.5	1.5	∞
RF ambient conditions - noise	1.7	rectangular	1.732	1	1	1.0	1.0	∞
RF Ambient Reflections	0.0	rectangular	1.732	1	1	0.0	0.0	∞
Probe positioner mechanical tolerance	0.8	rectangular	1.732	1	1	0.5	0.5	∞
Probe positioner with respect to phantom shell	9.9	rectangular	1.732	1	1	5.7	5.7	∞
Extrapolation, interpolation, and integration algorithms for max. SAR evaluation	4.0	rectangular	1.732	1	1	2.3	2.3	∞
Test Sample Related								
Device Positioning	2.9	normal	1	1	1	2.9	2.9	145
Device Holder	3.6	normal	1	1	1	3.6	3.6	5
Power Drift	5.0	rectangular	1.732	1	1	2.9	2.9	∞
Phantom and tissue parameters								
Phantom Uncertainty - shell thickness tolerances	4.0	rectangular	1.732	1	1	2.3	2.3	∞
Liquid conductivity - deviation from target values	5.0	rectangular	1.732	0.64	0.43	1.8	1.2	∞
Liquid conductivity - measurement uncertainty	6.5	normal	1	0.64	0.43	4.2	2.8	∞
Liquid permittivity - deviation from target values	5.0	rectangular	1.732	0.6	0.49	1.7	1.4	∞
Liquid permittivity - measurement uncertainty	3.2	normal	1	0.6	0.49	1.9	1.6	∞
Combined Standard Uncertainty	RSS					13.2	12.7	330
Expanded Measurement Uncertainty (95% Confidence/	normal (k=2)					26.5	25.4	

Probe Calibration

Please see attached calibration data

**Calibration Laboratory of
Schmid & Partner
Engineering AG**
Zeughausstrasse 43, 8004 Zurich, Switzerland



S Schweizerischer Kalibrierdienst
S Service suisse d'étalonnage
S Servizio svizzero di taratura
S Swiss Calibration Service

Accredited by the Swiss Accreditation Service (SAS)
The Swiss Accreditation Service is one of the signatories to the EA
Multilateral Agreement for the recognition of calibration certificates

Accreditation No.: **SCS 108**

Client **Northwest EMC**

Certificate No: **EX3-3746_Nov11**

CALIBRATION CERTIFICATE

Object **EX3DV4 - SN:3746**

Calibration procedure(s) **QA CAL-01.v8, QA CAL-14.v3, QA CAL-23.v4, QA CAL-25.v4
Calibration procedure for dosimetric E-field probes**

Calibration date: **November 17, 2011**

This calibration certificate documents the traceability to national standards, which realize the physical units of measurements (SI).
The measurements and the uncertainties with confidence probability are given on the following pages and are part of the certificate.

All calibrations have been conducted in the closed laboratory facility; environment temperature $(22 \pm 3)^\circ\text{C}$ and humidity $< 70\%$.

Calibration Equipment used (M&TE critical for calibration)

Primary Standards	ID	Cal Date (Certificate No.)	Scheduled Calibration
Power meter E4419B	GB41293874	31-Mar-11 (No. 217-01372)	Apr-12
Power sensor E4412A	MY41498087	31-Mar-11 (No. 217-01372)	Apr-12
Reference 3 dB Attenuator	SN: S5054 (3c)	29-Mar-11 (No. 217-01369)	Apr-12
Reference 20 dB Attenuator	SN: S5086 (20b)	29-Mar-11 (No. 217-01367)	Apr-12
Reference 30 dB Attenuator	SN: S5129 (30b)	29-Mar-11 (No. 217-01370)	Apr-12
Reference Probe ES3DV2	SN: 3013	29-Dec-10 (No. ES3-3013_Dec10)	Dec-11
DAE4	SN: 654	3-May-11 (No. DAE4-654_May11)	May-12
Secondary Standards	ID	Check Date (in house)	Scheduled Check
RF generator HP 8648C	US3642U01700	4-Aug-99 (in house check Apr-11)	In house check: Apr-13
Network Analyzer HP 8753E	US37390585	18-Oct-01 (in house check Oct-11)	In house check: Oct-12

Calibrated by:	Name Katja Pokovic	Function Technical Manager	Signature
Approved by:	Name Niels Kuster	Function Quality Manager	

Issued: November 17, 2011

This calibration certificate shall not be reproduced except in full without written approval of the laboratory.



Accredited by the Swiss Accreditation Service (SAS)

The Swiss Accreditation Service is one of the signatories to the EA
 Multilateral Agreement for the recognition of calibration certificates

Accreditation No.: **SCS 108**

Glossary:

TSL	tissue simulating liquid
NORM _{x,y,z}	sensitivity in free space
ConvF	sensitivity in TSL / NORM _{x,y,z}
DCP	diode compression point
CF	crest factor (1/duty_cycle) of the RF signal
A, B, C	modulation dependent linearization parameters
Polarization φ	φ rotation around probe axis
Polarization ϑ	ϑ rotation around an axis that is in the plane normal to probe axis (at measurement center), i.e., $\vartheta = 0$ is normal to probe axis

Calibration is Performed According to the Following Standards:

- IEEE Std 1528-2003, "IEEE Recommended Practice for Determining the Peak Spatial-Averaged Specific Absorption Rate (SAR) in the Human Head from Wireless Communications Devices: Measurement Techniques", December 2003
- IEC 62209-1, "Procedure to measure the Specific Absorption Rate (SAR) for hand-held devices used in close proximity to the ear (frequency range of 300 MHz to 3 GHz)", February 2005

Methods Applied and Interpretation of Parameters:

- NORM_{x,y,z}**: Assessed for E-field polarization $\vartheta = 0$ ($f \leq 900$ MHz in TEM-cell; $f > 1800$ MHz: R22 waveguide). NORM_{x,y,z} are only intermediate values, i.e., the uncertainties of NORM_{x,y,z} does not affect the E^2 -field uncertainty inside TSL (see below *ConvF*).
- NORM(f)_{x,y,z} = NORM_{x,y,z} * frequency_response** (see Frequency Response Chart). This linearization is implemented in DASY4 software versions later than 4.2. The uncertainty of the frequency response is included in the stated uncertainty of *ConvF*.
- DCP_{x,y,z}**: DCP are numerical linearization parameters assessed based on the data of power sweep with CW signal (no uncertainty required). DCP does not depend on frequency nor media.
- PAR**: PAR is the Peak to Average Ratio that is not calibrated but determined based on the signal characteristics
- A_{x,y,z}; B_{x,y,z}; C_{x,y,z}; VR_{x,y,z}**: A, B, C are numerical linearization parameters assessed based on the data of power sweep for specific modulation signal. The parameters do not depend on frequency nor media. VR is the maximum calibration range expressed in RMS voltage across the diode.
- ConvF and Boundary Effect Parameters**: Assessed in flat phantom using E-field (or Temperature Transfer Standard for $f \leq 800$ MHz) and inside waveguide using analytical field distributions based on power measurements for $f > 800$ MHz. The same setups are used for assessment of the parameters applied for boundary compensation (alpha, depth) of which typical uncertainty values are given. These parameters are used in DASY4 software to improve probe accuracy close to the boundary. The sensitivity in TSL corresponds to NORM_{x,y,z} * ConvF whereby the uncertainty corresponds to that given for *ConvF*. A frequency dependent *ConvF* is used in DASY version 4.4 and higher which allows extending the validity from ± 50 MHz to ± 100 MHz.
- Spherical isotropy (3D deviation from isotropy)**: in a field of low gradients realized using a flat phantom exposed by a patch antenna.
- Sensor Offset**: The sensor offset corresponds to the offset of virtual measurement center from the probe tip (on probe axis). No tolerance required.

Probe EX3DV4

SN:3746

Manufactured: March 26, 2010
Calibrated: November 17, 2011

Calibrated for DASYS/EASY Systems
(Note: non-compatible with DASYS2 system!)

DASY/EASY - Parameters of Probe: EX3DV4 - SN:3746

Basic Calibration Parameters

	Sensor X	Sensor Y	Sensor Z	Unc (k=2)
Norm ($\mu\text{V}/(\text{V}/\text{m})^2$) ^A	0.49	0.47	0.50	$\pm 10.1 \%$
DCP (mV) ^B	97.5	98.1	98.0	

Modulation Calibration Parameters

UID	Communication System Name	PAR		A dB	B dB	C dB	VR mV	Unc ^E (k=2)
10000	CW	0.00	X	0.00	0.00	1.00	112.2	$\pm 3.0 \%$
			Y	0.00	0.00	1.00	116.0	
			Z	0.00	0.00	1.00	114.8	
10061	IEEE 802.11b WiFi 2.4 GHz (DSSS, 11 Mbps)	3.60	X	6.31	77.5	22.0	114.7	$\pm 2.2 \%$
			Y	4.08	73.8	21.3	111.0	
			Z	6.71	80.1	23.4	115.3	
10069	IEEE 802.11a/h WiFi 5 GHz (OFDM, 54 Mbps)	12.20	X	14.34	73.4	26.1	129.1	$\pm 4.6 \%$
			Y	12.54	71.3	25.5	113.0	
			Z	14.02	73.2	26.1	128.5	
10077	IEEE 802.11g WiFi 2.4 GHz (DSSS/OFDM, 54 Mbps)	13.12	X	13.85	73.4	27.0	110.1	$\pm 5.2 \%$
			Y	13.00	73.9	28.0	139.2	
			Z	13.46	73.0	26.9	108.5	

The reported uncertainty of measurement is stated as the standard uncertainty of measurement multiplied by the coverage factor $k=2$, which for a normal distribution corresponds to a coverage probability of approximately 95%.

^A The uncertainties of NormX,Y,Z do not affect the E^2 -field uncertainty inside TSL (see Pages 5 and 6).

^B Numerical linearization parameter: uncertainty not required.

^E Uncertainty is determined using the max. deviation from linear response applying rectangular distribution and is expressed for the square of the field value.

DASY/EASY - Parameters of Probe: EX3DV4 - SN:3746

Calibration Parameter Determined in Head Tissue Simulating Media

f (MHz) ^C	Relative Permittivity ^F	Conductivity (S/m) ^F	ConvF X	ConvF Y	ConvF Z	Alpha	Depth (mm)	Unct. (k=2)
2450	39.2	1.80	7.14	7.14	7.14	0.46	0.91	± 12.0 %
5200	36.0	4.66	4.90	4.90	4.90	0.35	1.80	± 13.1 %
5300	35.9	4.76	4.67	4.67	4.67	0.35	1.80	± 13.1 %
5500	35.6	4.96	4.56	4.56	4.56	0.40	1.80	± 13.1 %
5800	35.3	5.27	4.23	4.23	4.23	0.50	1.80	± 13.1 %

^C Frequency validity of ± 100 MHz only applies for DASY v4.4 and higher (see Page 2), else it is restricted to ± 50 MHz. The uncertainty is the RSS of the ConvF uncertainty at calibration frequency and the uncertainty for the indicated frequency band.

^F At frequencies below 3 GHz, the validity of tissue parameters (ϵ and σ) can be relaxed to ± 10% if liquid compensation formula is applied to measured SAR values. At frequencies above 3 GHz, the validity of tissue parameters (ϵ and σ) is restricted to ± 5%. The uncertainty is the RSS of the ConvF uncertainty for indicated target tissue parameters.

DASY/EASY - Parameters of Probe: EX3DV4 - SN:3746

Calibration Parameter Determined in Body Tissue Simulating Media

f (MHz) ^C	Relative Permittivity ^F	Conductivity (S/m) ^F	ConvF X	ConvF Y	ConvF Z	Alpha	Depth (mm)	Unct. (k=2)
2450	52.7	1.95	6.77	6.77	6.77	0.80	0.50	± 12.0 %
5200	49.0	5.30	4.10	4.10	4.10	0.52	1.90	± 13.1 %
5300	48.9	5.42	3.92	3.92	3.92	0.52	1.90	± 13.1 %
5500	48.6	5.65	3.72	3.72	3.72	0.55	1.90	± 13.1 %
5800	48.2	6.00	3.85	3.85	3.85	0.60	1.90	± 13.1 %

^C Frequency validity of ± 100 MHz only applies for DASY v4.4 and higher (see Page 2), else it is restricted to ± 50 MHz. The uncertainty is the RSS of the ConvF uncertainty at calibration frequency and the uncertainty for the indicated frequency band.

^F At frequencies below 3 GHz, the validity of tissue parameters (ϵ and σ) can be relaxed to ± 10% if liquid compensation formula is applied to measured SAR values. At frequencies above 3 GHz, the validity of tissue parameters (ϵ and σ) is restricted to ± 5%. The uncertainty is the RSS of the ConvF uncertainty for indicated target tissue parameters.

Frequency Response of E-Field

(TEM-Cell:ifi110 EXX, Waveguide: R22)

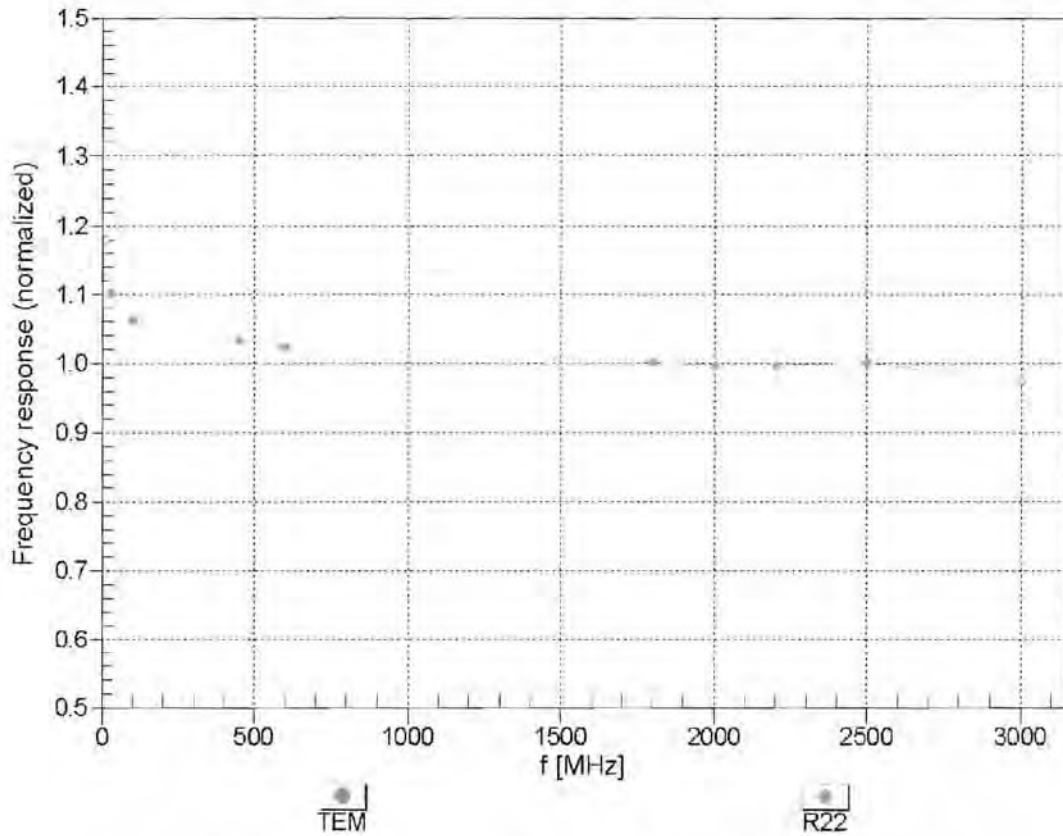

Uncertainty of Frequency Response of E-field: $\pm 6.3\%$ (k=2)

Receiving Pattern (ϕ), $\theta = 0^\circ$

f=600 MHz,TEM

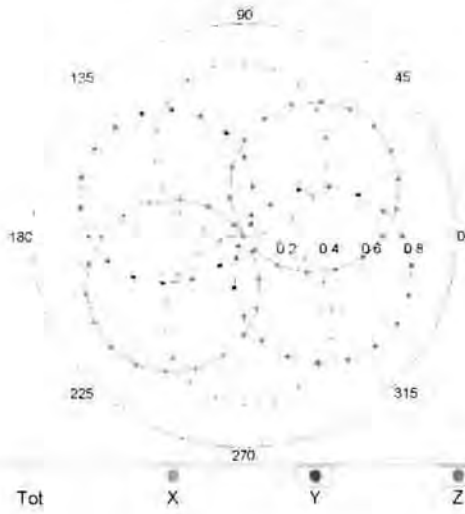

f=1800 MHz,R22

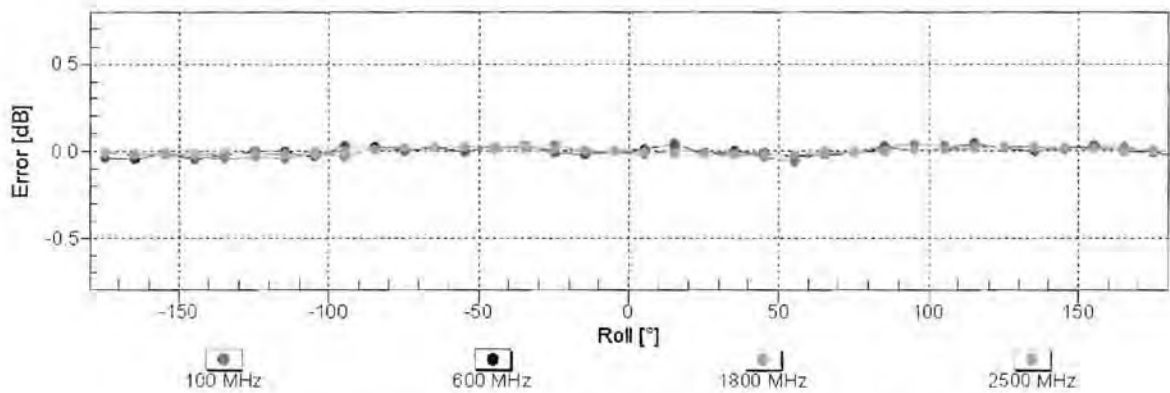
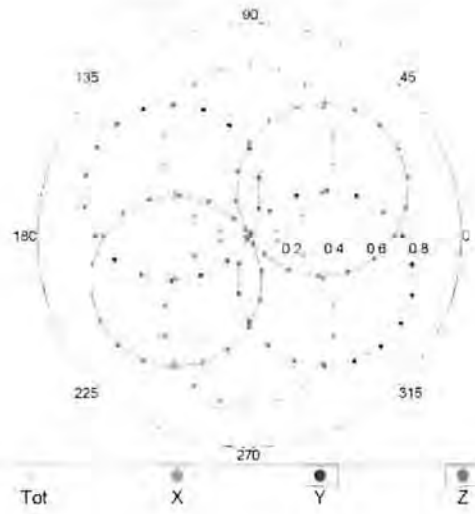

Uncertainty of Axial Isotropy Assessment: $\pm 0.5\%$ (k=2)

Dynamic Range f(SAR_{head}) (TEM cell , f = 900 MHz)

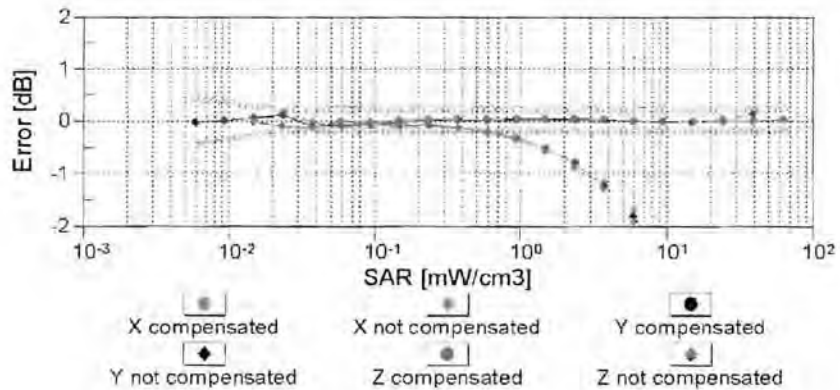
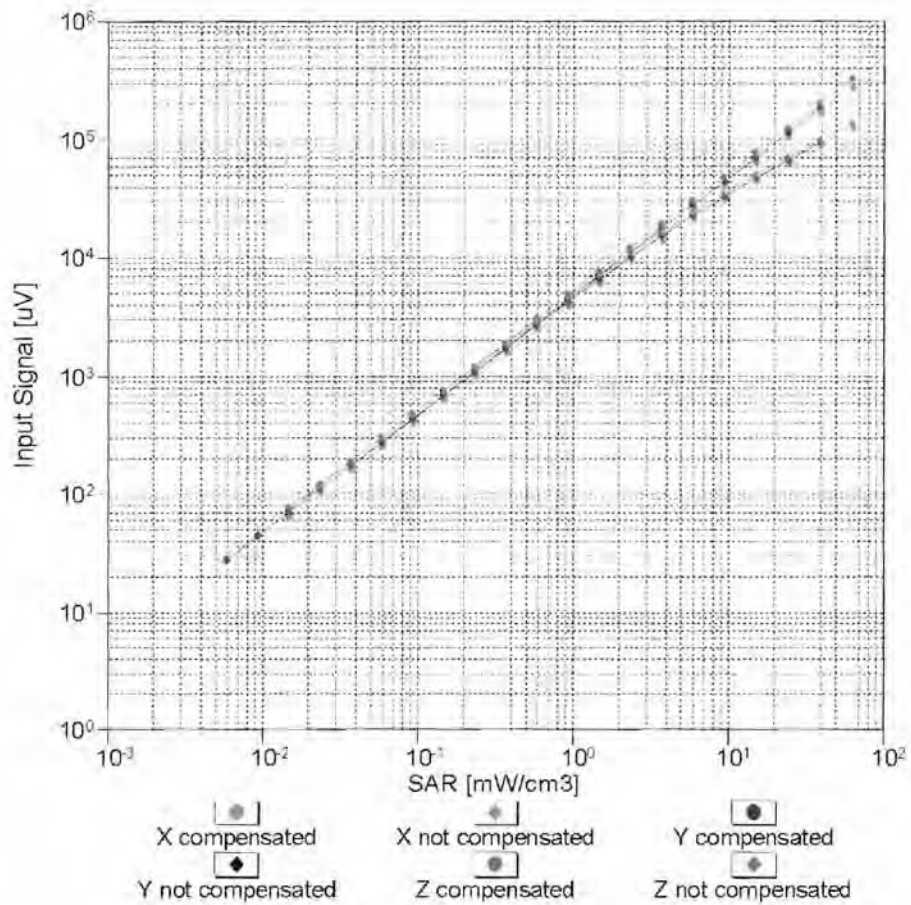

Uncertainty of Linearity Assessment: ± 0.6% (k=2)

Conversion Factor Assessment

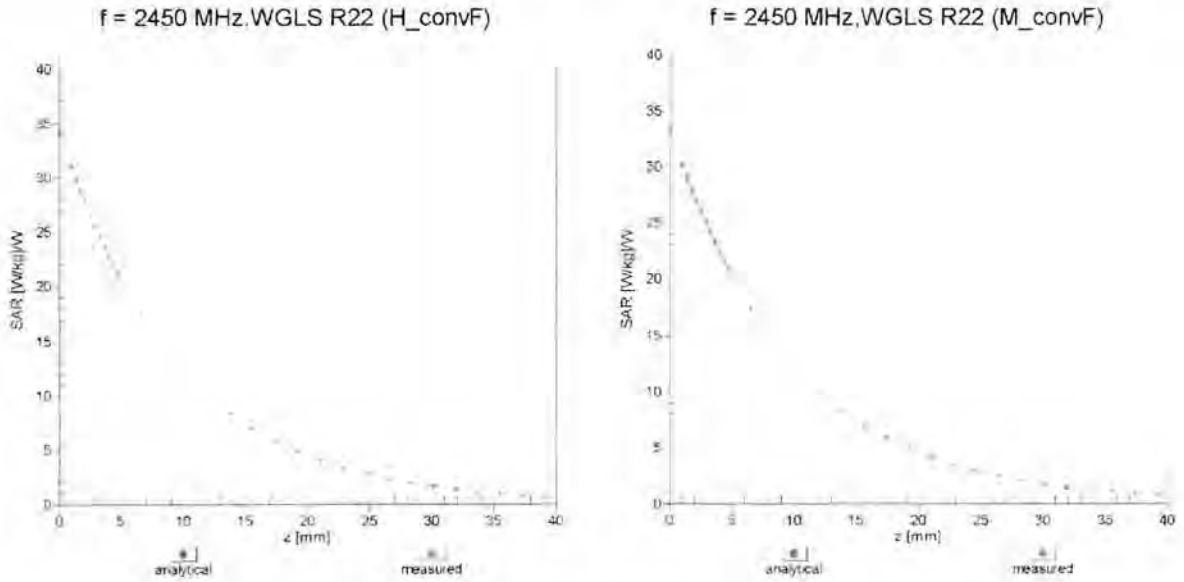

Deviation from Isotropy in Liquid Error (ϕ, θ), f = 900 MHz

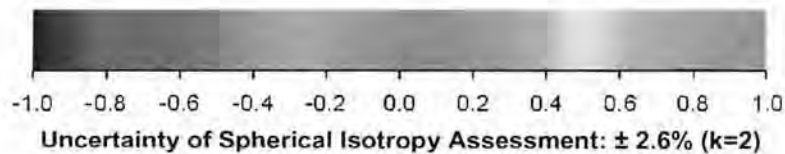
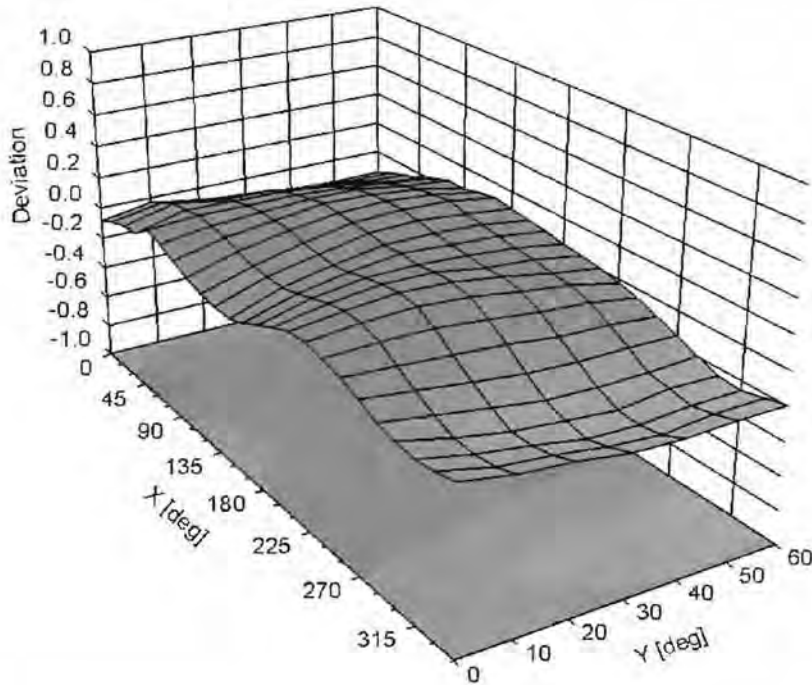

DASY/EASY - Parameters of Probe: EX3DV4 - SN:3746

Other Probe Parameters

Sensor Arrangement	Triangular
Connector Angle (°)	Not applicable
Mechanical Surface Detection Mode	enabled
Optical Surface Detection Mode	disabled
Probe Overall Length	337 mm
Probe Body Diameter	10 mm
Tip Length	9 mm
Tip Diameter	2.5 mm
Probe Tip to Sensor X Calibration Point	1 mm
Probe Tip to Sensor Y Calibration Point	1 mm
Probe Tip to Sensor Z Calibration Point	1 mm
Recommended Measurement Distance from Surface	2 mm

Dipole Calibration

Please see attached calibration data

**Calibration Laboratory of
Schmid & Partner
Engineering AG**
Zeughausstrasse 43, 8004 Zurich, Switzerland



S Schweizerischer Kalibrierdienst
S Service suisse d'étalonnage
C Servizio svizzero di taratura
S Swiss Calibration Service

Accredited by the Swiss Accreditation Service (SAS)
The Swiss Accreditation Service is one of the signatories to the EA
Multilateral Agreement for the recognition of calibration certificates

Accreditation No.: **SCS 108**

Client **Northwest EMC**

Certificate No: **D2450V2-855_Dec11**

CALIBRATION CERTIFICATE

Object: **D2450V2 - SN: 855**

Calibration procedure(s): **QA CAL-05.v8
Calibration procedure for dipole validation kits above 700 MHz**

Calibration date: **December 09, 2011**

This calibration certificate documents the traceability to national standards, which realize the physical units of measurements (SI).
The measurements and the uncertainties with confidence probability are given on the following pages and are part of the certificate.

All calibrations have been conducted in the closed laboratory facility: environment temperature (22 ± 3)°C and humidity < 70%.

Calibration Equipment used (M&TE critical for calibration)

Primary Standards	ID #	Cal Date (Certificate No.)	Scheduled Calibration
Power meter EPM-442A	GB37480704	05-Oct-11 (No. 217-01451)	Oct-12
Power sensor HP 8481A	US37292783	05-Oct-11 (No. 217-01451)	Oct-12
Reference 20 dB Attenuator	SN: 5086 (20g)	29-Mar-11 (No. 217-01368)	Apr-12
Type-N mismatch combination	SN: 5047.2 / 06327	29-Mar-11 (No. 217-01371)	Apr-12
Reference Probe ES3DV3	SN: 3205	29-Apr-11 (No. ES3-3205_Apr11)	Apr-12
DAE4	SN: 601	04-Jul-11 (No. DAE4-601_Jul11)	Jul-12
Secondary Standards	ID #	Check Date (in house)	Scheduled Check
Power sensor HP 8481A	MY41092317	18-Oct-02 (in house check Oct-11)	In house check: Oct-13
RF generator R&S SMT-06	100005	04-Aug-99 (in house check Oct-11)	In house check: Oct-13
Network Analyzer HP 8753E	US37390585 S4206	18-Oct-01 (in house check Oct-11)	In house check: Oct-12

	Name	Function	Signature
Calibrated by:	Dimce Iliev	Laboratory Technician	
Approved by:	Katja Pokovic	Technical Manager	

Issued: December 9, 2011

This calibration certificate shall not be reproduced except in full without written approval of the laboratory.



Accredited by the Swiss Accreditation Service (SAS)
The Swiss Accreditation Service is one of the signatories to the EA
Multilateral Agreement for the recognition of calibration certificates

Accreditation No.: **SCS 108**

Glossary:

TSL	tissue simulating liquid
ConvF	sensitivity in TSL / NORM x,y,z
N/A	not applicable or not measured

Calibration is Performed According to the Following Standards:

- IEEE Std 1528-2003, "IEEE Recommended Practice for Determining the Peak Spatial-Averaged Specific Absorption Rate (SAR) in the Human Head from Wireless Communications Devices: Measurement Techniques", December 2003
- IEC 62209-1, "Procedure to measure the Specific Absorption Rate (SAR) for hand-held devices used in close proximity to the ear (frequency range of 300 MHz to 3 GHz)", February 2005
- Federal Communications Commission Office of Engineering & Technology (FCC OET), "Evaluating Compliance with FCC Guidelines for Human Exposure to Radiofrequency Electromagnetic Fields; Additional Information for Evaluating Compliance of Mobile and Portable Devices with FCC Limits for Human Exposure to Radiofrequency Emissions", Supplement C (Edition 01-01) to Bulletin 65

Additional Documentation:

- DASY4/5 System Handbook

Methods Applied and Interpretation of Parameters:

- Measurement Conditions:** Further details are available from the Validation Report at the end of the certificate. All figures stated in the certificate are valid at the frequency indicated.
- Antenna Parameters with TSL:** The dipole is mounted with the spacer to position its feed point exactly below the center marking of the flat phantom section, with the arms oriented parallel to the body axis.
- Feed Point Impedance and Return Loss:** These parameters are measured with the dipole positioned under the liquid filled phantom. The impedance stated is transformed from the measurement at the SMA connector to the feed point. The Return Loss ensures low reflected power. No uncertainty required.
- Electrical Delay:** One-way delay between the SMA connector and the antenna feed point. No uncertainty required.
- SAR measured:** SAR measured at the stated antenna input power.
- SAR normalized:** SAR as measured, normalized to an input power of 1 W at the antenna connector.
- SAR for nominal TSL parameters:** The measured TSL parameters are used to calculate the nominal SAR result.

Measurement Conditions

DASY system configuration, as far as not given on page 1.

DASY Version	DASY5	V52.8.0
Extrapolation	Advanced Extrapolation	
Phantom	Modular Flat Phantom	
Distance Dipole Center - TSL	10 mm	with Spacer
Zoom Scan Resolution	dx, dy, dz = 5 mm	
Frequency	2450 MHz \pm 1 MHz	

Head TSL parameters

The following parameters and calculations were applied.

	Temperature	Permittivity	Conductivity
Nominal Head TSL parameters	22.0 °C	39.2	1.80 mho/m
Measured Head TSL parameters	(22.0 \pm 0.2) °C	39.5 \pm 6 %	1.87 mho/m \pm 6 %
Head TSL temperature change during test	< 0.5 °C	----	----

SAR result with Head TSL

SAR averaged over 1 cm ³ (1 g) of Head TSL	Condition	
SAR measured	250 mW input power	13.7 mW / g
SAR for nominal Head TSL parameters	normalized to 1W	53.9 mW / g \pm 17.0 % (k=2)

SAR averaged over 10 cm ³ (10 g) of Head TSL	condition	
SAR measured	250 mW input power	6.38 mW / g
SAR for nominal Head TSL parameters	normalized to 1W	25.3 mW / g \pm 16.5 % (k=2)

Body TSL parameters

The following parameters and calculations were applied.

	Temperature	Permittivity	Conductivity
Nominal Body TSL parameters	22.0 °C	52.7	1.95 mho/m
Measured Body TSL parameters	(22.0 \pm 0.2) °C	50.7 \pm 6 %	2.04 mho/m \pm 6 %
Body TSL temperature change during test	< 0.5 °C	----	----

SAR result with Body TSL

SAR averaged over 1 cm ³ (1 g) of Body TSL	Condition	
SAR measured	250 mW input power	13.0 mW / g
SAR for nominal Body TSL parameters	normalized to 1W	50.4 mW / g \pm 17.0 % (k=2)

SAR averaged over 10 cm ³ (10 g) of Body TSL	condition	
SAR measured	250 mW input power	6.02 mW / g
SAR for nominal Body TSL parameters	normalized to 1W	23.7 mW / g \pm 16.5 % (k=2)

Appendix

Antenna Parameters with Head TSL

Impedance, transformed to feed point	$52.9 \Omega + 4.5 j\Omega$
Return Loss	- 25.7 dB

Antenna Parameters with Body TSL

Impedance, transformed to feed point	$50.4 \Omega + 5.3 j\Omega$
Return Loss	- 25.5 dB

General Antenna Parameters and Design

Electrical Delay (one direction)	1.157 ns
----------------------------------	----------

After long term use with 100W radiated power, only a slight warming of the dipole near the feedpoint can be measured.

The dipole is made of standard semirigid coaxial cable. The center conductor of the feeding line is directly connected to the second arm of the dipole. The antenna is therefore short-circuited for DC-signals. On some of the dipoles, small end caps are added to the dipole arms in order to improve matching when loaded according to the position as explained in the "Measurement Conditions" paragraph. The SAR data are not affected by this change. The overall dipole length is still according to the Standard.

No excessive force must be applied to the dipole arms, because they might bend or the soldered connections near the feedpoint may be damaged.

Additional EUT Data

Manufactured by	SPEAG
Manufactured on	November 10, 2009

DASY5 Validation Report for Head TSL

Date: 09.12.2011

Test Laboratory: SPEAG, Zurich, Switzerland

DUT: Dipole 2450 MHz; Type: D2450V2; Serial: D2450V2 - SN: 855

Communication System: CW; Frequency: 2450 MHz

Medium parameters used: $f = 2450$ MHz; $\sigma = 1.87$ mho/m; $\epsilon_r = 39.5$; $\rho = 1000$ kg/m³

Phantom section: Flat Section

Measurement Standard: DASY5 (IEEE/IEC/ANSI C63.19-2007)

DASY52 Configuration:

- Probe: ES3DV3 - SN3205; ConvF(4.45, 4.45, 4.45); Calibrated: 29.04.2011
- Sensor-Surface: 3mm (Mechanical Surface Detection)
- Electronics: DAE4 Sn601; Calibrated: 04.07.2011
- Phantom: Flat Phantom 5.0 (front); Type: QD000P50AA; Serial: 1001
- DASY52 52.8.0(692); SEMCAD X 14.6.4(4989)

Dipole Calibration for Head Tissue/Pin=250 mW, d=10mm/Zoom Scan (7x7x7)/Cube 0:

Measurement grid: dx=5mm, dy=5mm, dz=5mm

Reference Value = 100.7 V/m; Power Drift = 0.07 dB

Peak SAR (extrapolated) = 28.3310

SAR(1 g) = 13.7 mW/g; SAR(10 g) = 6.38 mW/g

Maximum value of SAR (measured) = 17.684 mW/g

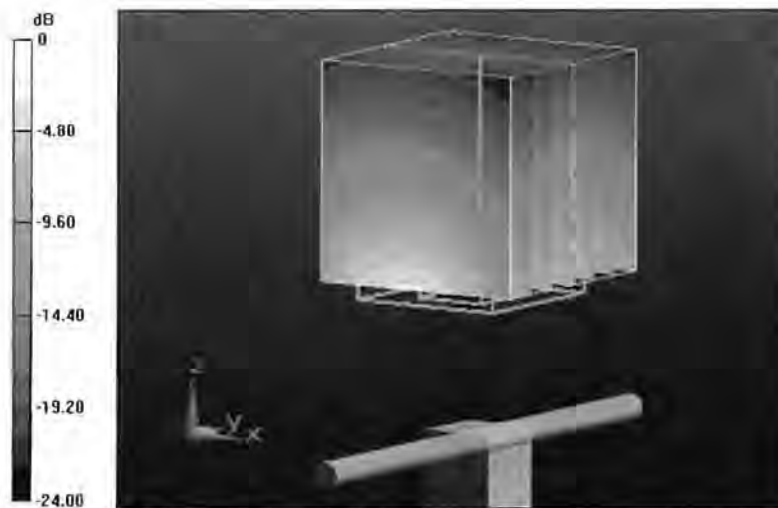

0 dB = 17.680mW/g = 24.95 dB mW/g

Impedance Measurement Plot for Head TSL

9 Dec 2011 13:32:30

CH1 S11 1 U FS 1: 52.912 Ω 4.5527 Ω 235.75 μH 2 450.000 000 MHz

*
Del
Cor

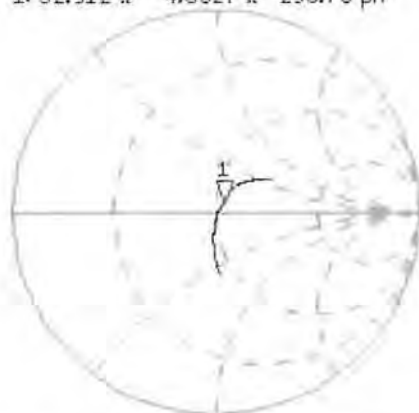

Avg
16

↑

CH2 S11 LOG 5 dB/REF -20 dB 1: -25.595 dB 2 450.000 000 MHz

Cor

Avg
16

↑

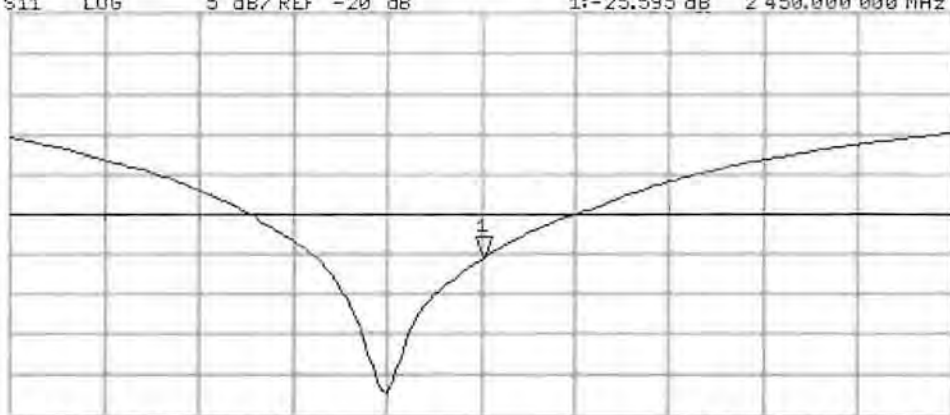

START 2 250.000 000 MHz

STOP 2 650.000 000 MHz

DASY5 Validation Report for Body TSL

Date: 08.12.2011

Test Laboratory: SPEAG, Zurich, Switzerland

DUT: Dipole 2450 MHz; Type: D2450V2; Serial: D2450V2 - SN: 855

Communication System: CW; Frequency: 2450 MHz

Medium parameters used: $f = 2450$ MHz; $\sigma = 2.04$ mho/m; $\epsilon_r = 50.7$; $\rho = 1000$ kg/m³

Phantom section: Flat Section

Measurement Standard: DASY5 (IEEE/IEC/ANSI C63.19-2007)

DASY52 Configuration:

- Probe: ES3DV3 - SN3205; ConvF(4.26, 4.26, 4.26); Calibrated: 29.04.2011
- Sensor-Surface: 3mm (Mechanical Surface Detection)
- Electronics: DAE4 Sn601; Calibrated: 04.07.2011
- Phantom: Flat Phantom 5.0 (back); Type: QD000P50AA; Serial: 1002
- DASY52 52.8.0(692); SEMCAD X 14.6.4(4989)

Dipole Calibration for Body Tissue/Pin=250 mW, d=10mm/Zoom Scan (7x7x7)/Cube 0:

Measurement grid: dx=5mm, dy=5mm, dz=5mm

Reference Value = 95.074 V/m; Power Drift = -0.0092 dB

Peak SAR (extrapolated) = 27.0840

SAR(1 g) = 13 mW/g; SAR(10 g) = 6.02 mW/g

Maximum value of SAR (measured) = 17.188 mW/g

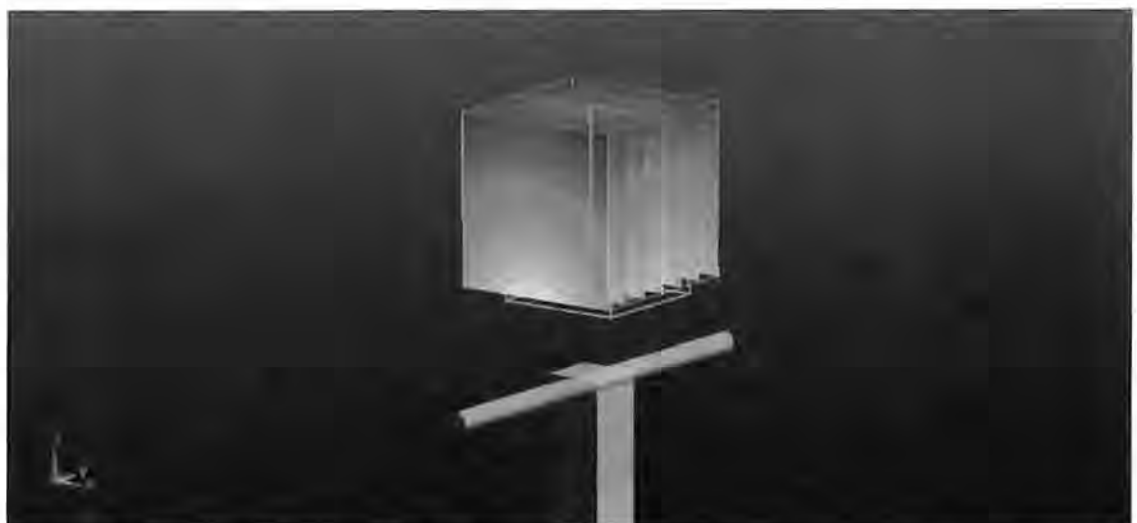

0 dB = 17.190mW/g = 24.71 dB mW/g

Impedance Measurement Plot for Body TSL

8 Dec 2011 11:09:43

CH1 S11 1 U FS 2: 50.367 Ω 5.3594 Ω 348.12 pF 2 450.220 000 MHz

*
De I
CA

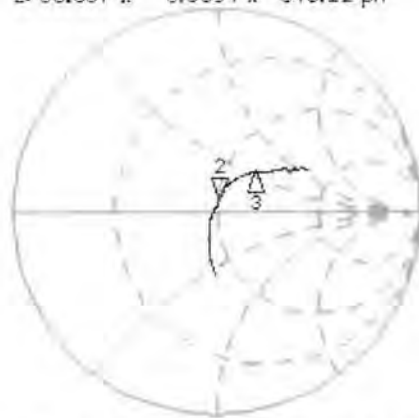

CH1 Markers
3: 65.660 Ω
27.344 Ω
2.60000 GHz

H1d

CH2 S11 LOG 5 dB/REF -20 dB 2:-25.455 dB 2 450.220 000 MHz

CA
Avg
16

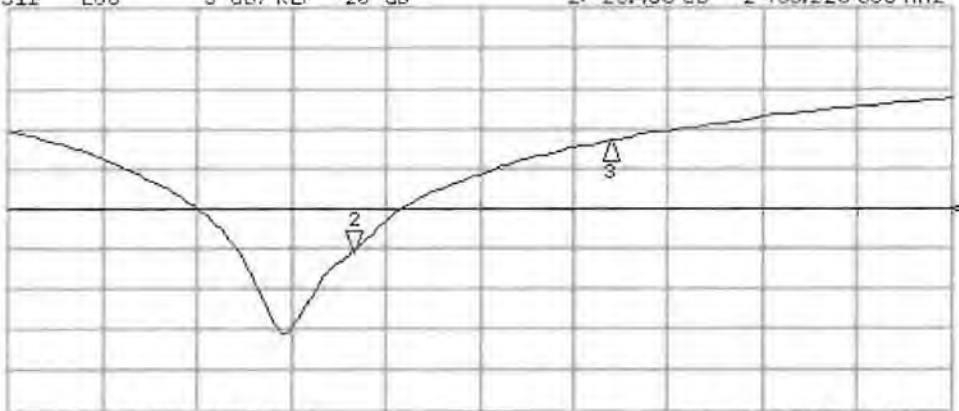

CH2 Markers
3:-11.515 dB
2.60000 GHz

START 2 250.000 000 MHz

STOP 2 800.000 000 MHz

**Calibration Laboratory of
Schmid & Partner
Engineering AG**
Zeughausstrasse 43, 8004 Zurich, Switzerland



S Schweizerischer Kalibrierdienst
S Service suisse d'étalonnage
C Servizio svizzero di taratura
S Swiss Calibration Service

Accredited by the Swiss Accreditation Service (SAS)
The Swiss Accreditation Service is one of the signatories to the EA
Multilateral Agreement for the recognition of calibration certificates

Accreditation No.: **SCS 108**

Client **Northwest EMC**

Certificate No: **D5GHzV2-1066_Dec11**

CALIBRATION CERTIFICATE

Object **D5GHzV2 - SN: 1066**

Calibration procedure(s) **QA CAL-22.v1
Calibration procedure for dipole validation kits between 3-6 GHz**

Calibration date: **December 14, 2011**

This calibration certificate documents the traceability to national standards, which realize the physical units of measurements (SI).
The measurements and the uncertainties with confidence probability are given on the following pages and are part of the certificate.

All calibrations have been conducted in the closed laboratory facility: environment temperature (22 ± 3)°C and humidity < 70%.

Calibration Equipment used (M&TE critical for calibration)

Primary Standards	ID #	Cal Date (Certificate No.)	Scheduled Calibration
Power meter EPM-442A	GB37480704	05-Oct-11 (No. 217-01451)	Oct-12
Power sensor HP 8481A	US37292783	05-Oct-11 (No. 217-01451)	Oct-12
Reference 20 dB Attenuator	SN: 5086 (20g)	29-Mar-11 (No. 217-01368)	Apr-12
Type-N mismatch combination	SN: 5047.2 / 06327	29-Mar-11 (No. 217-01371)	Apr-12
Reference Probe EX3DV4	SN: 3503	04-Mar-11 (No. EX3-3503_Mar11)	Mar-12
DAE4	SN: 601	04-Jul-11 (No. DAE4-601_Jul11)	Jul-12
Secondary Standards	ID #	Check Date (in house)	Scheduled Check
Power sensor HP 8481A	MY41092317	18-Oct-02 (in house check Oct-11)	In house check: Oct-13
RF generator R&S SMT-06	100005	04-Aug-99 (in house check Oct-11)	In house check: Oct-13
Network Analyzer HP 8753E	US37390585 S4206	18-Oct-01 (in house check Oct-11)	In house check: Oct-12

	Name	Function	Signature
Calibrated by:	Jeton Kastrati	Laboratory Technician	
Approved by:	Katja Pokovic	Technical Manager	

Issued: December 14, 2011

This calibration certificate shall not be reproduced except in full without written approval of the laboratory.



Accredited by the Swiss Accreditation Service (SAS)
The Swiss Accreditation Service is one of the signatories to the EA
Multilateral Agreement for the recognition of calibration certificates

Accreditation No.: **SCS 108**

Glossary:

TSL	tissue simulating liquid
ConvF	sensitivity in TSL / NORM x,y,z
N/A	not applicable or not measured

Calibration is Performed According to the Following Standards:

- IEEE Std 1528-2003, "IEEE Recommended Practice for Determining the Peak Spatial-Averaged Specific Absorption Rate (SAR) in the Human Head from Wireless Communications Devices: Measurement Techniques", December 2003
- IEC 62209-1, "Procedure to measure the Specific Absorption Rate (SAR) for hand-held devices used in close proximity to the ear (frequency range of 300 MHz to 3 GHz)", February 2005
- Federal Communications Commission Office of Engineering & Technology (FCC OET), "Evaluating Compliance with FCC Guidelines for Human Exposure to Radiofrequency Electromagnetic Fields; Additional Information for Evaluating Compliance of Mobile and Portable Devices with FCC Limits for Human Exposure to Radiofrequency Emissions", Supplement C (Edition 01-01) to Bulletin 65

Additional Documentation:

- DASY4/5 System Handbook

Methods Applied and Interpretation of Parameters:

- Measurement Conditions:** Further details are available from the Validation Report at the end of the certificate. All figures stated in the certificate are valid at the frequency indicated.
- Antenna Parameters with TSL:** The dipole is mounted with the spacer to position its feed point exactly below the center marking of the flat phantom section, with the arms oriented parallel to the body axis.
- Feed Point Impedance and Return Loss:** These parameters are measured with the dipole positioned under the liquid filled phantom. The impedance stated is transformed from the measurement at the SMA connector to the feed point. The Return Loss ensures low reflected power. No uncertainty required.
- Electrical Delay:** One-way delay between the SMA connector and the antenna feed point. No uncertainty required.
- SAR measured:** SAR measured at the stated antenna input power.
- SAR normalized:** SAR as measured, normalized to an input power of 1 W at the antenna connector.
- SAR for nominal TSL parameters:** The measured TSL parameters are used to calculate the nominal SAR result.

Measurement Conditions

DASY system configuration, as far as not given on page 1.

DASY Version	DASY5	V52.8.0
Extrapolation	Advanced Extrapolation	
Phantom	Modular Flat Phantom V5.0	
Distance Dipole Center - TSL	10 mm	with Spacer
Zoom Scan Resolution	dx, dy = 4.0 mm, dz = 1.4 mm	Graded Ratio = 1.4 (Z direction)
Frequency	5200 MHz ± 1 MHz 5500 MHz ± 1 MHz 5800 MHz ± 1 MHz	

Head TSL parameters at 5200 MHz

The following parameters and calculations were applied.

	Temperature	Permittivity	Conductivity
Nominal Head TSL parameters	22.0 °C	36.0	4.66 mho/m
Measured Head TSL parameters	(22.0 ± 0.2) °C	36.1 ± 6 %	4.65 mho/m ± 6 %
Head TSL temperature change during test	< 0.5 °C	----	----

SAR result with Head TSL at 5200 MHz

SAR averaged over 1 cm ³ (1 g) of Head TSL	Condition	
SAR measured	100 mW input power	8.13 mW / g
SAR for nominal Head TSL parameters	normalized to 1W	81.3 mW / g ± 17.0 % (k=2)

SAR averaged over 10 cm ³ (10 g) of Head TSL	condition	
SAR measured	100 mW input power	2.32 mW / g
SAR for nominal Head TSL parameters	normalized to 1W	23.2 mW / g ± 16.5 % (k=2)

Head TSL parameters at 5500 MHz

The following parameters and calculations were applied.

	Temperature	Permittivity	Conductivity
Nominal Head TSL parameters	22.0 °C	35.6	4.96 mho/m
Measured Head TSL parameters	(22.0 ± 0.2) °C	35.6 ± 6 %	4.96 mho/m ± 6 %
Head TSL temperature change during test	< 0.5 °C	----	----

SAR result with Head TSL at 5500 MHz

SAR averaged over 1 cm ³ (1 g) of Head TSL	Condition	
SAR measured	100 mW input power	8.53 mW / g
SAR for nominal Head TSL parameters	normalized to 1W	85.3 mW / g ± 17.0 % (k=2)

SAR averaged over 10 cm ³ (10 g) of Head TSL	condition	
SAR measured	100 mW input power	2.41 mW / g
SAR for nominal Head TSL parameters	normalized to 1W	24.1 mW / g ± 16.5 % (k=2)

Head TSL parameters at 5800 MHz

The following parameters and calculations were applied.

	Temperature	Permittivity	Conductivity
Nominal Head TSL parameters	22.0 °C	35.3	5.27 mho/m
Measured Head TSL parameters	(22.0 ± 0.2) °C	35.1 ± 6 %	5.27 mho/m ± 6 %
Head TSL temperature change during test	< 0.5 °C	----	---

SAR result with Head TSL at 5800 MHz

SAR averaged over 1 cm ³ (1 g) of Head TSL	Condition	
SAR measured	100 mW input power	7.86 mW / g
SAR for nominal Head TSL parameters	normalized to 1W	78.5 mW / g ± 17.0 % (k=2)

SAR averaged over 10 cm ³ (10 g) of Head TSL	condition	
SAR measured	100 mW input power	2.22 mW / g
SAR for nominal Head TSL parameters	normalized to 1W	22.2 mW / g ± 16.5 % (k=2)

Body TSL parameters at 5200 MHz

The following parameters and calculations were applied.

	Temperature	Permittivity	Conductivity
Nominal Body TSL parameters	22.0 °C	49.0	5.30 mho/m
Measured Body TSL parameters	(22.0 ± 0.2) °C	49.6 ± 6 %	5.44 mho/m ± 6 %
Body TSL temperature change during test	< 0.5 °C	----	----

SAR result with Body TSL at 5200 MHz

SAR averaged over 1 cm ³ (1 g) of Body TSL	Condition	
SAR measured	100 mW input power	7.51 mW / g
SAR for nominal Body TSL parameters	normalized to 1W	75.3 mW / g ± 18.1 % (k=2)

SAR averaged over 10 cm ³ (10 g) of Body TSL	condition	
SAR measured	100 mW input power	2.09 mW / g
SAR for nominal Body TSL parameters	normalized to 1W	21.0 mW / g ± 17.6 % (k=2)

Body TSL parameters at 5500 MHz

The following parameters and calculations were applied.

	Temperature	Permittivity	Conductivity
Nominal Body TSL parameters	22.0 °C	48.6	5.65 mho/m
Measured Body TSL parameters	(22.0 ± 0.2) °C	49.0 ± 6 %	5.86 mho/m ± 6 %
Body TSL temperature change during test	< 0.5 °C	---	---

SAR result with Body TSL at 5500 MHz

SAR averaged over 1 cm ³ (1 g) of Body TSL	Condition	
SAR measured	100 mW input power	8.04 mW / g
SAR for nominal Body TSL parameters	normalized to 1W	80.7 mW / g ± 18.1 % (k=2)

SAR averaged over 10 cm ³ (10 g) of Body TSL	condition	
SAR measured	100 mW input power	2.22 mW / g
SAR for nominal Body TSL parameters	normalized to 1W	22.3 mW / g ± 17.6 % (k=2)

Body TSL parameters at 5800 MHz

The following parameters and calculations were applied.

	Temperature	Permittivity	Conductivity
Nominal Body TSL parameters	22.0 °C	48.2	6.00 mho/m
Measured Body TSL parameters	(22.0 ± 0.2) °C	48.4 ± 6 %	6.28 mho/m ± 6 %
Body TSL temperature change during test	< 0.5 °C	---	---

SAR result with Body TSL at 5800 MHz

SAR averaged over 1 cm ³ (1 g) of Body TSL	Condition	
SAR measured	100 mW input power	7.54 mW / g
SAR for nominal Body TSL parameters	normalized to 1W	75.6 mW / g ± 18.1 % (k=2)

SAR averaged over 10 cm ³ (10 g) of Body TSL	condition	
SAR measured	100 mW input power	2.07 mW / g
SAR for nominal Body TSL parameters	normalized to 1W	20.8 mW / g ± 17.6 % (k=2)

Appendix

Antenna Parameters with Head TSL at 5200 MHz

Impedance, transformed to feed point	51.8 Ω - 5.1 j Ω
Return Loss	- 25.6 dB

Antenna Parameters with Head TSL at 5500 MHz

Impedance, transformed to feed point	53.2 Ω - 2.3 j Ω
Return Loss	- 28.4 dB

Antenna Parameters with Head TSL at 5800 MHz

Impedance, transformed to feed point	55.5 Ω - 1.0 j Ω
Return Loss	- 25.5 dB

Antenna Parameters with Body TSL at 5200 MHz

Impedance, transformed to feed point	51.2 Ω - 4.7 j Ω
Return Loss	- 26.4 dB

Antenna Parameters with Body TSL at 5500 MHz

Impedance, transformed to feed point	53.5 Ω - 0.2 j Ω
Return Loss	- 29.4 dB

Antenna Parameters with Body TSL at 5800 MHz

Impedance, transformed to feed point	56.4 Ω + 1.6 j Ω
Return Loss	- 24.1 dB

General Antenna Parameters and Design

Electrical Delay (one direction)	1.197 ns
----------------------------------	----------

After long term use with 100W radiated power, only a slight warming of the dipole near the feedpoint can be measured. The dipole is made of standard semirigid coaxial cable. The center conductor of the feeding line is directly connected to the second arm of the dipole. The antenna is therefore short-circuited for DC-signals. On some of the dipoles, small end caps are added to the dipole arms in order to improve matching when loaded according to the position as explained in the "Measurement Conditions" paragraph. The SAR data are not affected by this change. The overall dipole length is still according to the Standard.

No excessive force must be applied to the dipole arms, because they might bend or the soldered connections near the feedpoint may be damaged.

Additional EUT Data

Manufactured by	SPEAG
Manufactured on	November 27, 2006

DASY5 Validation Report for Head TSL

Date: 14.12.2011

Test Laboratory: SPEAG, Zurich, Switzerland

DUT: Dipole 5GHz; Type: D5GHzV2; Serial: D5GHzV2 - SN: 1066

Communication System: CW; Frequency: 5200 MHz, Frequency: 5500 MHz, Frequency: 5800 MHz
Medium parameters used: $f = 5200$ MHz; $\sigma = 4.65$ mho/m; $\epsilon_r = 36.1$; $\rho = 1000$ kg/m³, Medium parameters used: $f = 5500$ MHz; $\sigma = 4.96$ mho/m; $\epsilon_r = 35.6$; $\rho = 1000$ kg/m³, Medium parameters used: $f = 5800$ MHz; $\sigma = 5.27$ mho/m; $\epsilon_r = 35.1$; $\rho = 1000$ kg/m³
Phantom section: Flat Section
Measurement Standard: DASY5 (IEEE/IEC/ANSI C63.19-2007)

DASY52 Configuration:

- Probe: EX3DV4 - SN3503; ConvF(5.41, 5.41, 5.41), ConvF(4.91, 4.91, 4.91), ConvF(4.81, 4.81, 4.81); Calibrated: 04.03.2011
- Sensor-Surface: 1.4mm (Mechanical Surface Detection)
- Electronics: DAE4 Sn601; Calibrated: 04.07.2011
- Phantom: Flat Phantom 5.0 (front); Type: QD000P50AA; Serial: 1001
- DASY52 52.8.0(692); SEMCAD X 14.6.4(4989)

Dipole Calibration for Head Tissue/Pin=100mW, dist=10mm, f=5200 MHz/Zoom Scan,

dist=1.4mm (8x8x7)/Cube 0: Measurement grid: dx=4mm, dy=4mm, dz=1.4mm

Reference Value = 64.855 V/m; Power Drift = 0.10 dB

Peak SAR (extrapolated) = 30.2380

SAR(1 g) = 8.13 mW/g; SAR(10 g) = 2.32 mW/g

Maximum value of SAR (measured) = 18.418 mW/g

Dipole Calibration for Head Tissue/Pin=100mW, dist=10mm, f=5500 MHz/Zoom Scan,

dist=1.4mm (8x8x7)/Cube 0: Measurement grid: dx=4mm, dy=4mm, dz=1.4mm

Reference Value = 64.965 V/m; Power Drift = 0.04 dB

Peak SAR (extrapolated) = 33.8680

SAR(1 g) = 8.53 mW/g; SAR(10 g) = 2.41 mW/g

Maximum value of SAR (measured) = 19.692 mW/g

Dipole Calibration for Head Tissue/Pin=100mW, dist=10mm, f=5800 MHz/Zoom Scan,

dist=1.4mm (8x8x7)/Cube 0: Measurement grid: dx=4mm, dy=4mm, dz=1.4mm

Reference Value = 61.095 V/m; Power Drift = 0.03 dB

Peak SAR (extrapolated) = 33.1420

SAR(1 g) = 7.86 mW/g; SAR(10 g) = 2.22 mW/g

Maximum value of SAR (measured) = 18.642 mW/g

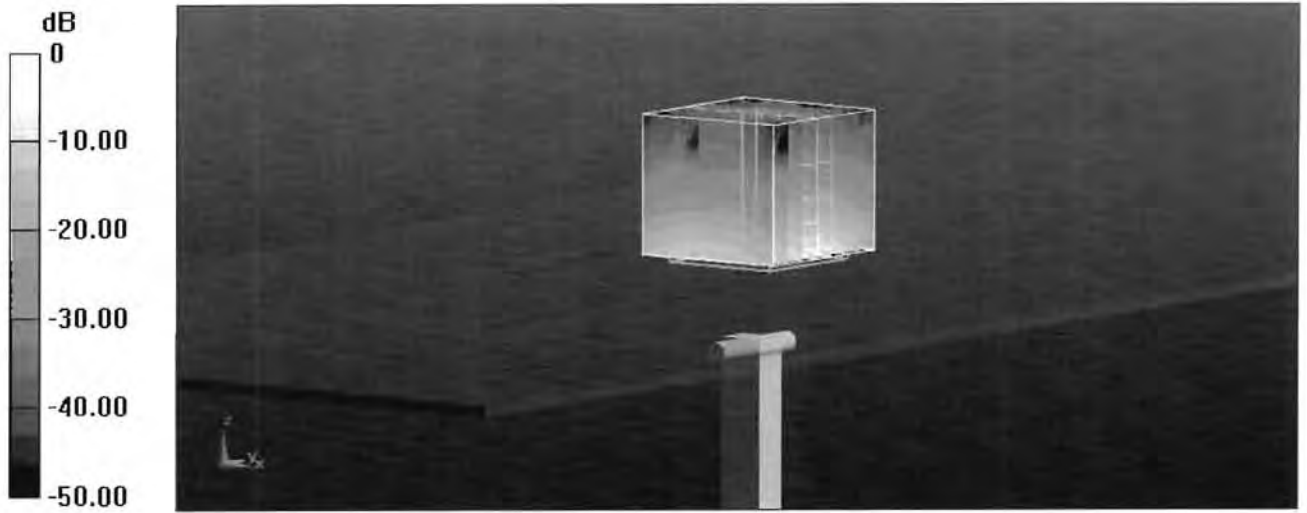

0 dB = 18.640mW/g = 25.41 dB mW/g

Impedance Measurement Plot for Head TSL

14 Dec 2011 09:59:02

CH1 S11 1 U FS 3: 55.518 Ω -994.14 m Ω 27.602 pF 5 800.000 000 MHz

*
Del
Cor

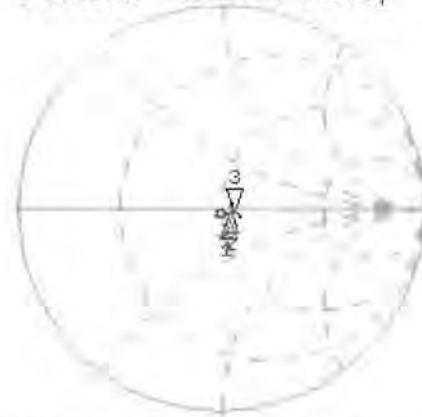

CH1 Markers

1: 51.801 Ω
-5.0625 Ω
5.20000 GHz
2: 53.201 Ω
-2.2308 Ω
5.50000 GHz

Avg
16
H1d

CH2 S11 LOG 5 dB/REF -20 dB 3: -25.493 dB 5 800.000 000 MHz

Cor
Avg
16
H1d

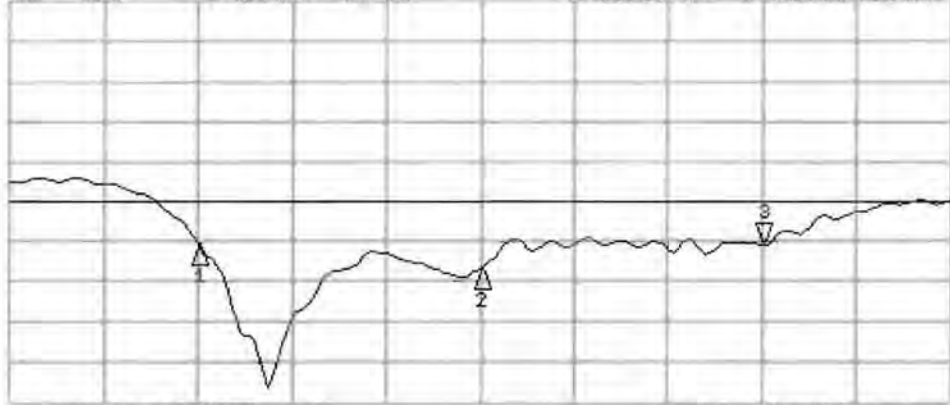

CH2 Markers

1: -25.562 dB
5.20000 GHz
2: -28.356 dB
5.50000 GHz

START 5 800.000 000 MHz

STOP 5 800.000 000 MHz

DASY5 Validation Report for Body TSL

Date: 13.12.2011

Test Laboratory: SPEAG, Zurich, Switzerland

DUT: Dipole 5GHz; Type: D5GHzV2; Serial: D5GHzV2 - SN: 1066

Communication System: CW; Frequency: 5200 MHz, Frequency: 5500 MHz, Frequency: 5800 MHz
Medium parameters used: $f = 5200$ MHz; $\sigma = 5.44$ mho/m; $\epsilon_r = 49.6$; $\rho = 1000$ kg/m³, Medium parameters used: $f = 5500$ MHz; $\sigma = 5.86$ mho/m; $\epsilon_r = 49$; $\rho = 1000$ kg/m³, Medium parameters used: $f = 5800$ MHz; $\sigma = 6.28$ mho/m; $\epsilon_r = 48.4$; $\rho = 1000$ kg/m³

Phantom section: Flat Section

Measurement Standard: DASY5 (IEEE/IEC/ANSI C63.19-2007)

DASY52 Configuration:

- Probe: EX3DV4 - SN3503; ConvF(4.91, 4.91, 4.91), ConvF(4.43, 4.43, 4.43), ConvF(4.38, 4.38, 4.38); Calibrated: 04.03.2011
- Sensor-Surface: 1.4mm (Mechanical Surface Detection)
- Electronics: DAE4 Sn601; Calibrated: 04.07.2011
- Phantom: Flat Phantom 5.0 (back); Type: QD000P50AA; Serial: 1002
- DASY52 52.8.0(692); SEMCAD X 14.6.4(4989)

Dipole Calibration for Body Tissue/Pin=100mW, dist=10mm, f=5200 MHz/Zoom Scan,

dist=1.4mm (8x8x7)/Cube 0: Measurement grid: dx=4mm, dy=4mm, dz=1.4mm

Reference Value = 58.272 V/m; Power Drift = -0.0057 dB

Peak SAR (extrapolated) = 29.4900

SAR(1 g) = 7.51 mW/g; SAR(10 g) = 2.09 mW/g

Maximum value of SAR (measured) = 17.296 mW/g

Dipole Calibration for Body Tissue/Pin=100mW, dist=10mm, f=5500 MHz/Zoom Scan,

dist=1.4mm (8x8x7)/Cube 0: Measurement grid: dx=4mm, dy=4mm, dz=1.4mm

Reference Value = 58.543 V/m; Power Drift = -0.01 dB

Peak SAR (extrapolated) = 34.4970

SAR(1 g) = 8.04 mW/g; SAR(10 g) = 2.22 mW/g

Maximum value of SAR (measured) = 19.193 mW/g

Dipole Calibration for Body Tissue/Pin=100mW, dist=10mm, f=5800 MHz/Zoom Scan,

dist=1.4mm (8x8x7)/Cube 0: Measurement grid: dx=4mm, dy=4mm, dz=1.4mm

Reference Value = 54.820 V/m; Power Drift = -0.0098 dB

Peak SAR (extrapolated) = 35.3730

SAR(1 g) = 7.54 mW/g; SAR(10 g) = 2.07 mW/g

Maximum value of SAR (measured) = 18.371 mW/g

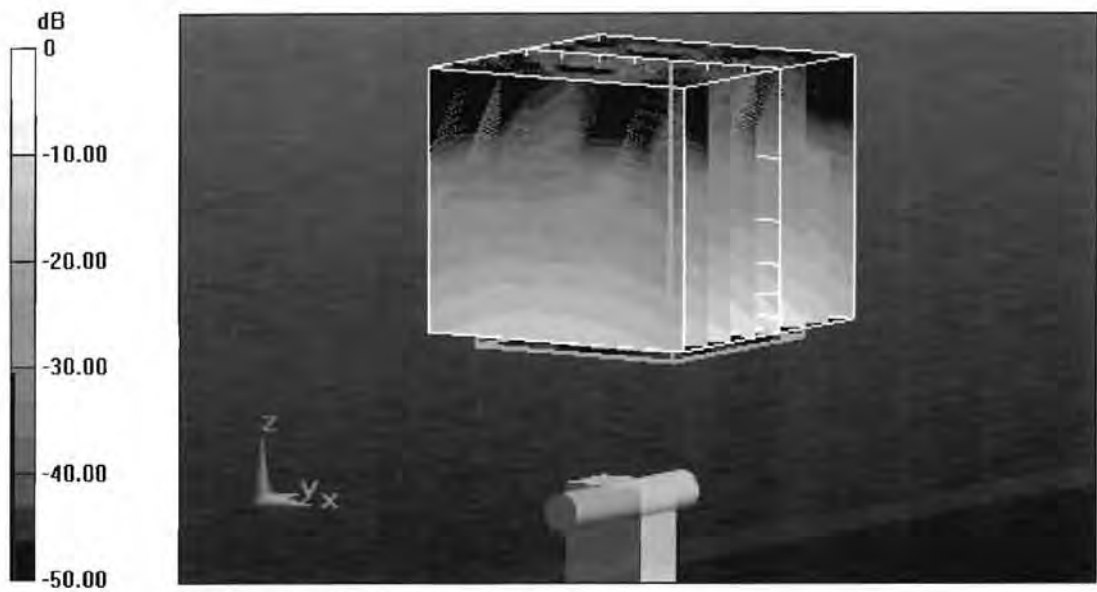

0 dB = 18.370mW/g = 25.28 dB mW/g

Impedance Measurement Plot for Body TSL

13 Dec 2011 10:52:37

CH1 S11 1 U FS 1: 51.188 Ω -4.7188 Ω 6.4863 pF 5 200.000 000 MHz

*
Del
Cor
Avg
16
H1d

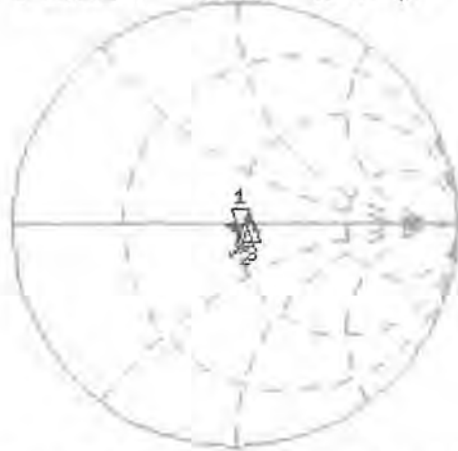

CH1 Markers
2: 53.516 Ω
-164.06 m Ω
5.50000 GHz
3: 56.428 Ω
1.6426 Ω
5.80000 GHz

CH2 S11 LOG 5 dB/REF -20 dB 1: -26.371 dB 5 200.000 000 MHz

Cor
Avg
16
H1d

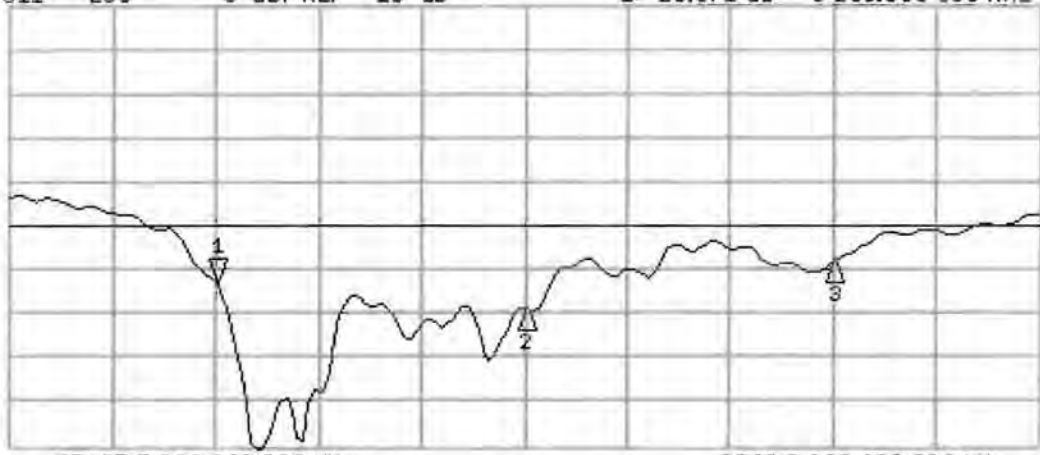

CH2 Markers
2: -29.363 dB
5.50000 GHz
3: -24.106 dB
5.80000 GHz

START 5 000.000 000 MHz

STOP 5 800.000 000 MHz

EUT Photos









