



FCC TEST REPORT

REPORT NO.: RF140312C05A R1
MODEL NO.: HRM1026B
FCC ID: VIYHRM1026B
IC: 7305A-HRM1026B
RECEIVED: Mar. 12, 2014
TESTED: Mar. 15 ~ Apr. 29, 2014
ISSUED: May 21, 2014

APPLICANT: Hosiden Corporation

ADDRESS: 4-33, Kitakyuhoji 1-chome Yao-City, Osaka
581-0071, Japan

ISSUED BY: Bureau Veritas Consumer Products Services
(H.K.) Ltd., Taoyuan Branch

LAB ADDRESS: No. 47, 14th Ling, Chia Pau Vil., Lin Kou Dist.,
New Taipei City, Taiwan, R.O.C.

TEST LOCATION: No. 19, Hwa Ya 2nd Rd, Wen Hwa Tsuen, Kwei
Shan Hsiang, Taoyuan Hsien 333, Taiwan, R.O.C.

This report should not be used by the client to claim product certification, approval, or endorsement by TAF or any government agencies.



This report is for your exclusive use. Any copying or replication of this report to or for any other person or entity, or use of our name or trademark, is permitted only with our prior written permission. This report sets forth our findings solely with respect to the test samples identified herein. The results set forth in this report are not indicative or representative of the quality or characteristics of the lot from which a test sample was taken or any similar or identical product unless specifically and expressly noted. Our report includes all of the tests requested by you and the results thereof based upon the information that you provided to us. You have 60 days from date of issuance of this report to notify us of any material error or omission caused by our negligence, provided, however, that such notice shall be in writing and shall specifically address the issue you wish to raise. A failure to raise such issue within the prescribed time shall constitute your unqualified acceptance of the completeness of this report, the tests conducted and the correctness of the report contents. Unless specific mention, the uncertainty of measurement has been explicitly taken into account to declare the compliance or non-compliance to the specification

Table of Contents

RELEASE CONTROL RECORD.....	4
1. CERTIFICATION.....	5
2. SUMMARY OF TEST RESULTS	6
2.1 MEASUREMENT UNCERTAINTY	6
3. GENERAL INFORMATION.....	7
3.1 GENERAL DESCRIPTION OF EUT.....	7
3.2 DESCRIPTION OF TEST MODES.....	8
3.2.1 TEST MODE APPLICABILITY AND TESTED CHANNEL DETAIL.....	9
3.3 DESCRIPTION OF SUPPORT UNITS	10
3.3.1 CONFIGURATION OF SYSTEM UNDER TEST.....	11
3.4 GENERAL DESCRIPTION OF APPLIED STANDARDS	11
4. TEST TYPES AND RESULTS.....	12
4.1 RADIATED EMISSION AND BANDEDGE MEASUREMENT.....	12
4.1.1 LIMITS OF RADIATED EMISSION AND BANDEDGE MEASUREMENT	12
4.1.2 TEST INSTRUMENTS	13
4.1.3 TEST PROCEDURES	14
4.1.4 DEVIATION FROM TEST STANDARD	14
4.1.5 TEST SETUP	15
4.1.6 EUT OPERATING CONDITIONS	15
4.1.7 TEST RESULTS	16
4.2 CONDUCTED EMISSION MEASUREMENT	26
4.2.1 LIMITS OF CONDUCTED EMISSION MEASUREMENT.....	26
4.2.2 TEST INSTRUMENTS	26
4.2.3 TEST PROCEDURES	27
4.2.4 DEVIATION FROM TEST STANDARD	27
4.2.5 TEST SETUP	27
4.2.6 EUT OPERATING CONDITIONS	27
4.2.7 TEST RESULTS	28
4.3 6dB BANDWIDTH MEASUREMENT	30
4.3.1 LIMITS OF 6dB BANDWIDTH MEASUREMENT	30
4.3.2 TEST SETUP	30
4.3.3 TEST INSTRUMENTS	30
4.3.4 TEST PROCEDURE	30
4.3.5 DEVIATION FROM TEST STANDARD	30
4.3.6 EUT OPERATING CONDITIONS	30
4.3.7 TEST RESULTS	31
4.4 CONDUCTED OUTPUT POWER	33
4.4.1 LIMITS OF CONDUCTED OUTPUT POWER MEASUREMENT	33
4.4.2 TEST SETUP	33
4.4.3 TEST INSTRUMENTS	33
4.4.4 TEST PROCEDURES	33
4.4.5 DEVIATION FROM TEST STANDARD	33
4.4.6 EUT OPERATING CONDITIONS	33
4.4.7 TEST RESULTS	34
4.5 POWER SPECTRAL DENSITY MEASUREMENT.....	35
4.5.1 LIMITS OF POWER SPECTRAL DENSITY MEASUREMENT	35
4.5.2 TEST SETUP	35
4.5.3 TEST INSTRUMENTS	35



4.5.4	TEST PROCEDURE	35
4.5.5	DEVIATION FROM TEST STANDARD	35
4.5.6	EUT OPERATING CONDITION	35
4.5.7	TEST RESULTS	36
4.6	OCCUPIED BANDWIDTH MEASUREMENT	38
4.6.1	TEST SETUP	38
4.6.2	TEST INSTRUMENTS	38
4.6.3	TEST PROCEDURE	38
4.6.4	DEVIATION FROM TEST STANDARD	38
4.6.5	EUT OPERATING CONDITIONS	38
4.6.6	TEST RESULTS	39
4.7	CONDUCTED OUT OF BAND EMISSION MEASUREMENT	41
4.7.1	LIMITS OF OUT OF BAND EMISSION MEASUREMENT	41
4.7.2	TEST SETUP	41
4.7.3	TEST INSTRUMENTS	41
4.7.4	TEST PROCEDURE	41
4.7.5	DEVIATION FROM TEST STANDARD	42
4.7.6	EUT OPERATING CONDITION	42
4.7.7	TEST RESULTS	42
4.7.8	TEST RESULTS	43
5.	PHOTOGRAPHS OF THE TEST CONFIGURATION	49
6.	INFORMATION ON THE TESTING LABORATORIES	50
7.	APPENDIX A - MODIFICATIONS RECORDERS FOR ENGINEERING CHANGES TO THE EUT BY THE LAB	51



RELEASE CONTROL RECORD

ISSUE NO.	REASON FOR CHANGE	DATE ISSUED
RF140312C05A	Original release	Apr. 30, 2014
RF140312C05A R1	Changed product name	May 21, 2014



1. CERTIFICATION

PRODUCT: Wireless Low Energy Module
MODEL NO.: HRM1026B
BRAND: Hosiden
APPLICANT: Hosiden Corporation
TESTED: Mar. 15 ~ Apr. 29, 2014
TEST SAMPLE: Production Prototype
STANDARDS: **FCC Part 15, Subpart C (Section 15.247)**
Canada RSS-210 Issue 8 (2010-12)
Canada RSS-Gen Issue 3 (2010-12)
ANSI C63.10-2009

The above equipment (model: HRM1026B) has been tested by **Bureau Veritas Consumer Products Services (H.K.) Ltd., Taoyuan Branch**, and found compliance with the requirement of the above standards. The test record, data evaluation & Equipment Under Test (EUT) configurations represented herein are true and accurate accounts of the measurements of the sample's EMC characteristics under the conditions specified in this report.

PREPARED BY :  , **DATE** : May 21, 2014
Pettie Chen / Senior Specialist

APPROVED BY :  , **DATE** : May 21, 2014
Ken Liu / Senior Manager

2. SUMMARY OF TEST RESULTS

The EUT has been tested according to the following specifications:

APPLIED STANDARD: FCC Part 15, Subpart C (Section 15.247); RSS-210; RSS-Gen				
STANDARD SECTION		TEST TYPE	RESULT	REMARK
FCC Part 15C	Canada Standard			
15.207	RSS-Gen 7.2.4	AC Power Conducted Emission	PASS	Meet the requirement of limit. Minimum passing margin is -38.44dB at 0.72465MHz.
-	RSS-Gen 4.6	Occupied Bandwidth Measurement	PASS	Meet the requirement of limit.
15.247(d) 15.209	RSS-210 A8.5	Radiated Emissions	PASS	Meet the requirement of limit. Minimum passing margin is -11.3dB at 198.71MHz.
15.247(d)	RSS-210 A8.5	Band Edge Measurement	PASS	Meet the requirement of limit. Minimum passing margin is -22.0dB at 2400.00MHz.
15.247(d)	-	Antenna Port Emission	PASS	Meet the requirement of limit.
15.247(a)(2)	RSS-210 A8.2 (a)	6dB bandwidth	PASS	Meet the requirement of limit.
15.247(b)	RSS-210 A8.4 (4)	Conducted power	PASS	Meet the requirement of limit.
15.247(e)	RSS-210 A8.2 (b)	Power Spectral Density	PASS	Meet the requirement of limit.
15.203	-	Antenna Requirement	PASS	No antenna connector is used.

Note: "NA" means Not Applicable.

2.1 MEASUREMENT UNCERTAINTY

Where relevant, the following measurement uncertainty levels have been estimated for tests performed on the EUT as specified in CISPR 16-4-2:

MEASUREMENT	FREQUENCY	UNCERTAINTY
Conducted emissions	9kHz~30MHz	2.44 dB
Radiated emissions	30MHz ~ 200MHz	3.19 dB
	200MHz ~1000MHz	3.21 dB
	1GHz ~ 18GHz	2.26 dB
	18GHz ~ 40GHz	1.94 dB

This uncertainty represents an expanded uncertainty expressed at approximately the 95% confidence level using a coverage factor of k=2.

3. GENERAL INFORMATION

3.1 GENERAL DESCRIPTION OF EUT

EUT	Wireless Low Energy Module			
MODEL NO.	HRM1026B			
POWER SUPPLY	3.0Vdc			
MODULATION TYPE	GFSK			
DATA RATE	250kbps	1Mbps	1Mbps	2Mbps
BANDWIDTH	700kHz	950kHz	950kHz	1800kHz
CHANNEL SPACING	1MHz	1MHz	2MHz	2MHz
OPERATING FREQUENCY	2402 ~ 2480MHz			
NUMBER OF CHANNEL	For 1MHz channel spacing	79		
	For 2MHz channel spacing	40		
OUTPUT POWER	Data Rate 250kbps for 1MHz channel spacing	3.420mW		
	Data Rate 1Mbps for 2MHz channel spacing	3.436mW		
	Data Rate 2Mbps for 2MHz channel spacing	3.436mW		
ANTENNA TYPE	Printed antenna with -2.5dBi gain			
ANTENNA CONNECTOR	NA			
DATA CABLE	NA			
I/O PORTS	Refer to user's manual			
ACCESSORY DEVICES	NA			

NOTE:

1. EUT doesn't support "hopping mode".
2. The EUT type: Single crystal.

TYPE	CRYSTAL
Single crystal	16MHz only

*Crystal: 16MHz (included) for main transmission.

3. The above EUT information is declared by the manufacturer and for more detailed features description, please refer to the manufacturer's specifications or User's Manual.

3.2 DESCRIPTION OF TEST MODES

For 1MHz channel spacing:

79 channels are provided to this EUT:

CHANNEL	FREQ. (MHz)	CHANNEL	FREQ. (MHz)	CHANNEL	FREQ. (MHz)	CHANNEL	FREQ. (MHz)
0	2402	20	2422	40	2442	60	2462
1	2403	21	2423	41	2443	61	2463
2	2404	22	2424	42	2444	62	2464
3	2405	23	2425	43	2445	63	2465
4	2406	24	2426	44	2446	64	2466
5	2407	25	2427	45	2447	65	2467
6	2408	26	2428	46	2448	66	2468
7	2409	27	2429	47	2449	67	2469
8	2410	28	2430	48	2450	68	2470
9	2411	29	2431	49	2451	69	2471
10	2412	30	2432	50	2452	70	2472
11	2413	31	2433	51	2453	71	2473
12	2414	32	2434	52	2454	72	2474
13	2415	33	2435	53	2455	73	2475
14	2416	34	2436	54	2456	74	2476
15	2417	35	2437	55	2457	75	2477
16	2418	36	2438	56	2458	76	2478
17	2419	37	2439	57	2459	77	2479
18	2420	38	2440	58	2460	78	2480
19	2421	39	2441	59	2461		

For 2MHz channel spacing:

40 channels are provided to this EUT:

CHANNEL	FREQ. (MHz)	CHANNEL	FREQ. (MHz)	CHANNEL	FREQ. (MHz)	CHANNEL	FREQ. (MHz)
0	2402	10	2422	20	2442	30	2462
1	2404	11	2424	21	2444	31	2464
2	2406	12	2426	22	2446	32	2466
3	2408	13	2428	23	2448	33	2468
4	2410	14	2430	24	2450	34	2470
5	2412	15	2432	25	2452	35	2472
6	2414	16	2434	26	2454	36	2474
7	2416	17	2436	27	2456	37	2476
8	2418	18	2438	28	2458	38	2478
9	2420	19	2440	29	2460	39	2480

3.2.1 TEST MODE APPLICABILITY AND TESTED CHANNEL DETAIL

EUT CONFIGURE MODE	APPLICABLE TO				DESCRIPTION			
	RE \geq 1G	RE<1G	PLC	APCM	EUT Type	Data rate	Bandwidth	Channel Spacing
A	√	√	√	√	Single crystal	250kbps	700kHz	1MHz
B	NOTE 2	-	-	NOTE 2		1Mbps	950kHz	1MHz
C	√	-	-	√		1Mbps	950kHz	2MHz
D	√	-	-	√		2Mbps	1800kHz	2MHz

Where **RE \geq 1G**: Radiated Emission above 1GHz **RE<1G**: Radiated Emission below 1GHz
PLC: Power Line Conducted Emission **APCM**: Antenna Port Conducted Measurement

NOTE: 1. The EUT had been pre-tested on the positioned of each 3 axis. The worst case was found when positioned on **Y-plane**.

2. For Radiated Emission above 1GHz test & Antenna Port Conducted Measurement:
After pretesting B & C, mode C was the worst case for the final test.

3. "-": Means no effect.

RADIATED EMISSION TEST (ABOVE 1 GHz):

- Pre-Scan has been conducted to determine the worst-case mode from all possible combinations between available modulations, antenna ports (if EUT with antenna diversity architecture) and packet type.
- Following channel(s) was (were) selected for the final test as listed below.

EUT CONFIGURE MODE	AVAILABLE CHANNEL	TESTED CHANNEL	MODULATION TYPE	DATA RATE
A	0 to 78	0, 39, 78	GFSK	250kbps
C	0 to 39	0, 19, 39	GFSK	1.0Mbps
D	0 to 39	0, 19, 39	GFSK	2.0Mbps

RADIATED EMISSION TEST (BELOW 1 GHz):

- Pre-Scan has been conducted to determine the worst-case mode from all possible combinations between available modulations, antenna ports (if EUT with antenna diversity architecture) and packet type.
- Following channel(s) was (were) selected for the final test as listed below.

EUT CONFIGURE MODE	AVAILABLE CHANNEL	TESTED CHANNEL	MODULATION TYPE	DATA RATE
A	0 to 39	0	GFSK	1.0Mbps

POWER LINE CONDUCTED EMISSION:

- Pre-Scan has been conducted to determine the worst-case mode from all possible combinations between available modulations, antenna ports (if EUT with antenna diversity architecture) and packet type.
- Following channel(s) was (were) selected for the final test as listed below.

EUT CONFIGURE MODE	AVAILABLE CHANNEL	TESTED CHANNEL	MODULATION TYPE	DATA RATE
A	0 to 39	0	GFSK	1.0Mbps



ANTENNA PORT CONDUCTED MEASUREMENT:

- This item includes all test value of each mode, but only includes spectrum plot of worst value of each mode.
- Pre-Scan has been conducted to determine the worst-case mode from all possible combinations between available modulations, antenna ports (if EUT with antenna diversity architecture), and packet types.
- Following channel(s) was (were) selected for the final test as listed below.

EUT CONFIGURE MODE	AVAILABLE CHANNEL	TESTED CHANNEL	MODULATION TYPE	DATA RATE
A	0 to 78	0, 39, 78	GFSK	250kbps
C	0 to 39	0, 19, 39	GFSK	1.0Mbps
D	0 to 39	0, 19, 39	GFSK	2.0Mbps

TEST CONDITION:

APPLICABLE TO	ENVIRONMENTAL CONDITIONS	INPUT POWER (SYSTEM)	TESTED BY
RE≥1G	23deg. C, 63%RH	3Vdc	Brad Tung
RE<1G	23deg. C, 63%RH	3Vdc	Brad Tung
PLC	25deg. C, 68%RH	120Vac, 60Hz	Leo Tsai
APCM	25deg. C, 60%RH	3Vdc	Cedric Wu

3.3 DESCRIPTION OF SUPPORT UNITS

The EUT has been tested as an independent unit together with other necessary accessories or support units. The following support units or accessories were used to form a representative test configuration during the tests.

NO.	PRODUCT	BRAND	MODEL NO.	SERIAL NO.	FCC ID
1	Power supply	TOPWARD	6603D	802001	NA
2	External Card	NA	NA	NA	NA

NO.	SIGNAL CABLE DESCRIPTION OF THE ABOVE SUPPORT UNITS
1	NA
2	NA

NOTE:

1. All power cords of the above support units are non shielded (1.8m).
2. Item 1 was placed under the test table.
3. Item 2 was provided by client.

3.3.1 CONFIGURATION OF SYSTEM UNDER TEST

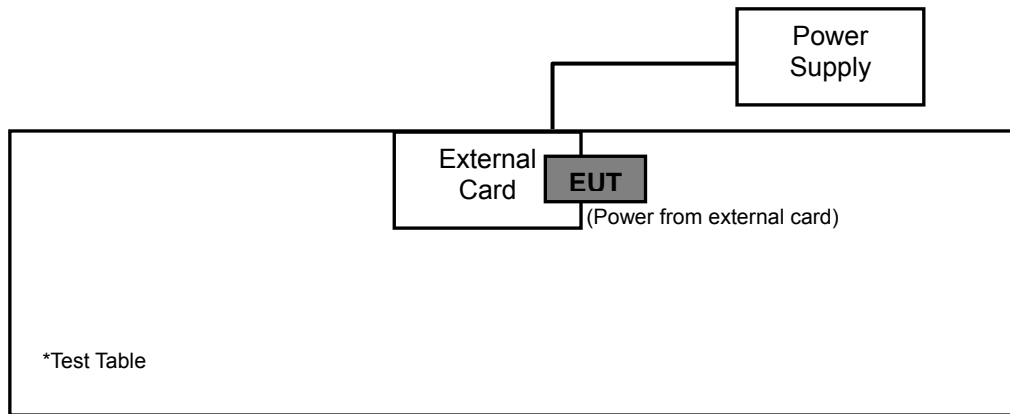

3.4 GENERAL DESCRIPTION OF APPLIED STANDARDS

The EUT is a RF Product. According to the specifications of the manufacturer, it must comply with the requirements of the following standards:

FCC Part 15, Subpart C (15.247)

Canada RSS-210 Issue 8 (2010-12)

Canada RSS-Gen Issue 3 (2010-12)

558074 D01 DTS Meas Guidance v03r01

FCC Public Notice DA 00-705

ANSI C63.10-2009

All test items have been performed and recorded as per the above standards.

4. TEST TYPES AND RESULTS

4.1 RADIATED EMISSION AND BANDEDGE MEASUREMENT

4.1.1 LIMITS OF RADIATED EMISSION AND BANDEDGE MEASUREMENT

Radiated emissions which fall in the restricted bands must comply with the radiated emission limits specified as below table. Other emissions shall be at least 20dB below the highest level of the desired power:

FREQUENCIES (MHz)	FIELD STRENGTH (microvolts/meter)	MEASUREMENT DISTANCE (meters)
0.009 ~ 0.490	2400/F(kHz)	300
0.490 ~ 1.705	24000/F(kHz)	30
1.705 ~ 30.0	30	30
30 ~ 88	100	3
88 ~ 216	150	3
216 ~ 960	200	3
Above 960	500	3

NOTE:

1. The lower limit shall apply at the transition frequencies.
2. Emission level (dBuV/m) = 20 log Emission level (uV/m).
3. For frequencies above 1000MHz, the field strength limits are based on average detector, however, the peak field strength of any emission shall not exceed the maximum permitted average limits, specified above by more than 20dB under any condition of modulation.

4.1.2 TEST INSTRUMENTS

DESCRIPTION & MANUFACTURER	MODEL NO.	SERIAL NO.	DATE OF CALIBRATION	DUE DATE OF CALIBRATION
Test Receiver ROHDE & SCHWARZ	ESCI	100424	Sep. 09, 2013	Sep. 08, 2014
Spectrum Analyzer ROHDE & SCHWARZ	FSU 43	100115	Dec. 18, 2013	Dec. 17, 2014
BILOG Antenna SCHWARZBECK	VULB9168	9168-155	Feb. 26, 2014	Feb. 25, 2015
HORN Antenna SCHWARZBECK	BBHA 9120D	9120D-404	Jan. 05, 2014	Jan. 04, 2015
HORN Antenna SCHWARZBECK	BBHA 9170	148	Jul. 15, 2013	Jul. 14, 2014
Preamplifier Agilent	8449B	3008A01961	Oct. 28, 2013	Oct. 27, 2014
Preamplifier Agilent	8447D	2944A10738	Oct. 18, 2013	Oct. 17, 2014
RF signal cable HUBER+SUHNNER	SUCOFLEX 104	309220/4	Aug. 26, 2013	Aug. 25, 2014
RF signal cable HUBER+SUHNNER	SUCOFLEX 104	250724/4	Aug. 26, 2013	Aug. 25, 2014
RF signal cable HUBER+SUHNNER	SUCOFLEX 104	295012/4	Aug. 26, 2013	Aug. 25, 2014
Software BV ADT	ADT_Radiated_ V7.6.15.9.4	NA	NA	NA
Antenna Tower inn-co GmbH	MA 4000	010303	NA	NA
Antenna Tower Controller inn-co GmbH	CO2000	019303	NA	NA
Turn Table BV ADT	TT100.	TT93021704	NA	NA
Turn Table Controller BV ADT	SC100.	SC93021704	NA	NA
High Speed Peak Power Meter	ML2495A	0824011	Jul. 29, 2013	Jul. 28, 2014
Power Sensor	MA2411B	0738171	Jul. 29, 2013	Jul. 28, 2014

- NOTE:**
1. The calibration interval of the above test instruments is 12 months and the calibrations are traceable to NML/ROC and NIST/USA.
 2. The test was performed in HwaYa Chamber 4.
 3. The horn antenna and HP preamplifier (model: 8449B) are used only for the measurement of emission frequency above 1GHz if tested.
 4. The FCC Site Registration No. is 460141.
 5. The IC Site Registration No. is IC7450F-4.

4.1.3 TEST PROCEDURES

- a. The EUT was placed on the top of a rotating table 0.8 meters above the ground at a 3 meter semi-anechoic chamber. The table was rotated 360 degrees to determine the position of the highest radiation.
- b. The EUT was set 3 meters away from the interference-receiving antenna, which was mounted on the top of a variable-height antenna tower.
- c. The antenna is a broadband antenna, and its height is varied from one meter to four meters above the ground to determine the maximum value of the field strength. Both horizontal and vertical polarizations of the antenna are set to make the measurement.
- d. For each suspected emission, the EUT was arranged to its worst case and then the antenna was tuned to heights from 1 meter to 4 meters and the rotatable table was turned from 0 degrees to 360 degrees to find the maximum reading.
- e. The test-receiver system was set to Peak Detect Function and Specified Bandwidth with Maximum Hold Mode.
- f. If the emission level of the EUT in peak mode was lower than the limit specified, then testing could be stopped and the peak values of the EUT would be reported. Otherwise the emissions would be re-tested one by one using peak, quasi-peak or average method as specified and then reported in a data sheet.

NOTE:

1. The resolution bandwidth and video bandwidth of test receiver/spectrum analyzer is 120kHz for Quasi-peak detection at frequency below 1GHz.
2. The resolution bandwidth of test receiver/spectrum analyzer is 1MHz and video bandwidth is 3MHz for Peak detection at frequency above 1GHz.
3. The resolution bandwidth of test receiver/spectrum analyzer is 1MHz and the video bandwidth is $\geq 1/T$ (Duty cycle < 98%) or 10Hz (Duty cycle > 98%) for Average detection (AV) at frequency above 1GHz.
4. All modes of operation were investigated and the worst-case emissions are reported.

4.1.4 DEVIATION FROM TEST STANDARD

No deviation.

4.1.5 TEST SETUP

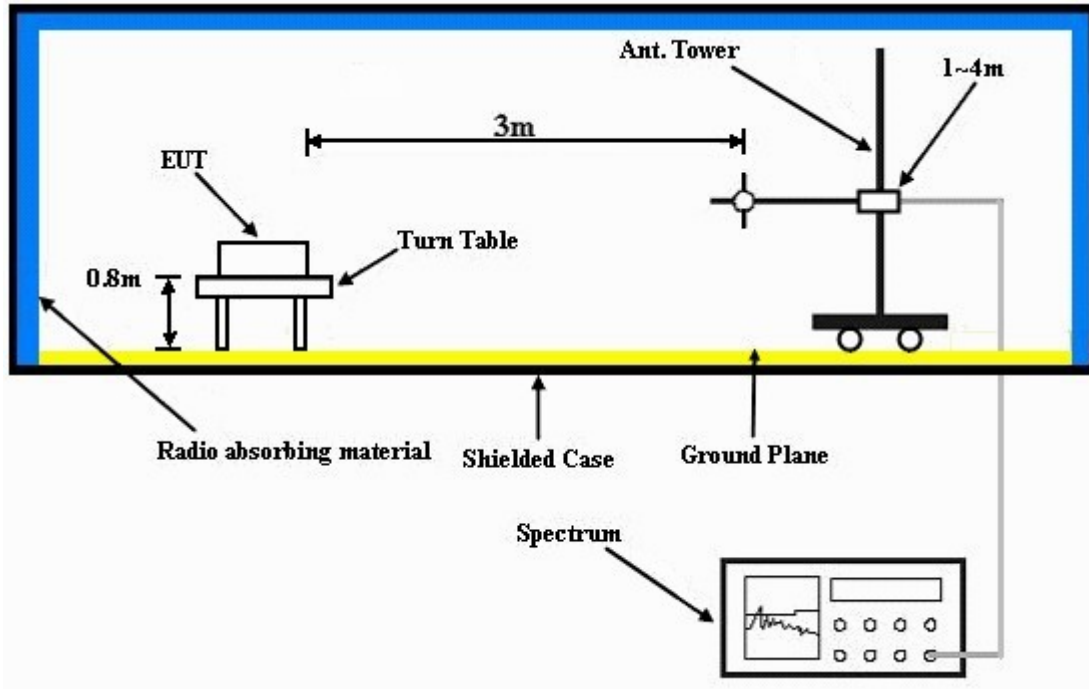

For the actual test configuration, please refer to the attached file (Test Setup Photo).

4.1.6 EUT OPERATING CONDITIONS

- a. Placed the EUT on the testing table.
- b. Set the EUT under transmission condition continuously at specific channel frequency.

4.1.7 TEST RESULTS

ABOVE 1GHz WORST-CASE DATA :

Test Mode A

EUT TEST CONDITION		MEASUREMENT DETAIL	
CHANNEL	Channel 0	FREQUENCY RANGE	1 ~ 25GHz
INPUT POWER (SYSTEM)	120Vac, 60 Hz	DETECTOR FUNCTION	Peak (PK) Average (AV)
ENVIRONMENTAL CONDITIONS	23deg. C, 63%RH	TESTED BY	Brad Tung

ANTENNA POLARITY & TEST DISTANCE: HORIZONTAL AT 3 M								
NO.	FREQ. (MHz)	EMISSION LEVEL (dBuV/m)	LIMIT (dBuV/m)	MARGIN (dB)	ANTENNA HEIGHT (m)	TABLE ANGLE (Degree)	RAW VALUE (dBuV)	CORRECTION FACTOR (dB/m)
1	2390.00	56.5 PK	74.0	-17.5	1.36 H	341	58.90	-2.40
2	2390.00	27.6 AV	54.0	-26.4	1.36 H	341	30.00	-2.40
3	#2400.00	58.6 PK	80.6	-22.0	1.36 H	341	61.00	-2.40
4	#2400.00	28.5 AV	50.5	-22.0	1.36 H	341	30.90	-2.40
5	*2402.00	100.6 PK			1.36 H	341	68.60	32.00
6	*2402.00	70.5 AV			1.36 H	341	38.50	32.00
7	4804.00	47.6 PK	74.0	-26.4	1.12 H	185	42.50	5.10
8	4804.00	17.5 AV	54.0	-36.5	1.12 H	185	12.40	5.10

ANTENNA POLARITY & TEST DISTANCE: VERTICAL AT 3 M								
NO.	FREQ. (MHz)	EMISSION LEVEL (dBuV/m)	LIMIT (dBuV/m)	MARGIN (dB)	ANTENNA HEIGHT (m)	TABLE ANGLE (Degree)	RAW VALUE (dBuV)	CORRECTION FACTOR (dB/m)
1	2390.00	50.1 PK	74.0	-23.9	1.61 V	310	52.50	-2.40
2	2390.00	27.3 AV	54.0	-26.7	1.61 V	310	29.70	-2.40
3	#2400.00	51.4 PK	73.4	-22.0	1.61 V	310	53.80	-2.40
4	#2400.00	21.3 AV	43.3	-22.0	1.61 V	310	23.70	-2.40
5	*2402.00	93.4 PK			1.61 V	310	61.40	32.00
6	*2402.00	63.3 AV			1.61 V	310	31.30	32.00
7	4804.00	47.3 PK	74.0	-26.7	1.06 V	75	42.20	5.10
8	4804.00	17.2 AV	54.0	-36.8	1.06 V	75	12.10	5.10

REMARKS:

1. Emission level (dBuV/m) = Raw Value (dBuV) + Correction Factor (dB/m).
2. Correction Factor (dB/m) = Antenna Factor (dB/m) + Cable Factor (dB).
3. The other emission levels were very low against the limit.
4. Margin value = Emission level – Limit value.
5. “ * “: Fundamental frequency.
6. “ # “: The radiated frequency is out of the restricted band.

EUT TEST CONDITION		MEASUREMENT DETAIL	
CHANNEL	Channel 39	FREQUENCY RANGE	1 ~ 25GHz
INPUT POWER (SYSTEM)	120Vac, 60 Hz	DETECTOR FUNCTION	Peak (PK) Average (AV)
ENVIRONMENTAL CONDITIONS	23deg. C, 63%RH	TESTED BY	Brad Tung

ANTENNA POLARITY & TEST DISTANCE: HORIZONTAL AT 3 M								
NO.	FREQ. (MHz)	EMISSION LEVEL (dBuV/m)	LIMIT (dBuV/m)	MARGIN (dB)	ANTENNA HEIGHT (m)	TABLE ANGLE (Degree)	RAW VALUE (dBuV)	CORRECTION FACTOR (dB/m)
1	*2441.00	98.9 PK			1.02 H	204	66.80	32.10
2	*2441.00	68.8 AV			1.02 H	204	36.70	32.10
3	4882.00	47.5 PK	74.0	-26.5	1.00 H	206	42.10	5.40
4	4882.00	17.4 AV	54.0	-36.6	1.00 H	206	12.00	5.40
ANTENNA POLARITY & TEST DISTANCE: VERTICAL AT 3 M								
NO.	FREQ. (MHz)	EMISSION LEVEL (dBuV/m)	LIMIT (dBuV/m)	MARGIN (dB)	ANTENNA HEIGHT (m)	TABLE ANGLE (Degree)	RAW VALUE (dBuV)	CORRECTION FACTOR (dB/m)
1	*2441.00	92.9 PK			1.53 V	318	60.80	32.10
2	*2441.00	62.8 AV			1.53 V	318	30.70	32.10
3	4882.00	47.4 PK	74.0	-26.6	1.00 V	80	42.00	5.40
4	4882.00	17.3 AV	54.0	-36.7	1.00 V	80	11.90	5.40

REMARKS:

1. Emission level (dBuV/m) = Raw Value (dBuV) + Correction Factor (dB/m).
2. Correction Factor (dB/m) = Antenna Factor (dB/m) + Cable Factor (dB).
3. The other emission levels were very low against the limit.
4. Margin value = Emission level – Limit value.
5. “ * “: Fundamental frequency.



A D T

EUT TEST CONDITION		MEASUREMENT DETAIL	
CHANNEL	Channel 78	FREQUENCY RANGE	1 ~ 25GHz
INPUT POWER (SYSTEM)	120Vac, 60 Hz	DETECTOR FUNCTION	Peak (PK) Average (AV)
ENVIRONMENTAL CONDITIONS	23deg. C, 63%RH	TESTED BY	Brad Tung

ANTENNA POLARITY & TEST DISTANCE: HORIZONTAL AT 3 M								
NO.	FREQ. (MHz)	EMISSION LEVEL (dBuV/m)	LIMIT (dBuV/m)	MARGIN (dB)	ANTENNA HEIGHT (m)	TABLE ANGLE (Degree)	RAW VALUE (dBuV)	CORRECTION FACTOR (dB/m)
1	*2480.00	97.5 PK			1.00 H	172	65.20	32.30
2	*2480.00	67.4 AV			1.00 H	172	35.10	32.30
3	2483.50	45.5 PK	74.0	-28.5	1.00 H	172	47.40	-1.90
4	2483.50	15.4 AV	54.0	-38.6	1.00 H	172	17.30	-1.90
5	4960.00	41.8 PK	74.0	-32.2	1.15 H	224	36.30	5.50
6	4960.00	11.7 AV	54.0	-42.3	1.15 H	224	6.20	5.50
ANTENNA POLARITY & TEST DISTANCE: VERTICAL AT 3 M								
NO.	FREQ. (MHz)	EMISSION LEVEL (dBuV/m)	LIMIT (dBuV/m)	MARGIN (dB)	ANTENNA HEIGHT (m)	TABLE ANGLE (Degree)	RAW VALUE (dBuV)	CORRECTION FACTOR (dB/m)
1	*2480.00	91.5 PK			1.43 V	300	59.20	32.30
2	*2480.00	61.4 AV			1.43 V	300	29.10	32.30
3	2483.50	39.5 PK	74.0	-34.5	1.43 V	300	41.40	-1.90
4	2483.50	9.4 AV	54.0	-44.6	1.43 V	300	11.30	-1.90
5	4960.00	41.6 PK	74.0	-32.4	1.00 V	96	36.10	5.50
6	4960.00	11.5 AV	54.0	-42.5	1.00 V	96	6.00	5.50

REMARKS:

1. Emission level (dBuV/m) = Raw Value (dBuV) + Correction Factor (dB/m).
2. Correction Factor (dB/m) = Antenna Factor (dB/m) + Cable Factor (dB).
3. The other emission levels were very low against the limit.
4. Margin value = Emission level – Limit value.
5. “ * “: Fundamental frequency.



A D T

Test Mode C

EUT TEST CONDITION		MEASUREMENT DETAIL	
CHANNEL	Channel 0	FREQUENCY RANGE	1 ~ 25GHz
INPUT POWER (SYSTEM)	120Vac, 60 Hz	DETECTOR FUNCTION	Peak (PK) Average (AV)
ENVIRONMENTAL CONDITIONS	23deg. C, 63%RH	TESTED BY	Brad Tung

ANTENNA POLARITY & TEST DISTANCE: HORIZONTAL AT 3 M								
NO.	FREQ. (MHz)	EMISSION LEVEL (dBuV/m)	LIMIT (dBuV/m)	MARGIN (dB)	ANTENNA HEIGHT (m)	TABLE ANGLE (Degree)	RAW VALUE (dBuV)	CORRECTION FACTOR (dB/m)
1	2390.00	61.6 PK	74.0	-12.4	1.34 H	0	64.00	-2.40
2	2390.00	31.0 AV	54.0	-23.0	1.34 H	0	33.40	-2.40
3	*2402.00	100.0 PK			1.34 H	0	68.00	32.00
4	*2402.00	94.2 AV			1.34 H	0	62.20	32.00
5	4804.00	50.5 PK	74.0	-23.5	1.13 H	102	45.90	4.60
6	4804.00	36.6 AV	54.0	-17.4	1.13 H	102	32.00	4.60
ANTENNA POLARITY & TEST DISTANCE: VERTICAL AT 3 M								
NO.	FREQ. (MHz)	EMISSION LEVEL (dBuV/m)	LIMIT (dBuV/m)	MARGIN (dB)	ANTENNA HEIGHT (m)	TABLE ANGLE (Degree)	RAW VALUE (dBuV)	CORRECTION FACTOR (dB/m)
1	2390.00	56.8 PK	74.0	-17.2	1.00 V	287	59.20	-2.40
2	2390.00	30.5 AV	54.0	-23.5	1.00 V	287	32.90	-2.40
3	*2402.00	94.0 PK			1.00 V	287	62.00	32.00
4	*2402.00	88.0 AV			1.00 V	287	56.00	32.00
5	4804.00	50.2 PK	74.0	-23.8	1.05 V	90	45.60	4.60
6	4804.00	36.1 AV	54.0	-17.9	1.05 V	90	31.50	4.60

REMARKS:

1. Emission level (dBuV/m) = Raw Value (dBuV) + Correction Factor (dB/m).
2. Correction Factor (dB/m) = Antenna Factor (dB/m) + Cable Factor (dB).
3. The other emission levels were very low against the limit.
4. Margin value = Emission level – Limit value.
5. “ * “: Fundamental frequency.

EUT TEST CONDITION		MEASUREMENT DETAIL	
CHANNEL	Channel 19	FREQUENCY RANGE	1 ~ 25GHz
INPUT POWER (SYSTEM)	120Vac, 60 Hz	DETECTOR FUNCTION	Peak (PK) Average (AV)
ENVIRONMENTAL CONDITIONS	23deg. C, 63%RH	TESTED BY	Brad Tung

ANTENNA POLARITY & TEST DISTANCE: HORIZONTAL AT 3 M								
NO.	FREQ. (MHz)	EMISSION LEVEL (dBuV/m)	LIMIT (dBuV/m)	MARGIN (dB)	ANTENNA HEIGHT (m)	TABLE ANGLE (Degree)	RAW VALUE (dBuV)	CORRECTION FACTOR (dB/m)
1	*2440.00	99.1 PK			1.28 H	4	67.00	32.10
2	*2440.00	93.7 AV			1.28 H	4	61.60	32.10
3	4880.00	50.4 PK	74.0	-23.6	1.09 H	90	45.40	5.00
4	4880.00	36.4 AV	54.0	-17.6	1.09 H	90	31.40	5.00
ANTENNA POLARITY & TEST DISTANCE: VERTICAL AT 3 M								
NO.	FREQ. (MHz)	EMISSION LEVEL (dBuV/m)	LIMIT (dBuV/m)	MARGIN (dB)	ANTENNA HEIGHT (m)	TABLE ANGLE (Degree)	RAW VALUE (dBuV)	CORRECTION FACTOR (dB/m)
1	*2440.00	93.1 PK			1.00 V	300	61.00	32.10
2	*2440.00	87.5 AV			1.00 V	300	55.40	32.10
3	4880.00	50.2 PK	74.0	-23.8	1.07 V	100	45.20	5.00
4	4880.00	36.1 AV	54.0	-17.9	1.07 V	100	31.10	5.00

REMARKS:

1. Emission level (dBuV/m) = Raw Value (dBuV) + Correction Factor (dB/m).
2. Correction Factor (dB/m) = Antenna Factor (dB/m) + Cable Factor (dB).
3. The other emission levels were very low against the limit.
4. Margin value = Emission level – Limit value.
5. “ * “: Fundamental frequency.



A D T

EUT TEST CONDITION		MEASUREMENT DETAIL	
CHANNEL	Channel 39	FREQUENCY RANGE	1 ~ 25GHz
INPUT POWER (SYSTEM)	120Vac, 60 Hz	DETECTOR FUNCTION	Peak (PK) Average (AV)
ENVIRONMENTAL CONDITIONS	23deg. C, 63%RH	TESTED BY	Brad Tung

ANTENNA POLARITY & TEST DISTANCE: HORIZONTAL AT 3 M								
NO.	FREQ. (MHz)	EMISSION LEVEL (dBuV/m)	LIMIT (dBuV/m)	MARGIN (dB)	ANTENNA HEIGHT (m)	TABLE ANGLE (Degree)	RAW VALUE (dBuV)	CORRECTION FACTOR (dB/m)
1	*2480.00	97.3 PK			1.23 H	333	65.00	32.30
2	*2480.00	90.9 AV			1.23 H	333	58.60	32.30
3	2483.50	48.2 PK	74.0	-25.8	1.23 H	333	50.10	-1.90
4	2483.50	30.4 AV	54.0	-23.6	1.23 H	333	32.30	-1.90
5	4960.00	50.4 PK	74.0	-23.6	1.14 H	152	45.40	5.00
6	4960.00	36.6 AV	54.0	-17.4	1.14 H	152	31.60	5.00
ANTENNA POLARITY & TEST DISTANCE: VERTICAL AT 3 M								
NO.	FREQ. (MHz)	EMISSION LEVEL (dBuV/m)	LIMIT (dBuV/m)	MARGIN (dB)	ANTENNA HEIGHT (m)	TABLE ANGLE (Degree)	RAW VALUE (dBuV)	CORRECTION FACTOR (dB/m)
1	*2480.00	92.3 PK			1.00 V	280	60.00	32.30
2	*2480.00	86.5 AV			1.00 V	280	54.20	32.30
3	2483.50	43.2 PK	74.0	-30.8	1.00 V	280	45.10	-1.90
4	2483.50	29.4 AV	54.0	-24.6	1.00 V	280	31.30	-1.90
5	4960.00	50.4 PK	74.0	-23.6	1.10 V	60	45.40	5.00
6	4960.00	36.3 AV	54.0	-17.7	1.10 V	60	31.30	5.00

REMARKS:

1. Emission level (dBuV/m) = Raw Value (dBuV) + Correction Factor (dB/m).
2. Correction Factor (dB/m) = Antenna Factor (dB/m) + Cable Factor (dB).
3. The other emission levels were very low against the limit.
4. Margin value = Emission level – Limit value.
5. “ * “: Fundamental frequency.

Test Mode D

EUT TEST CONDITION		MEASUREMENT DETAIL	
CHANNEL	Channel 0	FREQUENCY RANGE	1 ~ 25GHz
INPUT POWER (SYSTEM)	120Vac, 60 Hz	DETECTOR FUNCTION	Peak (PK) Average (AV)
ENVIRONMENTAL CONDITIONS	23deg. C, 63%RH	TESTED BY	Brad Tung

ANTENNA POLARITY & TEST DISTANCE: HORIZONTAL AT 3 M								
NO.	FREQ. (MHz)	EMISSION LEVEL (dBuV/m)	LIMIT (dBuV/m)	MARGIN (dB)	ANTENNA HEIGHT (m)	TABLE ANGLE (Degree)	RAW VALUE (dBuV)	CORRECTION FACTOR (dB/m)
1	2390.00	61.8 PK	74.0	-12.2	1.34 H	325	64.20	-2.40
2	2390.00	31.1 AV	54.0	-22.9	1.34 H	325	33.50	-2.40
3	*2402.00	100.1 PK			1.34 H	325	68.10	32.00
4	*2402.00	94.6 AV			1.34 H	325	62.60	32.00
5	4804.00	50.6 PK	74.0	-23.4	1.20 H	103	45.50	5.10
6	4804.00	36.6 AV	54.0	-17.4	1.20 H	103	31.50	5.10
ANTENNA POLARITY & TEST DISTANCE: VERTICAL AT 3 M								
NO.	FREQ. (MHz)	EMISSION LEVEL (dBuV/m)	LIMIT (dBuV/m)	MARGIN (dB)	ANTENNA HEIGHT (m)	TABLE ANGLE (Degree)	RAW VALUE (dBuV)	CORRECTION FACTOR (dB/m)
1	2390.00	56.4 PK	74.0	-17.6	1.00 V	306	58.80	-2.40
2	2390.00	30.3 AV	54.0	-23.7	1.00 V	306	32.70	-2.40
3	*2402.00	93.5 PK			1.00 V	306	61.50	32.00
4	*2402.00	87.6 AV			1.00 V	306	55.60	32.00
5	4804.00	50.3 PK	74.0	-23.7	1.03 V	82	45.20	5.10
6	4804.00	36.0 AV	54.0	-18.0	1.03 V	82	30.90	5.10

REMARKS:

1. Emission level (dBuV/m) = Raw Value (dBuV) + Correction Factor (dB/m).
2. Correction Factor (dB/m) = Antenna Factor (dB/m) + Cable Factor (dB).
3. The other emission levels were very low against the limit.
4. Margin value = Emission level – Limit value.
5. “ * ”: Fundamental frequency.



EUT TEST CONDITION		MEASUREMENT DETAIL	
CHANNEL	Channel 19	FREQUENCY RANGE	1 ~ 25GHz
INPUT POWER (SYSTEM)	120Vac, 60 Hz	DETECTOR FUNCTION	Peak (PK) Average (AV)
ENVIRONMENTAL CONDITIONS	23deg. C, 63%RH	TESTED BY	Brad Tung

ANTENNA POLARITY & TEST DISTANCE: HORIZONTAL AT 3 M								
NO.	FREQ. (MHz)	EMISSION LEVEL (dBuV/m)	LIMIT (dBuV/m)	MARGIN (dB)	ANTENNA HEIGHT (m)	TABLE ANGLE (Degree)	RAW VALUE (dBuV)	CORRECTION FACTOR (dB/m)
1	*2440.00	99.0 PK			1.29 H	346	66.90	32.10
2	*2440.00	92.9 AV			1.29 H	346	60.80	32.10
3	4880.00	50.6 PK	74.0	-23.4	1.16 H	137	45.20	5.40
4	4880.00	36.4 AV	54.0	-17.6	1.16 H	137	31.00	5.40
ANTENNA POLARITY & TEST DISTANCE: VERTICAL AT 3 M								
NO.	FREQ. (MHz)	EMISSION LEVEL (dBuV/m)	LIMIT (dBuV/m)	MARGIN (dB)	ANTENNA HEIGHT (m)	TABLE ANGLE (Degree)	RAW VALUE (dBuV)	CORRECTION FACTOR (dB/m)
1	*2440.00	93.0 PK			1.00 V	300	60.90	32.10
2	*2440.00	87.1 AV			1.00 V	300	55.00	32.10
3	4880.00	50.1 PK	74.0	-23.9	1.06 V	75	44.70	5.40
4	4880.00	36.5 AV	54.0	-17.5	1.06 V	75	31.10	5.40

REMARKS:

1. Emission level (dBuV/m) = Raw Value (dBuV) + Correction Factor (dB/m).
2. Correction Factor (dB/m) = Antenna Factor (dB/m) + Cable Factor (dB).
3. The other emission levels were very low against the limit.
4. Margin value = Emission level – Limit value.
5. “ * “: Fundamental frequency.



A D T

EUT TEST CONDITION		MEASUREMENT DETAIL	
CHANNEL	Channel 39	FREQUENCY RANGE	1 ~ 25GHz
INPUT POWER (SYSTEM)	120Vac, 60 Hz	DETECTOR FUNCTION	Peak (PK) Average (AV)
ENVIRONMENTAL CONDITIONS	23deg. C, 63%RH	TESTED BY	Brad Tung

ANTENNA POLARITY & TEST DISTANCE: HORIZONTAL AT 3 M								
NO.	FREQ. (MHz)	EMISSION LEVEL (dBuV/m)	LIMIT (dBuV/m)	MARGIN (dB)	ANTENNA HEIGHT (m)	TABLE ANGLE (Degree)	RAW VALUE (dBuV)	CORRECTION FACTOR (dB/m)
1	*2480.00	98.2 PK			1.30 H	326	65.90	32.30
2	*2480.00	91.5 AV			1.30 H	326	59.20	32.30
3	2483.50	46.2 PK	74.0	-27.8	1.30 H	326	48.10	-1.90
4	2483.50	28.6 AV	54.0	-25.4	1.30 H	326	30.50	-1.90
5	4960.00	50.6 PK	74.0	-23.4	1.11 H	126	45.10	5.50
6	4960.00	36.7 AV	54.0	-17.3	1.11 H	126	31.20	5.50
ANTENNA POLARITY & TEST DISTANCE: VERTICAL AT 3 M								
NO.	FREQ. (MHz)	EMISSION LEVEL (dBuV/m)	LIMIT (dBuV/m)	MARGIN (dB)	ANTENNA HEIGHT (m)	TABLE ANGLE (Degree)	RAW VALUE (dBuV)	CORRECTION FACTOR (dB/m)
1	*2480.00	92.2 PK			1.00 V	285	59.90	32.30
2	*2480.00	86.4 AV			1.00 V	285	54.10	32.30
3	2483.50	43.2 PK	74.0	-30.8	1.00 V	285	45.10	-1.90
4	2483.50	29.1 AV	54.0	-24.9	1.00 V	285	31.00	-1.90
5	4960.00	50.4 PK	74.0	-23.6	1.02 V	53	44.90	5.50
6	4960.00	36.7 AV	54.0	-17.3	1.02 V	53	31.20	5.50

REMARKS:

1. Emission level (dBuV/m) = Raw Value (dBuV) + Correction Factor (dB/m).
2. Correction Factor (dB/m) = Antenna Factor (dB/m) + Cable Factor (dB).
3. The other emission levels were very low against the limit.
4. Margin value = Emission level – Limit value.
5. “ * “: Fundamental frequency.

BELOW 1GHz WORST-CASE DATA :

Test Mode A

EUT TEST CONDITION		MEASUREMENT DETAIL	
CHANNEL	Channel 0	FREQUENCY RANGE	Below 1000MHz
INPUT POWER (SYSTEM)	120Vac, 60 Hz	DETECTOR FUNCTION	Quasi-Peak
ENVIRONMENTAL CONDITIONS	24deg. C, 69%RH	TESTED BY	Ted Chang

ANTENNA POLARITY & TEST DISTANCE: HORIZONTAL AT 3 M								
NO.	FREQ. (MHz)	EMISSION LEVEL (dBuV/m)	LIMIT (dBuV/m)	MARGIN (dB)	ANTENNA HEIGHT (m)	TABLE ANGLE (Degree)	RAW VALUE (dBuV)	CORRECTION FACTOR (dB/m)
1	165.73	28.7 QP	43.5	-14.8	1.25 H	147	42.60	-13.90
2	198.71	27.5 QP	43.5	-16.0	1.49 H	12	44.20	-16.70
3	212.30	26.0 QP	43.5	-17.5	1.00 H	201	42.30	-16.30
4	286.03	29.0 QP	46.0	-17.0	2.00 H	310	41.70	-12.70
5	311.26	33.1 QP	46.0	-12.9	1.49 H	298	45.20	-12.10
6	377.23	27.6 QP	46.0	-18.4	1.00 H	111	38.60	-11.00

ANTENNA POLARITY & TEST DISTANCE: VERTICAL AT 3 M								
NO.	FREQ. (MHz)	EMISSION LEVEL (dBuV/m)	LIMIT (dBuV/m)	MARGIN (dB)	ANTENNA HEIGHT (m)	TABLE ANGLE (Degree)	RAW VALUE (dBuV)	CORRECTION FACTOR (dB/m)
1	47.36	28.6 QP	40.0	-11.4	1.00 V	201	42.80	-14.20
2	142.44	31.1 QP	43.5	-12.4	1.50 V	69	45.20	-14.10
3	198.71	32.2 QP	43.5	-11.3	1.25 V	246	48.90	-16.70
4	299.62	34.1 QP	46.0	-11.9	2.00 V	203	46.50	-12.40
5	383.05	33.0 QP	46.0	-13.0	1.00 V	145	43.90	-10.90
6	532.46	32.0 QP	46.0	-14.0	1.00 V	251	40.40	-8.40

REMARKS:

1. Emission level (dBuV/m) = Raw Value (dBuV) + Correction Factor (dB/m).
2. Correction Factor (dB/m) = Antenna Factor (dB/m) + Cable Factor (dB).
3. The other emission levels were very low against the limit.
4. Margin value = Emission level – Limit value.

4.2 CONDUCTED EMISSION MEASUREMENT

4.2.1 LIMITS OF CONDUCTED EMISSION MEASUREMENT

FREQUENCY OF EMISSION (MHz)	CONDUCTED LIMIT (dB μ V)	
	Quasi-peak	Average
0.15 ~ 0.5	66 to 56	56 to 46
0.5 ~ 5	56	46
5 ~ 30	60	50

- NOTE:** 1. The lower limit shall apply at the transition frequencies.
 2. The limit decreases in line with the logarithm of the frequency in the range of 0.15 to 0.50MHz.
 3. All emanations from a class A/B digital device or system, including any network of conductors and apparatus connected thereto, shall not exceed the level of field strengths specified above.

4.2.2 TEST INSTRUMENTS

DESCRIPTION & MANUFACTURER	MODEL NO.	SERIAL NO.	DATE OF CALIBRATION	DUE DATE OF CALIBRATION
Test Receiver ROHDE & SCHWARZ	ESCS30	100289	Nov. 29, 2013	Nov. 28, 2014
RF signal cable Woken	5D-FB	Cable-HYC01-01	Dec. 27, 2013	Dec. 26, 2014
LISN ROHDE & SCHWARZ (EUT)	ESH3-Z5	835239/001	Feb. 13, 2014	Feb. 12, 2015
LISN ROHDE & SCHWARZ (Peripheral)	ESH3-Z5	100311	Jul. 17, 2013	Jul. 16, 2014
Software ADT	BV ADT_Cond_ V7.3.7.3	NA	NA	NA

- NOTE:** 1. The calibration interval of the above test instruments is 12 months and the calibrations are traceable to NML/ROC and NIST/USA.
 2. The test was performed in HwaYa Shielded Room 1.
 3. The VCCI Site Registration No. is C-2040.

4.2.3 TEST PROCEDURES

- a. The EUT was placed 0.4 meters from the conducting wall of the shielded room with EUT being connected to the power mains through a line impedance stabilization network (LISN). Other support units were connected to the power mains through another LISN. The two LISNs provide 50 ohm/ 50uH of coupling impedance for the measuring instrument.
- b. Both lines of the power mains connected to the EUT were checked for maximum conducted interference.
- c. The frequency range from 150kHz to 30MHz was searched. Emission levels under (Limit - 20dB) was not recorded.

NOTE: All modes of operation were investigated and the worst-case emissions are reported.

4.2.4 DEVIATION FROM TEST STANDARD

No deviation.

4.2.5 TEST SETUP

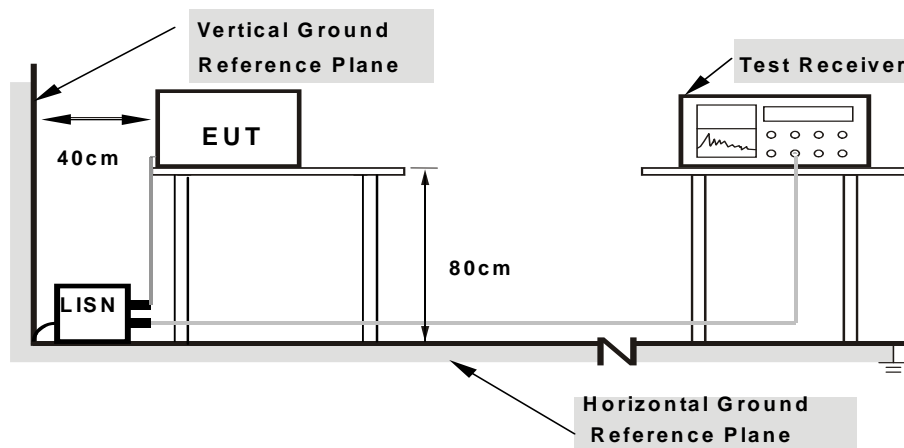

- Note:**
1. Support units were connected to second LISN.
 2. Both of LISNs (AMN) are 80 cm from EUT and at least 80 cm from other units and other metal planes

For the actual test configuration, please refer to the attached file (Test Setup Photo).

4.2.6 EUT OPERATING CONDITIONS

Same as 4.1.6.

4.2.7 TEST RESULTS

CONDUCTED WORST-CASE DATA :

Test Mode A

PHASE	Line 1	6dB BANDWIDTH	9kHz
-------	--------	---------------	------

No	Freq. [MHz]	Corr. Factor (dB)	Reading Value		Emission Level		Limit		Margin	
			[dB (uV)]		[dB (uV)]		[dB (uV)]		(dB)	
			Q.P.	AV.	Q.P.	AV.	Q.P.	AV.	Q.P.	AV.
1	0.28513	0.07	13.97	8.33	14.04	8.40	60.67	50.67	-46.62	-42.26
2	0.64266	0.09	7.81	3.49	7.90	3.58	56.00	46.00	-48.10	-42.42
3	1.61011	0.13	5.84	2.82	5.97	2.95	56.00	46.00	-50.03	-43.05
4	5.11179	0.28	6.56	3.53	6.84	3.81	60.00	50.00	-53.16	-46.19
5	8.07166	0.42	9.29	4.80	9.71	5.22	60.00	50.00	-50.29	-44.78
6	25.27175	1.20	7.20	5.76	8.40	6.96	60.00	50.00	-51.60	-43.04

- REMARKS:**
1. Q.P. and AV. are abbreviations of quasi-peak and average individually.
 2. The emission levels of other frequencies were very low against the limit.
 3. Margin value = Emission level - Limit value
 4. Correction factor = Insertion loss + Cable loss
 5. Emission Level = Correction Factor + Reading Value.

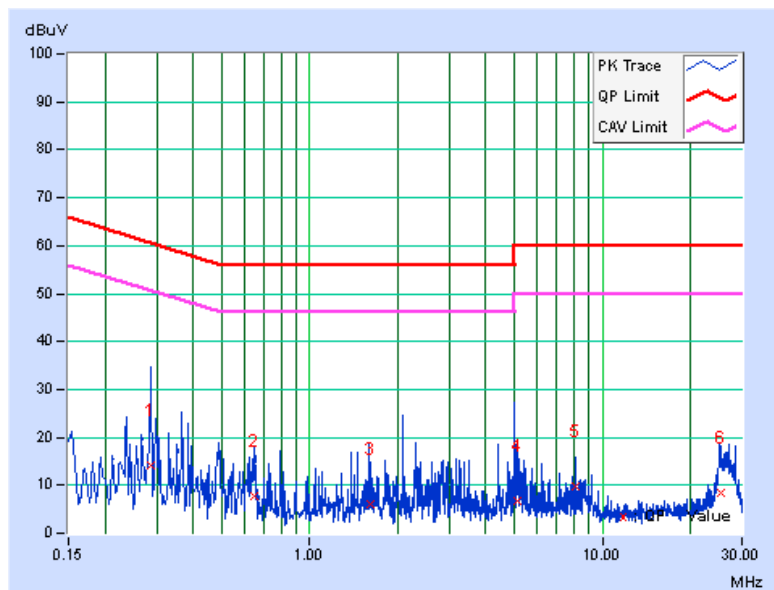

PHASE	Line 2	6dB BANDWIDTH	9kHz
--------------	--------	----------------------	------

No	Freq. [MHz]	Corr. Factor (dB)	Reading Value		Emission Level		Limit		Margin	
			[dB (uV)]		[dB (uV)]		[dB (uV)]		(dB)	
			Q.P.	AV.	Q.P.	AV.	Q.P.	AV.	Q.P.	AV.
1	0.19003	0.05	12.46	6.65	12.51	6.70	64.04	54.04	-51.53	-47.34
2	0.34560	0.06	11.71	4.06	11.77	4.12	59.07	49.07	-47.29	-44.94
3	0.72465	0.08	17.48	7.21	17.56	7.29	56.00	46.00	-38.44	-38.71
4	2.18573	0.15	7.00	3.14	7.15	3.29	56.00	46.00	-48.85	-42.71
5	8.69399	0.39	6.92	2.31	7.31	2.70	60.00	50.00	-52.69	-47.30
6	25.99901	1.04	14.07	9.81	15.11	10.85	60.00	50.00	-44.89	-39.15

- REMARKS:**
1. Q.P. and AV. are abbreviations of quasi-peak and average individually.
 2. The emission levels of other frequencies were very low against the limit.
 3. Margin value = Emission level - Limit value
 4. Correction factor = Insertion loss + Cable loss
 5. Emission Level = Correction Factor + Reading Value.

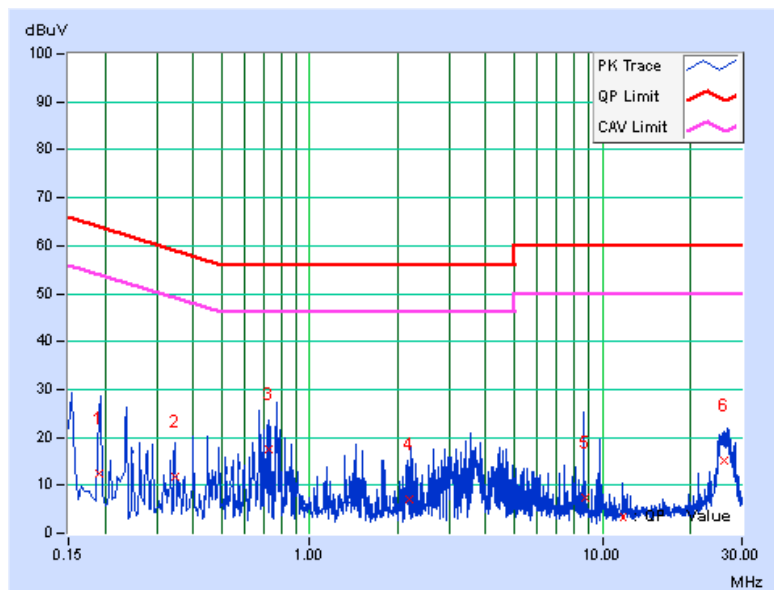

4.3 6dB BANDWIDTH MEASUREMENT

4.3.1 LIMITS OF 6dB BANDWIDTH MEASUREMENT

The minimum of 6dB Bandwidth Measurement is 0.5 MHz.

4.3.2 TEST SETUP

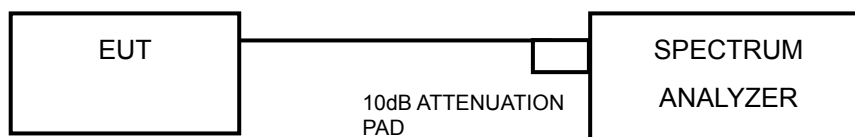

4.3.3 TEST INSTRUMENTS

Refer to section 4.1.2 to get information of above instrument.

4.3.4 TEST PROCEDURE

1. Set resolution bandwidth (RBW) = 100kHz
2. Set the video bandwidth (VBW) $\geq 3 \times$ RBW, Detector = Peak.
3. Trace mode = max hold.
4. Sweep = auto couple.
5. Measure the maximum width of the emission that is constrained by the frequencies associated with the two amplitude points (upper and lower) that are attenuated by 6 dB relative to the maximum level measured in the fundamental emission.

4.3.5 DEVIATION FROM TEST STANDARD

No deviation.

4.3.6 EUT OPERATING CONDITIONS

The software provided by client to enable the EUT under transmission condition continuously at lowest, middle and highest channel frequencies individually.

4.3.7 TEST RESULTS

Test Mode A

CHANNEL	FREQUENCY (MHz)	6dB BANDWIDTH (kHz)	MINIMUM LIMIT (MHz)	PASS / FAIL
0	2402	0.57	0.5	PASS
39	2441	0.57	0.5	PASS
78	2480	0.55	0.5	PASS

Test Mode C

CHANNEL	FREQUENCY (MHz)	6dB BANDWIDTH (kHz)	MINIMUM LIMIT (MHz)	PASS / FAIL
0	2402	0.58	0.5	PASS
19	2440	0.56	0.5	PASS
39	2480	0.56	0.5	PASS

Test Mode D

CHANNEL	FREQUENCY (MHz)	6dB BANDWIDTH (kHz)	MINIMUM LIMIT (MHz)	PASS / FAIL
0	2402	0.88	0.5	PASS
19	2440	0.81	0.5	PASS
39	2480	0.89	0.5	PASS



A D T

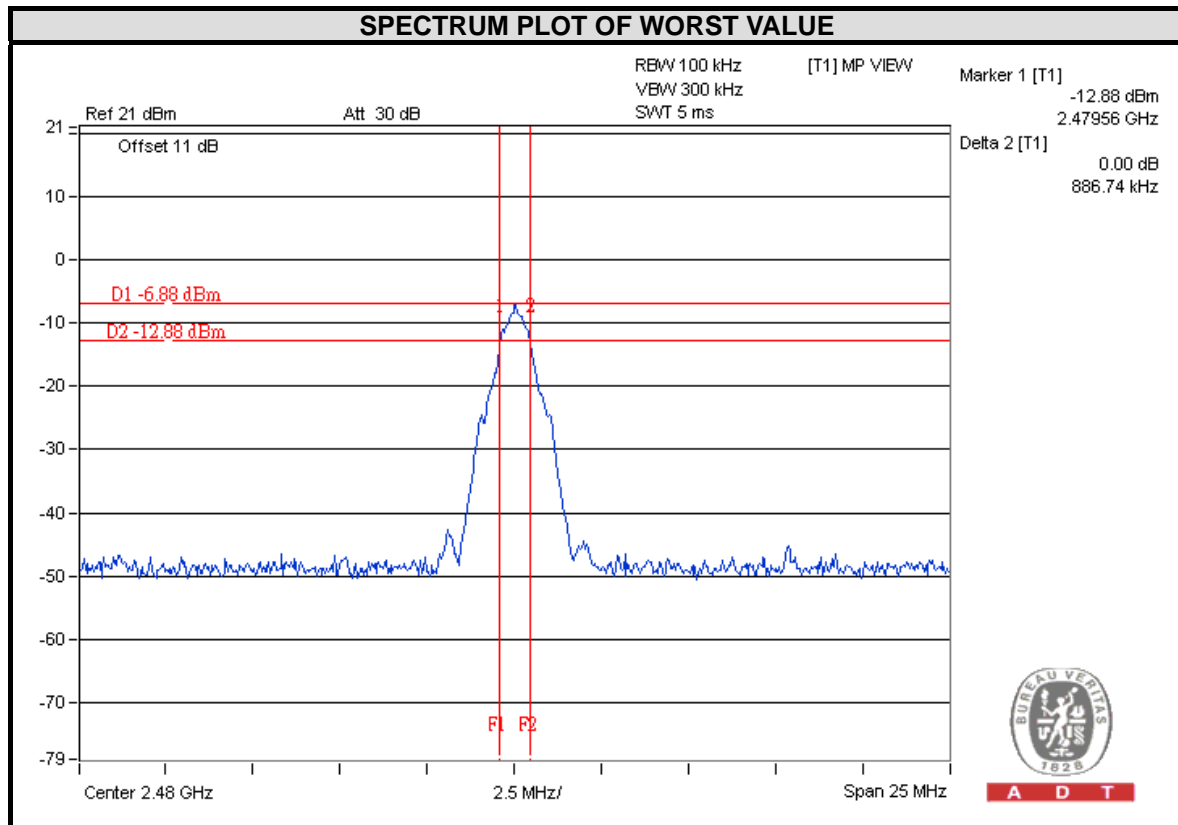

A D T

4.4 CONDUCTED OUTPUT POWER

4.4.1 LIMITS OF CONDUCTED OUTPUT POWER MEASUREMENT

For systems using digital modulation in the 2400–2483.5 MHz: 1 Watt (30dBm)

4.4.2 TEST SETUP

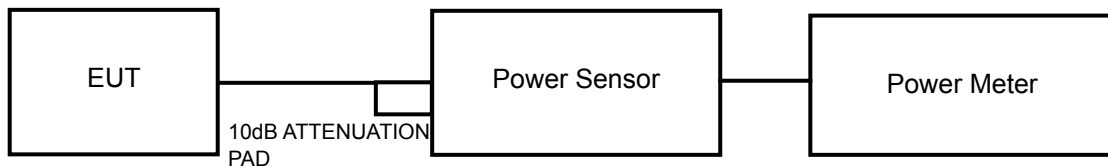

4.4.3 TEST INSTRUMENTS

Refer to section 4.1.2 to get information of above instrument.

4.4.4 TEST PROCEDURES

A peak power sensor was used on the output port of the EUT. A power meter was used to read the response of the peak power sensor. Record the peak power level.

4.4.5 DEVIATION FROM TEST STANDARD

No deviation.

4.4.6 EUT OPERATING CONDITIONS

Same as Item 4.3.6.

4.4.7 TEST RESULTS

Test Mode A

CHANNEL	FREQUENCY (MHz)	PEAK POWER (mW)	PEAK POWER (dBm)	LIMIT (dBm)	PASS/FAIL
0	2402	3.420	5.34	30	PASS
39	2441	3.412	5.33	30	PASS
78	2480	3.327	5.22	30	PASS

Test Mode C

CHANNEL	FREQUENCY (MHz)	PEAK POWER (mW)	PEAK POWER (dBm)	LIMIT (dBm)	PASS/FAIL
0	2402	3.436	5.36	30	PASS
19	2440	3.412	5.33	30	PASS
39	2480	3.304	5.19	30	PASS

Test Mode D

CHANNEL	FREQUENCY (MHz)	PEAK POWER (mW)	PEAK POWER (dBm)	LIMIT (dBm)	PASS/FAIL
0	2402	3.412	5.33	30	PASS
19	2440	3.436	5.36	30	PASS
39	2480	3.319	5.21	30	PASS

4.5 POWER SPECTRAL DENSITY MEASUREMENT

4.5.1 LIMITS OF POWER SPECTRAL DENSITY MEASUREMENT

The Maximum of Power Spectral Density Measurement is 8dBm.

4.5.2 TEST SETUP

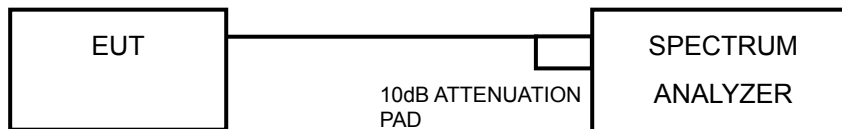

4.5.3 TEST INSTRUMENTS

Refer to section 4.1.2 to get information of above instrument.

4.5.4 TEST PROCEDURE

- a. Set resolution bandwidth (RBW) = approximately 1% of the emission bandwidth
- b. Set the video bandwidth (VBW) $\geq 3 \times$ RBW, Detector = Peak.
- c. Trace mode = max hold.
- d. Sweep = auto couple.
- e. Measure the maximum width of the emission that is constrained by the frequencies associated with the two amplitude points (upper and lower) that are attenuated by 6 dB relative to the maximum level measured in the fundamental emission

4.5.5 DEVIATION FROM TEST STANDARD

No deviation.

4.5.6 EUT OPERATING CONDITION

Same as Item 4.3.6

4.5.7 TEST RESULTS

Test Mode A

Channel	FREQ. (MHz)	PSD (dBm/3kHz)	Limit (dBm/3kHz)	PASS /FAIL
0	2402	-15.56	8	PASS
39	2441	-14.36	8	PASS
78	2480	-15.61	8	PASS

Test Mode C

Channel	FREQ. (MHz)	PSD (dBm/3kHz)	Limit (dBm/3kHz)	PASS /FAIL
0	2402	-14.09	8	PASS
19	2440	-16.84	8	PASS
39	2480	-16.77	8	PASS

Test Mode D

Channel	FREQ. (MHz)	PSD (dBm/3kHz)	Limit (dBm/3kHz)	PASS /FAIL
0	2402	-19.61	8	PASS
19	2440	-19.75	8	PASS
39	2480	-19.25	8	PASS



A D T

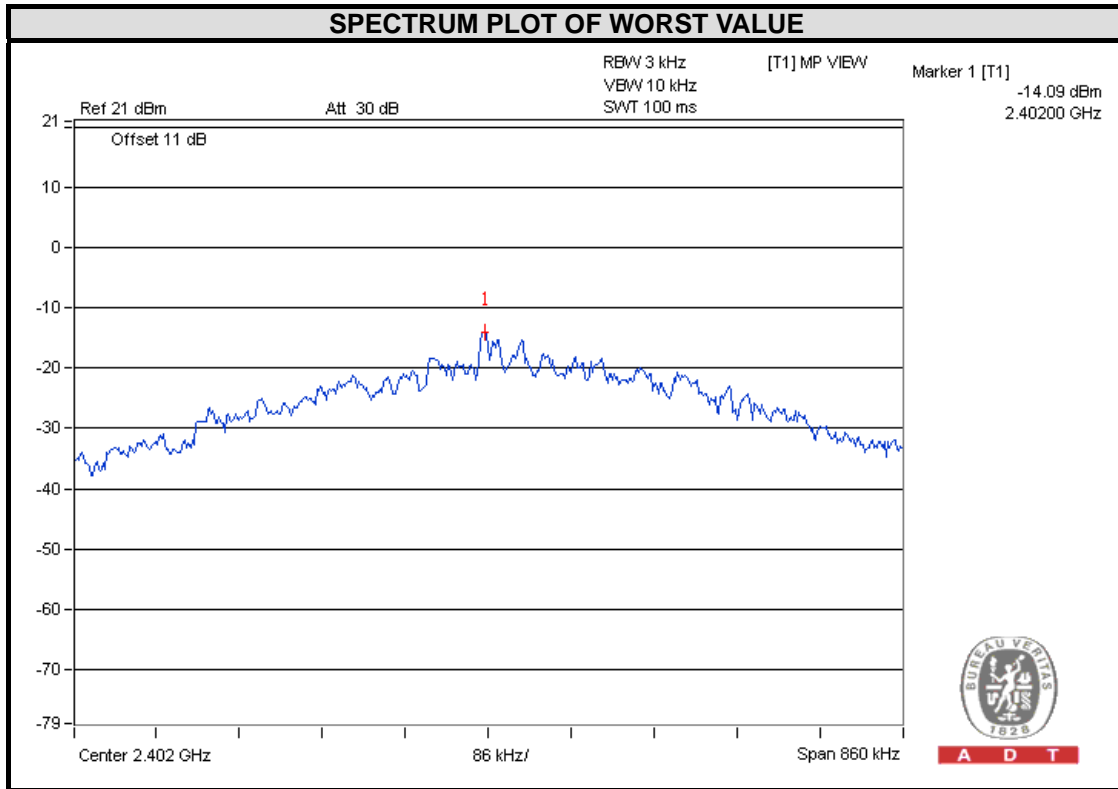

4.6 OCCUPIED BANDWIDTH MEASUREMENT

4.6.1 TEST SETUP

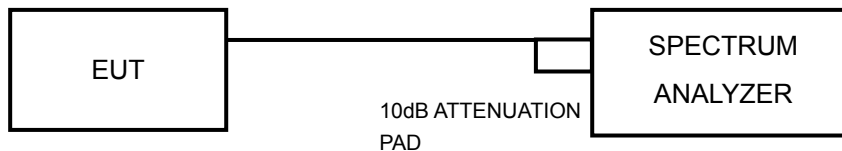

4.6.2 TEST INSTRUMENTS

Refer to section 4.1.2 to get information of above instrument.

4.6.3 TEST PROCEDURE

The transmitter output was connected to the spectrum analyzer through an attenuator. The bandwidth of the fundamental frequency was measured by spectrum analyzer with 100 kHz RBW and 300 kHz VBW. The width of a frequency band such that, below the lower and above the upper frequency limits, the mean powers emitted are each equal to a specified percentage 0.5 %of the total mean power of a given emission.

4.6.4 DEVIATION FROM TEST STANDARD

No deviation.

4.6.5 EUT OPERATING CONDITIONS

The software provided by client to enable the EUT under transmission condition continuously at lowest, middle and highest channel frequencies individually.

4.6.6 TEST RESULTS

Test Mode A

CHANNEL	FREQUENCY (MHz)	OCCUPIED BANDWIDTH (MHz)	PASS / FAIL
0	2402	1.20	PASS
39	2441	1.20	PASS
78	2480	1.20	PASS

Test Mode C

CHANNEL	FREQUENCY (MHz)	OCCUPIED BANDWIDTH (MHz)	PASS / FAIL
0	2402	1.44	PASS
19	2440	1.40	PASS
39	2480	1.40	PASS

Test Mode D

CHANNEL	FREQUENCY (MHz)	OCCUPIED BANDWIDTH (MHz)	PASS / FAIL
0	2402	2.04	PASS
19	2440	2.10	PASS
39	2480	2.00	PASS



A D T

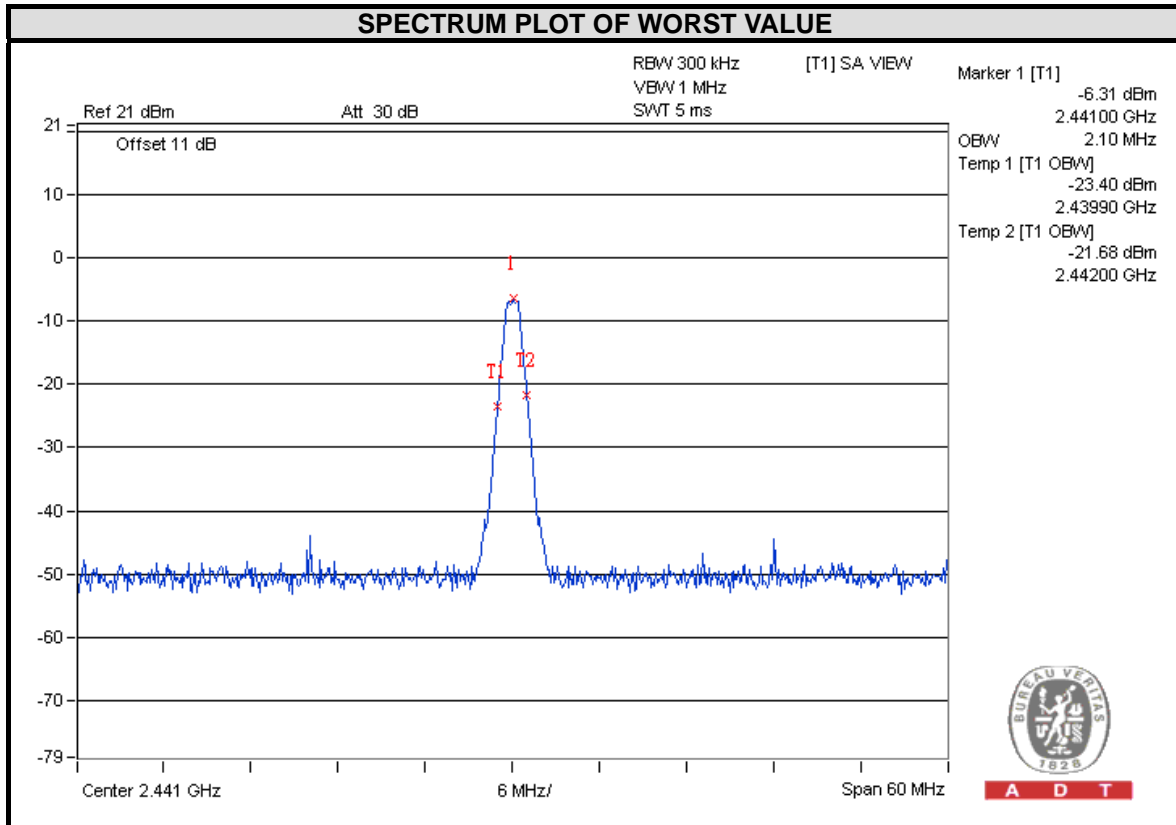

4.7 CONDUCTED OUT OF BAND EMISSION MEASUREMENT

4.7.1 LIMITS OF OUT OF BAND EMISSION MEASUREMENT

Below -20dB of the highest emission level of operating band (in 100kHz Resolution Bandwidth).

4.7.2 TEST SETUP

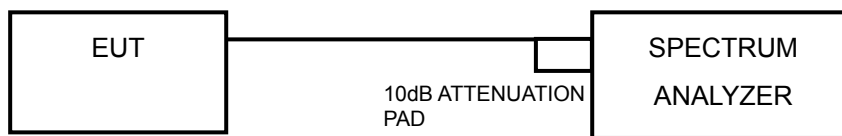

4.7.3 TEST INSTRUMENTS

Refer to section 4.1.2 to get information of above instrument.

4.7.4 TEST PROCEDURE

MEASUREMENT PROCEDURE REF

1. Set the RBW = 100 kHz.
2. Set the VBW \geq 300 kHz.
3. Detector = peak.
4. Sweep time = auto couple.
5. Trace mode = max hold.
6. Allow trace to fully stabilize.
7. Use the peak marker function to determine the maximum power level in any 100 kHz band segment within the fundamental EBW.

MEASUREMENT PROCEDURE OOB

1. Set RBW = 100 kHz.
2. Set VBW \geq 300 kHz.
3. Ensure that the number of measurement points \geq span/RBW
4. According to measurement points to set differ measurement span.
5. Detector = peak.
6. Trace Mode = max hold.
7. Sweep = auto couple.

4.7.5 DEVIATION FROM TEST STANDARD

No deviation.

4.7.6 EUT OPERATING CONDITION

Same as Item 4.3.6

4.7.7 TEST RESULTS

The spectrum plots are attached on the following pages. D1 line indicates the highest level, and D2 line indicates the 20dB offset below D1. It shows compliance with the requirement.

4.7.8 TEST RESULTS

Test Mode A

CH 0

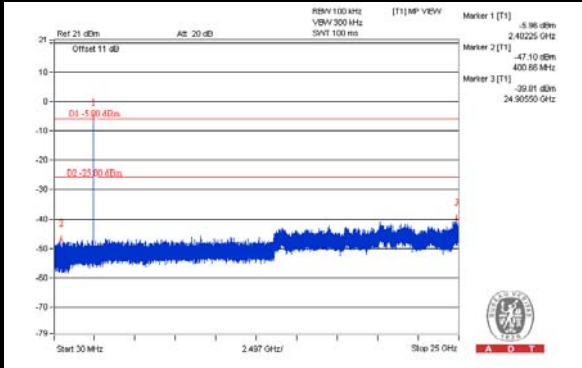
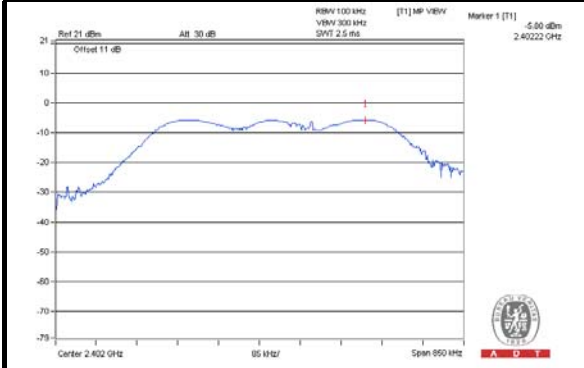

CH 39

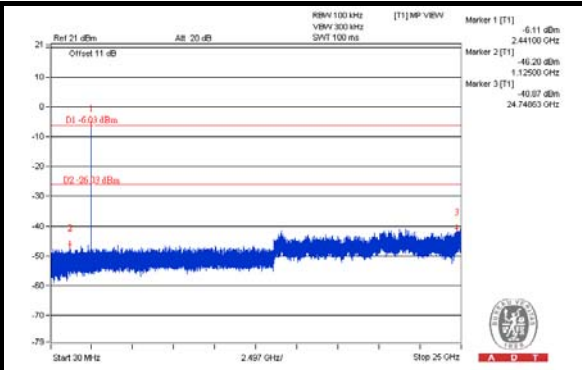
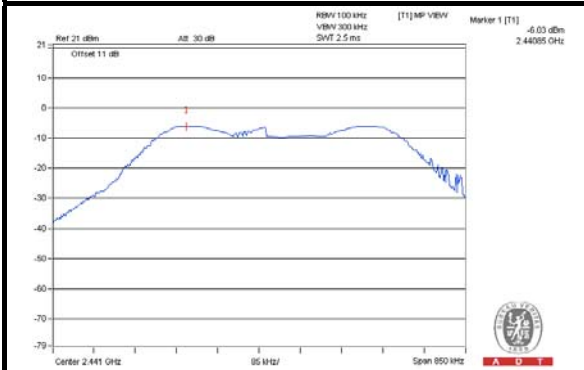

CH 78

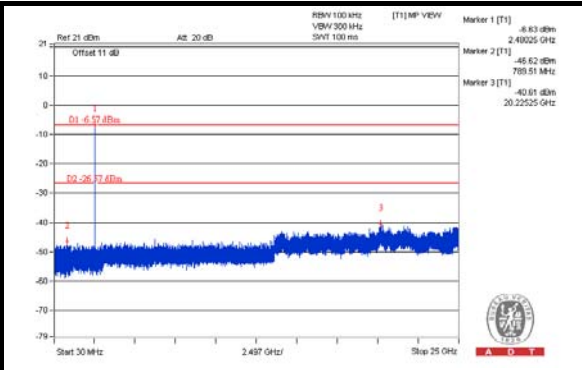
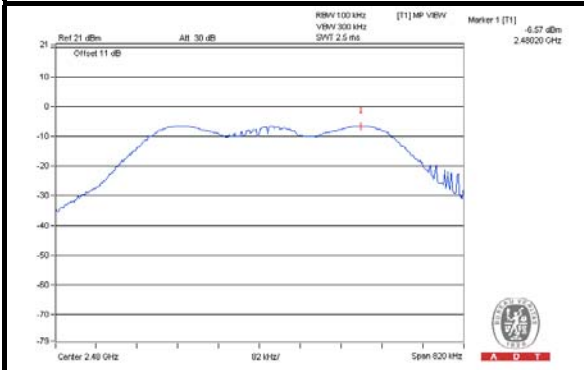

CH 0 Band edge

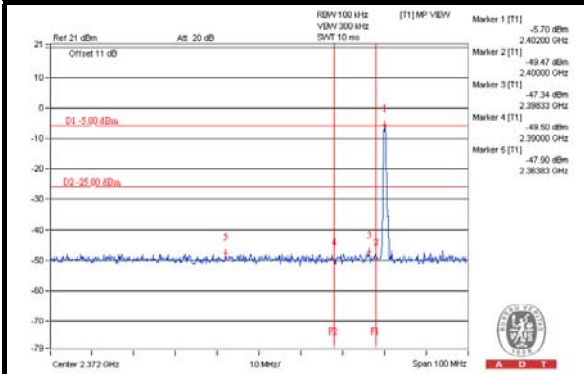

CH 78 Band edge

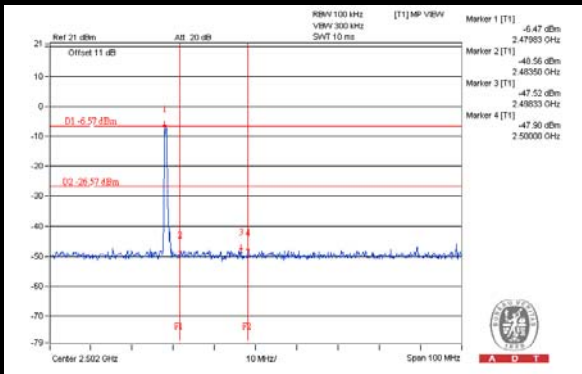



A D T



Test Mode C

CH 0

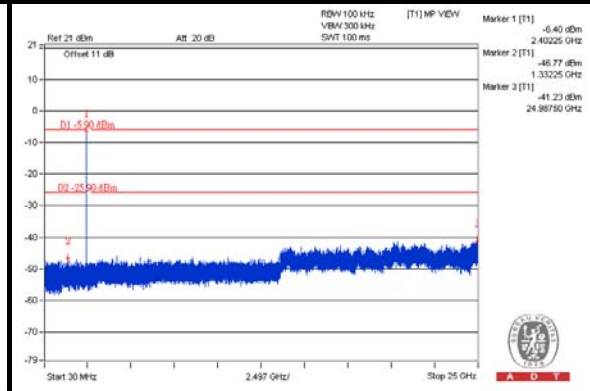
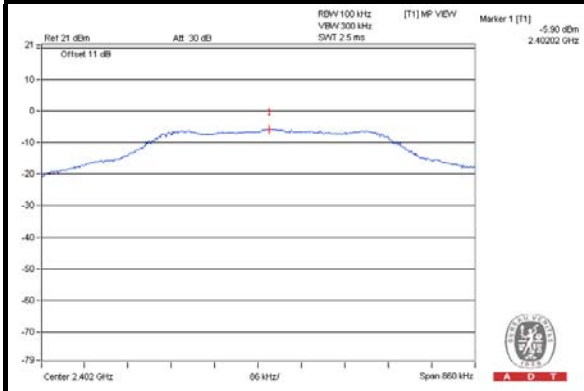

CH 19

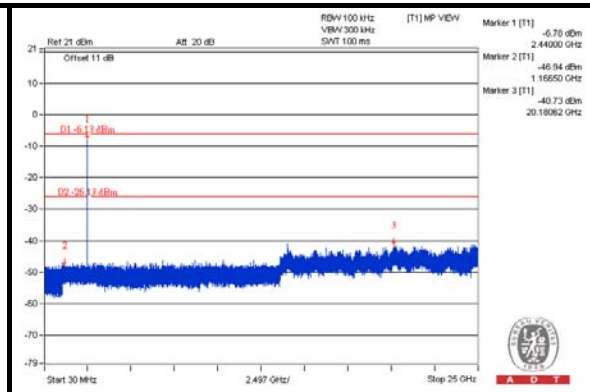
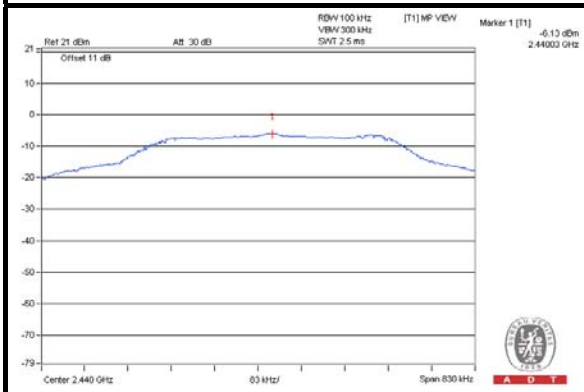

CH 39

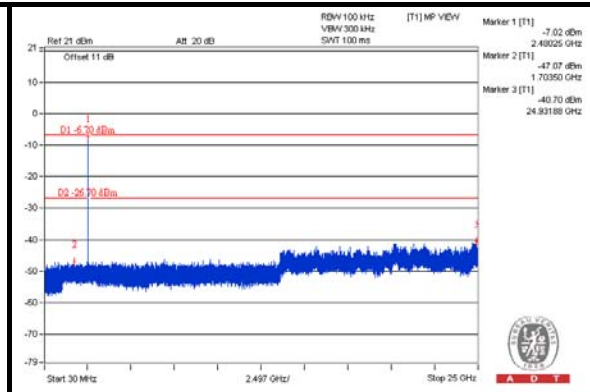
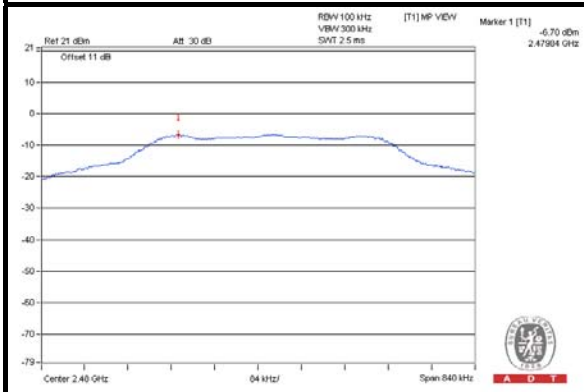

CH 0 Band edge

CH 39 Band edge



A D T

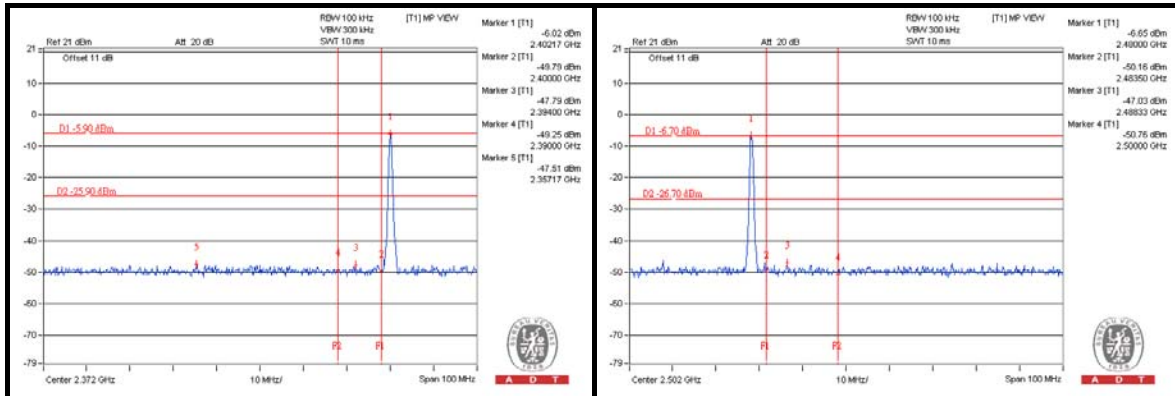



A D T

Test Mode D

CH 0

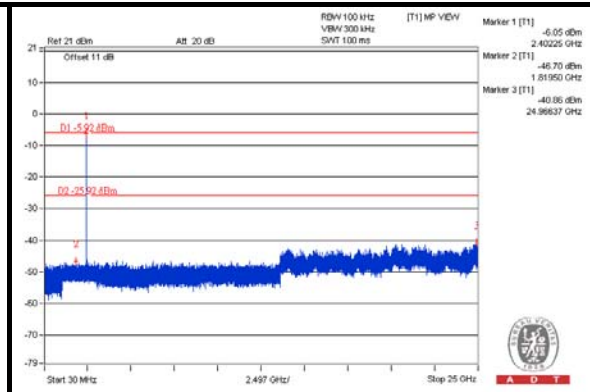
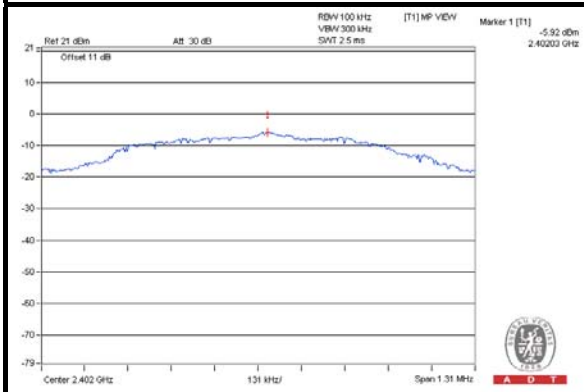

CH 19

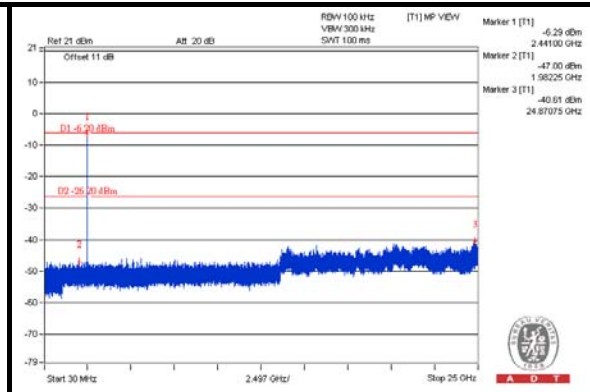
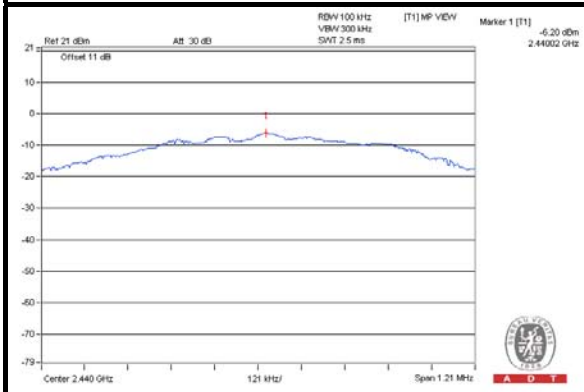

CH 39

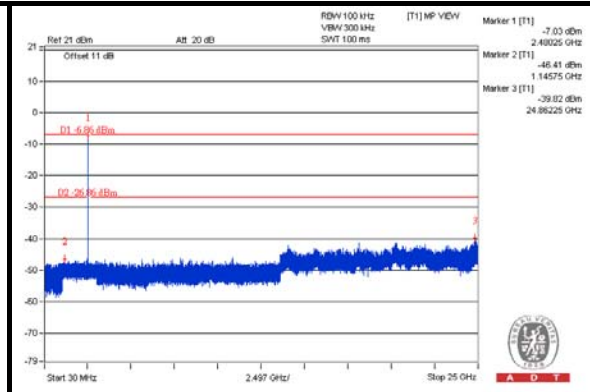
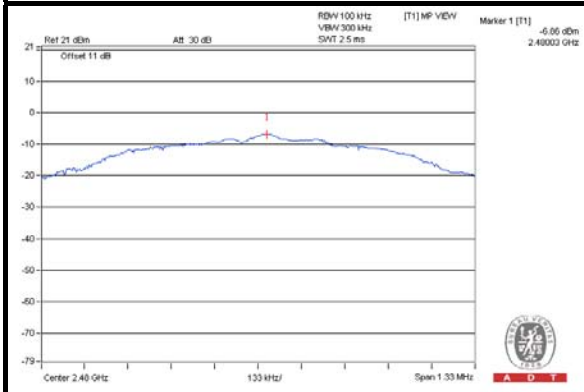

CH 0 Band edge

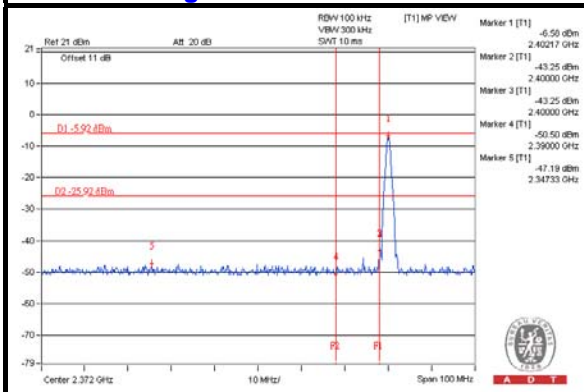

CH 39 Band edge

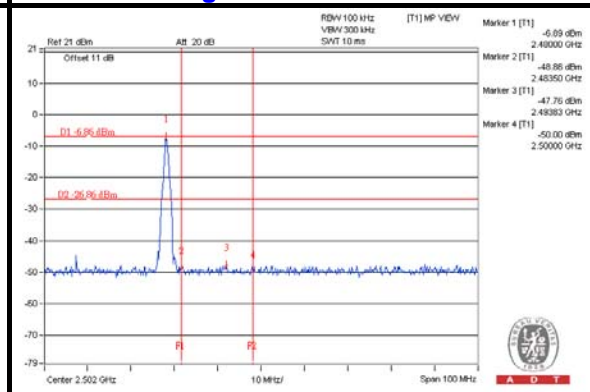



A D T





5. PHOTOGRAPHS OF THE TEST CONFIGURATION

Please refer to the attached file (Test Setup Photo).





6. INFORMATION ON THE TESTING LABORATORIES

We, Bureau Veritas Consumer Products Services (H.K.) Ltd., Taoyuan Branch, were founded in 1988 to provide our best service in EMC, Radio, Telecom and Safety consultation. Our laboratories are accredited and approved according to ISO/IEC 17025.

If you have any comments, please feel free to contact us at the following:

Linko EMC/RF Lab:

Tel: 886-2-26052180

Fax: 886-2-26051924

Hsin Chu EMC/RF Lab:

Tel: 886-3-5935343

Fax: 886-3-5935342

Hwa Ya EMC/RF/Safety Telecom Lab:

Tel: 886-3-3183232

Fax: 886-3-3270892

Email: service.adt@tw.bureauveritas.com

Web Site: www.adt.com.tw

The address and road map of all our labs can be found in our web site also.

7. APPENDIX A - MODIFICATIONS RECORDERS FOR ENGINEERING CHANGES TO THE EUT BY THE LAB

No modifications were made to the EUT by the lab during the test.

--- END ---