

FCC Radio Test Report

FCC ID: VIXSP360

This report concerns (check one): Original Grant Class I Change Class II Change

Project No. : 1512217
Equipment : Bluetooth Wireless Speaker
Model Name : SP360
Applicant : Voxx Accessories Corp.
Address : 3502 Woodview Trace, Suite 220 Indianapolis, IN
46268 USA

Date of Receipt : Dec. 28, 2015
Date of Test : Dec. 28, 2015 ~ Jan. 14, 2016
Issued Date : Jan. 14, 2016
Tested by : BTL Inc.

Testing Engineer : Shawn Xiao
(Shawn Xiao)

Technical Manager : David Mao
(David Mao)

Authorized Signatory : Steven Lu
(Steven Lu)

B T L I N C .

No.3, Jinshagang 1st Road, Shixia, Dalang Town, Dongguan,
Guangdong, China.

TEL: +86-769-8318-3000 FAX: +86-769-8319-6000

Declaration

BTL represents to the client that testing is done in accordance with standard procedures as applicable and that test instruments used has been calibrated with the standards traceable to National Measurement Laboratory (**NML**) of **CHINA**, or National Institute of Standards and Technology (**NIST**) of **U.S.A.**

BTL's reports apply only to the specific samples tested under conditions. It is manufacture's responsibility to ensure that additional production units of this model are manufactured with the identical electrical and mechanical components. **BTL** shall have no liability for any declarations, inferences or generalizations drawn by the client or others from **BTL** issued reports.

BTL's report must not be used by the client to claim product certification, approval, or endorsement by NVLAP, NIST, or any agency of the Federal Government.

This report is the confidential property of the client. As a mutual protection to the clients, the public and **BTL-self**, extracts from the test report shall not be reproduced except in full with **BTL's** authorized written approval.

BTL's laboratory quality assurance procedures are in compliance with the **ISO Guide 17025** requirements, and accredited by the conformity assessment authorities listed in this test report.

Limitation

For the use of the authority's logo is limited unless the Test Standard(s)/Scope(s)/Item(s) mentioned in this test report is (are) included in the conformity assessment authorities acceptance respective.

Table of Contents	Page
1 . CERTIFICATION	7
2 . SUMMARY OF TEST RESULTS	8
2.1 TEST FACILITY	9
2.2 MEASUREMENT UNCERTAINTY	9
3 . GENERAL INFORMATION	10
3.1 GENERAL DESCRIPTION OF EUT	10
3.2 DESCRIPTION OF TEST MODES	12
3.3 TABLE OF PARAMETERS OF TEXT SOFTWARE SETTING	12
3.4 BLOCK DIAGRAM SHOWING THE CONFIGURATION OF SYSTEM TESTED	13
3.5 DESCRIPTION OF SUPPORT UNITS	13
4 . EMC EMISSION TEST	14
4.1 CONDUCTED EMISSION MEASUREMENT	14
4.1.1 POWER LINE CONDUCTED EMISSION LIMITS	14
4.1.2 TEST PROCEDURE	14
4.1.3 DEVIATION FROM TEST STANDARD	14
4.1.4 TEST SETUP	15
4.1.5 EUT OPERATING CONDITIONS	15
4.1.6 EUT TEST CONDITIONS	15
4.1.7 TEST RESULTS	15
4.2 RADIATED EMISSION MEASUREMENT	16
4.2.1 RADIATED EMISSION LIMITS	16
4.2.2 TEST PROCEDURE	17
4.2.3 DEVIATION FROM TEST STANDARD	17
4.2.4 TEST SETUP	18
4.2.5 EUT OPERATING CONDITIONS	19
4.2.6 EUT TEST CONDITIONS	19
4.2.7 TEST RESULTS (9KHZ TO 30MHZ)	19
4.2.8 TEST RESULTS (30MHZ TO 1000 MHZ)	20
4.2.9 TEST RESULTS (ABOVE 1000 MHZ)	20
5 . NUMBER OF HOPPING CHANNEL	21
5.1 APPLIED PROCEDURES	21
5.1.1 TEST PROCEDURE	21
5.1.2 DEVIATION FROM STANDARD	21
5.1.3 TEST SETUP	21
5.1.4 EUT OPERATION CONDITIONS	21
5.1.5 EUT TEST CONDITIONS	21
5.1.6 TEST RESULTS	21

Table of Contents	Page
6 . AVERAGE TIME OF OCCUPANCY	22
6.1 APPLIED PROCEDURES / LIMIT	22
6.1.1 TEST PROCEDURE	22
6.1.2 DEVIATION FROM STANDARD	22
6.1.3 TEST SETUP	22
6.1.4 EUT OPERATION CONDITIONS	23
6.1.5 EUT TEST CONDITIONS	23
6.1.6 TEST RESULTS	23
7 . HOPPING CHANNEL SEPARATION MEASUREMENT	24
7.1 APPLIED PROCEDURES / LIMIT	24
7.1.1 TEST PROCEDURE	24
7.1.2 DEVIATION FROM STANDARD	24
7.1.3 TEST SETUP	24
7.1.4 EUT TEST CONDITIONS	24
7.1.5 TEST RESULTS	24
8 . BANDWIDTH TEST	25
8.1 APPLIED PROCEDURES	25
8.1.1 TEST PROCEDURE	25
8.1.2 DEVIATION FROM STANDARD	25
8.1.3 TEST SETUP	25
8.1.4 EUT OPERATION CONDITIONS	25
8.1.5 EUT TEST CONDITIONS	25
8.1.6 TEST RESULTS	25
9 . PEAK OUTPUT POWER TEST	26
9.1 APPLIED PROCEDURES / LIMIT	26
9.1.1 TEST PROCEDURE	26
9.1.2 DEVIATION FROM STANDARD	26
9.1.3 TEST SETUP	26
9.1.4 EUT OPERATION CONDITIONS	26
9.1.5 EUT TEST CONDITIONS	26
9.1.6 TEST RESULTS	26
10 . ANTENNA CONDUCTED SPURIOUS EMISSION	27
10.1 APPLIED PROCEDURES / LIMIT	27
10.1.1 TEST PROCEDURE	27
10.1.2 DEVIATION FROM STANDARD	27
10.1.3 TEST SETUP	27
10.1.4 EUT OPERATION CONDITIONS	27
10.1.5 EUT TEST CONDITIONS	27
10.1.6 TEST RESULTS	27
11 . MEASUREMENT INSTRUMENTS LIST	28

Table of Contents	Page
12 . EUT TEST PHOTO	30
ATTACHMENT A - CONDUCTED EMISSION	34
ATTACHMENT B - RADIATED EMISSION (9KHZ-30MHZ)	37
ATTACHMENT C - RADIATED EMISSION (30MHZ TO 1000MHZ)	39
ATTACHMENT D - RADIATED EMISSION (ABOVE 1000MHZ)	46
ATTACHMENT E - NUMBER OF HOPPING CHANNEL	71
ATTACHMENT F - AVERAGE TIME OF OCCUPANCY	73
ATTACHMENT G - HOPPING CHANNEL SEPARATION MEASUREMENT	86
ATTACHMENT H - BANDWIDTH	91
ATTACHMENT I - PEAK OUTPUT POWER	96
ATTACHMENT J - ANTENNA CONDUCTED SPURIOUS EMISSION	101

REPORT ISSUED HISTORY

Issued No.	Description	Issued Date
BTL-FCCP-1-1512217	Original Issue.	Jan. 14, 2016

1. CERTIFICATION

Equipment : Bluetooth Wireless Speaker
Brand Name : 808
Model Name : SP360
Applicant : Voxx Accessories Corp
Manufacturer : Dong Guan Lightion Electronics Co., LTD
Address : Meilin District 523823, Dalingshan, Dongguan City, Guangdong Province, China
Factory : Dong Guan Lightion Electronics Co., LTD
Address : Meilin District 523823, Dalingshan, Dongguan City, Guangdong Province, China
Date of Test : Dec. 28, 2015 ~ Jan. 14, 2016
Test Sample : Engineering Sample
Standard(s) : FCC Part15, Subpart C (15.247)/ ANSI C63.10-2013

The above equipment has been tested and found compliance with the requirement of the relative standards by BTL Inc.

The test data, data evaluation, and equipment configuration contained in our test report (Ref No. BTL-FCCP-1-1512217) were obtained utilizing the test procedures, test instruments, test sites that has been accredited by the Authority of TAF according to the ISO-17025 quality assessment standard and technical standard(s).

2. SUMMARY OF TEST RESULTS

Test procedures according to the technical standard(s):

Applied Standard(s): 47 CFR Part 15, Subpart C			
Standard(s) Section	Test Item	Judgment	Remark
15.207	Conducted Emission	PASS	
15.247(d)	Antenna conducted Spurious Emission	PASS	
15.247 (a)(1)	Hopping Channel Separation	PASS	
15.247(a)(1)	Bandwidth	PASS	
15.247 (b)(1)	Peak Output Power	PASS	
15.247(d) 15.209	Radiated Spurious Emission	PASS	
15.247 (a)(1)(iii)	Number of Hopping Frequency	PASS	
15.247 (a)(1)(iii)	Dwell Time	PASS	
15.205	Restricted Bands	PASS	
15.203	Antenna Requirement	PASS	

Note:

(1) "N/A" denotes test is not applicable in this test report

2.1 TEST FACILITY

The test facilities used to collect the test data in this report is at the location of No.3, Jinshagang 1st Road, Shixia, Dalang Town, Dongguan, Guangdong, China.
BTL's test firm number for FCC: 319330

2.2 MEASUREMENT UNCERTAINTY

Where relevant, the following measurement uncertainty levels have been estimated for tests performed on the EUT as specified in CISPR 16-4-2. The measurement instrumentation uncertainty considerations contained in CISPR 16-4-2.

The reported uncertainty of measurement $y \pm U$, where expanded uncertainty U is based on a standard uncertainty multiplied by a coverage factor of $k=2$, providing a level of confidence of approximately **95 %**.

A. Conducted Measurement :

Test Site	Method	Measurement Frequency Range	U,(dB)
DG-C02	CISPR	150 kHz ~ 30MHz	2.32

B. Radiated Measurement :

Test Site	Method	Measurement Frequency Range	Ant. H / V	U,(dB)
DG-CB03 (3m)	CISPR	9KHz ~ 30MHz	V	3.79
		9KHz ~ 30MHz	H	3.57
		30MHz ~ 200MHz	V	3.82
		30MHz ~ 200MHz	H	3.78
		200MHz ~ 1,000MHz	V	4.10
		200MHz ~ 1,000MHz	H	4.06

Test Site	Method	Measurement Frequency Range	Ant. H / V	U,(dB)
DG-CB03 (3m)	CISPR	1GHz ~ 18GHz	V	3.12
		1GHz ~ 18GHz	H	3.68
		18GHz ~ 40GHz	V	4.15
		18GHz ~ 40GHz	H	4.14

Note: Unless specifically mentioned, the uncertainty of measurement has not been taken into account to declare the compliance or non-compliance to the specification.

3. GENERAL INFORMATION

3.1 GENERAL DESCRIPTION OF EUT

Equipment	Bluetooth Wireless Speaker	
Brand Name	808	
Model Name	SP360	
Model Difference	The SP360 comes in color variations but are electrically and mechanically the same. The only difference is the color.	
Output Power (Max.)	Operation Frequency	2402~2480 MHz
	Modulation Technology	GFSK(1Mbps) $\pi/4$ -DQPSK(2Mbps)
	Bit Rate of Transmitter	8-DPSK(3Mbps)
	Output Power Max.	1.29 dBm(1Mbps) 0.22 dBm(3Mbps)
Power Source	#1 DC Voltage supplied from AC/DC adapter. Brand/Model: KINGS /Y18FG-150-1000U #2 Battery supplied. Brand/Model: DONGGUAN KINGNAIR/KNE 603443P-3S	
Power Rating	#1 AC 100-240V, 50-60Hz, 0.5A O/P: DC 15V,1000mA #2 DC 11.1V 1000mAh	

Note:

1. For a more detailed features description, please refer to the manufacturer's specifications or the user's manual.

2. Channel List:

Channel	Frequency (MHz)	Channel	Frequency (MHz)	Channel	Frequency (MHz)
00	2402	27	2429	54	2456
01	2403	28	2430	55	2457
02	2404	29	2431	56	2458
03	2405	30	2432	57	2459
04	2406	31	2433	58	2460
05	2407	32	2434	59	2461
06	2408	33	2435	60	2462
07	2409	34	2436	61	2463
08	2410	35	2437	62	2464
09	2411	36	2438	63	2465
10	2412	37	2439	64	2466
11	2413	38	2440	65	2467
12	2414	39	2441	66	2468
13	2415	40	2442	67	2469
14	2416	41	2443	68	2470
15	2417	42	2444	69	2471
16	2418	43	2445	70	2472
17	2419	44	2446	71	2473
18	2420	45	2447	72	2474
19	2421	46	2448	73	2475
20	2422	47	2449	74	2476
21	2423	48	2450	75	2477
22	2424	49	2451	76	2478
23	2425	50	2452	77	2479
24	2426	51	2453	78	2480
25	2427	52	2454		
26	2428	53	2455		

3. Table for Filed Antenna

Ant.	Brand	Model Name	Antenna Type	Connector	Gain (dBi)	Note
1	808	N/A	2.4G INTERNAL PCB	N/A	-1.88	N/A

3.2 DESCRIPTION OF TEST MODES

To investigate the maximum EMI emission characteristics generates from EUT, the test system was pre-scanning tested base on the consideration of following EUT operation mode or test configuration mode which possible have effect on EMI emission level. Each of these EUT operation mode(s) or test configuration mode(s) mentioned above was evaluated respectively.

Pretest Mode	Description
Mode 1	TX Mode Note (1)

The EUT system operated these modes were found to be the worst case during the pre-scanning test as following:

For Conducted Emission	
Final Test Mode	Description
Mode 1	TX Mode

For Radiated Emission	
Final Test Mode	Description
Mode 1	TX Mode Note (1)

Note:

- (1) The measurements are performed at the high, middle, low available channels.
- (2) The measurements for Hopping Channel Separation, Bandwidth and Peak Output Power were tested during 1Mbps, 2Mbps and 3Mbps, the worst case are 1Mbps and 3Mbps, only worst case was documented.

3.3 TABLE OF PARAMETERS OF TEXT SOFTWARE SETTING

During testing, channel & power controlling software provided by the customer was used to control the operating channel as well as the output power level. The RF output power selection is for the setting of RF output power expected by the customer and is going to be fixed on the firmware of the final end product power parameters of FHSS

Test Software Version	BK3256 RF Test_V1.3		
Frequency	2402 MHz	2441 MHz	2480 MHz
Parameters(1Mbps)	3.00	3.00	3.00
Parameters(3Mbps)	3.00	3.00	3.00

3.4 BLOCK DIAGRAM SHOWING THE CONFIGURATION OF SYSTEM TESTED

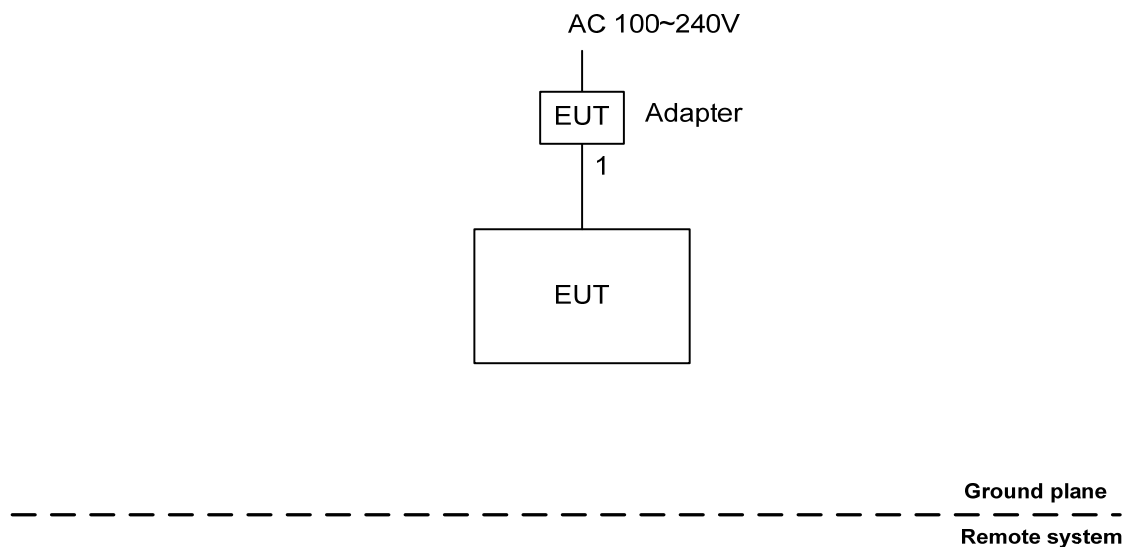

3.5 DESCRIPTION OF SUPPORT UNITS

The EUT has been tested as an independent unit together with other necessary accessories or support units. The following support units or accessories were used to form a representative test configuration during the tests.

Item	Equipment	Mfr/Brand	Model/Type No.	FCC ID	Series No.
-	-	-	-	-	-

Item	Shielded Type	Ferrite Core	Length	Note
1	NO	NO	1.4m	AC Main Cable

4. EMC EMISSION TEST

4.1 CONDUCTED EMISSION MEASUREMENT

4.1.1 POWER LINE CONDUCTED EMISSION LIMITS (Frequency Range 150KHz-30MHz)

Frequency of Emission (MHz)	Conducted Limit (dB μ V)	
	Quasi-peak	Average
0.15 -0.5	66 to 56*	56 to 46*
0.50 -5.0	56	46
5.0 -30.0	60	50

Note:

- (1) The limit of " * " decreases with the logarithm of the frequency
- (2) The test result calculated as following:
 Measurement Value = Reading Level + Correct Factor
 Correct Factor = Insertion Loss + Cable Loss + Attenuator Factor(if use)
 Margin Level = Measurement Value - Limit Value

The following table is the setting of the receiver

Receiver Parameters	Setting
Attenuation	10 dB
Start Frequency	0.15 MHz
Stop Frequency	30 MHz
IF Bandwidth	9 KHz

4.1.2 TEST PROCEDURE

- a. The EUT was placed 0.8 meters from the horizontal ground plane with EUT being connected to the power mains through a line impedance stabilization network (LISN). All other support equipments powered from additional LISN(s). The LISN provide 50 Ohm/ 50uH of coupling impedance for the measuring instrument.
- b. Interconnecting cables that hang closer than 40 cm to the ground plane shall be folded back and forth in the center forming a bundle 30 to 40 cm long.
- c. I/O cables that are not connected to a peripheral shall be bundled in the center. The end of the cable may be terminated, if required, using the correct terminating impedance. The overall length shall not exceed 1 m.
- d. LISN at least 80 cm from nearest part of EUT chassis.
- e. For the actual test configuration, please refer to the related Item –EUT Test Photos.

4.1.3 DEVIATION FROM TEST STANDARD

No deviation

4.1.4 TEST SETUP

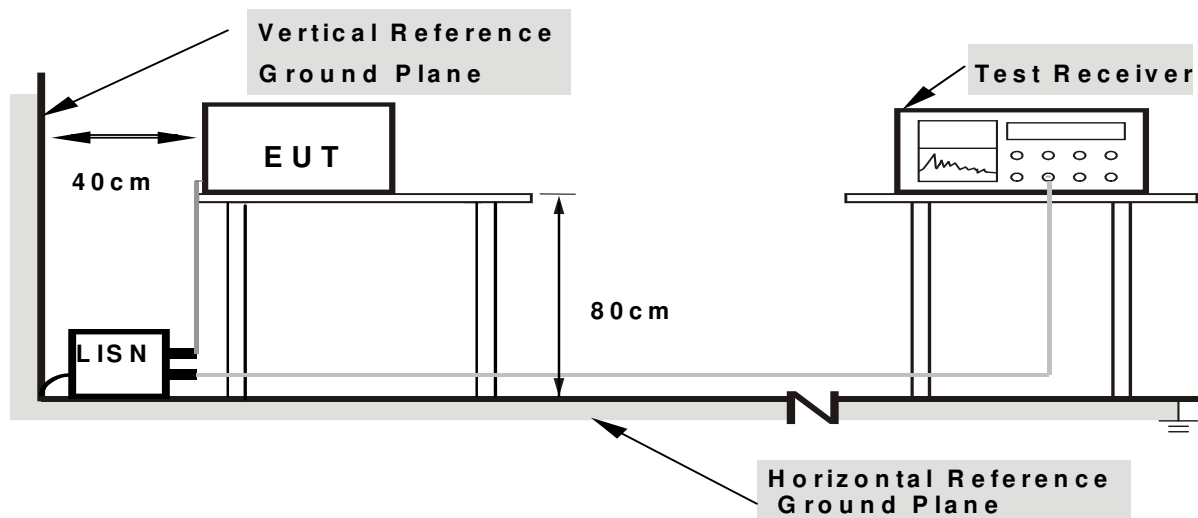

- Note:**
1. Support units were connected to second LISN.
 2. Both of LISNs (AMN) are 80 cm from EUT and at least 80 from other units and other metal planes

4.1.5 EUT OPERATING CONDITIONS

The EUT was configured for testing in a typical function (as a customer would normally use it), EUT was programmed to be in continuously transmitting/receiving data or hopping on mode.

4.1.6 EUT TEST CONDITIONS

Temperature: 25°C
 Relative Humidity: 55%
 Test Voltage: AC 120V/60Hz

4.1.7 TEST RESULTS

Please refer to the Attachment A.

Remark:

- (1) All readings are QP Mode value unless otherwise stated AVG in column of 'Note'. If the QP Mode Measured value compliance with the QP Limits and lower than AVG Limits, the EUT shall be deemed to meet both QP & AVG Limits and then only QP Mode was measured, but AVG Mode didn't perform in this case, a "*" marked in AVG Mode column of Interference Voltage Measured.
- (2) Measuring frequency range from 150KHz to 30MHz.

4.2 RADIATED EMISSION MEASUREMENT

4.2.1 RADIATED EMISSION LIMITS (Frequency Range 9KHz -1000MHz)

In case the emission fall within the restricted band specified on 15.205(a), then the 15.209(a) limit in the table below has to be followed.

Frequency (MHz)	Field Strength (microvolts/meter)	Measurement Distance (meters)
0.009~0.490	2400/F(KHz)	300
0.490~1.705	24000/F(KHz)	30
1.705~30.0	30	30
30~88	100	3
88~216	150	3
216~960	200	3
960~1000	500	3

LIMITS OF RADIATED EMISSION MEASUREMENT (Above 1000MHz)

Frequency (MHz)	dB(uV/m) (at 3 meters)	
	Peak	Average
Above 1000	74	54

Notes:

- (1) The limit for radiated test was performed according to FCC PART 15C.
- (2) The tighter limit applies at the band edges.
- (3) Emission level (dBuV/m) = 20log Emission level (uV/m).
- (4) The test result calculated as following:
 Measurement Value = Reading Level + Correct Factor
 Correct Factor = Antenna Factor + Cable Loss - Amplifier Gain(if use)
 Margin Level = Measurement Value - Limit Value

Spectrum Parameter	Setting
Attenuation	Auto
Start Frequency	1000 MHz
Stop Frequency	10th carrier harmonic
RBW / VBW (emission in restricted band)	1 MHz / 1 MHz for Peak, 1 MHz / 10Hz for Average

Spectrum Receiver Parameter	Setting
Attenuation	Auto
Start ~ Stop Frequency	9KHz ~90KHz for PK/AVG detector
Start ~ Stop Frequency	90KHz ~110KHz for QP detector
Start ~ Stop Frequency	110KHz ~490KHz for PK/AVG detector
Start ~ Stop Frequency	490KHz ~30MHz for QP detector
Start ~ Stop Frequency	30MHz~1000MHz for QP detector

4.2.2 TEST PROCEDURE

- a. The measuring distance of 3 m shall be used for measurements. The EUT was placed on the top of a rotating table 0.8 meter above the ground at a 3 meter semi-anechoic chamber. The table was rotated 360 degrees to determine the position of the highest radiation.(below 1GHz)
- b. The measuring distance of 3 m shall be used for measurements. The EUT was placed on the top of a rotating table 1.5 meter above the ground at a 3 meter semi-anechoic chamber. The table was rotated 360 degrees to determine the position of the highest radiation.(above 1GHz)
- c. The height of the equipment or of the substitution antenna shall be 0.8m or 1.5 m, the height of the test antenna shall vary between 1 m to 4 m. Both horizontal and vertical polarizations of the antenna are set to make the measurement.
- d. The initial step in collecting radiated emission data is a receiver peak detector mode pre-scanning the measurement frequency range. Significant peaks are then marked and then Quasi Peak detector mode re-measured.
- e. All readings are Peak unless otherwise stated QP in column of Note. Peak denotes that the Peak reading compliance with the QP Limits and then QP Mode measurement didn't perform. (below 1GHz)
- f. All readings are Peak Mode value unless otherwise stated AVG in column of Note. If the Peak Mode Measured value compliance with the Peak Limits and lower than AVG Limits, the EUT shall be deemed to meet both Peak & AVG Limits and then only Peak Mode was measured, but AVG Mode didn't perform. (above 1GHz)
- g. For the actual test configuration, please refer to the related Item –EUT Test Photos.

4.2.3 DEVIATION FROM TEST STANDARD

No deviation

4.2.4 TEST SETUP

(A) Radiated Emission Test Set-Up Frequency Below 1 GHz

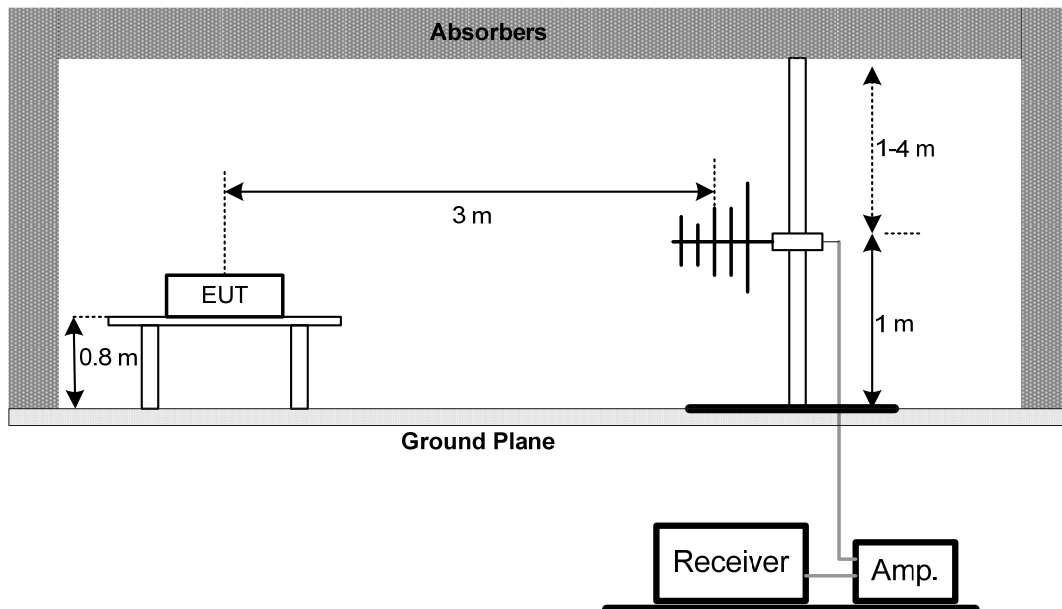

(B) Radiated Emission Test Set-Up Frequency Above 1 GHz

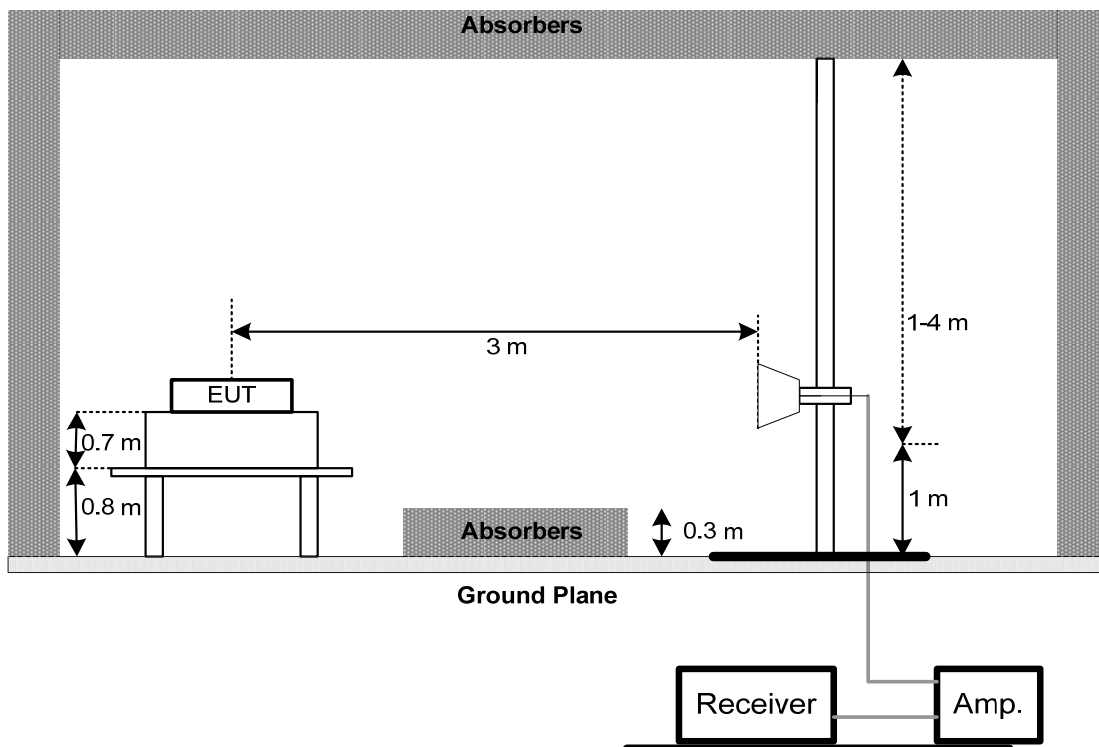

(C) For Radiated Emissions Below 30MHz

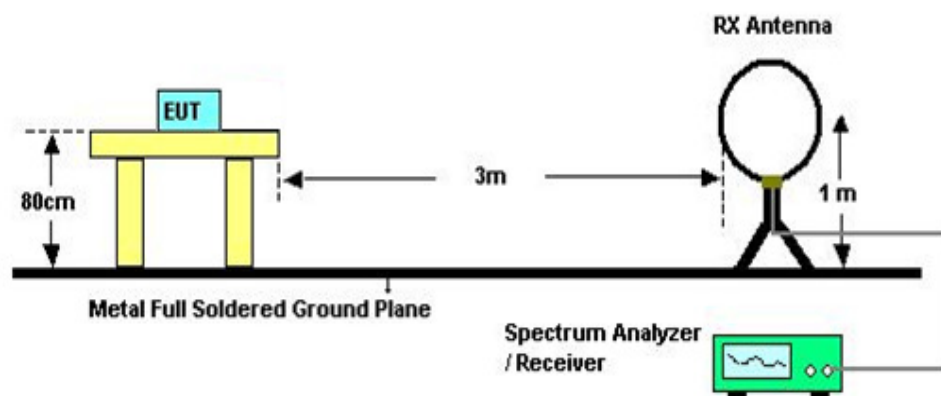

4.2.5 EUT OPERATING CONDITIONS

The EUT tested system was configured as the statements of 4.1.5 unless otherwise a special operating condition is specified in the follows during the testing

4.2.6 EUT TEST CONDITIONS

Temperature: 25°C

Relative Humidity: 55%

Test Voltage: AC 120V/60Hz

4.2.7 TEST RESULTS (9KHZ TO 30MHZ)

Please refer to the Attachment B

Remark:

- (1) The amplitude of spurious emissions which are attenuated by more than 20 dB below the permissible value has no need to be reported.
- (2) Distance extrapolation factor = $40 \log(\text{specific distance} / \text{test distance})$ (dB).
- (3) Limit line = specific limits (dBuV) + distance extrapolation factor.

4.2.8 TEST RESULTS (30MHZ TO 1000 MHZ)

Please refer to the Attachment C.

Remark:

- (1) Reading in which marked as QP or Peak means measurements by using are Quasi-Peak Mode or Peak Mode with Detector BW=120KHz; SPA setting in RBW=120KHz, VBW =120KHz, Swp. Time = 0.3 sec./MHz.
- (2) All readings are Peak unless otherwise stated QP in column of 『Note』 . Peak denotes that the Peak reading compliance with the QP Limits and then QP Mode measurement didn't perform.
- (3) Measuring frequency range from 30MHz to 1000MHz.
- (4) If the peak scan value lower limit more than 20dB, then this signal data does not show in table.

4.2.9 TEST RESULTS (ABOVE 1000 MHZ)

Please refer to the Attachment D.

Remark:

- (1) Radiated emissions measured in frequency range above 1000MHz were made with an instrument using Peak detector mode and AV detector mode of the emission
- (2) A preamp and high pass filter were used for this test in order to provide sufficient measurement sensitivity.
- (3) EUT Orthogonal Axis:
"X" - denotes Laid on Table; "Y" - denotes Vertical Stand; "Z" - denotes Side Stand
- (4) During the measurements above 1 GHz it is taken care of that the EUT is always within the 3 dB cone of radiation BW of the used antenna
- (5) No limit: This is fundamental signal, the judgment is not applicable.
For fundamental signal judgment was referred to Peak output test.

5. NUMBER OF HOPPING CHANNEL

5.1 APPLIED PROCEDURES

FCC Part15 (15.247) , Subpart C			
Section	Test Item	Frequency Range (MHz)	Result
15.247(a)(1)(iii)	Number of Hopping Channel	2400-2483.5	PASS

Spectrum Parameters	Setting
Attenuation	Auto
Span Frequency	> Operating Frequency Range
RBW	100 KHz
VBW	100 KHz
Detector	Peak
Trace	Max Hold
Sweep Time	Auto

5.1.1 TEST PROCEDURE

- a. The EUT was directly connected to the spectrum analyzer and antenna output port as show in the block diagram below,
- b. Spectrum Setting: RBW=100KHz, VBW=100KHz, Sweep time = Auto.

5.1.2 DEVIATION FROM STANDARD

No deviation.

5.1.3 TEST SETUP

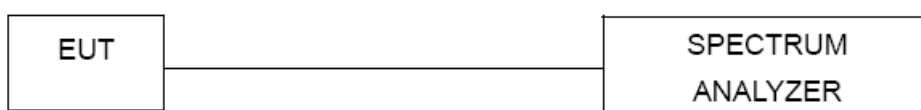

5.1.4 EUT OPERATION CONDITIONS

The EUT tested system was configured as the statements of 4.1.5 unless otherwise a special operating condition is specified in the follows during the testing.

5.1.5 EUT TEST CONDITIONS

Temperature: 25°C
 Relative Humidity: 55%
 Test Voltage: AC 120V/60Hz

5.1.6 TEST RESULTS

Please refer to the Attachment E

6. AVERAGE TIME OF OCCUPANCY

6.1 APPLIED PROCEDURES / LIMIT

FCC Part15 (15.247) , Subpart C				
Section	Test Item	Limit	Frequency Range (MHz)	Result
15.247(a)(1)(iii)	Average Time of Occupancy	0.4sec	2400-2483.5	PASS

6.1.1 TEST PROCEDURE

- a. The transmitter output (antenna port) was connected to the spectrum analyzer
- b. Set RBW of spectrum analyzer to 1MHz and VBW to 1MHz.
- c. Use a video trigger with the trigger level set to enable triggering only on full pulses.
- d. Sweep Time is more than once pulse time.
- e. Set the center frequency on any frequency would be measure and set the frequency span to zero span.
- f. Measure the maximum time duration of one single pulse.
- g. Set the EUT for DH5, DH3 and DH1 packet transmitting.
- h. Measure the maximum time duration of one single pulse.
- i. DH5 Packet permit maximum $1600 / 79 / 6 = 3.37$ hops per second in each channel (5 time slots TX, 1 time slot RX). So, the dwell time is the time duration of the pulse times $3.37 \times 31.6 = 106.6$ within 31.6 seconds.
- j. DH3 Packet permit maximum $1600 / 79 / 4 = 5.06$ hops per second in each channel (3 time slots TX, 1 time slot RX). So, the dwell time is the time duration of the pulse times $5.06 \times 31.6 = 160$ within 31.6 seconds.
- k. DH1 Packet permit maximum $1600 / 79 / 2 = 10.12$ hops per second in each channel (1 time slot TX, 1 time slot RX). So, the dwell time is the time duration of the pulse times $10.12 \times 31.6 = 320$ within 31.6 seconds.

6.1.2 DEVIATION FROM STANDARD

No deviation.

6.1.3 TEST SETUP



6.1.4 EUT OPERATION CONDITIONS

The EUT tested system was configured as the statements of 4.1.5 unless otherwise a special operating condition is specified in the follows during the testing.

6.1.5 EUT TEST CONDITIONS

Temperature: 25°C

Relative Humidity: 55%

Test Voltage: AC 120V/60Hz

6.1.6 TEST RESULTS

Please refer to the Attachment F

7. HOPPING CHANNEL SEPARATION MEASUREMENT

7.1 APPLIED PROCEDURES / LIMIT

Frequency hopping systems operating in the 2400-2483.5 MHz band may have hopping channel carrier frequencies that are separated by 25 KHz or two-thirds of the 20 dB bandwidth of the hopping channel, whichever is greater.

Spectrum Parameter	Setting
Attenuation	Auto
Span Frequency	> Measurement Bandwidth or Channel Separation
RBW	30 KHz
VBW	100 KHz
Detector	Peak
Trace	Max Hold
Sweep Time	Auto

7.1.1 TEST PROCEDURE

- a. The EUT must have its hopping function enabled
- b. Span = wide enough to capture the peaks of two adjacent channels
 - Resolution (or IF) Bandwidth (RBW) \geq 1% of the span
 - Video (or Average) Bandwidth (VBW) \geq RBW
 - Sweep = Auto
 - Detector function = Peak
 - Trace = Max Hold

7.1.2 DEVIATION FROM STANDARD

No deviation.

7.1.3 TEST SETUP

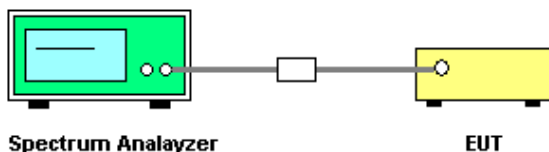

7.1.4 EUT TEST CONDITIONS

Temperature: 25°C
 Relative Humidity: 55%
 Test Voltage: AC 120V/60Hz

7.1.5 TEST RESULTS

Please refer to the Attachment G

8. BANDWIDTH TEST

8.1 APPLIED PROCEDURES

FCC Part15 (15.247) , Subpart C		
Section	Test Item	Frequency Range (MHz)
15.247(a)(2)	Bandwidth	2400-2483.5

Spectrum Parameter	Setting
Attenuation	Auto
Span Frequency	> Measurement Bandwidth or Channel Separation
RBW	30 KHz (20dB Bandwidth) / 30 KHz (Channel Separation)
VBW	100 KHz (20dB Bandwidth) / 100 KHz (Channel Separation)
Detector	Peak
Trace	Max Hold
Sweep Time	Auto

8.1.1 TEST PROCEDURE

- a. The EUT was directly connected to the spectrum analyzer and antenna output port as show in the block diagram below,
- b. Spectrum Setting: RBW= 30KHz, VBW=100KHz, Sweep Time = Auto.

8.1.2 DEVIATION FROM STANDARD

No deviation.

8.1.3 TEST SETUP



8.1.4 EUT OPERATION CONDITIONS

The EUT tested system was configured as the statements of 4.1.5 unless otherwise a special operating condition is specified in the follows during the testing.

8.1.5 EUT TEST CONDITIONS

Temperature: 25°C

Relative Humidity: 55%

Test Voltage: AC 120V/60Hz

8.1.6 TEST RESULTS

Please refer to the Attachment H

9. PEAK OUTPUT POWER TEST

9.1 APPLIED PROCEDURES / LIMIT

FCC Part15 (15.247) , Subpart C				
Section	Test Item	Limit	Frequency Range (MHz)	Result
15.247(b)(1)	Peak Output Power	1 Watt or 30dBm (hopping channel >75) 0.125Watt or 21dBm (hopping channel <75)	2400-2483.5	PASS

9.1.1 TEST PROCEDURE

- a. The EUT was directly connected to the spectrum analyzer and antenna output port as show in the block diagram below,
- b. Spectrum Setting: RBW= 1MHz/3MHz, VBW= 1MHz/3MHz, Sweep time = Auto.

9.1.2 DEVIATION FROM STANDARD

No deviation.

9.1.3 TEST SETUP

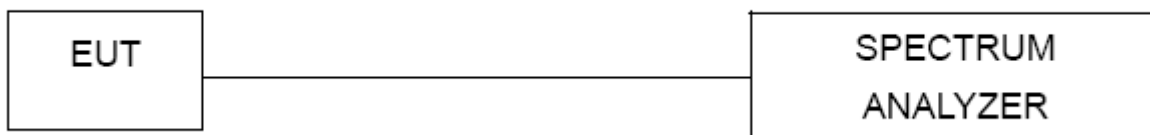

9.1.4 EUT OPERATION CONDITIONS

The EUT tested system was configured as the statements of 4.1.5 unless otherwise a special operating condition is specified in the follows during the testing.

9.1.5 EUT TEST CONDITIONS

Temperature: 25°C
Relative Humidity: 55%
Test Voltage: AC 120V/60Hz

9.1.6 TEST RESULTS

Please refer to the Attachment I

10. ANTENNA CONDUCTED SPURIOUS EMISSION

10.1 APPLIED PROCEDURES / LIMIT

In any 100 kHz bandwidth outside the frequency band in which the spread spectrum or digitally modulated device is operating, the RF power that is produced shall be at least 20 dB below that in the 100 kHz bandwidth within the band that contains the highest level of the desired power, based on either an RF conducted or a radiated measurement, provided that the transmitter demonstrates compliance with the peak conducted power limits.

10.1.1 TEST PROCEDURE

- a. The EUT was directly connected to the spectrum analyzer and antenna output port as show in the block diagram below,
- b. Spectrum Setting: RBW= 100KHz, VBW=100KHz, Sweep time = Auto.
- c. Offset=antenna gain+cable loss

10.1.2 DEVIATION FROM STANDARD

No deviation.

10.1.3 TEST SETUP



10.1.4 EUT OPERATION CONDITIONS

The EUT tested system was configured as the statements of 4.1.5 unless otherwise a special operating condition is specified in the follows during the testing.

10.1.5 EUT TEST CONDITIONS

Temperature: 25°C
Relative Humidity: 55%
Test Voltage: AC 120V/60Hz

10.1.6 TEST RESULTS

Please refer to the Attachment J

11. MEASUREMENT INSTRUMENTS LIST

Conducted Emission Measurement					
Item	Kind of Equipment	Manufacturer	Type No.	Serial No.	Calibrated until
1	LISN	EMCO	3816/2	00052765	Mar. 28, 2016
2	LISN	R&S	ENV216	101447	Mar. 28, 2016
3	Test Cable	emci	RG223(9KHz-30 MHz)	C_17	Mar. 13, 2016
4	EMI TEST RECEIVER	R&S	ESCS30	833364/017	Mar. 28, 2016
5	50Ω Terminator	SHX	TF2-3G-A	08122902	Mar. 28, 2016
6	Measurement Software	Farad	EZ-EMC Ver.NB-03A1-01	N/A	N/A

Radiated Emission Measurement					
Item	Kind of Equipment	Manufacturer	Type No.	Serial No.	Calibrated until
1	Antenna	Schwarbeck	VULB9160	9160-3232	Mar. 28, 2016
2	Amplifier	HP	8447D	2944A09673	Nov. 09, 2016
3	Receiver	AGILENT	N9038A	MY52130039	Oct. 11, 2016
4	Test Cable	emci	LMR-400(30MHz-1GHz)	C-01	Jun. 28, 2016
5	Controller	CT	SC100	N/A	N/A
6	Measurement Software	Farad	EZ-EMC Ver.NB-03A1-01	N/A	N/A
7	Antenna	ETS	3115	00075789	Mar. 28, 2016
8	Amplifier	Agilent	8449B	3008A02274	Nov. 01, 2016
9	Receiver	AGILENT	N9038A	MY52130039	Oct. 11, 2016
10	Test Cable	emci	EMC104-SM-S M-10000(1GHz-26.5GHz)	C-68	Jun. 28, 2016
11	Controller	CT	SC100	N/A	N/A
12	Broad-Band Horn Antenna	Schwarzbeck	BBHA 9170	9170319	Mar. 28, 2016
13	Active Loop Antenna	R&S	HFH2-Z2	830749/020	Sep. 07, 2016

Number of Hopping Channel					
Item	Kind of Equipment	Manufacturer	Type No.	Serial No.	Calibrated until
1	Spectrum Analyzer	R&S	FSP 40	100185	Oct. 11, 2016
2	Test Cable	emci	EMC104-SM-S M-9000(0.01G Hz-26.5GHz)	C_100	N/A

Average Time of Occupancy					
Item	Kind of Equipment	Manufacturer	Type No.	Serial No.	Calibrated until
1	Spectrum Analyzer	R&S	FSP 40	100185	Oct. 11, 2016
2	Test Cable	emci	EMC104-SM-S M-9000(0.01G Hz-26.5GHz)	C_100	N/A

Hopping Channel Separation Measurement					
Item	Kind of Equipment	Manufacturer	Type No.	Serial No.	Calibrated until
1	Spectrum Analyzer	R&S	FSP 40	100185	Oct. 11, 2016
2	Test Cable	emci	EMC104-SM-S M-9000(0.01G Hz-26.5GHz)	C_100	N/A

Bandwidth					
Item	Kind of Equipment	Manufacturer	Type No.	Serial No.	Calibrated until
1	Spectrum Analyzer	R&S	FSP 40	100185	Oct. 11, 2016
2	Test Cable	emci	EMC104-SM-S M-9000(0.01G Hz-26.5GHz)	C_100	N/A

Peak Output Power					
Item	Kind of Equipment	Manufacturer	Type No.	Serial No.	Calibrated until
1	Spectrum Analyzer	R&S	FSP 40	100185	Oct. 11, 2016
2	Test Cable	emci	EMC104-SM-S M-9000(0.01G Hz-26.5GHz)	C_100	N/A

Antenna Conducted Spurious Emission					
Item	Kind of Equipment	Manufacturer	Type No.	Serial No.	Calibrated until
1	Spectrum Analyzer	R&S	FSP 40	100185	Oct. 11, 2016
2	Test Cable	emci	EMC104-SM-S M-9000(0.01G Hz-26.5GHz)	C_100	N/A

Remark: "N/A" denotes no model name, serial no. or calibration specified.
All calibration period of equipment list is one year.

12. EUT TEST PHOTO

Conducted Measurement Photos



Radiated Measurement Photos

9KHz to 30MHz



Radiated Measurement Photos

30MHz to 1000MHz

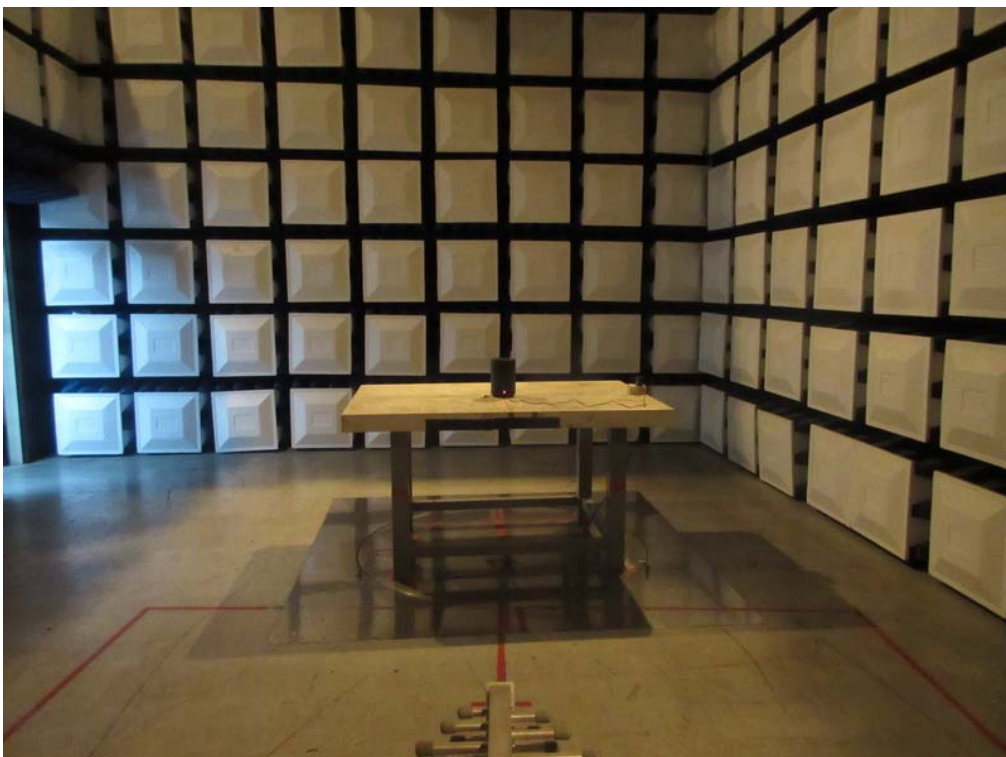

Radiated Measurement Photos

Above 1000MHz



ATTACHMENT A - CONDUCTED EMISSION

Test Mode: TX Mode

Line

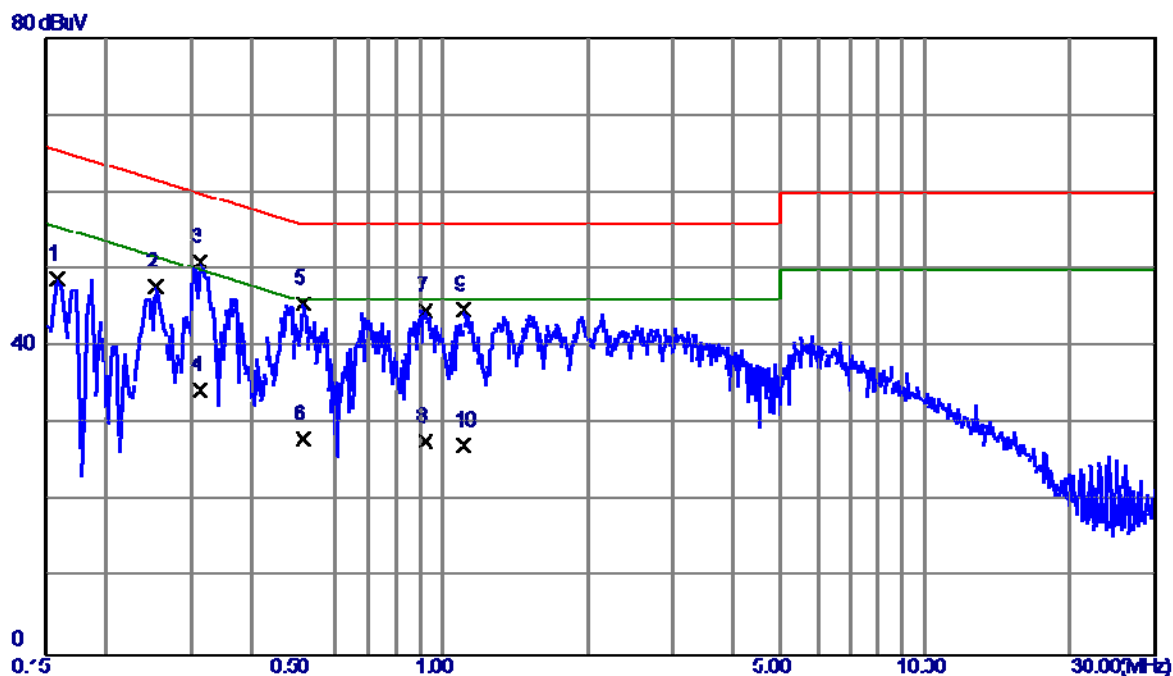

No.	Freq. MHz	Reading Level dBuV	Correct Factor dB	Measure ment dBuV	Limit dBuV	Margin dB	Detector	Comment
1	0.1580	39.25	9.55	48.80	65.57	-16.77	Peak	
2	0.2540	38.21	9.61	47.82	61.63	-13.81	Peak	
3	0.3140	41.41	9.64	51.05	59.86	-8.81	Peak	
4	0.3140	24.75	9.64	34.39	49.86	-15.47	AVG	
5	0.5140	35.96	9.69	45.65	56.00	10.35	Peak	
6	0.5140	18.32	9.69	28.01	46.00	-17.99	AVG	
7	0.9180	34.93	9.78	44.71	56.00	-11.29	Peak	
8	0.9180	17.83	9.78	27.61	46.00	-18.39	AVG	
9	1.1060	34.95	9.81	44.76	56.00	-11.24	Peak	
10	1.1060	17.39	9.81	27.20	46.00	-18.80	AVG	

Test Mode:	TX Mode
------------	---------

Neutral

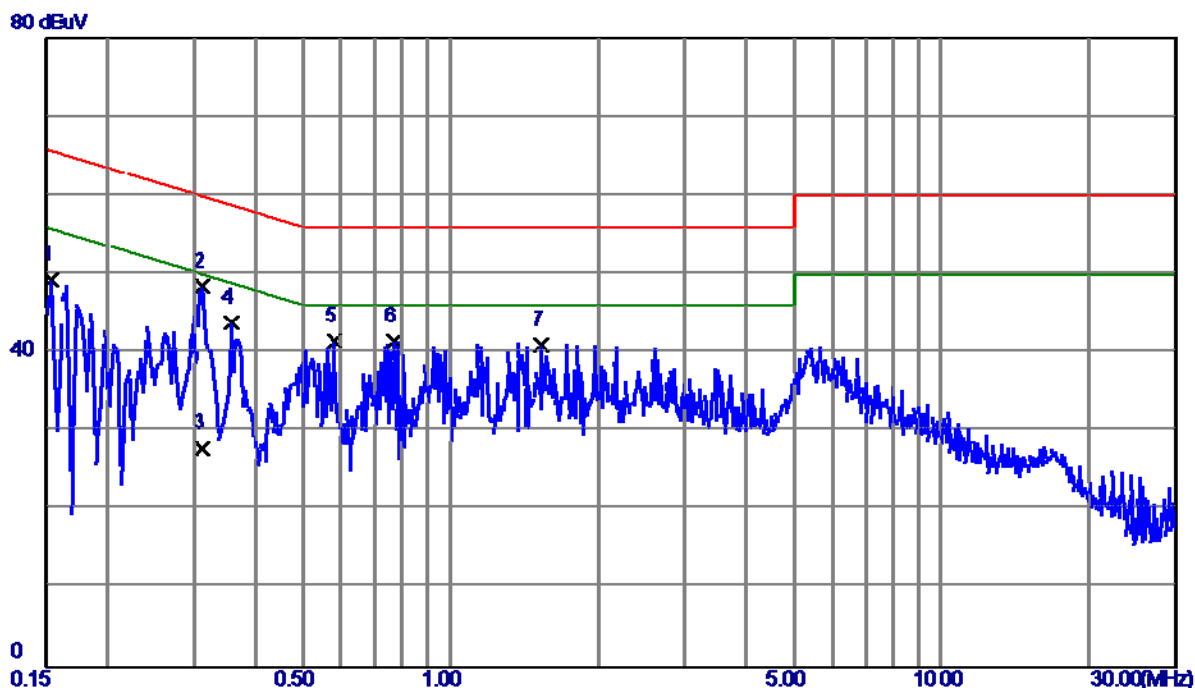

No.	Freq. MHz	Reading Level dBuV	Correct Factor dB	Measure ment dBuV	Limit dBuV	Margin dB	Detector	Comment
1	0.1539	39.80	9.49	49.29	65.79	-16.50	Peak	
2	0.3140	38.87	9.53	48.40	59.86	-11.46	Peak	
3	0.3140	18.38	9.53	27.91	49.86	-21.95	AVG	
4	0.3580	34.39	9.53	43.92	58.77	-14.85	Peak	
5	0.5820	31.92	9.56	41.48	56.00	-14.52	Peak	
6	0.7660	31.85	9.55	41.40	56.00	-14.60	Peak	
7	1.5339	31.35	9.66	41.01	56.00	-14.99	Peak	

ATTACHMENT B - RADIATED EMISSION (9KHZ-30MHZ)

Test Mode:	TX Mode
------------	---------

Frequency (MHz)	Ant 0°/90°	Read level dBuV/m	Factor (dB)	Measured(FS) (dBuV/m)	Limit (dBuV/m)	Margin (dB)	Note
0.0097	0°	11.39	24.9523	36.3423	127.8688	-91.5265	AVG
0.0097	0°	13.24	24.9523	38.1923	147.8688	-109.6765	PEAK
0.0282	0°	5.62	23.7807	29.4007	118.5992	-89.1986	AVG
0.0282	0°	8.19	23.7807	31.9707	138.5992	-106.6286	PEAK
0.0387	0°	3.20	23.1157	26.3157	115.8500	-89.5343	AVG
0.0387	0°	5.65	23.1157	28.7657	135.8500	-107.0843	PEAK
0.0556	0°	1.13	22.2880	23.4180	112.7027	-89.2847	AVG
0.0556	0°	2.42	22.2880	24.7080	132.7027	-107.9947	PEAK
0.5087	0°	19.25	19.8278	39.0778	73.4750	-34.3972	QP
1.9573	0°	23.21	19.5043	42.7143	69.5400	-26.8257	QP

Frequency (MHz)	Ant 0°/90°	Read level dBuV/m	Factor (dB)	Measured(FS) (dBuV/m)	Limit (dBuV/m)	Margin (dB)	Note
0.0121	90°	13.20	24.3000	37.5000	125.9485	-88.4485	AVG
0.0121	90°	14.75	24.3000	39.0500	145.9485	-106.8985	PEAK
0.0257	90°	6.75	23.9390	30.6890	119.4056	-88.7166	AVG
0.0257	90°	8.92	23.9390	32.8590	139.4056	-106.5466	PEAK
0.0430	90°	5.60	22.8433	28.4433	114.9349	-86.4915	AVG
0.0430	90°	6.20	22.8433	29.0433	134.9349	-105.8915	PEAK
0.0574	90°	1.47	22.2520	23.7220	112.4260	-88.7040	AVG
0.0574	90°	2.96	22.2520	25.2120	132.4260	-107.2140	PEAK
0.6220	90°	22.32	20.1904	42.5104	71.7284	-29.2180	QP
2.0535	90°	24.60	19.4679	44.0679	69.5400	-25.4721	QP

ATTACHMENT C - RADIATED EMISSION (30MHZ TO 1000MHZ)

Test Mode: TX 2402MHz_CH00_1Mbps

Vertical

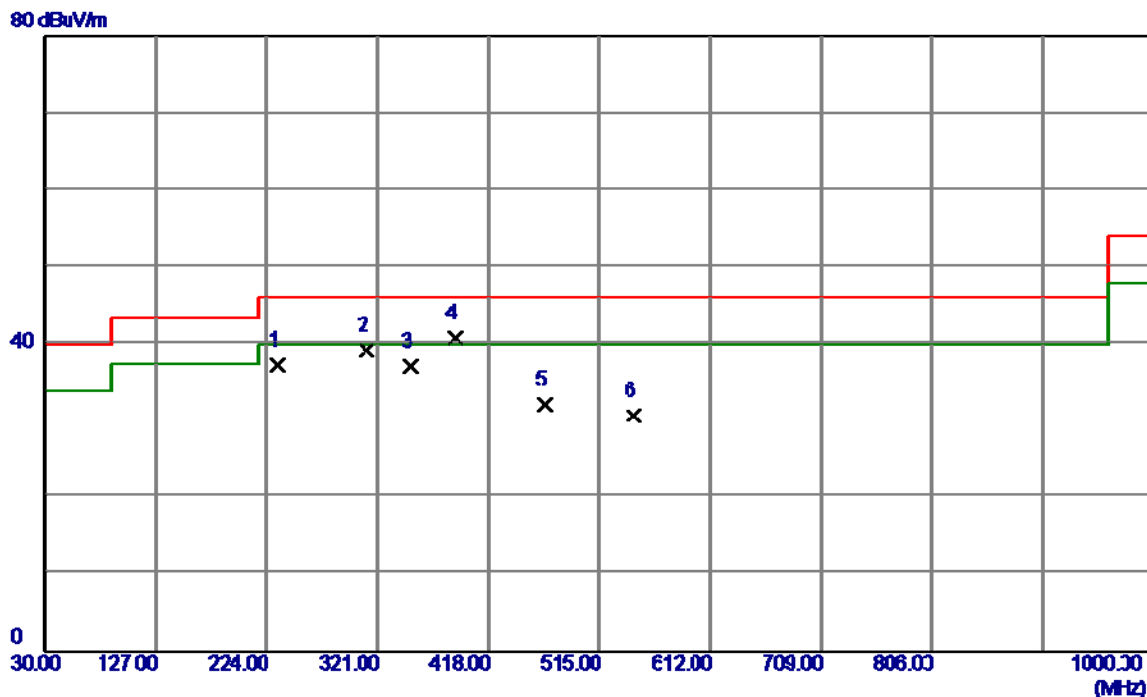

No.	Freq. MHz	Reading Level dBuV/m	Correct Factor dB	Measure ment dBuV/m	Limit dBuV/m	Margin dB	Detector	Comment
1	233.7000	49.98	-12.63	37.35	46.00	-8.65	Peak	
2	311.3000	48.87	-9.66	39.21	46.00	-6.79	Peak	
3	350.1000	46.99	-9.92	37.07	46.00	-8.93	Peak	
4	388.9000	48.70	-7.85	40.85	46.00	-5.15	Peak	
5	467.4700	38.51	-6.42	32.09	46.00	-13.91	Peak	
6	545.0700	35.64	-4.89	30.75	46.00	-15.25	Peak	

Test Mode: TX 2402MHz_CH00_1Mbps

Horizontal

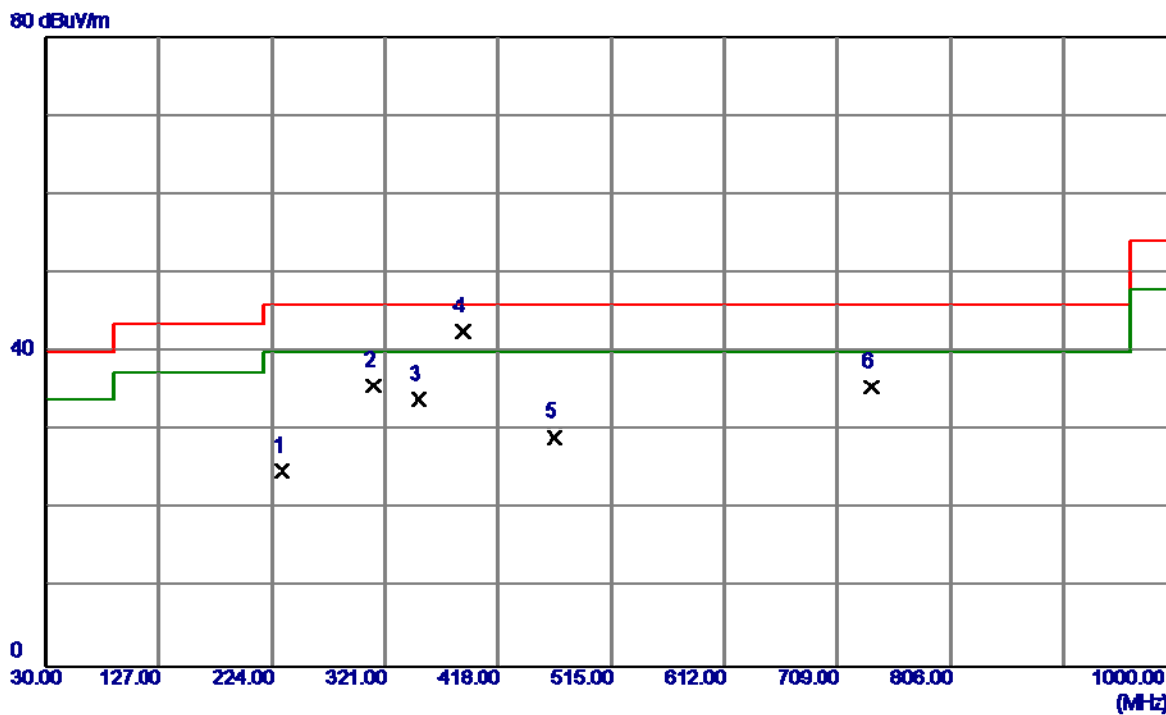

No.	Freq. MHz	Reading Level dBuV/m	Correct Factor dB	Measure ment dBuV/m	Limit dBuV/m	Margin dB	Detector	Comment
1	232.7300	37.53	-12.66	24.87	46.00	-21.13	Peak	
2	311.3000	45.30	-9.66	35.64	46.00	-10.36	Peak	
3	350.1000	43.88	-9.92	33.96	46.00	-12.04	Peak	
4	387.9300	50.42	-7.91	42.51	46.00	-3.49	Peak	
5	466.5000	35.54	-6.39	29.15	46.00	-16.85	Peak	
6	738.1000	37.01	-1.43	35.58	46.00	-10.42	Peak	

Test Mode: TX 2441MHz_CH39_1Mbps

Vertical

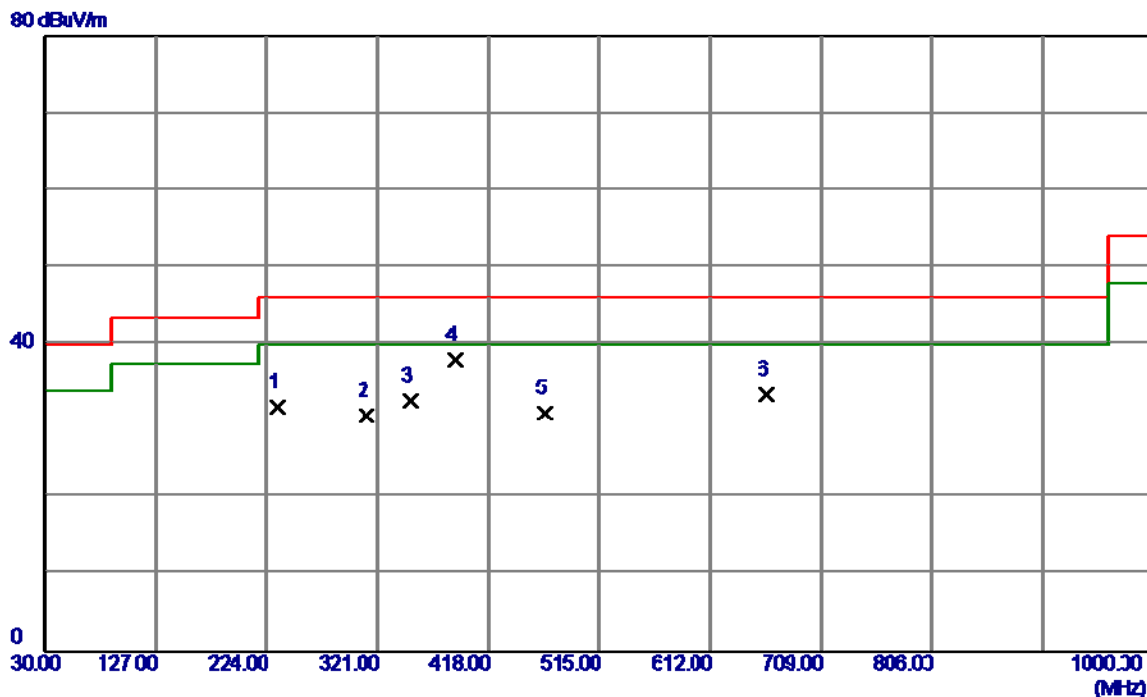

No.	Freq. MHz	Reading Level dBuV/m	Correct Factor dB	Measurement dBuV/m	Limit dBuV/m	Margin dB	Detector	Comment
1	233.7000	44.48	-12.63	31.85	46.00	-14.15	Peak	
2	311.3000	40.37	-9.66	30.71	46.00	-15.29	Peak	
3	350.1000	42.49	-9.92	32.57	46.00	-13.43	Peak	
4	388.9000	45.70	-7.85	37.85	46.00	-8.15	Peak	
5	467.4700	37.51	-6.42	31.09	46.00	-14.91	Peak	
6	661.4699	35.11	-1.60	33.51	46.00	-12.49	Peak	

Test Mode: TX 2441MHz_CH39_1Mbps

Horizontal

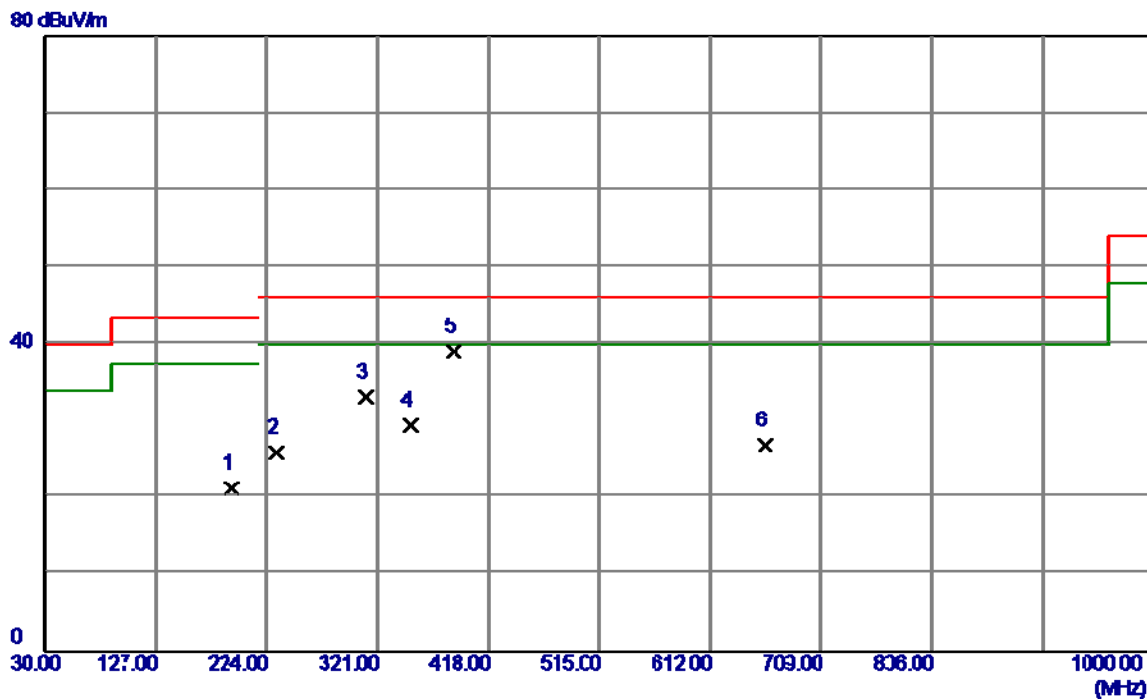

No.	Freq. MHz	Reading Level dBuV/m	Correct Factor dB	Measure ment dBuV/m	Limit dBuV/m	Margin dB	Detector	Comment
1	193.9299	34.49	-13.22	21.27	43.50	-22.23	Peak	
2	232.7300	38.53	-12.66	25.87	46.00	-20.13	Peak	
3	311.3000	42.80	-9.66	33.14	46.00	-12.86	Peak	
4	350.1000	39.38	-9.92	29.46	46.00	-16.54	Peak	
5	387.9300	46.92	-7.91	39.01	46.00	-6.99	Peak	
6	660.5000	28.53	-1.60	26.93	46.00	-19.07	Peak	

Test Mode: TX 2480MHz_CH78_1Mbps

Vertical

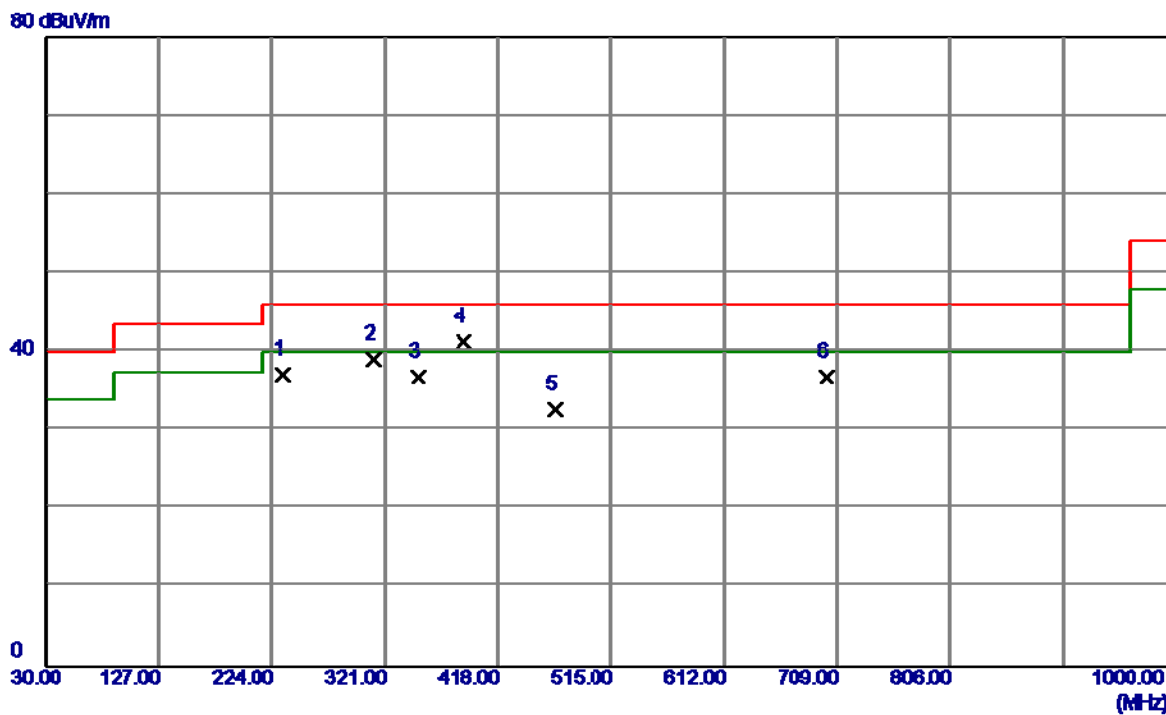

No.	Freq. MHz	Reading Level dBuV/m	Correct Factor dB	Measure ment dBuV/m	Limit dBuV/m	Margin dB	Detector	Comment
1	233.7000	49.73	-12.63	37.10	46.00	-8.90	Peak	
2	311.3000	48.74	-9.66	39.08	46.00	-6.92	Peak	
3	350.1000	46.79	-9.92	36.87	46.00	-9.13	Peak	
4	388.9000	49.14	-7.85	41.29	46.00	-4.71	Peak	
5	467.4700	39.09	-6.42	32.67	46.00	-13.33	Peak	
6	700.2700	38.26	-1.47	36.79	46.00	-9.21	Peak	

Test Mode: TX 2480MHz_CH78_1Mbps

Horizontal

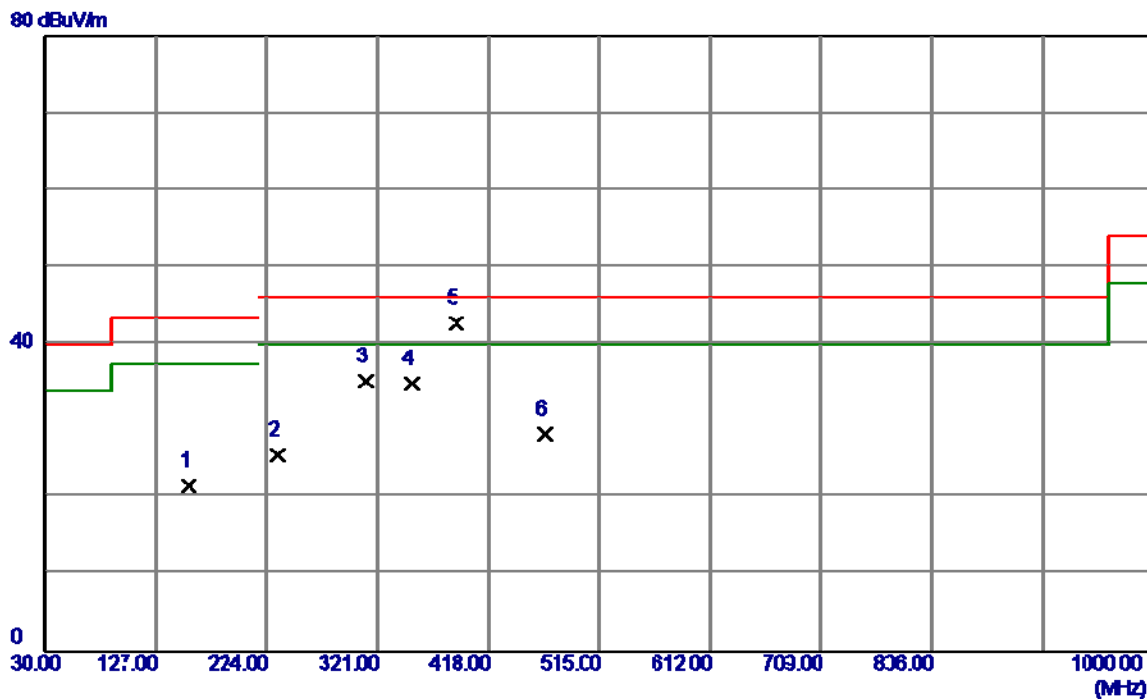

No.	Freq. MHz	Reading Level dBuV/m	Correct Factor dB	Measure ment dBuV/m	Limit dBuV/m	Margin dB	Detector	Comment
1	156.1000	33.58	-12.00	21.58	43.50	-21.92	Peak	
2	233.7000	38.16	-12.63	25.53	46.00	-20.47	Peak	
3	311.3000	44.83	-9.66	35.17	46.00	-10.83	Peak	
4	351.0700	44.80	-9.86	34.94	46.00	-11.06	Peak	
5	389.8700	50.45	-7.80	42.65	46.00	-3.35	Peak	
6	467.4700	34.73	-6.42	28.31	46.00	-17.69	Peak	

ATTACHMENT D - RADIATED EMISSION (ABOVE 1000MHZ)

Test Mode : TX 2402MHz_CH00_1Mbps

Vertical

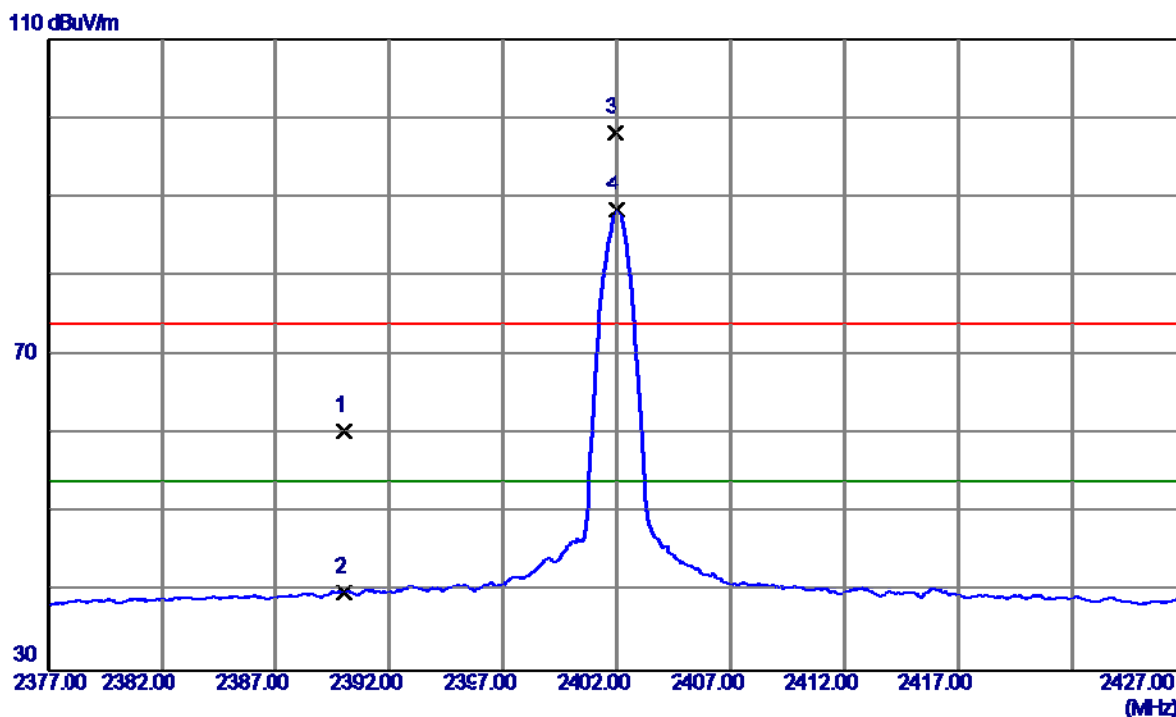

No.	Freq. MHz	Reading Level dBuV/m	Correct Factor dB	Measure ment dBuV/m	Limit dBuV/m	Margin dB	Detector	Comment
1	2390.0000	26.17	34.23	60.40	74.00	-13.60	Peak	
2	2390.0000	5.74	34.23	39.97	54.00	-14.03	AVG	
3	2401.9500	63.87	34.30	98.17	74.00	24.17	Peak	No Limit
4	2402.0000	54.04	34.30	88.34	54.00	34.34	AVG	No Limit

Test Mode : TX 2402MHz _CH00_1Mbps

Vertical

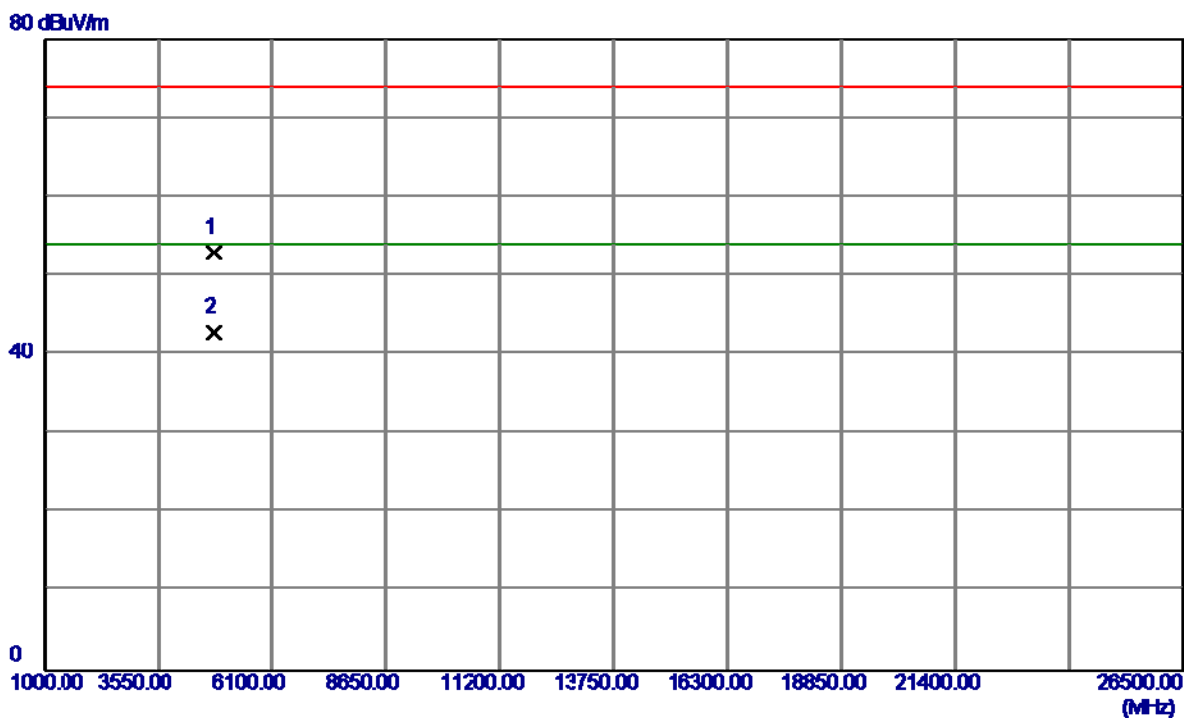

No.	Freq. MHz	Reading Level dBuV/m	Correct Factor dB	Measure ment dBuV/m	Limit dBuV/m	Margin dB	Detector	Comment
1	4803.7300	50.03	3.00	53.03	74.00	-20.97	Peak	
2	4803.9250	39.93	3.00	42.93	54.00	-11.07	AVG	

Test Mode : TX 2402MHz_CH00_1Mbps

Horizontal

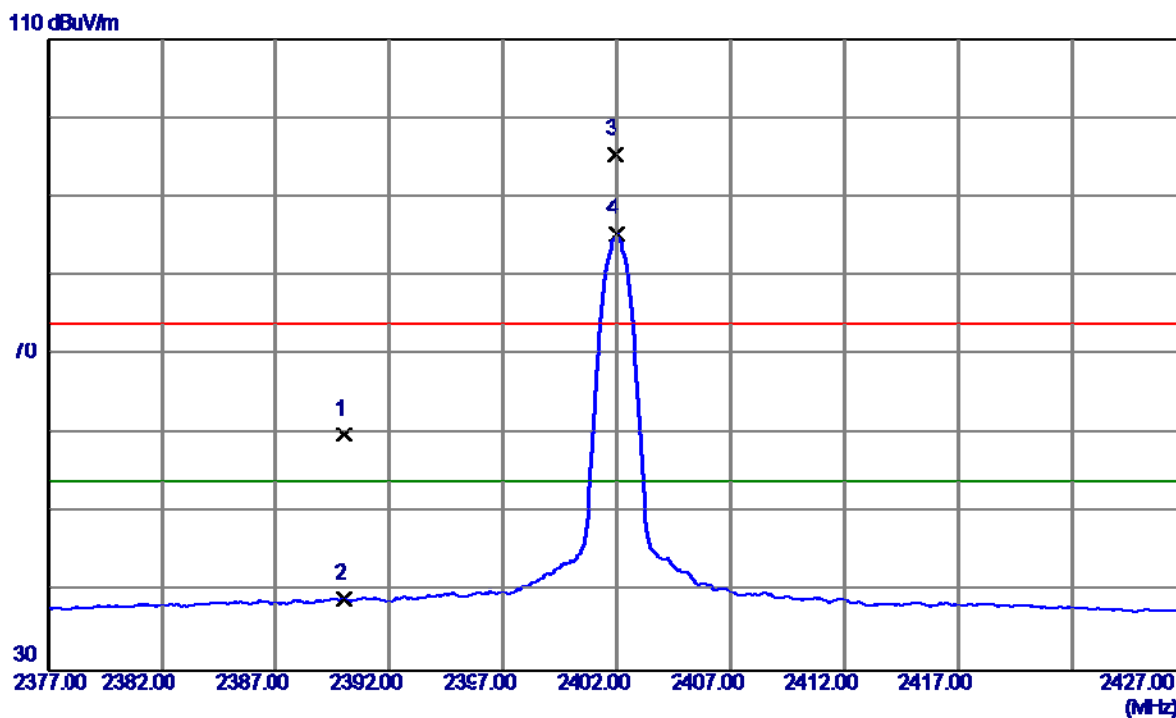

No.	Freq. MHz	Reading Level dBuV/m	Correct Factor dB	Measure ment dBuV/m	Limit dBuV/m	Margin dB	Detector	Comment
1	2390.0000	25.67	34.23	59.90	74.00	-14.10	Peak	
2	2390.0000	4.88	34.23	39.11	54.00	-14.89	AVG	
3	2401.9500	61.13	34.30	95.43	74.00	21.43	Peak	No Limit
4	2402.0000	51.09	34.30	85.39	54.00	31.39	AVG	No Limit

Test Mode : TX 2402MHz _CH00_1Mbps

Horizontal

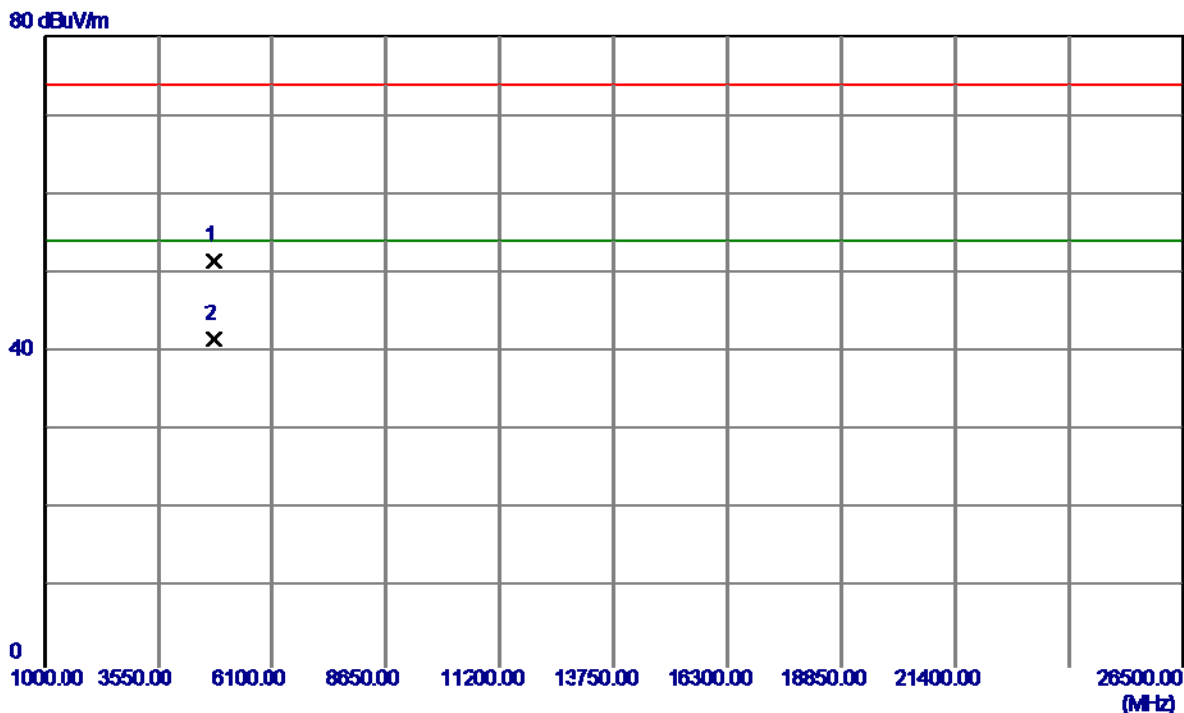

No.	Freq. MHz	Reading Level dBuV/m	Correct Factor dB	Measure ment dBuV/m	Limit dBuV/m	Margin dB	Detector	Comment
1	4803.9700	48.46	3.00	51.46	74.00	-22.54	Peak	
2	4803.9750	38.54	3.00	41.54	54.00	-12.46	AVG	

Test Mode : TX 2441MHz _CH39_1Mbps

Vertical

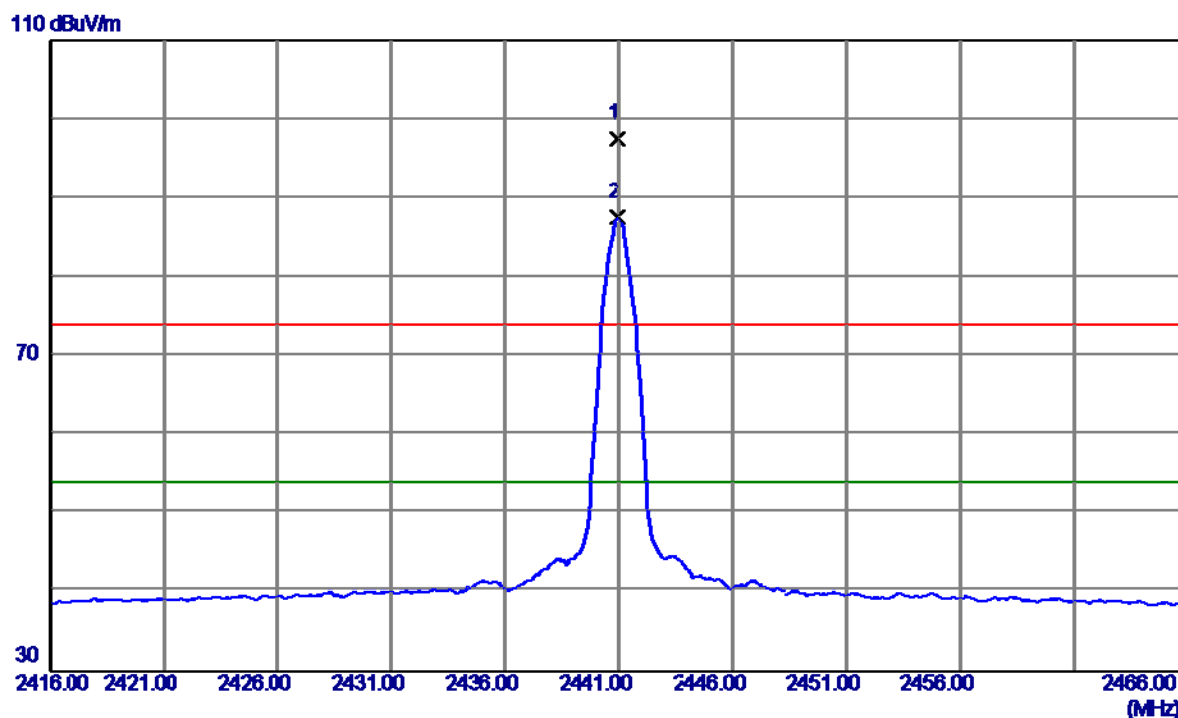

No.	Freq. MHz	Reading Level dBuV/m	Correct Factor dB	Measure ment dBuV/m	Limit dBuV/m	Margin dB	Detector	Comment
1	2440.9500	63.00	34.53	97.53	74.00	23.53	Peak	No Limit
2	2440.9500	53.08	34.53	87.61	54.00	33.61	AVG	No Limit

Test Mode : TX 2441MHz _CH39_1Mbps

Vertical

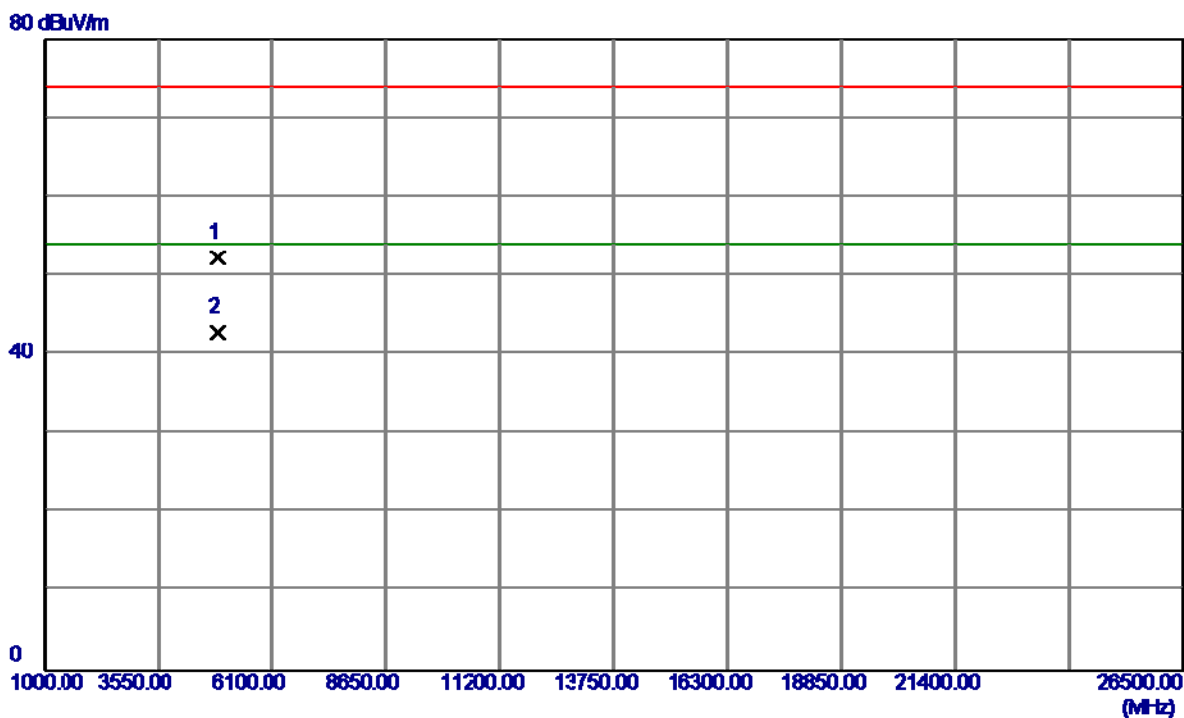

No.	Freq. MHz	Reading Level dBuV/m	Correct Factor dB	Measure ment dBuV/m	Limit dBuV/m	Margin dB	Detector	Comment
1	4881.4200	49.22	3.03	52.25	74.00	-21.75	Peak	
2	4882.3000	39.85	3.03	42.88	54.00	-11.12	AVG	

Test Mode : TX 2441MHz _CH39_1Mbps

Horizontal

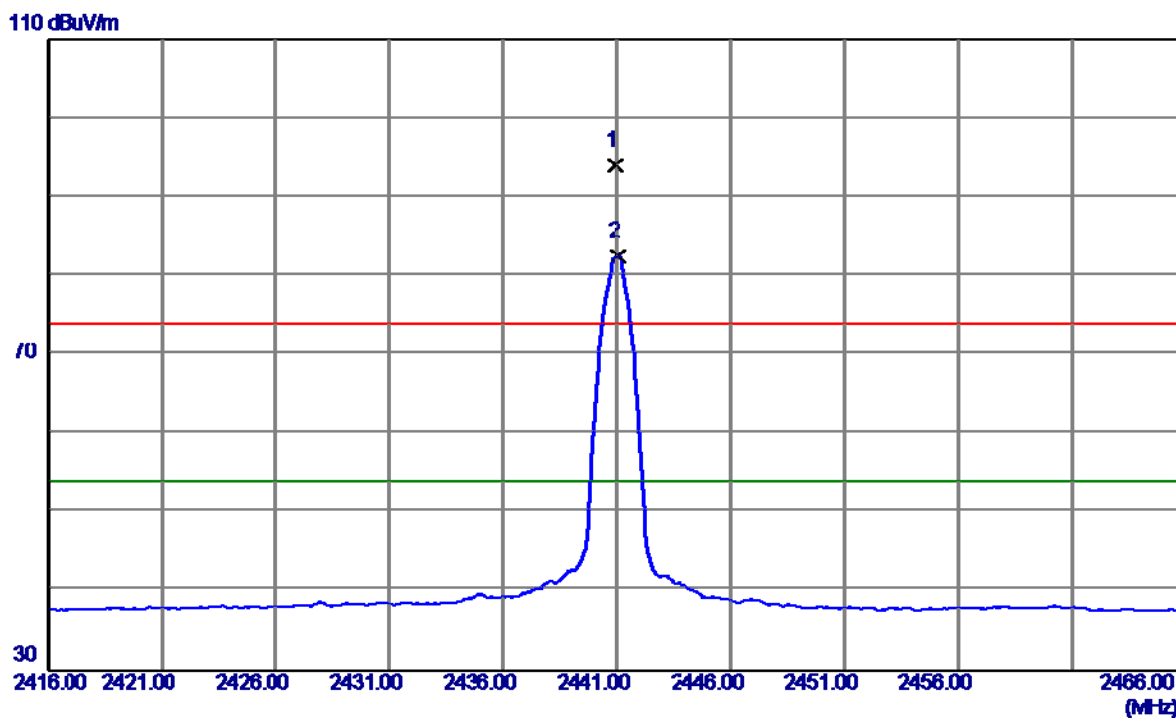

No.	Freq. MHz	Reading Level dBuV/m	Correct Factor dB	Measure ment dBuV/m	Limit dBuV/m	Margin dB	Detector	Comment
1	2440.9500	59.47	34.53	94.00	74.00	20.00	Peak	No Limit
2	2441.0500	47.99	34.53	82.52	54.00	28.52	AVG	No Limit

Test Mode : TX 2441MHz _CH39_1Mbps

Horizontal

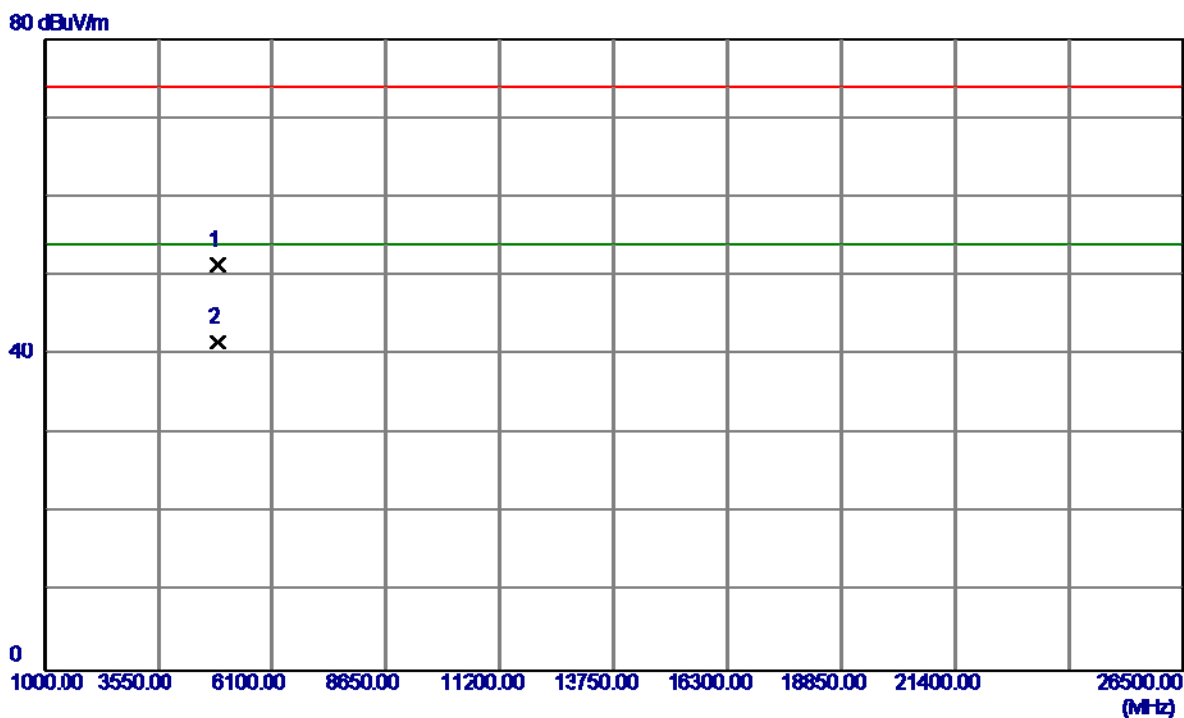

No.	Freq. MHz	Reading Level dBuV/m	Correct Factor dB	Measure ment dBuV/m	Limit dBuV/m	Margin dB	Detector	Comment
1	4882.9700	48.34	3.03	51.37	74.00	-22.63	Peak	
2	4883.7500	38.61	3.03	41.64	54.00	-12.36	AVG	

Test Mode : TX 2480MHz _CH78_1Mbps

Vertical

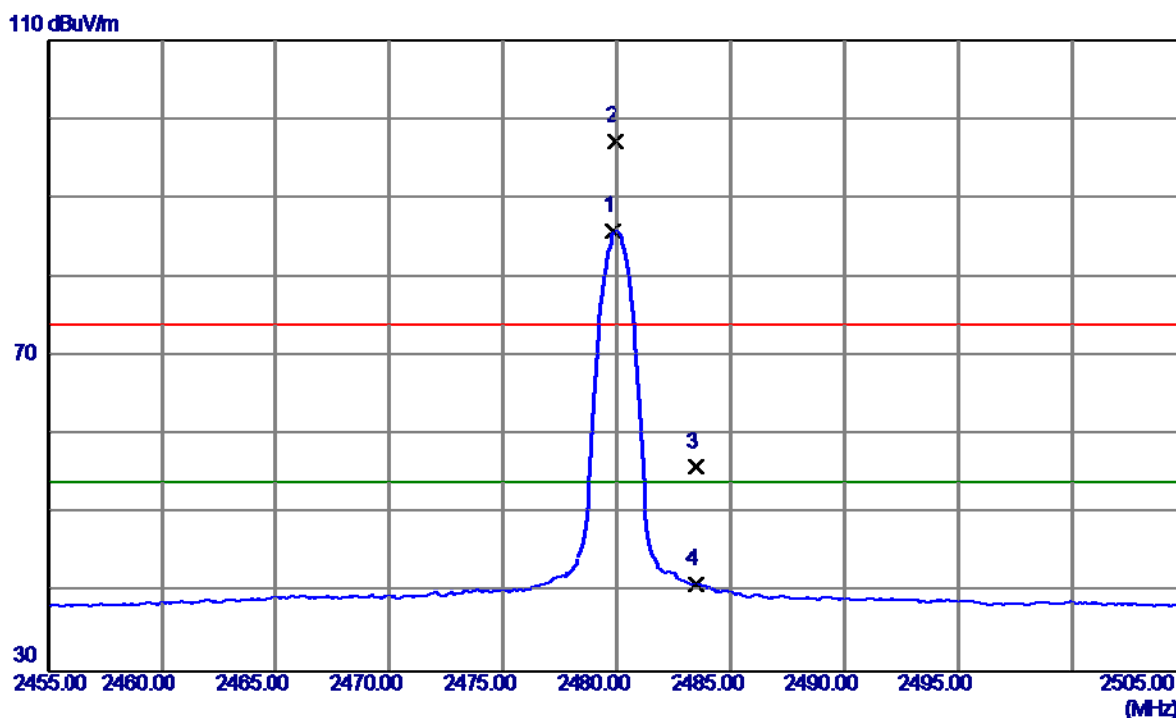

No.	Freq. MHz	Reading Level dBuV/m	Correct Factor dB	Measure ment dBuV/m	Limit dBuV/m	Margin dB	Detector	Comment
1	2479.9500	51.05	34.75	85.80	54.00	31.80	AVG	No Limit
2	2479.9500	62.43	34.75	97.18	74.00	23.18	Peak	No Limit
3	2483.5000	21.22	34.77	55.99	74.00	-18.01	Peak	
4	2483.5000	6.31	34.77	41.08	54.00	-12.92	AVG	

Test Mode : TX 2480MHz _CH78_1Mbps

Vertical

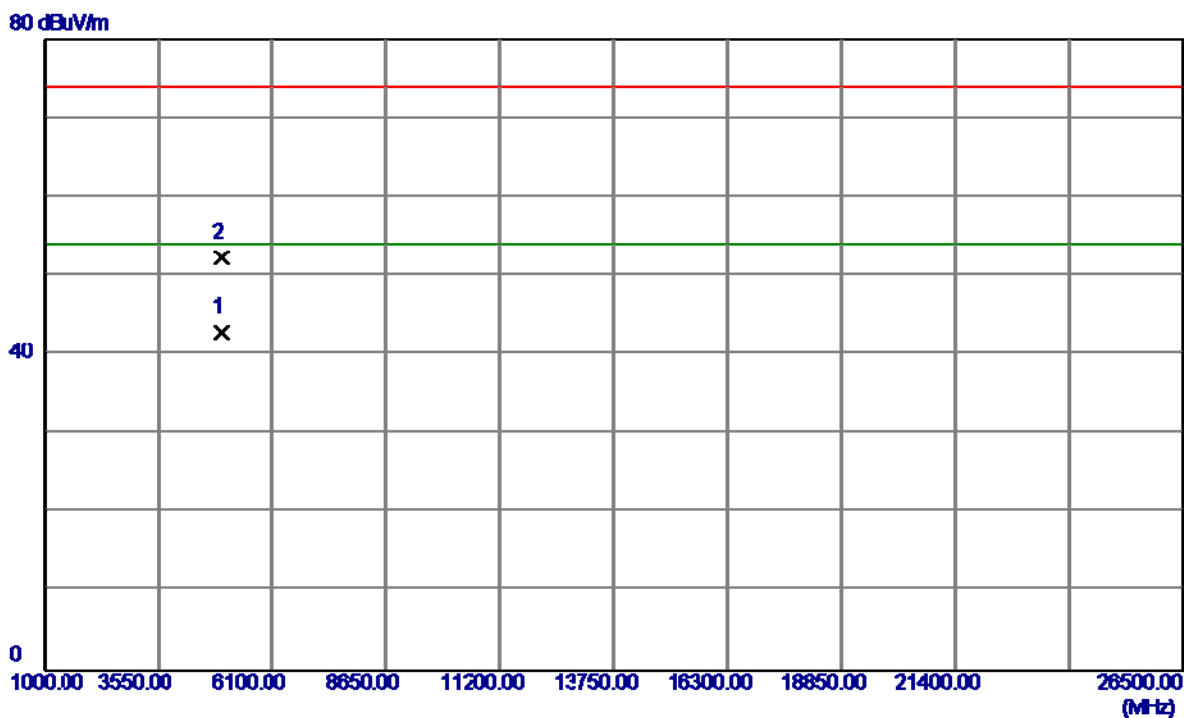

No.	Freq. MHz	Reading Level dBuV/m	Correct Factor dB	Measure ment dBuV/m	Limit dBuV/m	Margin dB	Detector	Comment
1	4960.3000	39.87	3.06	42.93	54.00	-11.07	AVG	
2	4960.5000	49.21	3.06	52.27	74.00	-21.73	Peak	

Test Mode : TX 2480MHz _CH78_1Mbps

Horizontal

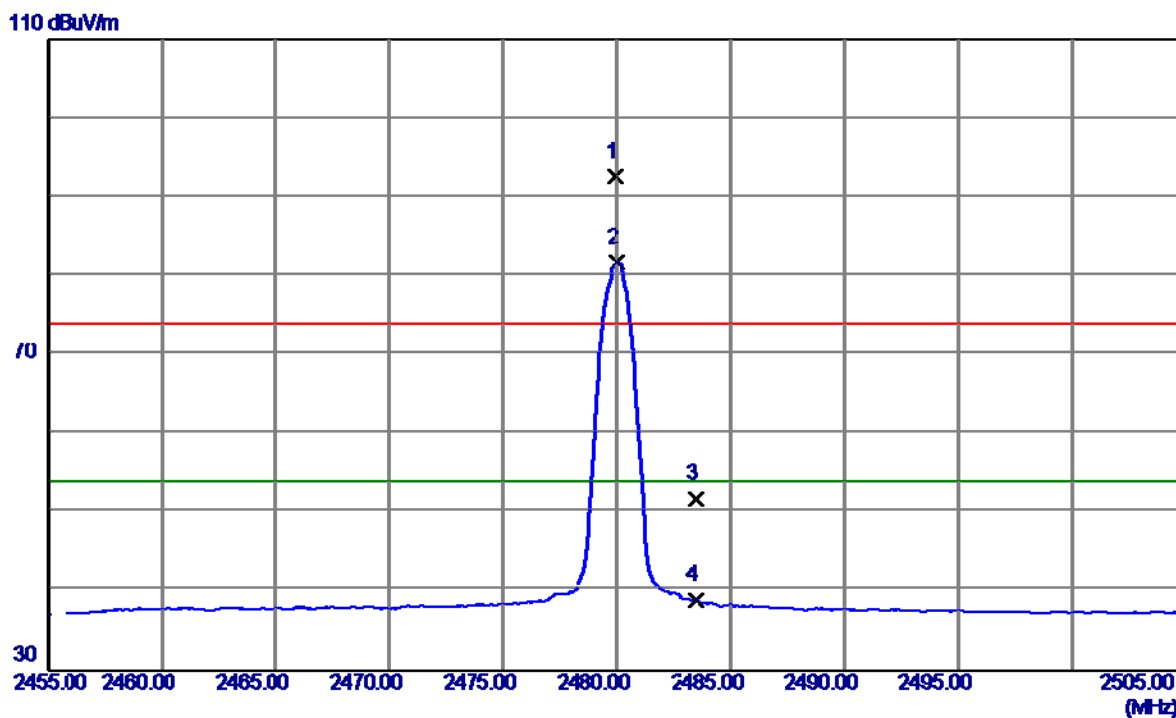

No.	Freq. MHz	Reading Level dBuV/m	Correct Factor dB	Measure ment dBuV/m	Limit dBuV/m	Margin dB	Detector	Comment
1	2479.9500	57.80	34.75	92.55	74.00	18.55	Peak	No Limit
2	2480.0000	46.97	34.75	81.72	54.00	27.72	AVG	No Limit
3	2483.5000	16.99	34.77	51.76	74.00	-22.24	Peak	
4	2483.5000	4.19	34.77	38.96	54.00	-15.04	AVG	

Test Mode : TX 2480MHz _CH78_1Mbps

Horizontal

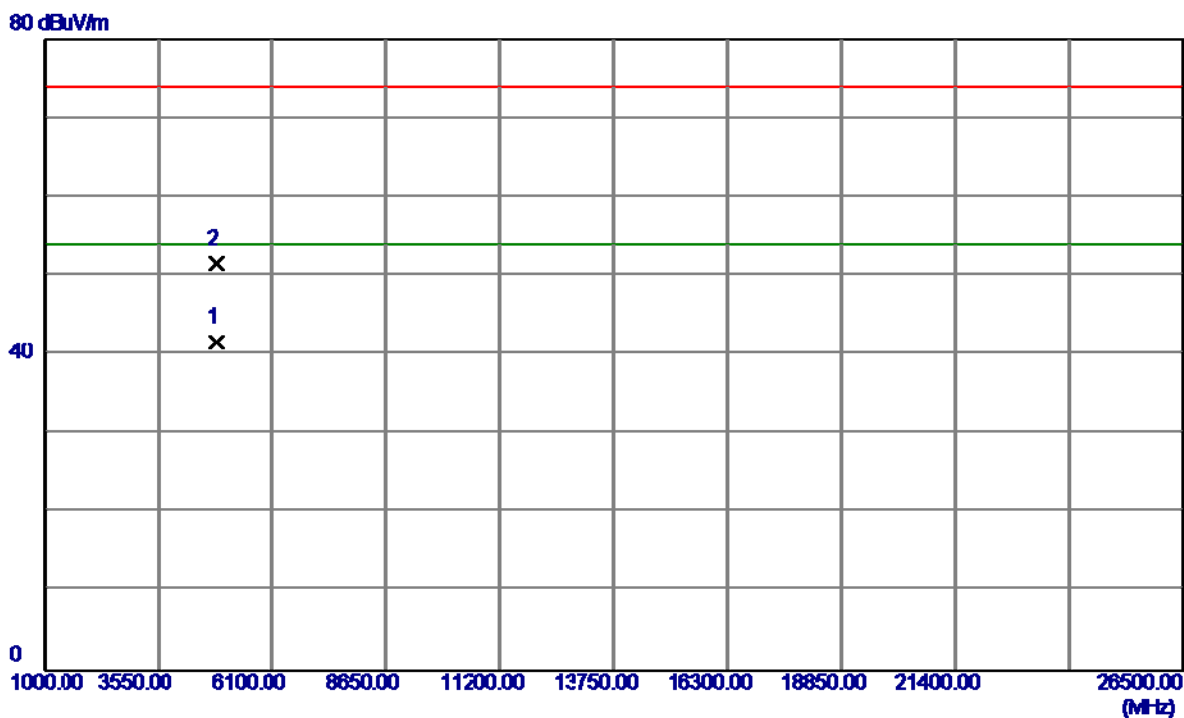

No.	Freq. MHz	Reading Level dBuV/m	Correct Factor dB	Measure ment dBuV/m	Limit dBuV/m	Margin dB	Detector	Comment
1	4860.2000	38.60	3.02	41.62	54.00	-12.38	AVG	
2	4860.8400	48.56	3.02	51.58	74.00	-22.42	Peak	

Test Mode : TX 2402MHz _CH00_3Mbps

Vertical

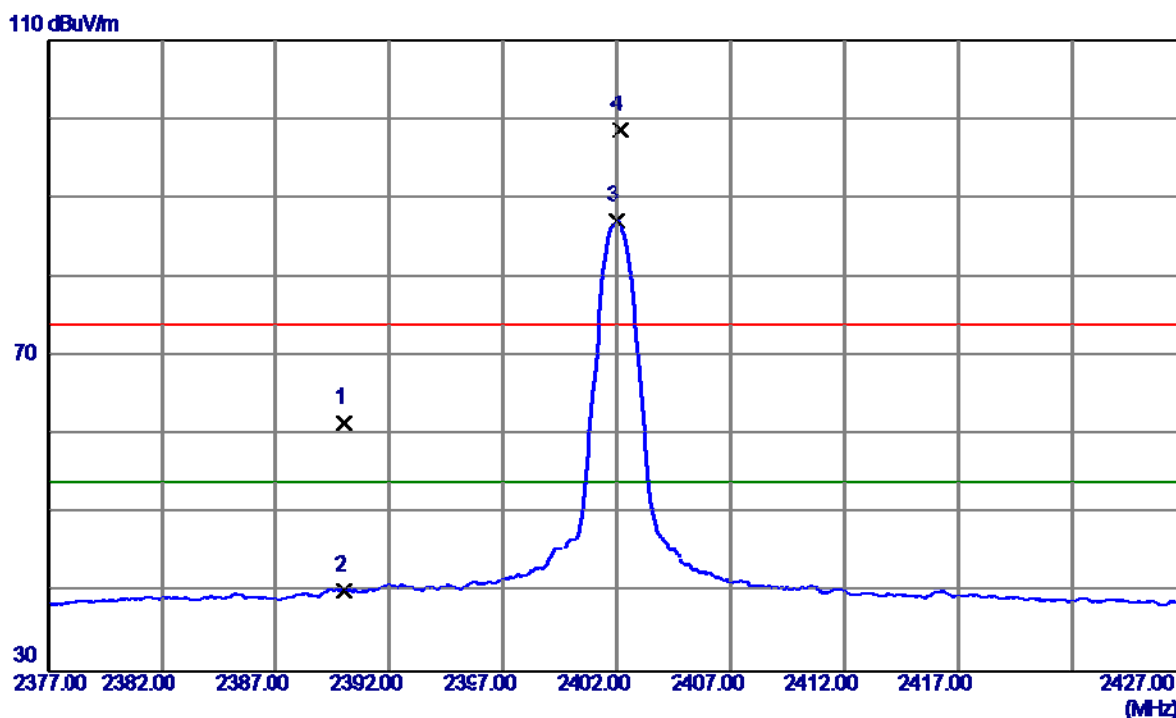

No.	Freq. MHz	Reading Level dBuV/m	Correct Factor dB	Measure ment dBuV/m	Limit dBuV/m	Margin dB	Detector	Comment
1	2390.0000	27.29	34.23	61.52	74.00	-12.48	Peak	
2	2390.0000	6.03	34.23	40.26	54.00	-13.74	AVG	
3	2402.0000	52.86	34.30	87.16	54.00	33.16	AVG	No Limit
4	2402.1500	64.28	34.30	98.58	74.00	24.58	Peak	No Limit

Test Mode : TX 2402MHz _CH00_3Mbps

Vertical

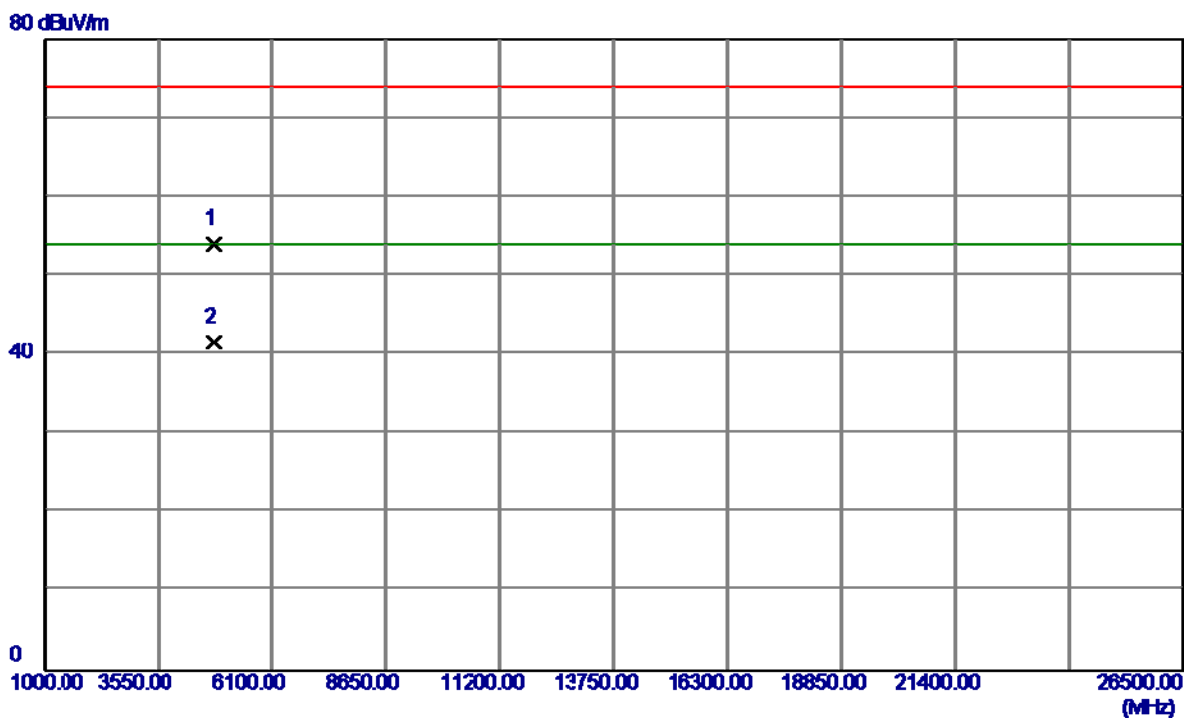

No.	Freq. MHz	Reading Level dBuV/m	Correct Factor dB	Measure ment dBuV/m	Limit dBuV/m	Margin dB	Detector	Comment
1	4803.4400	51.06	3.00	54.06	74.00	-19.94	Peak	
2	4803.9800	38.67	3.00	41.67	54.00	-12.33	AVG	

Test Mode : TX 2402MHz_CH00_3Mbps

Horizontal

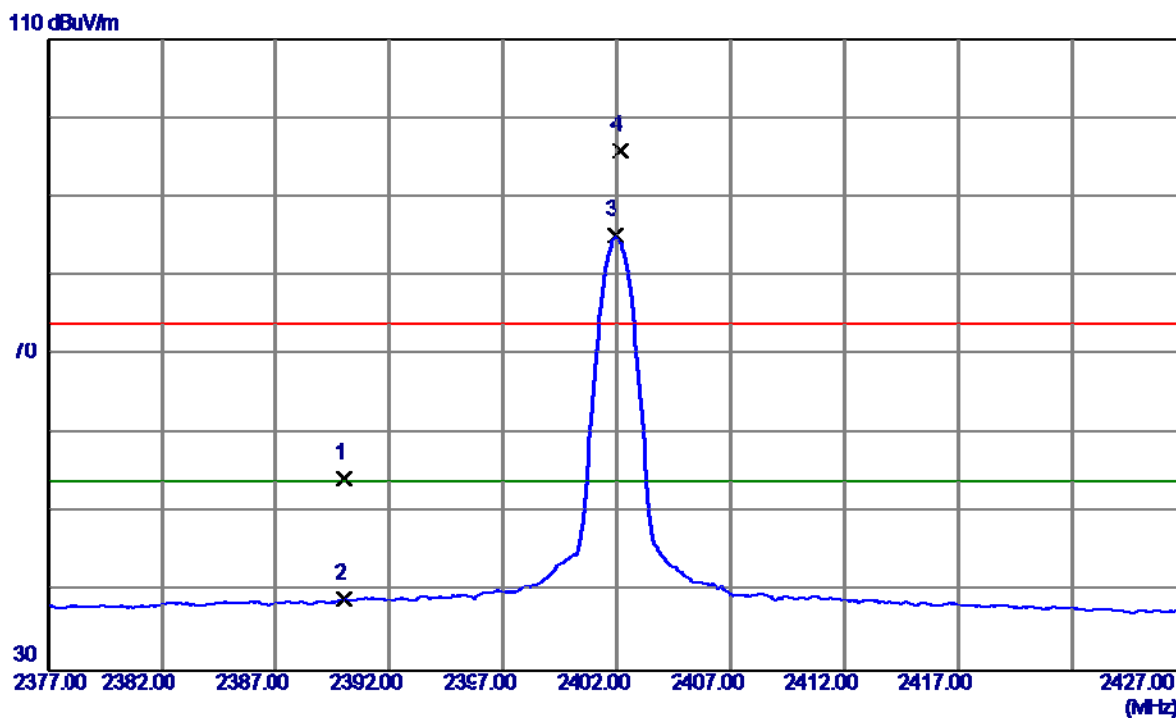

No.	Freq. MHz	Reading Level dBuV/m	Correct Factor dB	Measure ment dBuV/m	Limit dBuV/m	Margin dB	Detector	Comment
1	2390.0000	20.03	34.23	54.26	74.00	-19.74	Peak	
2	2390.0000	4.95	34.23	39.18	54.00	-14.82	AVG	
3	2401.9500	50.83	34.30	85.13	54.00	31.13	AVG	No Limit
4	2402.1500	61.55	34.30	95.85	74.00	21.85	Peak	No Limit

Test Mode : TX 2402MHz _CH00_3Mbps

Horizontal

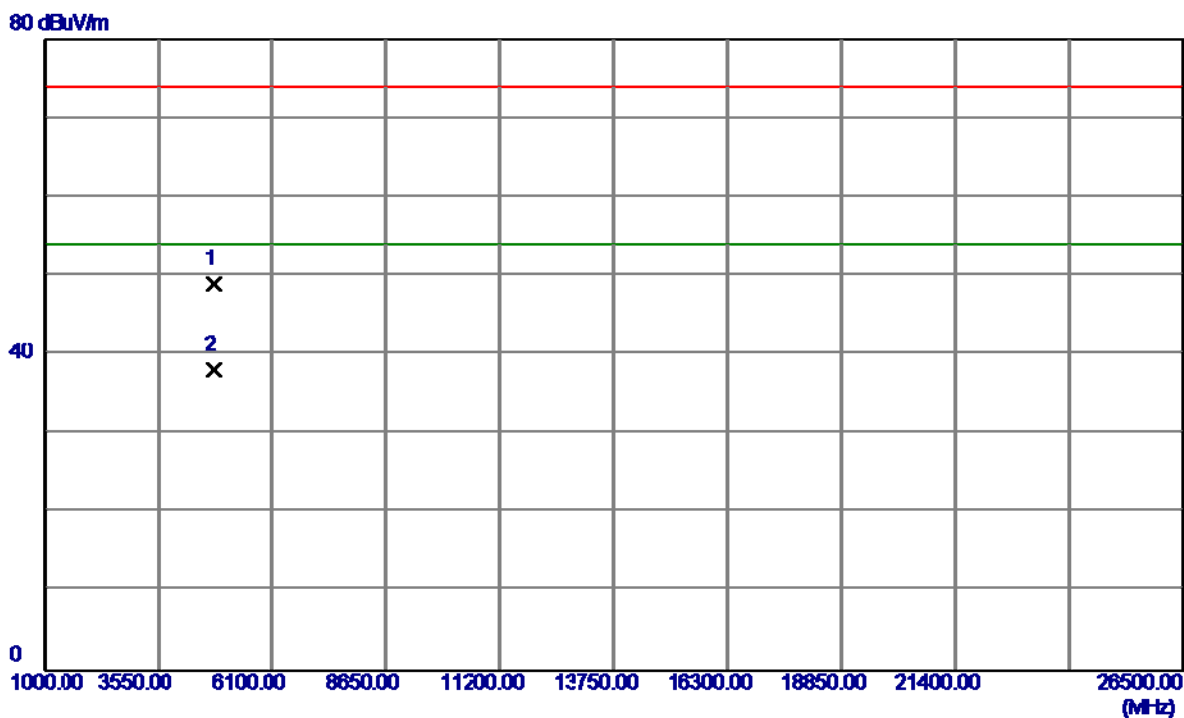

No.	Freq. MHz	Reading Level dBuV/m	Correct Factor dB	Measure ment dBuV/m	Limit dBuV/m	Margin dB	Detector	Comment
1	4803.6500	46.03	3.00	49.03	74.00	-24.97	Peak	
2	4804.0200	35.14	3.00	38.14	54.00	-15.86	AVG	

Test Mode : TX 2441MHz _CH39_3Mbps

Vertical

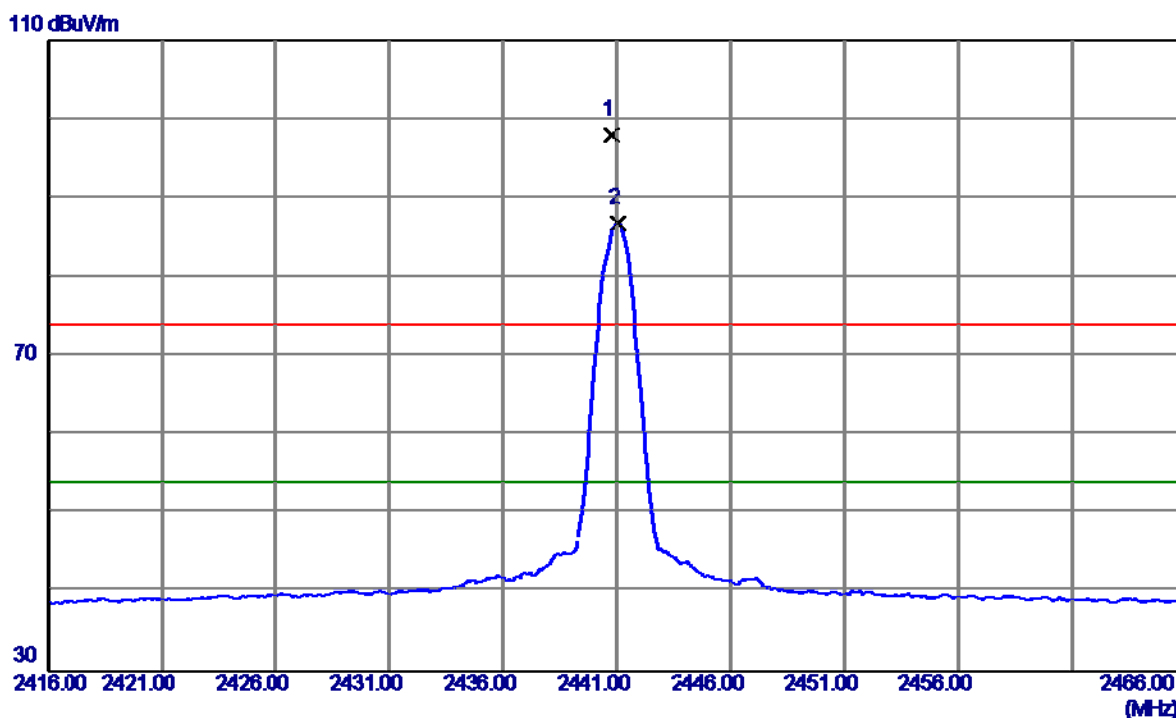

No.	Freq. MHz	Reading Level dBuV/m	Correct Factor dB	Measure ment dBuV/m	Limit dBuV/m	Margin dB	Detector	Comment
1	2440.8000	63.44	34.53	97.97	74.00	23.97	Peak	No Limit
2	2441.0500	52.22	34.53	86.75	54.00	32.75	AVG	No Limit

Test Mode : TX 2441MHz _CH39_3Mbps

Vertical

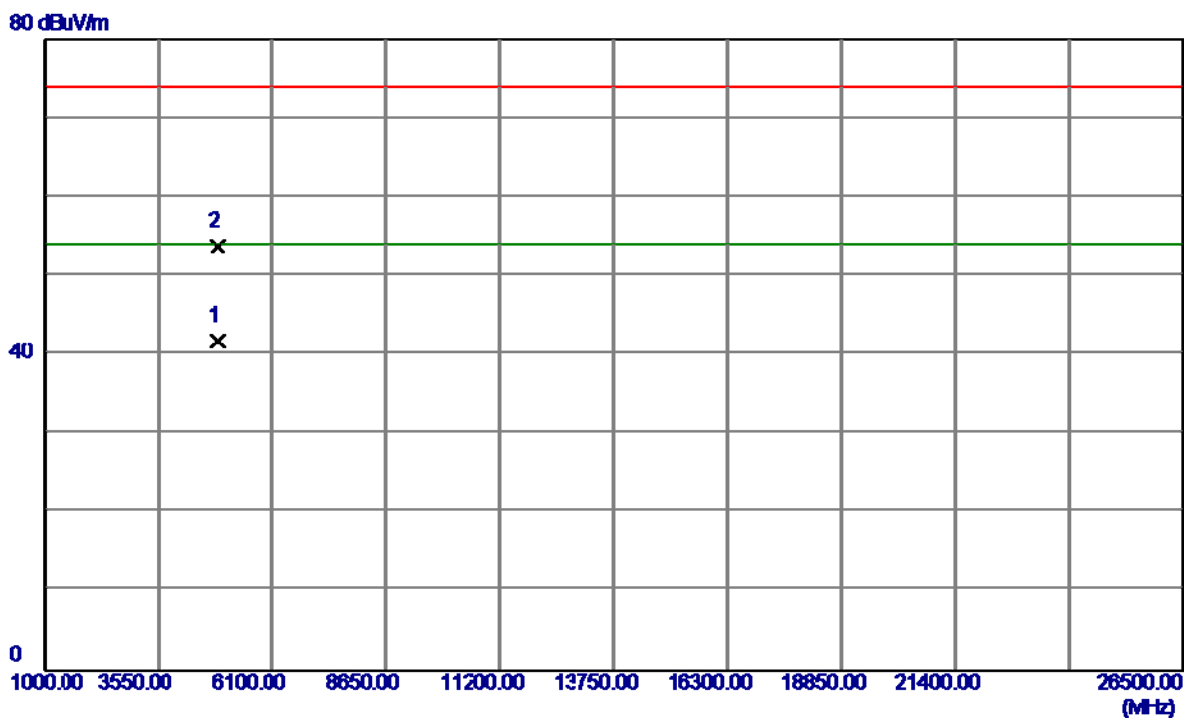

No.	Freq. MHz	Reading Level dBuV/m	Correct Factor dB	Measure ment dBuV/m	Limit dBuV/m	Margin dB	Detector	Comment
1	4881.4000	38.78	3.03	41.81	54.00	-12.19	AVG	
2	4882.3000	50.79	3.03	53.82	74.00	-20.18	Peak	

Test Mode : TX 2441MHz _CH39_3Mbps

Horizontal

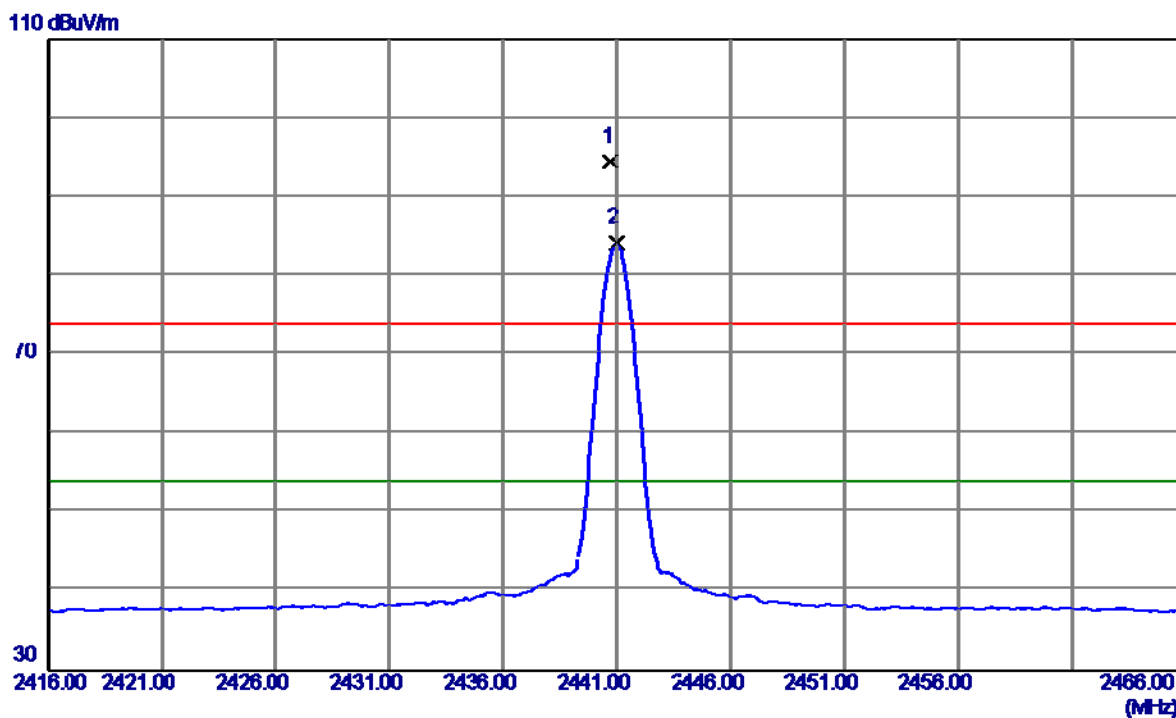

No.	Freq. MHz	Reading Level dBuV/m	Correct Factor dB	Measure ment dBuV/m	Limit dBuV/m	Margin dB	Detector	Comment
1	2440.7500	59.99	34.53	94.52	74.00	20.52	Peak	No Limit
2	2441.0000	49.72	34.53	84.25	54.00	30.25	AVG	No Limit

Test Mode : TX 2441MHz _CH39_3Mbps

Horizontal

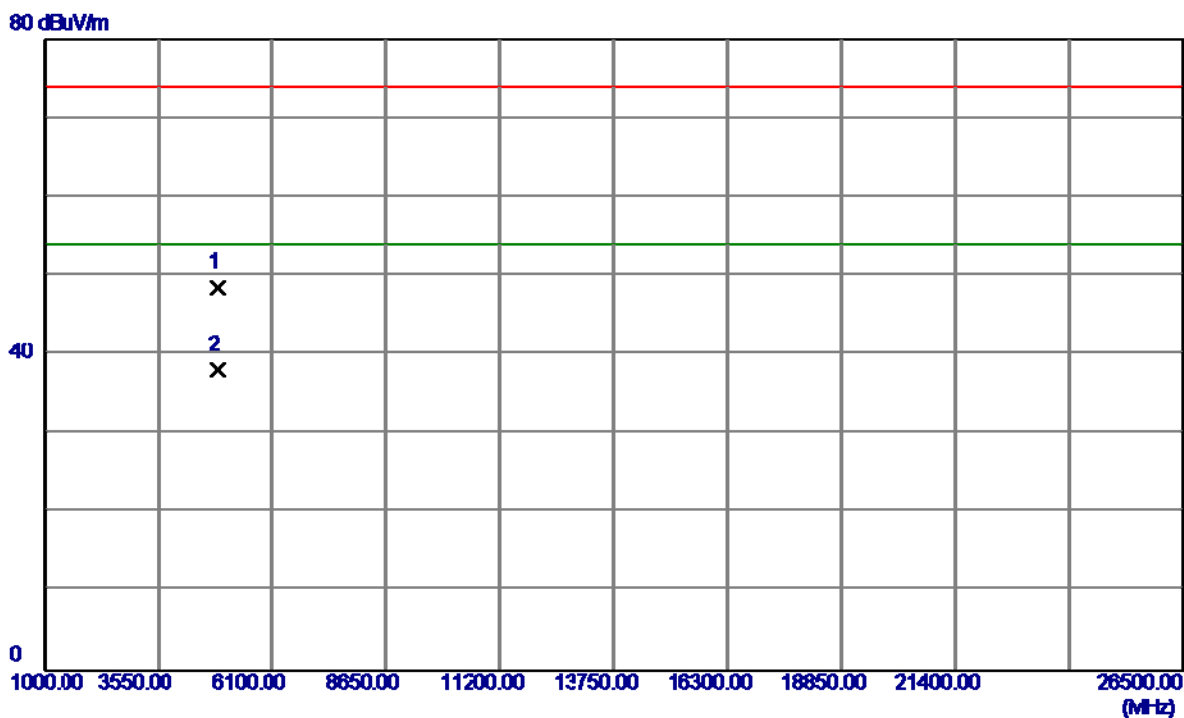

No.	Freq. MHz	Reading Level dBuV/m	Correct Factor dB	Measure ment dBuV/m	Limit dBuV/m	Margin dB	Detector	Comment
1	4882.5000	45.51	3.03	48.54	74.00	-25.46	Peak	
2	4883.1000	35.11	3.03	38.14	54.00	-15.86	AVG	

Test Mode : TX 2480MHz _CH78_3Mbps

Vertical

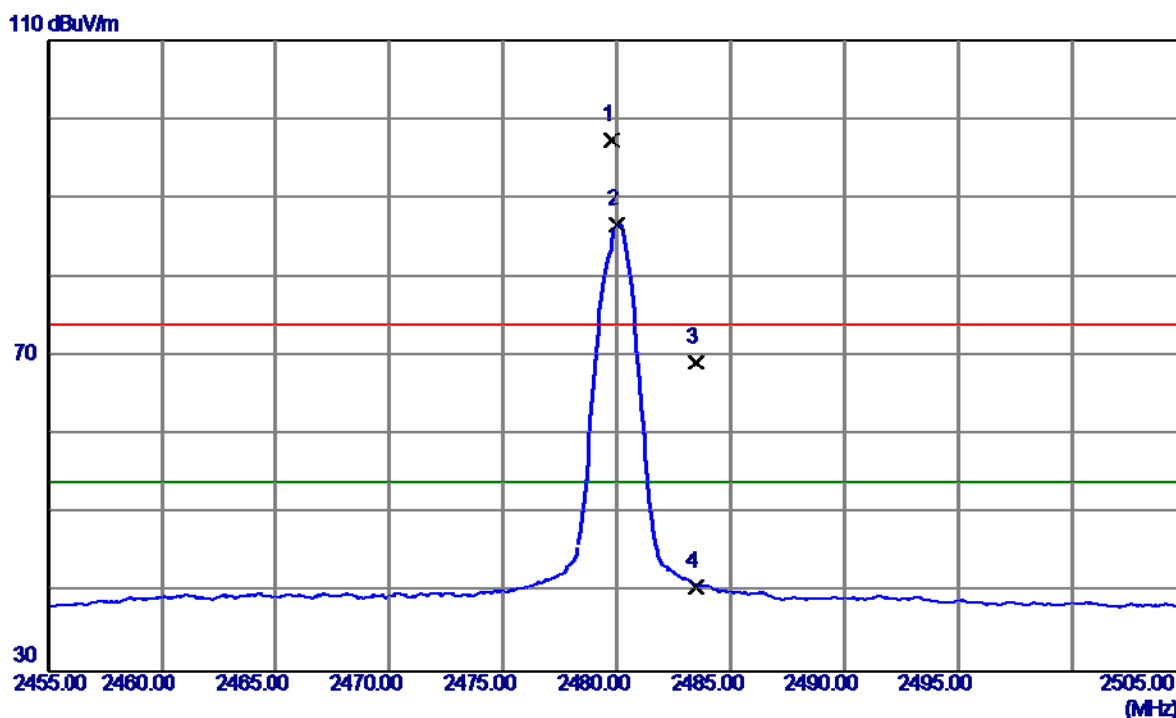

No.	Freq. MHz	Reading Level dBuV/m	Correct Factor dB	Measure ment dBuV/m	Limit dBuV/m	Margin dB	Detector	Comment
1	2479.9000	62.62	34.75	97.37	74.00	23.37	Peak	No Limit
2	2480.0000	51.89	34.75	86.64	54.00	32.64	AVG	No Limit
3	2483.5000	34.42	34.77	69.19	74.00	-4.81	Peak	
4	2483.5000	6.01	34.77	40.78	54.00	-13.22	AVG	

Test Mode : TX 2480MHz _CH78_3Mbps

Vertical

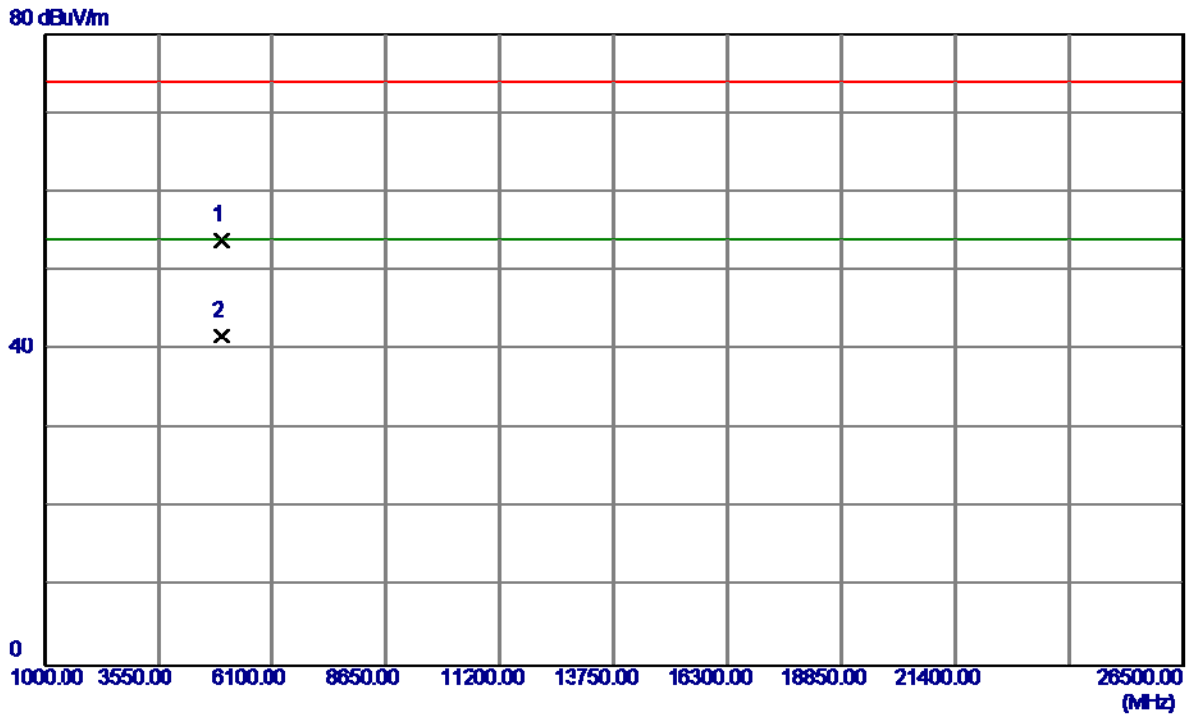

No.	Freq. MHz	Reading Level dBuV/m	Correct Factor dB	Measure ment dBuV/m	Limit dBuV/m	Margin dB	Detector	Comment
1	4960.3200	50.91	3.06	53.97	74.00	-20.03	Peak	
2	4960.5000	38.75	3.06	41.81	54.00	-12.19	AVG	

Test Mode : TX 2480MHz _CH78_3Mbps

Horizontal

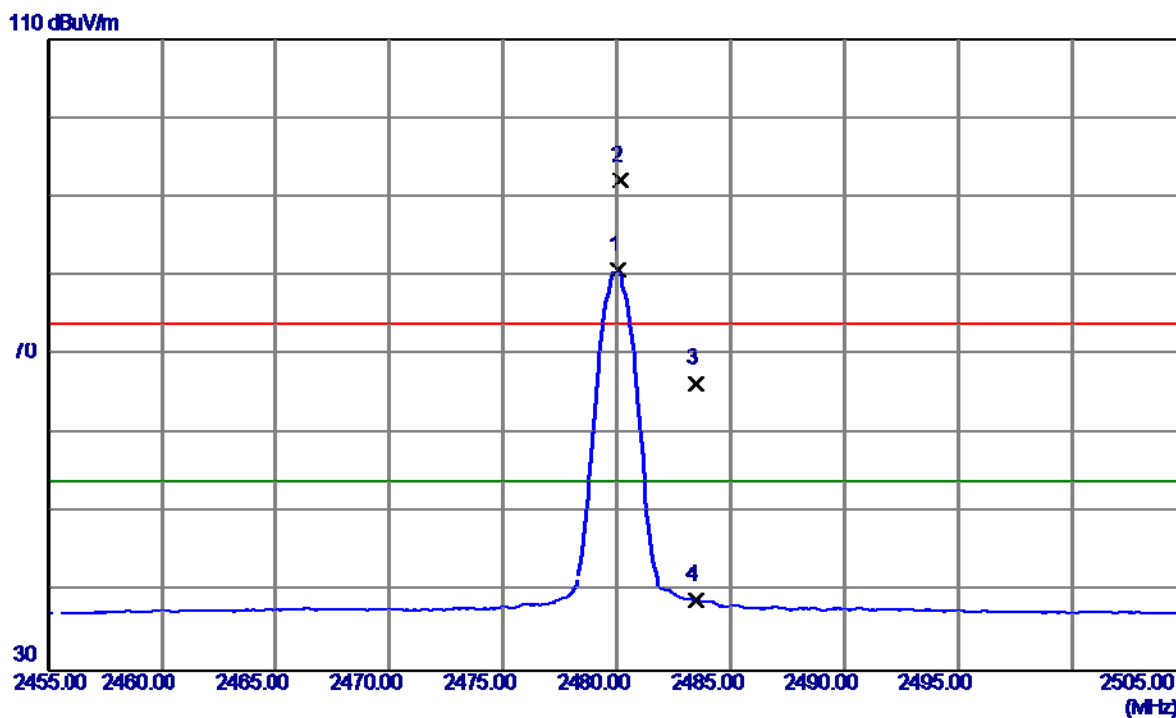

No.	Freq. MHz	Reading Level dBuV/m	Correct Factor dB	Measure ment dBuV/m	Limit dBuV/m	Margin dB	Detector	Comment
1	2480.0500	45.96	34.75	80.71	54.00	26.71	AVG	No Limit
2	2480.1500	57.31	34.75	92.06	74.00	18.06	Peak	No Limit
3	2483.5000	31.58	34.77	66.35	74.00	-7.65	Peak	
4	2483.5000	4.20	34.77	38.97	54.00	-15.03	AVG	

Test Mode : TX 2480MHz _CH78_3Mbps

Horizontal

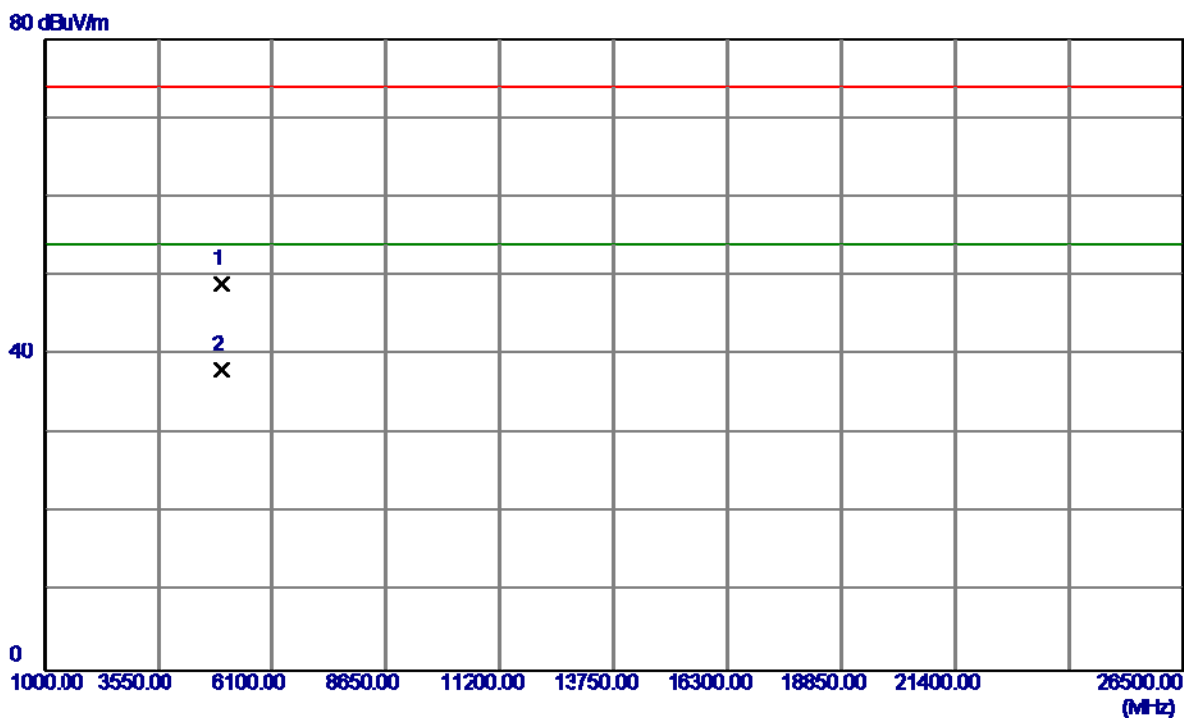

No.	Freq. MHz	Reading Level dBuV/m	Correct Factor dB	Measure ment dBuV/m	Limit dBuV/m	Margin dB	Detector	Comment
1	4961.2300	45.89	3.06	48.95	74.00	-25.05	Peak	
2	4961.3000	35.08	3.06	38.14	54.00	-15.86	AVG	

ATTACHMENT E - NUMBER OF HOPPING CHANNEL

Test Mode **Hopping Mode_1Mbps**
Number of Hopping Channel 79

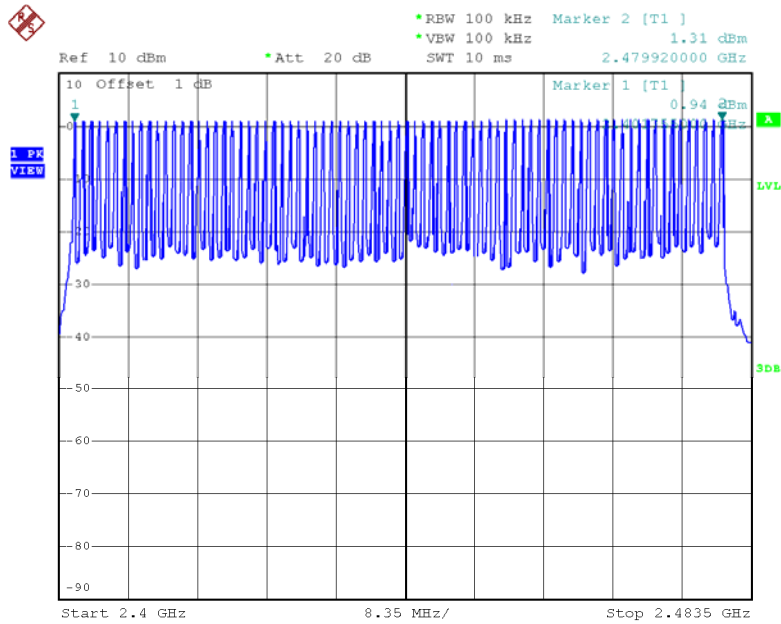

Date: 9.JAN.2016 16:39:42

Test Mode **Hopping Mode_3Mbps**
Number of Hopping Channel 79

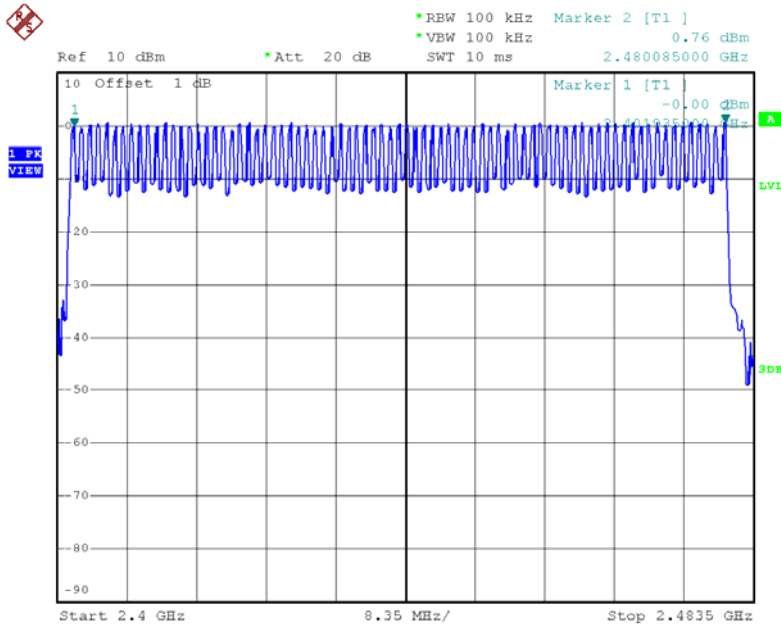

Date: 9.JAN.2016 17:01:35

ATTACHMENT F - AVERAGE TIME OF OCCUPANCY

Test Mode :	TX Mode_1Mbps
-------------	---------------

Data Packet	Frequency (MHz)	Pulse Duration (ms)	Dwell Time (s)	Limits (s)	Test Result
DH5	2402	2.3600	0.2517	0.4000	Pass
DH3	2402	1.7000	0.1813	0.4000	Pass
DH1	2402	0.4050	0.0432	0.4000	Pass
DH5	2441	2.5200	0.2688	0.4000	Pass
DH3	2441	1.3600	0.1451	0.4000	Pass
DH1	2441	0.3500	0.0373	0.4000	Pass
DH5	2480	2.4000	0.2560	0.4000	Pass
DH3	2480	1.4000	0.1493	0.4000	Pass
DH1	2480	0.3800	0.0405	0.4000	Pass

CH00-DH1

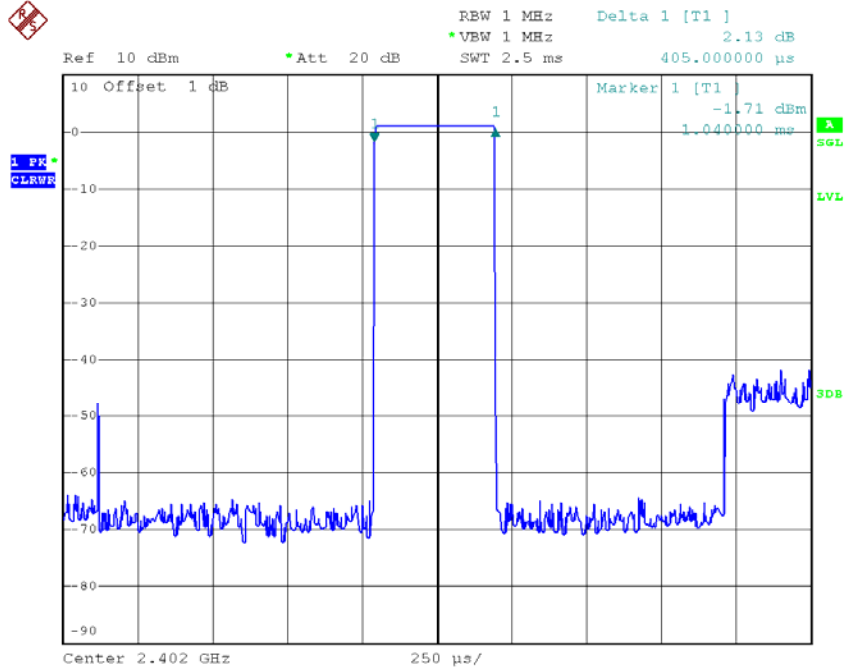

Date: 9.JAN.2016 16:14:26

CH00-DH3

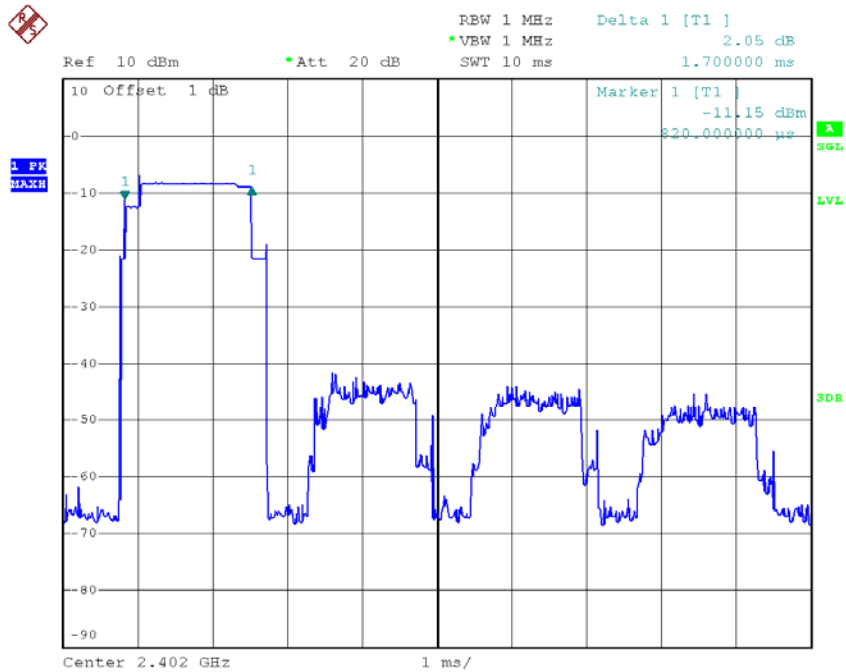

Date: 9.JAN.2016 16:47:04

CH00-DH5

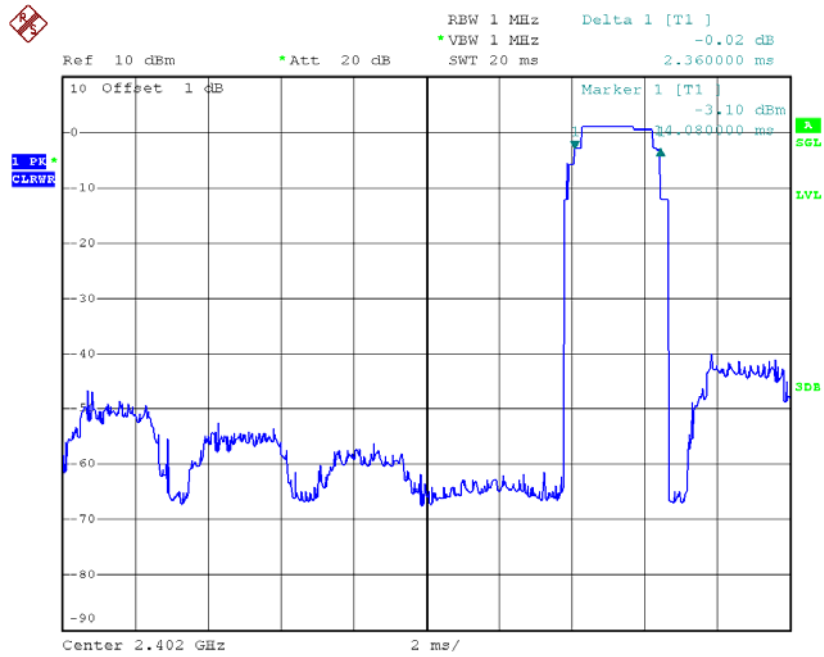

Date: 9.JAN.2016 16:47:38

CH39-DH1

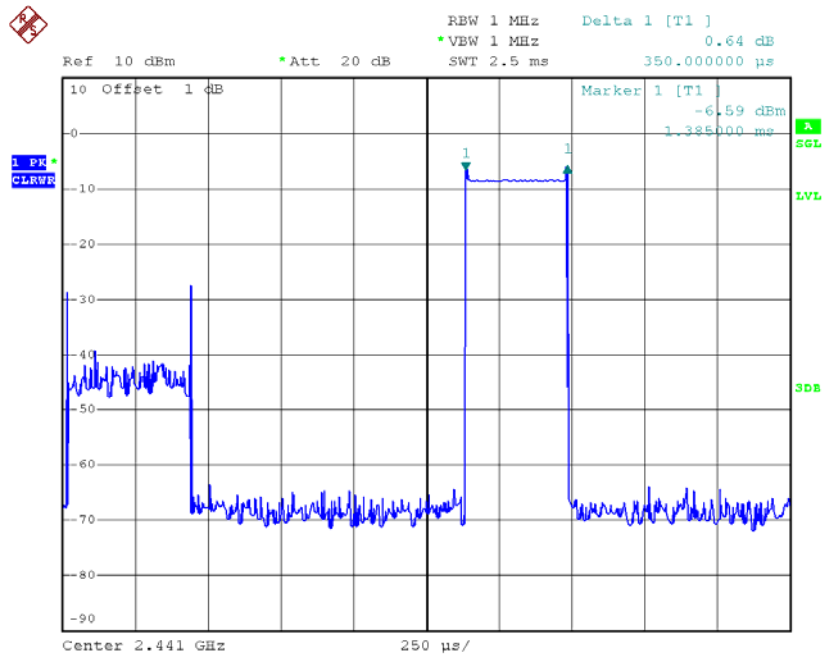

Date: 9.JAN.2016 16:14:32

CH39-DH3

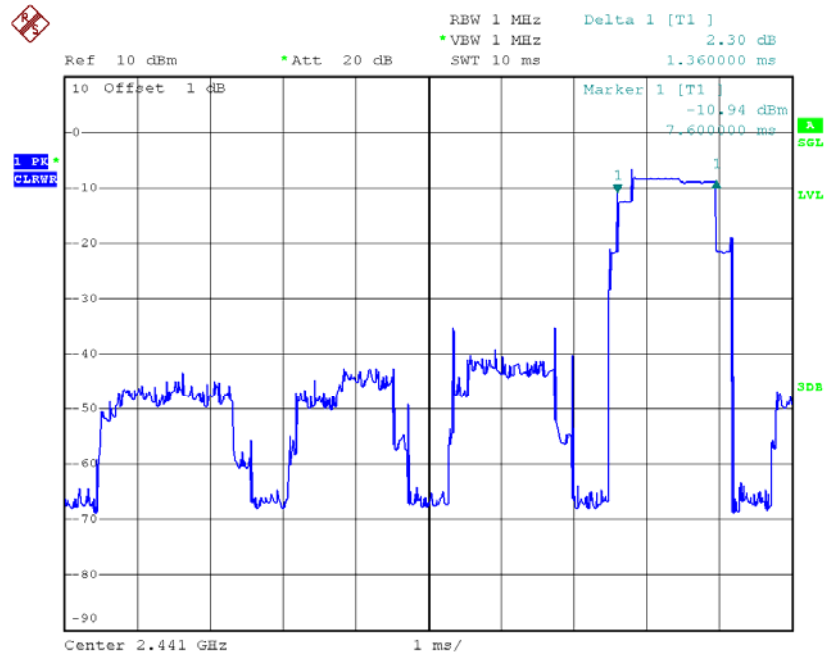

Date: 9.JAN.2016 16:47:09

CH39-DH5

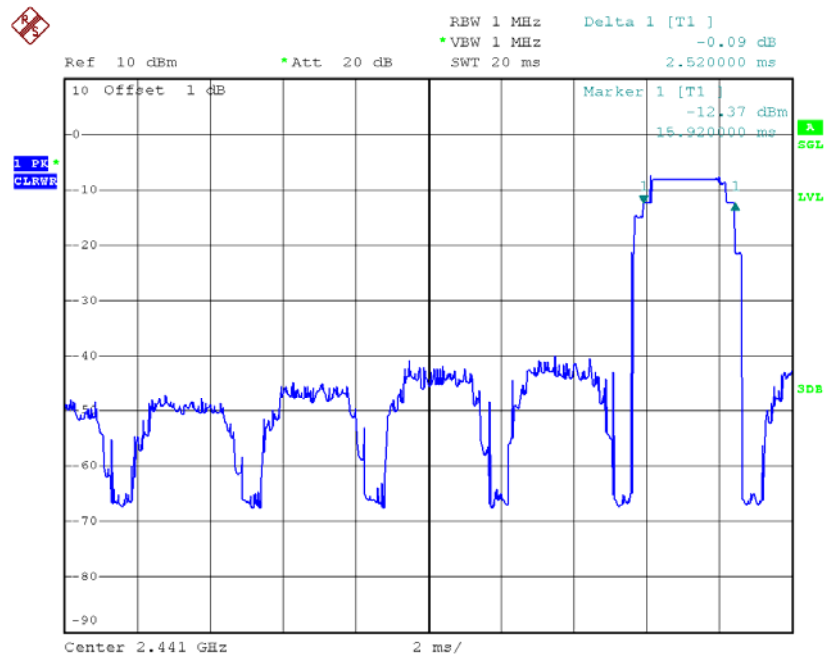

Date: 9.JAN.2016 16:47:43

CH78-DH1

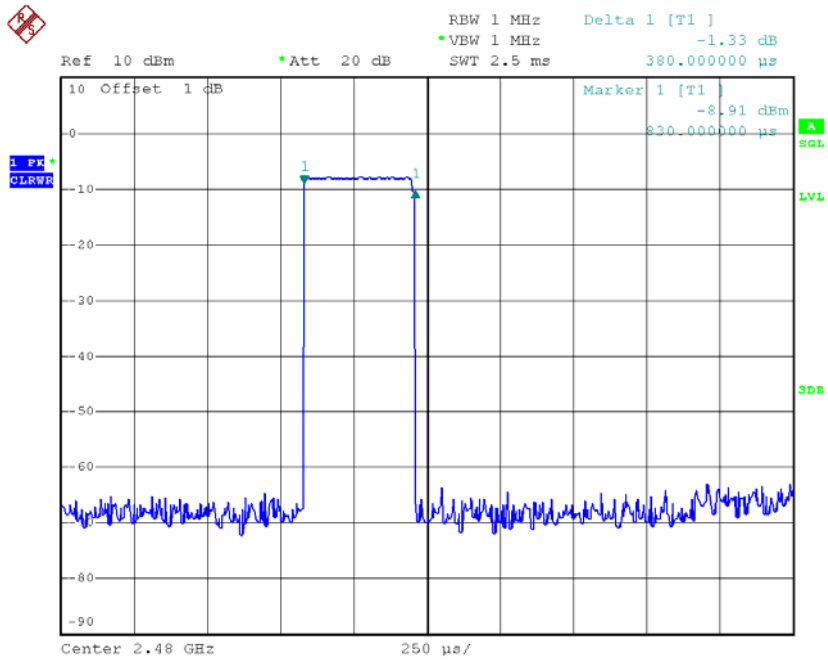

Date: 9.JAN.2016 16:14:37

CH78-DH3

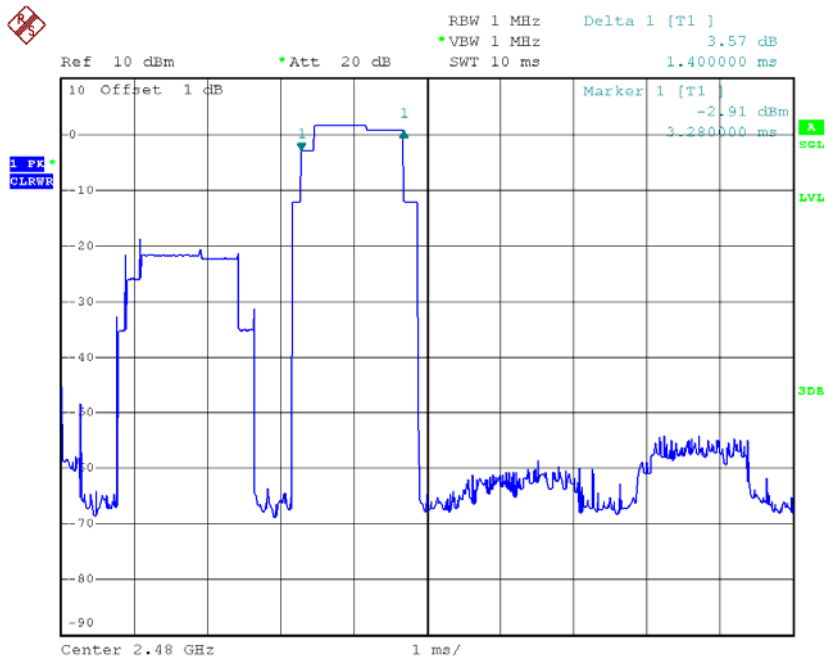

Date: 9.JAN.2016 16:47:16

CH78-DH5

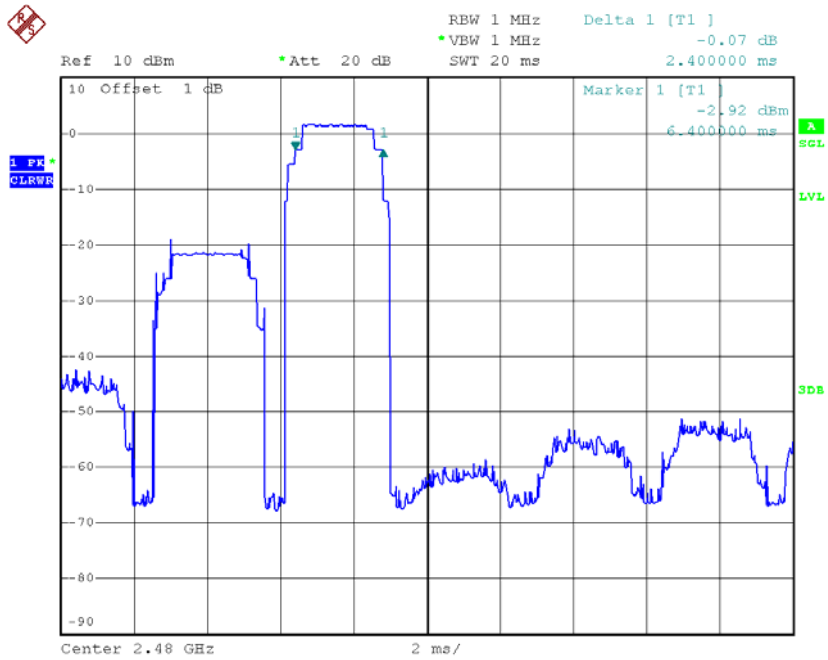

Date: 9.JAN.2016 16:47:52

Test Mode :	TX Mode_3Mbps
-------------	---------------

Data Packet	Frequency	Pulse Duration(ms)	Dwell Time(s)	Limits(s)	Test Result
DH5	2402	2.4000	0.2560	0.4000	Pass
DH3	2402	1.3800	0.1472	0.4000	Pass
DH1	2402	0.5450	0.0581	0.4000	Pass
DH5	2441	2.3600	0.2517	0.4000	Pass
DH3	2441	1.3400	0.1429	0.4000	Pass
DH1	2441	0.4050	0.0432	0.4000	Pass
DH5	2480	2.3600	0.2517	0.4000	Pass
DH3	2480	1.4600	0.1557	0.4000	Pass
DH1	2480	0.3700	0.0395	0.4000	Pass

CH00-DH1

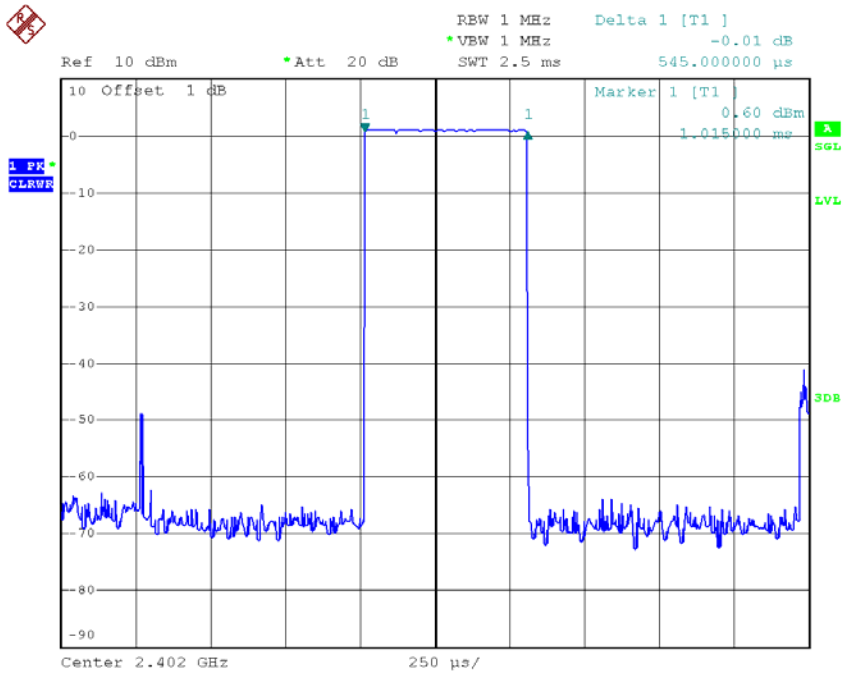

Date: 9.JAN.2016 16:56:07

CH00-DH3

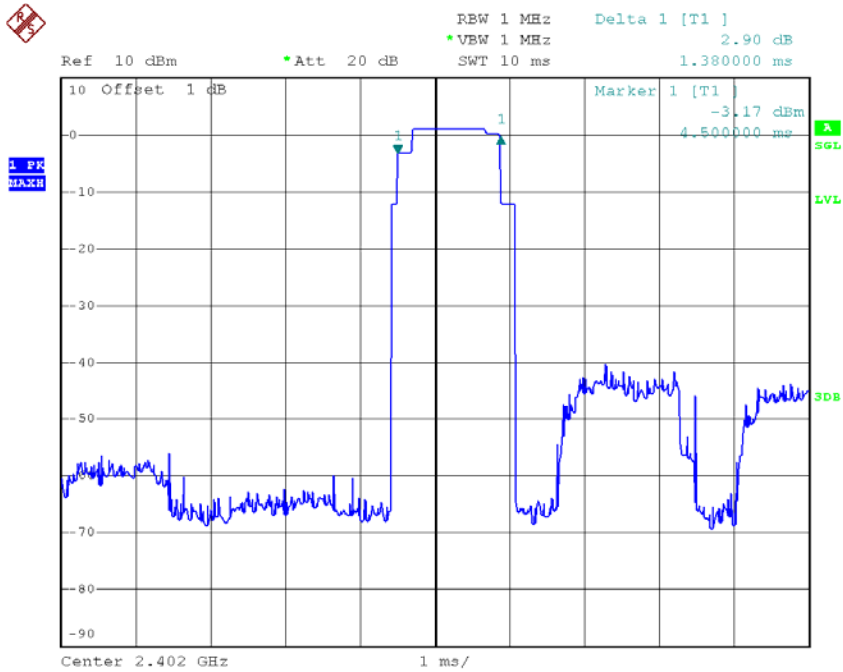

Date: 9.JAN.2016 17:03:06

CH00-DH5

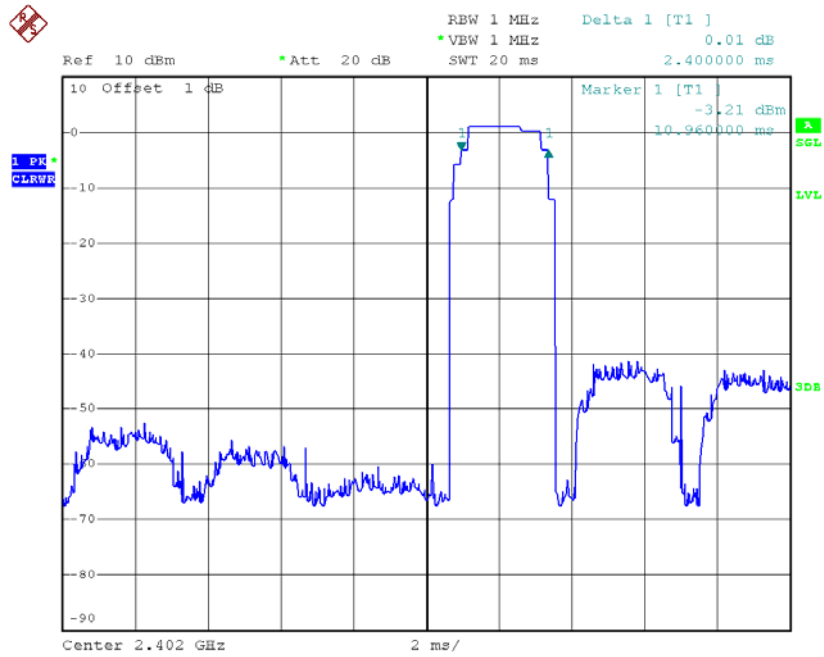

Date: 9.JAN.2016 17:03:31

CH39-DH1

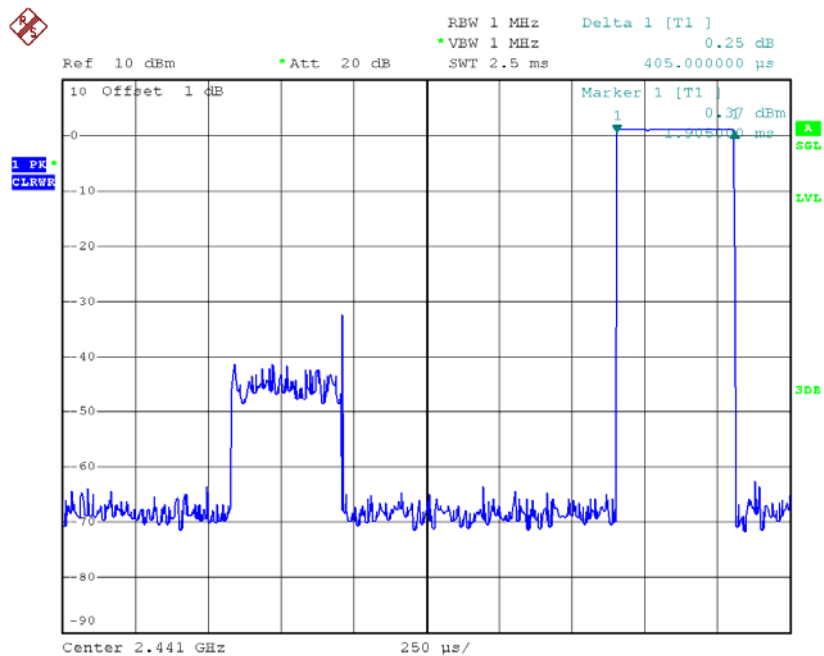

Date: 9.JAN.2016 16:56:17

CH39-DH3

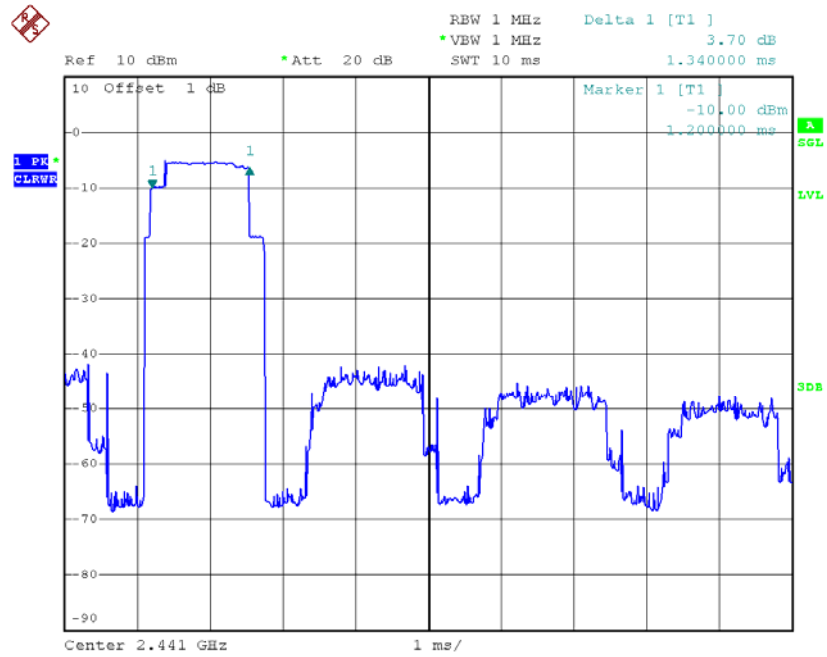

Date: 9.JAN.2016 17:03:10

CH39-DH5

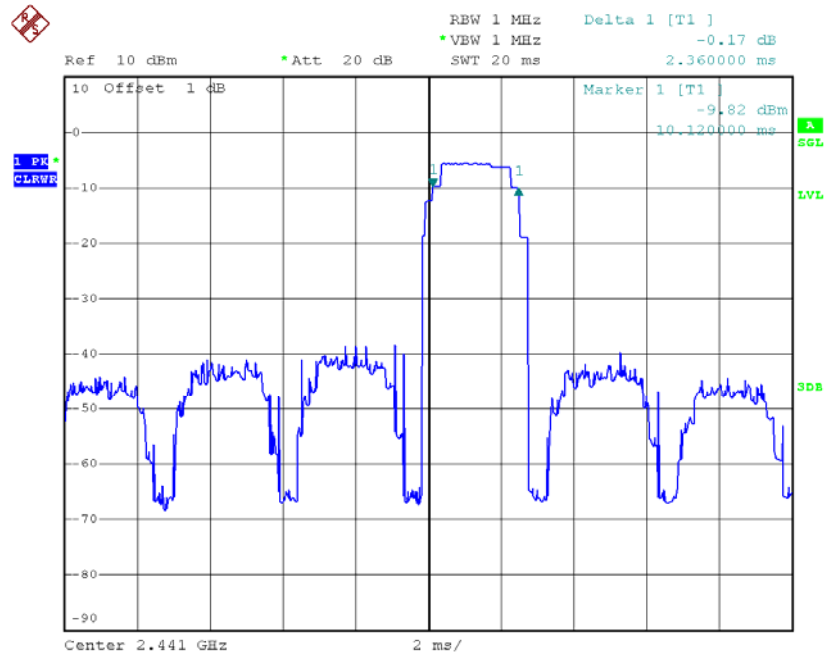

Date: 9.JAN.2016 17:03:35

CH78-DH1

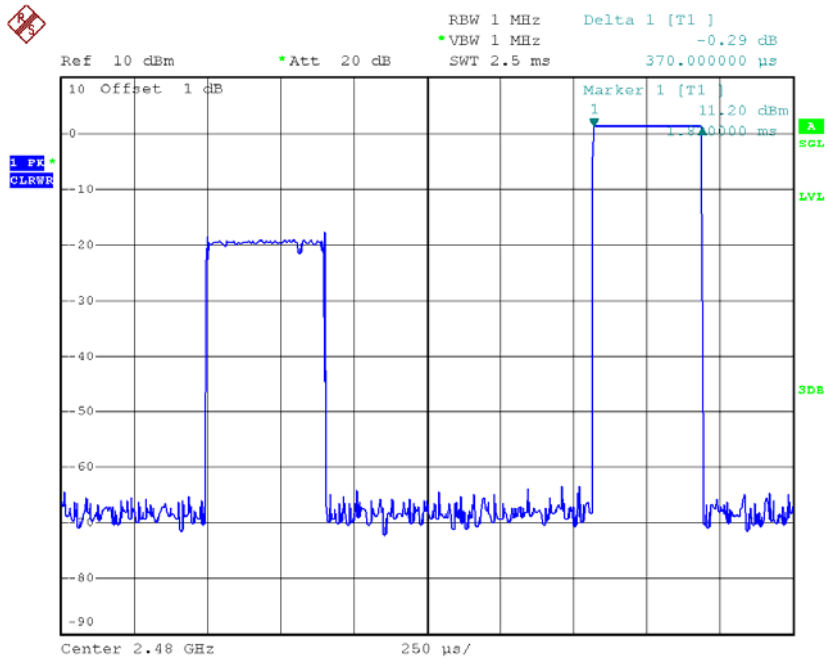

Date: 9.JAN.2016 16:56:21

CH78-DH3

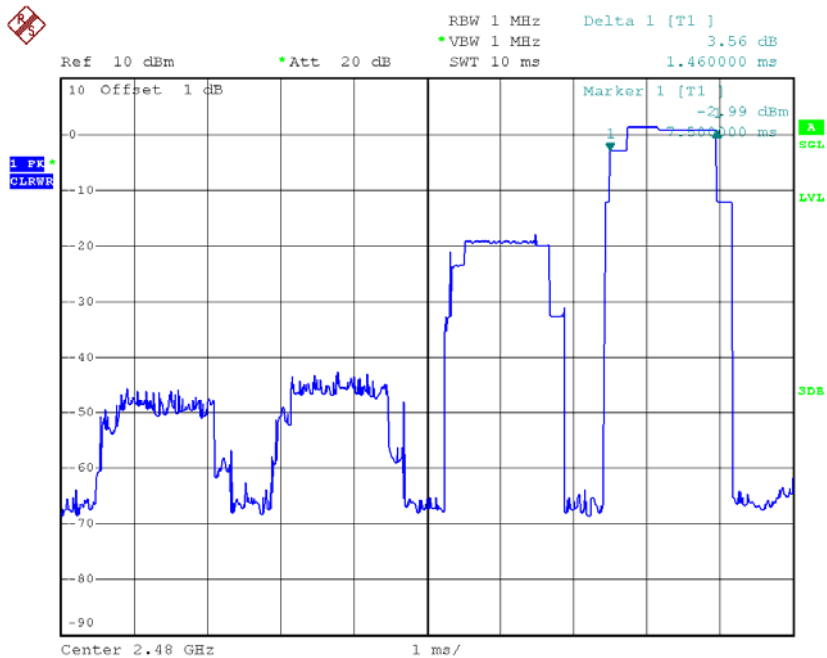

Date: 9.JAN.2016 17:03:15

CH78-DH5

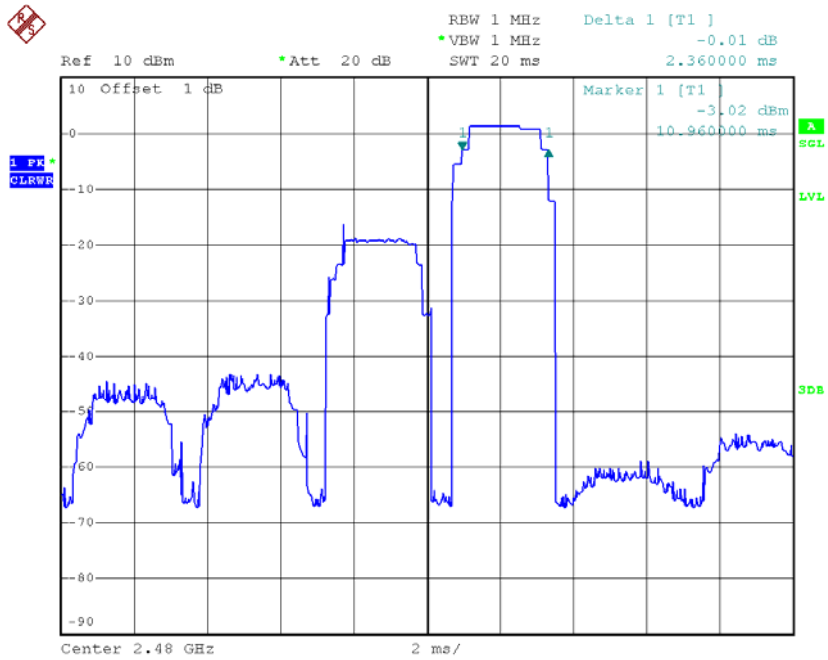

Date: 9.JAN.2016 17:03:41

ATTACHMENT G - HOPPING CHANNEL SEPARATION MEASUREMENT

Test Mode : Hopping on _1Mbps

Frequency (MHz)	Channel Separation (MHz)	2/3 of 20dB Bandwidth (MHz)	Test Result
2402	1.004	0.695	Pass
2441	1.004	0.732	Pass
2480	1.002	0.704	Pass

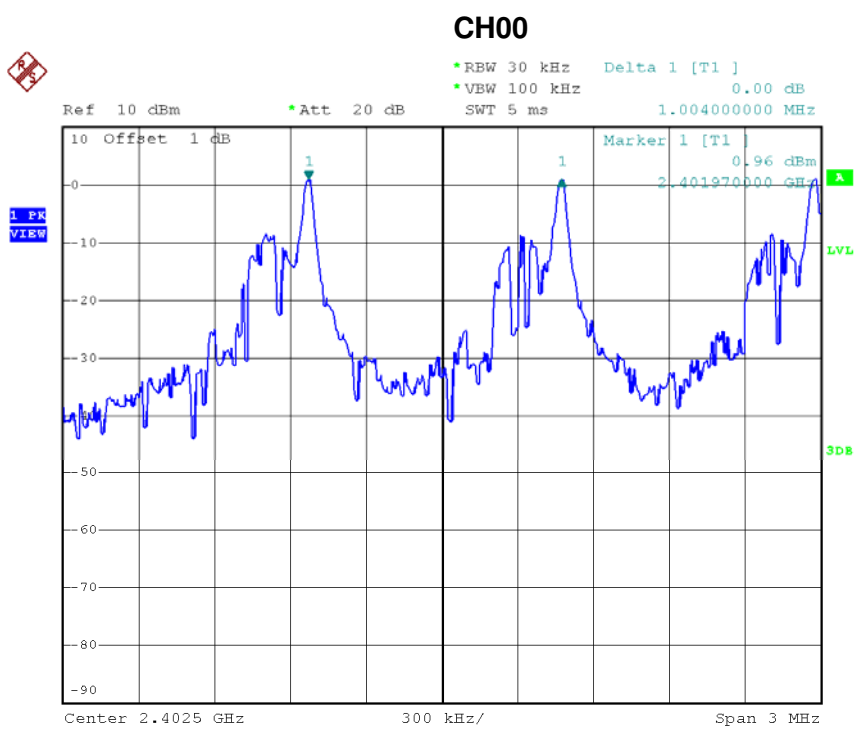

Date: 9.JAN.2016 16:30:07

CH39

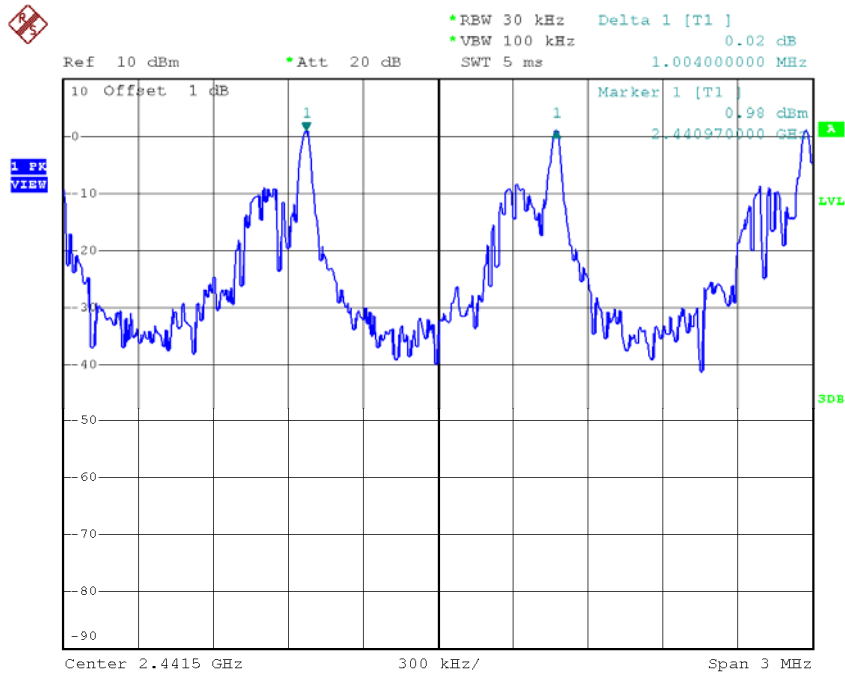

Date: 9.JAN.2016 16:26:26

CH78

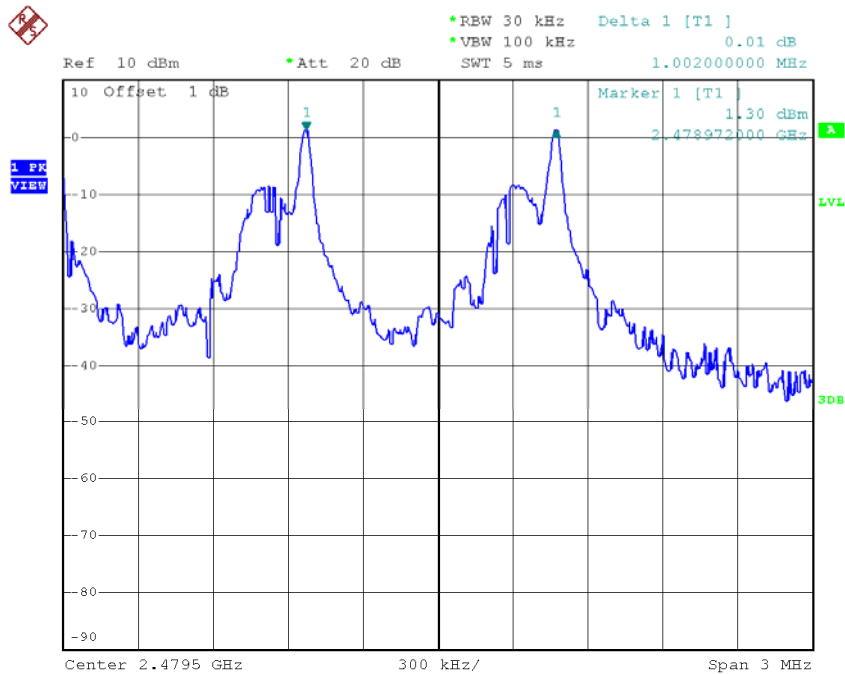

Date: 9.JAN.2016 16:32:57

Test Mode : Hopping on _3Mbps

Frequency (MHz)	Channel Separation (MHz)	2/3 of 20dB Bandwidth (MHz)	Test Result
2402	1.037	0.921	Pass
2441	0.997	0.921	Pass
2480	0.960	0.923	Pass

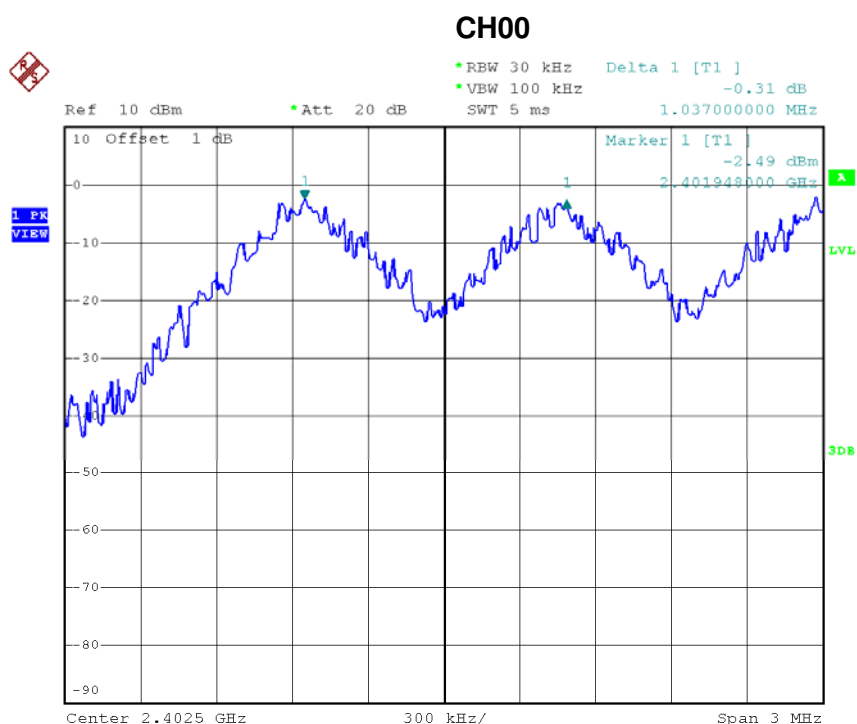

Date: 9.JAN.2016 16:57:31

CH39

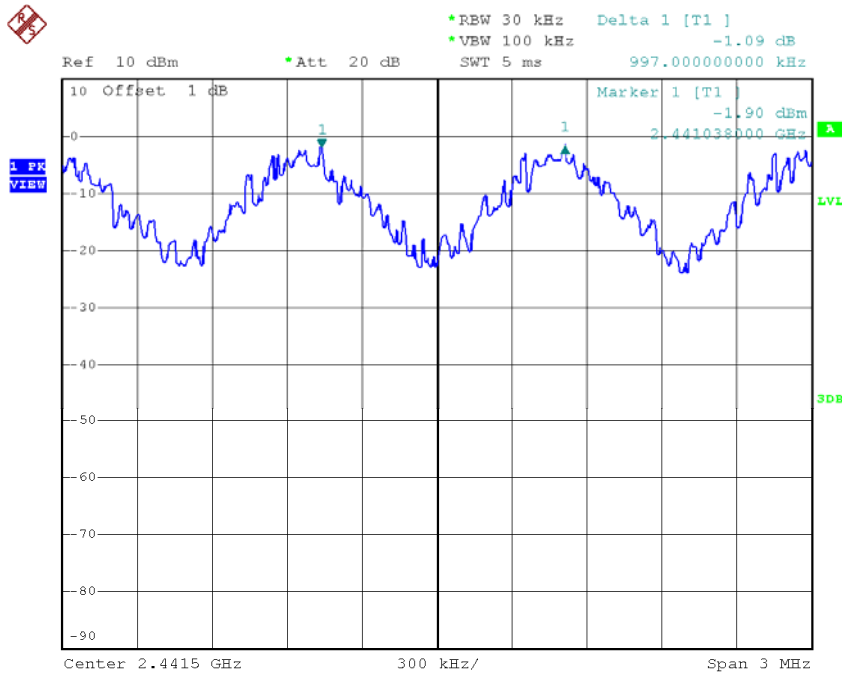

Date: 9.JAN.2016 16:58:40

CH78

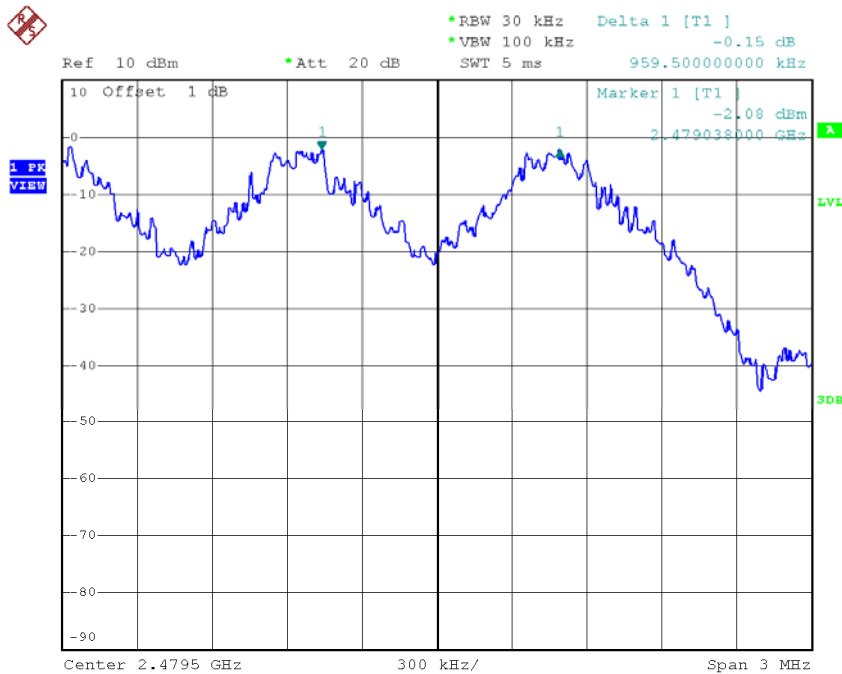

Date: 9.JAN.2016 16:59:48

ATTACHMENT H - BANDWIDTH

Test Mode : TX Mode _1Mbps

Frequency (MHz)	20dB Bandwidth (MHz)	99% Occupied BW (MHz)	Test Result
2402	1.042	0.944	Pass
2441	1.098	0.952	Pass
2480	1.056	0.948	Pass

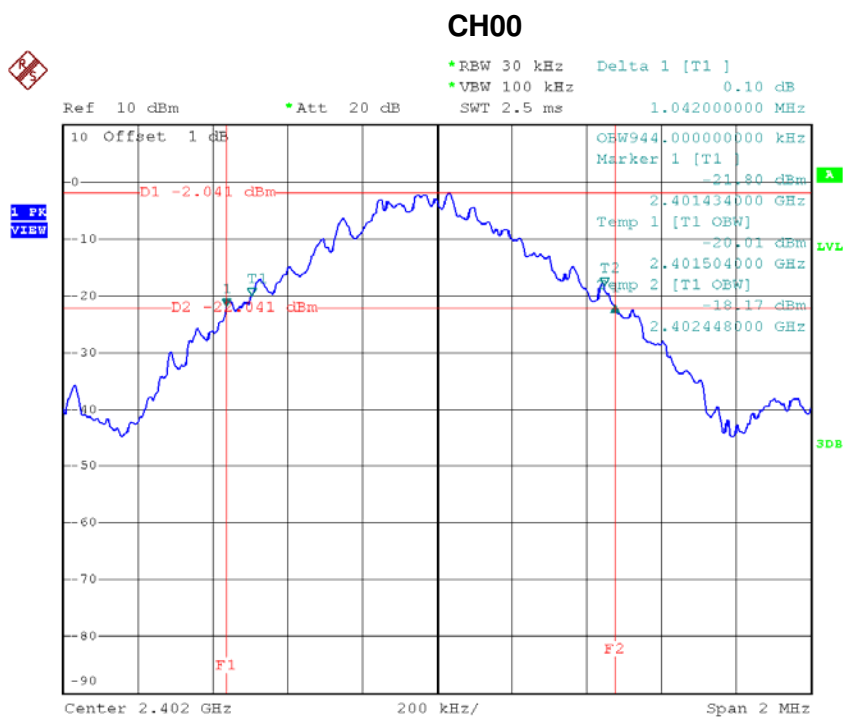

Date: 9.JAN.2016 16:03:53

CH39

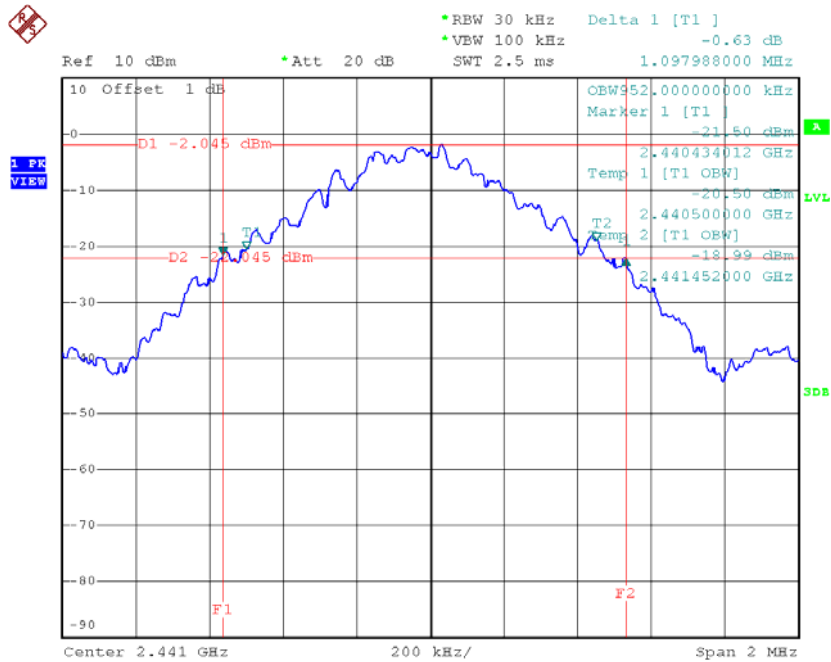

Date: 9.JAN.2016 16:06:01

CH78

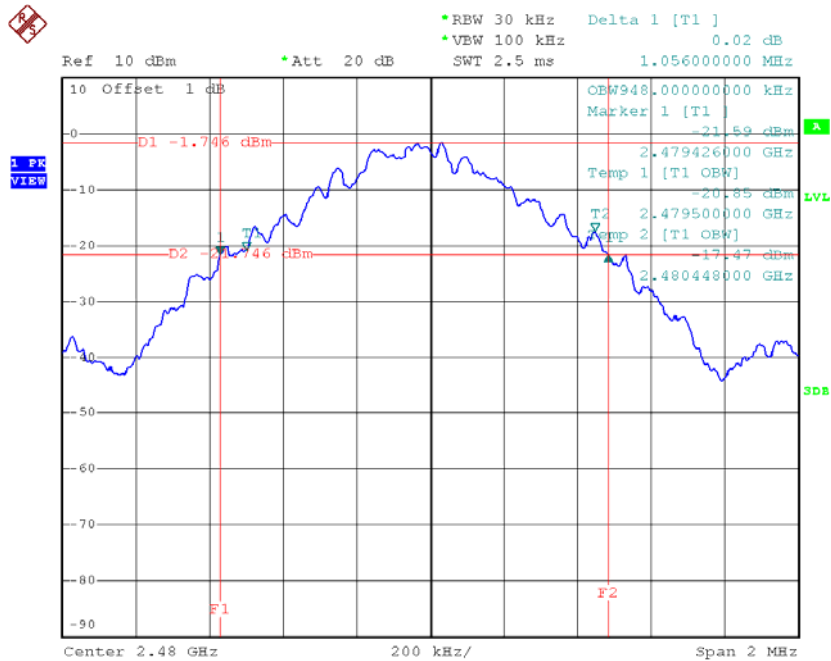

Date: 9.JAN.2016 16:07:21

Test Mode : TX Mode_3Mbps

Frequency (MHz)	20dB Bandwidth (MHz)	99% Occupied BW (MHz)	Test Result
2402	1.382	1.248	Pass
2441	1.382	1.272	Pass
2480	1.385	1.272	Pass

CH00

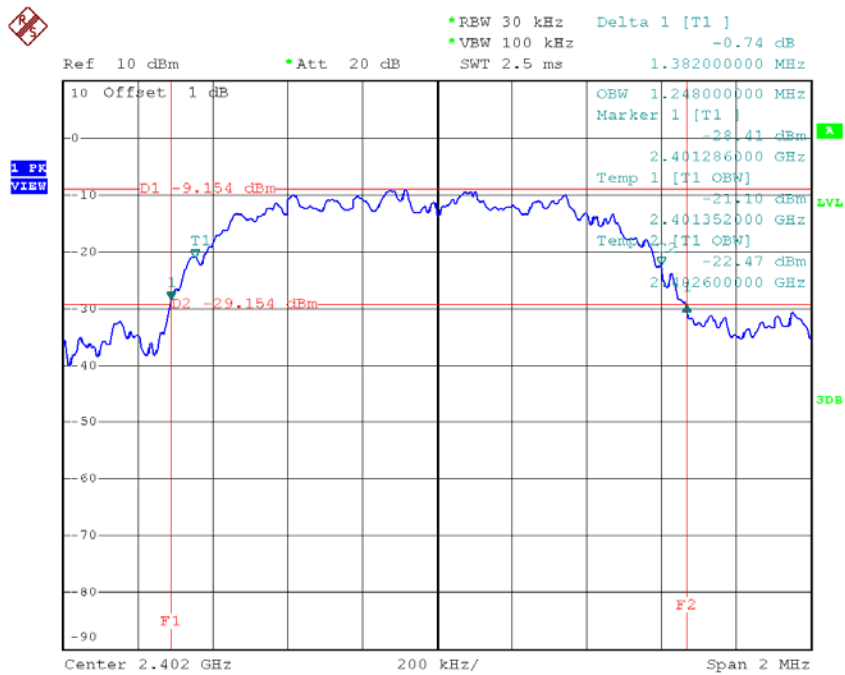

Date: 9.JAN.2016 16:53:18

CH39

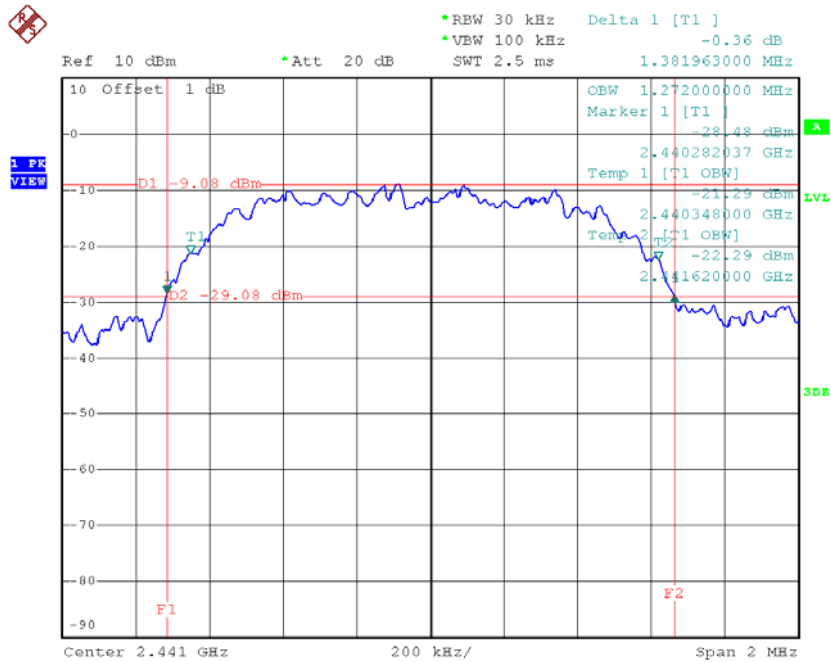

Date: 9.JAN.2016 16:54:22

CH78

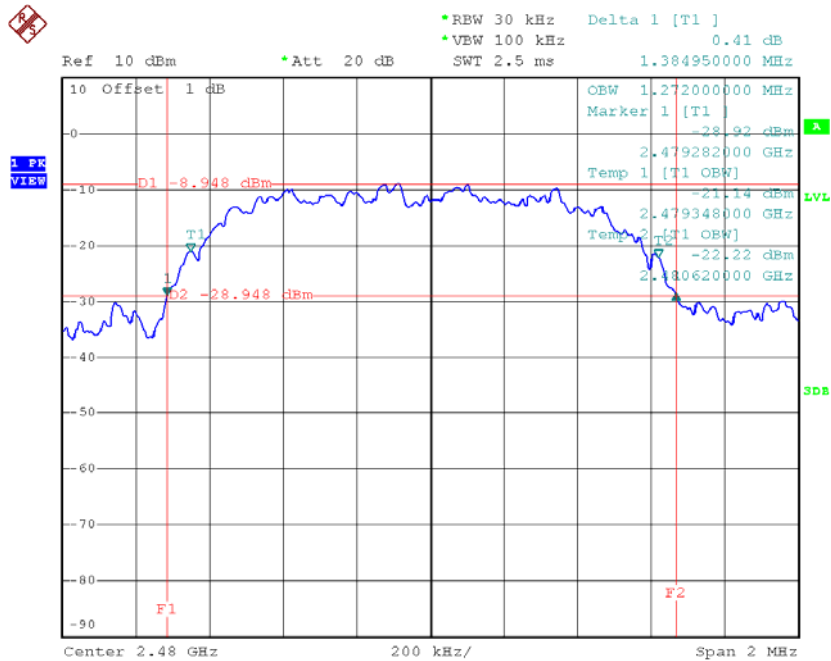

Date: 9.JAN.2016 16:54:59

ATTACHMENT I - PEAK OUTPUT POWER

Test Mode : TX Mode _1Mbps

Frequency (MHz)	Conducted Power (dBm)	Conducted Power (W)	Max. Limit (dBm)	Max. Limit (W)	Test Result
2402	0.92	0.0012	30.00	1.00	Pass
2441	1.01	0.0013	30.00	1.00	Pass
2480	1.29	0.0013	30.00	1.00	Pass

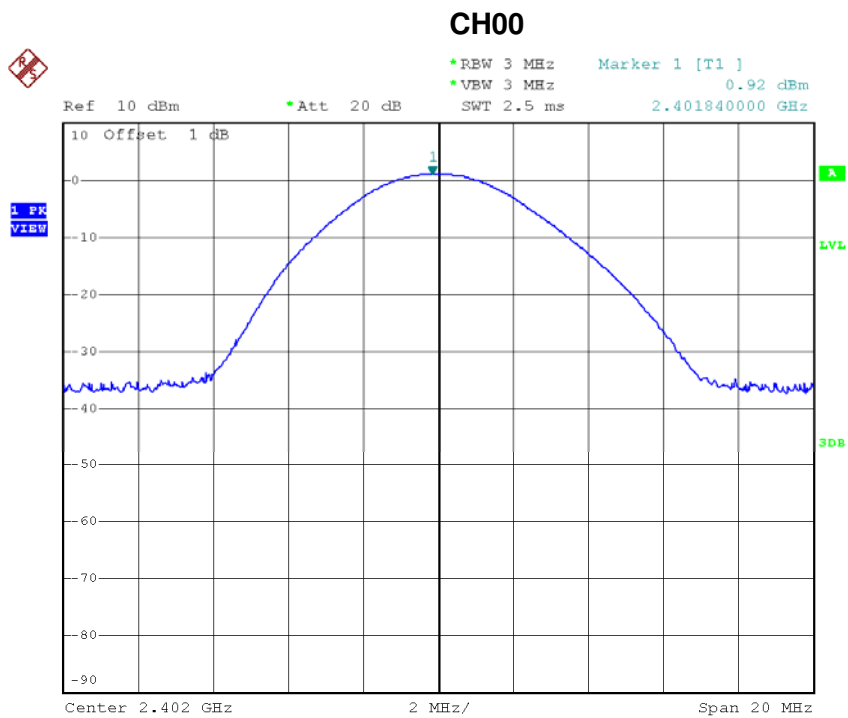

Date: 9.JAN.2016 15:22:04

CH39

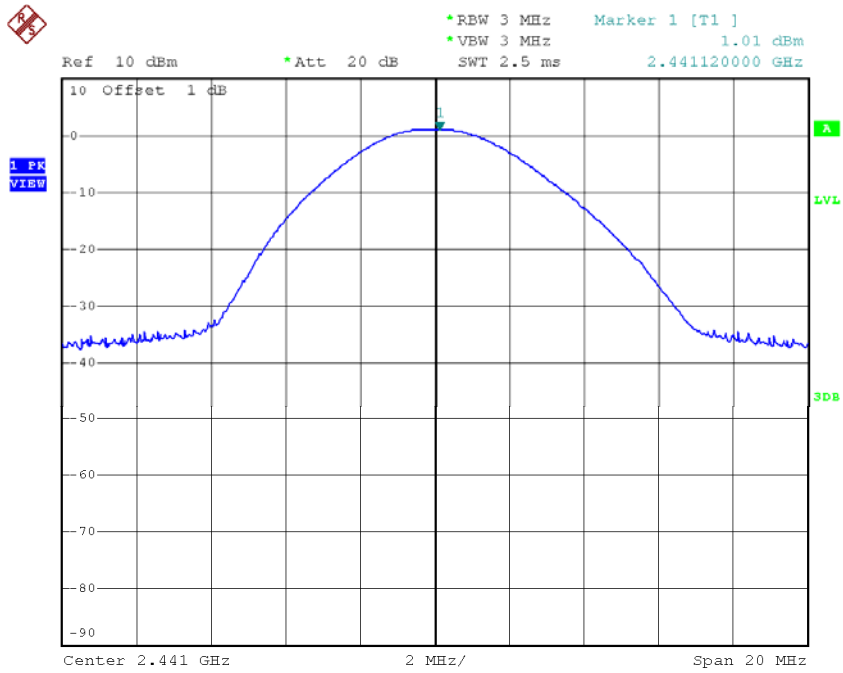

Date: 9.JAN.2016 15:59:59

CH78

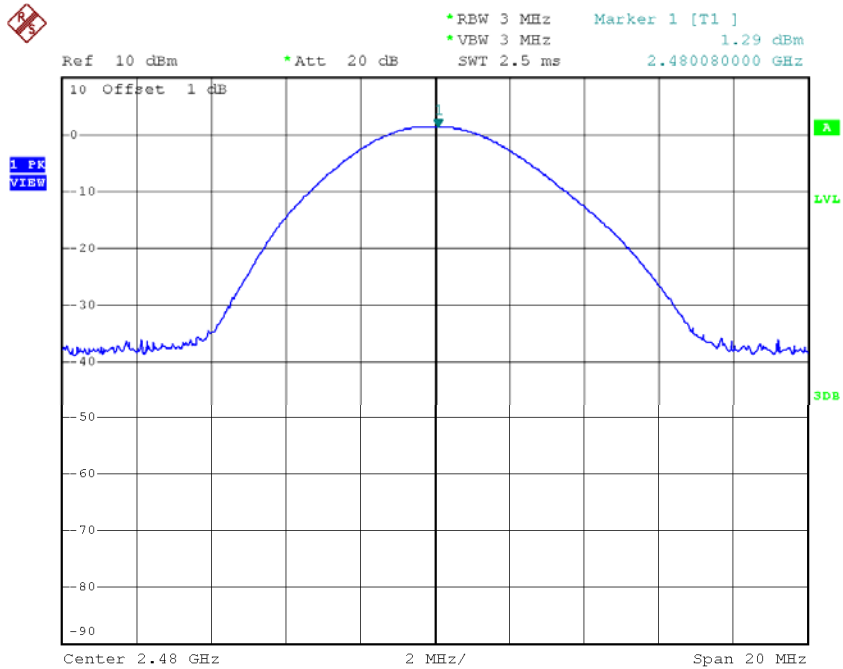

Date: 9.JAN.2016 16:01:16

Test Mode : TX Mode _3Mbps

Frequency (MHz)	Conducted Power (dBm)	Conducted Power (W)	Max. Limit (dBm)	Max. Limit (W)	Test Result
2402	0.01	0.0010	30.00	1.00	Pass
2441	0.00	0.0010	30.00	1.00	Pass
2480	0.22	0.0011	30.00	1.00	Pass

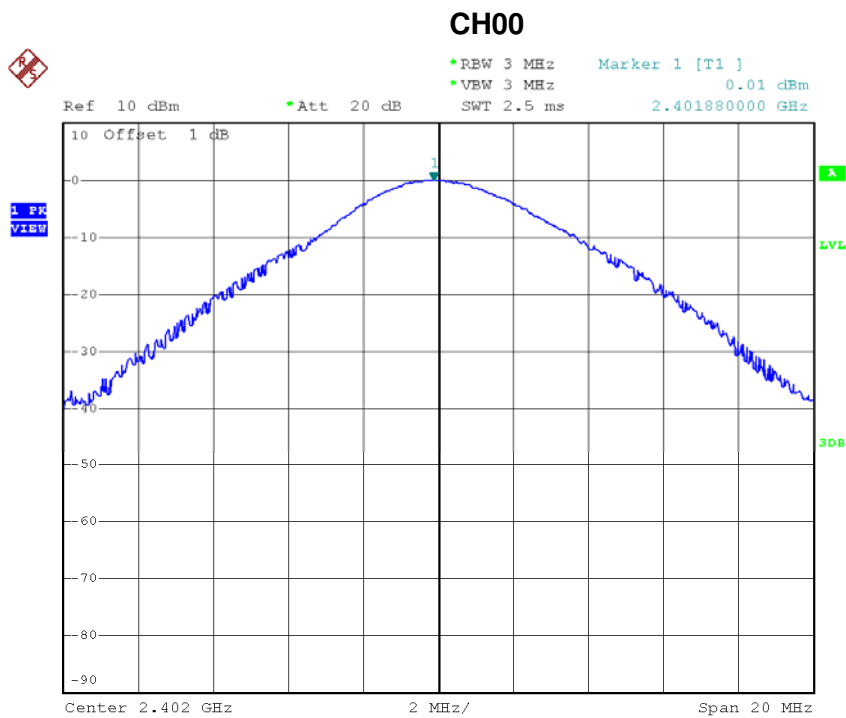

Date: 9.JAN.2016 16:51:23

CH39

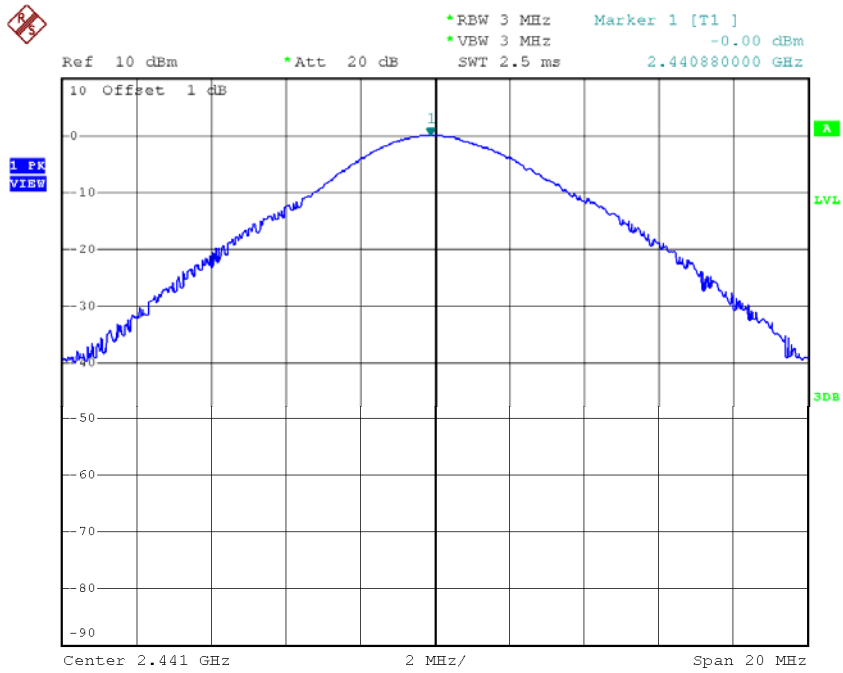

Date: 9.JAN.2016 16:51:43

CH78

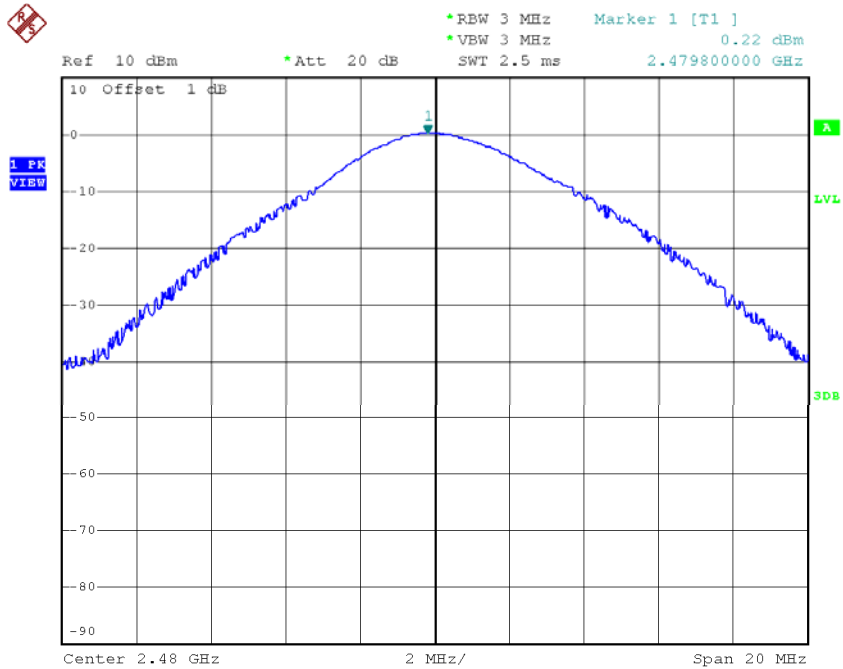

Date: 9.JAN.2016 16:52:05

**ATTACHMENT J - ANTENNA CONDUCTED SPURIOUS
EMISSION**

CH00 (Lower)_1Mbps

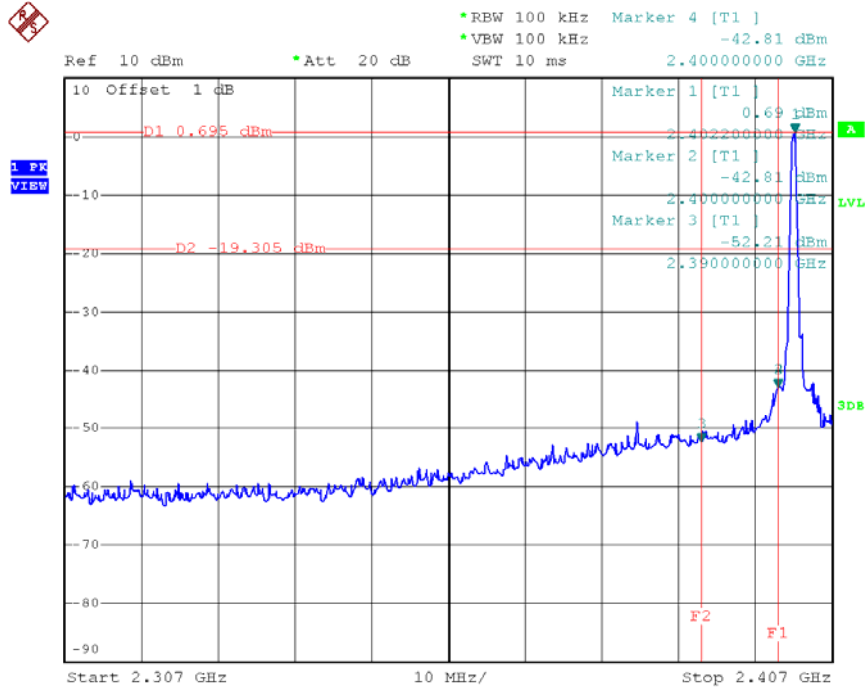

Date: 9.JAN.2016 16:03:28

CH78 (Upper)_1Mbps

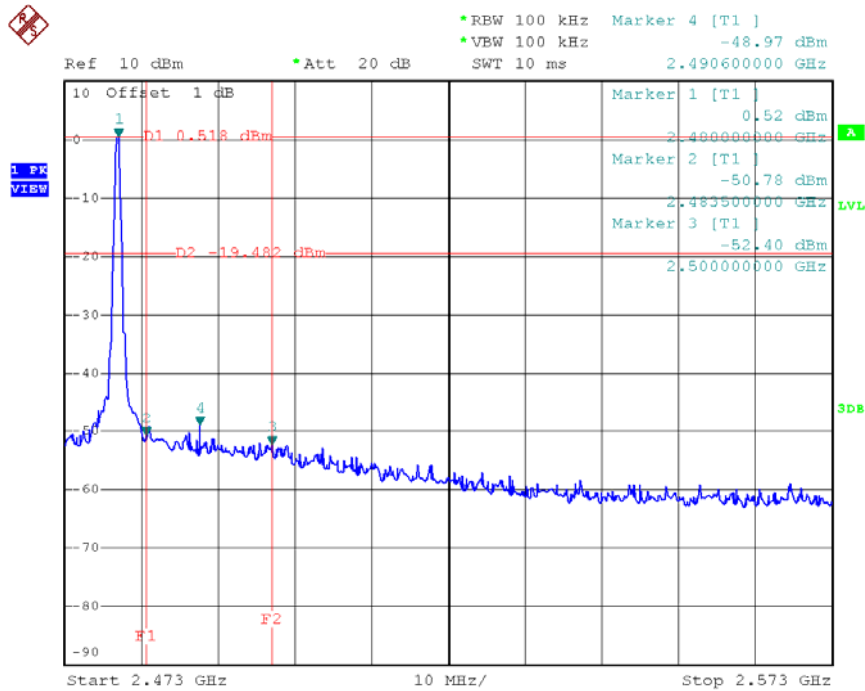

Date: 9.JAN.2016 16:06:59

CH00 Hopping on mode (Lower)_1Mbps

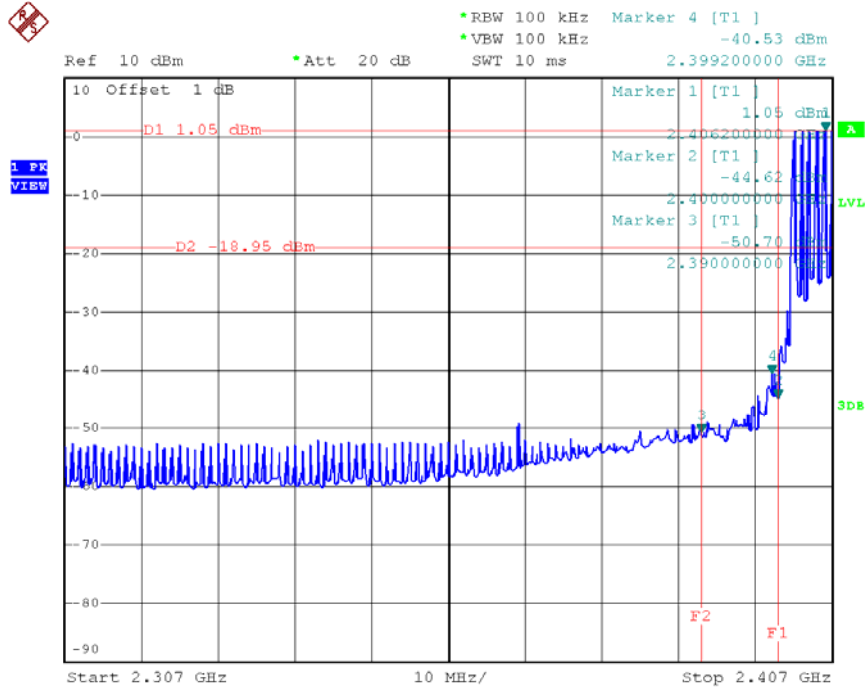

Date: 9.JAN.2016 16:42:24

CH78 Hopping on mode (Upper)_1Mbps

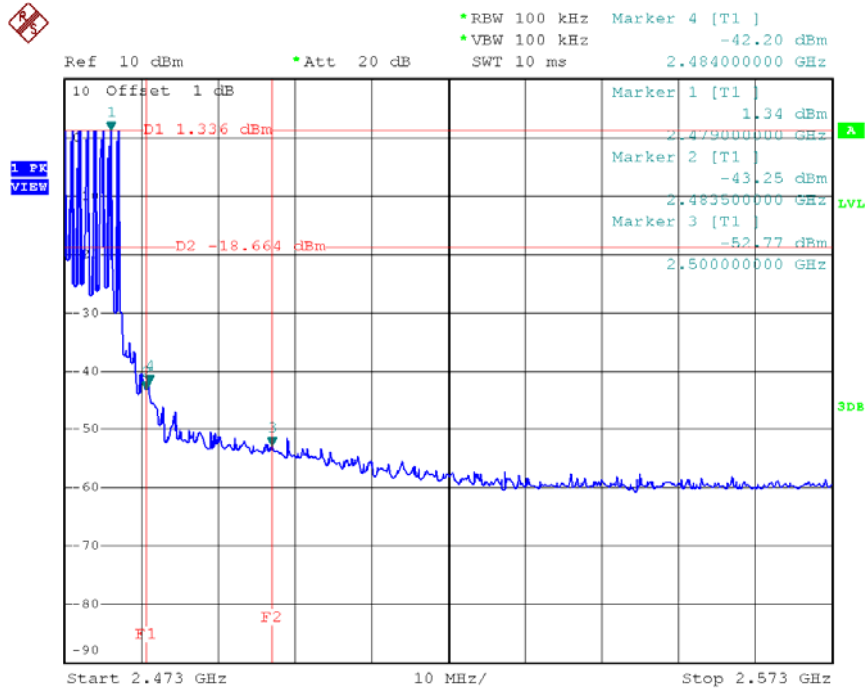

Date: 9.JAN.2016 16:44:39

CH00 (10 Harmonic of the frequency) _1Mbps

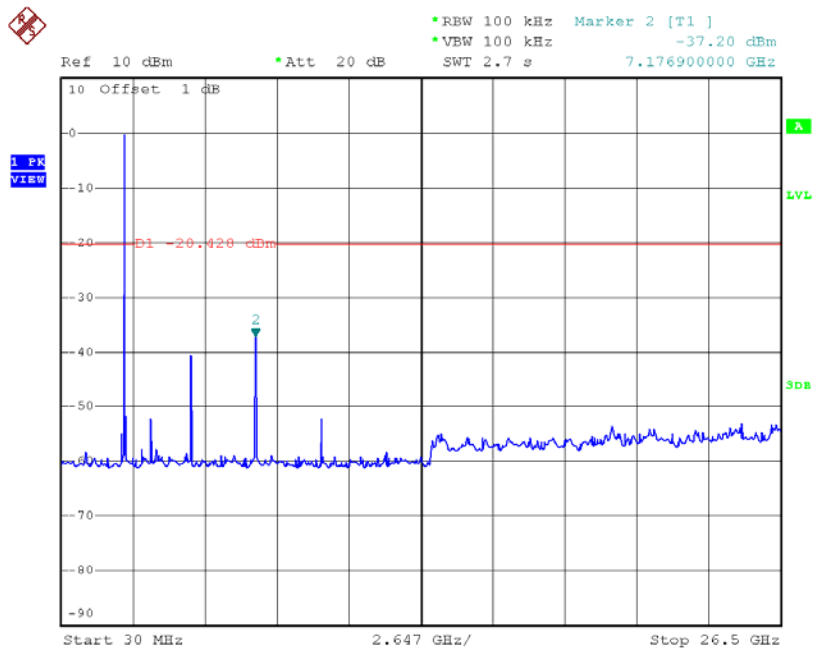

Date: 9.JAN.2016 16:04:07

CH39 (10 Harmonic of the frequency) _1Mbps

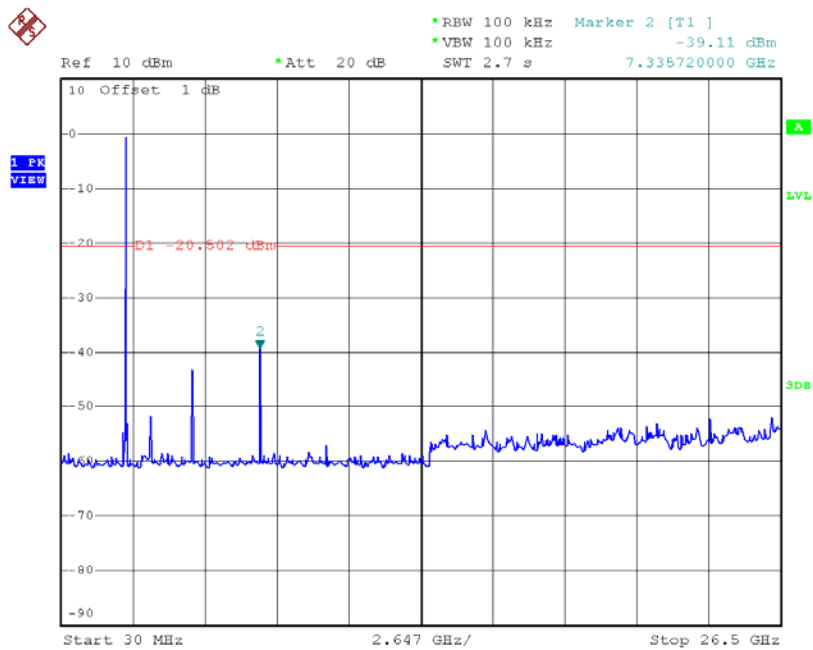

Date: 9.JAN.2016 16:05:36

CH78 (10 Harmonic of the frequency) _1Mbps

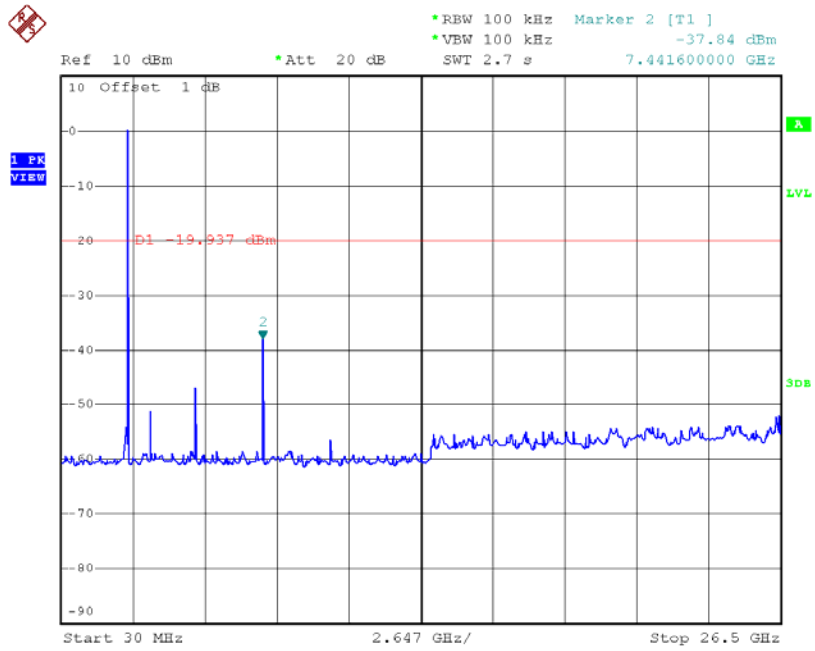

Date: 9.JAN.2016 16:07:35

CH00 (Lower) _3Mbps

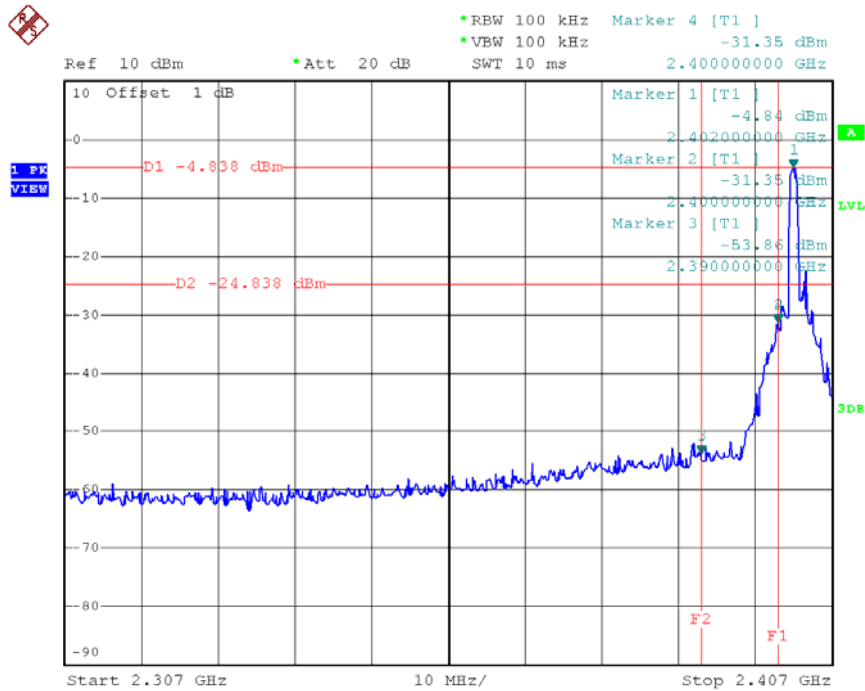

Date: 9.JAN.2016 16:53:00

CH78 (Upper) _3Mbps

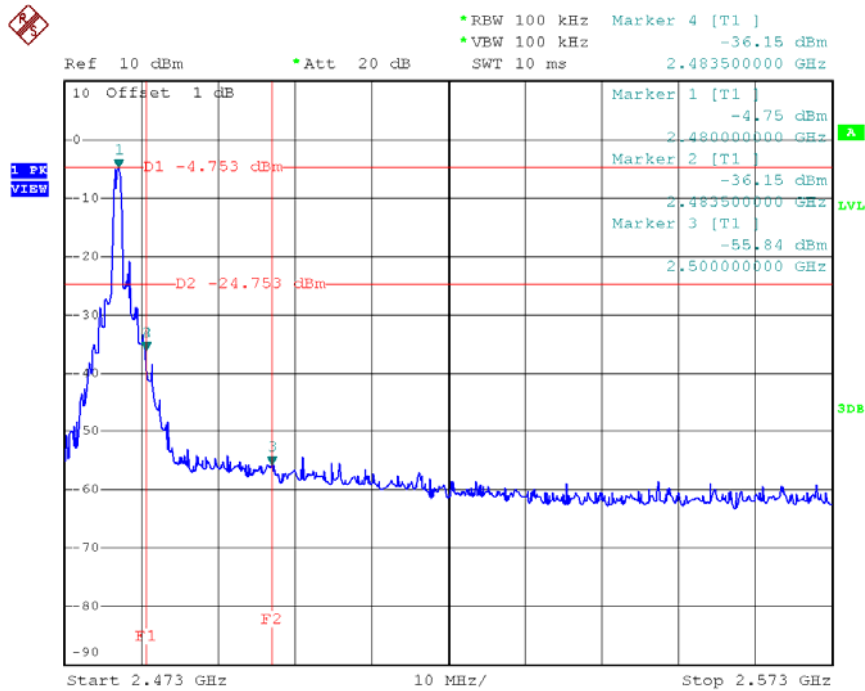

Date: 9.JAN.2016 16:54:41

CH00 Hopping on mode (Lower)_3Mbps

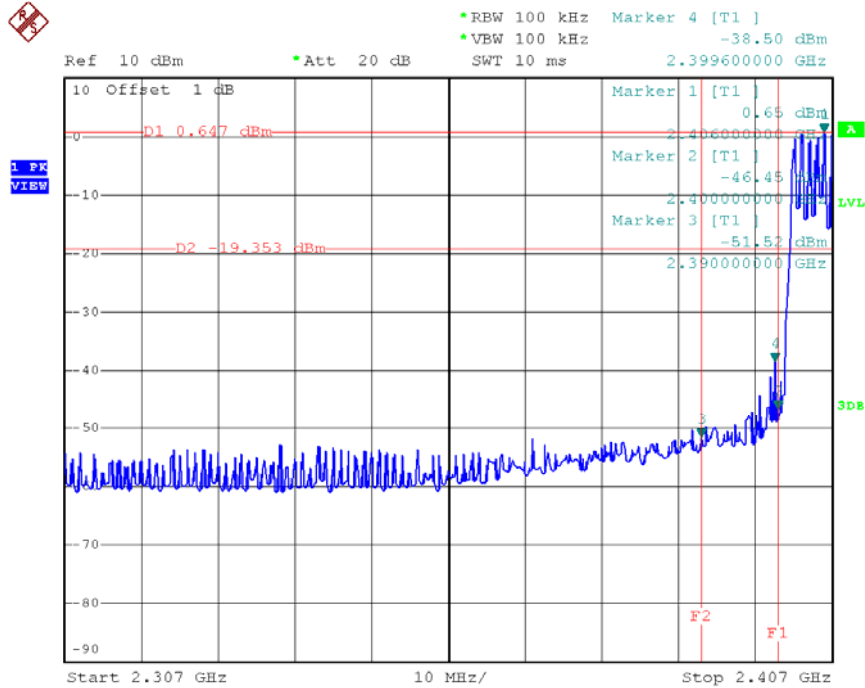

Date: 9.JAN.2016 17:02:12

CH78 Hopping on mode (Upper)_3Mbps

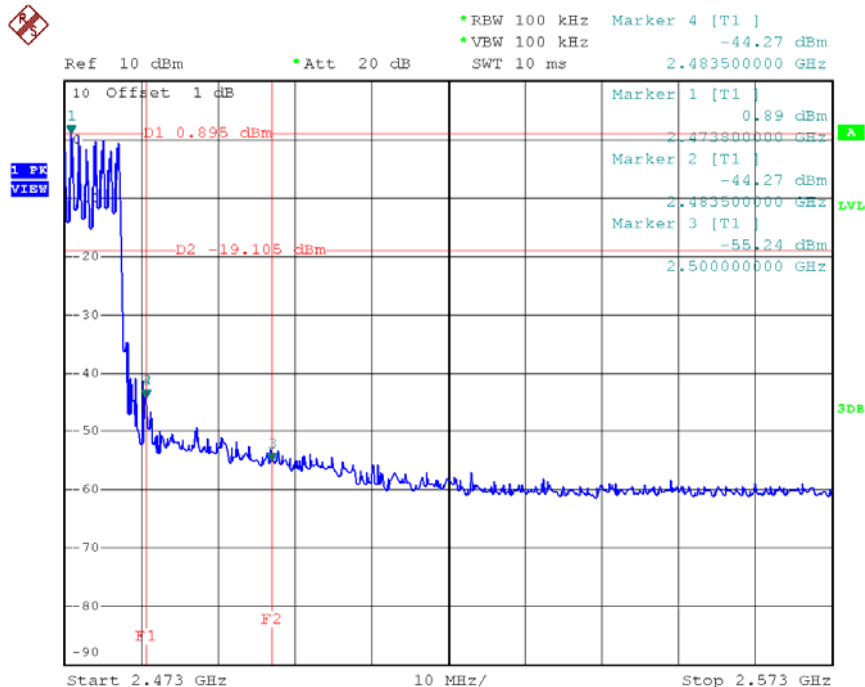

Date: 9.JAN.2016 17:02:46

CH00 (10 Harmonic of the frequency) _3Mbps

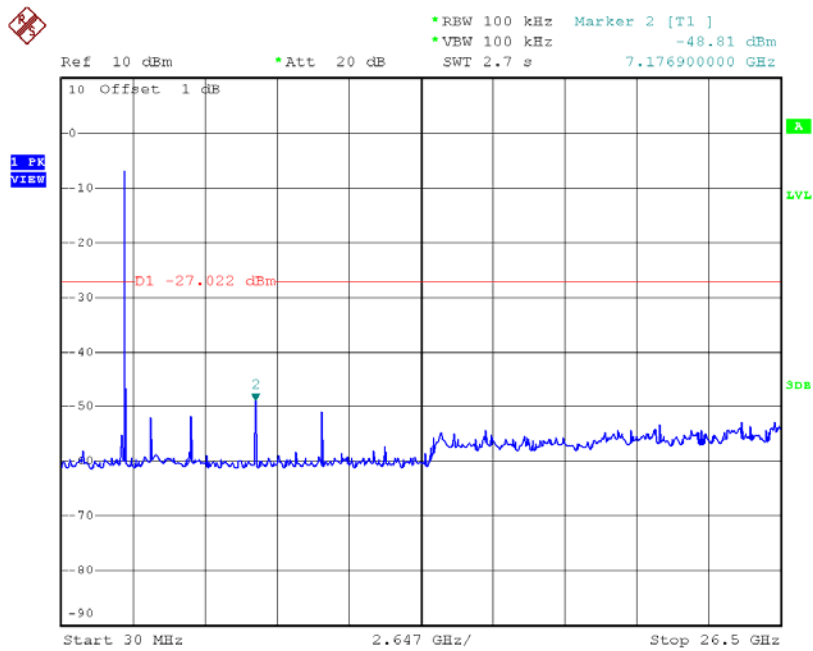

Date: 9.JAN.2016 16:53:32

CH39 (10 Harmonic of the frequency) _3Mbps

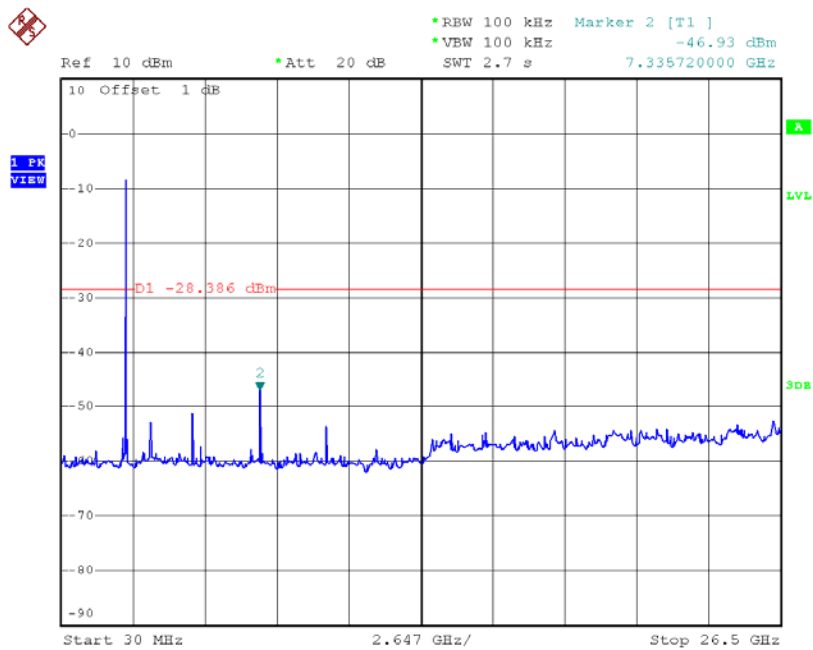

Date: 9.JAN.2016 16:54:03

CH78 (10 Harmonic of the frequency) _3Mbps

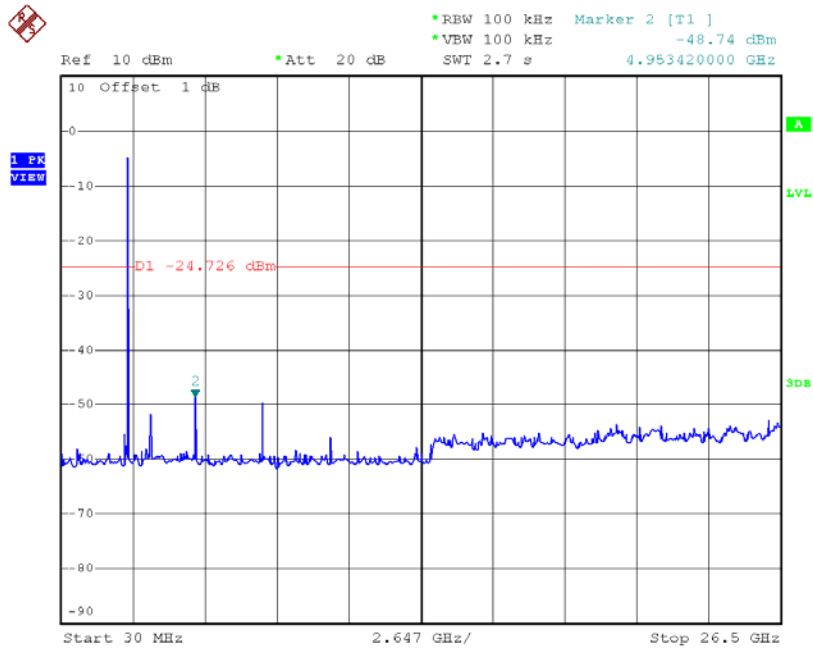

Date: 9.JAN.2016 16:55:13