

TEST REPORT

Report Number: 17051426HKG-001R1

Application for Original Grant of 47 CFR Part 15 Certification

Single New of RSS-247 Issue 2 Equipment

FCC ID: VIXPNMDUALCAM

IC: 21578-PNMDUALCAM

This report supersedes previous report with report number 17051426HKG-001 dated August 24, 2017. Please refer HEE-S17-0040 Letter issued on August 30, 2017 for amendment/ supersede notification.

PREPARED AND CHECKED BY:

APPROVED BY:

Signed On File
Yao Xin Lu, Josie
Engineer

Koo Wai Ip
Technical Supervisor
Date: August 30, 2017

Intertek's standard Terms and Conditions can be obtained at our website <http://www.intertek.com/terms/>.

The test report only allows to be revised within the retention period unless further standard or the requirement was noticed

This report is for the exclusive use of Intertek's Client and is provided pursuant to the agreement between Intertek and its Client. Intertek's responsibility and liability are limited to the terms and conditions of the agreement. Intertek assumes no liability to any party, other than to the Client in accordance with the agreement, for any loss, expense or damage occasioned by the use of this report. Only the Client is authorized to permit copying or distribution of this report and then only in its entirety. Any use of the Intertek name or one of its marks for the sale or advertisement of the tested material, product or service must first be approved in writing by Intertek. The observations and test results in this report are relevant only to the sample tested. This report by itself does not imply that the material, product, or service is or has ever been under an Intertek certification program.

© 2017 Intertek

TEST REPORT

GENERAL INFORMATION

Applicant Name:	Voxx Accessories Corp.
Applicant Address:	3502 Woodview Trace, Suite 220, Indianapolis, IN 46268, USA.
FCC Specification Standard:	FCC Part 15, October 1, 2015 Edition
FCC ID:	VIXPNMDUALCAM
FCC Model(s):	PNMDUALCAM
IC Specification Standard:	RSS-247 Issue 2, February 2017 RSS-Gen Issue 4, November 2014
IC:	21578-PNMDUALCAM
PMN:	PNMDUALCAM
HVIN:	PNMDUALCAM
Type of EUT:	Spread Spectrum Transmitter
Description of EUT:	WiFi Camera
Serial Number:	N/A
Sample Receipt Date:	May 19, 2017
Date of Test:	July 26, 2017 to August 24, 2017
Report Date:	August 30, 2017
Environmental Conditions:	Temperature: +10 to 40°C Humidity: 10 to 90%

TEST REPORT

TABLE OF CONTENTS

1.0 Test Results Summary & Statement of Compliance	4
1.1 Summary of Test Results	4
1.2 Statement of Compliance.....	4
2.0 General Description	5
2.1 Product Description	5
2.2 Test Methodology.....	6
2.3 Test Facility	6
2.4 Related Submittal(s) Grants	6
3.0 System Test Configuration	7
3.1 Justification.....	7
3.2 EUT Exercising Software.....	8
3.3 Details of EUT and Description of Accessories.....	9
3.4 Measurement Uncertainty.....	9
4.0 Test Results	10
4.1 Maximum Conducted Output Power at Antenna Terminals	10
4.2 Minimum 6dB RF Bandwidth	12
4.3 Maximum Power Spectral Density	21
4.4 Out of Band Conducted Emissions	30
4.5 Field Strength Calculation	47
4.6 Transmitter Radiated Emissions in Restricted Bands and Spurious Emissions	48
4.6.1 Radiated Emission Configuration Photograph.....	48
4.6.2 Radiated Emission Data.....	48
4.6.3 Radiated Emission Test Setup	62
4.6.4 Transmitter Duty Cycle Calculation	63
4.7 AC Power Line Conducted Emission	64
4.7.1 AC Power Line Conducted Emission Configuration Photograph	64
4.7.2 AC Power Line Conducted Emission Data.....	64
4.7.3 Conducted Emission Test Setup	67
5.0 Equipment List	68

TEST REPORT

EXHIBIT 1 TEST RESULTS SUMMARY & STATEMENT OF COMPLIANCE

1.0 TEST RESULTS SUMMARY & STATEMENT OF COMPLIANCE

1.1 Summary of Test Results

TEST ITEMS	FCC PART 15 SECTION	RSS-247/ RSS-GEN# SECTION	RESULTS	DETAILS SEE SECTION
Antenna Requirement	15.203	8.3#	Pass	2.1
Max. Conducted Output Power (Peak)	15.247(b)(3)&(4)	5.4(4)	Pass	4.1
Min. 6dB RF Bandwidth	15.247(a)(2)	5.2(1)	Pass	4.2
Max. Power Density (peak)	15.247(e)	5.2(2)	Pass	4.3
Out of Band Antenna Conducted Emission	15.247(d)	5.5	Pass	4.4
Radiated Emission in Restricted Bands and Spurious Emissions	15.247(d), 15.209 & 15.109	5.5	Pass	4.6
AC Power Line Conducted Emission	15.207 & 15.107	8.8#	Pass	4.7

Note: Pursuant to FCC Part 15 Section 15.215(c), the 20dB bandwidth of the emission was contained within the frequency band designated (mentioned as above) which the EUT operated. The effects, if any, from frequency sweeping, frequency hopping, other modulation techniques and frequency stability over expected variations in temperature and supply voltage were considered.

1.2 Statement of Compliance

The equipment under test is found to be complying with the following standard:

FCC Part 15, October 1, 2015 Edition
RSS-247 Issue 2, February 2017
RSS-Gen Issue 4, November 2014

TEST REPORT

EXHIBIT 2 GENERAL DESCRIPTION

2.0 GENERAL DESCRIPTION

2.1 Product Description

The PNMDUALCAM is a WiFi Camera.

The Equipment Under Test (EUT) operates at frequency range of 2412MHz to 2462MHz with 11 channels.

For 802.11b mode, it operates at frequency range of 2412.000MHz to 2462.000MHz with 11 channels. It transmits via Direct-sequence spread spectrum (DSSS) modulation. Maximum bit rate can be up to 11Mbps.

For 802.11g mode, it operates at frequency range of 2412.000MHz to 2462.000MHz with 11 channels. It transmits via Orthogonal Frequency Division Multiplexing (OFDM) modulation. Maximum bit rate can be up to 54Mbps.

For 802.11n (with 20MHz bandwidth) mode, it operates at frequency range of 2412.000MHz to 2462.000MHz with 11 channels. It transmits via Orthogonal Frequency Division Multiplexing (OFDM) modulation. Maximum bit rate can support up to 65Mbps.

For 802.11n (with 40MHz bandwidth) mode, it operates at frequency range of 2422.000MHz to 2452.000MHz with 7 channels. It transmits via Orthogonal Frequency Division Multiplexing (OFDM) modulation. Maximum bit rate can support up to 65Mbps.

The EUT is power by a 100-240VAC, 50/60Hz, 400mA to 5VDC 2000mA.

The antenna(s) used in the EUT is integral.

The circuit description is saved with filename: descri.pdf.

TEST REPORT

2.2 Test Methodology

Both AC power line-conducted and radiated emission measurements were performed according to the procedures in ANSI C63.10 (2013). Preliminary radiated scans and all radiated measurements were performed in radiated emission test sites. All Radiated tests were performed at an antenna to EUT distance of 3 meters, unless stated otherwise in the "**Justification Section**" of this Application. Antenna port conducted measurements were performed according to ANSI C63.10 (2013) and KDB Publication No.558074 D01 v04 (05-April-2017) All other measurements were made in accordance with the procedures in 47 CFR Part 2 and RSS-Gen Issue 4 (2014).

2.3 Test Facility

The radiated emission test site and antenna port conducted measurement facility used to collect the radiated data and conductive data are at Workshop No. 3, G/F., World-Wide Industrial Centre, 43-47 Shan Mei Street, Fo Tan, Sha Tin, N.T., Hong Kong. This test facility and site measurement data have been fully placed on file with the FCC and Industry Canada No.: 2042V-1.

2.4 Related Submittal(s) Grants

This is a single application for certification of a transceiver.

TEST REPORT

EXHIBIT 3 SYSTEM TEST CONFIGURATION

3.0 SYSTEM TEST CONFIGURATION

3.1 Justification

For radiated emissions testing, the equipment under test (EUT) was setup to transmit / receive continuously to simplify the measurement methodology. Care was taken to ensure proper power supply voltages during testing. During testing, all cables (if any) were manipulated to produce worst case emissions.

The EUT is power by a 100-240VAC, 50/60Hz, 400mA to 5VDC 2000mA.

For the measurements, the EUT was attached to a plastic stand if necessary and placed on the wooden turntable. If the base unit attached to peripherals, they were connected and operational (as typical as possible).

The signal was maximized through rotation and placement in the three orthogonal axes. The antenna height and polarization were varied during the search for maximum signal level. The antenna height was varied from 1 to 4 meters. Radiated emissions were taken at three meters unless the signal level was too low for measurement at that distance. If necessary, a pre-amplifier was used and/or the test was conducted at a closer distance.

For any intentional radiator powered by AC power line, measurements of the radiated signal level of the fundamental frequency component of the emission was performed with the supply voltage varied between 85% and 115% of the nominal rated supply voltage.

Radiated emission measurement for transmitter were performed from the lowest radio frequency signal generated in the device which is greater than 9 kHz to the tenth harmonic of the highest fundamental frequency or to 40 GHz, whichever is lower.

Emission that are directly caused by digital circuits in the transmit path and transmitter portion were measured, and the limit are according to FCC Part 15 Section 15.209. Digital circuitries used to control additional functions other than the operation of the transmitter are subject to FCC Part 15 Section 15.109 Limits.

TEST REPORT

3.1 Justification – Cont'd

Detector function for radiated emissions was in peak mode. Average readings, when required, were taken by measuring the duty cycle of the equipment under test and subtracting the corresponding amount in dB from the measured peak readings. A detailed description for the calculation of the average factor can be found in section 4.8.3.

Determination of pulse desensitization was made according to *Hewlett Packard Application Note 150-2, Spectrum Analysis... Pulsed RF*. The effective period (Teff) was referred to Exhibit 4.8.3. With the resolution bandwidth 1MHz and spectrum analyzer IF bandwidth 3dB, the pulse desensitization factor was 0dB.

For AC line conducted emission test, the EUT along with its peripherals were placed on a 1.0m(W)x1.5m(L) and 0.8m in height wooden table and the EUT was adjusted to maintain a 0.4 meter space from a vertical reference plane. The EUT was connected to power mains through a line impedance stabilization network (LISN), which provided 50ohm coupling impedance for measuring instrument. The LISN housing, measuring instrument case, reference ground plane, and vertical ground plane were bounded together. The excess power cable between the EUT and the LISN was bundled.

All connecting cables of EUT and peripherals were manipulated to find the maximum emission.

Different data rates have been tested. Worst case is reported only.

All relevant operation modes have been tested, and the worst case data is included in this report.

All data rates were tested under normal mode of WiFi. Only the worst-case data is shown in the report for DSSS and OFDM

3.2 EUT Exercising Software

The EUT exercise program (if any) used during radiated and conducted testing was designed to exercise the various system components in a manner similar to a typical use.

TEST REPORT

3.3 Details of EUT and Description of Accessories

Details of EUT:

An AC adaptor (provided with the unit) was used to power the device. Their description are listed below.

- (1) An AC adaptor (100-240V 50/60Hz 400mA to 5.0VDC 2000mA, Model: S010WU0500200) (Provided by Client)

Description of Accessories:

- (1) Monitor Unit, Model: PNMDUAL5M, FCC ID: VIXPNMDUAL5M, IC: 21578-PNMDUAL5M (Provided by Client)
- (2) Charging Cable with ferrite in length of 10 feet (Provided by Client)
- (3) 8GB Micro SD Card, Brand: Kingston, Model: SDC4 (Provided by Client)

3.4 Measurement Uncertainty

When determining of the test conclusion, the Measurement Uncertainty of test at a level of confidence of 95% has been considered. The values of the Measurement uncertainty for radiated emission test and RF conducted measurement test are $\pm 5.3\text{dB}$ and $\pm 0.99\text{dB}$ respectively. The value of the Measurement uncertainty for conducted emission test is $\pm 4.2\text{dB}$.

Uncertainty and Compliance - Unless the standard specifically states that measured values are to be extended by the measurement uncertainty in determining compliance, all compliance determinations are based on the actual measured value.

TEST REPORT

EXHIBIT 4 TEST RESULTS

4.0 TEST RESULTS

4.1 Maximum Conducted (peak) Output Power at Antenna Terminals

RF Conduct Measurement Test Setup

The figure below shows the test setup, which is utilized to make these measurements.

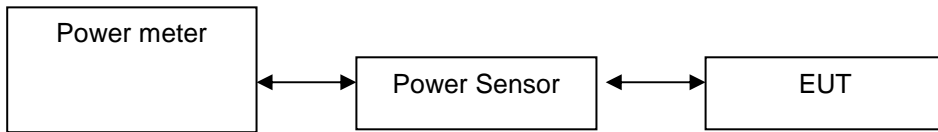

The antenna port of the EUT was connected to the input of a spectrum analyzer.

- The antenna power of the EUT was connected to the input of a power meter. Power was read directly and cable loss correction was added to the reading to the obtain power at the EUT antenna terminals. The measurement procedure 9.1.3 was used.
- The EUT should be configured to transmit continuously (at a minimum duty cycle of 98%) at full power over the measurement duration. The measurement procedure AVG1 was used.

IEEE 802.11b (DSSS, 1 Mbps) Antenna Gain = 1 dBi

Frequency (MHz)	Output in dBm	Output in mWatt
Low Channel: 2412	15.77	37.76
Middle Channel: 2437	16.04	40.18
High Channel: 2462	17.17	52.12

IEEE 802.11g (OFDM, 6 Mbps) Antenna Gain = 1 dBi

Frequency (MHz)	Output in dBm	Output in mWatt
Low Channel: 2412	19.43	87.70
Middle Channel: 2437	19.35	86.10
High Channel: 2462	19.62	91.62

IEEE 802.11n (20MHz) (OFDM, MCS0) Antenna Gain = 1 dBi

Frequency (MHz)	Output in dBm	Output in mWatt
Low Channel: 2412	20.23	105.44
Middle Channel: 2437	19.57	90.57
High Channel: 2462	21.33	135.83

TEST REPORT

4.1 Maximum Conducted Output Power at Antenna Terminals – Cont’d

IEEE 802.11n (40MHz) (OFDM, MCS0) Antenna Gain = 1 dBi

Frequency (MHz)	Output in dBm	Output in mWatt
Low Channel: 2422	20.44	110.66
Middle Channel: 2437	19.91	97.95
High Channel: 2452	20.14	103.28

Cable loss : 0.7 dB External Attenuation : 0 dB

Cable loss, external attenuation: included in OFFSET function
 added to SA raw reading

IEEE 802.11b (DSSS, 1 Mbps)
max. conducted (peak) output level = 17.17 dBm

IEEE 802.11g (OFDM, 9 Mbps)
max. conducted (peak) output level = 19.62 dBm

IEEE 802.11n (20MHz) (OFDM, MCS0)
max. conducted (peak) output level = 21.33 dBm

IEEE 802.11n (40MHz) (OFDM, MCS0)
max. conducted (peak) output level = 20.44 dBm

Limits:

1W (30dBm) for antennas with gains of 6dBi or less

___W (___dBm) for antennas with gains more than 6dBi

TEST REPORT

4.2 Minimum 6dB RF Bandwidth

The antenna port of the EUT was connected to the input of a spectrum analyzer. The EBW measurement procedure was used. A PEAK output reading was taken, a DISPLAY line was drawn 6dB lower than PEAK level. The 6dB bandwidth was determined from where the channel output spectrum intersected the display line.

IEEE 802.11b (DSSS, 1 Mbps)

Frequency (MHz)	6dB Bandwidth (MHz)
Low Channel: 2412	10.3
Middle Channel: 2437	10.2
High Channel: 2462	10.2

IEEE 802.11g (OFDM, 6 Mbps)

Frequency (MHz)	6dB Bandwidth (MHz)
Low Channel: 2412	16.6
Middle Channel: 2437	16.6
High Channel: 2462	16.6

IEEE 802.11n (20MHz) (OFDM, MCS0)

Frequency (MHz)	6dB Bandwidth (MHz)
Low Channel: 2412	17.8
Middle Channel: 2437	17.8
High Channel: 2462	17.8

IEEE 802.11n (40MHz) (OFDM, MCS0)

Frequency (MHz)	6dB Bandwidth (MHz)
Low Channel: 2422	35.8
Middle Channel: 2437	36.0
High Channel: 2452	35.8

Limits

6 dB bandwidth shall be at least 500kHz

The plots of 6dB RF bandwidth are saved as below.

TEST REPORT

PLOTS OF 6dB RF BANDWIDTH

802.11b, Lowest Channel

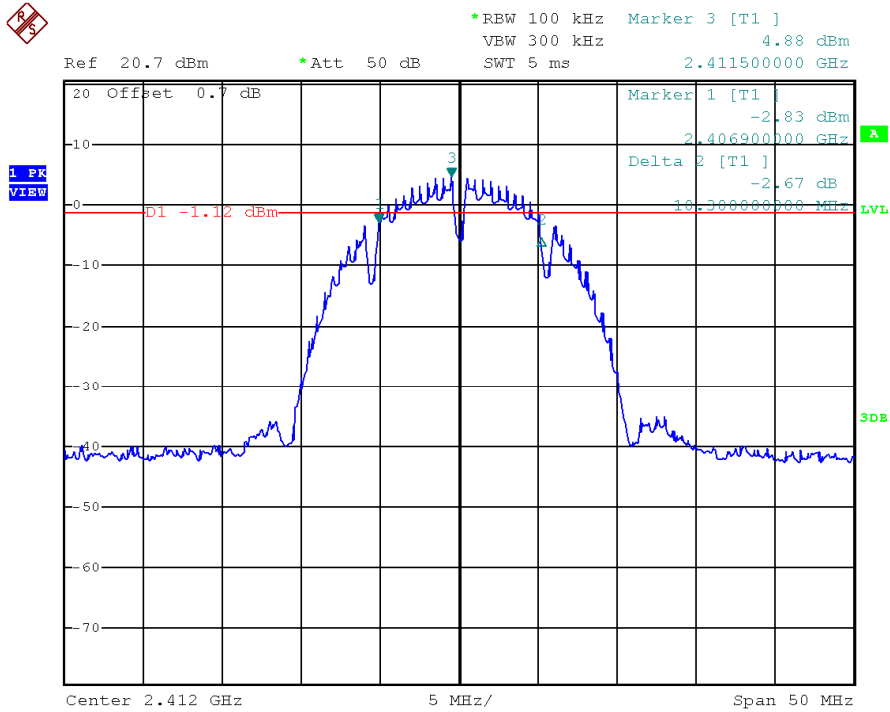

802.11b, Middle Channel

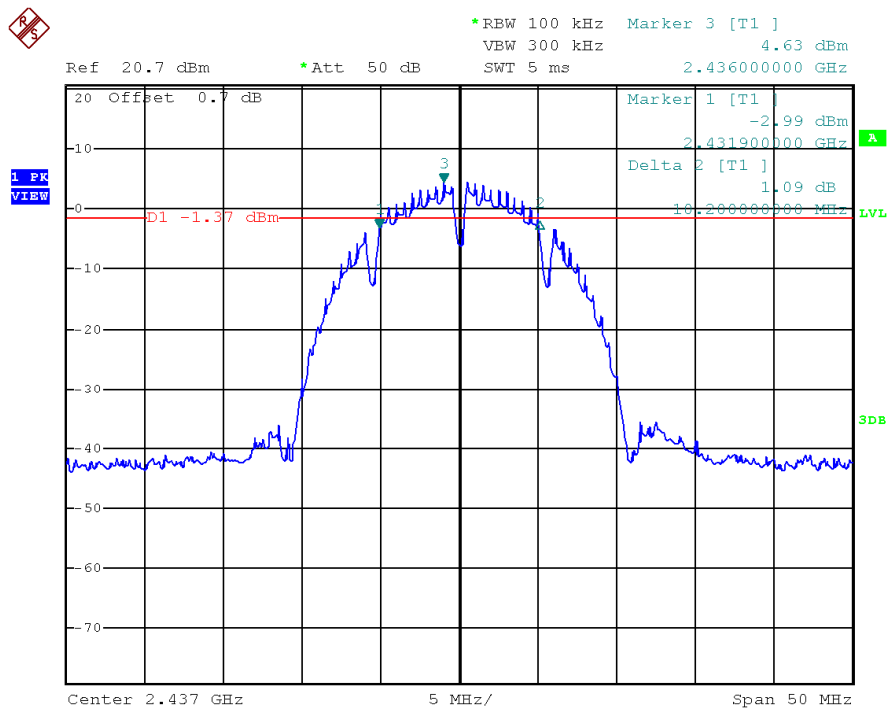

TEST REPORT

PLOTS OF 6dB RF BANDWIDTH

802.11b, Highest Channel

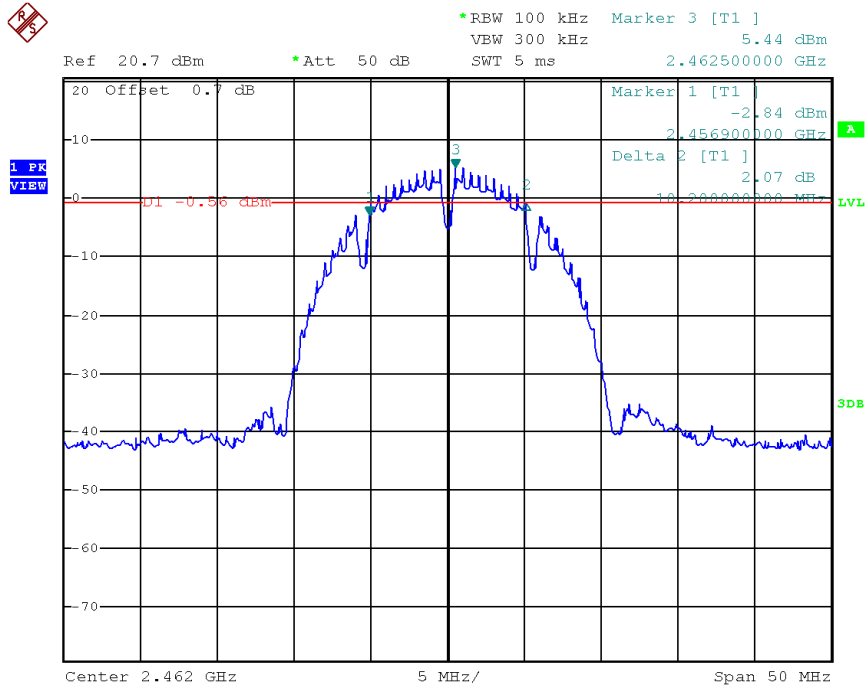

TEST REPORT

PLOTS OF 6dB RF BANDWIDTH

802.11g, Lowest Channel

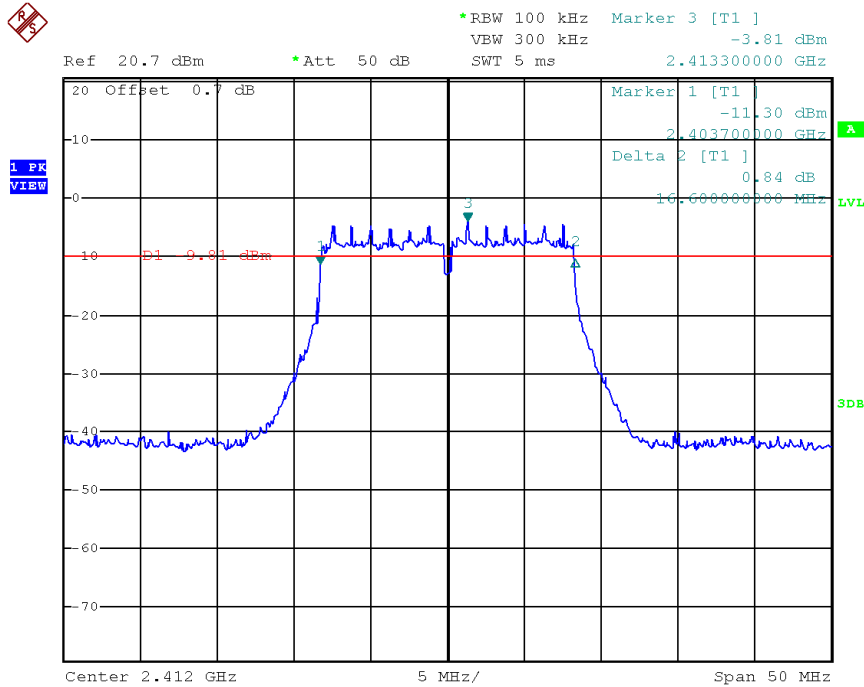

802.11g, Middle Channel

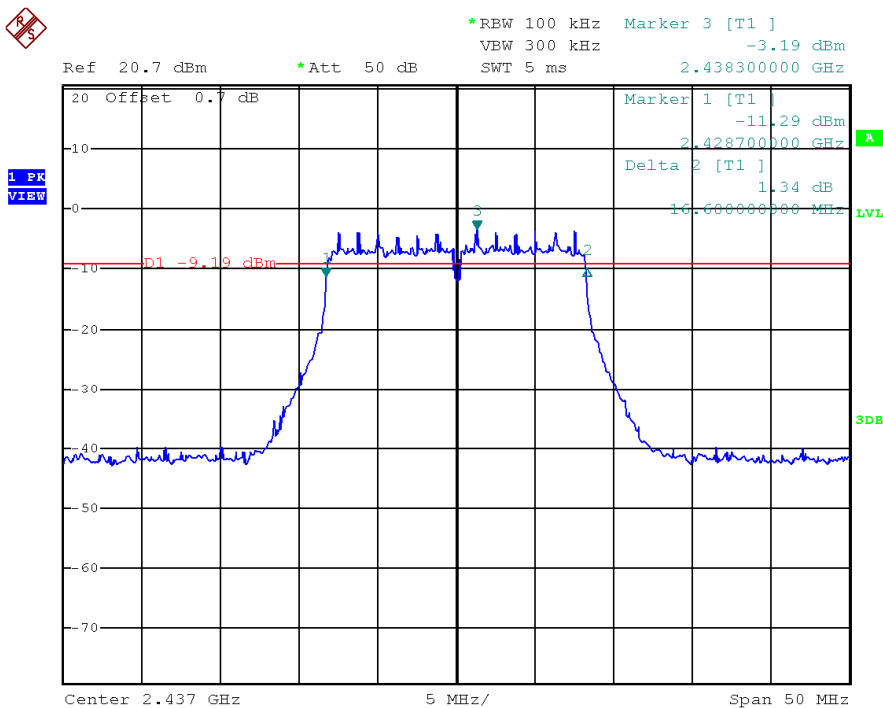

TEST REPORT

PLOTS OF 6dB RF BANDWIDTH

802.11g, Highest Channel

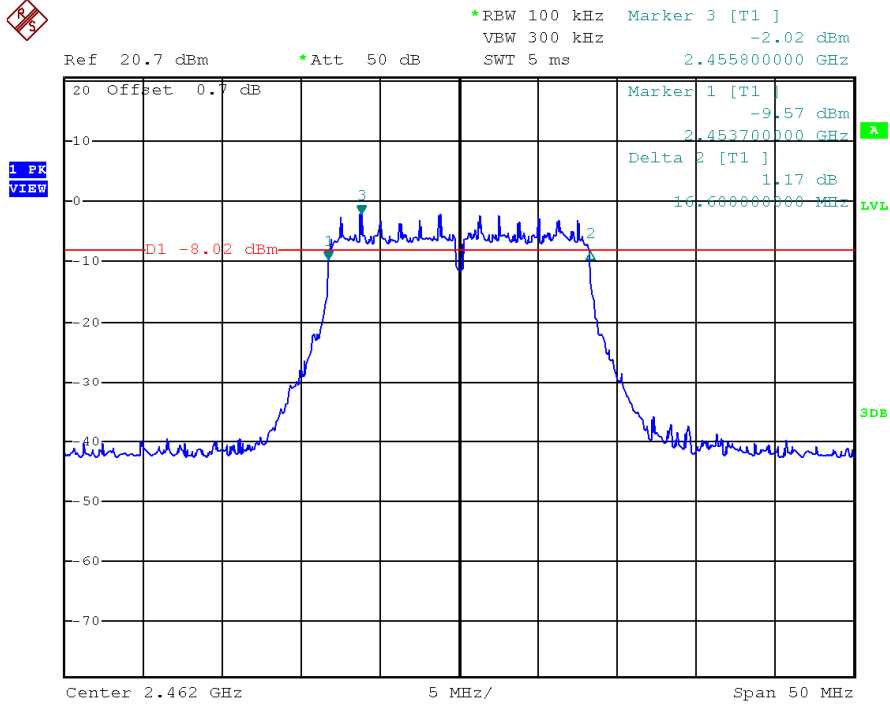

TEST REPORT

PLOTS OF 6dB RF BANDWIDTH

802.11n (20MHz), Lowest Channel

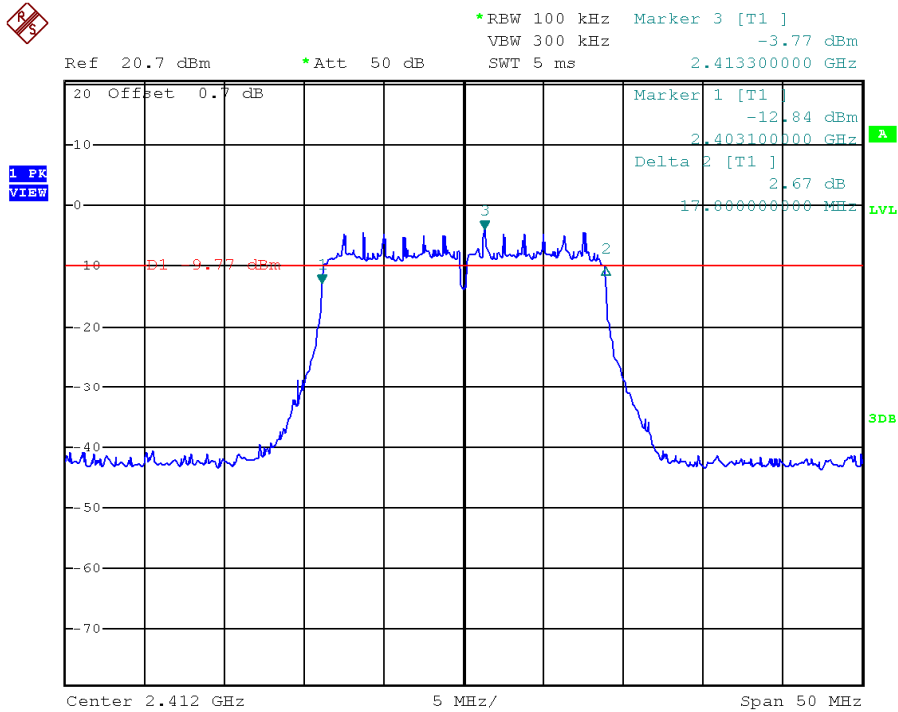

802.11n (20MHz), Middle Channel

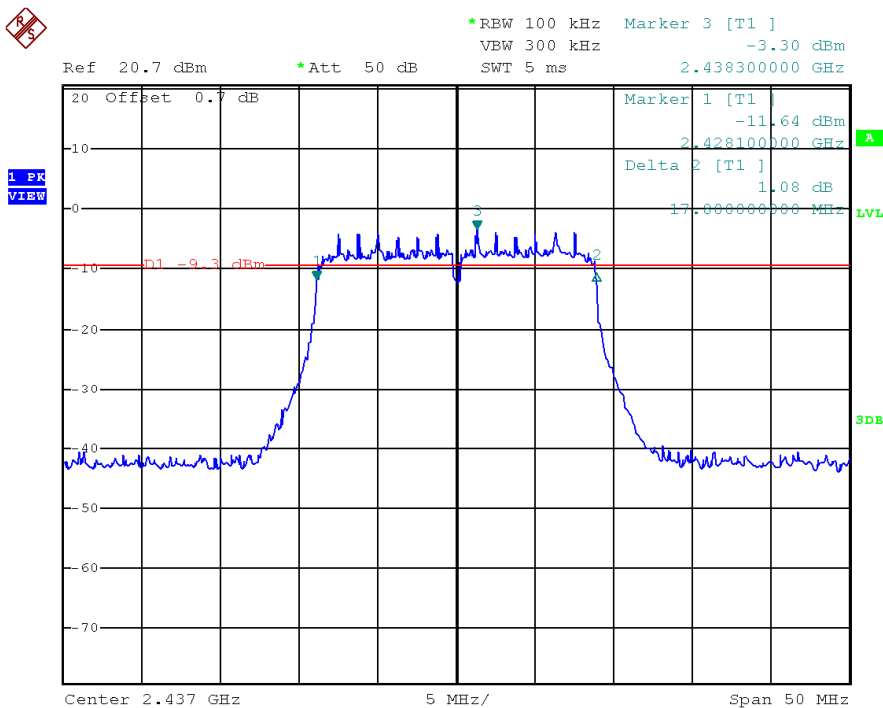

TEST REPORT

PLOTS OF 6dB RF BANDWIDTH

802.11n (20MHz), Highest Channel

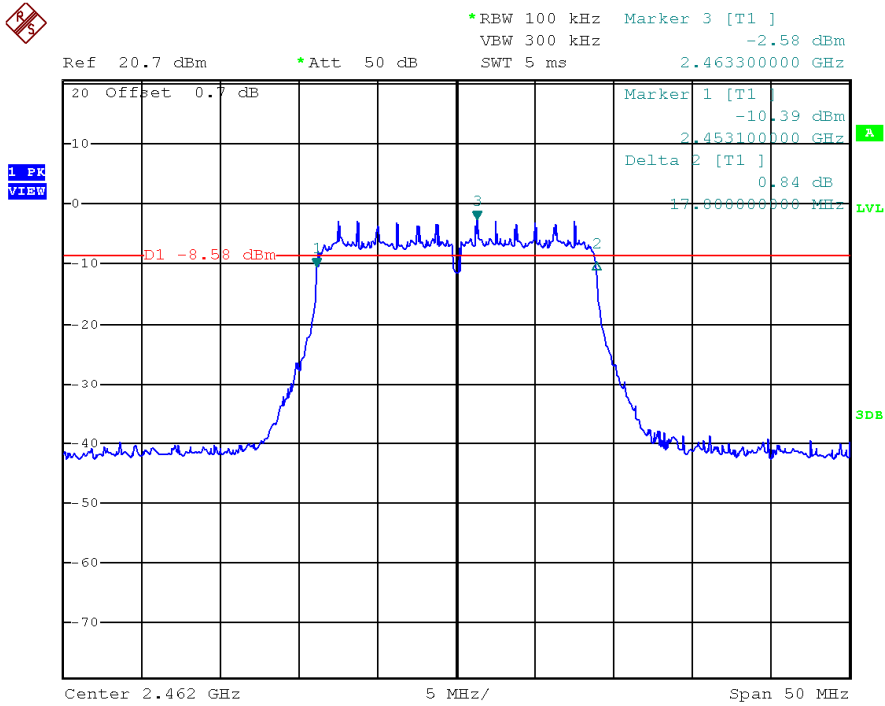

TEST REPORT

PLOTS OF 6dB RF BANDWIDTH

802.11n (40MHz), Lowest Channel

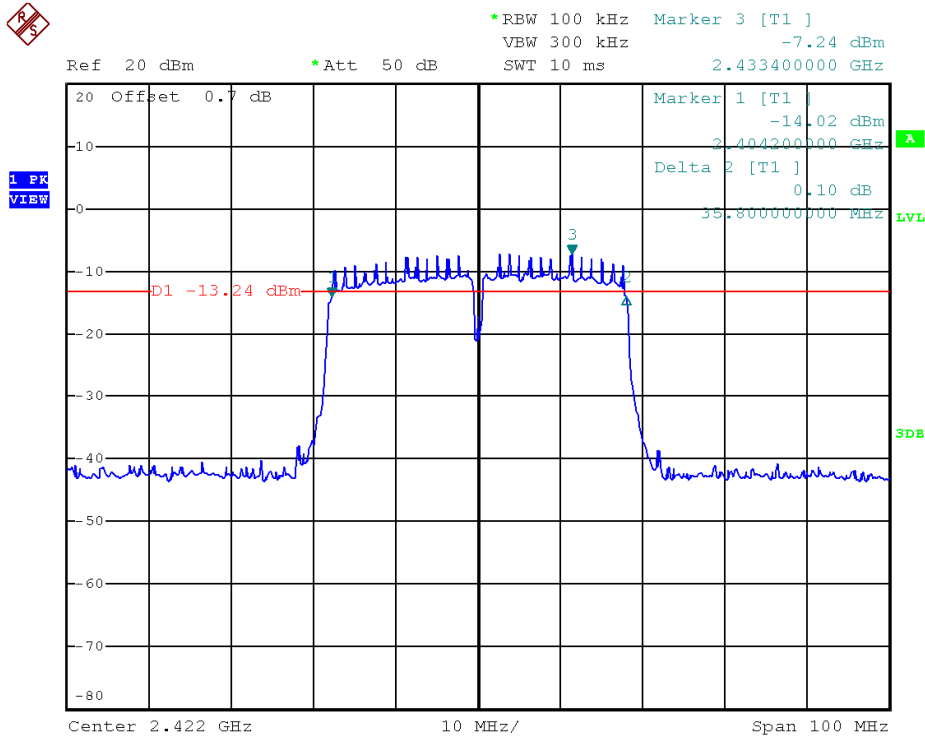

802.11n (40MHz), Middle Channel

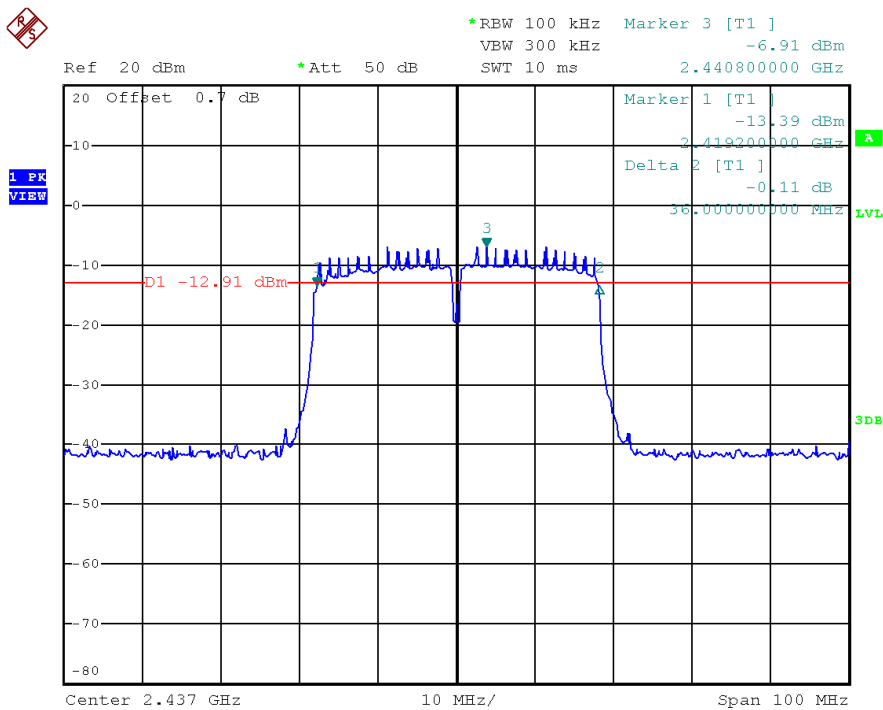

TEST REPORT

PLOTS OF 6dB RF BANDWIDTH

802.11n (40MHz), Highest Channel

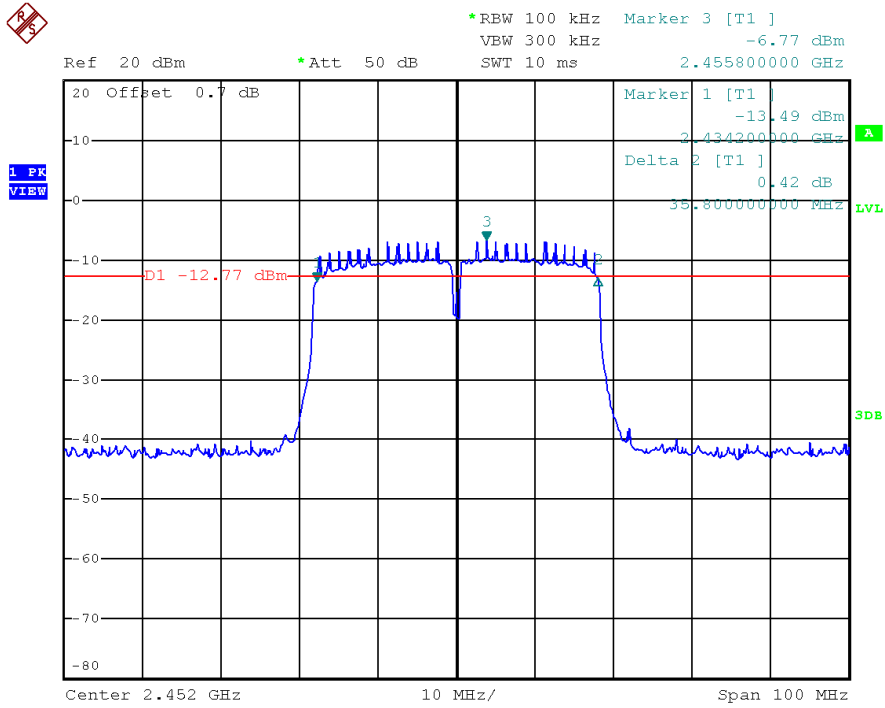

TEST REPORT**4.3 Maximum Power Spectral Density**

Antenna output of the EUT was coupled directly to spectrum analyzer. The measurement procedure 10.2 PKPSD-1 was used. If an external attenuator and/or cable was used, these losses are compensated for using the OFFSET function of the analyser.

IEEE 802.11b (DSSS, 1 Mbps)

Frequency (MHz)	PSD in 100kHz (dBm)
Low Channel: 2412	3.64
Middle Channel: 2437	4.27
High Channel: 2462	4.73

IEEE 802.11g (OFDM, 6 Mbps)

Frequency (MHz)	PSD in 100kHz (dBm)
Low Channel: 2412	-3.43
Middle Channel: 2437	-3.48
High Channel: 2462	-2.30

IEEE 802.11n (20MHz) (OFDM, MCS0)

Frequency (MHz)	PSD in 100kHz (dBm)
Low Channel: 2412	-4.03
Middle Channel: 2437	-3.64
High Channel: 2462	-2.30

IEEE 802.11n (40MHz) (OFDM, MCS0)

Frequency (MHz)	PSD in 100kHz (dBm)
Low Channel: 2422	-7.06
Middle Channel: 2437	-6.82
High Channel: 2452	-6.62

Cable Loss: 0.7 dB

Limit:
8dBm

The plots of power spectral density are as below.

TEST REPORT

PLOTS OF POWER SPECTRAL DENSITY

802.11b, Lowest channel

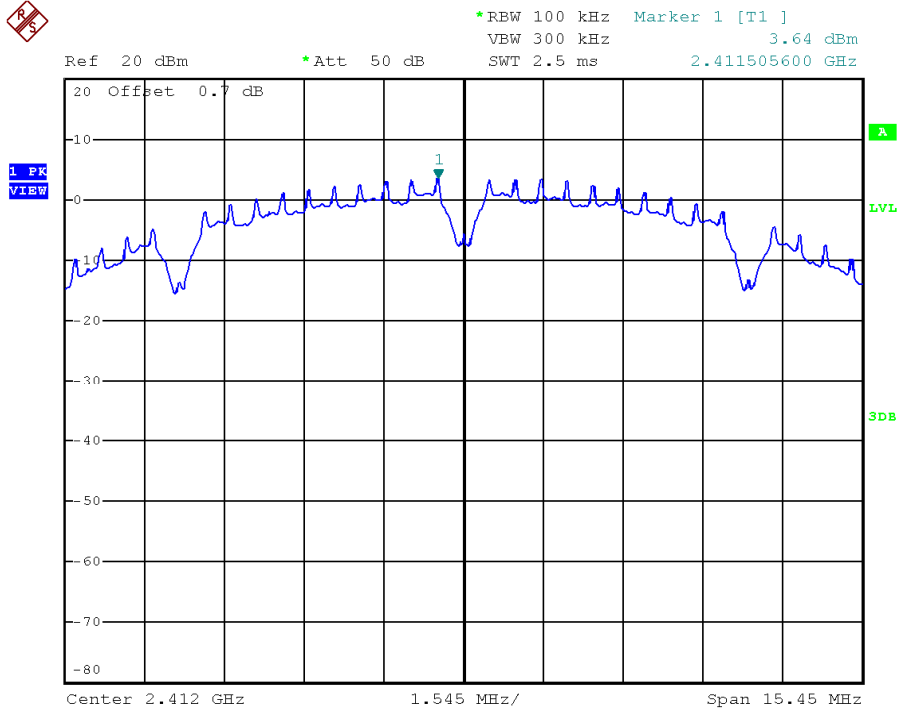

802.11b, Middle channel

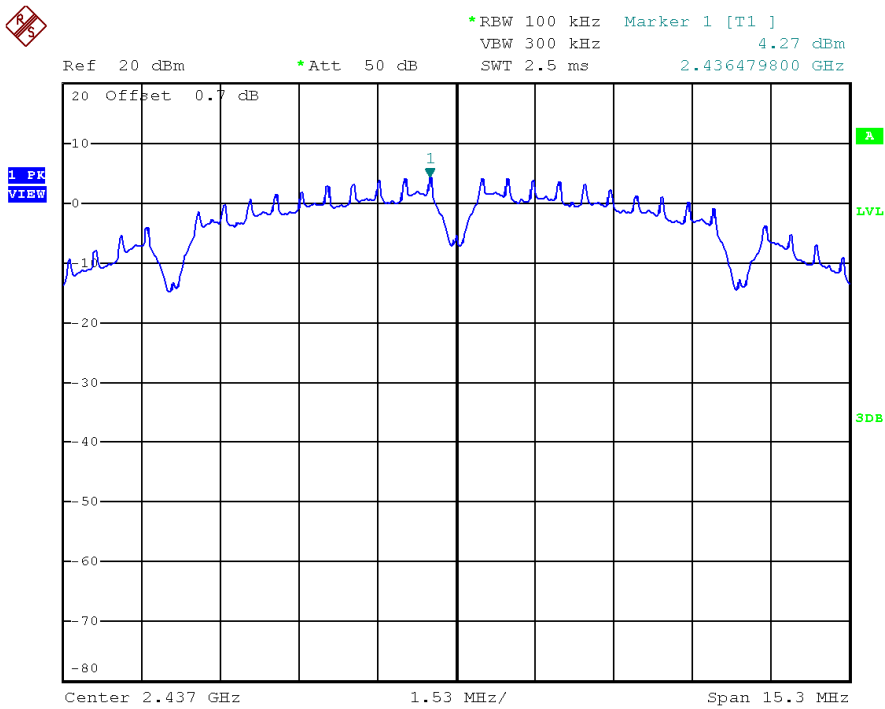

TEST REPORT

PLOTS OF POWER SPECTRAL DENSITY

802.11b, Highest channel

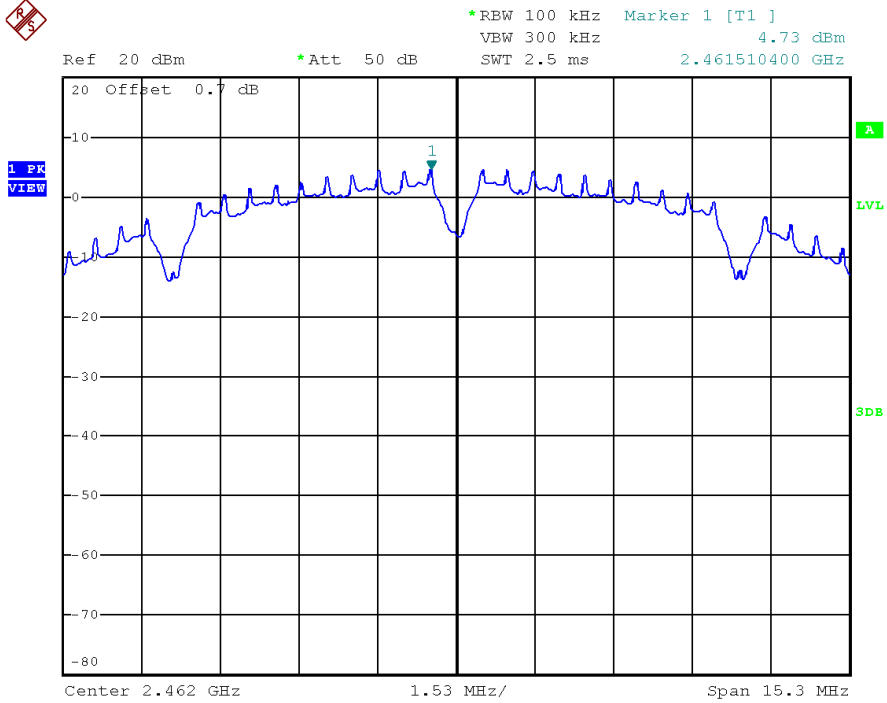

TEST REPORT

PLOTS OF POWER SPECTRAL DENSITY

802.11g, Lowest channel

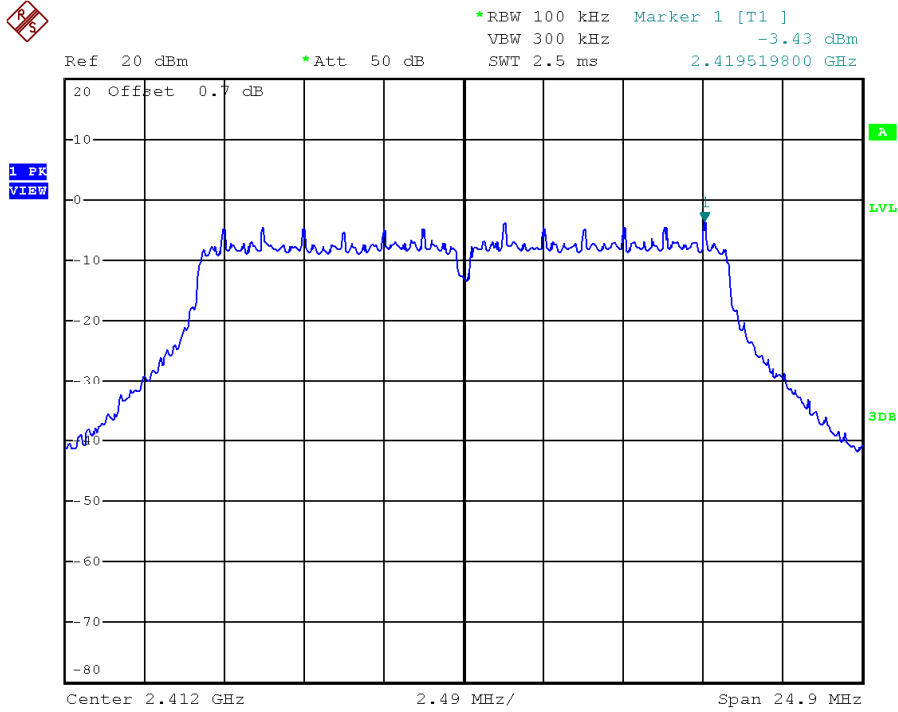

802.11g, Middle channel

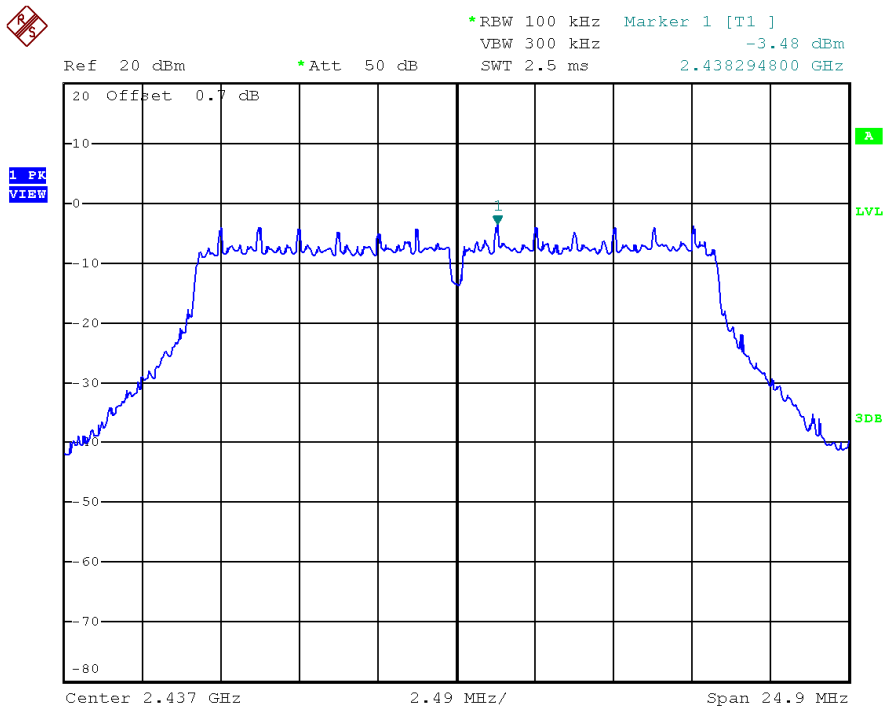

TEST REPORT

PLOTS OF POWER SPECTRAL DENSITY

802.11g, Highest channel

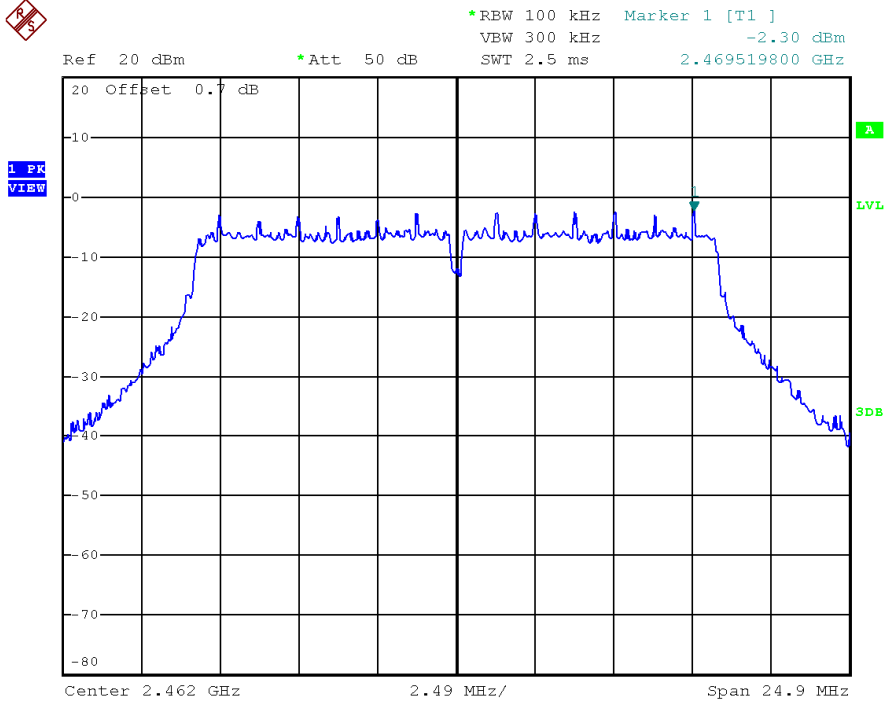

TEST REPORT

PLOTS OF POWER SPECTRAL DENSITY

802.11n (20MHz), Lowest channel

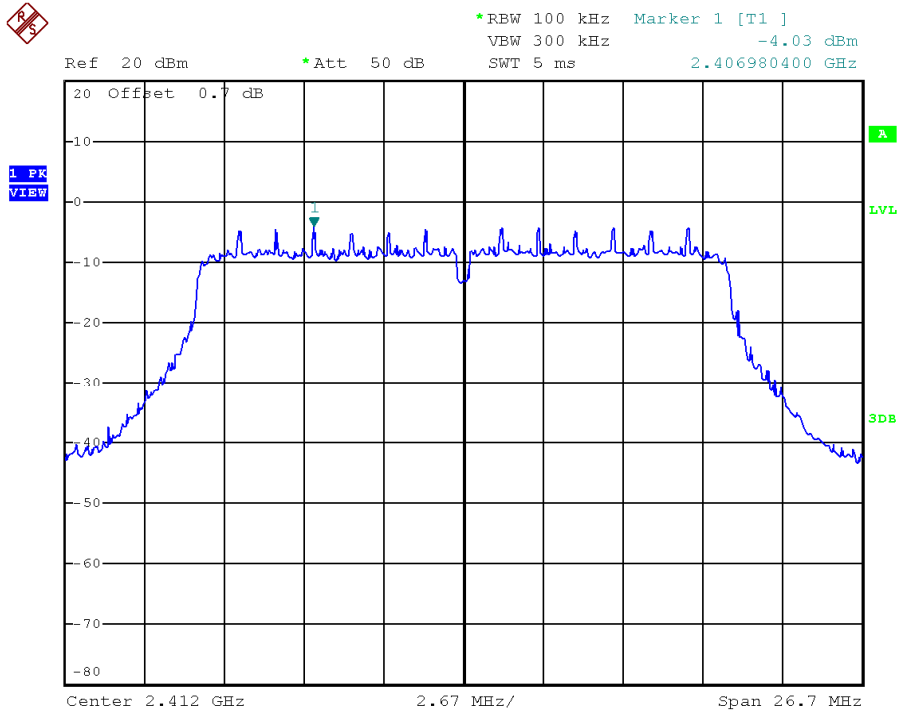

802.11n (20MHz), Middle channel

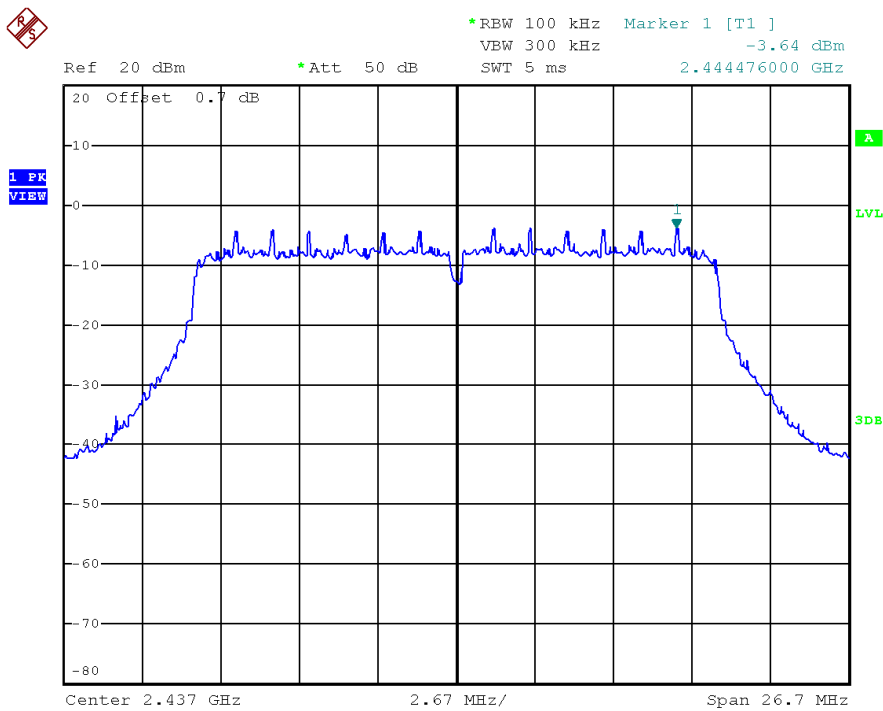

TEST REPORT

PLOTS OF POWER SPECTRAL DENSITY

802.11n (20MHz), Highest channel

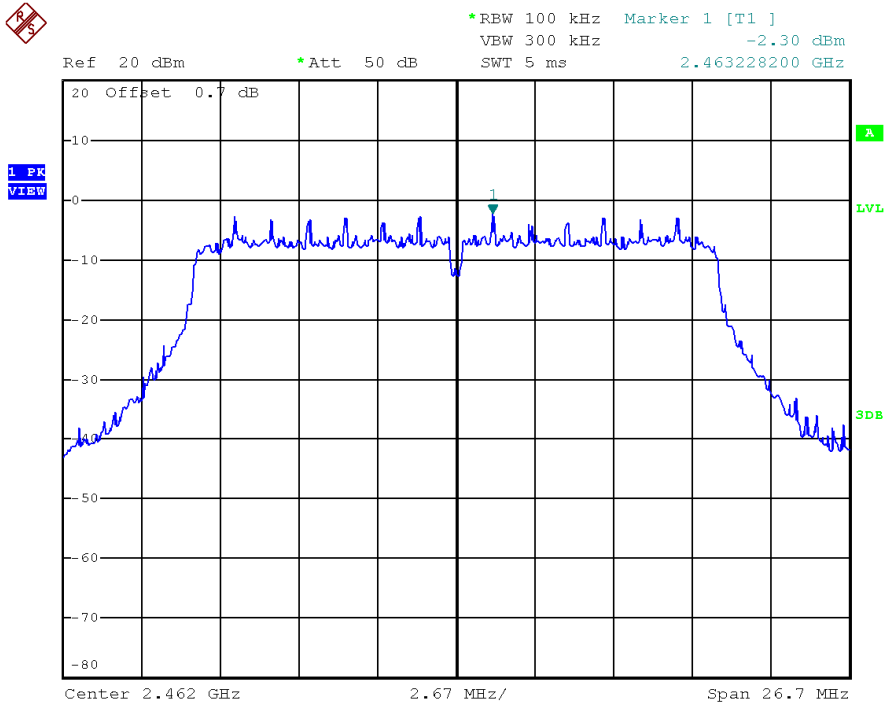

TEST REPORT

PLOTS OF POWER SPECTRAL DENSITY

802.11n (40MHz), Lowest channel

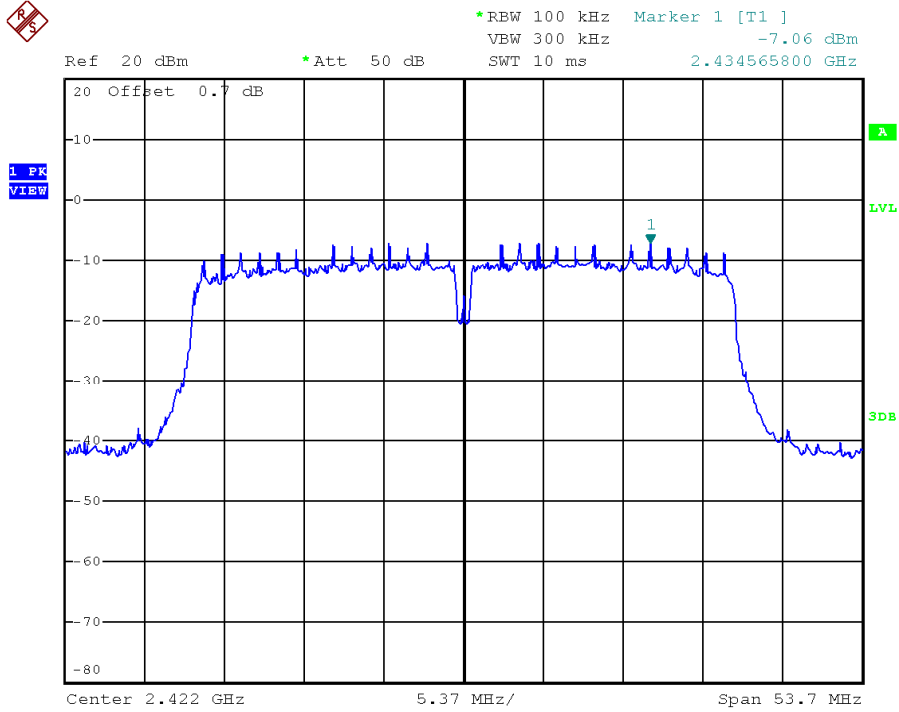

802.11n (40MHz), Middle channel

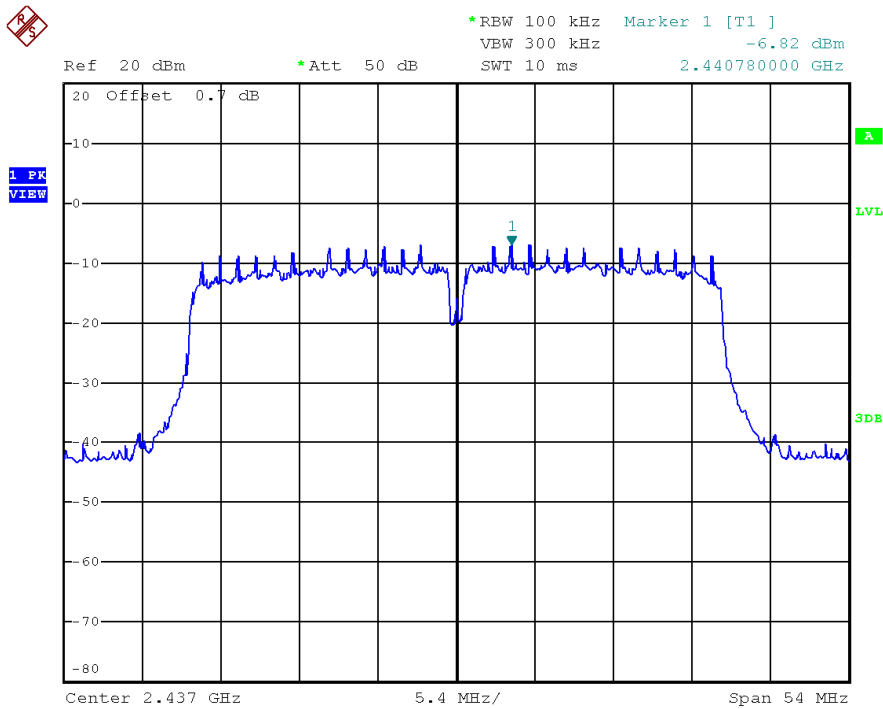

TEST REPORT

PLOTS OF POWER SPECTRAL DENSITY

802.11n (20MHz), Highest channel

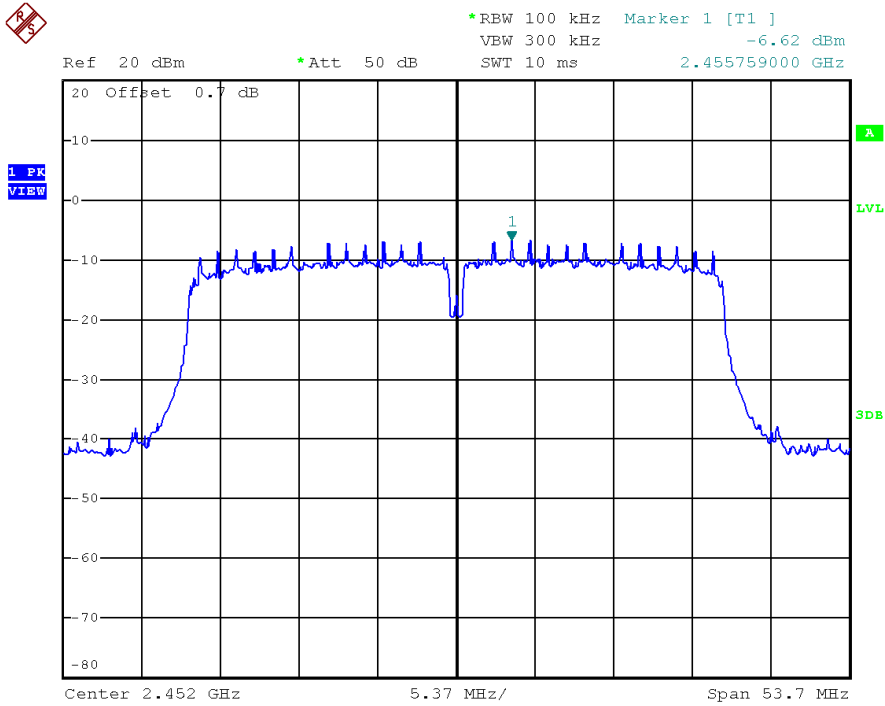

TEST REPORT

4.4 Out of Band Conducted Emissions

For 802.11b/g/n20/n40MHz, the maximum conducted (peak) output power was used to demonstrate compliance as described in 9.1. Then the display line (in red) shown in the following plots denotes the limit at 20dB below maximum measured in-band peak PSD level in 100 KHz bandwidth for 802.11b/g/n20/n40MHz.

The measurement procedures under sections 11 of KDB558074 D01 v04 (05-April-2017) were used.

Furthermore, delta measurement technique for measuring bandedge emissions was incorporated in the test of the edge at 2483.5MHz.

Limits:

All spurious emission and up to the tenth harmonic was measured and they were found to be at least for 802.11b,g,n20MHz, n40MHz below the maximum measured in-band peak PSD level.

TEST REPORT

PLOTS OF OUT OF BAND CONDUCTED EMISSIONS

802.11b, Lowest Channel

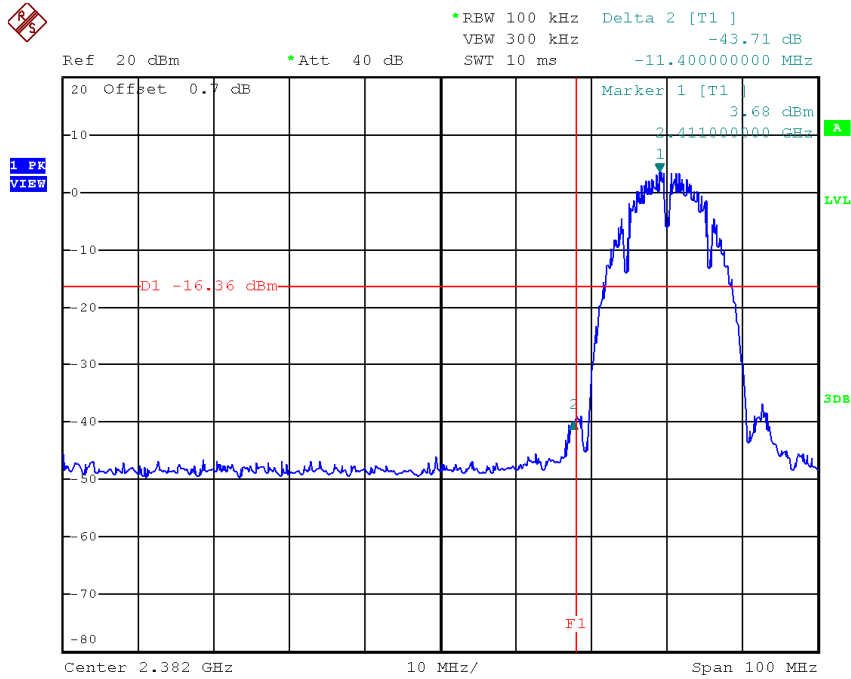

802.11b, Highest Channel

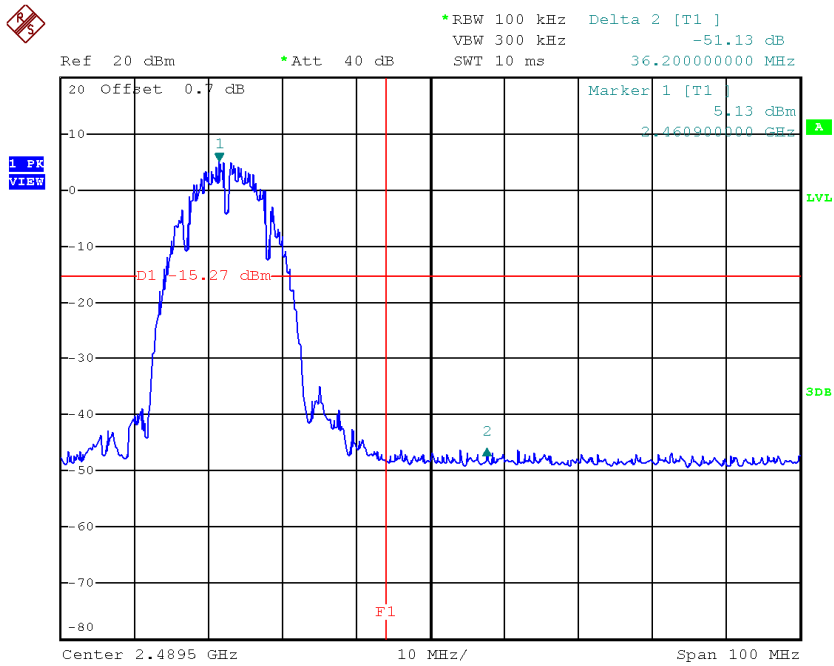

TEST REPORT

PLOTS OF OUT OF BAND CONDUCTED EMISSIONS

802.11b, Lowest Channel, Plot A

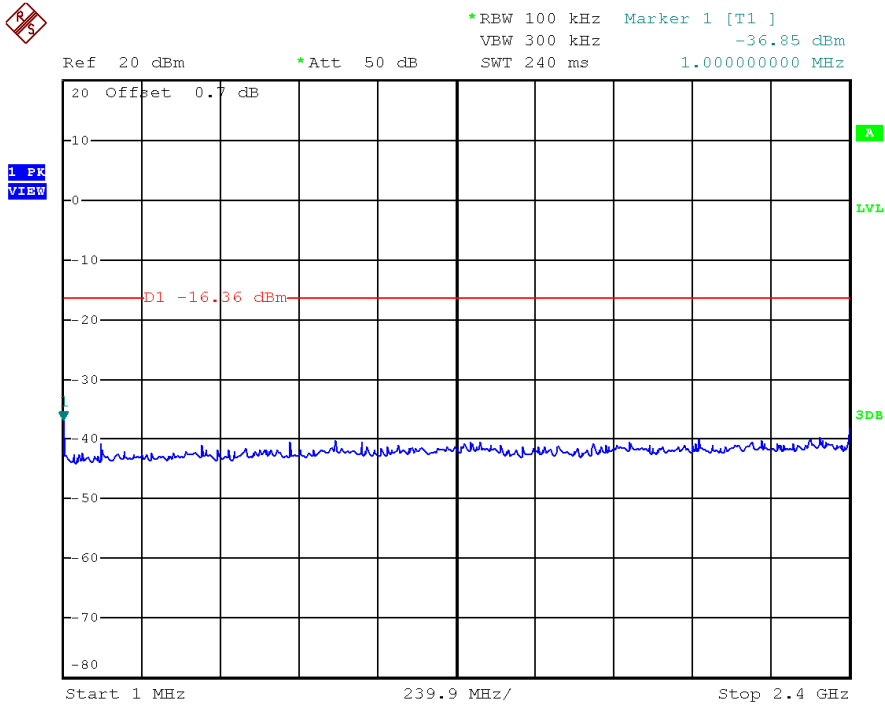

802.11b, Lowest Channel, Plot B

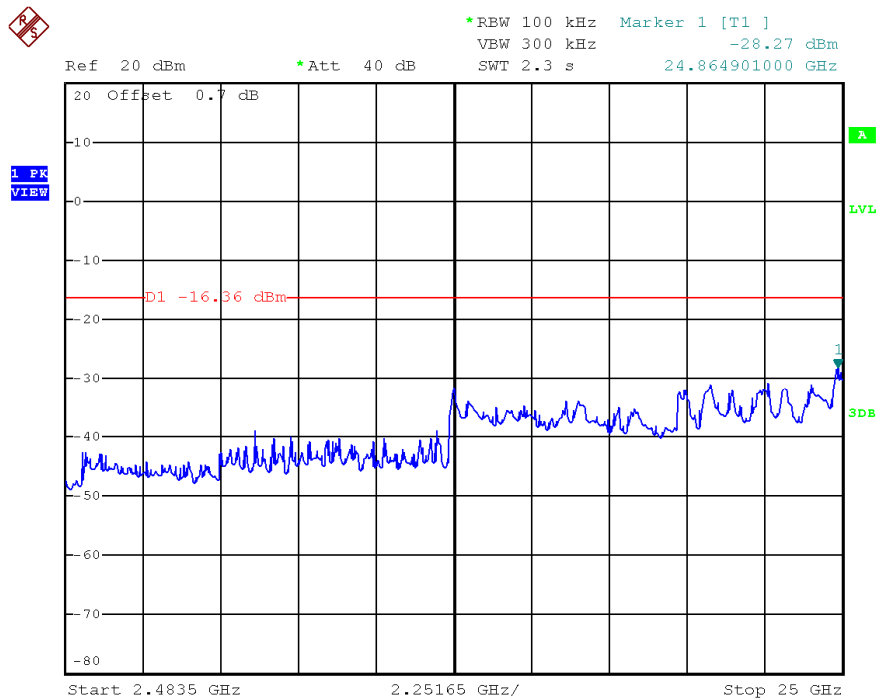

TEST REPORT

PLOTS OF OUT OF BAND CONDUCTED EMISSIONS

802.11b, Middle Channel, Plot A

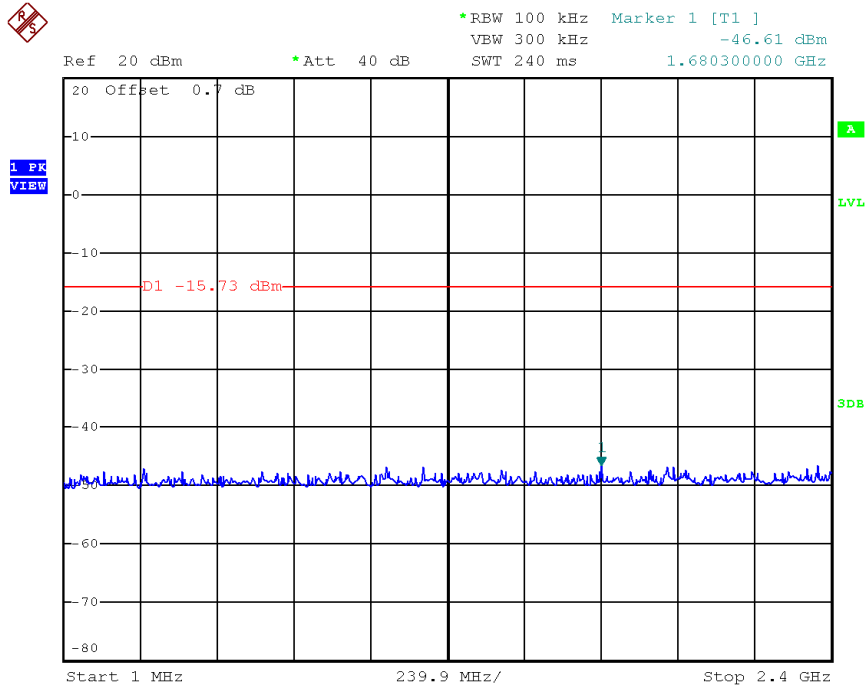

802.11b, Middle Channel, Plot B

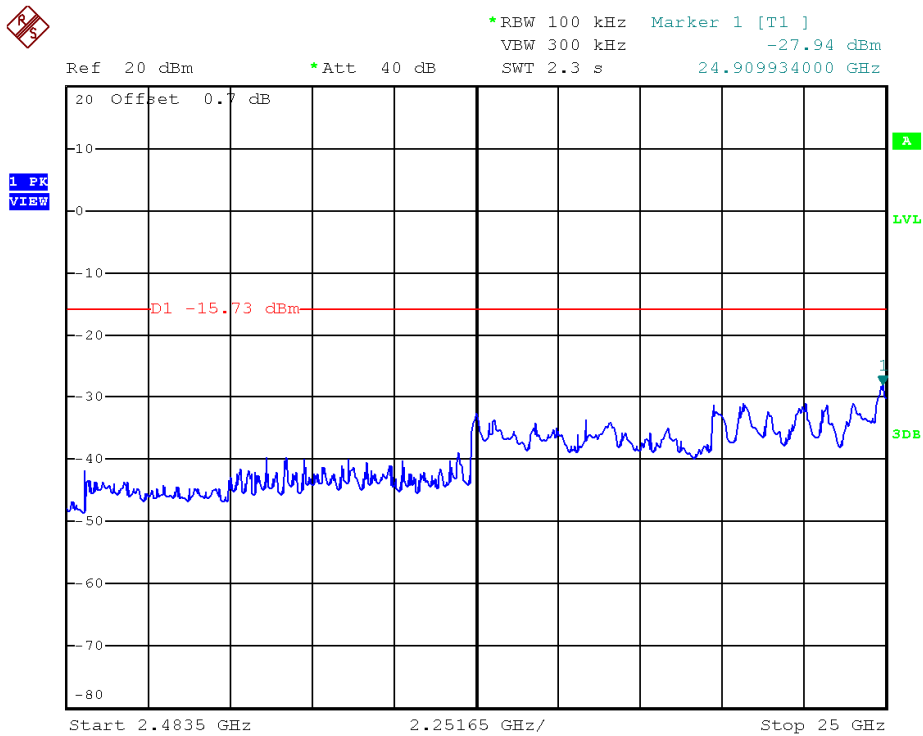

TEST REPORT

PLOTS OF OUT OF BAND CONDUCTED EMISSIONS

802.11b, Highest Channel, Plot A

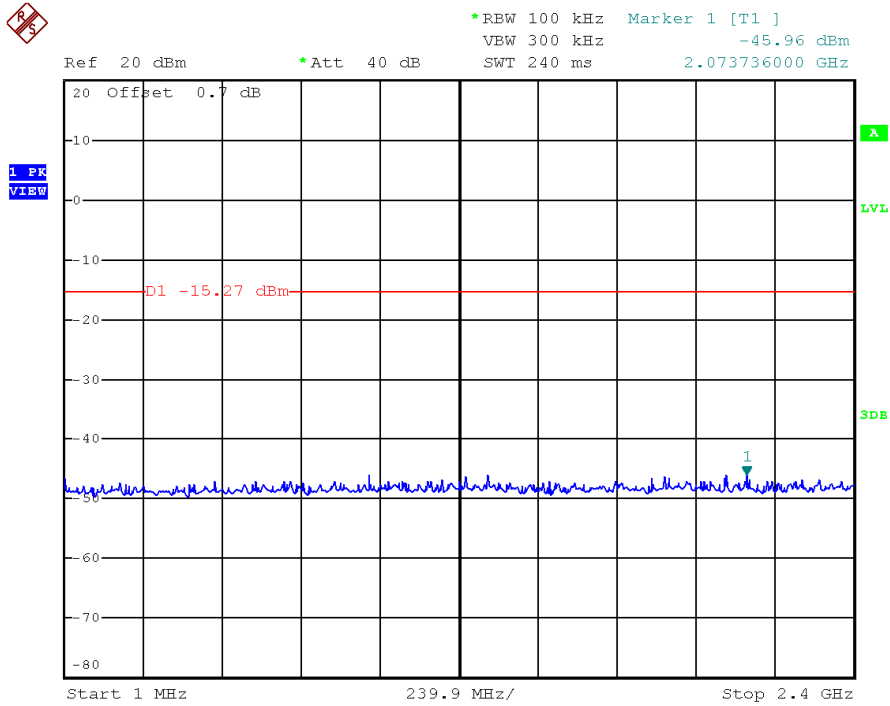

802.11b, Highest Channel, Plot B

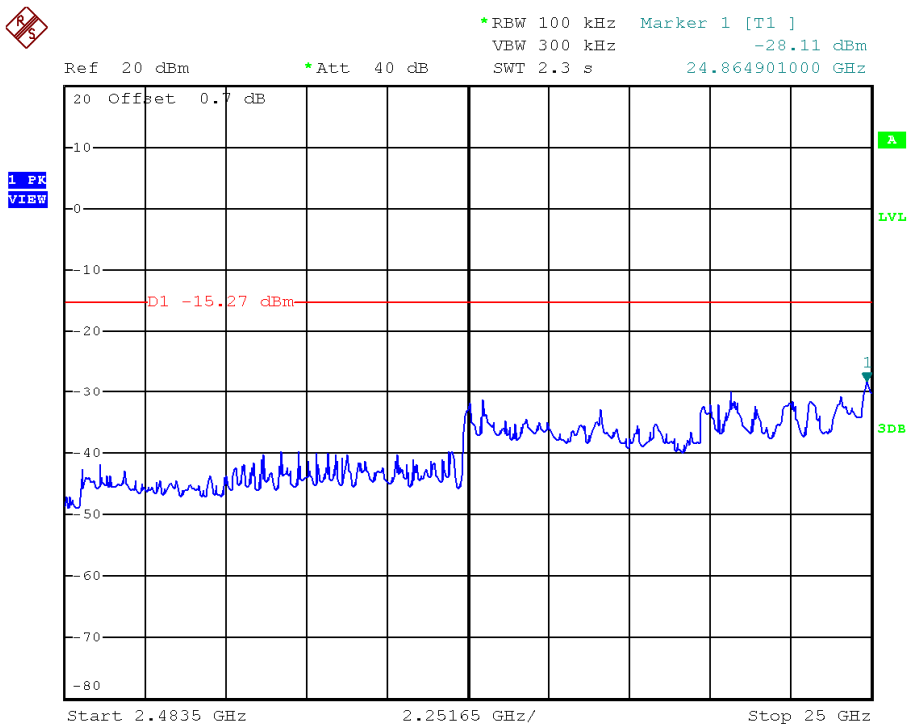

TEST REPORT

PLOTS OF OUT OF BAND CONDUCTED EMISSIONS

802.11g, Lowest Channel

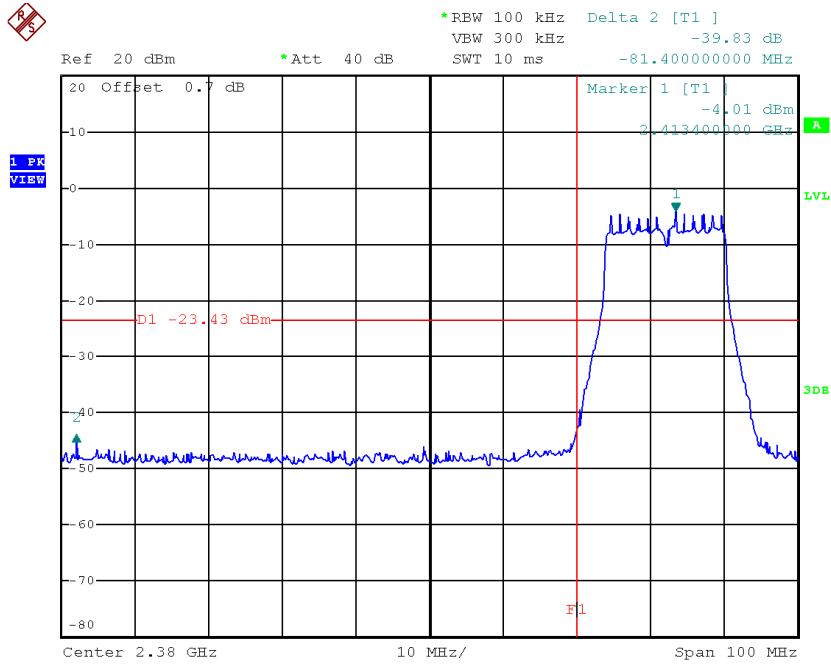

802.11g, Highest Channel

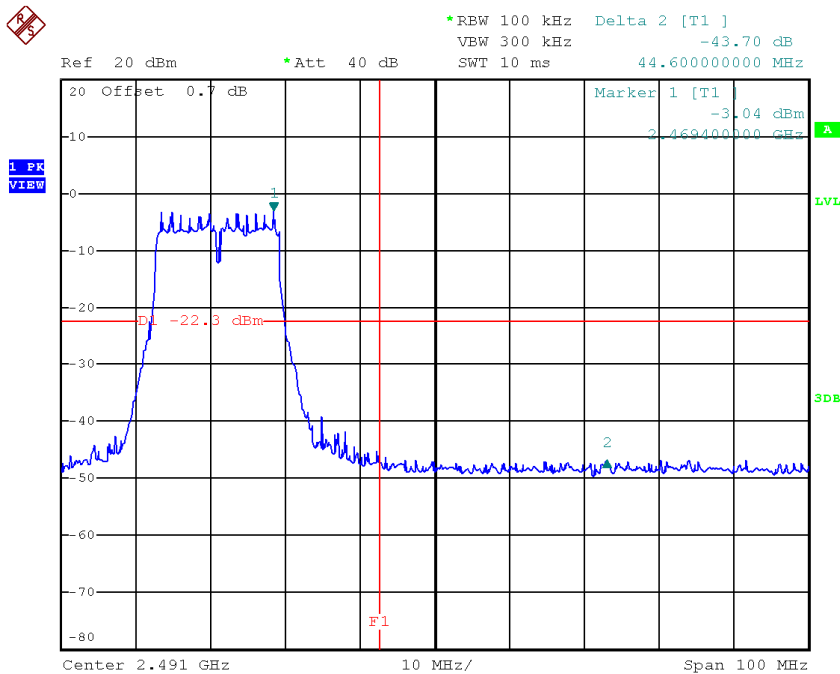

TEST REPORT

PLOTS OF OUT OF BAND CONDUCTED EMISSIONS

802.11g, Lowest Channel, Plot A

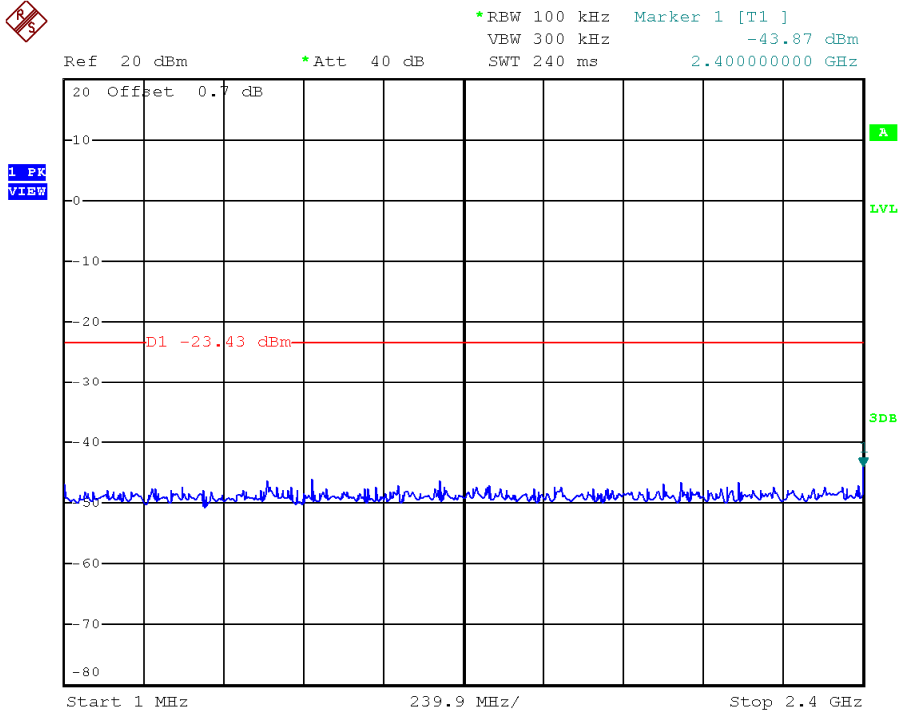

802.11g, Lowest Channel, Plot B

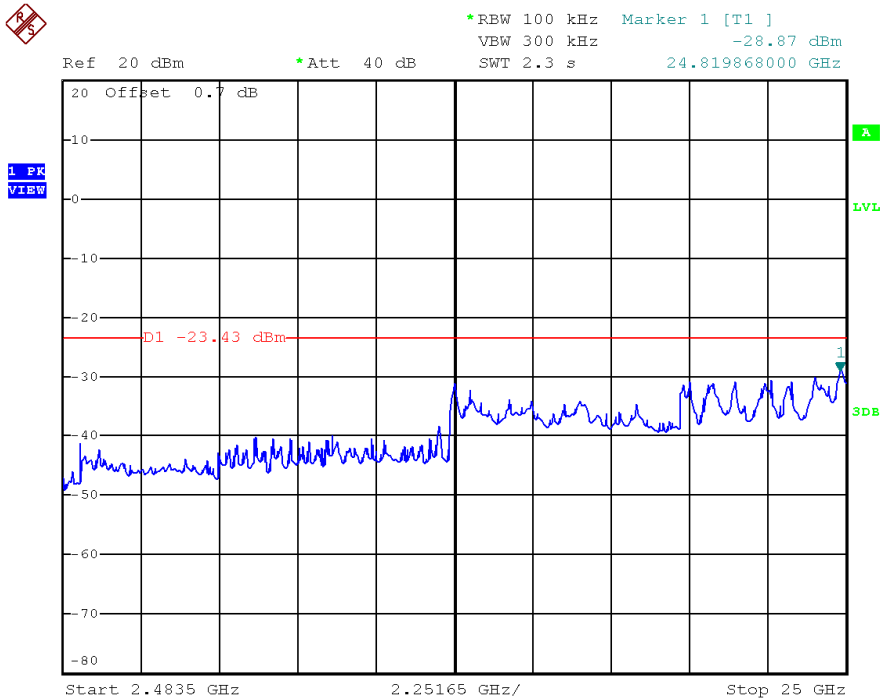

TEST REPORT

PLOTS OF OUT OF BAND CONDUCTED EMISSIONS

802.11g, Middle Channel, Plot A

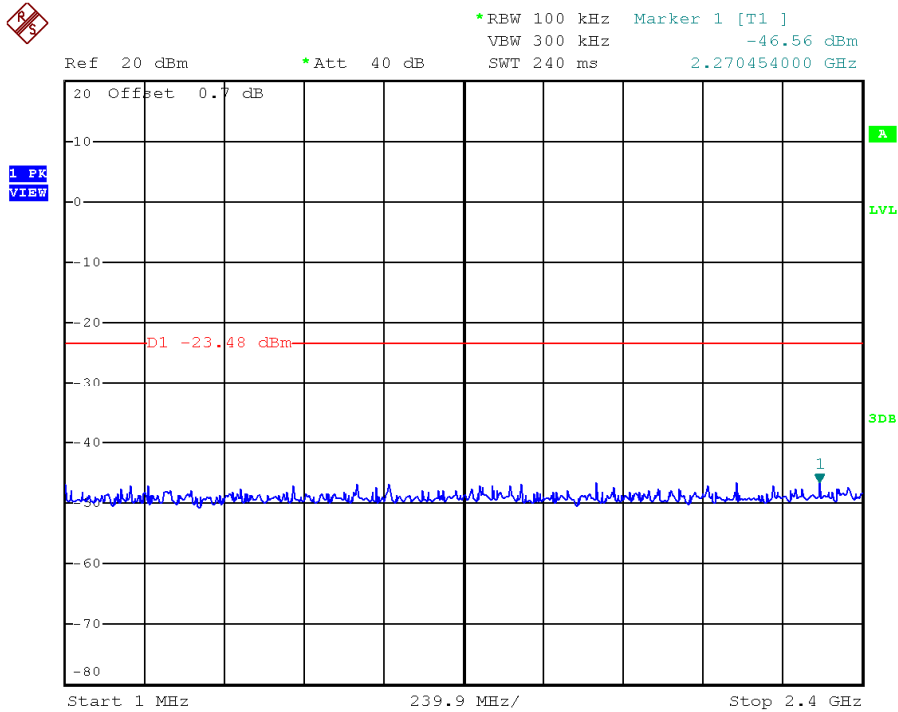

802.11g, Middle Channel, Plot B

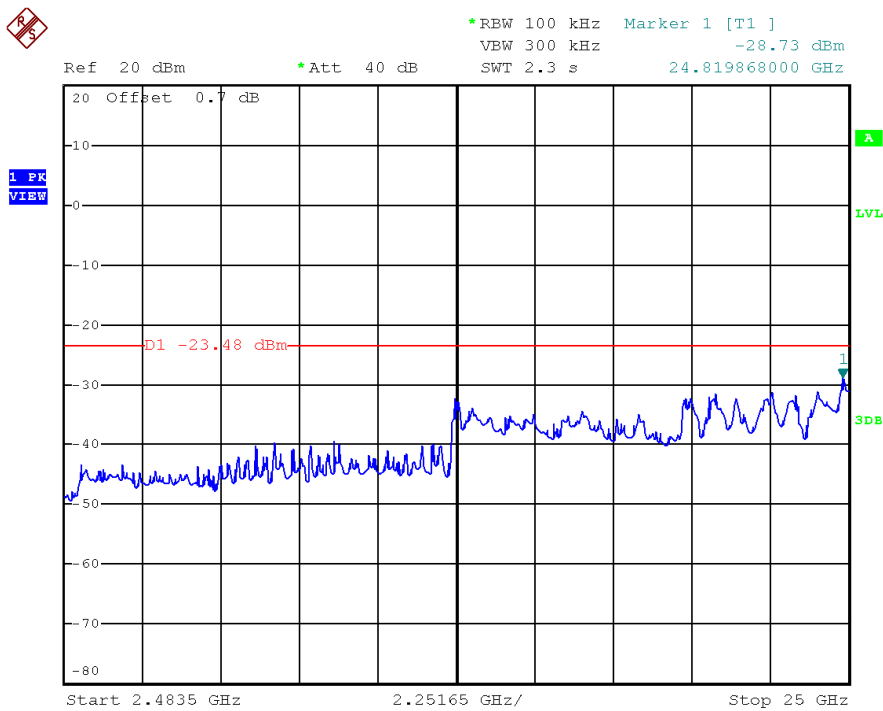

TEST REPORT

PLOTS OF OUT OF BAND CONDUCTED EMISSIONS

802.11g, Highest Channel, Plot A

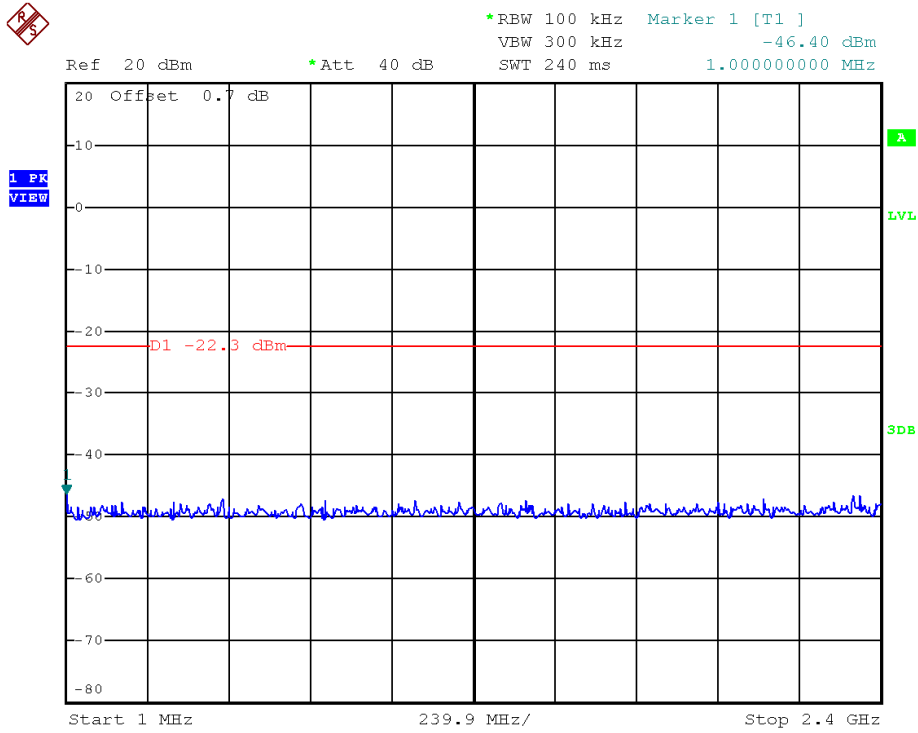

802.11g, Highest Channel, Plot B

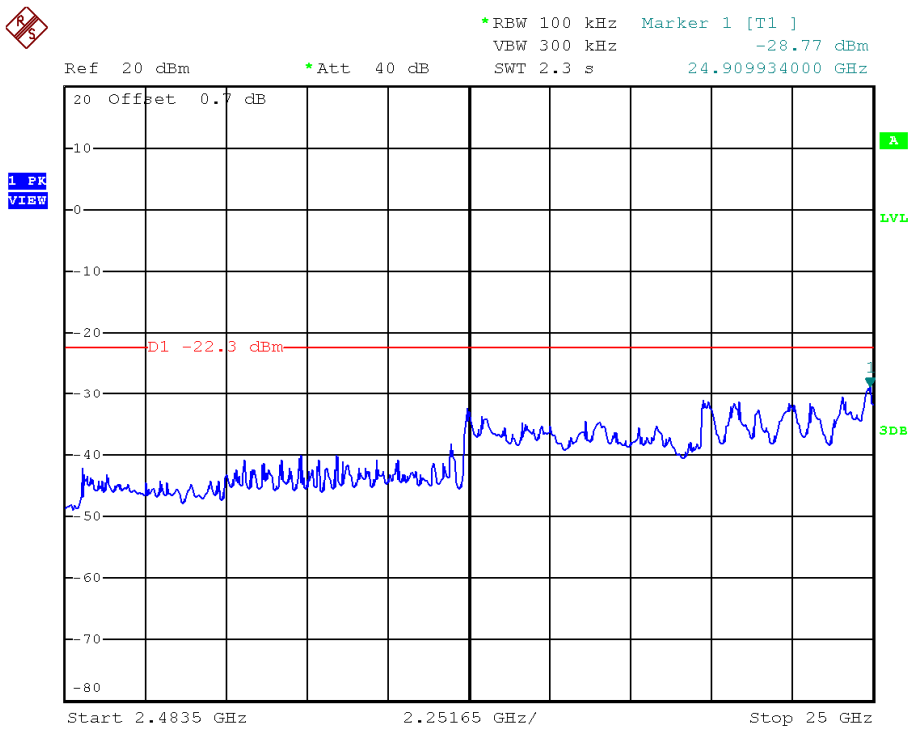

TEST REPORT

PLOTS OF OUT OF BAND CONDUCTED EMISSIONS

802.11n (20MHz), Lowest Channel

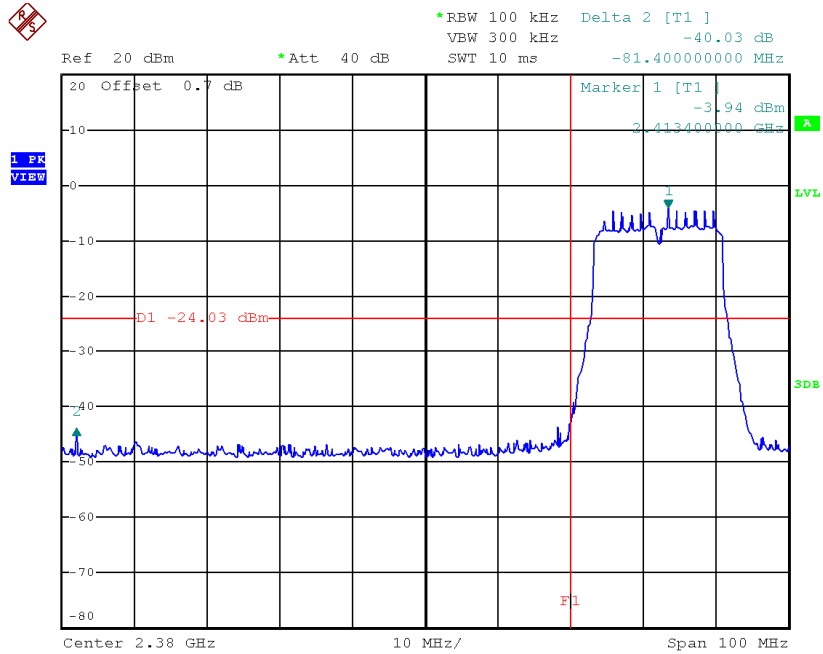

802.11n (20MHz), Highest Channel

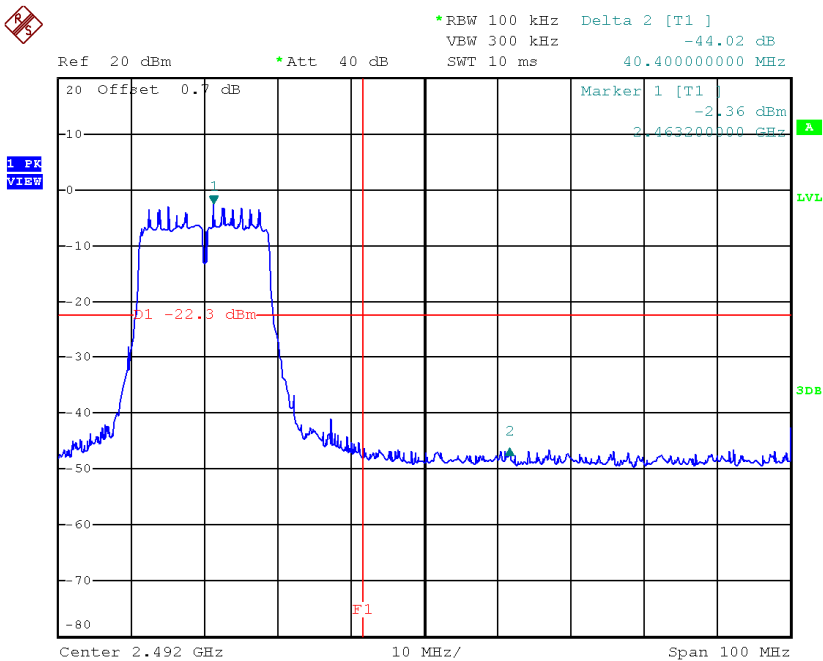

TEST REPORT

PLOTS OF OUT OF BAND CONDUCTED EMISSIONS

802.11n (20MHz), Lowest Channel, Plot A

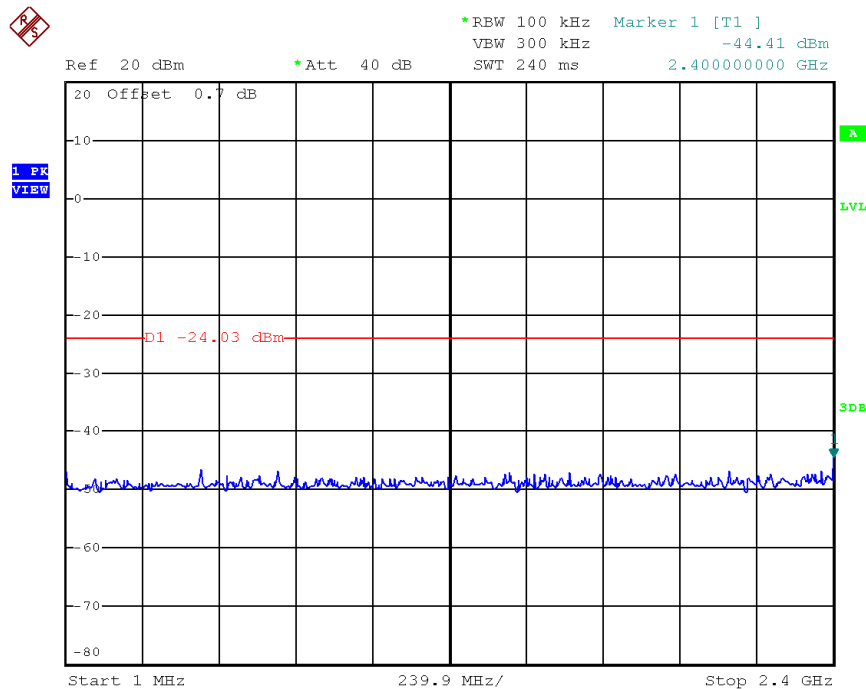

802.11n (20MHz), Lowest Channel, Plot B

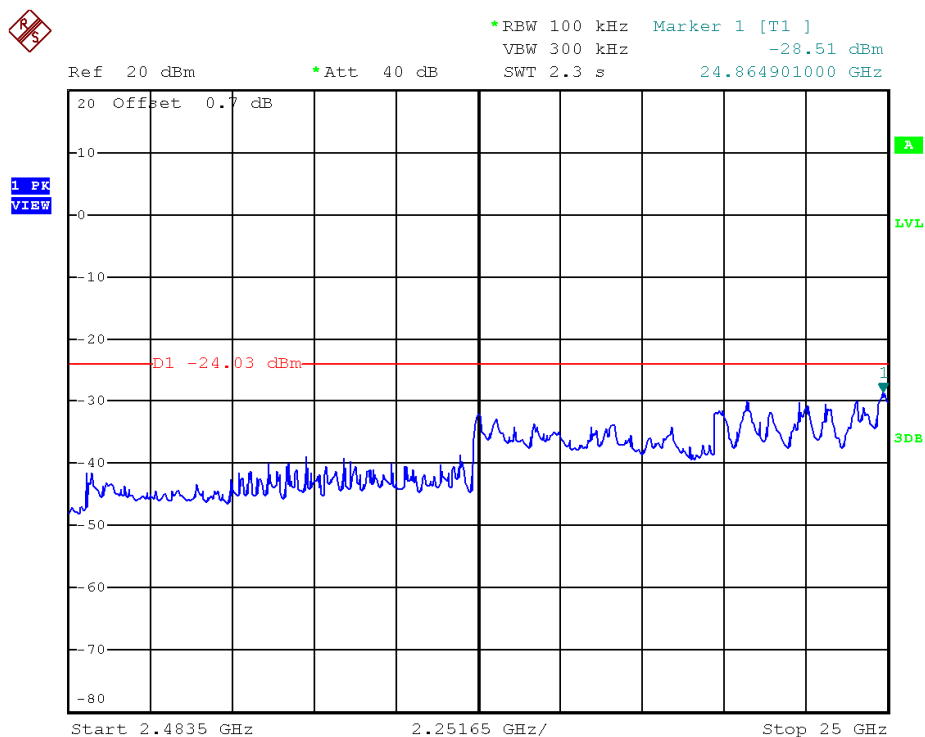

TEST REPORT

PLOTS OF OUT OF BAND CONDUCTED EMISSIONS

802.11n (20MHz), Middle Channel, Plot A

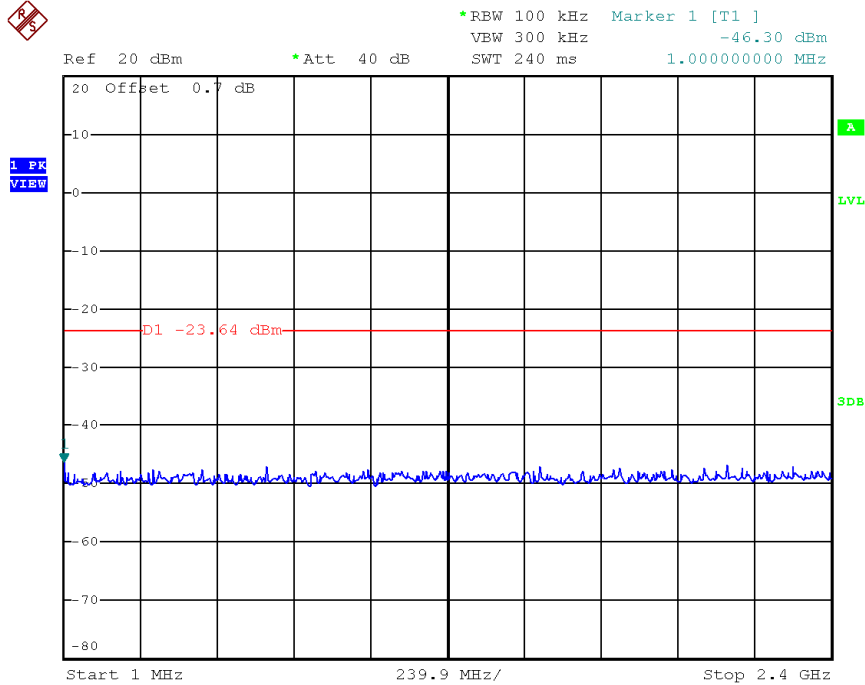

802.11n (20MHz), Middle Channel, Plot B

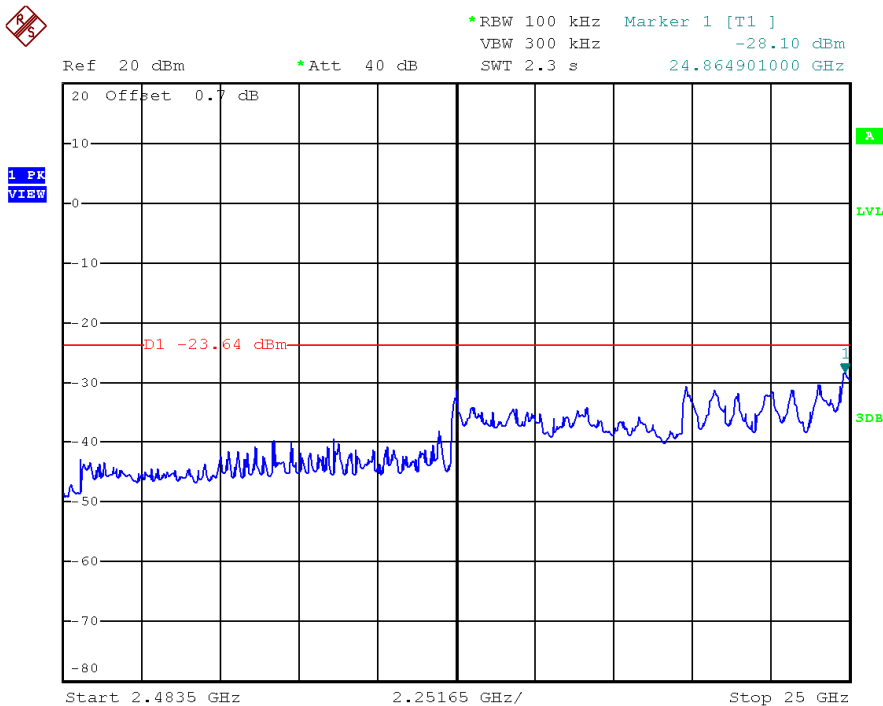

TEST REPORT

PLOTS OF OUT OF BAND CONDUCTED EMISSIONS

802.11n (20MHz), Highest Channel, Plot A

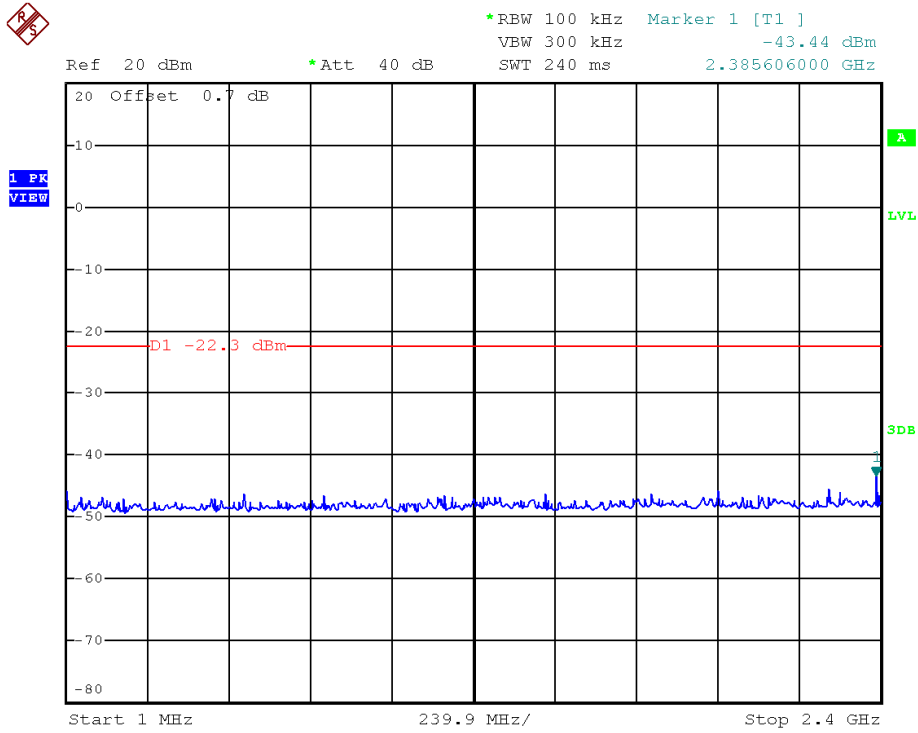

802.11n (20MHz), Highest Channel, Plot B

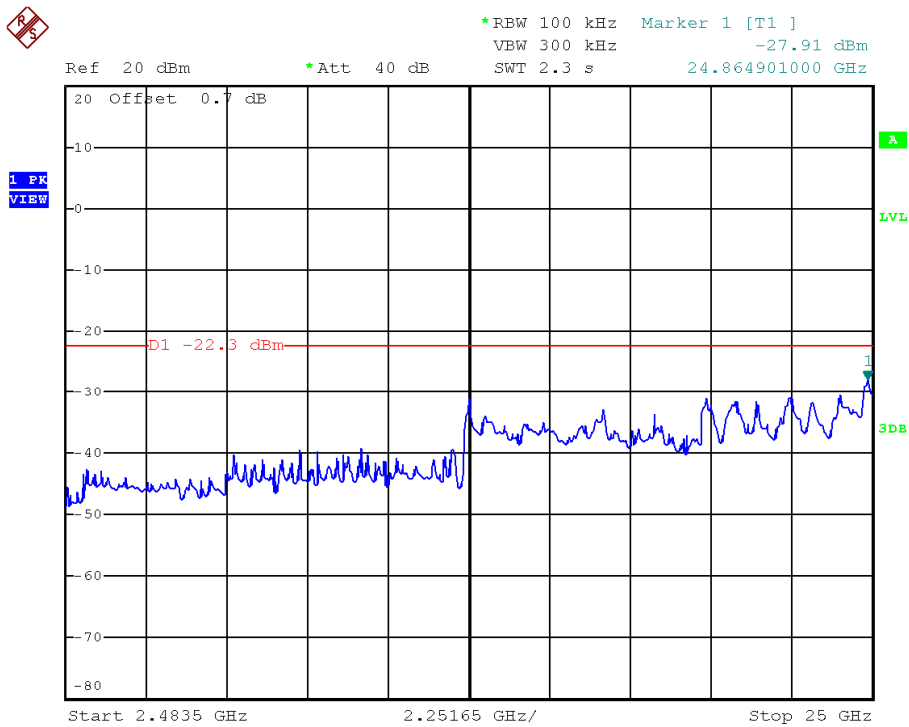

TEST REPORT

PLOTS OF OUT OF BAND CONDUCTED EMISSIONS

802.11n (40MHz), Lowest Channel

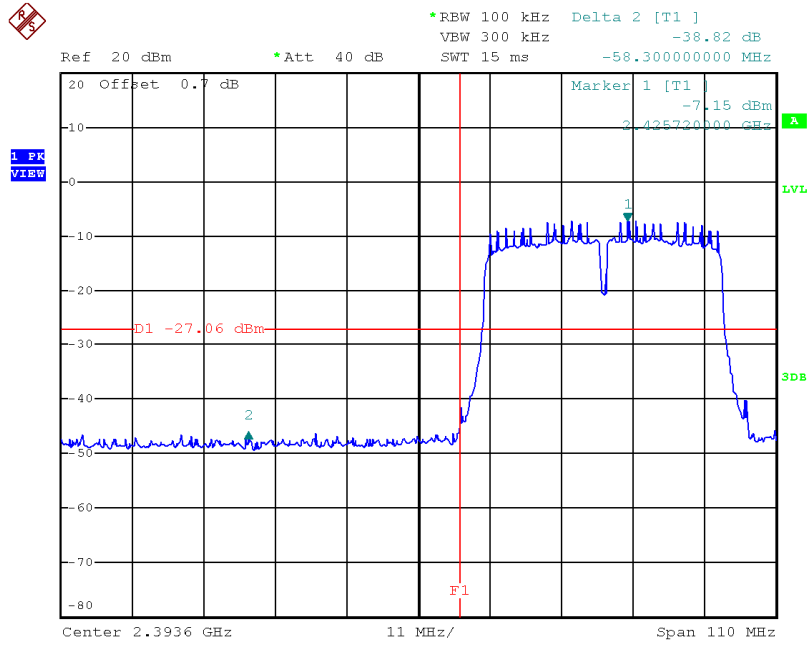

802.11n (40MHz), Highest Channel

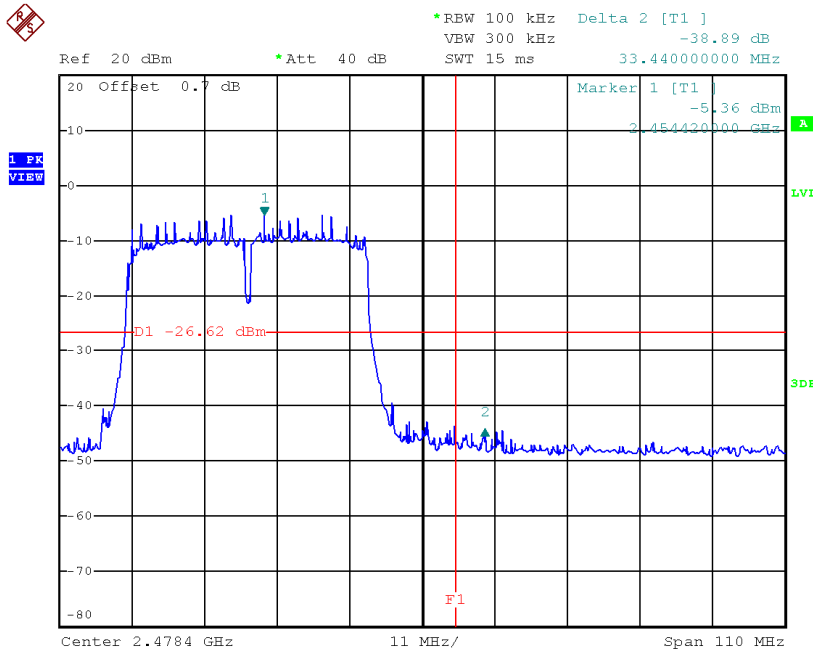

TEST REPORT

PLOTS OF OUT OF BAND CONDUCTED EMISSIONS

802.11n (40MHz), Lowest Channel, Plot A

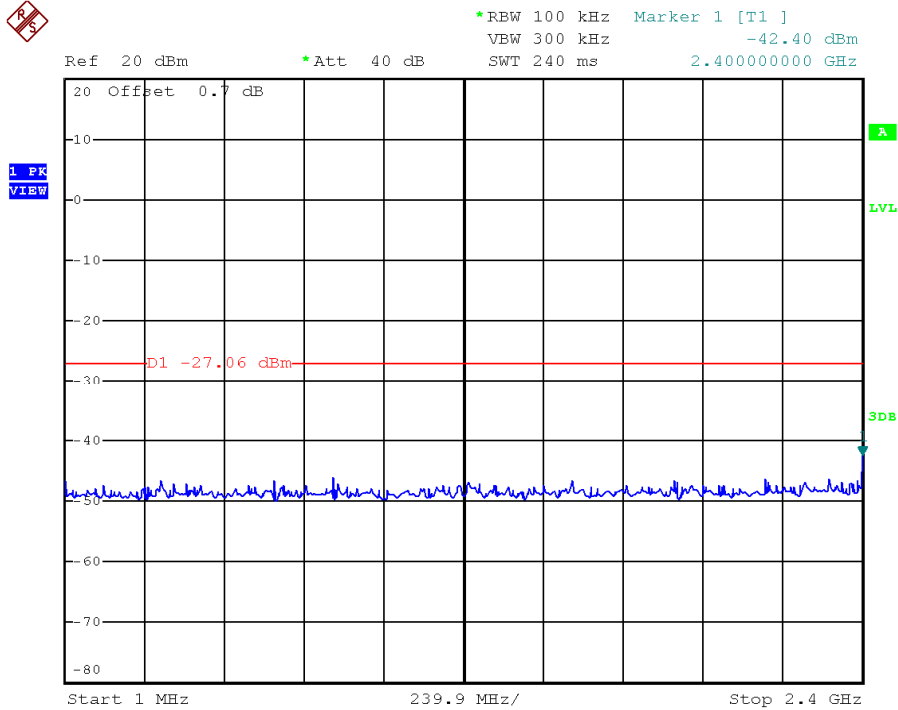

802.11n (40MHz), Lowest Channel, Plot B

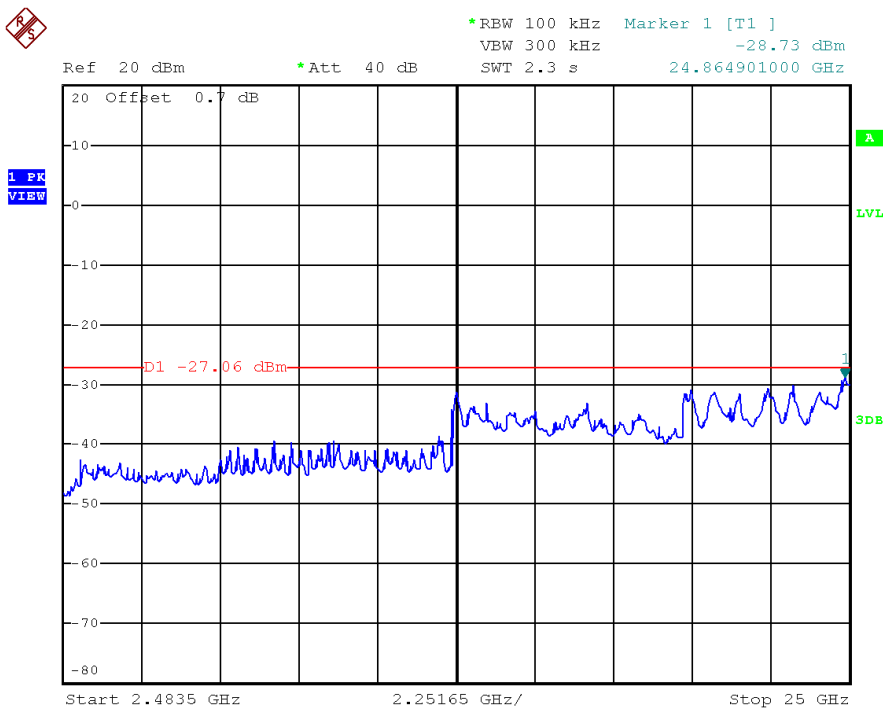

TEST REPORT

PLOTS OF OUT OF BAND CONDUCTED EMISSIONS

802.11n (40MHz), Middle Channel, Plot A

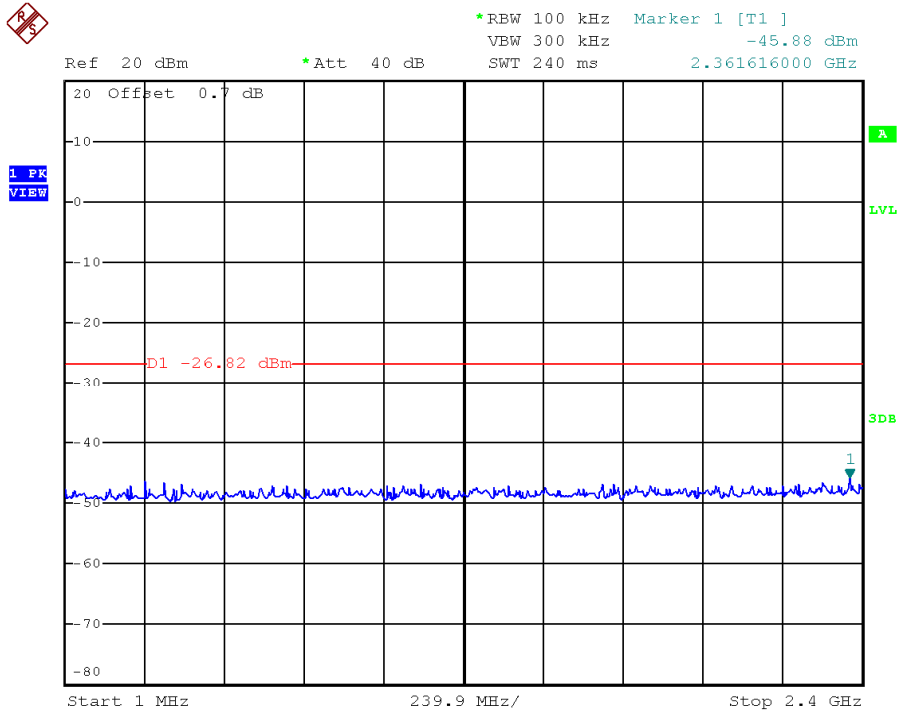

802.11n (40MHz), Middle Channel, Plot B

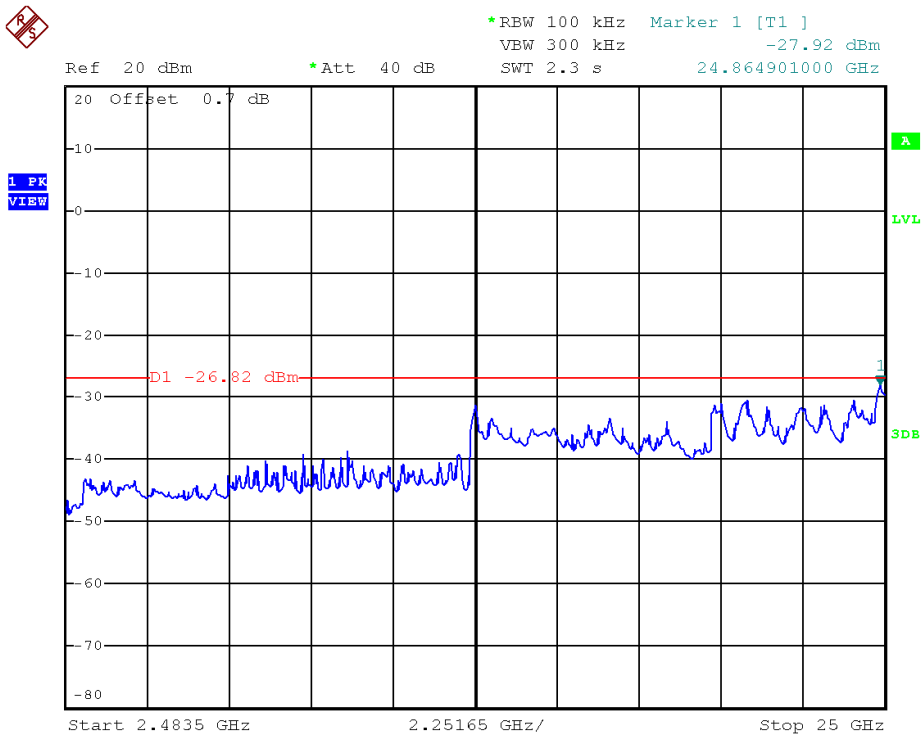

TEST REPORT

PLOTS OF OUT OF BAND CONDUCTED EMISSIONS

802.11n (40MHz), Highest Channel, Plot A

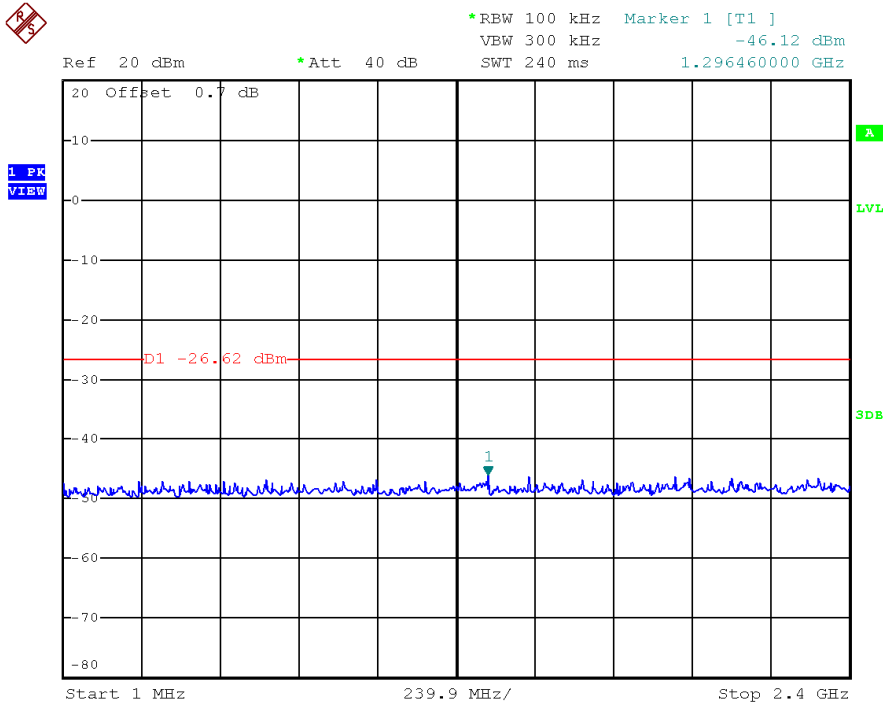

802.11n (40MHz), Highest Channel, Plot B

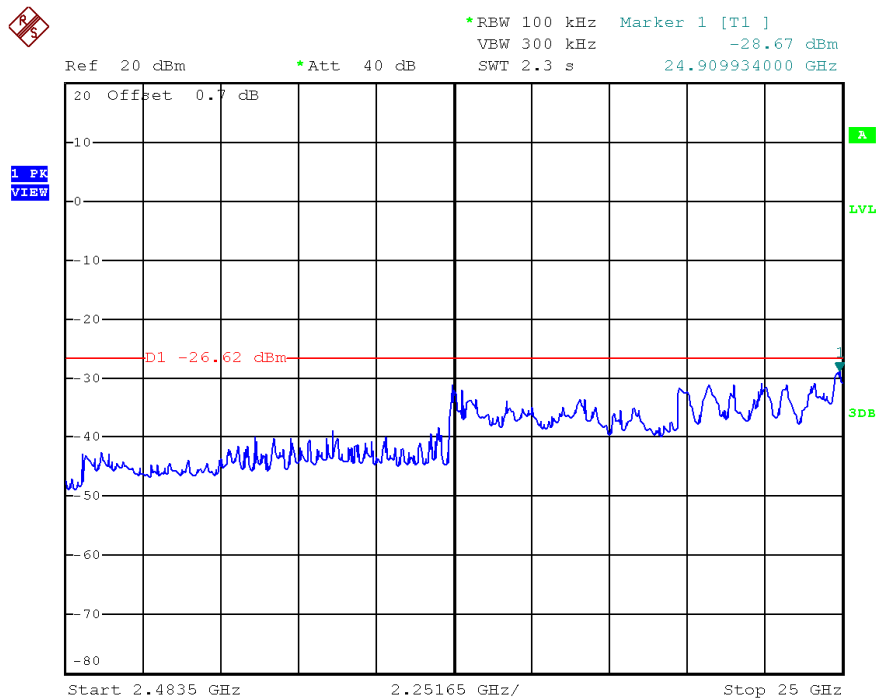

TEST REPORT

4.5 Field Strength Calculation

The field strength is calculated by adding the reading on the Spectrum Analyzer to the factors associated with preamplifiers (if any), antennas, cables, pulse desensitization and average factors (when specified limit is in average and measurements are made with peak detectors). A sample calculation is included below.

$$FS = RA + AF + CF - AG + PD + AV$$

Where FS = Field Strength in dB μ V/m

RA = Receiver Amplitude (including preamplifier) in dB μ V

CF = Cable Attenuation Factor in dB

AF = Antenna Factor in dB

AG = Amplifier Gain in dB

PD = Pulse Desensitization in dB

AV = Average Factor in -dB

In the radiated emission table which follows, the reading shown on the data table may reflect the preamplifier gain. An example of the calculations, where the reading does not reflect the preamplifier gain, follows:

$$FS = RA + AF + CF - AG + PD + AV$$

Example

Assume a receiver reading of 62.0 dB μ V is obtained. The antenna factor of 7.4 dB and cable factor of 1.6 dB is added. The amplifier gain of 29.0 dB is subtracted. The pulse desensitization factor of the spectrum analyzer is 0.0 dB, and the resultant average factor is -10.0 dB. The net field strength for comparison to the appropriate emission limit is 32.0 dB μ V/m. This value in dB μ V/m is converted to its corresponding level in μ V/m.

$$RA = 62.0 \text{ dB}\mu\text{V}$$

$$AF = 7.4 \text{ dB}$$

$$CF = 1.6 \text{ dB}$$

$$AG = 29.0 \text{ dB}$$

$$PD = 0.0 \text{ dB}$$

$$AV = -10 \text{ dB}$$

$$FS = 62.0 + 7.4 + 1.6 - 29.0 + 0.0 + (-10.0) = 32.0 \text{ dB}\mu\text{V/m}$$

$$\text{Level in } \mu\text{V/m} = \text{Common Antilogarithm } [(32.0 \text{ dB}\mu\text{V/m})/20] = 39.8 \mu\text{V/m}$$

TEST REPORT

4.6 Transmitter Radiated Emissions in Restricted Bands and Spurious Emissions

Data is included of the worst case configuration (the configuration which resulted in the highest emission levels). A sample calculation, configuration photographs and data tables of the emissions are included.

The data on the following pages list the significant emission frequencies, the limit and the margin of compliance.

4.6.1 Radiated Emission Configuration Photograph

Worst Case Restricted Band Radiated Emission
at

55.947 MHz

The worst case radiated emission configuration photographs are saved with filename: config photos.pdf

4.6.2 Radiated Emission Data

The data in tables 1-15 list the significant emission frequencies, the limit and the margin of compliance.

Judgement -

Passed by 2.5 dB margin

TEST REPORT

RADIATED EMISSION DATA

Mode: TX-Channel 01

Table 1
IEEE 802.11b (DSSS, 1 Mbps)

Polarization	Frequency (MHz)	Reading (dBµV)	Pre-Amp Gain (dB)	Antenna Factor (dB)	Net at 3m (dBµV/m)	Average Limit at 3m (dBµV/m)	Margin (dB)
<i>H</i>	<i>2390.000</i>	<i>44.0</i>	<i>33</i>	<i>29.4</i>	<i>40.4</i>	<i>54.0</i>	<i>-13.6</i>
<i>V</i>	<i>4824.000</i>	<i>32.9</i>	<i>33</i>	<i>34.9</i>	<i>34.8</i>	<i>54.0</i>	<i>-19.2</i>
<i>H</i>	<i>12060.000</i>	<i>30.7</i>	<i>33</i>	<i>40.5</i>	<i>38.2</i>	<i>54.0</i>	<i>-15.8</i>
<i>V</i>	<i>14472.000</i>	<i>33.2</i>	<i>33</i>	<i>40.0</i>	<i>40.2</i>	<i>54.0</i>	<i>-13.8</i>

Polarization	Frequency (MHz)	Reading (dBµV)	Pre-Amp Gain (dB)	Antenna Factor (dB)	Net at 3m - Peak (dBµV/m)	Peak Limit at 3m (dBµV/m)	Margin (dB)
<i>H</i>	<i>2390.000</i>	<i>55.9</i>	<i>33</i>	<i>29.4</i>	<i>52.3</i>	<i>74.0</i>	<i>-21.7</i>
<i>V</i>	<i>4824.000</i>	<i>42.5</i>	<i>33</i>	<i>34.9</i>	<i>44.4</i>	<i>74.0</i>	<i>-29.6</i>
<i>H</i>	<i>12060.000</i>	<i>42.3</i>	<i>33</i>	<i>40.5</i>	<i>49.8</i>	<i>74.0</i>	<i>-24.2</i>
<i>V</i>	<i>14472.000</i>	<i>43.3</i>	<i>33</i>	<i>40.0</i>	<i>50.3</i>	<i>74.0</i>	<i>-23.7</i>

- NOTES:
1. Peak detector is used for the emission measurement.
 2. Average detector is used for the average data of emission measurement.
 3. All measurements were made at 3 meters. Radiated emissions not detected at the 3-meter distance were measured at 0.3-meter and an inverse proportional extrapolation was performed to compare the signal level to the 3-meter limit. No other radiated emissions than those reported were detected at a test distance of 0.3-meter.
 4. Negative value in the margin column shows emission below limit.
 5. Horn antenna is used for the emission over 1000MHz.
 6. Emission (the row indicated by ***bold italic***) within the restricted band meets the requirement of FCC Part 15 Section 15.205 / RSS-Gen Section 8.10.

TEST REPORT

Mode: TX-Channel 06

Table 2
IEEE 802.11b (DSSS, 1 Mbps)

Polarization	Frequency (MHz)	Reading (dBμV)	Pre-Amp Gain (dB)	Antenna Factor (dB)	Net at 3m (dBμV/m)	Average Limit at 3m (dBμV/m)	Margin (dB)
<i>V</i>	<i>4874.000</i>	<i>32.7</i>	<i>33</i>	<i>34.9</i>	<i>34.6</i>	<i>54.0</i>	<i>-19.4</i>
<i>H</i>	<i>7311.000</i>	<i>28.3</i>	<i>33</i>	<i>37.9</i>	<i>33.2</i>	<i>54.0</i>	<i>-20.8</i>
<i>H</i>	<i>12185.000</i>	<i>30.8</i>	<i>33</i>	<i>40.5</i>	<i>38.3</i>	<i>54.0</i>	<i>-15.7</i>

Polarization	Frequency (MHz)	Reading (dBμV)	Pre-Amp Gain (dB)	Antenna Factor (dB)	Net at 3m - Peak (dBμV/m)	Peak Limit at 3m (dBμV/m)	Margin (dB)
<i>V</i>	<i>4874.000</i>	<i>42.7</i>	<i>33</i>	<i>34.9</i>	<i>44.6</i>	<i>74.0</i>	<i>-29.4</i>
<i>H</i>	<i>7311.000</i>	<i>37.3</i>	<i>33</i>	<i>37.9</i>	<i>42.2</i>	<i>74.0</i>	<i>-31.8</i>
<i>H</i>	<i>12185.000</i>	<i>42.0</i>	<i>33</i>	<i>40.5</i>	<i>49.5</i>	<i>74.0</i>	<i>-24.5</i>

- NOTES:
1. Peak detector is used for the emission measurement.
 2. Average detector is used for the average data of emission measurement
 3. All measurements were made at 3 meters. Radiated emissions not detected at the 3-meter distance were measured at 0.3-meter and an inverse proportional extrapolation was performed to compare the signal level to the 3-meter limit. No other radiated emissions than those reported were detected at a test distance of 0.3-meter.
 4. Negative value in the margin column shows emission below limit.
 5. Horn antenna is used for the emission over 1000MHz.
 6. Emission (the row indicated by ***bold italic***) within the restricted band meets the requirement of FCC Part 15 Section 15.205 / RSS-Gen Section 8.10.

TEST REPORT

Mode: TX-Channel 11

Table 3
IEEE 802.11b (DSSS, 1 Mbps)

Polarization	Frequency (MHz)	Reading (dBμV)	Pre-Amp Gain (dB)	Antenna Factor (dB)	Net at 3m (dBμV/m)	Average Limit at 3m (dBμV/m)	Margin (dB)
<i>H</i>	<i>2483.500</i>	<i>44.5</i>	<i>33</i>	<i>29.4</i>	<i>40.9</i>	<i>54.0</i>	<i>-13.1</i>
<i>V</i>	<i>4924.000</i>	<i>32.2</i>	<i>33</i>	<i>34.9</i>	<i>34.1</i>	<i>54.0</i>	<i>-19.9</i>
<i>H</i>	<i>7386.000</i>	<i>28.6</i>	<i>33</i>	<i>37.9</i>	<i>33.5</i>	<i>54.0</i>	<i>-20.5</i>
<i>H</i>	<i>12310.000</i>	<i>31.2</i>	<i>33</i>	<i>40.5</i>	<i>38.7</i>	<i>54.0</i>	<i>-15.3</i>

Polarization	Frequency (MHz)	Reading (dBμV)	Pre-Amp Gain (dB)	Antenna Factor (dB)	Net at 3m - Peak (dBμV/m)	Peak Limit at 3m (dBμV/m)	Margin (dB)
<i>H</i>	<i>2483.500</i>	<i>56.8</i>	<i>33</i>	<i>29.4</i>	<i>53.2</i>	<i>74.0</i>	<i>-20.8</i>
<i>V</i>	<i>4924.000</i>	<i>42.4</i>	<i>33</i>	<i>34.9</i>	<i>44.3</i>	<i>74.0</i>	<i>-29.7</i>
<i>H</i>	<i>7386.000</i>	<i>37.2</i>	<i>33</i>	<i>37.9</i>	<i>42.1</i>	<i>74.0</i>	<i>-31.9</i>
<i>H</i>	<i>12310.000</i>	<i>41.8</i>	<i>33</i>	<i>40.5</i>	<i>49.3</i>	<i>74.0</i>	<i>-24.7</i>

- NOTES:
1. Peak detector is used for the emission measurement.
 2. Average detector is used for the average data of emission measurement
 3. All measurements were made at 3 meters. Radiated emissions not detected at the 3-meter distance were measured at 0.3-meter and an inverse proportional extrapolation was performed to compare the signal level to the 3-meter limit. No other radiated emissions than those reported were detected at a test distance of 0.3-meter.
 4. Negative value in the margin column shows emission below limit.
 5. Horn antenna is used for the emission over 1000MHz.
 6. Emission (the row indicated by ***bold italic***) within the restricted band meets the requirement of FCC Part 15 Section 15.205 / RSS-Gen Section 8.10.

TEST REPORT

Mode: TX-Channel 01

Table 4
IEEE 802.11g (OFDM, 6 Mbps)

Polarization	Frequency (MHz)	Reading (dBμV)	Pre-Amp Gain (dB)	Antenna Factor (dB)	Net at 3m (dBμV/m)	Average Limit at 3m (dBμV/m)	Margin (dB)
<i>H</i>	<i>2390.000</i>	<i>44.4</i>	<i>33</i>	<i>29.4</i>	<i>40.8</i>	<i>54.0</i>	<i>-13.2</i>
<i>V</i>	<i>4824.000</i>	<i>30.6</i>	<i>33</i>	<i>34.9</i>	<i>32.5</i>	<i>54.0</i>	<i>-21.5</i>
<i>V</i>	<i>12060.000</i>	<i>29.3</i>	<i>33</i>	<i>40.5</i>	<i>36.8</i>	<i>54.0</i>	<i>-17.2</i>
<i>V</i>	<i>14472.000</i>	<i>30.4</i>	<i>33</i>	<i>40.0</i>	<i>37.4</i>	<i>54.0</i>	<i>-16.6</i>

Polarization	Frequency (MHz)	Reading (dBμV)	Pre-Amp Gain (dB)	Antenna Factor (dB)	Net at 3m - Peak (dBμV/m)	Peak Limit at 3m (dBμV/m)	Margin (dB)
<i>H</i>	<i>2390.000</i>	<i>59.0</i>	<i>33</i>	<i>29.4</i>	<i>55.4</i>	<i>74.0</i>	<i>-18.6</i>
<i>V</i>	<i>4824.000</i>	<i>38.5</i>	<i>33</i>	<i>34.9</i>	<i>40.4</i>	<i>74.0</i>	<i>-33.6</i>
<i>V</i>	<i>12060.000</i>	<i>38.2</i>	<i>33</i>	<i>40.5</i>	<i>45.7</i>	<i>74.0</i>	<i>-28.3</i>
<i>V</i>	<i>14472.000</i>	<i>39.8</i>	<i>33</i>	<i>40.0</i>	<i>46.8</i>	<i>74.0</i>	<i>-27.2</i>

- NOTES:
1. Peak detector is used for the emission measurement.
 2. Average detector is used for the average data of emission measurement
 3. All measurements were made at 3 meters. Radiated emissions not detected at the 3-meter distance were measured at 0.3-meter and an inverse proportional extrapolation was performed to compare the signal level to the 3-meter limit. No other radiated emissions than those reported were detected at a test distance of 0.3-meter.
 4. Negative value in the margin column shows emission below limit.
 5. Horn antenna is used for the emission over 1000MHz.
 6. Emission (the row indicated by ***bold italic***) within the restricted band meets the requirement of FCC Part 15 Section 15.205 / RSS-Gen Section 8.10.

TEST REPORT

Mode: TX-Channel 06

Table 5
IEEE 802.11g (OFDM, 6 Mbps)

Polarization	Frequency (MHz)	Reading (dBμV)	Pre-Amp Gain (dB)	Antenna Factor (dB)	Net at 3m (dBμV/m)	Average Limit at 3m (dBμV/m)	Margin (dB)
<i>V</i>	<i>4874.000</i>	<i>30.4</i>	<i>33</i>	<i>34.9</i>	<i>32.3</i>	<i>54.0</i>	<i>-21.7</i>
<i>H</i>	<i>7311.000</i>	<i>27.6</i>	<i>33</i>	<i>37.9</i>	<i>32.5</i>	<i>54.0</i>	<i>-21.5</i>
<i>V</i>	<i>12185.000</i>	<i>28.8</i>	<i>33</i>	<i>40.5</i>	<i>36.3</i>	<i>54.0</i>	<i>-17.7</i>

Polarization	Frequency (MHz)	Reading (dBμV)	Pre-Amp Gain (dB)	Antenna Factor (dB)	Net at 3m - Peak (dBμV/m)	Peak Limit at 3m (dBμV/m)	Margin (dB)
<i>V</i>	<i>4874.000</i>	<i>38.6</i>	<i>33</i>	<i>34.9</i>	<i>40.5</i>	<i>74.0</i>	<i>-33.5</i>
<i>H</i>	<i>7311.000</i>	<i>35.7</i>	<i>33</i>	<i>37.9</i>	<i>40.6</i>	<i>74.0</i>	<i>-33.4</i>
<i>V</i>	<i>12185.000</i>	<i>37.6</i>	<i>33</i>	<i>40.5</i>	<i>45.1</i>	<i>74.0</i>	<i>-28.9</i>

- NOTES:
1. Peak detector is used for the emission measurement.
 2. Average detector is used for the average data of emission measurement
 3. All measurements were made at 3 meters. Radiated emissions not detected at the 3-meter distance were measured at 0.3-meter and an inverse proportional extrapolation was performed to compare the signal level to the 3-meter limit. No other radiated emissions than those reported were detected at a test distance of 0.3-meter.
 4. Negative value in the margin column shows emission below limit.
 5. Horn antenna is used for the emission over 1000MHz.
 6. Emission (the row indicated by ***bold italic***) within the restricted band meets the requirement of FCC Part 15 Section 15.205 / RSS-Gen Section 8.10.

TEST REPORT

Mode: TX-Channel 11

Table 6
IEEE 802.11g (OFDM, 6 Mbps)

Polarization	Frequency (MHz)	Reading (dBμV)	Pre-Amp Gain (dB)	Antenna Factor (dB)	Net at 3m (dBμV/m)	Average Limit at 3m (dBμV/m)	Margin (dB)
<i>H</i>	<i>2483.500</i>	<i>47.6</i>	<i>33</i>	<i>29.4</i>	<i>44.0</i>	<i>54.0</i>	<i>-10.0</i>
<i>V</i>	<i>4924.000</i>	<i>30.4</i>	<i>33</i>	<i>34.9</i>	<i>32.3</i>	<i>54.0</i>	<i>-21.7</i>
<i>H</i>	<i>7386.000</i>	<i>27.3</i>	<i>33</i>	<i>37.9</i>	<i>32.2</i>	<i>54.0</i>	<i>-21.8</i>
<i>V</i>	<i>12310.000</i>	<i>29.0</i>	<i>33</i>	<i>40.5</i>	<i>36.5</i>	<i>54.0</i>	<i>-17.5</i>

Polarization	Frequency (MHz)	Reading (dBμV)	Pre-Amp Gain (dB)	Antenna Factor (dB)	Net at 3m - Peak (dBμV/m)	Peak Limit at 3m (dBμV/m)	Margin (dB)
<i>H</i>	<i>2483.500</i>	<i>71.0</i>	<i>33</i>	<i>29.4</i>	<i>67.4</i>	<i>74.0</i>	<i>-6.6</i>
<i>V</i>	<i>4924.000</i>	<i>38.8</i>	<i>33</i>	<i>34.9</i>	<i>40.7</i>	<i>74.0</i>	<i>-33.3</i>
<i>H</i>	<i>7386.000</i>	<i>35.5</i>	<i>33</i>	<i>37.9</i>	<i>40.4</i>	<i>74.0</i>	<i>-33.6</i>
<i>V</i>	<i>12310.000</i>	<i>37.9</i>	<i>33</i>	<i>40.5</i>	<i>45.4</i>	<i>74.0</i>	<i>-28.6</i>

- NOTES:
1. Peak detector is used for the emission measurement.
 2. Average detector is used for the average data of emission measurement
 3. All measurements were made at 3 meters. Radiated emissions not detected at the 3-meter distance were measured at 0.3-meter and an inverse proportional extrapolation was performed to compare the signal level to the 3-meter limit. No other radiated emissions than those reported were detected at a test distance of 0.3-meter.
 4. Negative value in the margin column shows emission below limit.
 5. Horn antenna is used for the emission over 1000MHz.
 6. Emission (the row indicated by ***bold italic***) within the restricted band meets the requirement of FCC Part 15 Section 15.205 / RSS-Gen Section 8.10.

TEST REPORT

Mode: TX-Channel 01

Table 7
IEEE 802.11n (20MHz) (OFDM, MCS0)

Polarization	Frequency (MHz)	Reading (dBμV)	Pre-Amp Gain (dB)	Antenna Factor (dB)	Net at 3m (dBμV/m)	Average Limit at 3m (dBμV/m)	Margin (dB)
<i>H</i>	<i>2390.000</i>	<i>43.9</i>	<i>33</i>	<i>29.4</i>	<i>40.3</i>	<i>54.0</i>	<i>-13.7</i>
<i>V</i>	<i>4824.000</i>	<i>30.2</i>	<i>33</i>	<i>34.9</i>	<i>32.1</i>	<i>54.0</i>	<i>-21.9</i>
<i>V</i>	<i>12060.000</i>	<i>30.8</i>	<i>33</i>	<i>40.5</i>	<i>38.3</i>	<i>54.0</i>	<i>-15.7</i>
<i>V</i>	<i>14472.000</i>	<i>32.4</i>	<i>33</i>	<i>40.0</i>	<i>39.4</i>	<i>54.0</i>	<i>-14.6</i>

Polarization	Frequency (MHz)	Reading (dBμV)	Pre-Amp Gain (dB)	Antenna Factor (dB)	Net at 3m - Peak (dBμV/m)	Peak Limit at 3m (dBμV/m)	Margin (dB)
<i>H</i>	<i>2390.000</i>	<i>63.2</i>	<i>33</i>	<i>29.4</i>	<i>59.6</i>	<i>74.0</i>	<i>-14.4</i>
<i>V</i>	<i>4824.000</i>	<i>40.7</i>	<i>33</i>	<i>34.9</i>	<i>42.6</i>	<i>74.0</i>	<i>-31.4</i>
<i>V</i>	<i>12060.000</i>	<i>40.4</i>	<i>33</i>	<i>40.5</i>	<i>47.9</i>	<i>74.0</i>	<i>-26.1</i>
<i>V</i>	<i>14472.000</i>	<i>42.6</i>	<i>33</i>	<i>40.0</i>	<i>49.6</i>	<i>74.0</i>	<i>-24.4</i>

- NOTES:
1. Peak detector is used for the emission measurement.
 2. Average detector is used for the average data of emission measurement
 3. All measurements were made at 3 meters. Radiated emissions not detected at the 3-meter distance were measured at 0.3-meter and an inverse proportional extrapolation was performed to compare the signal level to the 3-meter limit. No other radiated emissions than those reported were detected at a test distance of 0.3-meter.
 4. Negative value in the margin column shows emission below limit.
 5. Horn antenna is used for the emission over 1000MHz.
 6. Emission (the row indicated by ***bold italic***) within the restricted band meets the requirement of FCC Part 15 Section 15.205 / RSS-Gen Section 8.10.

TEST REPORT

Mode: TX-Channel 06

Table 8
IEEE 802.11n (20MHz) (OFDM, MCS0)

Polari- zation	Frequency (MHz)	Reading (dBµV)	Pre-Amp Gain (dB)	Antenna Factor (dB)	Net at 3m (dBµV/m)	Average Limit at 3m (dBµV/m)	Margin (dB)
<i>V</i>	<i>4874.000</i>	<i>30.4</i>	<i>33</i>	<i>34.9</i>	<i>32.3</i>	<i>54.0</i>	<i>-21.7</i>
<i>H</i>	<i>7311.000</i>	<i>28.5</i>	<i>33</i>	<i>37.9</i>	<i>33.4</i>	<i>54.0</i>	<i>-20.6</i>
<i>V</i>	<i>12185.000</i>	<i>31.2</i>	<i>33</i>	<i>40.5</i>	<i>38.7</i>	<i>54.0</i>	<i>-15.3</i>

Polari- zation	Frequency (MHz)	Reading (dBµV)	Pre-Amp Gain (dB)	Antenna Factor (dB)	Net at 3m - Peak (dBµV/m)	Peak Limit at 3m (dBµV/m)	Margin (dB)
<i>V</i>	<i>4874.000</i>	<i>40.5</i>	<i>33</i>	<i>34.9</i>	<i>42.4</i>	<i>74.0</i>	<i>-31.6</i>
<i>H</i>	<i>7311.000</i>	<i>37.9</i>	<i>33</i>	<i>37.9</i>	<i>42.8</i>	<i>74.0</i>	<i>-31.2</i>
<i>V</i>	<i>12185.000</i>	<i>39.6</i>	<i>33</i>	<i>40.5</i>	<i>47.1</i>	<i>74.0</i>	<i>-26.9</i>

- NOTES:
1. Peak detector is used for the emission measurement.
 2. Average detector is used for the average data of emission measurement
 3. All measurements were made at 3 meters. Radiated emissions not detected at the 3-meter distance were measured at 0.3-meter and an inverse proportional extrapolation was performed to compare the signal level to the 3-meter limit. No other radiated emissions than those reported were detected at a test distance of 0.3-meter.
 4. Negative value in the margin column shows emission below limit.
 5. Horn antenna is used for the emission over 1000MHz.
 6. Emission (the row indicated by ***bold italic***) within the restricted band meets the requirement of FCC Part 15 Section 15.205 / RSS-Gen Section 8.10.

TEST REPORT

Mode: TX-Channel 11

Table 9
IEEE 802.11n (20MHz) (OFDM, MCS0)

Polarization	Frequency (MHz)	Reading (dBμV)	Pre-Amp Gain (dB)	Antenna Factor (dB)	Net at 3m (dBμV/m)	Average Limit at 3m (dBμV/m)	Margin (dB)
<i>H</i>	<i>2483.500</i>	<i>46.4</i>	<i>33</i>	<i>29.4</i>	<i>42.8</i>	<i>54.0</i>	<i>-11.2</i>
<i>V</i>	<i>4924.000</i>	<i>30.8</i>	<i>33</i>	<i>34.9</i>	<i>32.7</i>	<i>54.0</i>	<i>-21.3</i>
<i>H</i>	<i>7386.000</i>	<i>28.9</i>	<i>33</i>	<i>37.9</i>	<i>33.8</i>	<i>54.0</i>	<i>-20.2</i>
<i>V</i>	<i>12310.000</i>	<i>30.7</i>	<i>33</i>	<i>40.5</i>	<i>38.2</i>	<i>54.0</i>	<i>-15.8</i>

Polarization	Frequency (MHz)	Reading (dBμV)	Pre-Amp Gain (dB)	Antenna Factor (dB)	Net at 3m - Peak (dBμV/m)	Peak Limit at 3m (dBμV/m)	Margin (dB)
<i>H</i>	<i>2483.500</i>	<i>71.3</i>	<i>33</i>	<i>29.4</i>	<i>67.7</i>	<i>74.0</i>	<i>-6.3</i>
<i>V</i>	<i>4924.000</i>	<i>40.2</i>	<i>33</i>	<i>34.9</i>	<i>42.1</i>	<i>74.0</i>	<i>-31.9</i>
<i>H</i>	<i>7386.000</i>	<i>37.7</i>	<i>33</i>	<i>37.9</i>	<i>42.6</i>	<i>74.0</i>	<i>-31.4</i>
<i>V</i>	<i>12310.000</i>	<i>39.9</i>	<i>33</i>	<i>40.5</i>	<i>47.4</i>	<i>74.0</i>	<i>-26.6</i>

- NOTES:
1. Peak detector is used for the emission measurement.
 2. Average detector is used for the average data of emission measurement
 3. All measurements were made at 3 meters. Radiated emissions not detected at the 3-meter distance were measured at 0.3-meter and an inverse proportional extrapolation was performed to compare the signal level to the 3-meter limit. No other radiated emissions than those reported were detected at a test distance of 0.3-meter.
 4. Negative value in the margin column shows emission below limit.
 5. Horn antenna is used for the emission over 1000MHz.
 6. Emission (the row indicated by ***bold italic***) within the restricted band meets the requirement of FCC Part 15 Section 15.205 / RSS-Gen Section 8.10.

TEST REPORT

Mode: TX-Channel 03

Table 10
IEEE 802.11n (40MHz) (OFDM, MCS0)

Polarization	Frequency (MHz)	Reading (dBμV)	Pre-Amp Gain (dB)	Antenna Factor (dB)	Net at 3m (dBμV/m)	Average Limit at 3m (dBμV/m)	Margin (dB)
<i>H</i>	<i>2390.000</i>	<i>43.7</i>	<i>33</i>	<i>29.4</i>	<i>40.1</i>	<i>54.0</i>	<i>-13.9</i>
<i>H</i>	<i>4844.000</i>	<i>30.3</i>	<i>33</i>	<i>34.9</i>	<i>32.2</i>	<i>54.0</i>	<i>-21.8</i>
<i>H</i>	<i>7266.000</i>	<i>28.4</i>	<i>33</i>	<i>37.9</i>	<i>33.3</i>	<i>54.0</i>	<i>-20.7</i>
<i>V</i>	<i>12110.000</i>	<i>30.2</i>	<i>33</i>	<i>40.5</i>	<i>37.7</i>	<i>54.0</i>	<i>-16.3</i>

Polarization	Frequency (MHz)	Reading (dBμV)	Pre-Amp Gain (dB)	Antenna Factor (dB)	Net at 3m - Peak (dBμV/m)	Peak Limit at 3m (dBμV/m)	Margin (dB)
<i>H</i>	<i>2390.000</i>	<i>62.9</i>	<i>33</i>	<i>29.4</i>	<i>59.3</i>	<i>74.0</i>	<i>-14.7</i>
<i>H</i>	<i>4844.000</i>	<i>39.9</i>	<i>33</i>	<i>34.9</i>	<i>41.8</i>	<i>74.0</i>	<i>-32.2</i>
<i>H</i>	<i>7266.000</i>	<i>37.8</i>	<i>33</i>	<i>37.9</i>	<i>42.7</i>	<i>74.0</i>	<i>-31.3</i>
<i>V</i>	<i>12110.000</i>	<i>38.2</i>	<i>33</i>	<i>40.5</i>	<i>45.7</i>	<i>74.0</i>	<i>-28.3</i>

- NOTES:
1. Peak detector is used for the emission measurement.
 2. Average detector is used for the average data of emission measurement
 3. All measurements were made at 3 meters. Radiated emissions not detected at the 3-meter distance were measured at 0.3-meter and an inverse proportional extrapolation was performed to compare the signal level to the 3-meter limit. No other radiated emissions than those reported were detected at a test distance of 0.3-meter.
 4. Negative value in the margin column shows emission below limit.
 5. Horn antenna is used for the emission over 1000MHz.
 6. Emission (the row indicated by ***bold italic***) within the restricted band meets the requirement of FCC Part 15 Section 15.205 / RSS-Gen Section 8.10.

TEST REPORT

Mode: TX-Channel 06

Table 11
IEEE 802.11n (40MHz) (OFDM, MCS0)

Polarization	Frequency (MHz)	Reading (dBμV)	Pre-Amp Gain (dB)	Antenna Factor (dB)	Net at 3m (dBμV/m)	Average Limit at 3m (dBμV/m)	Margin (dB)
<i>H</i>	<i>4874.000</i>	<i>30.6</i>	<i>33</i>	<i>34.9</i>	<i>32.5</i>	<i>54.0</i>	<i>-21.5</i>
<i>H</i>	<i>7311.000</i>	<i>28.9</i>	<i>33</i>	<i>37.9</i>	<i>33.8</i>	<i>54.0</i>	<i>-20.2</i>
<i>V</i>	<i>12185.000</i>	<i>30.1</i>	<i>33</i>	<i>40.5</i>	<i>37.6</i>	<i>54.0</i>	<i>-16.4</i>

Polarization	Frequency (MHz)	Reading (dBμV)	Pre-Amp Gain (dB)	Antenna Factor (dB)	Net at 3m - Peak (dBμV/m)	Peak Limit at 3m (dBμV/m)	Margin (dB)
<i>H</i>	<i>4874.000</i>	<i>39.4</i>	<i>33</i>	<i>34.9</i>	<i>41.3</i>	<i>74.0</i>	<i>-32.7</i>
<i>H</i>	<i>7311.000</i>	<i>37.7</i>	<i>33</i>	<i>37.9</i>	<i>42.6</i>	<i>74.0</i>	<i>-31.4</i>
<i>V</i>	<i>12185.000</i>	<i>37.8</i>	<i>33</i>	<i>40.5</i>	<i>45.3</i>	<i>74.0</i>	<i>-28.7</i>

- NOTES:
1. Peak detector is used for the emission measurement.
 2. Average detector is used for the average data of emission measurement
 3. All measurements were made at 3 meters. Radiated emissions not detected at the 3-meter distance were measured at 0.3-meter and an inverse proportional extrapolation was performed to compare the signal level to the 3-meter limit. No other radiated emissions than those reported were detected at a test distance of 0.3-meter.
 4. Negative value in the margin column shows emission below limit.
 5. Horn antenna is used for the emission over 1000MHz.
 6. Emission (the row indicated by ***bold italic***) within the restricted band meets the requirement of FCC Part 15 Section 15.205 / RSS-Gen Section 8.10.
 7. .

TEST REPORT

Mode: TX-Channel 09

Table 12
IEEE 802.11n (40MHz) (OFDM, MCS0)

Polarization	Frequency (MHz)	Reading (dBμV)	Pre-Amp Gain (dB)	Antenna Factor (dB)	Net at 3m (dBμV/m)	Average Limit at 3m (dBμV/m)	Margin (dB)
<i>H</i>	<i>2483.500</i>	<i>46.3</i>	<i>33</i>	<i>29.4</i>	<i>42.7</i>	<i>54.0</i>	<i>-11.3</i>
<i>H</i>	<i>4904.000</i>	<i>30.5</i>	<i>33</i>	<i>34.9</i>	<i>32.4</i>	<i>54.0</i>	<i>-21.6</i>
<i>H</i>	<i>7356.000</i>	<i>28.3</i>	<i>33</i>	<i>37.9</i>	<i>33.2</i>	<i>54.0</i>	<i>-20.8</i>
<i>V</i>	<i>12260.000</i>	<i>29.7</i>	<i>33</i>	<i>40.5</i>	<i>37.2</i>	<i>54.0</i>	<i>-16.8</i>

Polarization	Frequency (MHz)	Reading (dBμV)	Pre-Amp Gain (dB)	Antenna Factor (dB)	Net at 3m - Peak (dBμV/m)	Peak Limit at 3m (dBμV/m)	Margin (dB)
<i>H</i>	<i>2483.500</i>	<i>67.8</i>	<i>33</i>	<i>29.4</i>	<i>64.2</i>	<i>74.0</i>	<i>-9.8</i>
<i>H</i>	<i>4904.000</i>	<i>39.3</i>	<i>33</i>	<i>34.9</i>	<i>41.2</i>	<i>74.0</i>	<i>-32.8</i>
<i>H</i>	<i>7356.000</i>	<i>38.0</i>	<i>33</i>	<i>37.9</i>	<i>42.9</i>	<i>74.0</i>	<i>-31.1</i>
<i>V</i>	<i>12260.000</i>	<i>37.7</i>	<i>33</i>	<i>40.5</i>	<i>45.2</i>	<i>74.0</i>	<i>-28.8</i>

- NOTES:
1. Peak detector is used for the emission measurement.
 2. Average detector is used for the average data of emission measurement
 3. All measurements were made at 3 meters. Radiated emissions not detected at the 3-meter distance were measured at 0.3-meter and an inverse proportional extrapolation was performed to compare the signal level to the 3-meter limit. No other radiated emissions than those reported were detected at a test distance of 0.3-meter.
 4. Negative value in the margin column shows emission below limit.
 5. Horn antenna is used for the emission over 1000MHz.
 6. Emission (the row indicated by ***bold italic***) within the restricted band meets the requirement of FCC Part 15 Section 15.205 / RSS-Gen Section 8.10.

TEST REPORT

Mode: Live mode with Music Playing

Table 14

Polarization	Frequency (MHz)	Reading (dBµV)	Pre-amp (dB)	Antenna Factor (dB)	Net at 3m (dBµV/m)	Limit at 3m (dBµV/m)	Margin (dB)
V	35.941	40.1	16	10.0	34.1	40.0	-5.9
H	55.947	42.5	16	11.0	37.5	40.0	-2.5
V	77.287	45.0	16	6.0	35.0	40.0	-5.0
V	119.967	38.5	16	14.0	36.5	43.5	-7.0
V	170.165	35.9	16	18.0	37.9	43.5	-5.6
V	194.900	35.8	16	16.0	35.8	43.5	-7.7
V	249.947	35.3	16	20.0	39.3	46.0	-6.7

- NOTES:
1. Peak detector is used for the emission measurement.
 2. All measurements were made at 3 meters. Radiated emissions not detected at the 3-meter distance were measured at 0.3-meter and an inverse proportional extrapolation was performed to compare the signal level to the 3-meter limit. No other radiated emissions than those reported were detected at a test distance of 0.3-meter.
 3. Negative value in the margin column shows emission below limit.
 4. Emission (the row indicated by ***bold italic***) within the restricted band meets the requirement of FCC Part 15 Section 15.205 / RSS-Gen Section 8.10.

TEST REPORT

4.6.3 Radiated Emission Test Setup

The figure below shows the test setup, which is utilized to make these measurements.

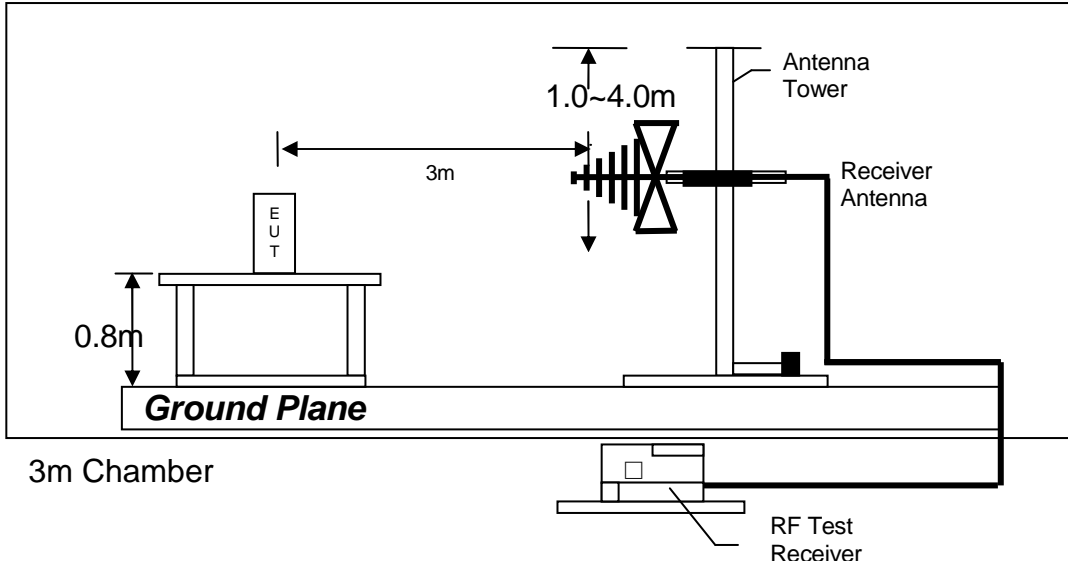

Test setup of radiated emissions up to 1GHz

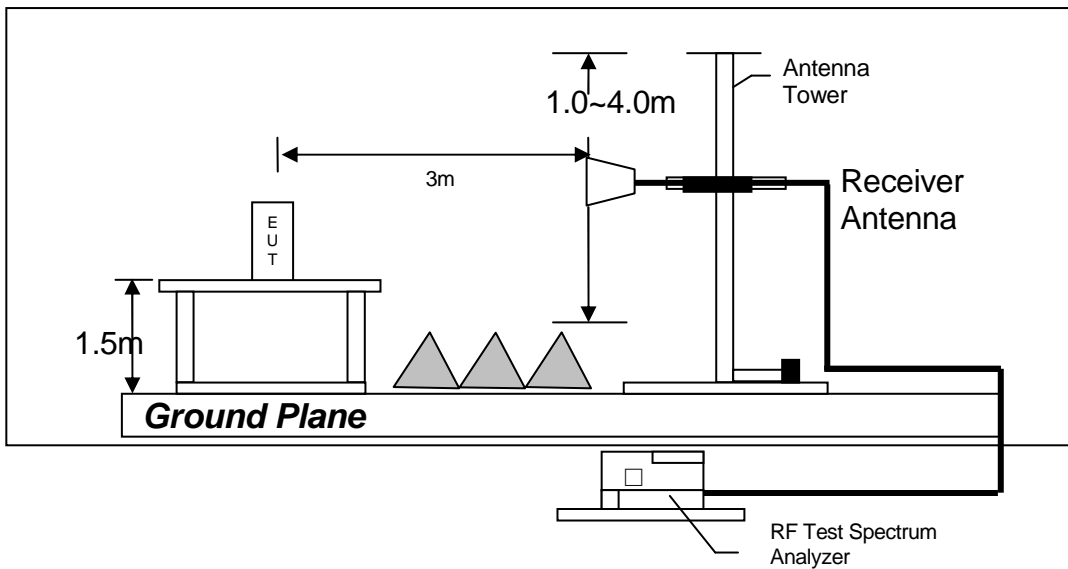

Test setup of radiated emissions above 1GHz

TEST REPORT

4.6.4 Transmitter Duty Cycle Calculation

Not applicable – No average factor is required.

TEST REPORT**4.7 AC Power Line Conducted Emission**

- Not applicable – EUT is only powered by battery for operation.
- EUT connects to AC power line. Emission Data is listed in following pages.

- Base Unit connects to AC power line and has transmission. Handset connects to AC power line but has no transmission. Emission Data of Base Unit is listed in following pages.

4.7.1 AC Power Line Conducted Emission Configuration Photograph

Worst Case Line-Conducted Configuration
at

10.293 MHz

The worst case line conducted configuration photographs are attached in the Appendix and saved with filename: config photos.pdf

4.7.2 AC Power Line Conducted Emission Data

The plot(s) and data in the following pages list the significant emission frequencies, the limit and the margin of compliance.

Passed by 16.27 dB margin compare with CISPR Average limit

TEST REPORT

AC POWER LINE CONDUCTED EMISSION

Worst Case: Live mode with music Playing



RBW 9 kHz

MT 1 s

Att 10 dB AUTO PREAMP OFF

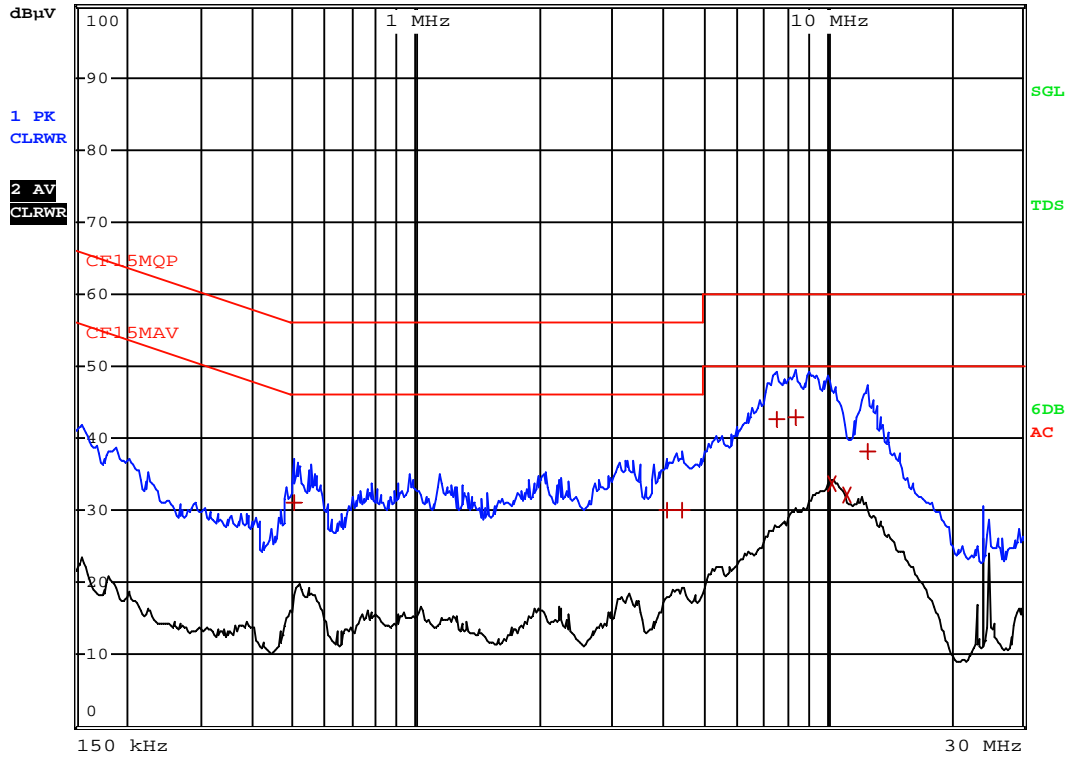

TEST REPORT

Worst Case: Live mode with music Playing

EDIT PEAK LIST (Final Measurement Results)				
Trace1:	CF15MQP			
Trace2:	CF15MAV			
Trace3:	---			
TRACE	FREQUENCY	LEVEL dBµV		DELTA LIMIT dB
1 Quasi Peak	505.5 kHz	31.00 N		-24.99
1 Quasi Peak	4.074 MHz	30.05 N		-25.95
1 Quasi Peak	4.4655 MHz	30.04 N		-25.95
1 Quasi Peak	7.584 MHz	42.68 N		-17.31
1 Quasi Peak	8.412 MHz	42.86 L1		-17.13
2 CISPR Average	10.293 MHz	33.72 N		-16.27
2 CISPR Average	11.121 MHz	32.10 N		-17.89
1 Quasi Peak	12.516 MHz	38.29 N		-21.70

TEST REPORT

4.7.3 Conducted Emission Test Setup

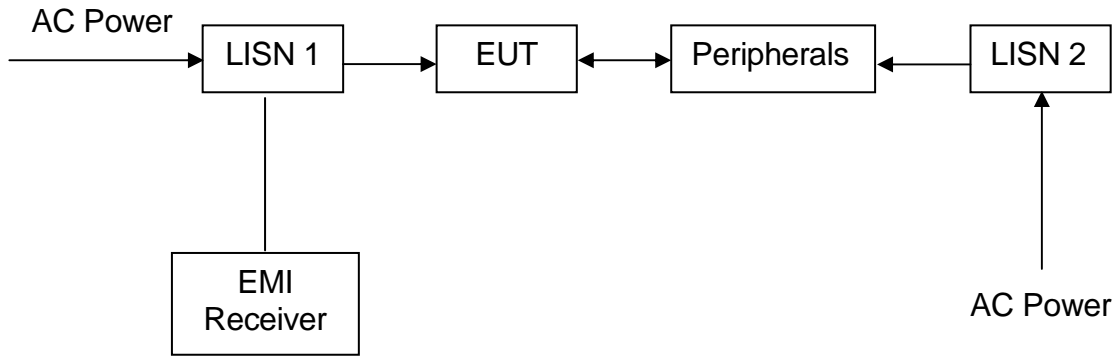

TEST REPORT

EXHIBIT 5 EQUIPMENT LIST

5.0 EQUIPMENT LIST

1) Radiated Emissions Test

Equipment	Biconical Antenna	EMI Test Receiver (9kHz to 26.5GHz)	Double Ridged Guide Antenna
Registration No.	EW-0571	EW-3156	EW-0194
Manufacturer	EMCO	ROHDESCHWARZ	EMCO
Model No.	3104C	ESR26	3115
Calibration Date	May. 18, 2016	Dec. 06, 2016	Aug. 10, 2016
Calibration Due Date	Nov. 18, 2017	Dec. 06, 2017	Feb. 10, 2018

Equipment	Log Periodic Antenna	Spectrum Analyzer
Registration No.	EW-0447	EW-2249
Manufacturer	EMCO	R&S
Model No.	3146	FSP30
Calibration Date	May. 18, 2016	Dec. 23, 2016
Calibration Due Date	Nov. 18, 2017	Nov. 27, 2017

Equipment	Active Loop H-field (9kHz to 30MHz)	RF Cable 9kHz to 1000MHz	RF Cable (up to 40GHz)
Registration No.	EW-2313	EW-3170	EW-3155
Manufacturer	ELECTROMETRI	N/A	N/A
Model No.	EM-6876	9kHz to 1000MHz	1-40 GHz
Calibration Date	May. 18, 2016	Mar. 20, 2017	Dec. 05, 2016
Calibration Due Date	Nov. 18, 2017	Mar. 20, 2018	Dec. 05, 2017

Equipment	Solid State Low Noise Pre-amplifier Assembly (1 - 18)GHz	RF Pre-amplifier 3 pcs (9kHz to 40GHz)	Notch Filter (cutoff frequency 2.4GHz to 2.5GHz)
Registration No.	EW-3229	EW-3006	EW-3155
Manufacturer	BONN ELEKTRO	SCHWARZBECK	MICROTRONICS
Model No.	BLMA 0118-5G	BBV 9744	BRM50701-02
Calibration Date	Oct. 24, 2016	Mar. 23, 2017	May. 26, 2017
Calibration Due Date	Oct. 24, 2017	Mar. 23, 2018	May. 26, 2018

2) Conducted Emissions Test

Equipment	EMI Test Receiver	RF Cable 9kHz to 1000MHz	LISN
Registration No.	EW-3156	EW-3170	EW-2874
Manufacturer	ROHDESCHWARZ	N/A	R&S
Model No.	ESR26	9kHz to 1000MHz	ENV-216
Calibration Date	Dec. 06, 2016	Mar. 20, 2017	Mar. 16, 2017
Calibration Due Date	Dec. 06, 2017	Mar. 20, 2018	Mar. 16, 2018

TEST REPORT

3) Conductive Measurement Test

Equipment	Spectrum Analyzer	RF Cable (up to 40GHz) 1.5m length	RF Power Meter with Power Sensor (N1921A)
Registration No.	EW-2249	EW-3104	EW-2270
Manufacturer	R&S	N/A	AGILENTTECH
Model No.	FSP30	SMA-M to SMA-M	N1911A
Calibration Date	Dec. 23, 2016	Feb. 28, 2017	Jan. 04, 2017
Calibration Due Date	Nov, 27. 2017	Feb. 28, 2018	Jan. 04, 2018

- End of Report -