



**FCC 47 CFR PART 15 SUBPART C**

**TEST REPORT**

**For**

**Bluetooth Speaker**

**Model: AWSBT 6,AWSBT 7, AWSBT 8**

**Brand: Acoustic Research**

**Test Report Number:**

**C160331Z07-RP1**

*Prepared for*

**Voxx Accessories Corp.**

**3502 Woodview Trace,Suite 220 Indianapolis, Indiana.United States  
46268**

*Prepared by*

**COMPLIANCE CERTIFICATION SERVICES (SHENZHEN) INC.**

**No.10-1, Mingkeda Logistics Park, No.18, Huanguan South Rd.,  
Guan Lan Town, Baoan District, Shenzhen China**

**TEL: 86-755-28055000**

**FAX: 86-755-28055221**

**Issued Date: May 23, 2016**

**E-Mail: [service@ccssz.com](mailto:service@ccssz.com)**



TESTING CERT #2861.01

**Note:** This report shall not be reproduced except in full, without the written approval of Compliance Certification Services (Shenzhen) Inc. This document may be altered or revised by Compliance Certification Services (Shenzhen) Inc. personnel only, and shall be noted in the revision section of the document. The client should not use it to claim product endorsement by TAF, A2LA, NVLAP, NIST, CNAS or any government agencies. The test result of this report relate only to the tested sample identified in this report.



Revision History

Rev.	Issue Date	Revisions	Effect Page	Revised By
00	May 23, 2016	Initial Issue	ALL	Amzula Chen



**TABLE OF CONTENTS**

**1. TEST RESULT CERTIFICATION .....4**

**2. EUT DESCRIPTION.....5**

**3. TEST METHODOLOGY.....6**

    3.1 DESCRIPTION OF TEST MODES.....6

**4. FACILITIES AND ACCREDITATIONS .....7**

    4.1 FACILITIES.....7

    4.2 ACCREDITATIONS .....7

    4.3 MEASUREMENT UNCERTAINTY.....7

**5. SETUP OF EQUIPMENT UNDER TEST .....8**

    5.1 SETUP CONFIGURATION OF EUT .....8

    5.2 SUPPORT EQUIPMENT .....8

**6. FCC PART 15.247 REQUIREMENTS .....9**

    6.1 20DB BANDWIDTH .....9

    6.2 ANTENNA GAIN .....14

    6.3 PEAK POWER .....15

    6.4 PEAK POWER SPECTRAL DENSITY .....17

    6.5 BAND EDGES MEASUREMENT .....18

    6.6 FREQUENCY SEPARATION .....28

    6.7 NUMBER OF HOPPING FREQUENCY .....31

    6.8 TIME OF OCCUPANCY (DWELL TIME).....33

    6.9 SPURIOUS EMISSIONS .....40

    6.10 POWERLINE CONDUCTED EMISSIONS.....58



# 1. TEST RESULT CERTIFICATION

<b>Product:</b>	Bluetooth Speaker
<b>Model:</b>	AWSBT 6,AWSBT 7, AWSBT 8
<b>Brand:</b>	Acoustic Research
<b>Tested:</b>	March 31~May 20, 2016
<b>Applicant:</b>	<b>Voxx Accessories Corp.</b> 3502 Woodview Trace,Suite 220 Indianapolis, Indiana.United States 46268
<b>Manufacturer:</b>	<b>Uni-Art Precise Products Ltd</b> 11-12/F, Yue Xiu Industrial Building, 87 Hung To Road, Kowloon,Hong kong

APPLICABLE STANDARDS	
STANDARD	TEST RESULT
FCC 47 CFR Part 15 Subpart C	No non-compliance noted

### We hereby certify that:

The above equipment was tested by Compliance Certification Services (Shenzhen) Inc. The test data, data evaluation, test procedures, and equipment configurations shown in this report were made in accordance with the procedures given in ANSI C63.10:2013 and the energy emitted by the sample EUT tested as described in this report is in compliance with conducted and radiated emission limits of FCC Rules Part 15.207, 15.209 and 15.247.

The test results of this report relate only to the tested sample EUT identified in this report.

**Approved by:**

---

**Sunday Hu**  
Supervisor of EMC Dept.  
Compliance Certification Services  
(Shenzhen) Inc.

**Reviewed by:**

---

**Ruby Zhang**  
Supervisor of Report Dept.  
Compliance Certification Services  
(Shenzhen) Inc.



## 2. EUT DESCRIPTION

<b>Product</b>	Bluetooth Speaker
<b>Model Number</b>	AWSBT 6,AWSBT 7, AWSBT 8
<b>Brand</b>	Acoustic Research
<b>Model Discrepancy</b>	They are same product except product model name.
<b>Identify Number</b>	C160331Z07-RP1
<b>Received Date</b>	March 31, 2016
<b>Power Supply</b>	DC10V supplied by the adapter or DC9.0V supplied by the Dry Cell
<b>Adapter Manufacturer /Model No.</b>	Dongguan Yinli Electronics Co., Ltd. / YLS0241A-T100150 INPUT: 100-240VAC, 50/60Hz, 0.8A Max OUTPUT : 10.0VDC, 1.5 A DC Cable: Unshielded, 1.80m
<b>Frequency Range</b>	2402 ~ 2480 MHz
<b>Transmit Power</b>	GFSK : -4.11dBm $\pi/4$ -DQPSK: -4.15dBm 8DPSK : -4.27dBm
<b>Modulation Technique</b>	FHSS (GFSK for 1Mbps, $\pi/4$ -DQPSK for 2Mbps, 8DPSK for 3Mbps)
<b>Number of Channels</b>	79 Channels
<b>Antenna Specification</b>	PCB antenna with 0dBi gain (Max)
<b>Temperature Range</b>	-10°C~+55°C
<b>Hardware Version</b>	VER04
<b>Software Version</b>	F6188V40

**Note:** This submittal(s) (test report) is intended for FCC ID: VIXAUDAWSBTRXV01 filing to comply with Section 15.207, 15.209 and 15.247 of the FCC Part 15, Subpart C Rules.



### 3. TEST METHODOLOGY

#### 3.1 DESCRIPTION OF TEST MODES

The EUT has been tested under operating condition.

Test program used to control the EUT for staying in continuous transmitting and receiving mode is programmed.

Test Item	Test mode	Worse mode
Conducted Emission	<b>Mode 1:</b> Adapter + AUX PLAY	<input checked="" type="checkbox"/>
Radiated Emission	<b>Mode 1:</b> TX	<input checked="" type="checkbox"/>

Channel Low (2402MHz) 、Mid (2441MHz) and High (2480MHz) were chosen for pre-testing for GFSK 、 $\pi/4$ -DQPSK and 8DPSK, GFSK and 8DPSK were the worse case and print in the report.



## 4. FACILITIES AND ACCREDITATIONS

### 4.1 FACILITIES

All measurement facilities used to collect the measurement data are located at

- No.10-1, Mingkeda Logistics Park, No.18, Huanguan South Rd., Guan Lan Town, Baoan District, Shenzhen, China**

The sites are constructed in conformance with the requirements of ANSI C63.10:2013, ANSI C63.7 and CISPR Publication 22. All receiving equipment conforms to CISPR Publication 16-1, "Radio Interference Measuring Apparatus and Measurement Methods."

### 4.2 ACCREDITATIONS

Our laboratories are accredited and approved by the following accreditation body according to ISO/IEC 17025.

<b>USA</b>	A2LA
<b>China</b>	CNAS

The measuring facility of laboratories has been authorized or registered by the following approval agencies.

<b>USA</b>	FCC
<b>Japan</b>	VCCI(C-4815,R-4320,T-2317, G-10624)
<b>Canada</b>	INDUSTRY CANADA

Copies of granted accreditation certificates are available for downloading from our web site, <http://www.ccssz.com>

### 4.3 MEASUREMENT UNCERTAINTY

Where relevant, the following measurement uncertainty levels have been estimated for tests performed on the EUT as specified in CISPR 16-4-2:

Parameter	Uncertainty
Radiated Emission, 30 to 200 MHz Test Site : 966(2)	+/-3.6880dB
Radiated Emission, 200 to 1000 MHz Test Site : 966(2)	+/-3.6695dB
Radiated Emission, 1 to 8 GHz	+/-5.1782dB
Radiated Emission, 8 to 18 GHz	+/-5.2173dB
Conducted Emissions	+/-3.6836dB
Band Width	178kHz
Peak Output Power MU	+/-1.906dB
Band Edge MU	+/-0.182dB
Channel Separation MU	416.178Hz
Duty Cycle MU	0.054ms
Frequency Stability MU	226Hz

This uncertainty represents an expanded uncertainty expressed at approximately the 95% confidence level using a coverage factor of k=2.

The measured result is above (below) the specification limit by a margin less than the measurement uncertainty; it is therefore not possible to state compliance based on the 95% level of confidence. However, the result indicates that compliance (non-compliance) is more probable than non-compliance) with the specification limit.



## 5. SETUP OF EQUIPMENT UNDER TEST

### 5.1 SETUP CONFIGURATION OF EUT

See test photographs attached in Appendix 1 for the actual connections between EUT and support equipment.

### 5.2 SUPPORT EQUIPMENT

No.	Equipment	Model No.	Serial No.	FCC	Brand	Data Cable	Power Cord
1	N/A						

**Notes:**

*Grounding was established in accordance with the manufacturer's requirements and conditions for the intended use.*





## 6. FCC PART 15.247 REQUIREMENTS

### 6.1 20DB BANDWIDTH

None; for reporting purpose only.

### MEASUREMENT EQUIPMENT USED

Name of Equipment	Manufacturer	Model	Serial Number	Last Calibration	Due Calibration
Spectrum Analyzer	Agilent	E4446A	US44300399	02/21/2016	02/20/2017

*Remark: Each piece of equipment is scheduled for calibration once a year.*

### TEST CONFIGURATION

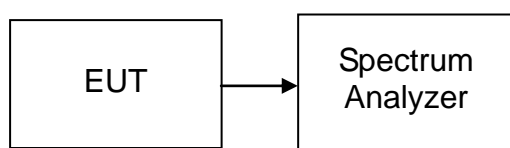

### TEST PROCEDURE

1. Place the EUT on the table and set it in the transmitting mode.
2. Remove the antenna from the EUT, then connect a low loss RF cable from antenna port to the spectrum analyzer.
3. Set the spectrum analyzer as RBW=30kHz, VBW=100kHz, Span=3MHz, Sweep = auto.
4. Mark the peak frequency and 20dB (upper and lower) frequency.
5. Repeat until all the test channels are investigated.

### TEST RESULTS

No non-compliance noted



**Test plot**

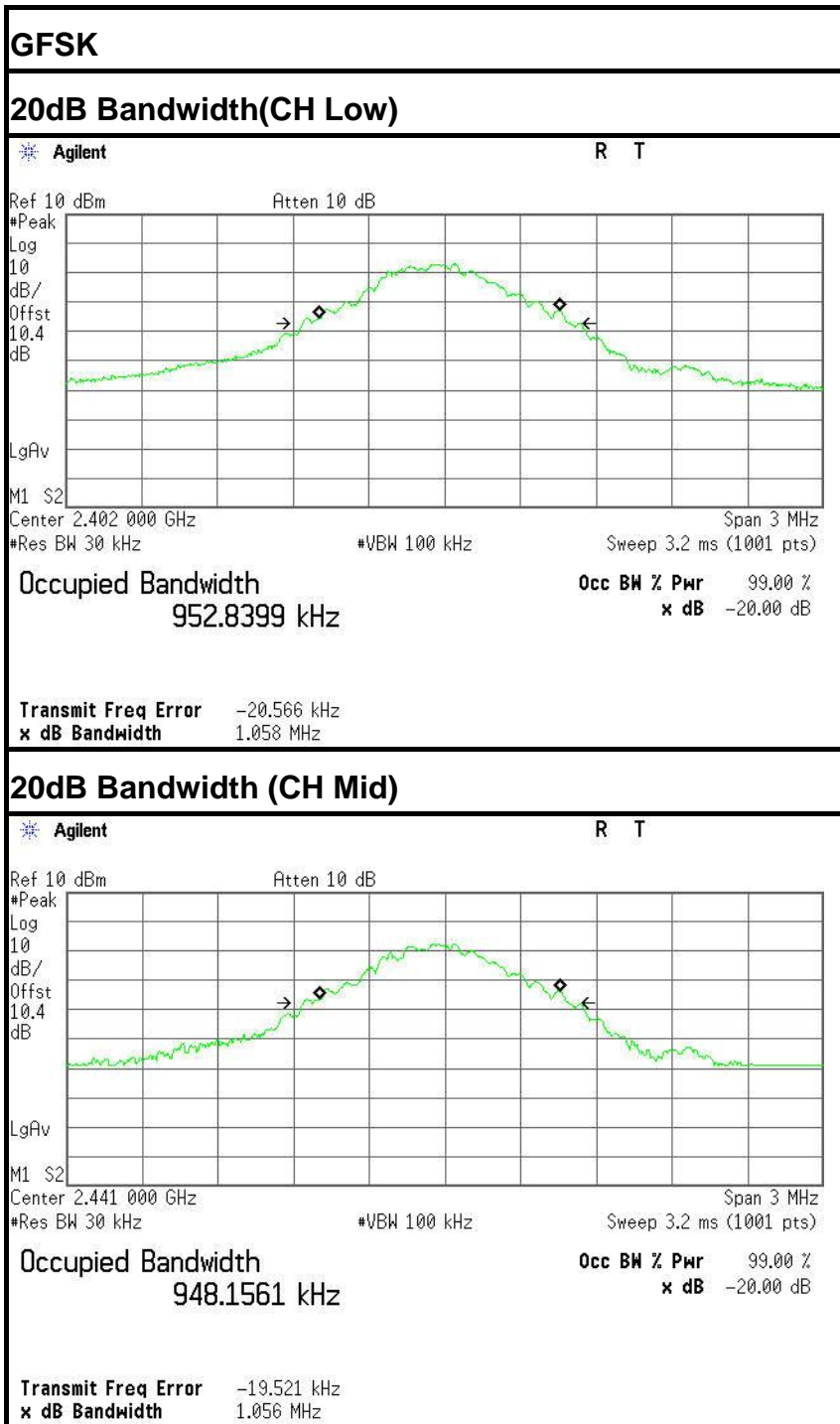

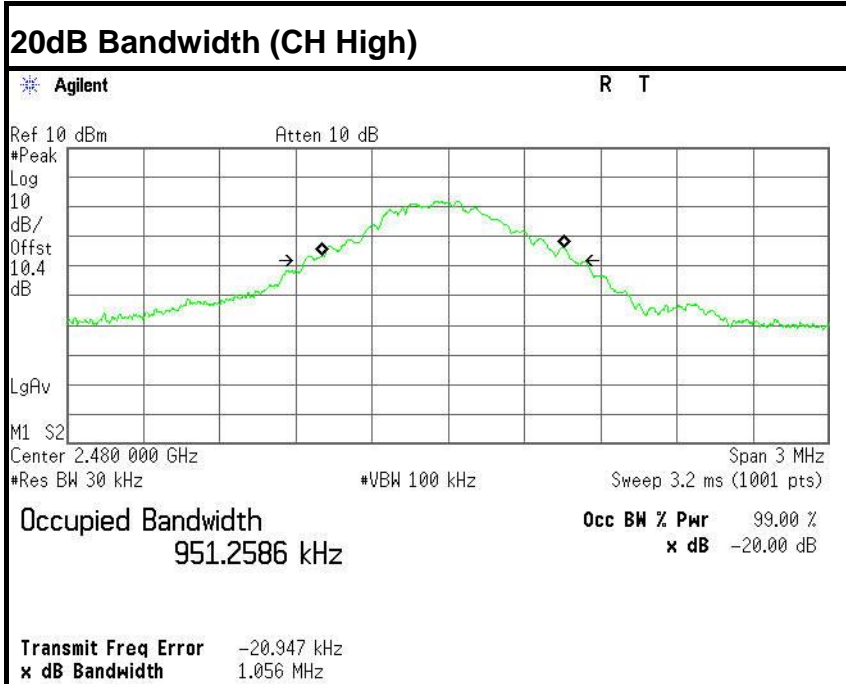



**Test plot**

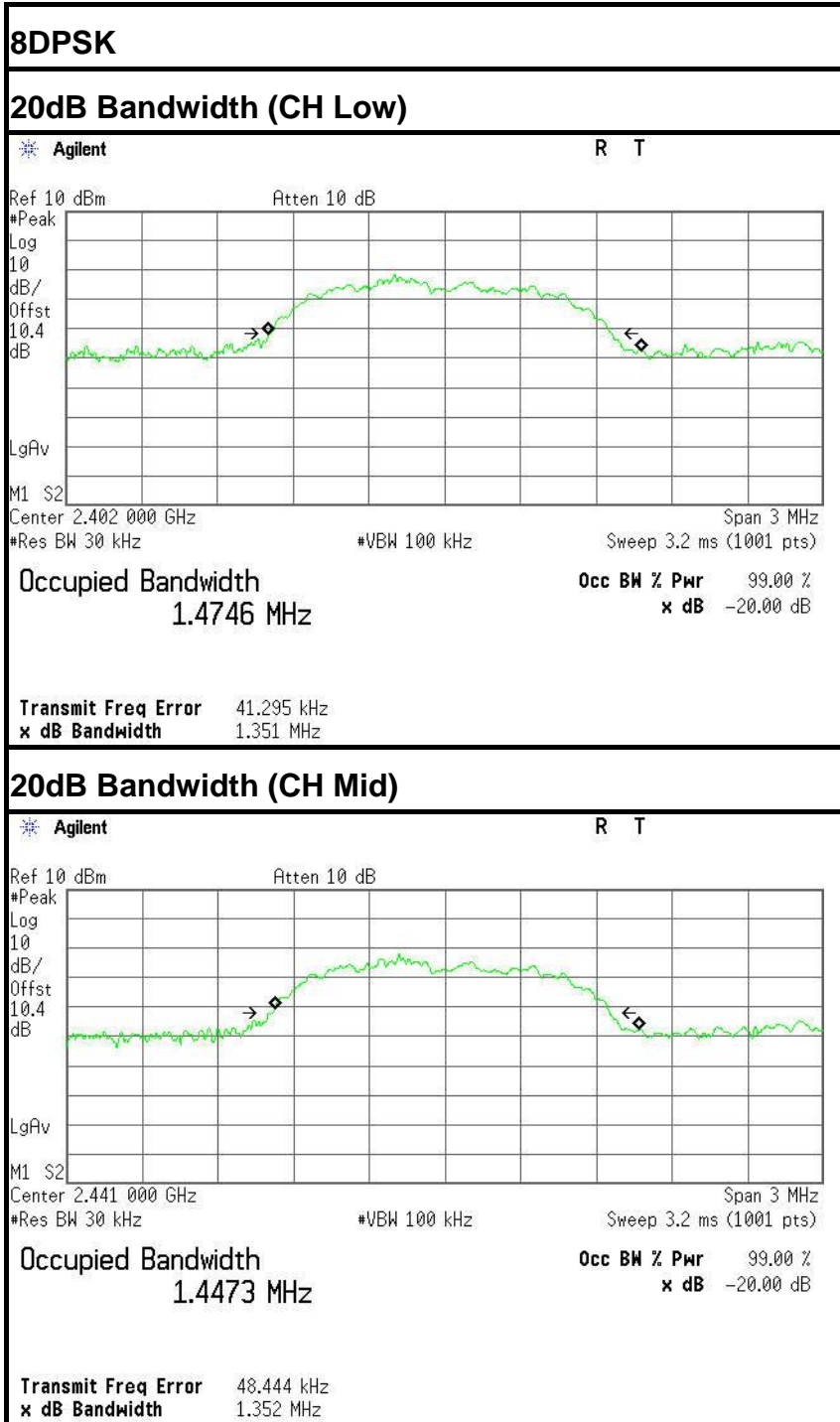

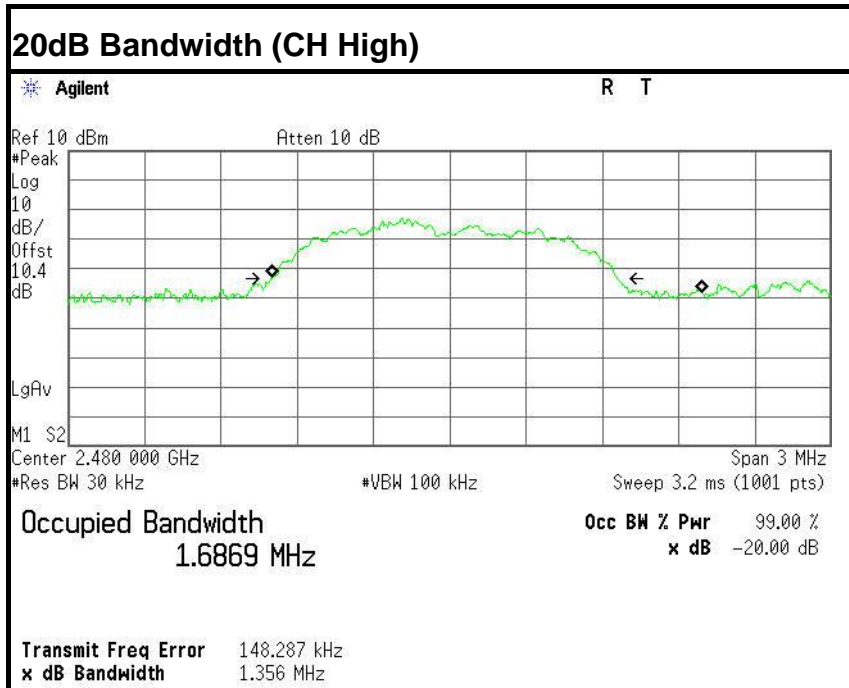



## 6.2 ANTENNA GAIN

### MEASUREMENT

The antenna gain of the complete system is calculated by the difference of radiated power in EIRP and the conducted power of the module. For normal BT devices, the GFSK mode is used.

### MEASUREMENT PARAMETERS

Measurement parameter	
Detector	Peak
Sweep time	Auto
Resolution bandwidth	3 MHz
Video bandwidth	3 MHz
Trace-Mode	Max hold

### LIMITS

FCC	IC
Antenna Gain	
6 dBi	

### TEST RESULTS

#### GFSK

T <sub>nom</sub>	V <sub>nom</sub>	Lowest channel 2402MHz	Middle channel 2441MHz	Highest channel 2480MHz
Conducted power [dBm] Measured with GFSK modulation		-4.11	-4.28	-5.26
Radiated power [dBm] Measured with GFSK modulation		-18.97	-19.26	-19.54
Gain [dBi] Calculated		-14.86	-14.98	14.28
Measurement uncertainty		± 1.5 dB (cond.) / ± 3 dB (rad.)		

#### 8DPSK

T <sub>nom</sub>	V <sub>nom</sub>	Lowest channel 2402MHz	Middle channel 2441MHz	Highest channel 2480MHz
Conducted power [dBm] Measured with 8DPSK modulation		-4.27	-4.92	-5.44
Radiated power [dBm] Measured with 8DPSK modulation		-19.31	-18.82	-18.32
Gain [dBi] Calculated		-15.04	-13.90	-12.88
Measurement uncertainty		± 1.5 dB (cond.) / ± 3 dB (rad.)		



### 6.3 PEAK POWER

#### LIMIT

The maximum peak output power of the intentional radiator shall not exceed the following:

1. For frequency hopping systems operating in the 2400-2483.5 MHz band employing at least 75 non-overlapping hopping channels: 1 watt. For all other frequency hopping systems in the 2400-2483.5 MHz band: 0.125 watts.
2. Except as shown in paragraphs (b)(3) (i), (ii) and (iii) of this section, if transmitting antennas of directional gain greater than 6dBi are used the peak output power from the intentional radiator shall be reduced below the stated values in paragraphs (b)(1) or (b)(2) of this section, as appropriate, by the amount in dB that the directional gain of the antenna exceeds 6dBi.
3. The conducted output power limit specified in paragraph (b) of this section is based on the use of antennas with directional gains that do not exceed 6 dBi. Except as shown in paragraph (c) of this section, if transmitting antennas of directional gain greater than 6 dBi are used, the conducted output power from the intentional radiator shall be reduced below the stated values in paragraphs (b)(1), (b)(2), and (b)(3) of this section, as appropriate, by the amount in dB that the directional gain of the antenna exceeds 6 dBi.

#### MEASUREMENT EQUIPMENT USED

Name of Equipment	Manufacturer	Model	Serial Number	Last Calibration	Due Calibration
Power Meter	Anritsu	ML2495A	1204003	02/21/2016	02/20/2017
Power Sensor	Anritsu	MA2411B	1126150	02/21/2016	02/20/2017

*Remark: Each piece of equipment is scheduled for calibration once a year.*

#### Test Configuration

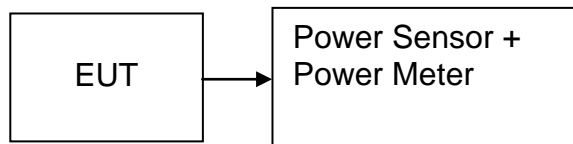

#### TEST PROCEDURE

The transmitter output is connected to the RF Power Meter. The RF Power Meter is set to the peak power detection.



**TEST RESULTS**

No non-compliance noted

**Test Data**

**GFSK**

Channel	Frequency (MHz)	Reading Power (dBm)	Cable loss (dB)	Output Power (dBm)	Output Power (W)	Limit (W)	Peak /AVG	Result
Low	2402	-7.61	3.50	-4.11	0.00039	1	peak	PASS
Mid	2441	-7.78	3.50	-4.28	0.00037			PASS
High	2480	-8.76	3.50	-5.26	0.00030			PASS
Low	2402	-8.27	3.50	-4.77	0.00033	1	AVG	PASS
Mid	2441	-8.85	3.50	-5.35	0.00029			PASS
High	2480	-9.42	3.50	-5.92	0.00026			PASS

**$\pi/4$ -DQPSK**

Channel	Frequency (MHz)	Reading Power (dBm)	Cable loss (dB)	Output Power (dBm)	Output Power (W)	Limit (W)	Peak /AVG	Result
Low	2402	-7.65	3.50	-4.15	0.00038	1	peak	PASS
Mid	2441	-7.88	3.50	-4.38	0.00036			PASS
High	2480	-8.87	3.50	-5.37	0.00029			PASS
Low	2402	-7.73	3.50	-4.23	0.00038	1	AVG	PASS
Mid	2441	-8.69	3.50	-5.19	0.00030			PASS
High	2480	-8.76	3.50	-5.26	0.00030			PASS

**8DPSK**

Channel	Frequency (MHz)	Reading Power (dBm)	Cable loss (dB)	Output Power (dBm)	Output Power (W)	Limit (W)	Peak /AVG	Result
Low	2402	-7.77	3.50	-4.27	0.00037	1	peak	PASS
Mid	2441	-8.42	3.50	-4.92	0.00032			PASS
High	2480	-8.94	3.50	-5.44	0.00029			PASS
Low	2402	-11.91	3.50	-8.41	0.00014	1	AVG	PASS
Mid	2441	-12.69	3.50	-9.19	0.00012			PASS
High	2480	-13.36	3.50	-9.86	0.00010			PASS





## 6.4 PEAK POWER SPECTRAL DENSITY

### LIMIT

1. For direct sequence systems, the peak power spectral density conducted from the intentional radiator to the antenna shall not be greater than 8dBm in any 3kHz band during any time interval of continuous transmission.
2. The direct sequence operating of the hybrid system, with the frequency hopping operation turned off, shall comply with the power density requirements of paragraph (d) of this section.

### MEASUREMENT EQUIPMENT USED

Name of Equipment	Manufacturer	Model	Serial Number	Last Calibration	Due Calibration
Spectrum Analyzer	Agilent	E4446A	US44300399	02/21/2016	02/20/2017

*Remark: Each piece of equipment is scheduled for calibration once a year.*

### Test Configuration

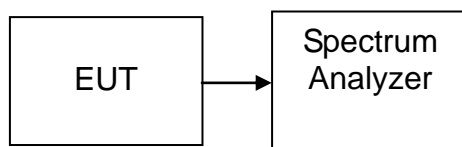

### TEST PROCEDURE

1. Set analyzer center frequency to DTS channel center frequency.
2. Set the span to 1.5 times the DTS bandwidth.
3. Set the RBW to:  $3 \text{ kHz} \leq \text{RBW} \leq 100 \text{ kHz}$ .
4. Set the VBW  $\geq 3 \times \text{RBW}$ .
5. Detector = peak.
6. Sweep time = auto couple.
7. Trace mode = max hold.
8. Allow trace to fully stabilize.
9. Use the peak marker function to determine the maximum amplitude level within the RBW.
10. If measured value exceeds limit, reduce RBW (no less than 3 kHz) and repeat.

### TEST RESULTS

*Not applicable. Since EUT is the Bluetooth device.*



### 6.5 BAND EDGES MEASUREMENT

#### LIMIT

According to §15.247(c), in any 100 kHz bandwidth outside the frequency bands in which the spread spectrum intentional radiator is operating, the radio frequency power that is produced by the intentional radiator shall be at least 20dB below that in the 100kHz bandwidth within the band that contains the highest level of the desired power. In addition, radiated emissions which fall in the restricted bands, as defined in §15.205(a), must also comply with the radiated emission limits specified in 15.209(a).

#### MEASUREMENT EQUIPMENT USED

Radiated Emission Test Site 966 (2)					
Name of Equipment	Manufacturer	Model Number	Serial Number	Last Calibration	Due Calibration
Spectrum Analyzer	Agilent	E4446A	US44300399	02/21/2016	02/20/2017
EMI TEST RECEIVER	ROHDE&SCHWARZ	ESCI	100783	02/21/2016	02/20/2017
Amplifier	MITEQ	AM-1604-3000	1123808	03/18/2016	03/18/2017
High Noise Amplifier	Agilent	8449B	3008A01838	02/21/2016	02/20/2017
Board-Band Horn Antenna	Schwarzbeck	BBHA 9170	9170-497	02/28/2016	02/27/2017
Bilog Antenna	SCHAFFNER	CBL6143	5082	02/21/2016	02/20/2017
Horn Antenna	SCHWARZBECK	BBHA9120	D286	02/28/2016	02/27/2017
Active Loop Antenna	COM-POWER	AL-130	121044	02/21/2016	02/20/2017
Turn Table	N/A	N/A	N/A	N.C.R	N.C.R
Controller	Sunol Sciences	SC104V	022310-1	N.C.R	N.C.R
Controller	CT	N/A	N/A	N.C.R	N.C.R
Temp. / Humidity Meter	Anymetre	JR913	N/A	02/21/2016	02/20/2017
Antenna Tower	SUNOL	TLT2	N/A	N.C.R	N.C.R
Test S/W	FARAD	LZ-RF / CCS-SZ-3A2			

#### Test Configuration

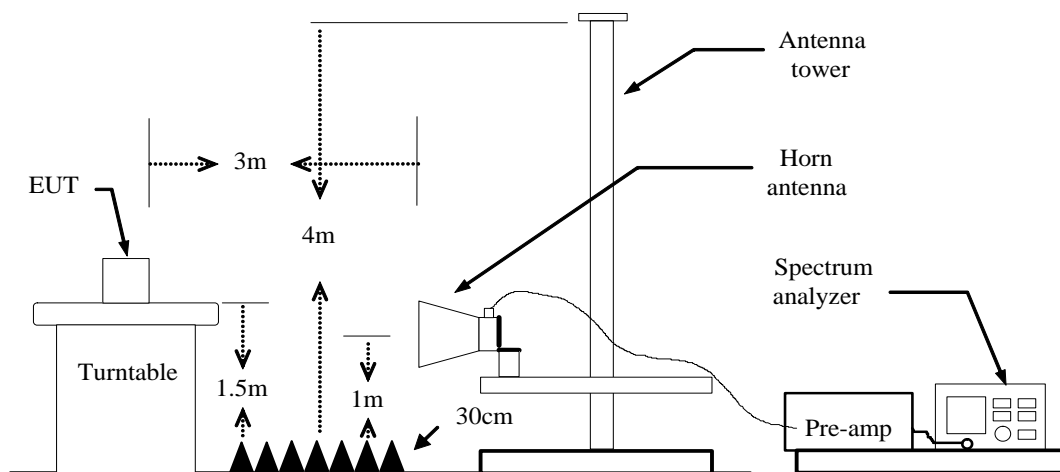



## **TEST PROCEDURE**

1. The EUT is placed on a turntable, which is 1.5m above the ground plane.
2. The turntable shall be rotated for 360 degrees to determine the position of maximum emission level.
3. EUT is set 3m away from the receiving antenna, which is varied from 1m to 4m to find out the highest emission.
4. Set the spectrum analyzer in the following setting in order to capture the lower and upper band-edges of the emission:
  - (a) PEAK: RBW=VBW=1MHz / Sweep=AUTO
  - (b) AVERAGE: RBW=1MHz / VBW=330Hz / Sweep=AUTO
5. Repeat the procedures until all the PEAK and AVERAGE versus POLARIZATION are measured.

## **TEST RESULTS**

Refer to attach spectrum analyzer data chart.



**Test Data ( GFSK )**

**Band Edges (CH-Low)**

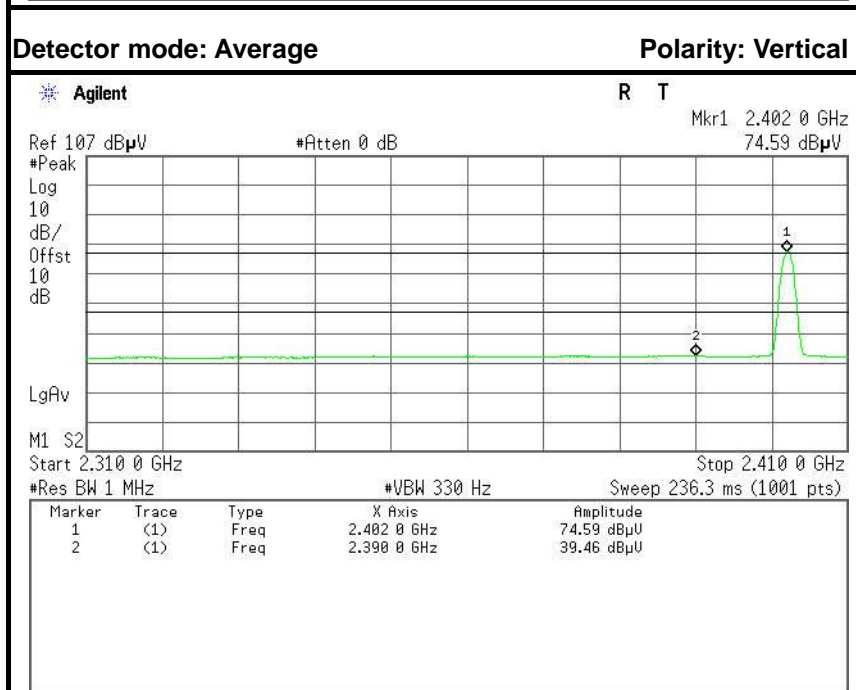
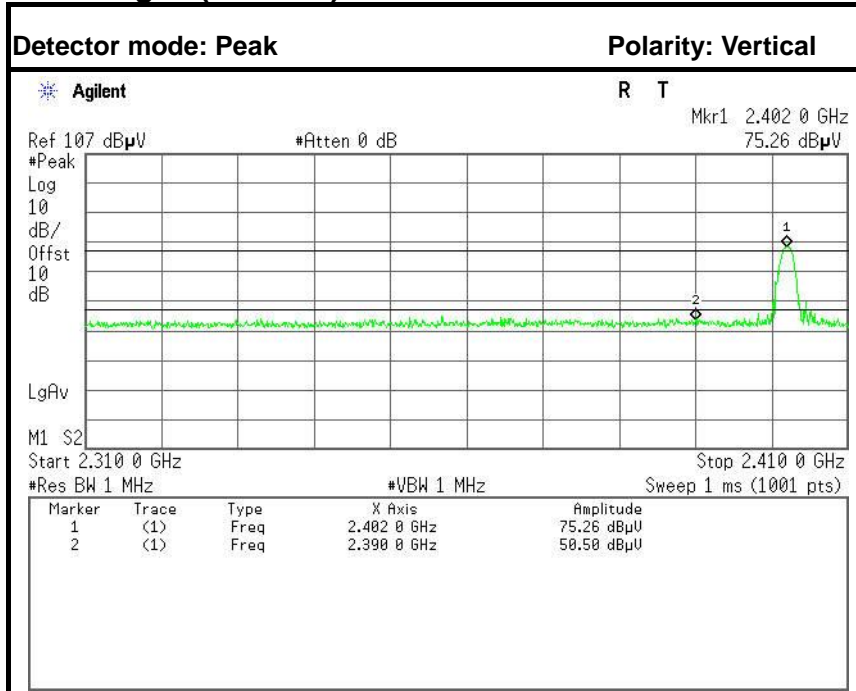

No.	Frequency (MHz)	Reading (dBuV)	Corrected (dB)	Result (dBuV)	Limit (dBuV)	Margin (dB)	Detector	Antenna Pole
1	2390.0000	43.90	-6.60	50.50	74.00	-23.50	Peak	Vertical
2	2390.0000	32.86	-6.60	39.46	54.00	-14.54	Average	Vertical

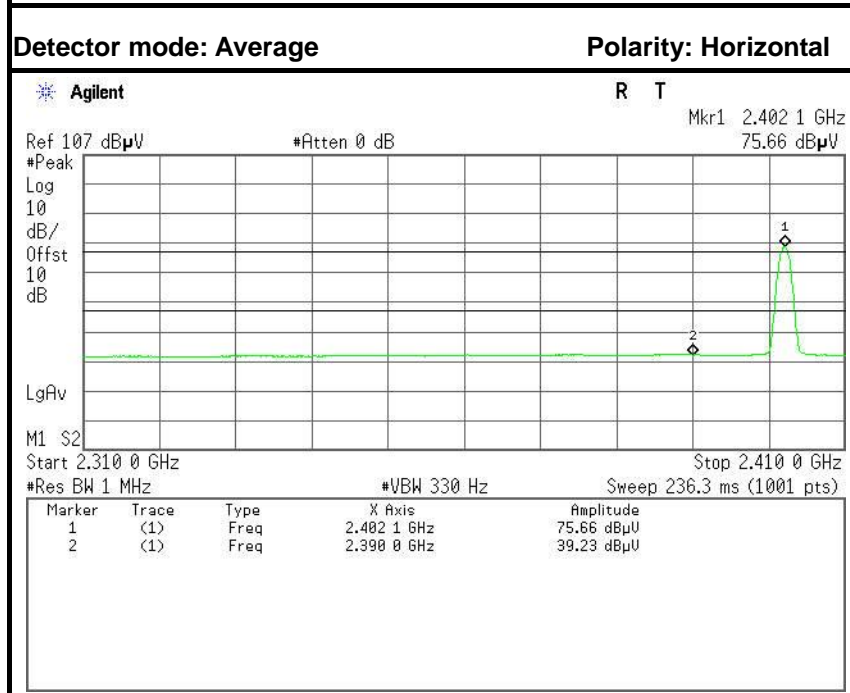
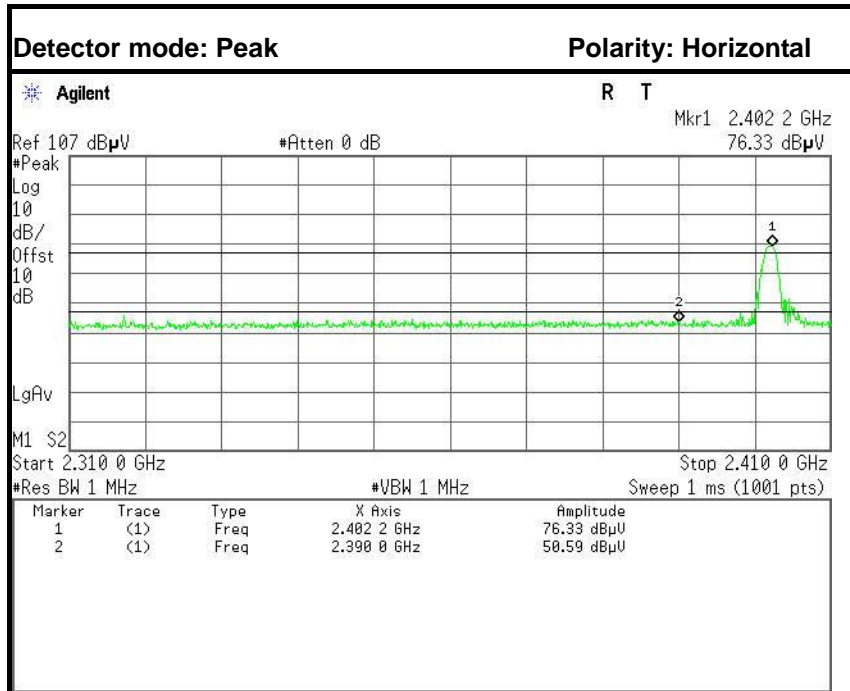

No.	Frequency (MHz)	Reading (dBuV)	Corrected (dB)	Result (dBuV)	Limit (dBuV)	Margin (dB)	Detector	Antenna Pole
1	2390.0000	43.99	-6.60	50.59	74.00	-23.41	Peak	Horizontal
2	2390.0000	32.63	-6.60	39.23	54.00	-14.77	Average	Horizontal



**Band Edges (CH-High)**

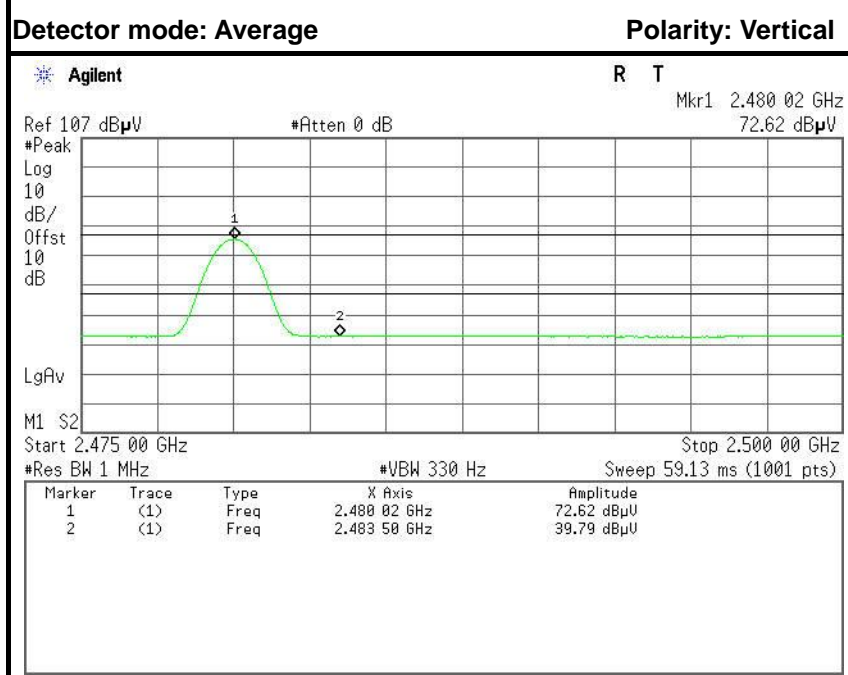
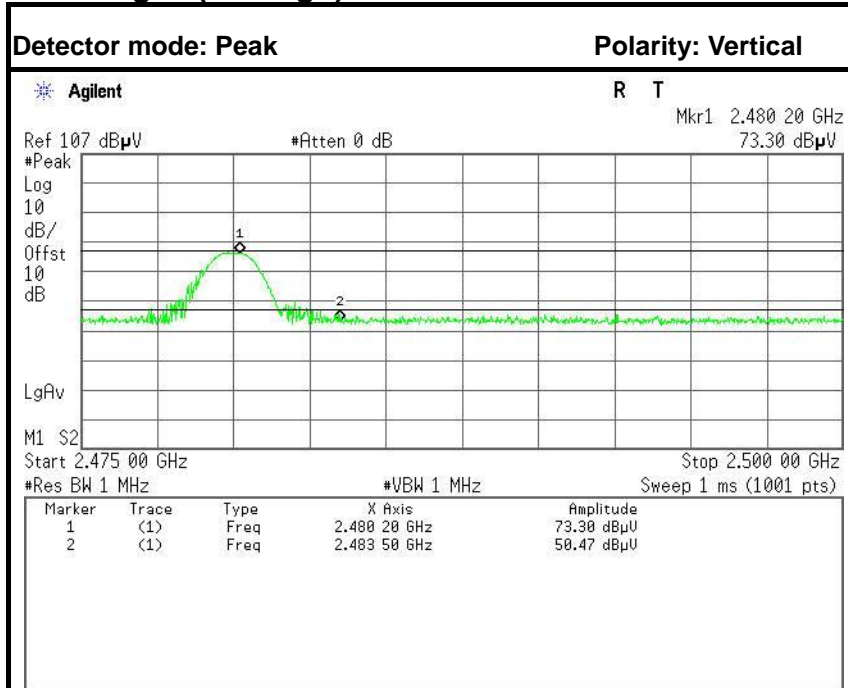

No.	Frequency (MHz)	Reading (dBuV)	Corrected (dB)	Result (dBuV)	Limit (dBuV)	Margin (dB)	Detector	Antenna Pole
1	2483.5000	44.23	-6.24	50.47	74.00	-23.53	Peak	Vertical
2	2483.5000	33.55	-6.24	39.79	54.00	-14.21	Average	Vertical

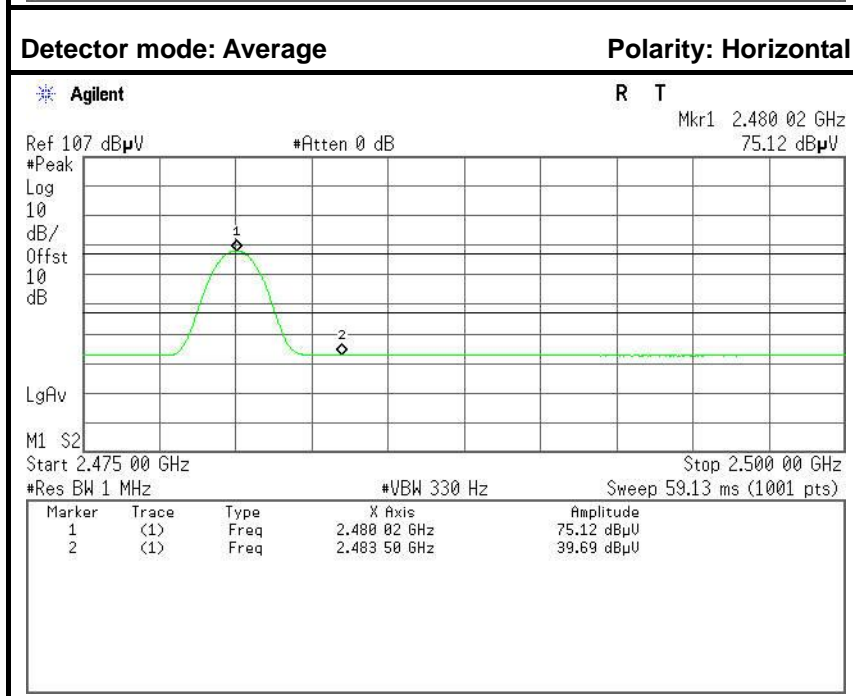
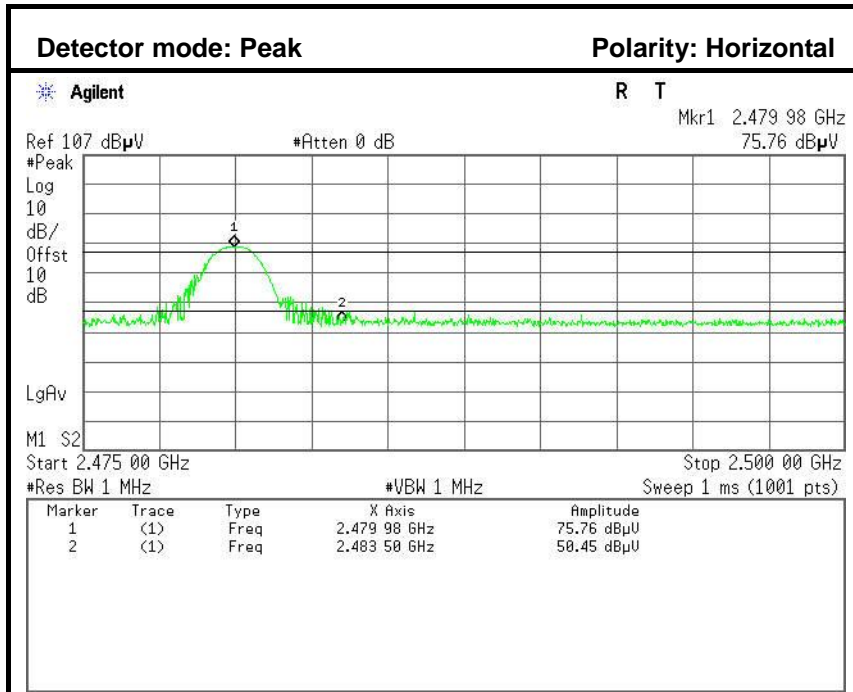

No.	Frequency (MHz)	Reading (dBuV)	Corrected (dB)	Result (dBuV)	Limit (dBuV)	Margin (dB)	Detector	Antenna Pole
1	2483.5000	44.21	-6.24	50.45	74.00	-23.55	Peak	Horizontal
2	2483.5000	33.45	-6.24	39.69	54.00	-14.31	Average	Horizontal



**8DPSK**

**Band Edges (CH-Low)**

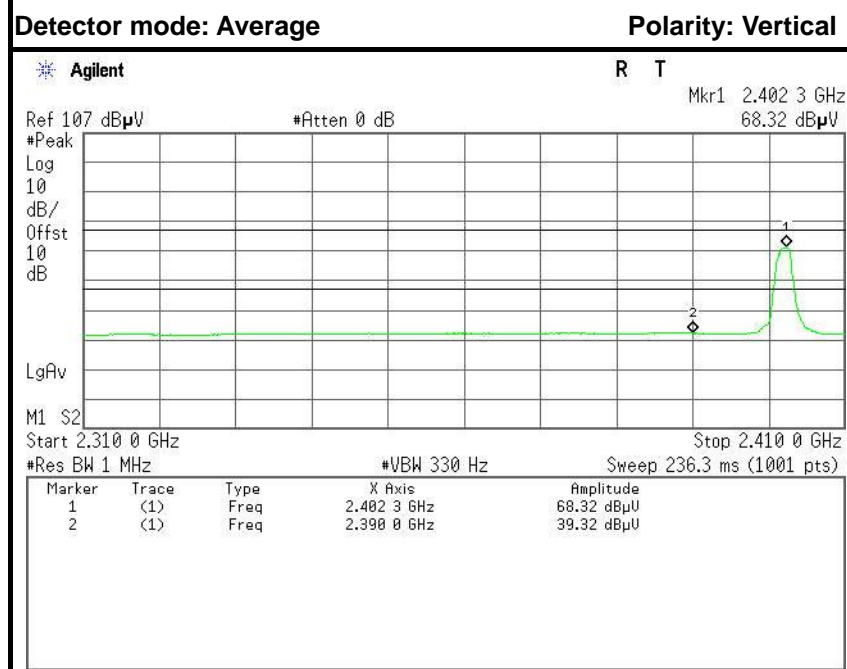
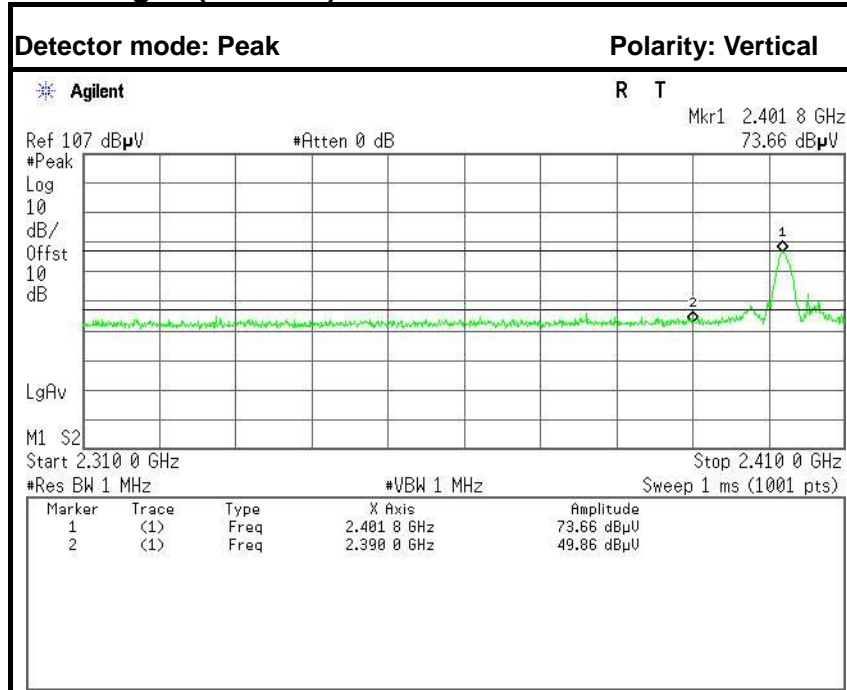

No.	Frequency (MHz)	Reading (dBuV)	Corrected (dB)	Result (dBuV)	Limit (dBuV)	Margin (dB)	Detector	Antenna Pole
1	2390.0000	43.26	-6.60	49.86	74.00	-24.14	Peak	Vertical
2	2390.0000	32.72	-6.60	39.32	54.00	-14.68	Average	Vertical



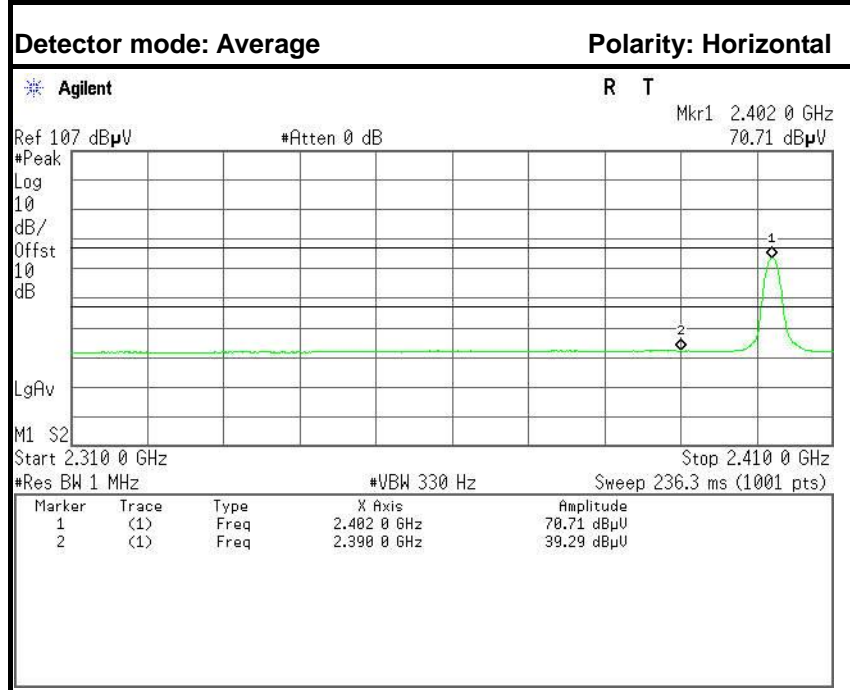
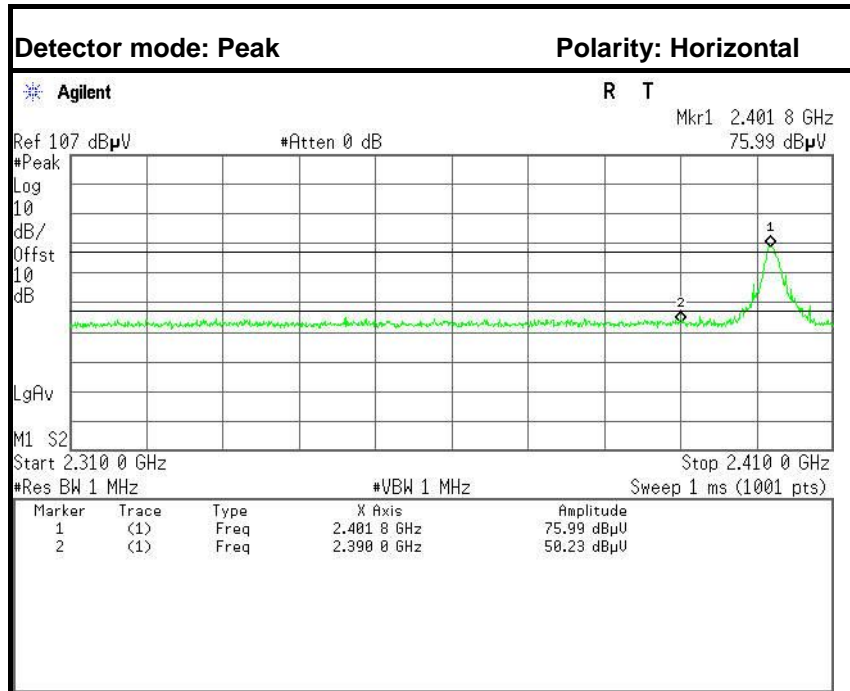

No.	Frequency (MHz)	Reading (dBuV)	Corrected (dB)	Result (dBuV)	Limit (dBuV)	Margin (dB)	Detector	Antenna Pole
1	2390.0000	43.63	-6.60	50.23	74.00	-23.77	Peak	Horizontal
2	2390.0000	32.69	-6.60	39.29	54.00	-14.71	Average	Horizontal



**Band Edges (CH-High)**

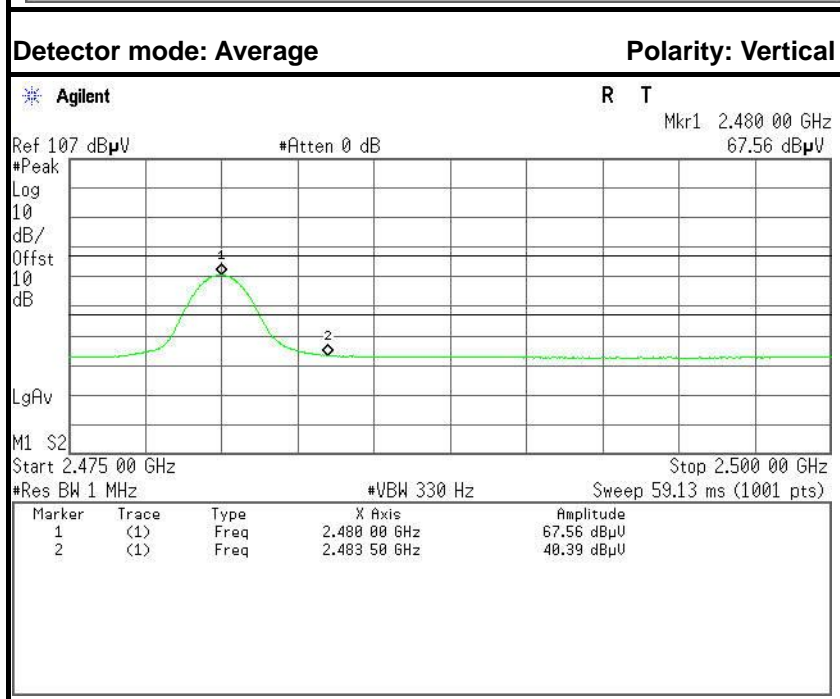
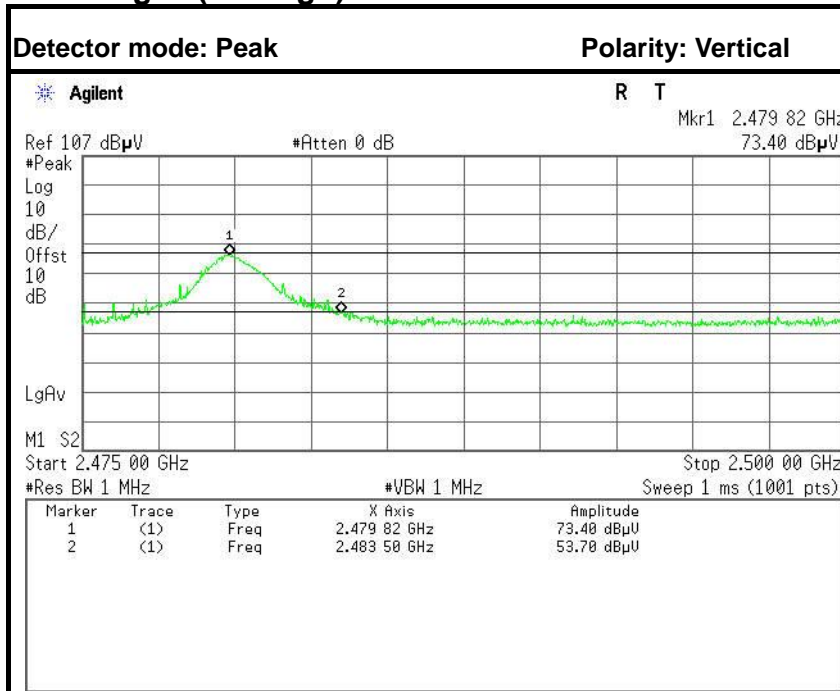

No.	Frequency (MHz)	Reading (dBuV)	Corrected (dB)	Result (dBuV)	Limit (dBuV)	Margin (dB)	Detector	Antenna Pole
1	2483.5000	47.46	-6.24	53.70	74.00	-20.30	Peak	Vertical
2	2483.5000	34.15	-6.24	40.39	54.00	-13.61	Average	Vertical

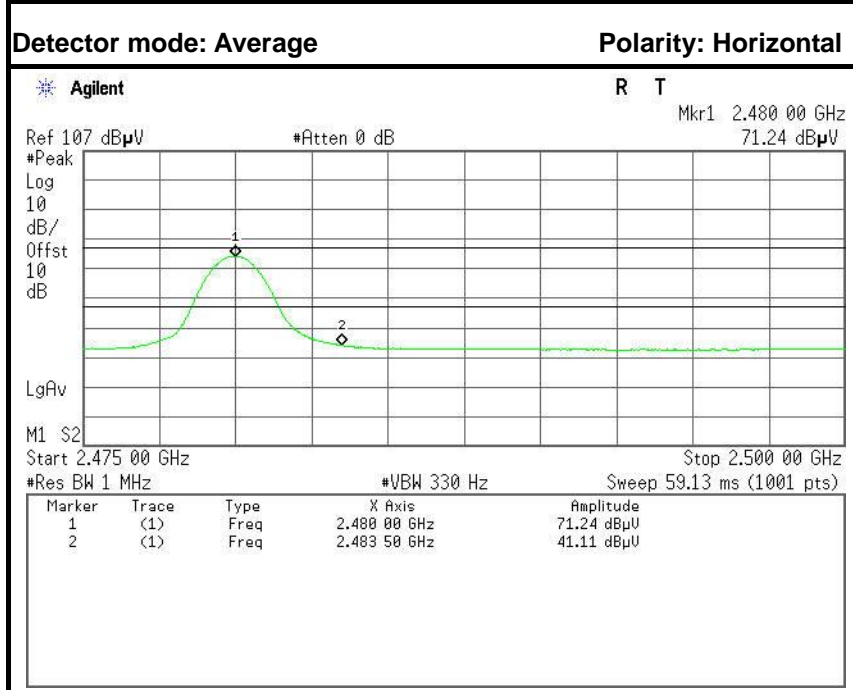
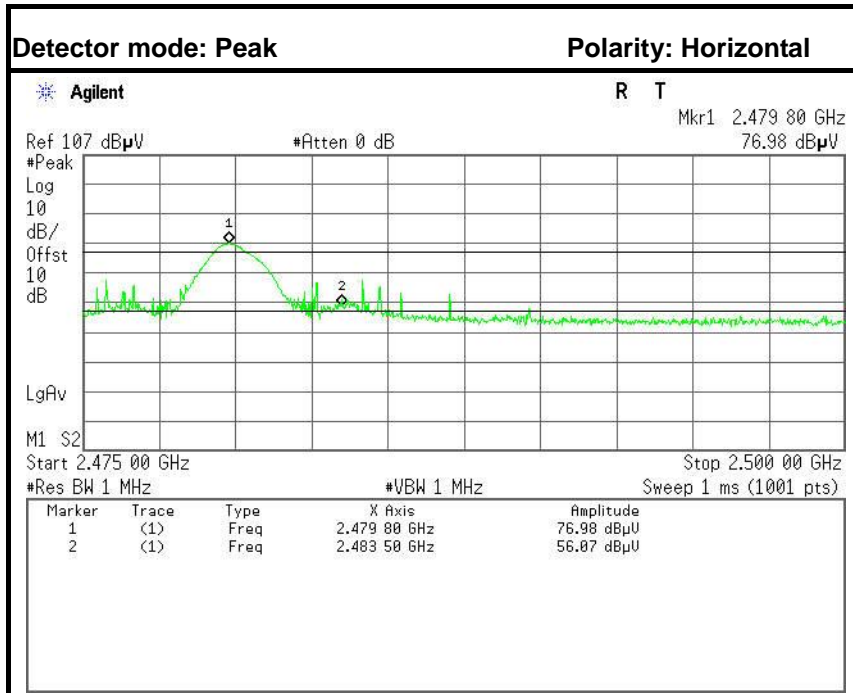

No.	Frequency (MHz)	Reading (dBuV)	Corrected (dB)	Result (dBuV)	Limit (dBuV)	Margin (dB)	Detector	Antenna Pole
1	2483.5000	49.83	-6.24	56.07	74.00	-17.93	Peak	Horizontal
2	2483.5000	34.87	-6.24	41.11	54.00	-12.89	Average	Horizontal



## 6.6 FREQUENCY SEPARATION

### LIMIT

According to §15.247(a)(1), Frequency hopping systems shall have hopping channel carrier frequencies separated by a minimum of 25 kHz or the 20 dB bandwidth of the hopping channel, whichever is greater. Alternatively, frequency hopping systems operating in the 2400-2483.5 MHz band may have hopping channel carrier frequencies that are separated by 25 kHz or two-thirds of the 20 dB bandwidth of the hopping channel, whichever is greater, provided the systems operate with an output power no greater than 125 mW.

### MEASUREMENT EQUIPMENT USED

Name of Equipment	Manufacturer	Model	Serial Number	Last Calibration	Due Calibration
Spectrum Analyzer	Agilent	E4446A	US44300399	02/21/2016	02/20/2017

*Remark: Each piece of equipment is scheduled for calibration once a year.*

### Test Configuration

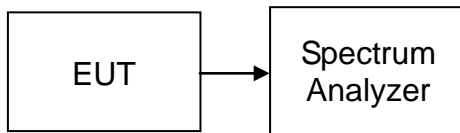

### TEST PROCEDURE

1. Place the EUT on the table and set it in transmitting mode.
2. Remove the antenna from the EUT and then connect a low loss RF cable from the antenna port to the spectrum analyzer.
3. Set center frequency of spectrum analyzer = middle of hopping channel.
4. Set the spectrum analyzer as RBW=30kHz, VBW=30kHz, Adjust Span to 4 MHz, Sweep = auto.
5. Max hold. Mark 3 Peaks of hopping channel and record the 3 peaks frequency.

### TEST RESULTS

*No non-compliance noted*

#### Test Data

##### GFSK

Channel Separation (MHz)	Two-thirds of the 20 dB Bandwidth (kHz)	Channel Separation Limit	Result
1.000	704.000	> Two-thirds of the 20 dB Bandwidth	Pass

##### 8DPSK

Channel Separation (MHz)	Two-thirds of the 20 dB Bandwidth (kHz)	Channel Separation Limit	Result
1.000	904.000	> Two-thirds of the 20 dB Bandwidth	Pass



### GFSK

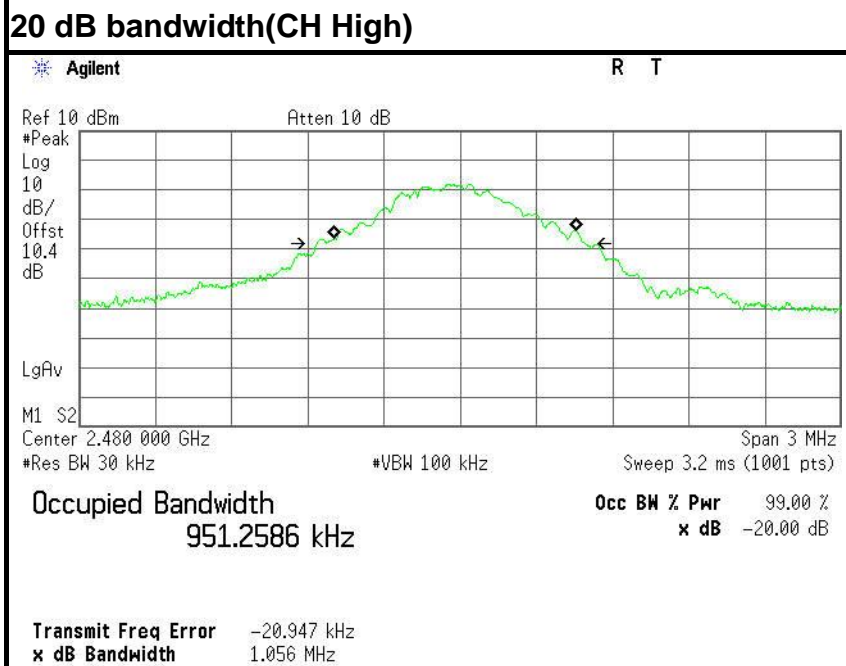
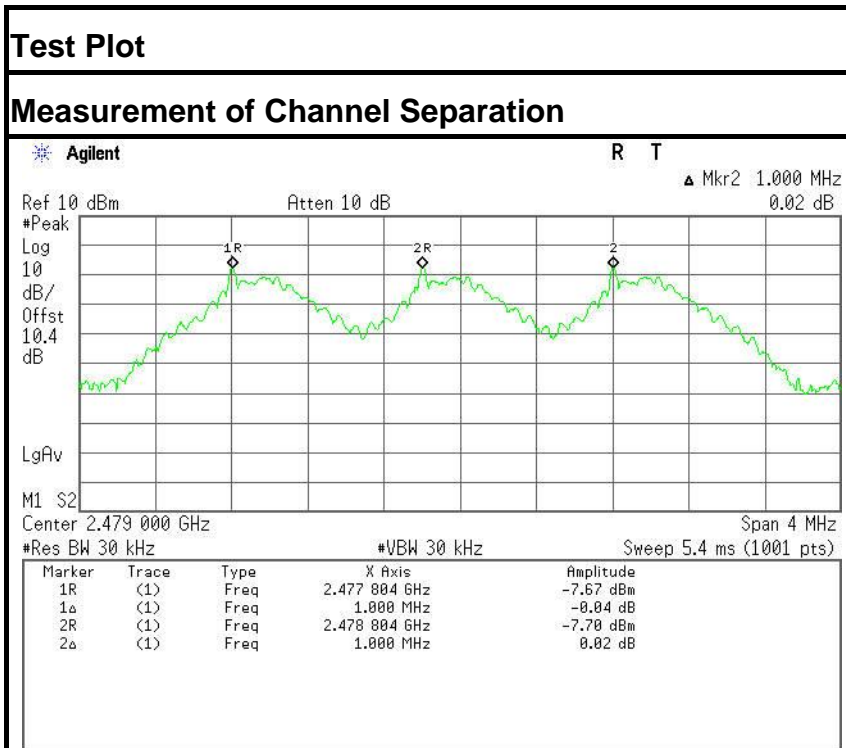



### 8DPSK

#### Test Plot

#### Measurement of Channel Separation

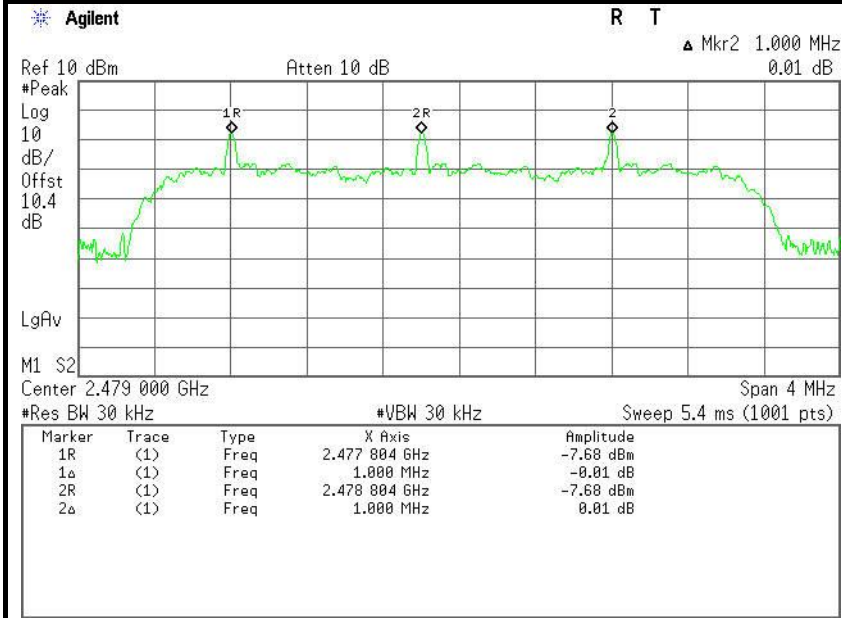

#### 20 dB bandwidth(CH Low)

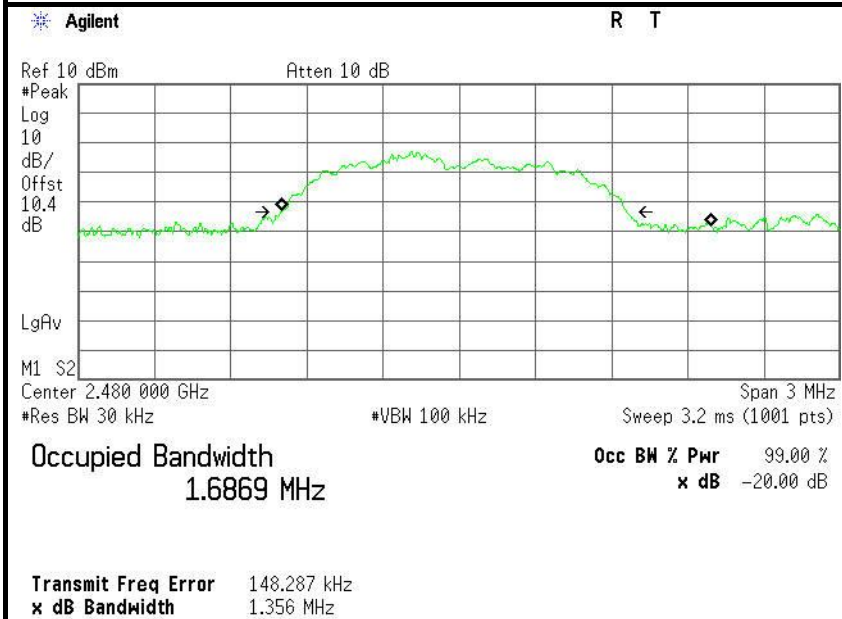



## 6.7 NUMBER OF HOPPING FREQUENCY

### LIMIT

According to §15.247(a)(1)(ii), Frequency hopping systems operating in the 2400MHz-2483.5 MHz bands shall use at least 15 hopping frequencies.

### MEASUREMENT EQUIPMENT USED

Name of Equipment	Manufacturer	Model	Serial Number	Last Calibration	Due Calibration
Spectrum Analyzer	Agilent	E4446A	US44300399	02/21/2016	02/20/2017

*Remark: Each piece of equipment is scheduled for calibration once a year.*

### Test Configuration

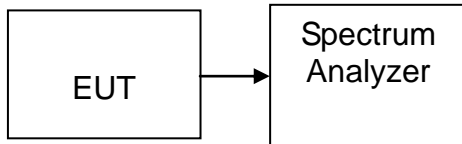

### TEST PROCEDURE

1. Place the EUT on the table and set it in transmitting mode.
2. Remove the antenna from the EUT and then connect a low loss RF cable from the antenna port to the spectrum analyzer.
3. Set spectrum analyzer Start=2400MHz, Stop = 2483.5MHz, Sweep = 1ms.
4. Set the spectrum analyzer as RBW, VBW=300kHz,
5. Max hold, view and count how many channel in the band.

### TEST RESULTS

*No non-compliance noted*

### Test Data

Result (No. of CH)	Limit (No. of CH)	Result
79	>15	PASS



Test Plot

Channel Number

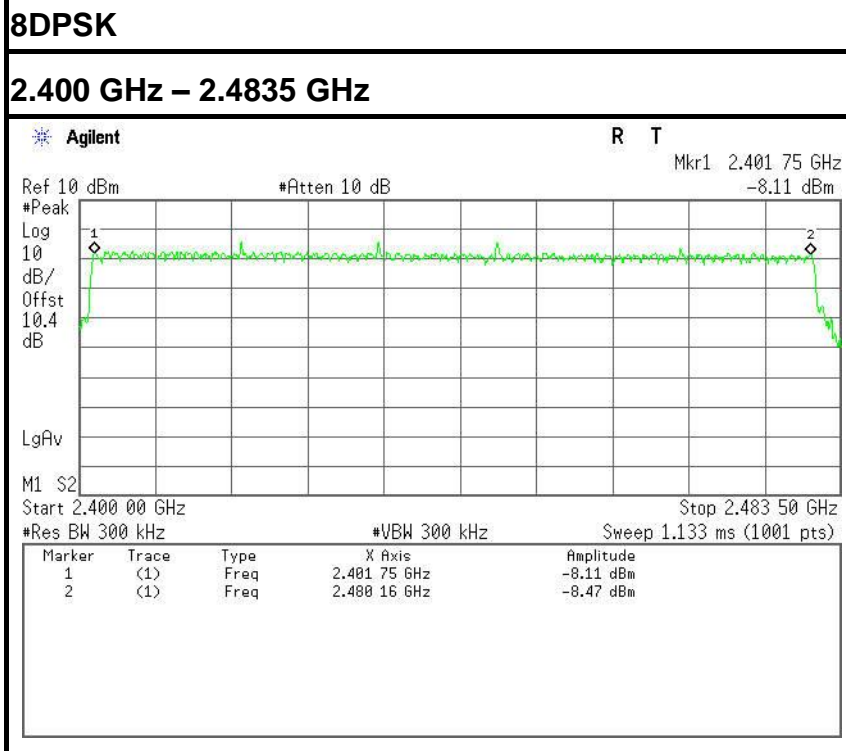
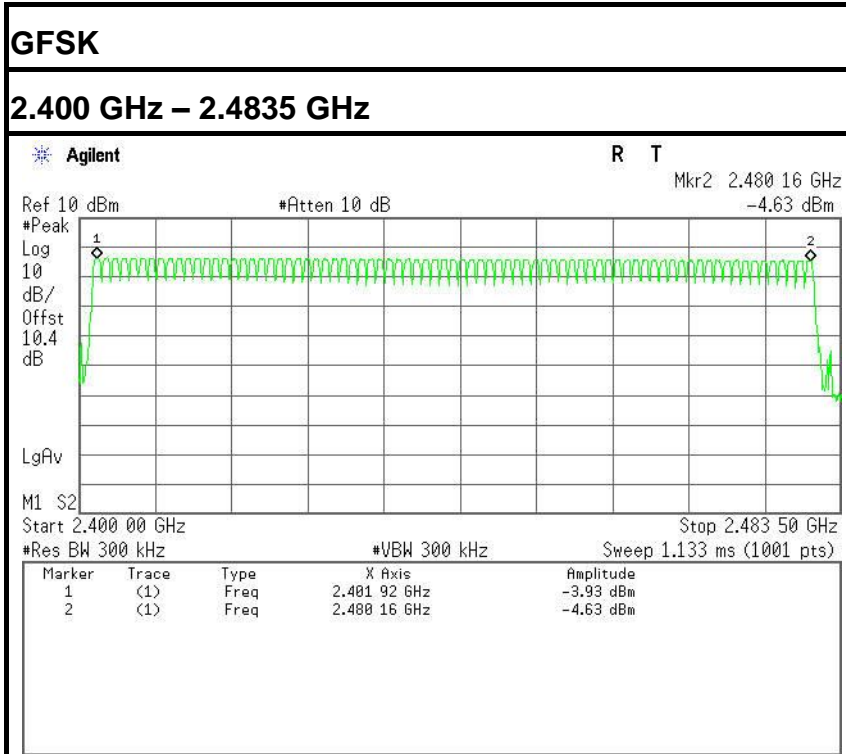





## 6.8 TIME OF OCCUPANCY (DWELL TIME)

### LIMIT

According to §15.247(a)(1)(iii), Frequency hopping systems operating in the 2400MHz-2483.5 MHz bands. The average time of occupancy on any channels shall not greater than 0.4 s within a period 0.4s multiplied by the number of hopping channels employed.

### MEASUREMENT EQUIPMENT USED

Name of Equipment	Manufacturer	Model	Serial Number	Last Calibration	Due Calibration
Spectrum Analyzer	Agilent	E4446A	US44300399	02/21/2016	02/20/2017

*Remark: Each piece of equipment is scheduled for calibration once a year.*

### Test Configuration

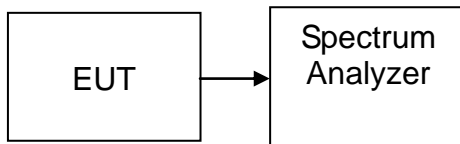

### TEST PROCEDURE

1. Place the EUT on the table and set it in transmitting mode.
2. Remove the antenna from the EUT and then connect a low loss RF cable from the antenna port to the spectrum analyzer.
3. Set center frequency of spectrum analyzer = operating frequency.
4. Set the spectrum analyzer as RBW, VBW=1MHz, Span = 0Hz, Sweep = auto.
5. Repeat above procedures until all frequency measured were complete.



## **TEST RESULTS**

*No non-compliance noted*

### **Test Data**

#### **GFSK**

##### **DH 1**

CH Mid:  $0.384 * (1600/2)/79 * 31.6 = 122.88$  (ms)

CH	Pulse Time (ms)	Total of Dwell (ms)	Period Time (s)	Limit (ms)	Result
Low	0.384	122.88	31.60	400.00	PASS

##### **DH 3**

CH Mid:  $1.546 * (1600/4)/79 * 31.6 = 247.36$ (ms)

CH	Pulse Time (ms)	Total of Dwell (ms)	Period Time (s)	Limit (ms)	Result
Low	1.546	247.36	31.60	400.00	PASS

##### **DH 5**

CH Mid:  $2.804 * (1600/6)/79 * 31.6 = 299.09$ (ms)

CH	Pulse Time (ms)	Total of Dwell (ms)	Period Time (s)	Limit (ms)	Result
Low	2.804	299.09	31.60	400.00	PASS



**8DPSK**

**DH 1**

CH Mid:  $0.556 * (1600/2)/79 * 31.6 = 177.92(\text{ms})$

CH	Pulse Time (ms)	Total of Dwell (ms)	Period Time (s)	Limit (ms)	Result
Low	0.556	177.92	31.60	400.00	PASS

**DH 3**

CH Mid:  $1.522 * (1600/4)/79 * 31.6 = 243.52 (\text{ms})$

CH	Pulse Time (ms)	Total of Dwell (ms)	Period Time (s)	Limit (ms)	Result
Low	1.522	243.52	31.60	400.00	PASS

**DH 5**

CH Mid:  $2.848 * (1600/6)/79 * 31.6 = 303.79(\text{ms})$

CH	Pulse Time (ms)	Total of Dwell (ms)	Period Time (s)	Limit (ms)	Result
Low	2.848	303.79	31.60	400.00	PASS



**Test Plot**

**GFSK**

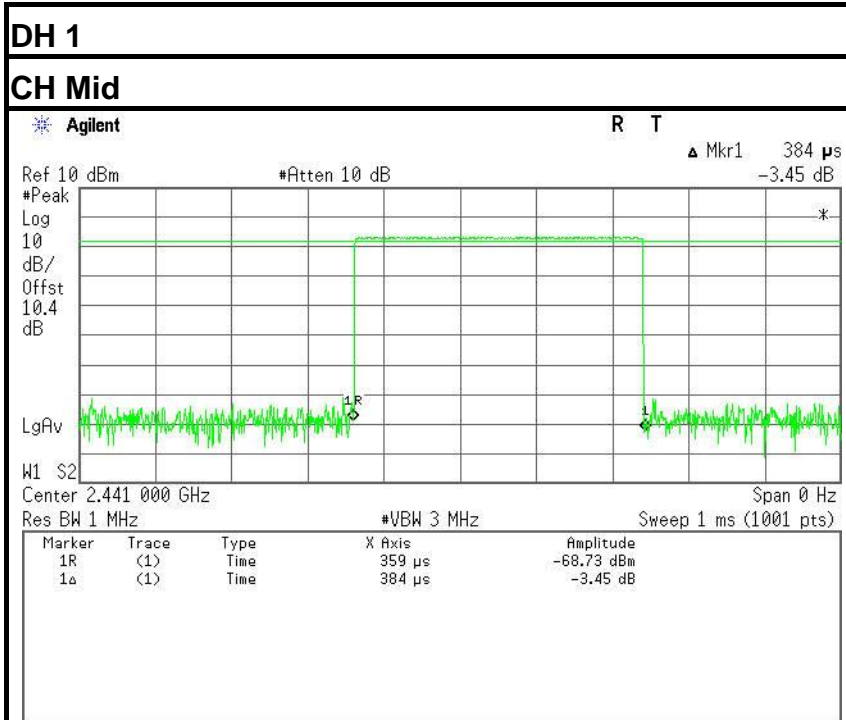

**DH 3**

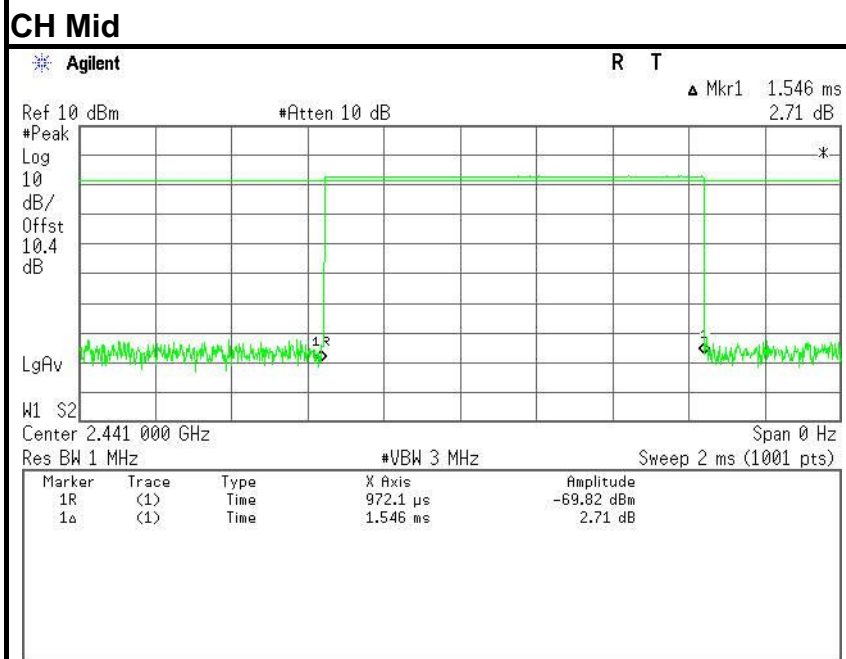

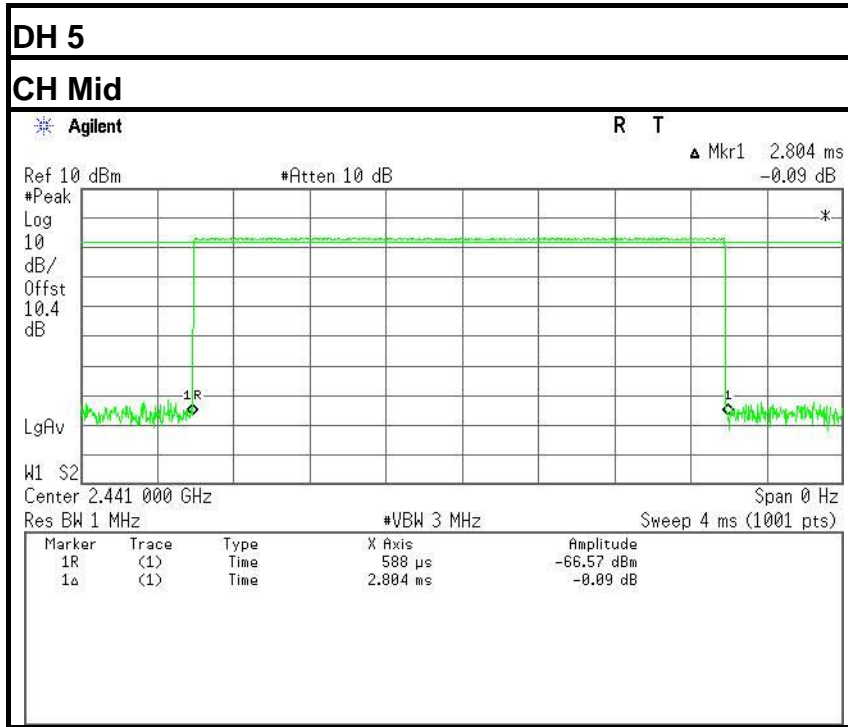



**Test Plot**  
**8DPSK**

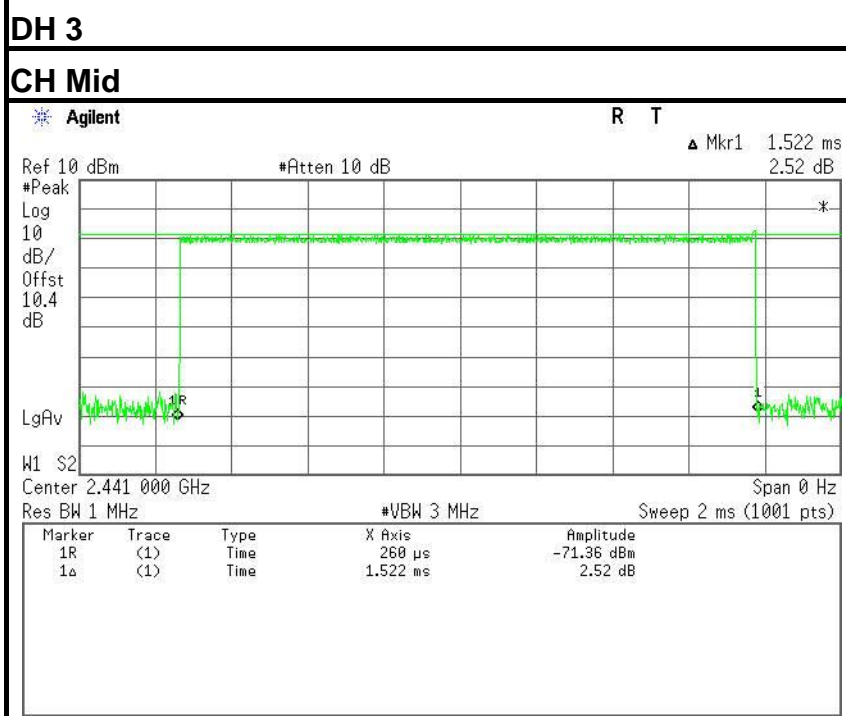
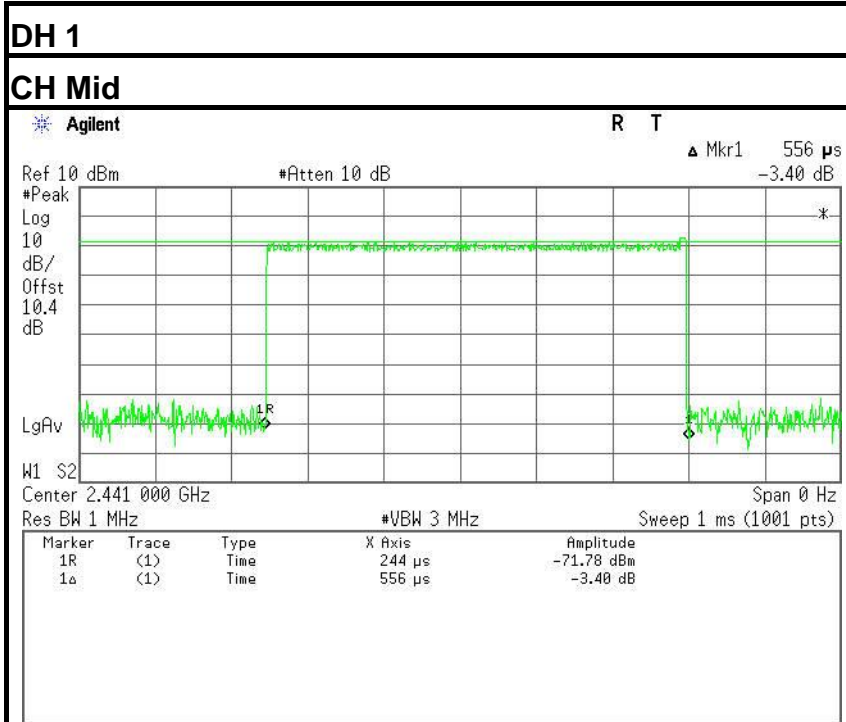

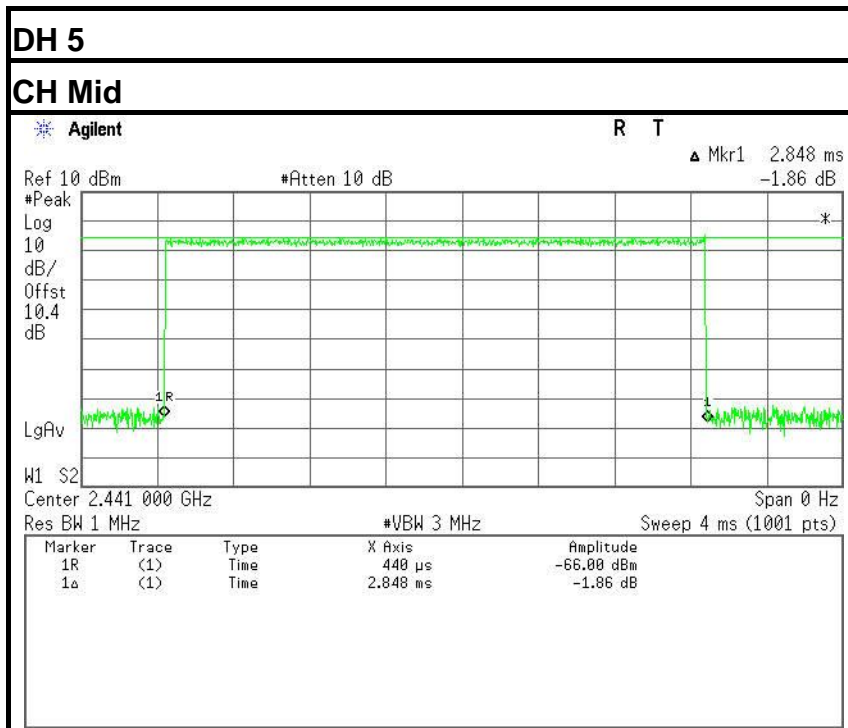



## 6.9 SPURIOUS EMISSIONS

### 6.9.1. CONDUCTED MEASUREMENT

#### LIMIT

In any 100 kHz bandwidth outside the frequency band in which the spread spectrum or digitally modulated intentional radiator is operating, the radio frequency power that is produced by the intentional radiator shall be at least 20 dB below that in the 100 kHz bandwidth within the band that contains the highest level of the desired power, based on either an RF conducted or a radiated measurement. Attenuation below the general limits specified in Section 15.209(a) is not required. In addition, radiated emissions which fall in the restricted bands, as defined in Section 15.205(a), must also comply with the radiated emission limits specified in Section 15.209(a) (see Section 15.205(c)).

#### MEASUREMENT EQUIPMENT USED

Name of Equipment	Manufacturer	Model	Serial Number	Last Calibration	Due Calibration
Spectrum Analyzer	Agilent	E4446A	US44300399	02/21/2016	02/20/2017

*Remark: Each piece of equipment is scheduled for calibration once a year.*

#### Test Configuration

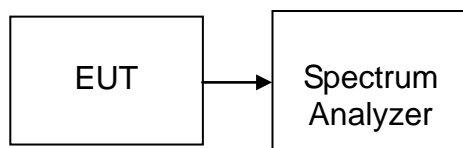

#### TEST PROCEDURE

Conducted RF measurements of the transmitter output were made to confirm that the EUT antenna port conducted emissions meet the specified limit and to identify any spurious signals that require further investigation or measurements on the radiated emissions site.

The transmitter output is connected to the spectrum analyzer. The resolution bandwidth is set to 100 kHz. The video bandwidth is set to 300 kHz.

Measurements are made over the 10MHz to 26.5GHz range with the transmitter set to the lowest, middle, and highest channels.

#### TEST RESULTS

*No non-compliance noted*

*Remark: The hopping on mode and hopping off mode were chosen for pre-test and the hopping off mode was the worse case and print in the report.*





**Test Plot ( GFSK )**

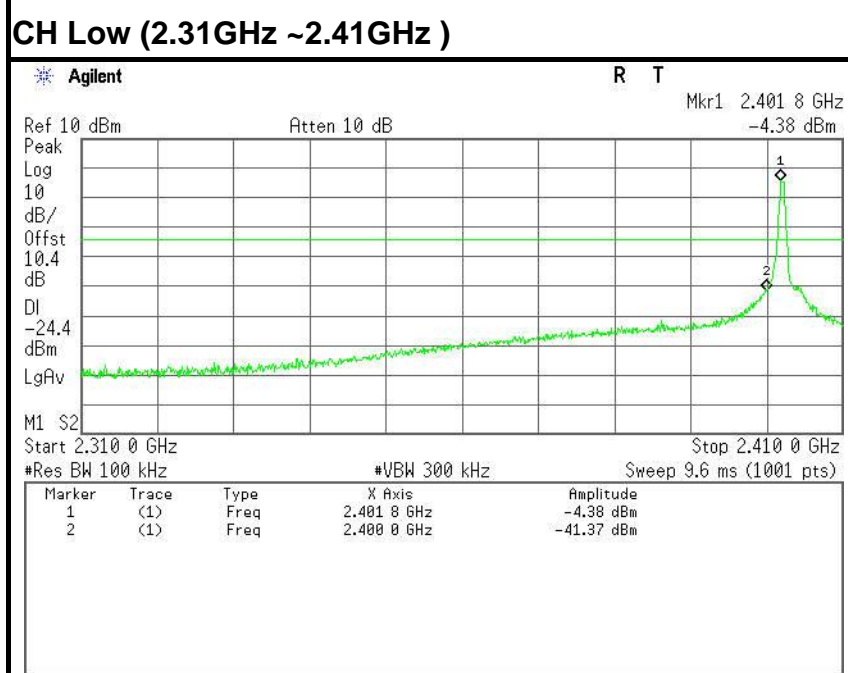
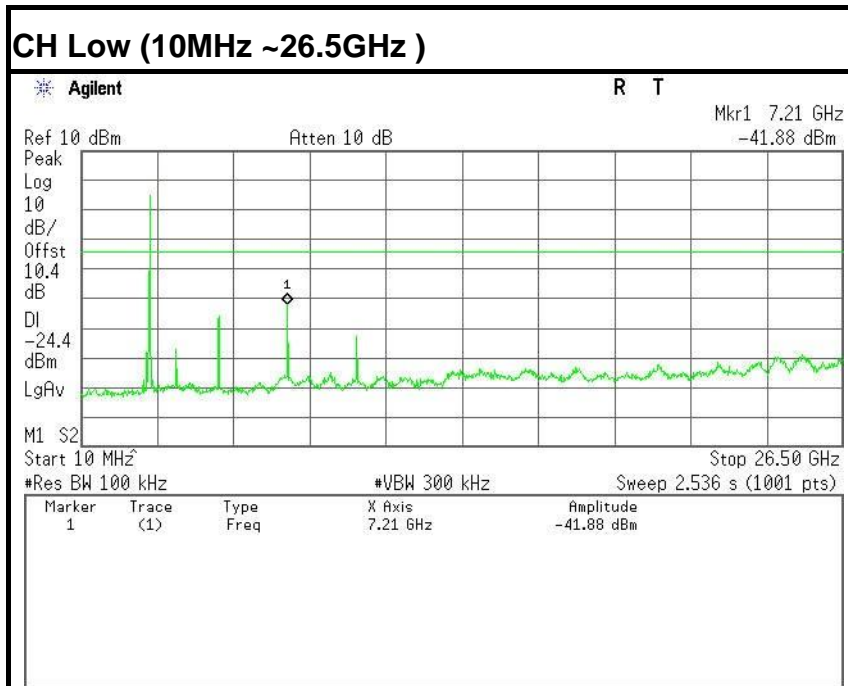

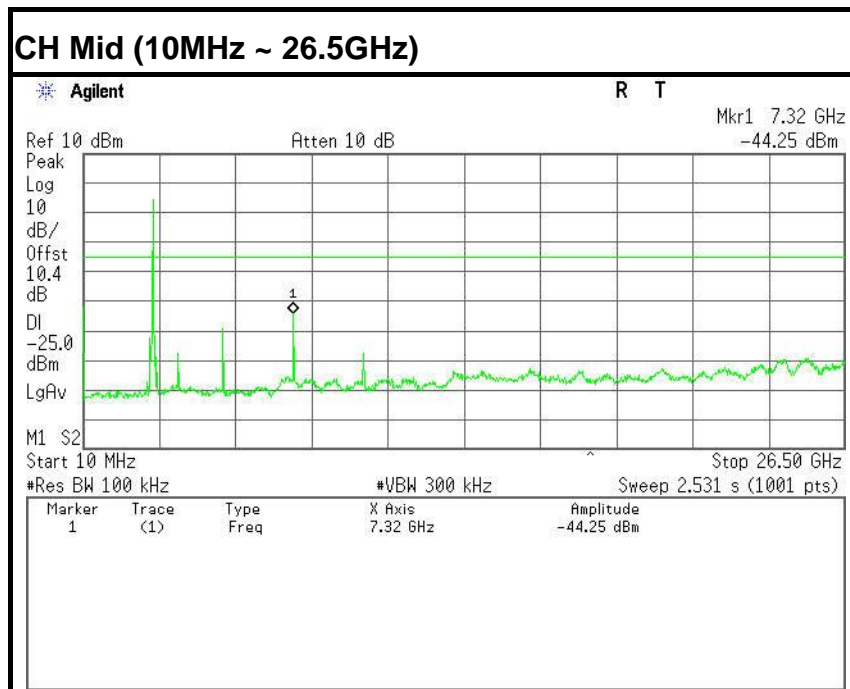



### CH High (10MHz ~ 26.5GHz)

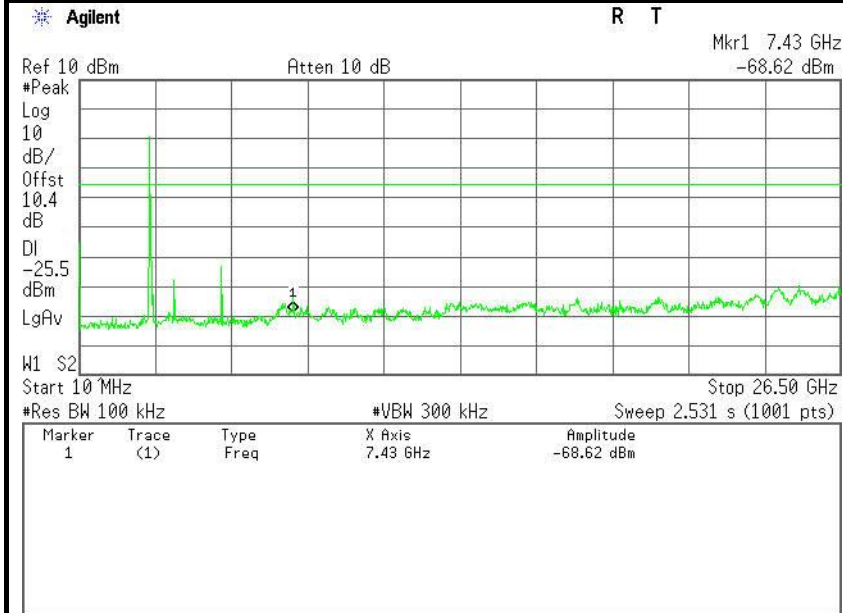

### CH High (2.475GHz ~ 2.5GHz)

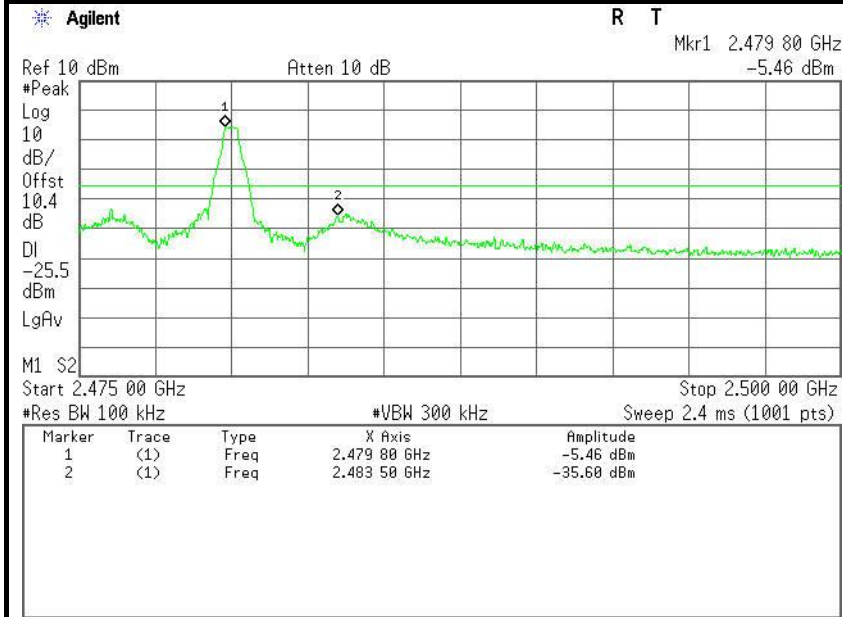



**Test Plot (8DPSK )**

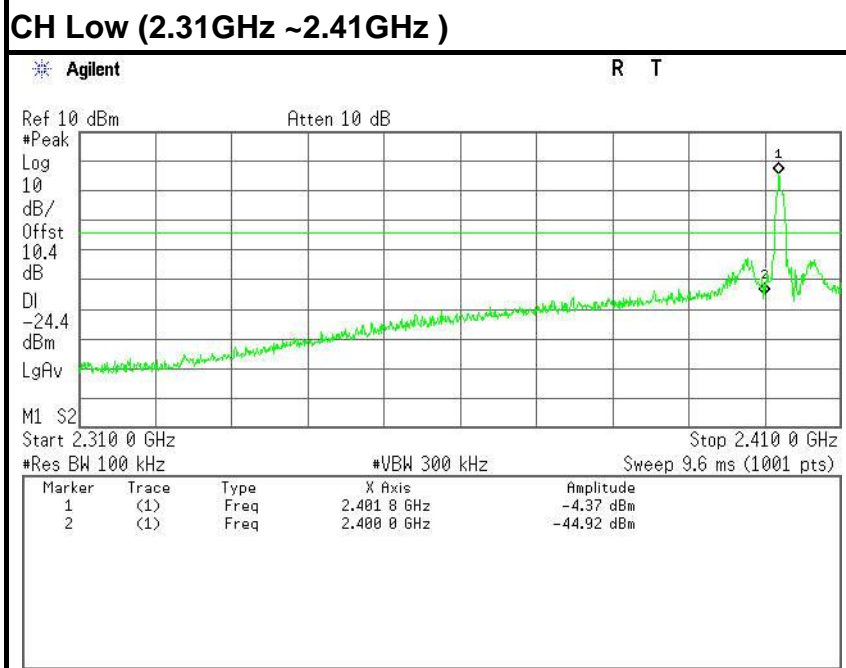
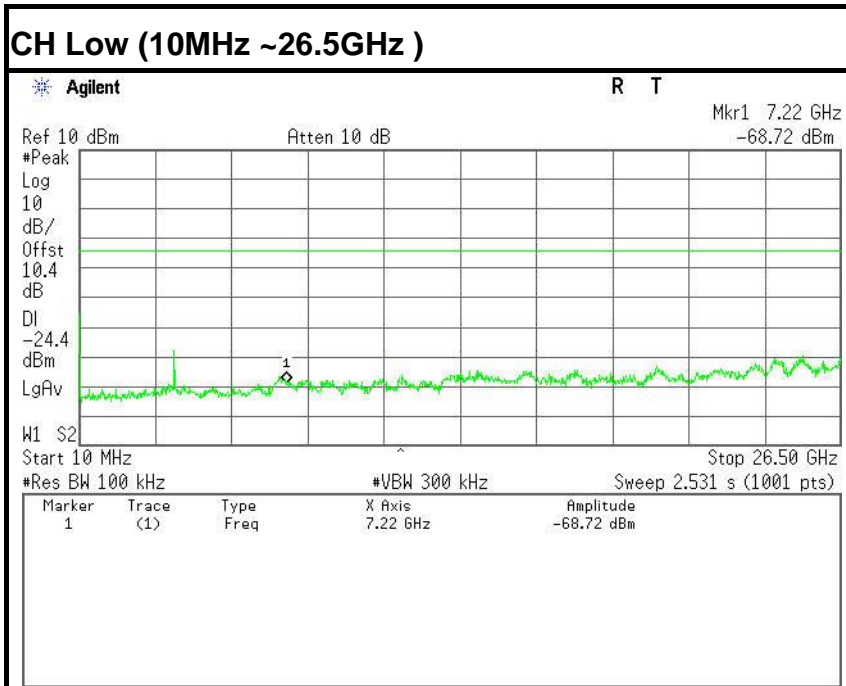

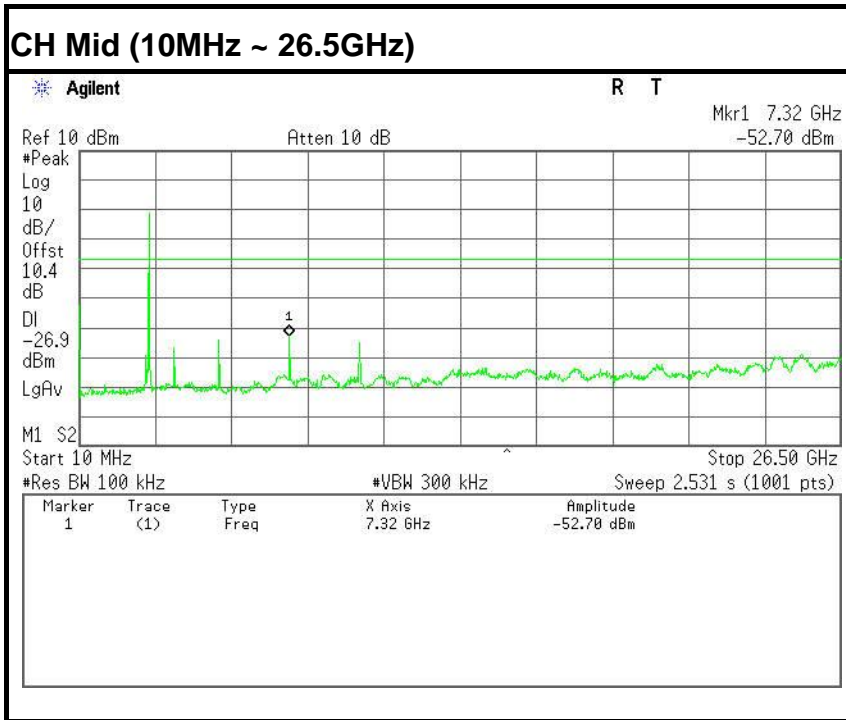

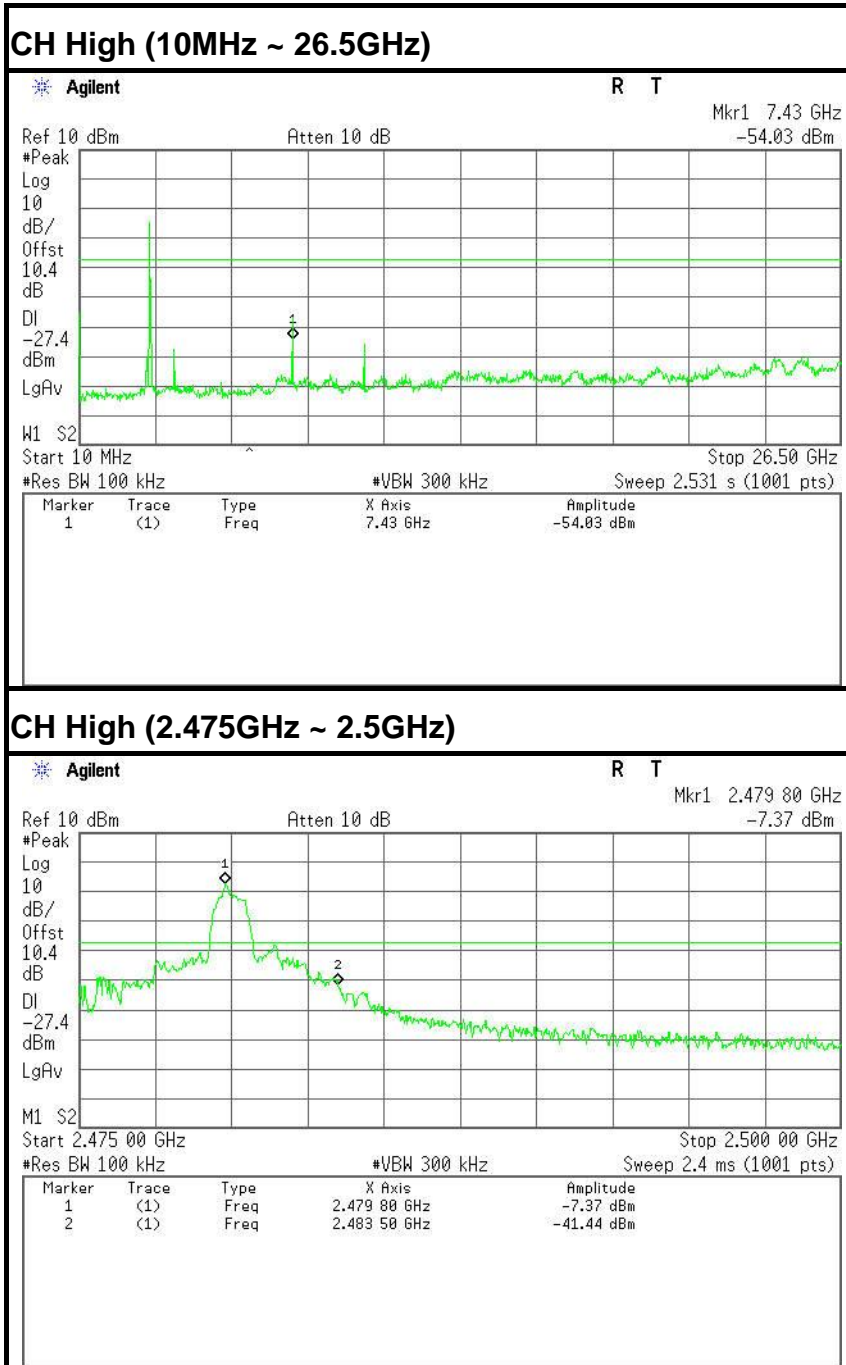



## 6.9.2. Radiated Emissions

### LIMIT

1. Except as provided elsewhere in this Subpart, the emissions from an intentional radiator shall not exceed the field strength levels specified in the following table:

Frequency (MHz)	Field Strength (mV/m)	Measurement Distance (m)
0.009-0.490	2400/F(kHz)	300
0.490-1.705	24000/F(kHz)	30
1.705-30.0	30	30
30-88	100*	3
88-216	150*	3
216-960	200*	3
Above 960	500	3

**Note:** Except as provided in paragraph (g), fundamental emissions from intentional radiators operating under this Section shall not be located in the frequency bands 54-72 MHz, 76-88 MHz, 174-216 MHz or 470-806 MHz. However, operation within these frequency bands is permitted under other sections of this Part, e.g., Sections 15.231 and 15.241.

2. In the above emission table, the tighter limit applies at the band edges.

Frequency (Hz)	Field Strength ( $\mu$ V/m at 3-meter)	Field Strength (dB $\mu$ V/m at 3-meter)
30-88	100	40
88-216	150	43.5
216-960	200	46
Above 960	500	54



**MEASUREMENT EQUIPMENT USED**

Radiated Emission Test Site 966 (2)					
Name of Equipment	Manufacturer	Model Number	Serial Number	Last Calibration	Due Calibration
PSA Series Spectrum Analyzer	Agilent	E4446A	US44300399	02/21/2016	02/20/2017
EMI TEST RECEIVER	ROHDE&SCHWARZ	ESCI	100783	02/21/2016	02/20/2017
Amplifier	MITEQ	AM-1604-3000	1123808	03/18/2016	03/18/2017
High Noise Amplifier	Agilent	8449B	3008A01838	02/21/2016	02/20/2017
Board-Band Horn Antenna	Schwarzbeck	BBHA 9170	9170-497	02/28/2016	02/27/2017
Bilog Antenna	SCHAFFNER	CBL6143	5082	02/21/2016	02/20/2017
Horn Antenna	SCHWARZBECK	BBHA9120	D286	02/28/2016	02/27/2017
Loop Antenna	COM-POWER	AL-130	121044	02/28/2016	02/27/2017
Turn Table	N/A	N/A	N/A	N.C.R	N.C.R
Controller	Sunol Sciences	SC104V	022310-1	N.C.R	N.C.R
Controller	CT	N/A	N/A	N.C.R	N.C.R
Temp. / Humidity Meter	Anymetre	JR913	N/A	02/21/2016	02/20/2017
Antenna Tower	SUNOL	TLT2	N/A	N.C.R	N.C.R
Test S/W	FARAD	LZ-RF / CCS-SZ-3A2			

**Remark:** Each piece of equipment is scheduled for calibration once a year.

**Test Configuration**

**Below 30MHz**

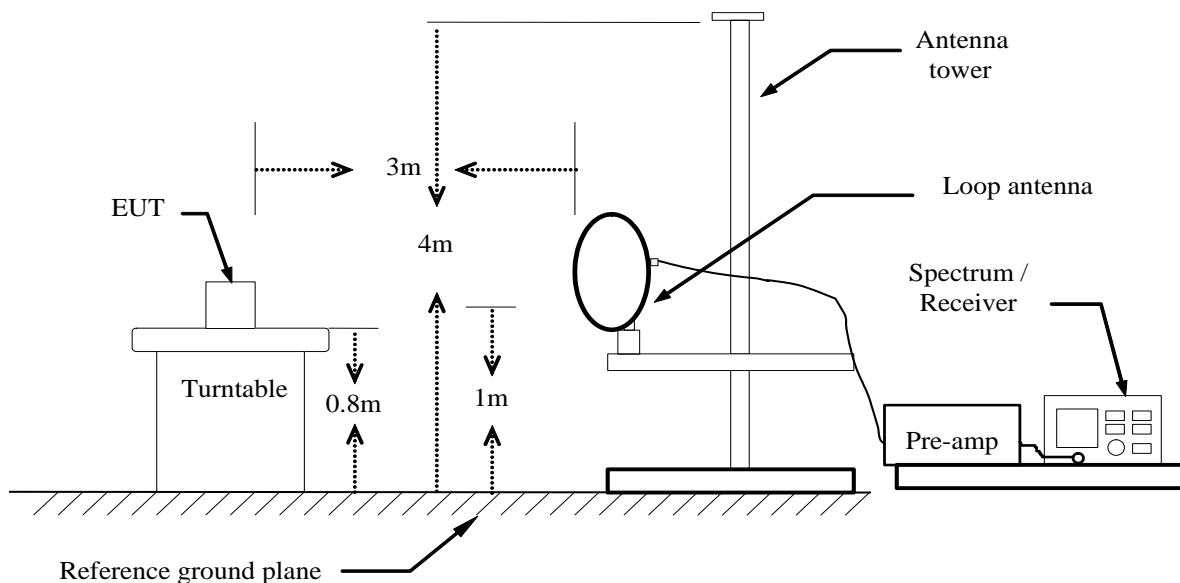





**Below 1 GHz**

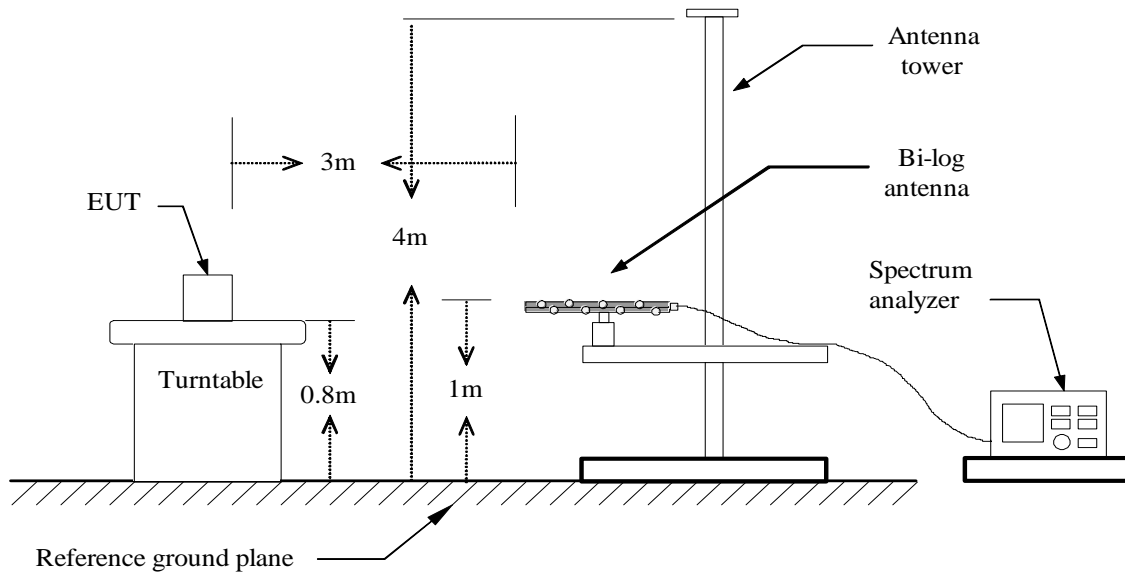

**Above 1 GHz**

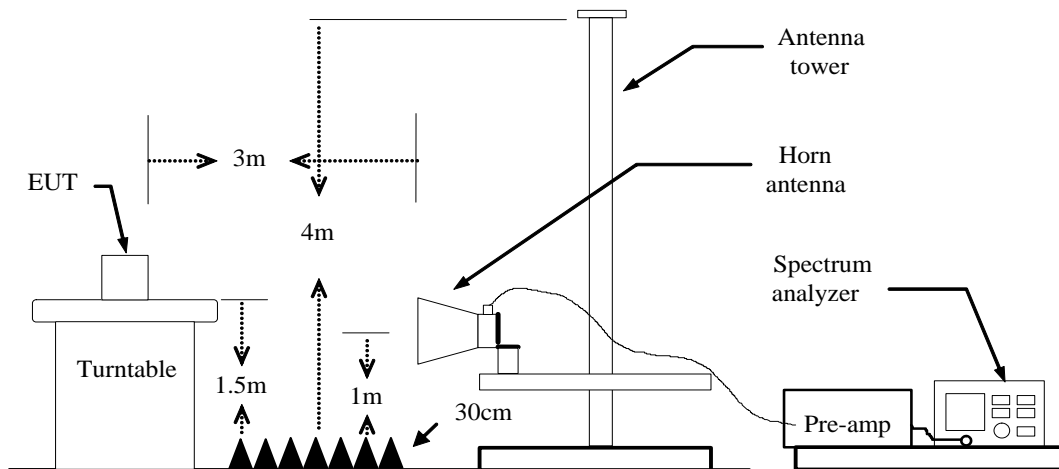



## **TEST PROCEDURE**

1. The EUT is placed on a turntable, which is 0.8m or 1.5m above ground plane.
2. The turntable shall be rotated for 360 degrees to determine the position of maximum emission level.
3. EUT is set 3m away from the receiving antenna, which is varied from 1m to 4m to find out the highest emissions.
4. Maximum procedure was performed on the six highest emissions to ensure EUT compliance.
5. And also, each emission was to be maximized by changing the polarization of receiving antenna both horizontal and vertical.
6. Repeat above procedures until the measurements for all frequencies are complete.



**TEST RESULTS**

**Below 1 GHz**

Test Mode: TX

Tested by: Darry Wu

Ambient temperature: 24°C Relative humidity: 52% RH

Date: May 20, 2016

Frequency (MHz)	Reading (dBuV)	Correction Factor (dB/m)	Result (dBuV/m)	Limit (dBuV/m)	Margin (dB)	Antenna Pole (V/H)	Remark
40.6700	53.74	-16.69	37.05	40.00	-2.95	V	QP
62.0100	60.45	-24.32	36.13	40.00	-3.87	V	QP
95.9600	64.28	-24.11	40.17	43.50	-3.33	V	QP
144.4600	59.01	-21.48	37.53	43.50	-5.97	V	QP
315.1800	60.92	-19.05	41.87	46.00	-4.13	V	QP
550.8900	50.93	-13.11	37.82	46.00	-8.18	V	QP
37.7600	49.77	-15.48	34.29	40.00	-5.71	H	QP
95.9600	62.34	-24.11	38.23	43.50	-5.27	H	QP
144.4600	63.00	-21.48	41.52	43.50	-1.98	H	QP
191.9900	63.55	-22.83	40.72	43.50	-2.78	H	QP
239.5200	64.88	-21.52	43.36	46.00	-2.64	H	QP
314.2100	57.57	-19.07	38.50	46.00	-7.50	H	QP

**\*\*Remark:** No emission found between lowest internal used/generated frequency to 30MHz.

**Notes:**

1. Measuring frequencies from 9kHz to the 1GHz.
2. Radiated emissions measured in frequency range from 30MHz to 1GHz were made with an instrument using Peak/Quasi-peak detector mode.
3. Data of measurement within this frequency range shown " --- " in the table above means the reading of emissions are attenuated more than 20dB below the permissible limits or the field strength is too small to be measured.
4. The IF bandwidth of SPA between 30MHz to 1GHz was 120kHz.
5.
 

Frequency (MHz).	= Emission frequency in MHz
Reading (dBuV)	= Receiver reading
Correction Factor(dB/m)	= Antenna factor + Cable loss – Amplifier gain
Actual FS (dBuV/m)	= Reading (dBuV) + Corr. Factor (dB/m)
Limit (dBuV/m)	= Limit stated in standard
Margin(dB)	= Measured (dBuV/m) – Limits (dBuV/m)
Antenna Pole(V/H)	= Current carrying line of reading



**Above 1 GHz**  
**GFSK**

**Test Mode:** TX(CH Low)

**Tested by:** Darry Wu

**Ambient temperature:** 24°C    **Relative humidity:** 52% RH

**Date:** May 7, 2016

Frequency (MHz)	Reading (dBuV)	Correction Factor (dB/m)	Result (dBuV/m)	Limit (dBuV/m)	Margin (dB)	Antenna Pole (V/H)	Remark
1054.000	49.90	-8.35	41.55	74.00	-32.45	V	peak
1603.000	47.30	-6.69	40.61	74.00	-33.39	V	peak
3331.000	46.81	-0.80	46.01	74.00	-27.99	V	peak
4807.000	45.40	4.35	49.75	74.00	-24.25	V	peak
5608.000	41.14	5.92	47.06	74.00	-26.94	V	peak
7210.000	45.39	8.11	53.50	74.00	-20.50	V	peak
7210.000	39.76	8.11	47.87	54.00	-6.13	V	VGA
1054.000	48.72	-8.35	40.37	74.00	-33.63	H	Peak
2557.000	45.09	-2.16	42.93	74.00	-31.07	H	Peak
3331.000	48.15	-0.80	47.35	74.00	-26.65	H	Peak
4807.000	44.12	4.35	48.47	74.00	-25.53	H	peak
4987.000	40.86	4.94	45.80	74.00	-28.20	H	peak
7210.000	44.23	8.11	52.34	74.00	-21.66	H	peak
7210.000	42.26	8.11	50.37	54.00	-3.63	H	VGA

**Notes:**

1. Measuring frequencies from 1 GHz to the 10th harmonic of highest fundamental frequency.
2. Measurements above show only up to 6 maximum emissions noted, or would be lesser if no specific emissions from the EUT are recorded (ie: margin>20dB from the applicable limit) and considered that's already beyond the background noise floor.
3. Radiated emissions measured in frequency above 1000MHz were made with an instrument using Peak detector mode and average detector mode of the emission shown in Actual FS column.
4. Spectrum setting:
  - a. Peak Setting 1GHz - 26GHz, RBW = 1MHz, VBW = 1MHz, Sweep time = auto.
  - b. AV Setting 1GH z- 26GHz, RBW = 1MHz, VBW = 330Hz, Sweep time = auto.
5. Frequency (MHz)                   = Emission frequency in MHz  
 Reading (dBuV/m)                =Uncorrected Analyzer / Receiver Reading  
 Correction Factor (dB)         = Antenna factor + Cable loss – Amplifier gain  
 Limit (dBuV/m)                   = Limit stated in standard  
 Margin (dB)                        = Result (dBuV/m)- Limit (dBuV/m)  
 Pk                                     = Peak Reading  
 AV.                                    = Average Reading  
 Remark                               = Mark Peak Reading or Average Reading



Test Mode: TX(CH Mid)

Tested by: Darry Wu

Ambient temperature: 24°C Relative humidity: 52% RH

Date: May 7, 2016

Frequency (MHz)	Reading (dBuV)	Correction Factor (dB/m)	Result (dBuV/m)	Limit (dBuV/m)	Margin (dB)	Antenna Pole (V/H)	Remark
1054.000	50.85	-8.35	42.50	74.00	-31.50	V	peak
1153.000	49.02	-7.97	41.05	74.00	-32.95	V	peak
3331.000	47.61	-0.80	46.81	74.00	-27.19	V	peak
4879.000	45.53	4.59	50.12	74.00	-23.88	V	peak
6535.000	40.70	6.95	47.65	74.00	-26.35	V	peak
6967.000	40.91	7.65	48.56	74.00	-25.44	V	peak
1243.000	48.69	-7.63	41.06	74.00	-32.94	H	Peak
2836.000	44.15	-1.66	42.49	74.00	-31.51	H	Peak
3331.000	47.57	-0.80	46.77	74.00	-27.23	H	Peak
4879.000	43.33	4.59	47.92	74.00	-26.08	H	peak
5761.000	40.53	5.98	46.51	74.00	-27.49	H	peak
7318.000	45.05	8.32	53.37	74.00	-20.63	H	peak
7318.000	43.63	8.32	51.95	54.00	-2.05	H	VGA

Notes:

1. Measuring frequencies from 1 GHz to the 10th harmonic of highest fundamental frequency.
2. Measurements above show only up to 6 maximum emissions noted, or would be lesser if no specific emissions from the EUT are recorded (ie: margin>20dB from the applicable limit) and considered that's already beyond the background noise floor.
3. Radiated emissions measured in frequency above 1000MHz were made with an instrument using Peak detector mode and average detector mode of the emission shown in Actual FS column.
4. Spectrum setting:
  - a. Peak Setting 1GHz - 26GHz, RBW = 1MHz, VBW = 1MHz, Sweep time = auto.
  - b. AV Setting 1GH z- 26GHz, RBW = 1MHz, VBW = 330Hz, Sweep time = auto.
5. Frequency (MHz) = Emission frequency in MHz  
 Reading (dBuV/m) =Uncorrected Analyzer / Receiver Reading  
 Correction Factor (dB) = Antenna factor + Cable loss – Amplifier gain  
 Limit (dBuV/m) = Limit stated in standard  
 Margin (dB) = Result (dBuV/m)- Limit (dBuV/m)  
 Pk = Peak Reading  
 AV. = Average Reading  
 Remark = Mark Peak Reading or Average Reading



Test Mode: TX(CH High)

Tested by: Darry Wu

Ambient temperature: 24°C Relative humidity: 52% RH

Date: May 7, 2016

Frequency (MHz)	Reading (dBuV)	Correction Factor (dB/m)	Result (dBuV/m)	Limit (dBuV/m)	Margin (dB)	Antenna Pole (V/H)	Remark
1153.000	49.04	-7.97	41.07	74.00	-32.93	V	peak
3331.000	47.56	-0.80	46.76	74.00	-27.24	V	peak
4195.000	42.22	2.28	44.50	74.00	-29.50	V	peak
4960.000	45.04	4.85	49.89	74.00	-24.11	V	peak
6031.000	41.65	6.13	47.78	74.00	-26.22	V	peak
7435.000	41.69	8.55	50.24	74.00	-23.76	V	peak
1153.000	48.37	-7.97	40.40	74.00	-33.60	H	Peak
2557.000	44.99	-2.16	42.83	74.00	-31.17	H	Peak
3331.000	46.57	-0.80	45.77	74.00	-28.23	H	Peak
4960.000	45.44	4.85	50.29	74.00	-23.71	H	peak
6724.000	40.80	7.25	48.05	74.00	-25.95	H	peak
7435.000	46.37	8.55	54.92	74.00	-19.08	H	peak
7435.000	39.68	8.55	48.23	54.00	-5.77	H	VGA

**Notes:**

1. Measuring frequencies from 1 GHz to the 10th harmonic of highest fundamental frequency.
2. Measurements above show only up to 6 maximum emissions noted, or would be lesser if no specific emissions from the EUT are recorded (ie: margin>20dB from the applicable limit) and considered that's already beyond the background noise floor.
3. Radiated emissions measured in frequency above 1000MHz were made with an instrument using Peak detector mode and average detector mode of the emission shown in Actual FS column.
4. Spectrum setting:
  - a. Peak Setting 1GHz - 26GHz, RBW = 1MHz, VBW = 1MHz, Sweep time = auto.
  - b. AV Setting 1GH z- 26GHz, RBW = 1MHz, VBW = 330Hz, Sweep time = auto.
5. Frequency (MHz) = Emission frequency in MHz  
 Reading (dBuV/m) =Uncorrected Analyzer / Receiver Reading  
 Correction Factor (dB) = Antenna factor + Cable loss – Amplifier gain  
 Limit (dBuV/m) = Limit stated in standard  
 Margin (dB) = Result (dBuV/m)- Limit (dBuV/m)  
 Pk = Peak Reading  
 AV. = Average Reading  
 Remark = Mark Peak Reading or Average Reading



**8DPSK**

**Test Mode:** TX(CH Low)

**Tested by:** Darry Wu

**Ambient temperature:** 24°C    **Relative humidity:** 52% RH

**Date:** May 7, 2016

Frequency (MHz)	Reading (dBuV)	Correction Factor (dB/m)	Result (dBuV/m)	Limit (dBuV/m)	Margin (dB)	Antenna Pole (V/H)	Remark
1153.000	49.90	-7.97	41.93	74.00	-32.07	V	peak
1594.000	47.27	-6.71	40.56	74.00	-33.44	V	peak
3331.000	47.87	-0.80	47.07	74.00	-26.93	V	peak
4807.000	43.07	4.35	47.42	74.00	-26.58	V	peak
6949.000	40.86	7.62	48.48	74.00	-25.52	V	peak
7201.000	42.67	8.09	50.76	74.00	-23.24	V	peak
1054.000	48.72	-8.35	40.37	74.00	-33.63	H	Peak
2557.000	45.09	-2.16	42.93	74.00	-31.07	H	Peak
3331.000	48.15	-0.80	47.35	74.00	-26.65	H	Peak
4807.000	44.12	4.35	48.47	74.00	-25.53	H	peak
4987.000	40.86	4.94	45.80	74.00	-28.20	H	peak
7210.000	44.23	8.11	52.34	74.00	-21.66	H	peak
7210.000	42.26	8.11	50.37	54.00	-3.63	H	VGA

**Notes:**

1. Measuring frequencies from 1 GHz to the 10th harmonic of highest fundamental frequency.
2. Measurements above show only up to 6 maximum emissions noted, or would be lesser if no specific emissions from the EUT are recorded (ie: margin>20dB from the applicable limit) and considered that's already beyond the background noise floor.
3. Radiated emissions measured in frequency above 1000MHz were made with an instrument using Peak detector mode and average detector mode of the emission shown in Actual FS column.
4. Spectrum setting:
  - a. Peak Setting 1GHz - 26GHz, RBW = 1MHz, VBW = 1MHz, Sweep time = auto.
  - b. AV Setting 1GH z- 26GHz, RBW = 1MHz, VBW = 330Hz, Sweep time = auto.
5. Frequency (MHz) = Emission frequency in MHz  
 Reading (dBuV/m) =Uncorrected Analyzer / Receiver Reading  
 Correction Factor (dB) = Antenna factor + Cable loss – Amplifier gain  
 Limit (dBuV/m) = Limit stated in standard  
 Margin (dB) = Result (dBuV/m)- Limit (dBuV/m)  
 Pk = Peak Reading  
 AV. = Average Reading  
 Remark = Mark Peak Reading or Average Reading



Test Mode: TX(CH Mid)

Tested by: Darry Wu

Ambient temperature: 24°C Relative humidity: 52% RH

Date: May 7, 2016

Frequency (MHz)	Reading (dBuV)	Correction Factor (dB/m)	Result (dBuV/m)	Limit (dBuV/m)	Margin (dB)	Antenna Pole (V/H)	Remark
3331.000	47.82	-0.80	47.02	74.00	-26.98	V	peak
4879.000	44.81	4.59	49.40	74.00	-24.60	V	peak
6148.000	40.85	6.32	47.17	74.00	-26.83	V	peak
6472.000	40.80	6.84	47.64	74.00	-26.36	V	peak
7732.000	41.20	9.13	50.33	74.00	-23.67	V	peak
7921.000	40.56	9.50	50.06	74.00	-23.94	V	peak
1252.000	48.76	-7.60	41.16	74.00	-32.84	H	Peak
3331.000	47.12	-0.80	46.32	74.00	-27.68	H	Peak
4879.000	45.15	4.59	49.74	74.00	-24.26	H	Peak
7327.000	41.67	8.34	50.01	74.00	-23.99	H	peak
7723.000	41.49	9.11	50.60	74.00	-23.40	H	peak
8398.000	40.79	9.43	50.22	74.00	-23.78	H	peak

**Notes:**

1. Measuring frequencies from 1 GHz to the 10th harmonic of highest fundamental frequency.
2. Measurements above show only up to 6 maximum emissions noted, or would be lesser if no specific emissions from the EUT are recorded (ie: margin>20dB from the applicable limit) and considered that's already beyond the background noise floor.
3. Radiated emissions measured in frequency above 1000MHz were made with an instrument using Peak detector mode and average detector mode of the emission shown in Actual FS column.
4. Spectrum setting:
  - a. Peak Setting 1GHz - 26GHz, RBW = 1MHz, VBW = 1MHz, Sweep time = auto.
  - b. AV Setting 1GH z- 26GHz, RBW = 1MHz, VBW = 330Hz, Sweep time = auto.
5. Frequency (MHz) = Emission frequency in MHz  
 Reading (dBuV/m) =Uncorrected Analyzer / Receiver Reading  
 Correction Factor (dB) = Antenna factor + Cable loss – Amplifier gain  
 Limit (dBuV/m) = Limit stated in standard  
 Margin (dB) = Result (dBuV/m)- Limit (dBuV/m)  
 Pk = Peak Reading  
 AV. = Average Reading  
 Remark = Mark Peak Reading or Average Reading





Test Mode: TX(CH High)

Tested by: Darry Wu

Ambient temperature: 24°C Relative humidity: 52% RH

Date: May 7, 2016

Frequency (MHz)	Reading (dBuV)	Correction Factor (dB/m)	Result (dBuV/m)	Limit (dBuV/m)	Margin (dB)	Antenna Pole (V/H)	Remark
1054.000	50.43	-8.35	42.08	74.00	-31.92	V	peak
2575.000	45.54	-2.12	43.42	74.00	-30.58	V	peak
3331.000	47.58	-0.80	46.78	74.00	-27.22	V	peak
4456.000	41.61	3.20	44.81	74.00	-29.19	V	peak
5356.000	39.83	5.61	45.44	74.00	-28.56	V	peak
7228.000	40.77	8.14	48.91	74.00	-25.09	V	peak
1360.000	46.76	-7.21	39.55	74.00	-34.45	H	Peak
2431.000	43.75	-2.64	41.11	74.00	-32.89	H	Peak
3331.000	47.18	-0.80	46.38	74.00	-27.62	H	Peak
4249.000	41.28	2.47	43.75	74.00	-30.25	H	peak
6949.000	40.75	7.62	48.37	74.00	-25.63	H	peak
7921.000	40.56	9.50	50.06	74.00	-23.94	H	peak

**Notes:**

1. Measuring frequencies from 1 GHz to the 10th harmonic of highest fundamental frequency.
2. Measurements above show only up to 6 maximum emissions noted, or would be lesser if no specific emissions from the EUT are recorded (ie: margin>20dB from the applicable limit) and considered that's already beyond the background noise floor.
3. Radiated emissions measured in frequency above 1000MHz were made with an instrument using Peak detector mode and average detector mode of the emission shown in Actual FS column.
4. Spectrum setting:
  - a. Peak Setting 1GHz - 26GHz, RBW = 1MHz, VBW = 1MHz, Sweep time = auto.
  - b. AV Setting 1GH z- 26GHz, RBW = 1MHz, VBW = 330Hz, Sweep time = auto.
5. Frequency (MHz) = Emission frequency in MHz  
 Reading (dBuV/m) =Uncorrected Analyzer / Receiver Reading  
 Correction Factor (dB) = Antenna factor + Cable loss – Amplifier gain  
 Limit (dBuV/m) = Limit stated in standard  
 Margin (dB) = Result (dBuV/m)- Limit (dBuV/m)  
 Pk = Peak Reading  
 AV. = Average Reading  
 Remark = Mark Peak Reading or Average Reading



## 6.10 POWERLINE CONDUCTED EMISSIONS

### LIMIT

For an intentional radiator which is designed to be connected to the public utility (AC) power line, the radio frequency voltage that is conducted back onto the AC power line on any frequency or frequencies within the band 150 kHz to 30 MHz shall not exceed 250 microvolts (The limit decreases linearly with the logarithm of the frequency in the range 0.15 MHz to 0.50 MHz). The limits at specific frequency range is listed as follows:

Frequency Range (MHz)	Limits (dB $\mu$ V)	
	Quasi-peak	Average
0.15 to 0.50	66 to 56	56 to 46
0.50 to 5	56	46
5 to 30	60	50

Compliance with this provision shall be based on the measurement of the radio frequency voltage between each power line (LINE and NEUTRAL) and ground at the power terminals.

### MEASUREMENT EQUIPMENT USED

Conducted Emission Test Site					
Name of Equipment	Manufacturer	Model Number	Serial Number	Last Calibration	Due Calibration
EMI TEST RECEIVER	ROHDE&SCHWARZ	ESCI	100783	02/21/2016	02/20/2017
LISN(EUT)	ROHDE&SCHWARZ	ENV216	101543-WX	02/21/2016	02/20/2017
LISN	EMCO	3825/2	8901-1459	02/21/2016	02/20/2017
Temp. / Humidity Meter	VICTOR	HTC-1	N/A	02/21/2016	02/20/2017
Test S/W	FARAD	EZ-EMC/ CCS-3A1-CE			

**Remark:** Each piece of equipment is scheduled for calibration once a year.



## Test Configuration

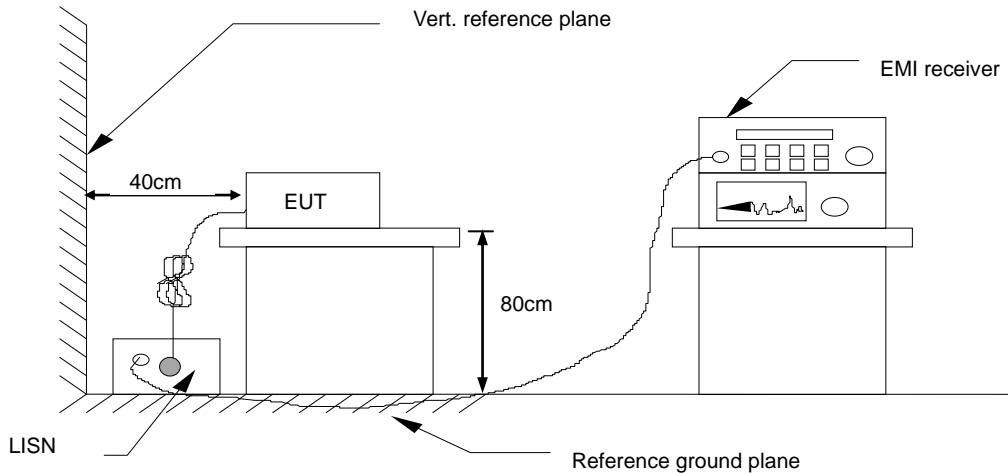

See test photographs attached in Appendix 1 for the actual connections between EUT and support equipment.

## TEST PROCEDURE

1. The EUT was placed on a table, which is 0.8m above ground plane.
2. Maximum procedure was performed on the six highest emissions to ensure EUT compliance.
3. Repeat above procedures until all frequency measured were complete.

## TEST RESULTS

The initial step in collecting conducted data is a spectrum analyzer peak scan of the measurement range. Significant peaks are then marked as shown on the following data page, and these signals are then quasi-peaked.



**Test Data**

**Operation Mode:** Mode 1

**Test Date:** April 26, 2016

**Temperature:** 22°C

**Humidity:** 45% RH

**Tested by:** Darry Wu

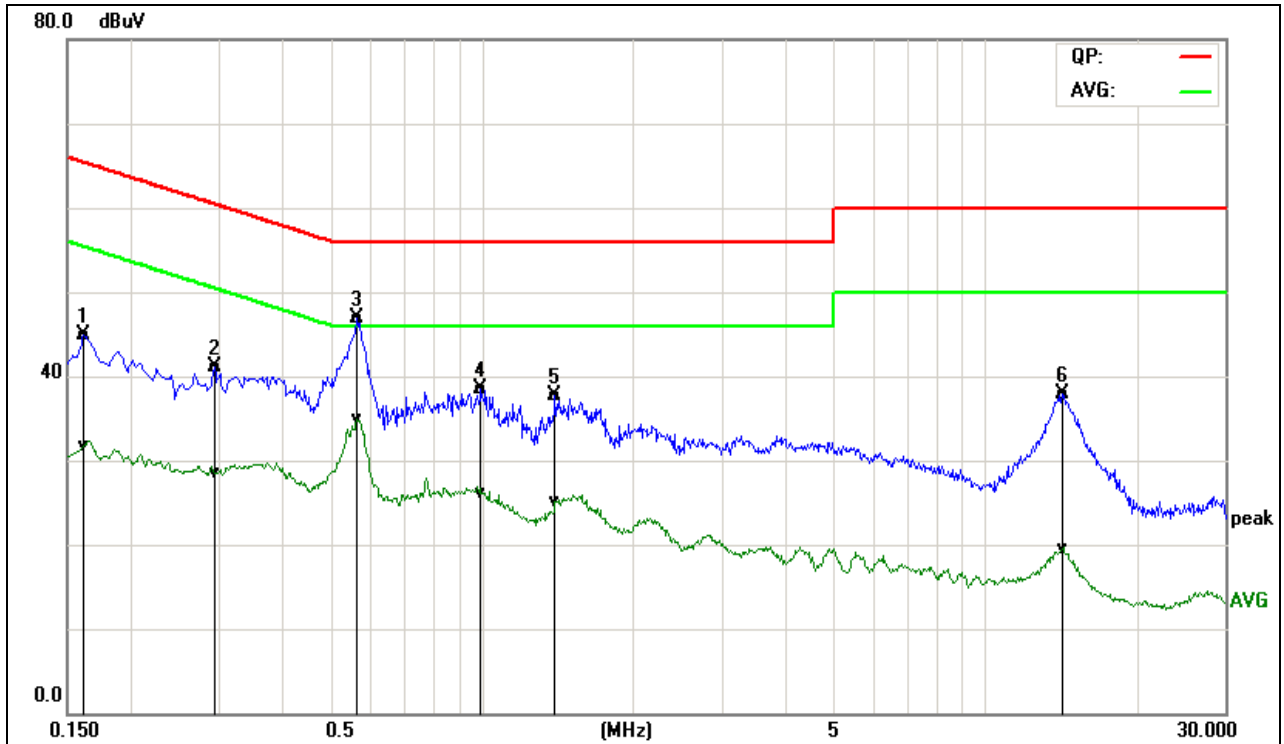

Frequency (MHz)	QuasiPeak Reading (dBuV)	Average Reading (dBuV)	Correction Factor (dB)	QuasiPeak Result (dBuV)	Average Result (dBuV)	QuasiPeak Limit (dBuV)	Average Limit (dBuV)	QuasiPeak Margin (dB)	Average Margin (dB)	Line (L1/L2)
0.1620	35.14	21.97	9.78	44.92	31.75	65.36	55.36	-20.44	-23.61	L1
0.2940	31.24	18.63	9.82	41.06	28.45	60.41	50.41	-19.35	-21.96	L1
0.5660	37.00	24.95	9.88	46.88	34.83	56.00	46.00	-9.12	-11.17	L1
0.9980	28.55	16.25	9.91	38.46	26.16	56.00	46.00	-17.54	-19.84	L1
1.4020	27.82	15.17	9.92	37.74	25.09	56.00	46.00	-18.26	-20.91	L1
14.2780	27.72	9.33	10.10	37.82	19.43	60.00	50.00	-22.18	-30.57	L1

**Note:**

1. Measuring frequencies from 0.15 MHz to 30MHz.
2. The emissions measured in frequency range from 0.15 MHz to 30MHz were made with an instrument using Peak detector, Quasi-peak detector and average detector.
3. “---” denotes the emission level was or more than 2dB below the Average limit.
4. The IF bandwidth of SPA between 0.15MHz to 30MHz was 10kHz; the IF bandwidth of Test Receiver between 0.15MHz to 30MHz was 9kHz;
5. L1= Line One (Live Line)



Operation Mode: Mode 1

Test Date: April 26, 2016

Temperature: 22°C

Humidity: 45% RH

Tested by: Darry Wu

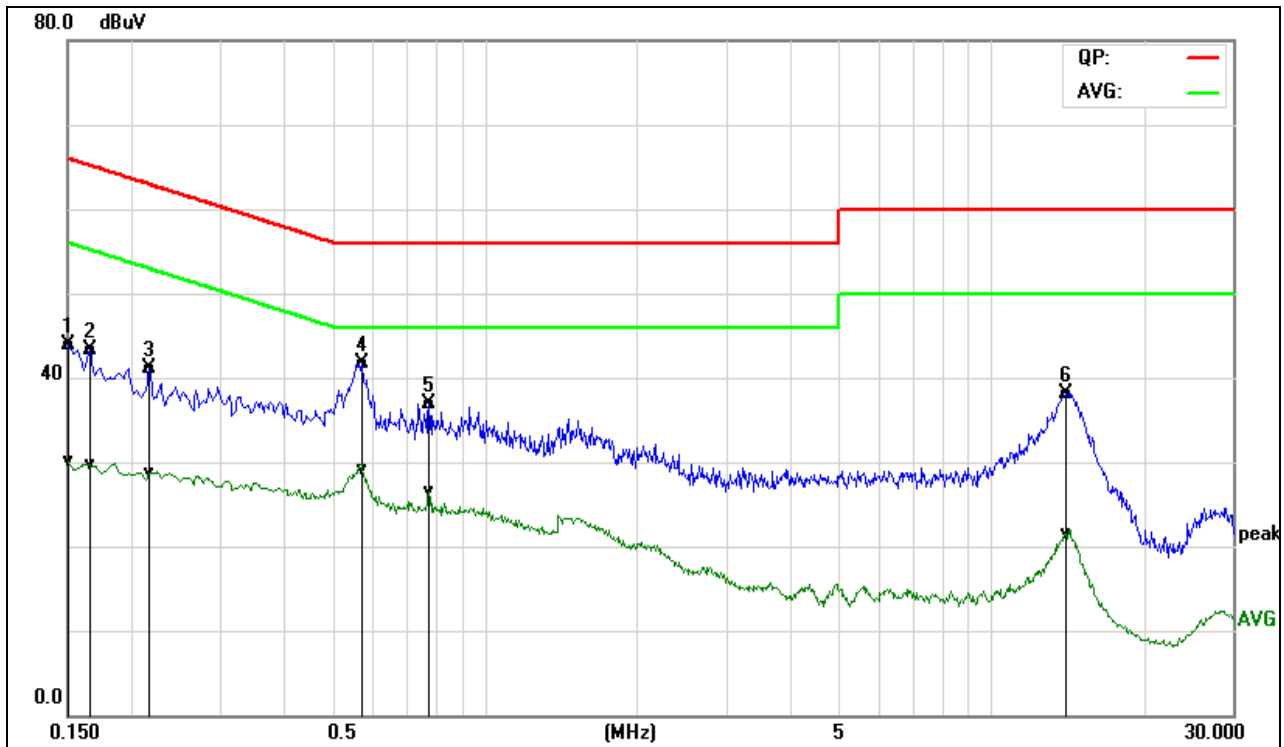

Frequency (MHz)	QuasiPeak Reading (dBuV)	Average Reading (dBuV)	Correction Factor (dB)	QuasiPeak Result (dBuV)	Average Result (dBuV)	QuasiPeak Limit (dBuV)	Average Limit (dBuV)	QuasiPeak Margin (dB)	Average Margin (dB)	Line (L1/L2)
0.1500	33.95	20.17	9.88	43.83	30.05	65.99	56.00	-22.16	-25.95	L2
0.1660	33.41	19.74	9.88	43.29	29.62	65.15	55.16	-21.86	-25.54	L2
0.2180	31.13	18.89	9.89	41.02	28.78	62.89	52.89	-21.87	-24.11	L2
0.5740	31.87	19.28	9.88	41.75	29.16	56.00	46.00	-14.25	-16.84	L2
0.7780	27.04	16.63	9.90	36.94	26.53	56.00	46.00	-19.06	-19.47	L2
14.1020	28.04	11.32	10.10	38.14	21.42	60.00	50.00	-21.86	-28.58	L2

Note:

1. Measuring frequencies from 0.15 MHz to 30MHz.
2. The emissions measured in frequency range from 0.15 MHz to 30MHz were made with an instrument using Peak detector, Quasi-peak detector and average detector.
3. "---" denotes the emission level was or more than 2dB below the Average limit.
4. The IF bandwidth of SPA between 0.15MHz to 30MHz was 10kHz; the IF bandwidth of Test Receiver between 0.15MHz to 30MHz was 9kHz;
5. L2= Line Two (Neutral Line)