

**ELECTROMAGNETIC EMISSIONS COMPLIANCE REPORT
INTENTIONAL RADIATOR CERTIFICATION TO
FCC PART 15 SUBPART C REQUIREMENT**

OF

Mobile DVD Player With FM/AM Tuner

MODEL No.: VM9725BT

BRAND NAME: Jensen, Foryou

FCC ID: VIPVM9725BT

REPORT NO: KAD120529062F

ISSUE DATE: August 28, 2012

Prepared for

**HUIZHOU FORYOU GENERAL ELECTRONICS CO., LTD.
NO.6 Zhongkai Songshan Industrial District, Huizhou, Guangdong, China**

Prepared by

DONGGUAN EMTEK CO., LTD.

**No.281, Guantai Road, Nancheng District,
Dongguan, Guangdong, China
TEL: 86-769-22807078
FAX: 86-769-22807079**

VERIFICATION OF COMPLIANCE

Applicant:	HUIZHOU FORYOU GENERAL ELECTRONICS CO., LTD. NO.6 Zhongkai Songshan Industrial District, Huizhou, Guangdong, China
Manufacturer:	HUIZHOU FORYOU GENERAL ELECTRONICS CO., LTD. NO.6, Huifeng 7 Road, Zhongkai Songshan Industrial District, Huizhou, Guangdong, China.
Product Description:	Mobile DVD Player With FM/AM Tuner
Brand Name:	Jensen, Foryou
Model Number:	VM9725BT
Serial Number:	N/A
Kind of Device:	Bluetooth Ver. 2.0+EDR
File Number:	KAD120529062F
Date of Test:	May 29, 2012 to August 28, 2012

We hereby certify that:

The above equipment was tested by DONGGUAN EMTEK CO., LTD. The test data, data evaluation, test procedures, and equipment configurations shown in this report were made in accordance with the procedures given in ANSI C63.4 (2009) and the energy emitted by the sample EUT tested as described in this report is in compliance with conducted and radiated emission limits of FCC Rules Part 15.247.

The test results of this report relate only to the tested sample identified in this report.

Approved By



Sam Lv / Q.A. Manager
DONGGUAN EMTEK CO., LTD.

Table of Contents

1.	GENERAL INFORMATION.....	5
1.1	PRODUCT DESCRIPTION.....	5
1.2	RELATED SUBMITTAL(S) / GRANT (S)	5
1.3	TEST METHODOLOGY.....	5
1.4	SPECIAL ACCESSORIES	5
1.5	EQUIPMENT MODIFICATIONS	5
1.6	TEST FACILITY	6
2.	SYSTEM TEST CONFIGURATION	7
2.1	EUT CONFIGURATION	7
2.2	EUT EXERCISE	7
2.3	TEST PROCEDURE.....	7
2.4	LIMITATION	7
2.5	CONFIGURATION OF TESTED SYSTEM	11
3.	SUMMARY OF TEST RESULTS	12
4.	DESCRIPTION OF TEST MODES	12
5.	RADIATED EMISSION TEST	13
5.1	MEASUREMENT PROCEDURE.....	13
5.2	TEST SET-UP (BLOCK DIAGRAM OF CONFIGURATION)	14
5.3	MEASUREMENT EQUIPMENT USED:	15
5.4	MEASUREMENT RESULT.....	15
5.5	RADIATED MEASUREMENT PHOTOS:	23
6.	CHANNEL SEPARATION TEST	24
6.1	MEASUREMENT PROCEDURE.....	24
6.2	TEST SET-UP (BLOCK DIAGRAM OF CONFIGURATION)	24
6.3	MEASUREMENT EQUIPMENT USED:	24
6.4	MEASUREMENT RESULTS:.....	24
7.	20DB BANDWIDTH TEST	26
7.1	MEASUREMENT PROCEDURE.....	26
7.2	TEST SET-UP (BLOCK DIAGRAM OF CONFIGURATION)	26
7.3	MEASUREMENT EQUIPMENT USED:	26
7.4	MEASUREMENT RESULTS:.....	26
8.	QUANTITY OF HOPPING CHANNEL TEST.....	32
8.1	MEASUREMENT PROCEDURE.....	32
8.2	TEST SET-UP (BLOCK DIAGRAM OF CONFIGURATION)	32
8.3	MEASUREMENT EQUIPMENT USED:	32
8.4	MEASUREMENT RESULTS:.....	32

9.	TIME OF OCCUPANCY (DWELL TIME) TEST	33
9.1	TEST DESCRIPTION	33
9.2	TEST REQUIREMENTS / LIMITS	33
9.3	TEST PROTOCOL	33
9.4	TEST RESULT: DWELL TIME.....	33
10.	MAXIMUM PEAK OUTPUT POWER TEST	35
10.1	MEASUREMENT PROCEDURE.....	35
10.2	TEST SET-UP (BLOCK DIAGRAM OF CONFIGURATION)	35
10.3	MEASUREMENT EQUIPMENT USED:	35
10.4	MEASUREMENT RESULTS:.....	36
11.	BAND EDGE TEST.....	41
11.1	MEASUREMENT PROCEDURE.....	41
11.2	TEST SET-UP (BLOCK DIAGRAM OF CONFIGURATION)	41
11.3	MEASUREMENT EQUIPMENT USED:	41
11.4	MEASUREMENT RESULTS:.....	42
12.	ANTENNA APPLICATION.....	46
12.1	ANTENNA REQUIREMENT	46
12.2	RESULT	46
13.	RF EXPOSURE EVALUATION	47
13.1	FRIIS TRANSMISSION FORMULA: $P_D=(P_{OUT}*G)/(4*\pi*R^2)$	47
13.2	MEASUREMENT RESULT.....	47

1. GENERAL INFORMATION

1.1 Product Description

The HUIZHOU FORYOU GENERAL ELECTRONICS CO., LTD. Model: VM9725BT (referred to as the EUT in this report) The EUT is an short range, lower power, Mobile DVD Player With FM/AM Tuner designed as an Input Device. It is designed by way of utilizing the following modulation achieves the system operating.

A major technical descriptions of EUT is described as following:

- A). Operation Frequency: 2402-2480MHz
- B). Modulation: GFSK, DQPSK, 8DPSK
- C). Number of Channel: 79
- D). Channel space: 1MHz
- E). Rated RF Output Power: 1.42dBm
- F). Antenna Type: Internal PCB antenna
- G). Antenna GAIN: -2.34dBi
- H). Power Supply: DC 12.0~14.4V

The basic data rate of 1Mbps uses GFSK modulation and the enhanced data rate uses PSK modulation. For the enhanced data rate of 3Mbps 8DPSK modulation and of 2Mbps DQPSK modulation is used.

1.2 Related Submittal(s) / Grant (s)

This submittal(s) (test report) is intended for FCC ID: VIPVM9725BT filing to comply with Section 15.247 of the FCC Part 15, Subpart C Rules and FCC Public Notice DA 00-705.

1.3 Test Methodology

Both conducted and radiated testing were performed according to the procedures in ANSI C63.4 (2009). Radiated testing was performed at an antenna to EUT distance 3 meters.

1.4 Special Accessories

Not available for this EUT intended for grant.

1.5 Equipment Modifications

Not available for this EUT intended for grant.

1.6 Test Facility

Site Description

EMC Lab. : Accredited by FCC, Aug. 18, 2011
The Certificate Number is 247565.

Accredited by Industry Canada, January 13, 2011
The Certificate Number is 9444A

Name of Firm : DONGGUAN EMTEK CO., LTD.

Site Location : No.281, Guantai Road, Nancheng District,
Dongguan, Guangdong, China

2. System Test Configuration

2.1 EUT Configuration

The EUT configuration for testing is installed on RF field strength measurement to meet the Commissions requirement and operating in a manner which intends to maximize its emission characteristics in a continuous normal application.

2.2 EUT Exercise

The Transmitter was operated in the normal operating mode. the Tx frequency was fixed which was for the purpose of the measurements.

2.3 Test Procedure

2.3.1 Conducted Emissions

The EUT is a placed on as turn table which is 0.8 m above ground plane. According to the requirements in Section 13.1.4.1 of ANSI C63.4-2009. Conducted emissions from the EUT measured in the frequency range between 0.15 MHz and 30MHz using CISPR Quasi-Peak and average detector mode.

2.3.2 Radiated Emissions

The EUT is a placed on as turn table which is 0.8 m above ground plane. The turn table shall rotate 360 degrees to determine the position of maximum emission level. EUT is set 3m away from the receiving antenna which varied from 1m to 4m to find out the highest emission. And also, each emission was to be maximized by changing the polarization of receiving antenna both horizontal and vertical. In order to find out the max. emission, the relative positions of this hand-held transmitter(EUT) was rotated through three orthogonal axes according to the requirements in Section 13.1.4.1 of ANSI C63.4-2009.

2.4 Limitation

(1) Channel Separation test

FCC Part 15, Subpart C Section 15.247(a)(1). Frequency hopping systems shall have hopping channel carrier frequencies separated by a minimum of 25kHz or the 20 Bandwidth of the hopping channel, whichever is greater.

Frequency Range (MHz)	Limit(kHz)
902-928	>25kHz
2400-2483.5	>25kHz
5725-5850	>25kHz

(2) 20dB Bandwidth

Frequency Range(MHz)	Quantity of Hopping Channel	Limit(kHz)			
		50	25	15	75
902-928		<250	>250	NA	NA
2400-2483.5		NA	NA	>1000	<1000

(3) Quantity of Hopping Channel

FCC Part 15, Subpart C Section 15.247

Frequency Range (MHz)	Limit(Quantity of Hopping Channel)			
	20dB bandwidth <250kHz	20dB bandwidth >250kHz	20dB bandwidth <1MHz	20dB bandwidth >1MHz
902-928	50	25	NA	NA
2400-2483.5	NA	NA	15	15
5725-5850	NA	NA	75	NA

(4) Time of Occupancy(Dwell Time)

FCC Part 15, Subpart C Section 15.247

Frequency Range (MHz)	LIMIT(rms)		
	20dB bandwidth <250kHz(50Channel)	20dB bandwidth >250kHz(25Channel)	20dB bandwidth <1MHz(75Channel)
902-928	400(20S)	400(10S)	NA
2400-2483.5	NA	NA	400(30S)
5725-5850	NA	NA	400(30S)

Note: The “()” is all channel’s average time of occupancy.

(5) Maximum Peak Output Power

FCC Part 15, Subpart C Section 15.247

Frequency Range (MHz)	Quantity of Hopping Channel	LIMIT(W)			
		50	25	15	75
902-928		1(30dBm)	0.125(21dBm)	NA	NA
2400-2483.5		NA	NA	0.125(21dBm)	1(30dBm)
5725-5850		NA	NA	NA	1(30dBm)

(6) Band edge

FCC Part15, Subpart C Section 15.247, In any 100kHz bandwidth outside the frequency band in with the spread spectrum intentional radiator is operating, the radio frequency power that is produced by the intentional radiator shall be at least 20dB below that in the 100kHz bandwidth within the band that contains the highest level of the desired power, based on either an RF conducted or a radiated measurement, attenuation below the general limits specified in section 15.209(a) is not required. In addition, radiated emissions which fall in the restricted bands, as defined in section 15.205(a), must also comply with the radiated emission limits specified in section 15.209(a).

Operating Frequency Range(MHz)	Spurious emission frequency	Limit	
		Peak power ration to emission(dBc)	Emission level(dBuV/m)
902-928	<902	>20	NA
	>928	>20	NA
	960-1240	NA	54
2400-2483.5	<2400	>20	NA
	>2483.5-2500	NA	54
5725-5850	<5350-5460	NA	54
	<5725	>20	NA
	>5850	>20	NA

(7) Conducted Emission

Frequency(MHz)	Quasi-peak	Average
0.15-0.5	66-56	56-46
0.5-5.0	56	46
5.0-30.0	60	50

Note:

1. The lower limit shall apply at the transition frequencies
2. The limit decreases in line with the logarithm of the frequency in the range of 0.15 to 0.50MHz.

(8) Radiated Emission

FCC Part 15, Subpart C Section 15.209 limit of radiated emission for frequency below 1000GHz. The emissions from an intentional radiator shall not exceed the field strength level specified in the following table:

Frequency (MHz)	Field strength $\mu\text{V/m}$	Distance(m)	Field strength at 3m $\text{dB}\mu\text{V/m}$
0.009-0.490	2400/F(kHz)	300	/
0.490-1.705	24000/F(kHz)	30	/
1.705-30.0	30	30	/
30-88	100	3	40
88-216	150	3	43.5
216-960	200	3	46
Above 960	500	3	54

Remark: 1. Emission level in $\text{dB}\mu\text{V/m}=20 \log (\text{uV/m})$
 2. Measurement was performed at an antenna to the closed point of EUT distance of meters.

FCC Part 15, Section 15.35(b) limit of radiated emission for frequency above 1000MHz

Frequency(MHz)	Class A($\text{dB}\mu\text{V/m}$)(at 3m)		Class B($\text{dB}\mu\text{V/m}$)(at 3m)	
	PEAK	AVERAGE	PEAK	AVERAGE
Above 1000	80.0	60.0	74.0	54.0

FCC Part 15, Subpart C Section 15.249. The field strength of emissions from intentional radiators operated within these frequency bands shall comply with the following:

Frequency(MHz)	Filed Strength of Fundamental(at 3m)		Filed Strength of Harmonics(at 3m)	
	PEAK	AVERAGE	PEAK	AVERAGE
902-928	114	94	74.0	54.0
2400-2483.5	114	94	74.0	54.0
5725-5875	114	94	74.0	54.0
24000-24250	128	108	88.0	68.0

2.5 Configuration of Tested System

Fig. 2-1 Configuration of Tested System



Table 2-1 Equipment Used in Tested System

Item	Equipment	Mfr/Brand	Model/Type No.	FCC ID	Series No.	Note
1.	Mobile DVD Player With FM/AM Tuner	Jensen, Foryou	VM9725BT	VIPVM9725 BT	N/A	<i>EUT</i>

Note:

- (1) Unless otherwise denoted as EUT in 『Remark』 column , device(s) used in tested system is a support equipment.

3. Summary of Test Results

FCC Rules	Description Of Test	Result
§ 15.247(a)(1)	Channel Separation test	Compliant
§ 15.247(a)(1)	20dB Bandwidth	Compliant
§ 15.247(a)(1)(iii)	Quantity of Hopping Channel	Compliant
§ 15.247(a)(1)(iii)	Time of Occupancy(Dwell Time)	Compliant
§ 15.247(b)	Max Peak output Power test	Compliant
§ 15.247(d)	Band edge test	Compliant
§ 15.207	AC Power Conducted Emission	N/A
§ 15.247(d), § 15.209	Radiated Emission	Compliant
§ 15.203	Antenna Requirement	Compliant
§ 1.1310	RF Exposure	Compliant

Remark: The EUT is supplied by Battery, there is no need for AC Power Conducted Emission test to be performed on this product.

4. Description of test modes

The EUT (MOBILE DVD PLAYER WITH FM/AM TUNER) has been tested under normal operating condition.

This EUT is a FHSS system, we use blue test to control the EUT with parallel port, Let EUT hopping on and transmit at every channel with highest power, Only output power use conducted method, others are using radiated method. After sirfdemo330R1 send the command to EUT, it can be removed, and the EUT keep hopping. 79 Channels are provided by EUT. The operating modes of the EUTs used for testing are described as follows:

Op. Mode	Description of Operating Modes	Remarks
op-mode 1	The EUT transmits on 2402 MHz	Basic data rate 1 Mbps
op-mode 2	The EUT transmits on 2441 MHz	Basic data rate 1 Mbps
op-mode 3	The EUT transmits on 2480 MHz	Basic data rate 1 Mbps
op-mode 4	The EUT is in hopping mode	The EUT is hopping on 79 channels, Basic data rate 1Mbps
op-mode 6	The EUT transmits on 2402 MHz	Enhanced data rate 3 Mbps
op-mode 7	The EUT transmits on 2441 MHz	Enhanced data rate 3 Mbps
op-mode 8	The EUT transmits on 2480 MHz	Enhanced data rate 3 Mbps
op-mode 10	The EUT transmits on 2402 MHz	Enhanced data rate 2 Mbps
op-mode 11	The EUT transmits on 2441 MHz	Enhanced data rate 2 Mbps
op-mode 12	The EUT transmits on 2480 MHz	Enhanced data rate 2 Mbps

5. Radiated Emission Test

5.1 Measurement Procedure

1. The EUT was placed on a turn table which is 0.8m above ground plane.
2. Maximum procedure was performed on the six highest emissions to ensure EUT compliance.
3. And also, each emission was to be maximized by changing the polarization of receiving antenna both horizontal and vertical.
4. Repeat above procedures until all frequency measured were complete.
5. For range 9KHz~30MHz, The measured value is really too low to be recorded.

5.2 Test SET-UP (Block Diagram of Configuration)

(A) Radiated Emission Test Set-Up, Frequency Below 30MHz

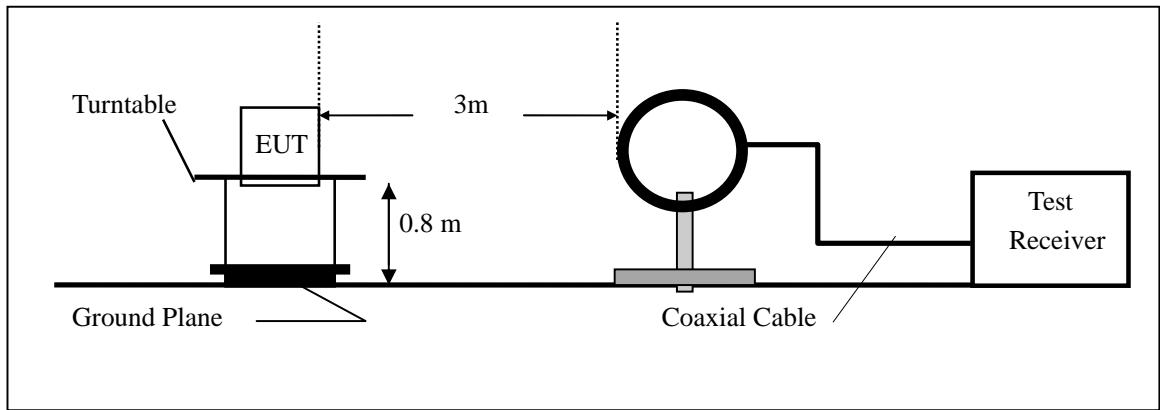

(B) Radiated Emission Test Set-Up, Frequency Below 1000MHz

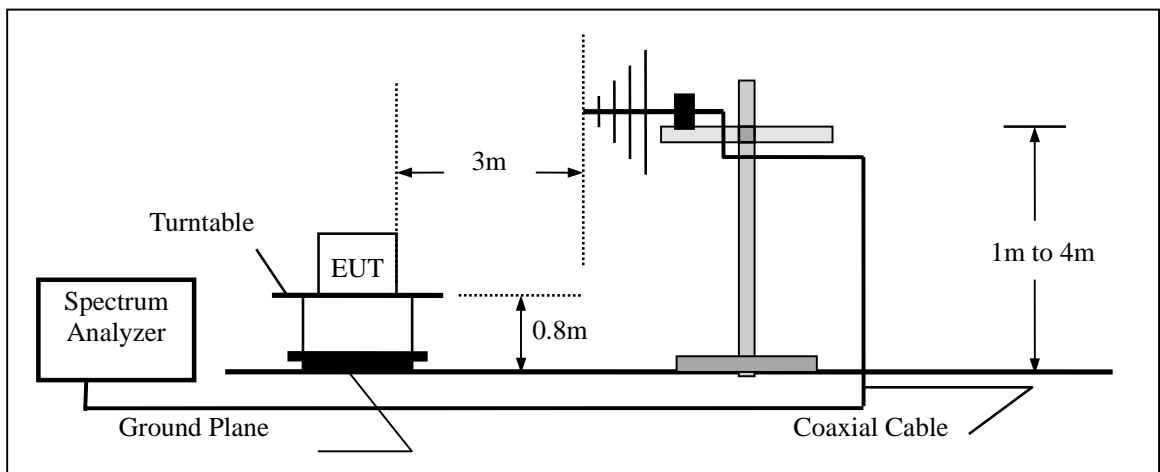

(C) Radiated Emission Test Set-Up, Frequency above 1000MHz

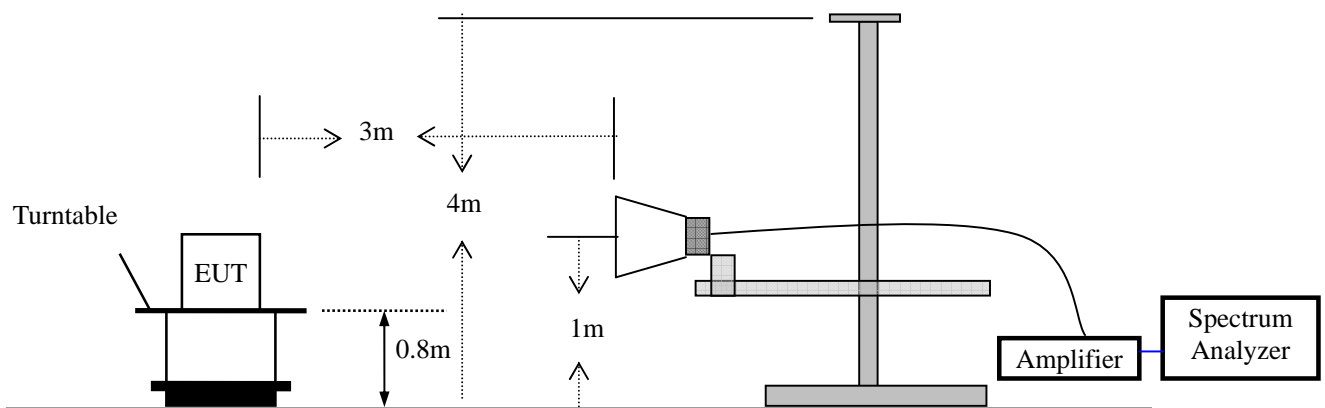

5.3 Measurement Equipment Used:

EQUIPMENT TYPE	MFR	MODEL NUMBER	SERIAL NUMBER	LAST CAL.	CAL DUE.
Spectrum Analyzer	Rohde & Schwarz	FSP7	839511/010	05/29/2012	05/29/2013
Spectrum Analyzer	HP	E4407B	839840481	05/29/2012	05/29/2013
EMI Test Receiver	Rohde & Schwarz	ESU	1302.6005.26	05/29/2012	05/29/2013
Pre-Amplifier	HP	8447D	2944A07999	05/29/2012	05/29/2013
Bilog Antenna	Schwarzbeck	VULB9163	142	05/29/2012	05/29/2013
Loop Antenna	ARA	PLA-1030/B	1029	05/29/2012	05/29/2013
Horn Antenna	Electro-Metrics	EM-6961	103314	05/29/2012	05/29/2013
Horn Antenna	Schwarzbeck	BBHA 9120	D143	05/29/2012	05/29/2013

5.4 Measurement Result

Operation Mode: RX Mode (CH40: 2441MHz) Test Date : July 02, 2012
 Frequency Range: 30~1000MHz Temperature : 25 °C
 Test Result: PASS Humidity : 50 %
 Measured Distance: 3m Test By: Andy

Freq. (MHz)	Ant. Pol. H/V	Emission Level (dBuV/m)	Limit 3m (dBuV/m)	Margin (dB)	Note
54.390	V	27.44	40.00	-12.56	PK
133.015	V	18.79	43.50	-24.71	PK
146.130	V	23.83	43.50	-19.67	PK
181.080	V	24.29	43.50	-19.21	PK
188.080	V	25.31	43.50	-18.19	PK
480.090	V	28.79	46.00	-17.21	PK
54.910	H	27.89	40.00	-12.11	PK
130.180	H	24.55	43.50	-18.95	PK
143.670	H	26.47	43.50	-17.03	PK
180.030	H	25.59	43.50	-17.91	PK
207.330	H	24.12	43.50	-19.38	PK
312.250	H	25.44	46.00	-20.56	PK

- Note:**
- (1) All Readings are Peak Value and AV;
 - (2) Emission Level= Reading Level+ Probe Factor +Cable Loss;
 - (3) The average measurement was not performed when the peak measured data under the limit of average detection;
 - (4) The results of low and high channel are as same as middle channel.
 - (5) The results of different data rate(1Mbps, 2Mbps, 3Mbps) are the same.

Operation Mode: RX Mode (CH40: 2441MHz) Test Date : July 02, 2012
Frequency Range: 1-25GHz Temperature : 25 °C
Test Result: PASS Humidity : 50 %
Measured Distance: 3m Test By: Andy

Freq. (MHz)	Ant. Pol. H/V	Emission Level(dBuV/m)		Limit 3m(dBuV/m)		Margin(dB)	
		PK	AV	PK	AV	PK	AV
4882	V	59.21	43.11	74.00	54.00	-14.79	-10.89
7323	V	58.18	44.55	74.00	54.00	-15.82	-9.45
9764	V	57.36	42.14	74.00	54.00	-16.64	-11.86
12205	V	59.20	39.79	74.00	54.00	-14.80	-14.21
4882	H	59.25	42.03	74.00	54.00	-14.75	-11.97
7323	H	57.54	41.05	74.00	54.00	-16.46	-12.95
9764	H	56.25	41.83	74.00	54.00	-17.75	-12.17
12205	H	58.78	38.99	74.00	54.00	-15.22	-15.01

Other harmonics emissions are lower than 20dB below the allowable limit.

- Note:**
- (1) All Readings are Peak Value and AV.
 - (2) Emission Level= Reading Level+ Probe Factor +Cable Loss.
 - (3) The average measurement was not performed when the peak measured data under the limit of average detection;
 - (4) The results of low and high channel are as same as middle channel.
 - (5) The results of different data rate(1Mbps, 2Mbps, 3Mbps) are the same.

Operation Mode: TX Mode (CH1: 2402MHz) Test Date : July 02, 2012
Frequency Range: 30~1000MHz Temperature : 25 °C
Test Result: PASS Humidity : 50 %
Measured Distance: 3m Test By: Andy

Freq. (MHz)	Ant. Pol. H/V	Emission Level (dBUV/m)	Limit 3m (dBUV/m)	Margin (dB)	Note
110.510	V	36.26	43.50	-7.24	PK
134.760	V	33.98	43.50	-9.52	PK
159.010	V	35.59	43.50	-7.91	PK
269.590	V	37.76	46.00	-8.24	PK
675.050	V	40.85	46.00	-5.15	PK
945.680	V	37.29	46.00	-8.71	PK
85.290	H	31.83	40.00	-8.17	PK
110.510	H	34.60	43.50	-8.90	PK
159.010	H	36.11	43.50	-7.39	PK
216.240	H	33.57	46.00	-12.43	PK
269.590	H	36.53	46.00	-9.47	PK
323.910	H	35.47	46.00	-10.53	PK

- Note:**
- (1) All Readings are Peak Value.
 - (2) Emission Level= Reading Level+ Probe Factor +Cable Loss
 - (3) The average measurement was not performed when the peak measured data under the limit of average detection.
 - (4) The results of different data rate(1Mbps, 2Mbps, 3Mbps) are the same.

Operation Mode: TX Mode (CH40: 2441MHz) Test Date : July 02, 2012
Frequency Range: 30~1000MHz Temperature : 25 °C
Test Result: PASS Humidity : 50 %
Measured Distance: 3m Test By: Andy

Freq. (MHz)	Ant. Pol. H/V	Emission Level (dBUV/m)	Limit 3m (dBUV/m)	Margin (dB)	Note
110.370	V	36.12	43.50	-7.38	PK
134.550	V	33.91	43.50	-9.59	PK
160.010	V	35.55	43.50	-7.95	PK
269.210	V	37.76	46.00	-8.24	PK
673.010	V	40.85	46.00	-5.15	PK
945.680	V	37.29	46.00	-8.71	PK
85.220	H	31.83	40.00	-8.17	PK
110.510	H	34.60	43.50	-8.90	PK
159.390	H	36.05	43.50	-7.45	PK
216.240	H	33.57	46.00	-12.43	PK
269.580	H	36.77	46.00	-9.23	PK
323.940	H	35.02	46.00	-10.98	PK

- Note:**
- (1) All Readings are Peak Value.
 - (2) Emission Level= Reading Level+ Probe Factor +Cable Loss.
 - (3) The average measurement was not performed when the peak measured data under the limit of average detection.
 - (4) The results of different data rate(1Mbps, 2Mbps, 3Mbps) are the same.

Operation Mode: TX Mode (CH79: 2480MHz) Test Date : July 02, 2012
Frequency Range: 30~1000MHz Temperature : 25 °C
Test Result: PASS Humidity : 50 %
Measured Distance: 3m Test By: Andy

Freq. (MHz)	Ant. Pol. H/V	Emission Level (dBuV/m)	Limit 3m (dBuV/m)	Margin (dB)	Note
110.120	V	36.06	43.50	-7.44	PK
124.270	V	33.22	43.50	-10.28	PK
160.010	V	35.55	43.50	-7.95	PK
269.210	V	37.76	46.00	-8.24	PK
673.550	V	40.83	46.00	-5.17	PK
945.680	V	37.29	46.00	-8.71	PK
85.220	H	31.83	40.00	-8.17	PK
110.510	H	34.94	43.50	-8.56	PK
159.320	H	36.05	43.50	-7.45	PK
216.240	H	33.15	46.00	-12.85	PK
269.510	H	36.70	46.00	-9.30	PK
323.440	H	35.32	46.00	-10.68	PK

- Note:**
- (1) All Readings are Peak Value.
 - (2) Emission Level= Reading Level+ Probe Factor +Cable Loss.
 - (3) The average measurement was not performed when the peak measured data under the limit of average detection.
 - (4) The results of different data rate(1Mbps, 2Mbps, 3Mbps) are the same.

Operation Mode: TX Mode (CH1: 2402MHz) Test Date : July 02, 2012
 Frequency Range: 1-25GHz Temperature : 25 °C
 Test Result: PASS Humidity : 50 %
 Measured Distance: 3m Test By: Andy

Freq. (MHz)	Ant. Pol. H/V	Emission Level(dBuV/m)		Limit 3m(dBuV/m)		Margin(dB)	
		PK	AV	PK	AV	PK	AV
2402	V	58.21	46.23	74.00	54.00	-15.79	-7.77
4804	V	61.43	45.83	74.00	54.00	-12.57	-8.17
7206	V	58.30	42.77	74.00	54.00	-15.7	-11.23
9608	V	54.49	43.02	74.00	54.00	-19.51	-10.98
12010	V	58.41	44.81	74.00	54.00	-15.59	-9.19
2402	H	59.25	46.39	74.00	54.00	-14.75	-7.61
4804	H	57.69	42.55	74.00	54.00	-16.31	-11.45
7206	H	60.07	45.71	74.00	54.00	-13.93	-8.29
9608	H	59.92	44.21	74.00	54.00	-14.08	-9.79
12010	H	57.12	47.39	74.00	54.00	-16.88	-6.61

Other harmonics emissions are lower than 20dB below the allowable limit.

- Note:**
- (1) All Readings are Peak Value and AV.
 - (2) Emission Level= Reading Level+ Probe Factor +Cable Loss.
 - (3) The average measurement was not performed when the peak measured data under the limit of average detection.
 - (4) The results of different data rate(1Mbps, 2Mbps, 3Mbps) are the same.

Operation Mode: TX Mode (CH40: 2441MHz) Test Date : July 02, 2012
Frequency Range: 1-25GHz Temperature : 25 °C
Test Result: PASS Humidity : 50 %
Measured Distance: 3m Test By: Andy

Freq. (MHz)	Ant. Pol. H/V	Emission Level(dBuV/m)		Limit 3m(dBuV/m)		Margin(dB)	
		PK	AV	PK	AV	PK	AV
4882	V	60.19	44.55	74.00	54.00	-13.81	-9.45
7323	V	57.25	45.89	74.00	54.00	-16.75	-8.11
9764	V	59.88	43.02	74.00	54.00	-14.12	-10.98
12205	V	57.33	42.02	74.00	54.00	-16.67	-11.98
4882	H	61.25	43.94	74.00	54.00	-12.75	-10.06
7323	H	58.03	43.91	74.00	54.00	-15.97	-10.09
9764	H	56.18	42.71	74.00	54.00	-17.82	-11.29
12205	H	57.83	43.34	74.00	54.00	-16.17	-10.66

Other harmonics emissions are lower than 20dB below the allowable limit.

- Note:**
- (1) All Readings are Peak Value and AV.
 - (2) Emission Level= Reading Level+ Probe Factor +Cable Loss.
 - (3) The average measurement was not performed when the peak measured data under the limit of average detection.
 - (4) The results of different data rate(1Mbps, 2Mbps, 3Mbps) are the same.

Operation Mode: TX Mode (CH79: 2480MHz) Test Date : July 02, 2012
 Frequency Range: 1-25GHz Temperature : 25 °C
 Test Result: PASS Humidity : 50 %
 Measured Distance: 3m Test By: Andy

Freq. (MHz)	Ant. Pol. H/V	Emission Level(dBuV/m)		Limit 3m(dBuV/m)		Margin(dB)	
		PK	AV	PK	AV	PK	AV
2480	V	63.25	46.79	74.00	54.00	-10.75	-7.21
4960	V	61.39	45.03	74.00	54.00	-12.61	-8.97
7440	V	58.82	42.09	74.00	54.00	-15.18	-11.91
9920	V	57.04	43.82	74.00	54.00	-16.96	-10.18
12400	V	57.29	43.46	74.00	54.00	-16.71	-10.54
2480	H	61.41	45.32	74.00	54.00	-12.59	-8.68
4960	H	55.92	42.17	74.00	54.00	-18.08	-11.83
7440	H	57.07	44.83	74.00	54.00	-16.93	-9.17
9920	H	54.54	43.56	74.00	54.00	-19.46	-10.44
12400	H	52.22	41.87	74.00	54.00	-21.78	-12.13

Other harmonics emissions are lower than 20dB below the allowable limit.

- Note:**
- (1) All Readings are Peak Value and AV.
 - (2) Emission Level= Reading Level+ Probe Factor +Cable Loss.
 - (3) The average measurement was not performed when the peak measured data under the limit of average detection.
 - (4) The results of different data rate(1Mbps, 2Mbps, 3Mbps) are the same.

5.5 Radiated Measurement Photos:

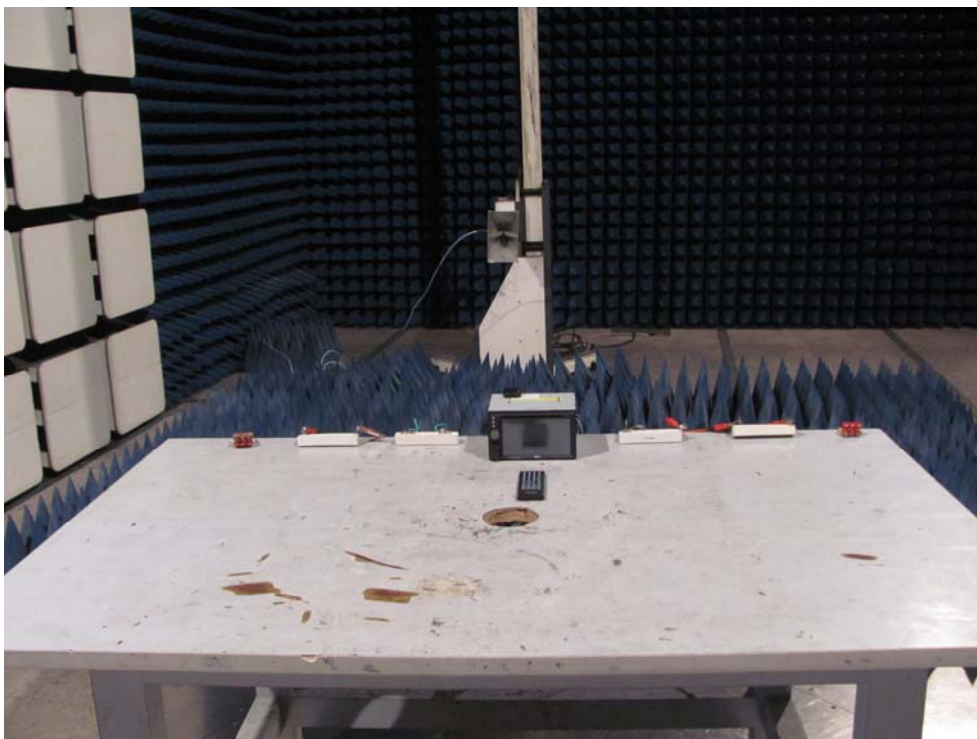
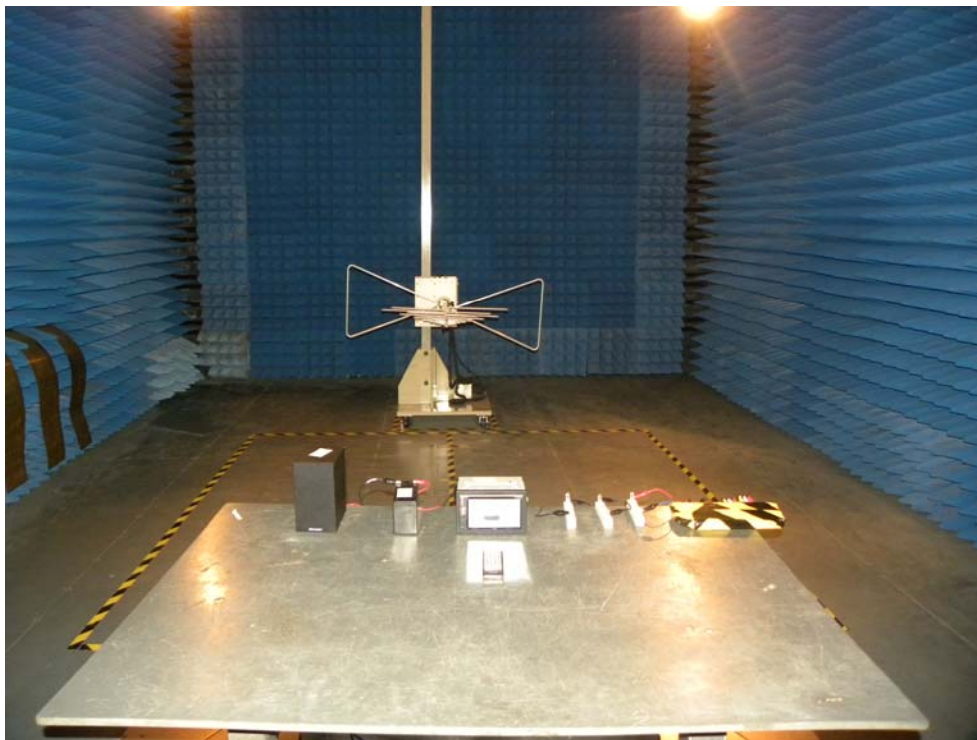

6. Channel Separation test

6.1 Measurement Procedure

The EUT was operating in hopping mode or could be controlled its channel. Printed out the test result from the spectrum by hard copy function.

6.2 Test SET-UP (Block Diagram of Configuration)

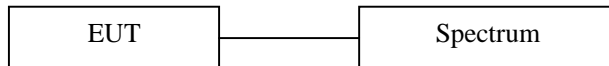

6.3 Measurement Equipment Used:

Same as 5.3 Radiated Emission Measurement.

6.4 Measurement Results:

Refer to attached data chart.

Spectrum Detector:	PK	Test Date :	July 14, 2012
Test By:	Andy	Temperature :	25 °C
Test Result:	PASS	Humidity :	50 %

Operating Mode	Hopping Channel Frequency Range	Separation Read Value (KHz)	Separation Limit (KHz)
op-mode 4	2402-2480	1000	>641.6

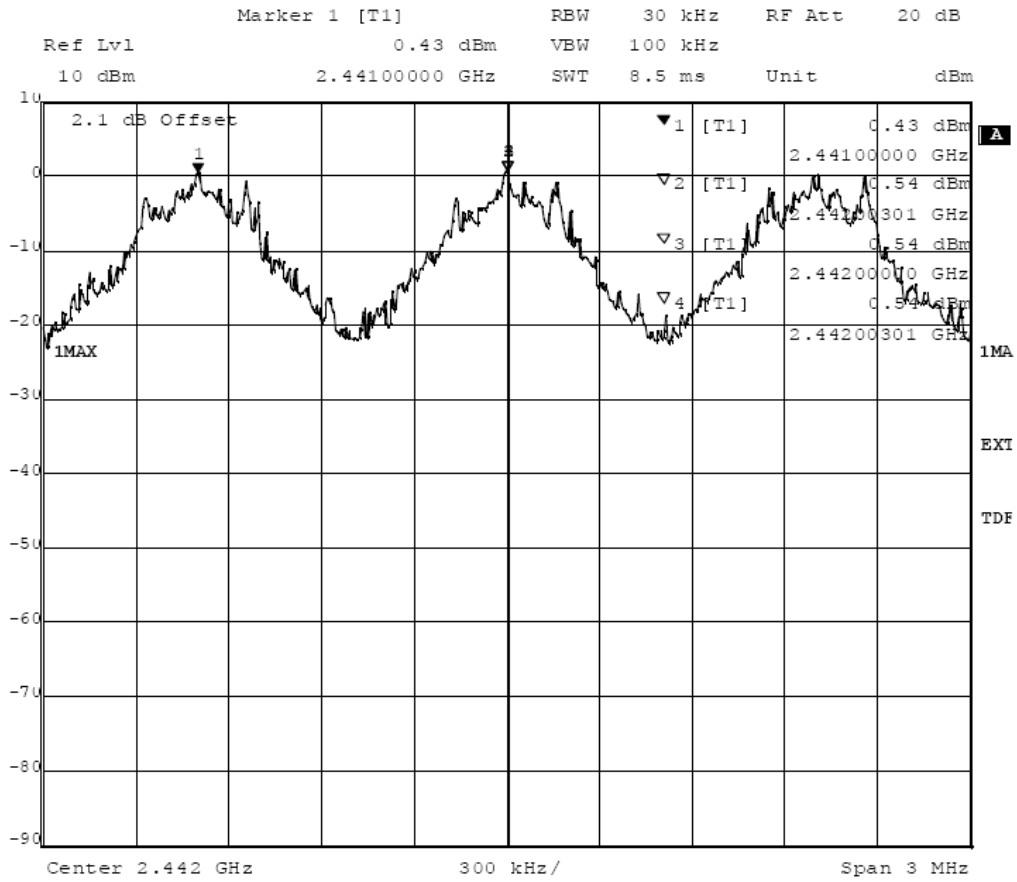

Title: Number of hopping frequencies
 Comment A: CH H: Hopping

7. 20dB Bandwidth test

7.1 Measurement Procedure

The EUT was operating in hopping mode or could be controlled its channel. Printed out the test result from the spectrum by hard copy function.

7.2 Test SET-UP (Block Diagram of Configuration)

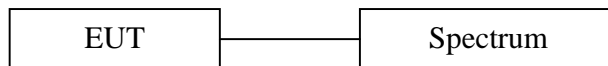

7.3 Measurement Equipment Used:

Same as 5.3 Radiated Emission Measurement.

7.4 Measurement Results:

Refer to attached data chart.

Spectrum Detector:	PK	Test Date :	July 14, 2012
Test By:	Andy	Temperature :	25 °C
Test Result:	PASS	Humidity :	50 %

Operating Mode	Channel frequency (MHz)	20dB Down BW(kHz)
op-mode 1	2402	956.4
op-mode 2	2441	962.4
op-mode 3	2480	968.4
op-mode 6	2402	1311.6
op-mode 7	2441	1311.6
op-mode 8	2480	1251.6
op-mode 10	2402	1311.6
op-mode 11	2441	1257.6
op-mode 12	2480	1287.6

Op-mode 1:

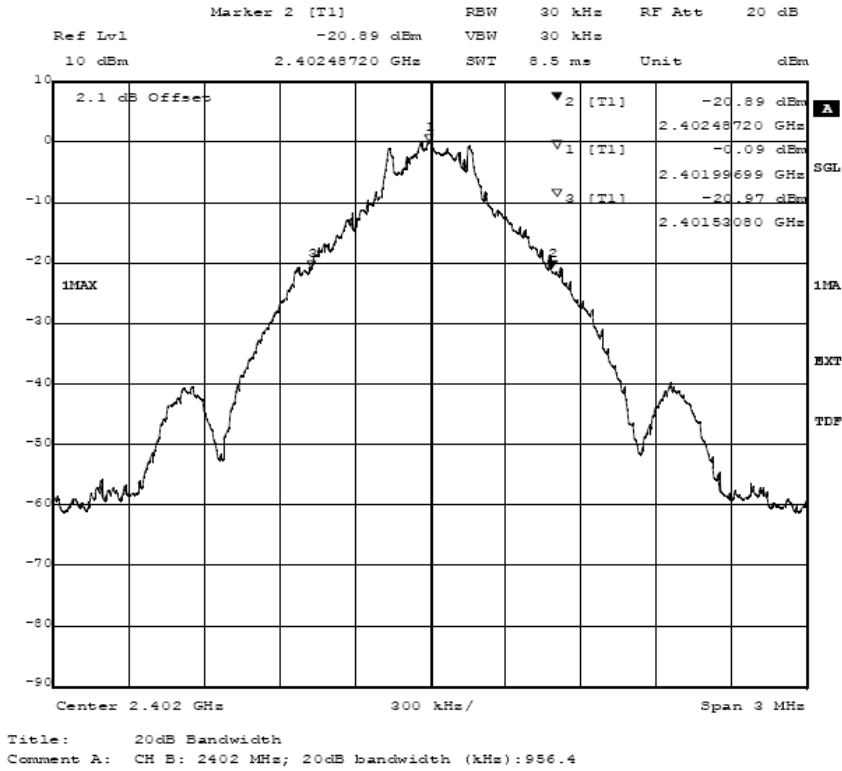

Op-mode 2:

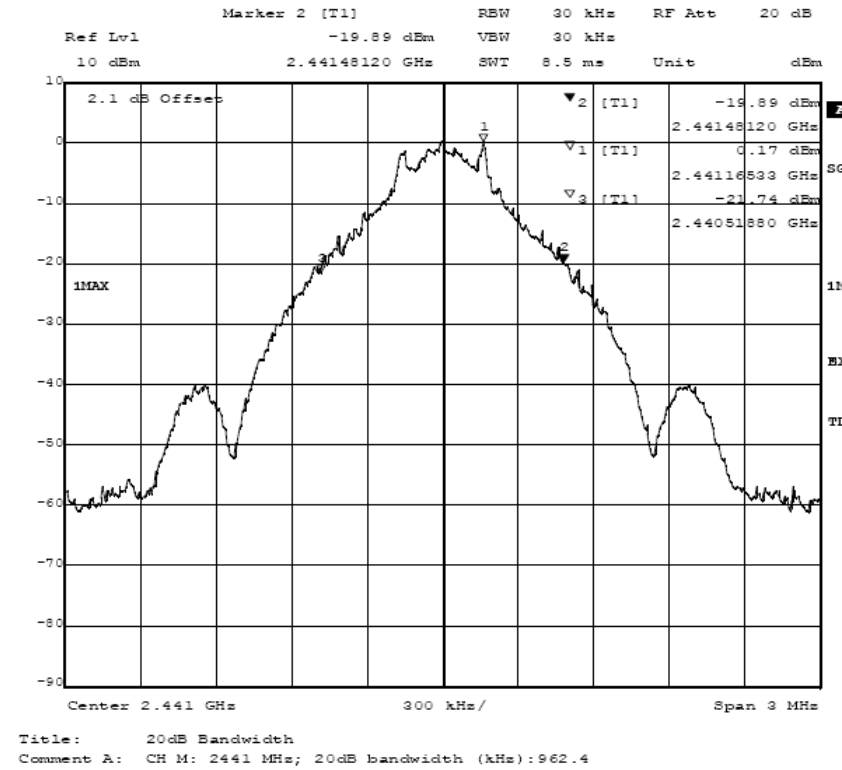

Op-mode 3:

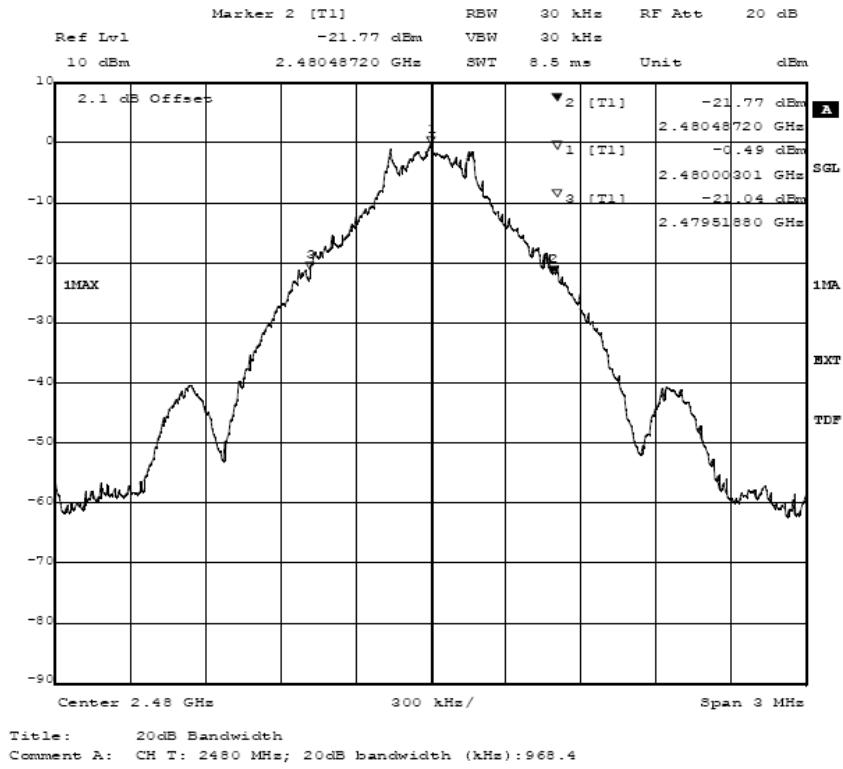

Op-mode 6:

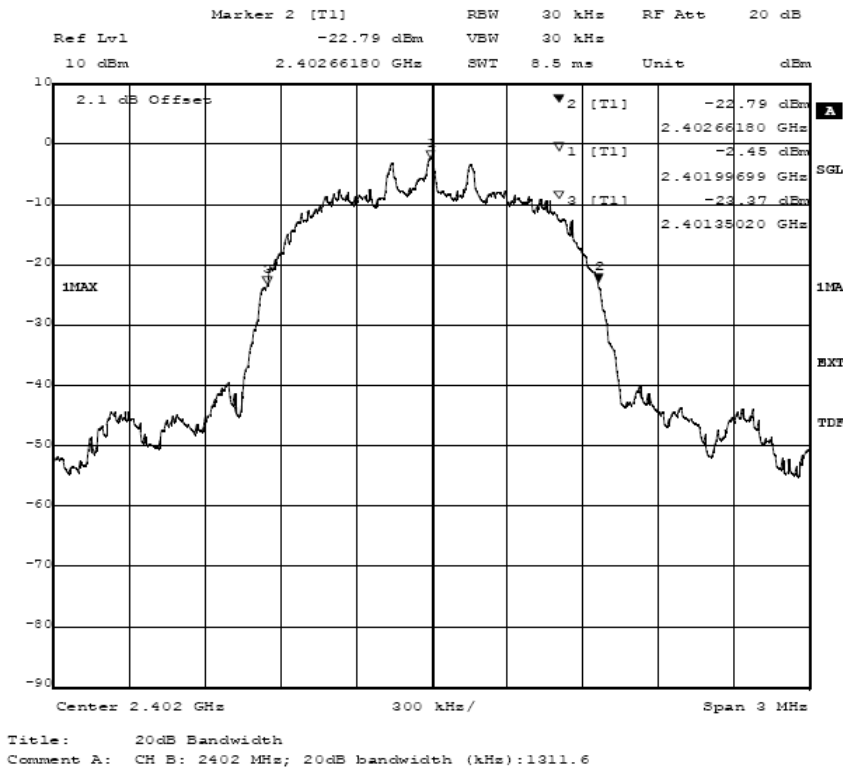

Op-mode 7:

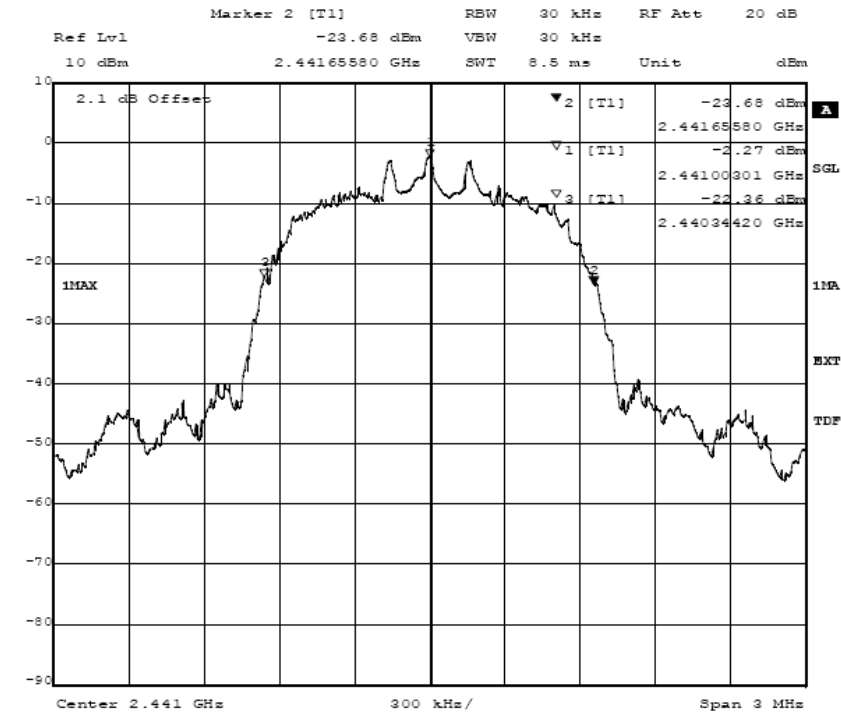

Title: 20dB Bandwidth
 Comment A: CH M: 2441 MHz; 20dB bandwidth (kHz):1311.6

Op-mode 8:

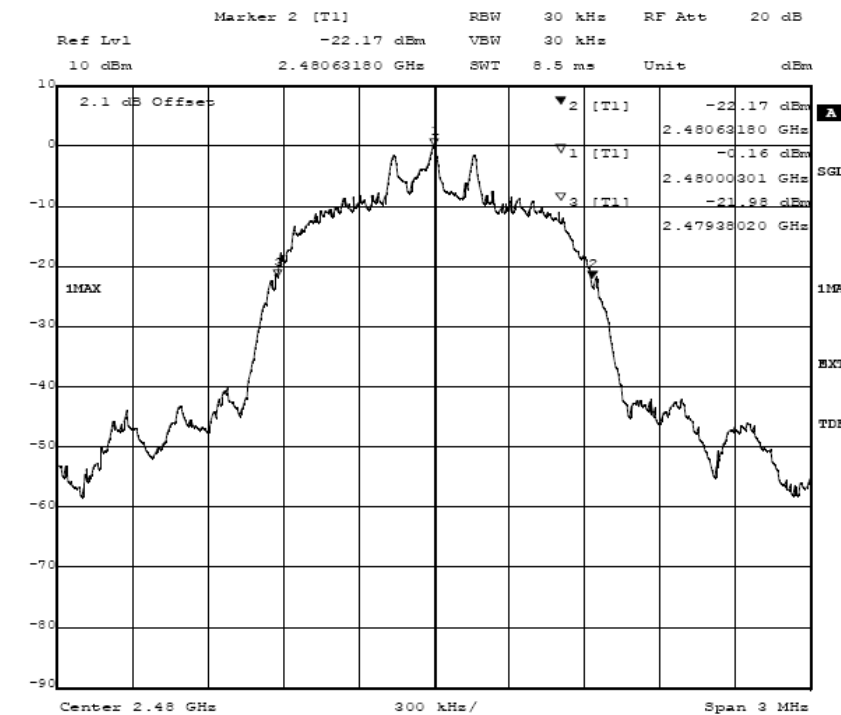

Title: 20dB Bandwidth
 Comment A: CH T: 2480 MHz; 20dB bandwidth (kHz):1251.6

Op-mode 10:

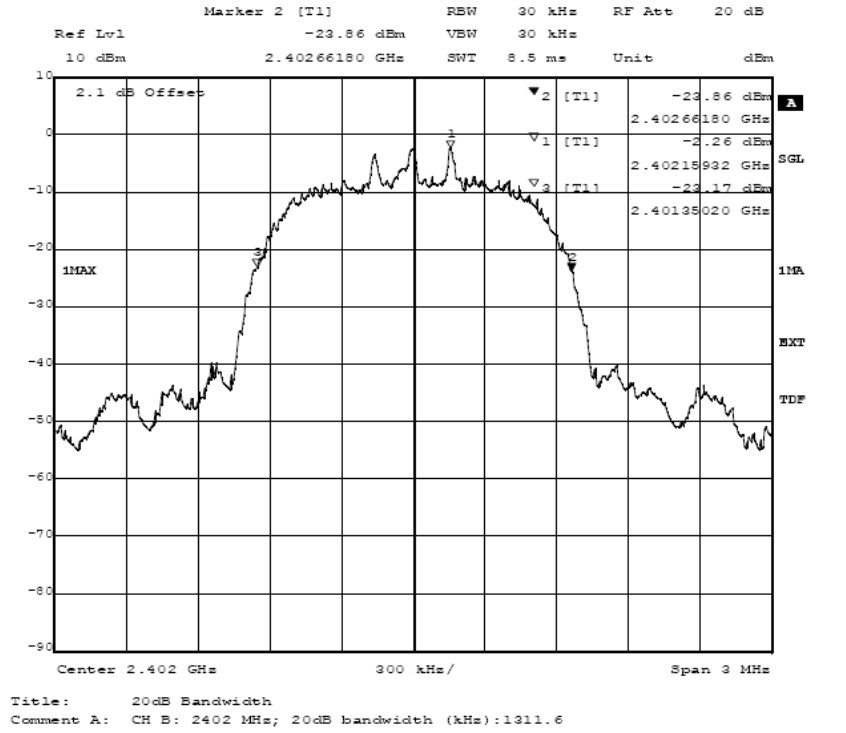

Op-mode 11:

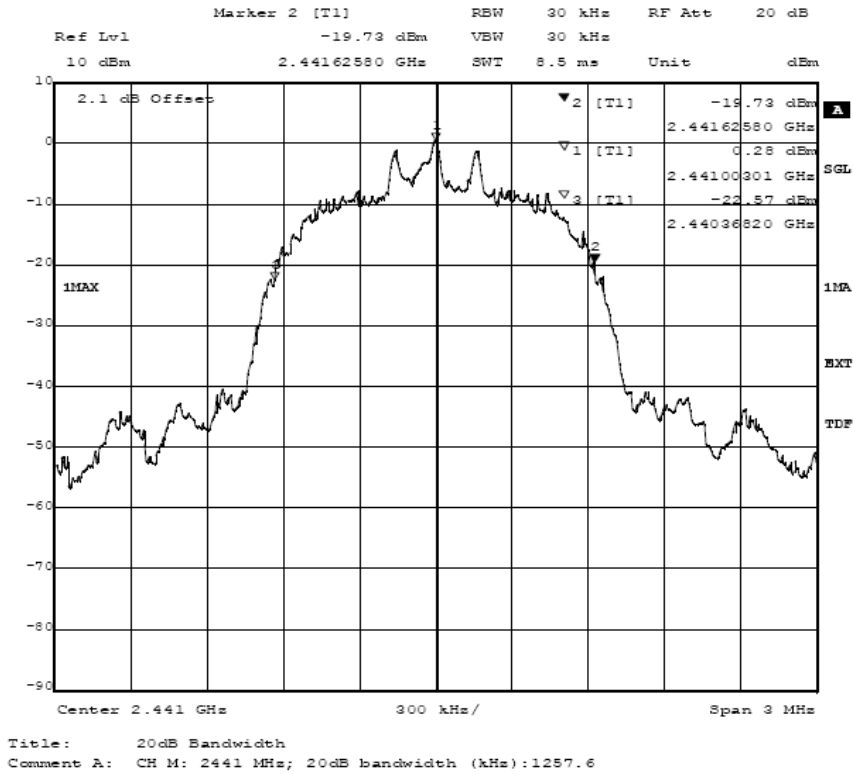

Op-mode 12:

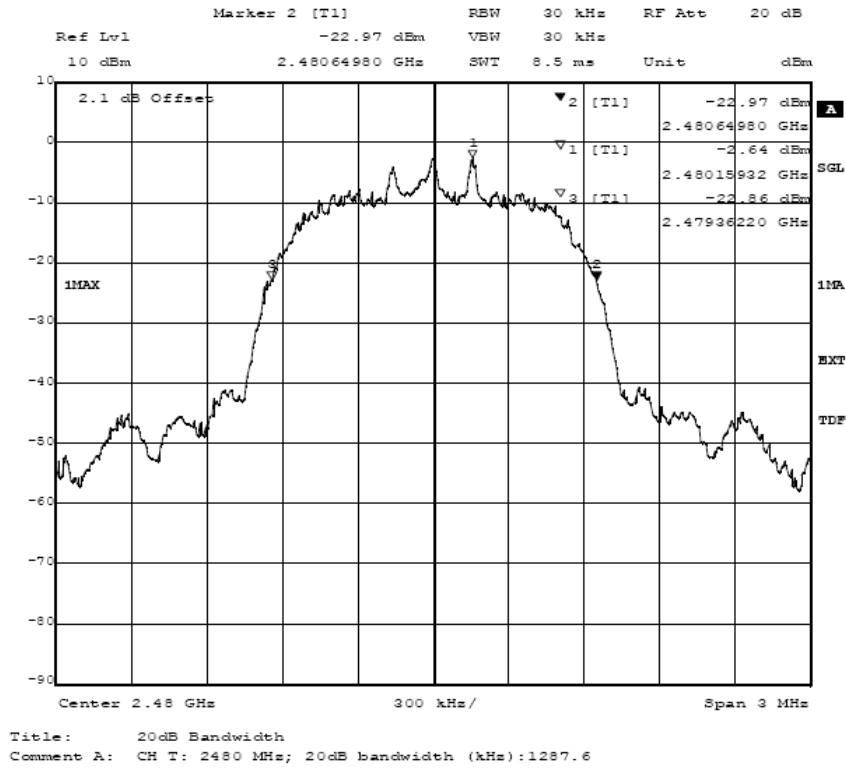

8. Quantity of Hopping Channel Test

8.1 Measurement Procedure

The EUT was operating in hopping mode or could be controlled its channel. Printed out the test result from the spectrum by hard copy function.

8.2 Test SET-UP (Block Diagram of Configuration)

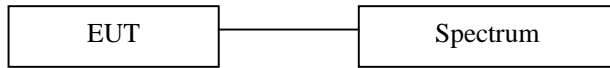

8.3 Measurement Equipment Used:

Same as 5.3 Radiated Emission Measurement.

8.4 Measurement Results:

Refer to attached data chart.

Spectrum Detector:	PK	Test Date :	July 14, 2012
Test By:	Andy	Temperature :	25 °C
Test Result:	PASS	Humidity :	50 %

Operating Mode	Hopping Channel Frequency Range	Quantity of Hopping Channel	Quantity of Hopping Channel
op-mode 4	2402-2480	79	>15

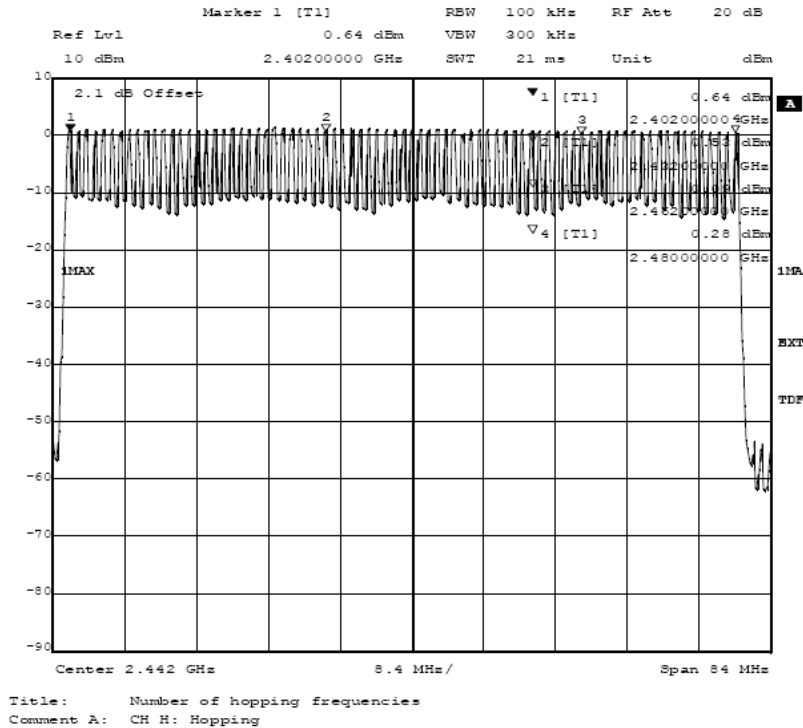

9. Time of Occupancy (Dwell Time) test

9.1 Test Description

The Equipment Under Test (EUT) was set up to perform the dwell time measurements. The EUT was connected to the spectrum analyzer via a short coax cable. The dwell time is calculated by:

$$\text{Dwell time} = \text{time slot length} * \text{hop rate} / \text{number of hopping channels} * 31.6\text{s}$$

with:

- hop rate = $1600 * 1/\text{s}$ for DH1 packets = 1600 s^{-1}
- hop rate = $1600/3 * 1/\text{s}$ for DH3 packets = 533.33 s^{-1}
- hop rate = $1600/5 * 1/\text{s}$ for DH5 packets = 320 s^{-1}
- number of hopping channels = 79
- $31.6 \text{ s} = 0.4 \text{ seconds multiplied by the number of hopping channels} = 0.4 \text{ s} * 79$

The highest value of the dwell time is reported.

9.2 Test Requirements / Limits

FCC Part 15, Subpart C, §15.247 (a) (1) (iii)

Frequency hopping systems in the 2400-2483.5 MHz band shall use at least 15 channels. The average time of occupancy on any channel shall not be greater than 0.4 seconds within a period of 0.4 seconds multiplied by the number of hopping channels employed. Since the Bluetooth technology uses 79 channels this period is calculated to be 31.6seconds.Refer to attached data chart.

9.3 Test Protocol

Packet type	Time slot length(ms)	Dwell time	Dwell time(ms)
DH5	2.887	time slot length *1600/5 /79 * 31.6	369.54

Remark:

1. The results of low and high channel are as same as middle channel.
2. The results of different data rate(1Mbps, 2Mbps, 3Mbps) are the same.

9.4 Test result: Dwell time

PASS.

DH5:

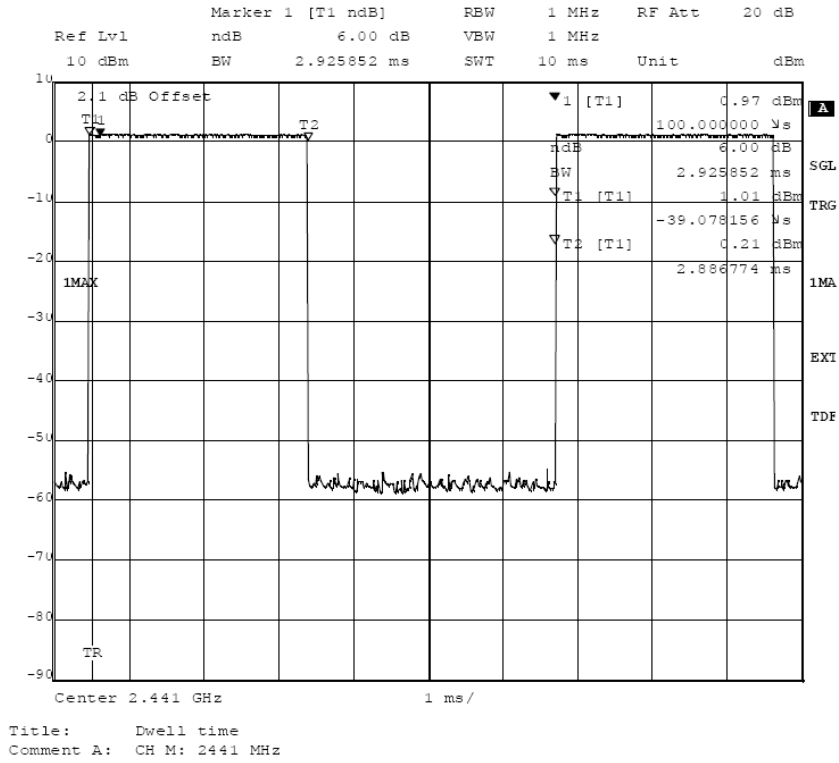

10. MAXIMUM PEAK OUTPUT POWER TEST

10.1 Measurement Procedure

- a. Check the calibration of the measuring instrument(SA) using either an internal calibrator or a known signal from an external generator.
- b. Turn on the EUT and connect it to measurement instrument. Then set it to any one convenient frequency within its operating range. Set a reference level on the measuring instrument equal to the highest peak value.
- c. The center frequency of the spectrum analyzer is set to the fundamental frequency and using proper RBW and VBW setting.
- d. Measure the captured power within the band and recording the plot.
- e. Repeat above procedures until all frequencies required were complete.

10.2 Test SET-UP (Block Diagram of Configuration)

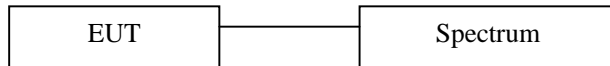

10.3 Measurement Equipment Used:

EQUIPMENT TYPE	MFR	MODEL NUMBER	SERIAL NUMBER	LAST CAL.	CAL DUE.
Spectrum Analyzer	Rohde & Schwarz	FSP7	839511/010	05/29/2012	05/29/2013

10.4 Measurement Results:

Refer to attached data chart.

Spectrum Detector: PK Test Date : July 14, 2012
 Test By: Andy Temperature : 25 °C
 Test Result: PASS Humidity : 50 %

Operating Mode	Channel Frequency (MHz)	Peak Power output(mW)	Peak Power output(dBm)	Peak Power Limit(mW)	Pass/Fail																							
op-mode 1	2402	1.250	0.97	125	PASS																							
op-mode 2	2441	1.297	1.13	125	PASS																							
op-mode 3	2480	1.164	0.66	125	PASS																							
op-mode 6	2402	1.291	1.11	125	PASS																							
op-mode 7	2441	1.387	1.42	125 </tr <tr> <td>op-mode 8</td> <td>2480</td> <td>1.202</td> <td>0.80</td> <td>125</td> <td>PASS</td> </tr> <tr> <td>op-mode 10</td> <td>2402</td> <td>1.143</td> <td>0.58</td> <td>125</td> <td>PASS</td> </tr> <tr> <td>op-mode 11</td> <td>2441</td> <td>1.365</td> <td>1.35</td> <td>125</td> <td>PASS</td> </tr> <tr> <td>op-mode 12</td> <td>2480</td> <td>1.047</td> <td>0.20</td> <td>125</td> <td>PASS</td> </tr>	op-mode 8	2480	1.202	0.80	125	PASS	op-mode 10	2402	1.143	0.58	125	PASS	op-mode 11	2441	1.365	1.35	125	PASS	op-mode 12	2480	1.047	0.20	125	PASS
op-mode 8	2480	1.202	0.80	125	PASS																							
op-mode 10	2402	1.143	0.58	125	PASS																							
op-mode 11	2441	1.365	1.35	125	PASS																							
op-mode 12	2480	1.047	0.20	125	PASS																							

op-mode 1:

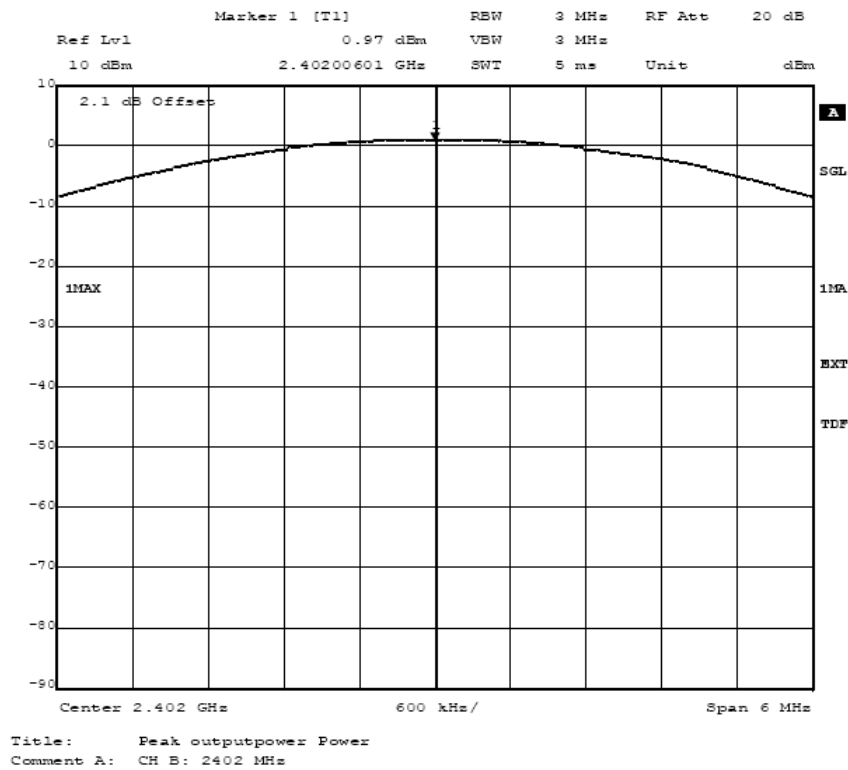

op-mode 2:

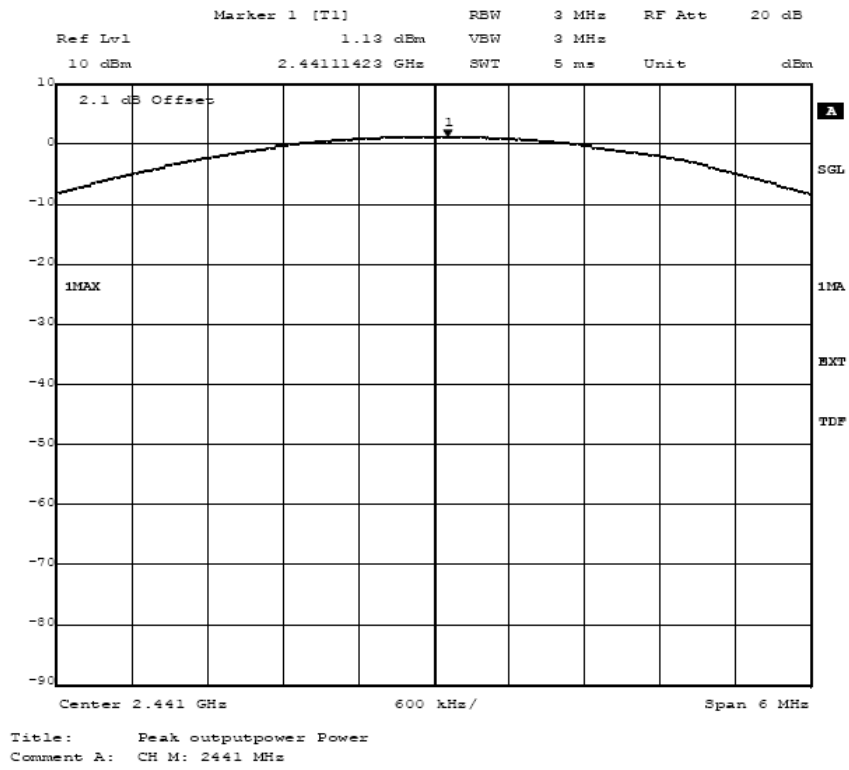

op-mode 3:

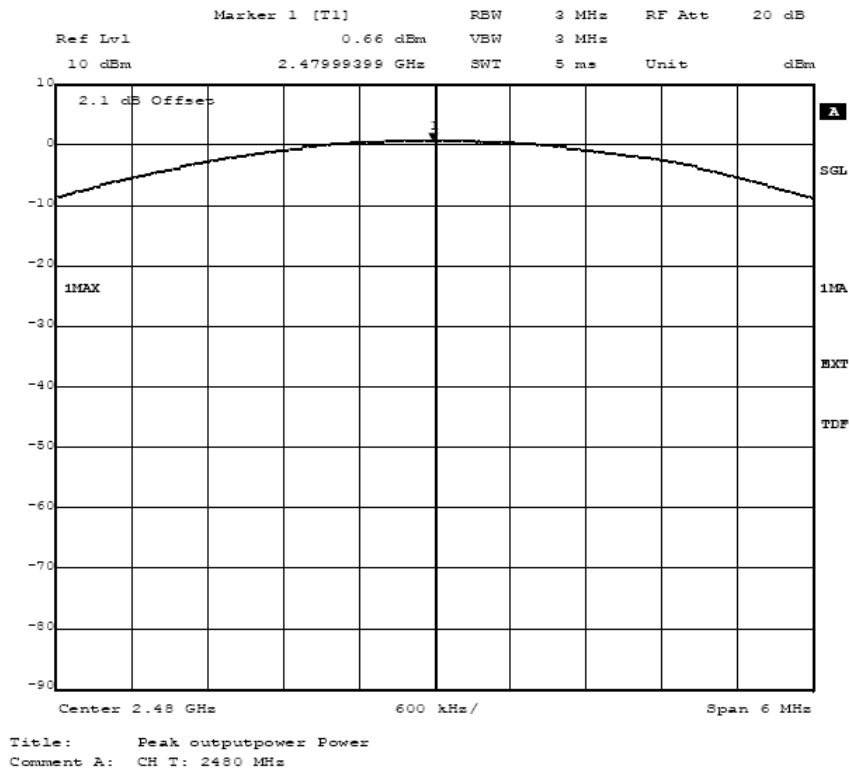

op-mode 6:

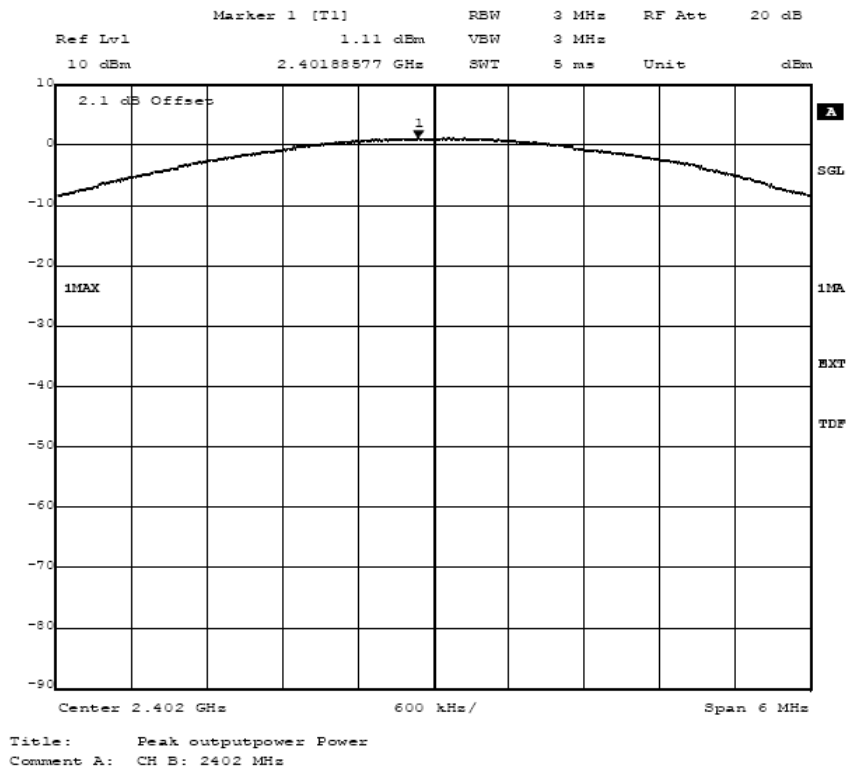

op-mode 7:

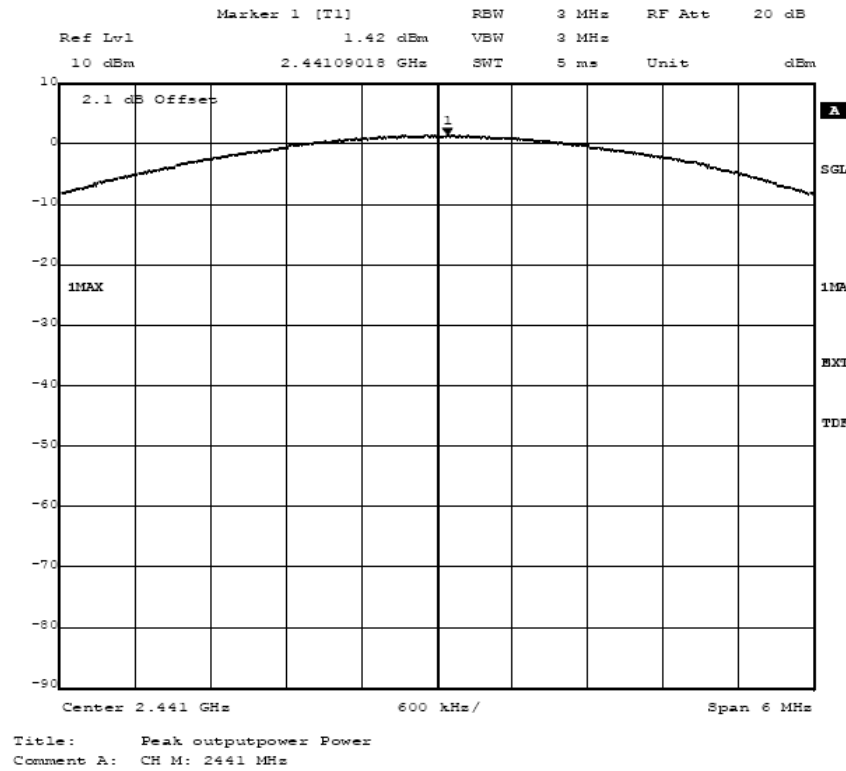

op-mode 8:

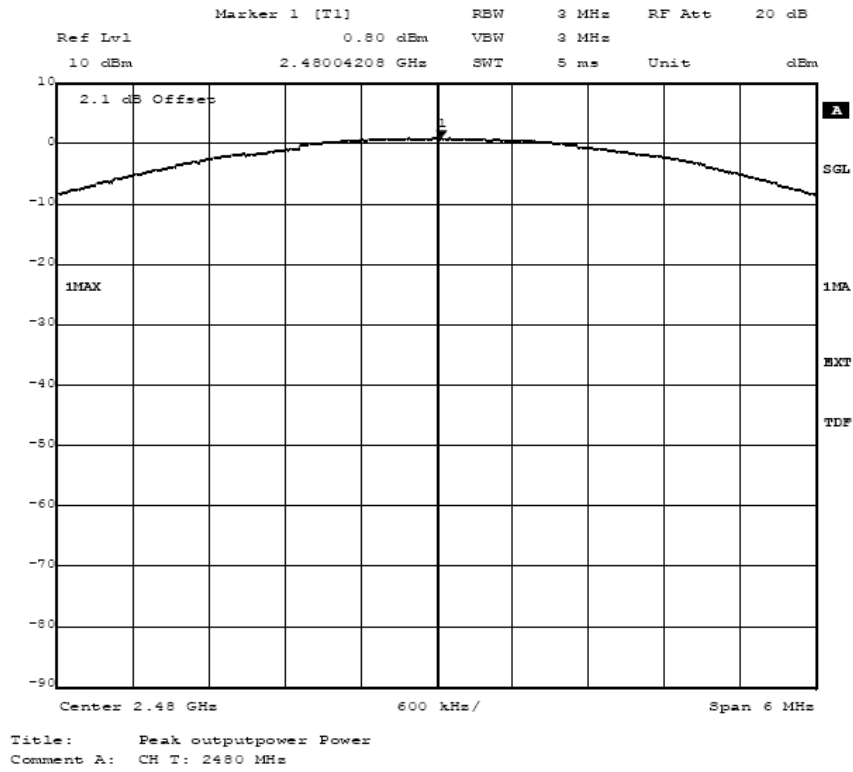

op-mode 10:

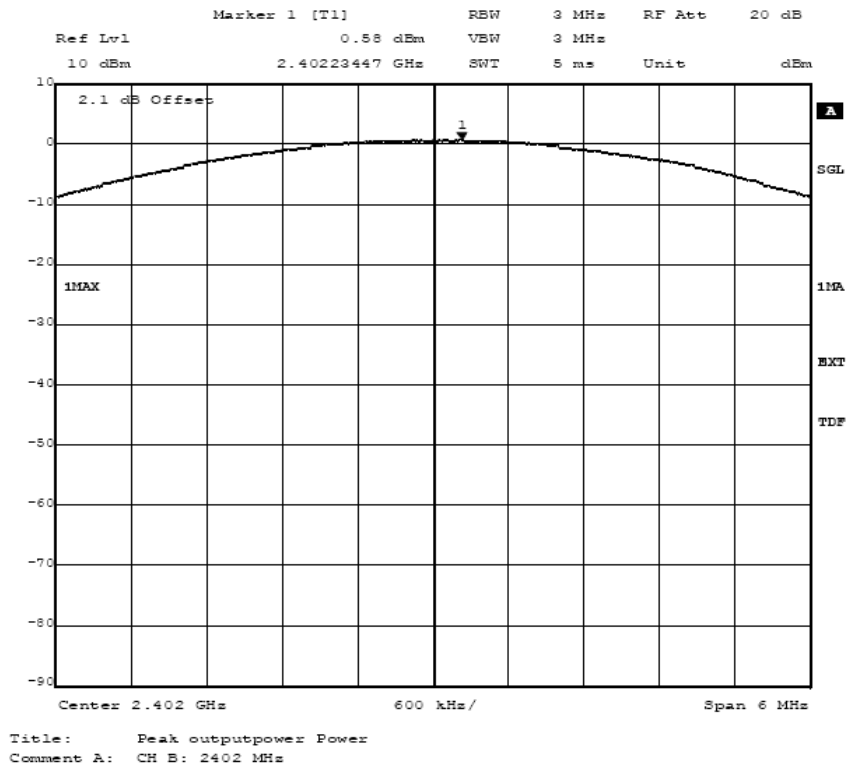

op-mode 11:

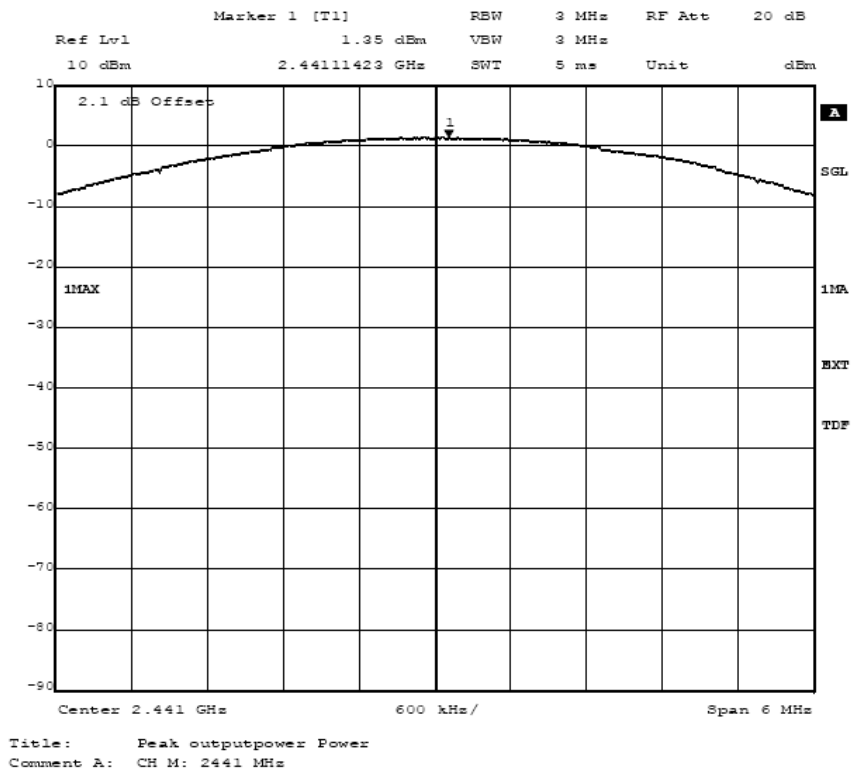

op-mode 12:

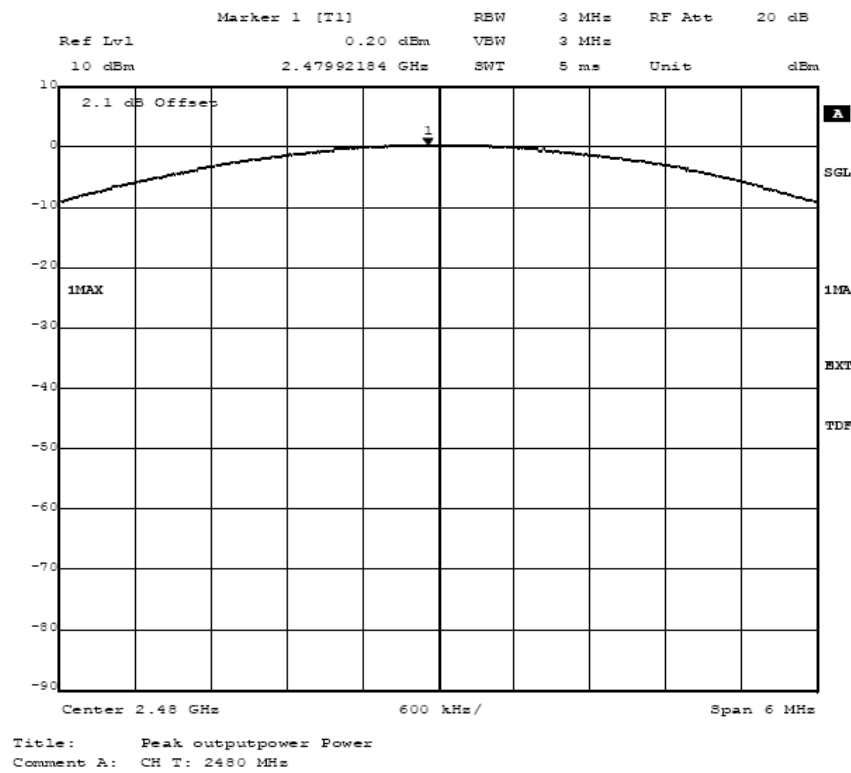

11. Band EDGE test

11.1 Measurement Procedure

1. The EUT was Operating in hopping mode or could be controlled its channel. Printed out test result from the spectrum by hard copy function.
2. The EUT was placed on a turn table which is 0.8m above ground plane.
3. Maximum procedure was performed on the six highest emissions to ensure EUT compliance.
4. And also, each emission was to be maximized by changing the polarization of receiving antenna both horizontal and vertical.
5. Repeat above procedures until all frequency measured were complete.

11.2 Test SET-UP (Block Diagram of Configuration)

Same as 5.2 Radiated Emission Set-up.

11.3 Measurement Equipment Used:

Same as 5.3 Radiated Emission Measurement.

11.4 Measurement Results:

Refer to attached data chart.

Spectrum Detector: PK Test Date : July 14, 2012
 Test By: Andy Temperature : 25 °C
 Test Result: PASS Humidity : 50 %

1. Conducted Test

Frequency (MHz)	Operating Mode	Peak Power Output(dBm)	Emission read Value(dBm)	Result of Band edge(dBc)	Band edge Limit(dBc)
<2400	op-mode 1	0.75	-58.93	59.68	>20dBc
	op-mode 6	-1.57	-51.75	50.18	>20dBc
	op-mode 10	-1.62	-55.69	54.07	>20dBc
>2483.5	op-mode 3	0.39	-63.67	64.06	>20dBc
	op-mode 8	-2.02	-63.79	61.77	>20dBc
	op-mode 12	-2.15	-63.41	61.26	>20dBc

2. Radiated emission Test

Frequency (MHz)	Operating Mode	Antenna polarization (H/V)	Emission (dBuV/m)		Band edge Limit (dBuV/m)	
			PK	AV	PK	AV
<2400	op-mode 1	V	51.09	38.22	74.00	54.00
	op-mode 6	V	52.54	39.59	74.00	54.00
	op-mode 10	V	48.78	37.55	74.00	54.00
>2483.5	op-mode 3	V	48.39	36.89	74.00	54.00
	op-mode 8	V	48.99	36.89	74.00	54.00
	op-mode 12	V	49.39	37.01	74.00	54.00

Remark: The results of Horizontal polarization and Vertical polarization are same.

op-mode 1:

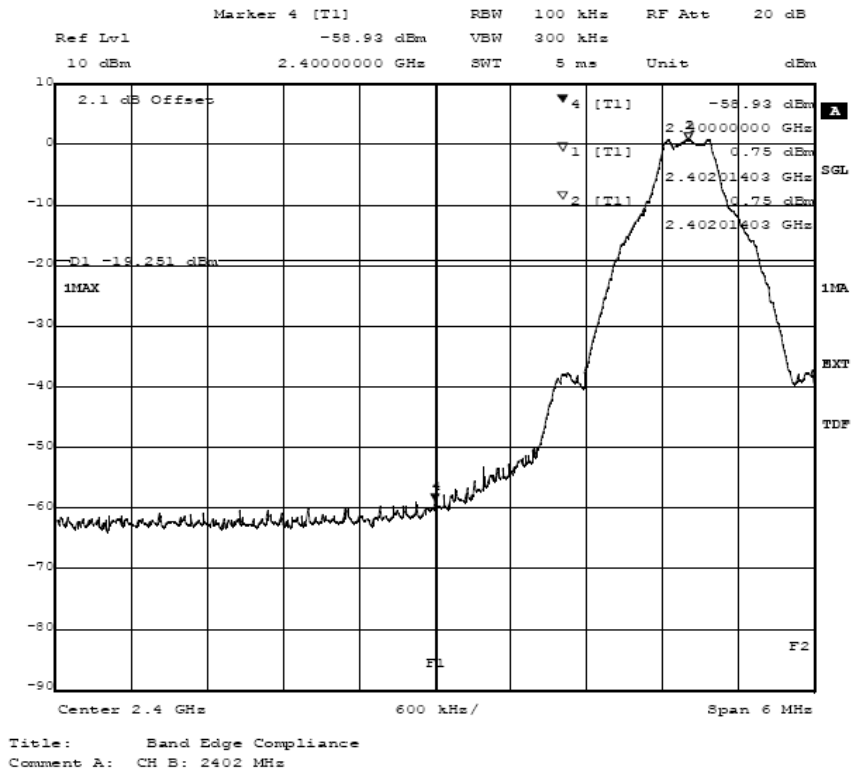

op-mode 3:

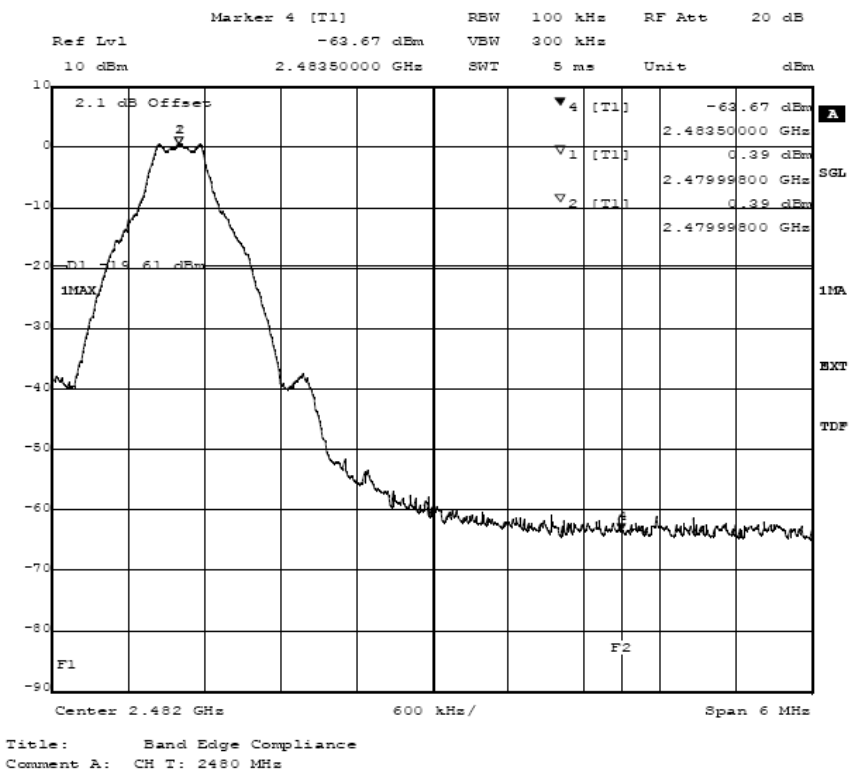

op-mode 6:

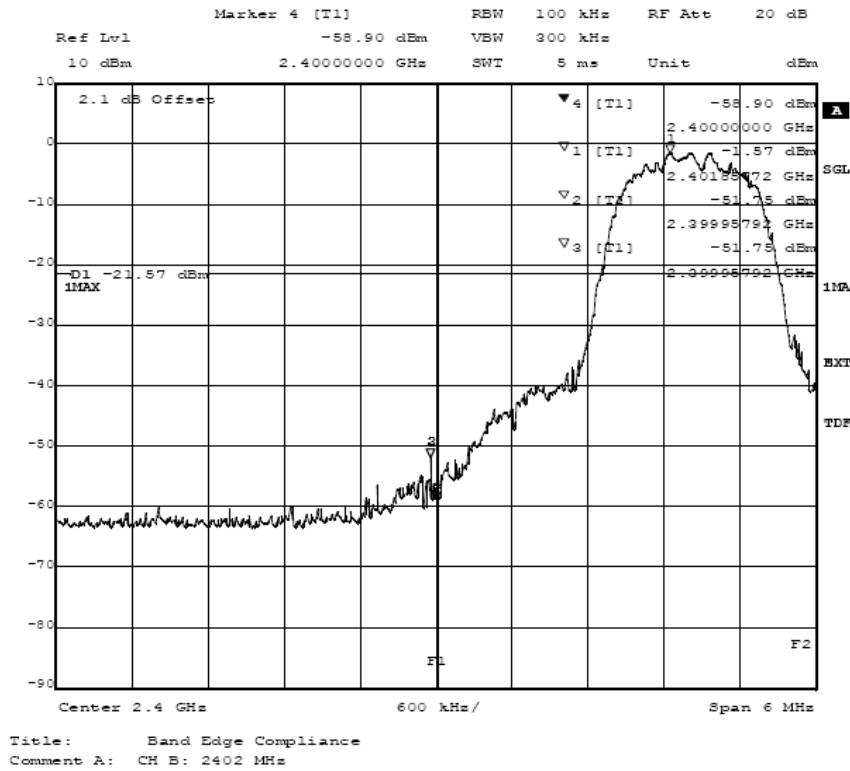

op-mode 8:

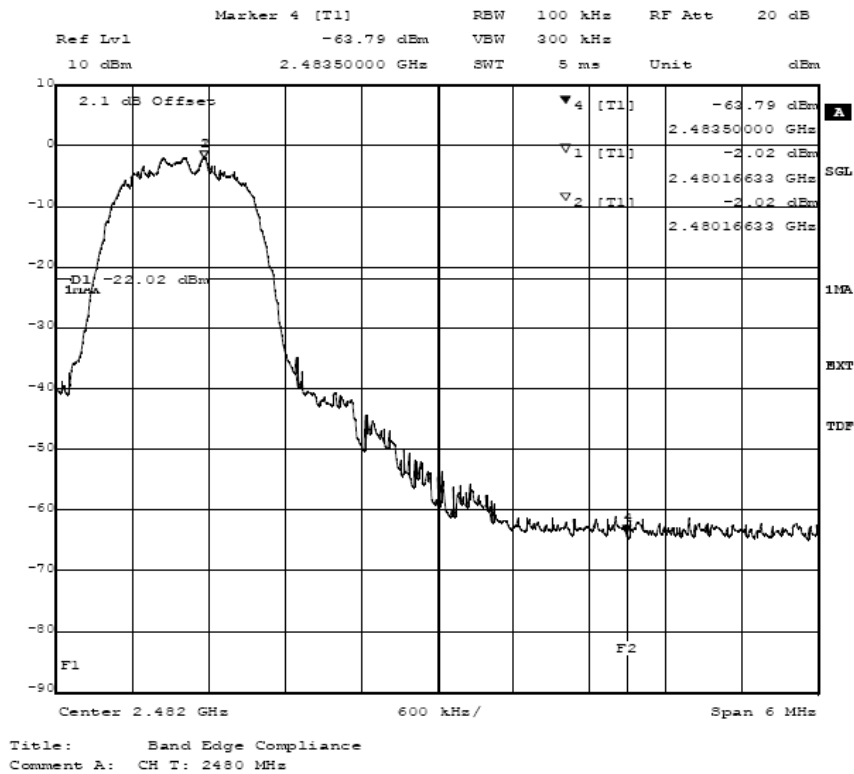

op-mode 10:

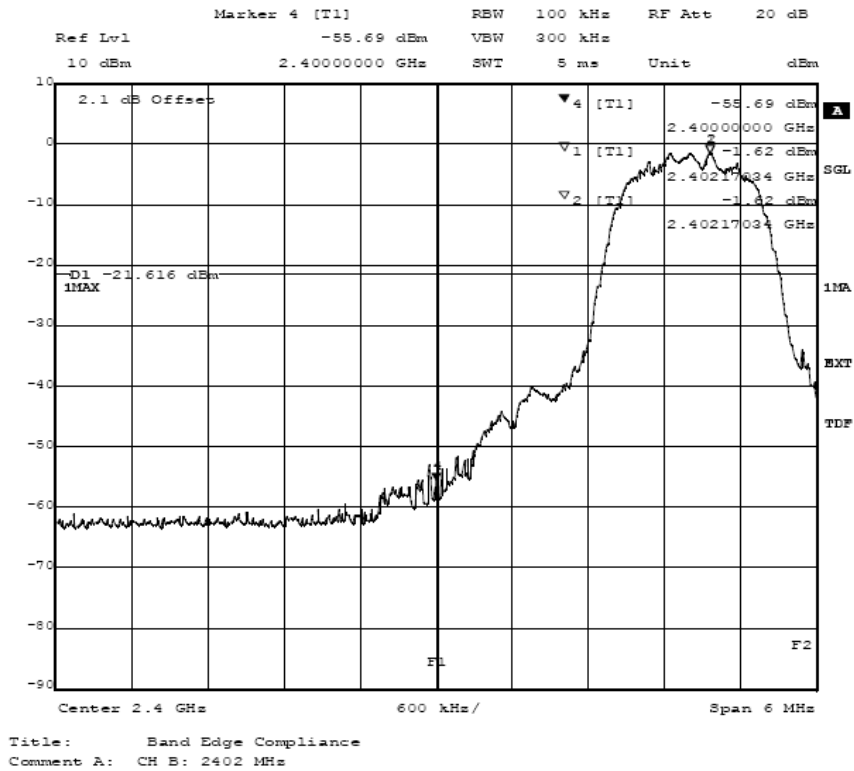

op-mode 12:

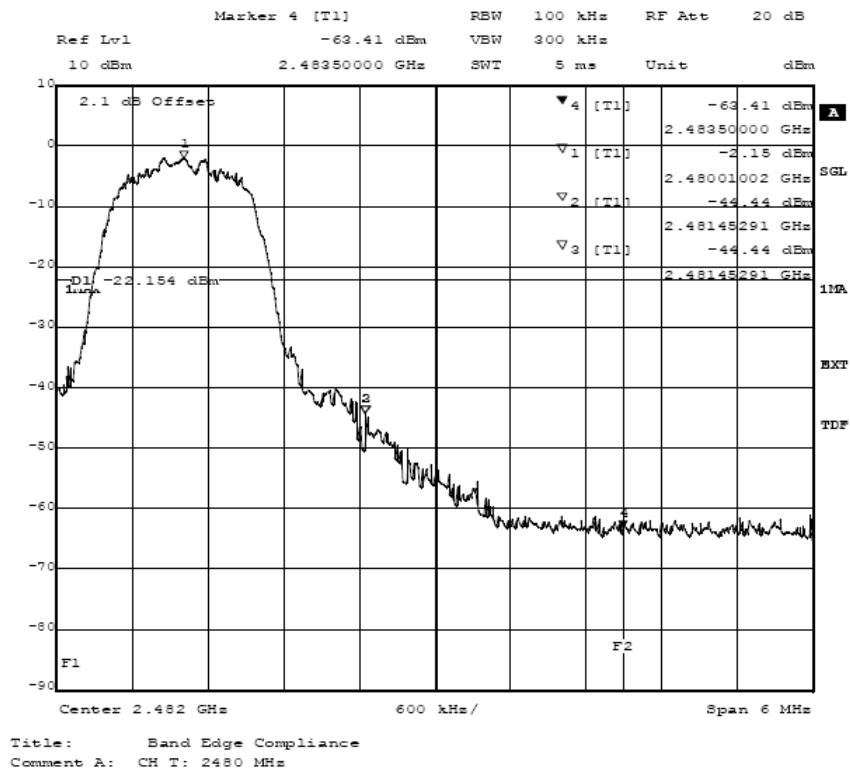

12. Antenna Application

12.1 Antenna requirement

The EUT'S antenna is met the requirement of FCC part 15C section 15.203 and 15.247.

FCC part 15C section 15.247 requirements:

Systems operating in the 2402-2480MHz band that are used exclusively for fixed, point-to-point operations may employ transmitting antennas with directional gain greater than 6dBi provided the maximum peak output power of the intentional radiator is reduced by 1dB for every 3dB that the directional gain of the antenna exceeds 6dBi.

12.2 Result

The EUT's antenna used a chip antenna and integrated on PCB, The antenna's gain is -2.34dBi and meets the requirement.

13. RF EXPOSURE EVALUATION

According to FCC 1.1310: The criteria listed in the following table shall be used to evaluate the environment impact of human exposure to radio frequency(RF) Radiation as specified in § 1.1307(b)

Limits for Maximum Permissible Exposure(MPE)

Frequency Range(MHz)	Electric Field Strength(V/m)	Magnetic Field Strength(A/m)	Power Density(mW/cm ²)	Average Time
(A) Limits for Occupational/Control Exposures				
300-1500	--	--	F/300	6
1500-100000	--	--	5	6
(B) Limits for General Population/Uncontrol Exposures				
300-1500	--	--	F/1500	6
1500-100000	--	--	1	30

13.1 Friis transmission formula: $P_d = (P_{out} * G) / (4 * \pi * R^2)$

Where

P_d = Power density in mW/cm²

P_{out} =output power to antenna in Mw

G = gain of antenna in linear scale

π =3.1416

R = distance between observation point and center of the radiator in cm

P_d the limit of MPE, 1mW/cm². If we know the maximum gain of the antenna and total power input to the antenna, through the calculation, we will know the distance where the MPE limit is reached.

13.2 Measurement Result.

Operating Mode	Channel Frequency (MHz)	Output Peak power (mW)	Antenna Gain (dBi)	Power density at 20cm (mW/ cm ²)	Power density Limits (mW/cm ²)
op-mode 1	2402	1.250	-2.34	1.45E-04	1
op-mode 2	2441	1.297	-2.34	1.51E-04	1
op-mode 3	2480	1.164	-2.34	1.35E-04	1
op-mode 6	2402	1.291	-2.34	1.50E-04	1
op-mode 7	2441	1.387	-2.34	1.59E-04	1
op-mode 8	2480	1.202	-2.34	1.53E-04	1
op-mode 10	2402	1.143	-2.34	1.33E-04	1
op-mode 11	2441	1.365	-2.34	1.59E-04	1
op-mode 12	2480	1.047	-2.34	1.22E-04	1