



Operating Instructions

NEW YORK 800

DVD/VCD/CD/MP3/MPEG4/SD/MMC/USB PLAYER WITH FM/AM TUNER
GPS & BLUETOOTH

Safety Precautions

Thank you for purchasing this product. Please read through these operating instructions so you will know how to operate your model properly. After you have finished reading the instructions, keep this manual in a safe place for future reference.

Only connect the unit to a 12-volt power supply with negative grounding.

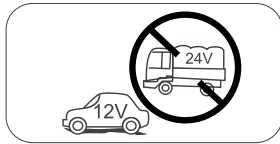

Never install this unit where the operation & condition for safety driving is restrained.

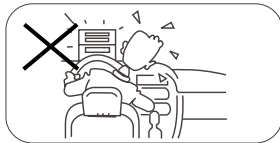

Never use the video display function in the front when driving to prevent the violation of laws & regulations and also to reduce the risk of traffic accident except using for rear view video camera.



Never expose this unit, amplifier, and speakers to moisture or water for preventing electric sparks or fires.

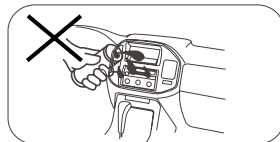

Please don't change the fuse on the power cord without professional guidance, using improper fuse may cause damage to this unit or even cause fire.

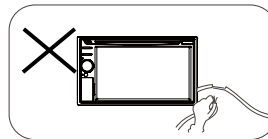

Please power off this unit at once and send it back to the after-sales service center or the dealer /distributor you purchased from if one of the following symptoms is found:

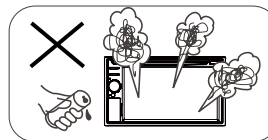

- (a). Water or other obstacle enters the unit;
- (b). Smoking;
- (c). Peculiar smell.

To ensure safe driving, please adjust the volume to a safe and comfort level in case of emergency situations.

Precautions

1. Never disassemble or adjust the unit without any professional guide.
For details, please consult any professional car shop / dealer for inquiry.
2. If the front panel or TFT monitor is squalid, please use a clean silicone cloth and neutral detergent to wipe off the spot. Using a rough cloth and non-neutral detergent such as alcohol for cleaning may result in scratching or decoloration to the applicant.
3. If any abnormal behavior of the unit is found, please refer to trouble shooting guide of this manual. If no relevant information is found, please press the [RESET] key on the front panel to resume factory default.
4. If you have parked the car in hot or cold weather for a long time, please wait until the temperature in the car becomes normal before operating the unit.
5. Using in-car heater in low temperature environment may result in beads coagulate inside the unit, DO NOT use the unit in this situation, eject the disc and wipe off the bead on the disc. If the unit still doesn't work after a few hours, please contact with after-sales service center.
6. No fierce impact to the LCD monitor when it is in open position for preventing the damage to any mechanisms inside.
7. To prevent the damage to the screen, avoid touching it with sharp objects.
8. To provide a clear demonstration and an alternative for easy understanding to the operation of this unit, graphic illustrations are used.
However, these illustrations are some different from the actual images displayed on the screen.
9. Operate the unit correctly according to this manual to prevent unnecessary problem. The guarantee won't be valid if the problem is caused by inappropriate operation.

Contents

Safety Precautions	1	Receive call	15
Precautions	2	Switch Phone Call to the Mobile	15
Contents	3	Adjust Bluetooth Settings.....	15
Before using	4	Select iPod as playing source.....	16
Front Panel	4	Play	16
Remote Control.....	5	Adjust sound	17
Notes of remote control using.....	6	Adjust volume	17
Uninstall Battery.....	6	Mute.....	17
Install Battery	6	Select preset equalizer	17
Basic operations	7	Adjust fader/balance	17
Power On/Off	7	SETUP	18
Open SOURCE MENU	7	Display System	18
Playing source selection	7	Adjust video settings.....	18
Set Date /Time.....	7	Adjust general Settings.....	18
Set date	7	Adjust time settings.....	18
Set clock mode	7	Adjust sound settings.....	19
Set time.....	7	Adjust language settings	19
Radio mode	8	Adjust Bluetooth settings	19
Select radio as playing source.....	8	Adjust DVD rating	20
Select one radio band.....	8	Adjust volume settings.....	20
Tune.....	8	Other modes	21
Preset station.....	8	Listen to other devices.....	21
Local Seeking	9	Reset	21
EQ Selection.....	9	Remove the unit.....	21
RDS Basics	9	Replace fuse.....	21
Adjust RDS Settings	9	GPS	21
PLAY	10	User-Defined Wallpaper	22
Load Disc.....	10	Device connections	23
Eject the Disc.....	10	Specifications	25
Touch Screen Controls	10	Region code	26
Connect USB/iPod Device.....	10	Cautions of disc using.....	26
Remove the USB/iPod Device.....	10	Troubleshooting	27
Insert SD/MMC Card	10	No power	27
Remove the SD/MMC Card.....	10	No sound	27
Play/Pause.....	11	No response to the remote control	27
Previous/Next	11	Disc does not play	27
Fast Forward/Backward.....	11	No image	27
Search for a Folder	11	Image flashes or distorted	27
Repeat	11	Noise in broadcasts	27
Repeat A-B	12	Preset stations lost	27
Random Play	12	Fuse is broken	28
Select Audio Mode.....	12	Display show ERR-12.....	28
Select Subtitle Language.....	12	About Bluetooth device.....	28
Change View Angle	12	Appendix	29
Rotate Pictures	13		
Zoom.....	13		
Bluetooth mode	14		
Pair the Bluetooth-enabled devices.....	14		
Disconnect Bluetooth device	14		
Make a call.....	14		

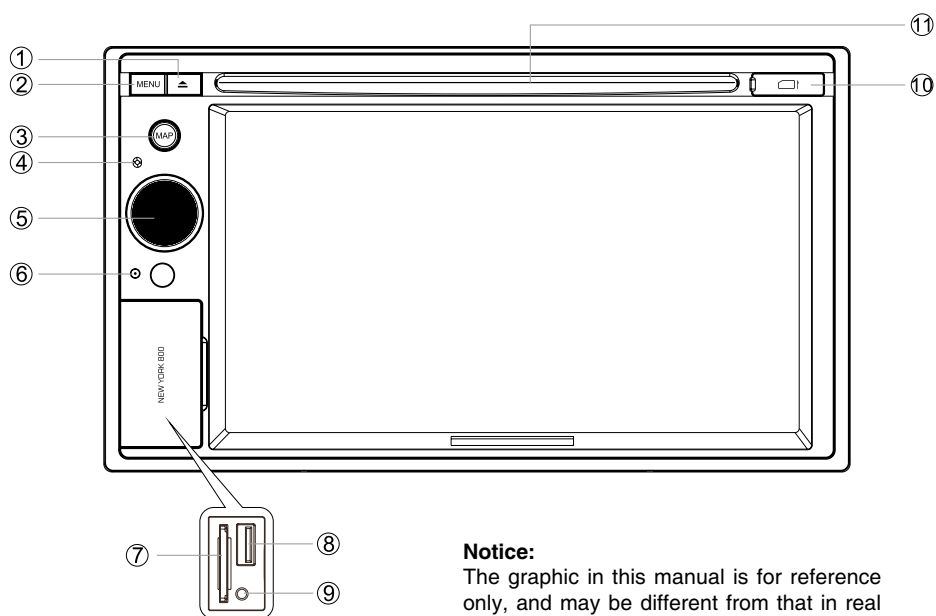

Before using

Front Panel



Notice:

The graphic in this manual is for reference only, and may be different from that in real unit. Reference to real unit is suggested.

1. [] Key: Eject disc
2. [MENU] Key: Switch to the current source and the main menu.
3. [NAV] Key: Enter navigation mode.
4. Microphone
5. [VOLUME / ] Knob:
Adjust volume (rotate)
Mute (short press)
Turn off the unit (long press)
6. Reset: Load the original setting.
7. SD/SDHC/MMC card slot
8. USB connector
9. AV-in jack
10. Map card slot
11. Disc slot

Before using

Remote Control



1. Return to the home menu.
2. Eject the disc
3. Select DVD dialogue language
Show music catalog
4. Display information
5. Zoom
6. Select radio band
7. Call out
8. Goto search
9. A-B Repeat
10. Repeat playback
11. Setup menu
12. Play / Pause / Enter
13. Move the cursor up/down/left/right.
Up/down: Manual tuning
14. Slow playback
15. Numeric keys
16. Random playback
17. Intro playback
18. Stop playback
19. Mute the volume
20. Adjust volume
21. Image setting
22. Previous/Next
Auto tuning
23. Hang up
24. Clear information
25. DVD title
26. DVD menu / PBC
27. Select view angle
Show video catalog
28. Select DVD subtitle language
Show photo catalog
29. Unit power
30. Open EQ setting menu

Before using

Notes of remote control using

- 1) Aim the remote control at the remote sensor on the unit.
- 2) Remove the battery from the remote control or insert a battery insulator if the battery has not been used for a month or longer.
- 3) DO NOT store the remote control under direct sunlight or in high temperature environment, or it may not function properly.
- 4) The battery can work for 6 months under normal condition. If the remote control can't work, please change the battery.
- 5) Use "button shaped" lithium battery "CR2025" (3V) only.
- 6) DO NOT recharge, disassemble, heat or expose the battery in fire.
- 7) Insert the battery in proper direction according to the (+) and (-) poles.
- 8) Store the battery in a place where children cannot reach to avoid the risk of accident.

Uninstall Battery

Slide out the battery compartment tray at the bottom on the back of the remote control.

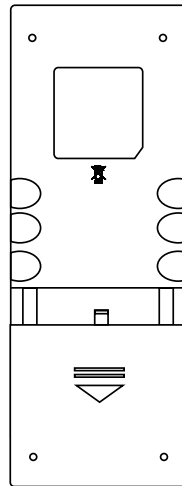

↓ PULL OUT

Install Battery

Use button-shaped lithium battery "CR2025 (3V)" only. Insert the battery to the battery tray with proper direction according to the (+) and (-) poles.

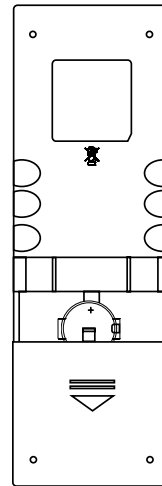

↑ PUSH IN

Basic operations

Power On/Off

Turn on: Short-press button(5) on the front panel or [POWER] key on the remote control.

Turn off: When on, long press button(5) on the panel or press [POWER] key on the remote control.

Open SOURCE MENU

Press the [MENU] key on the front panel or touch the top left corner of the screen to open the SOURCE MENU.



Playing source selection

Open the SOURCE MENU, and then touch the source you desired or select one source by moving the cursor and then confirm.

Notes:

Playing source selection means selecting work mode, such as DVD mode, Radio mode, Camera mode, etc.

Set Date /Time

1. Touch [Settings].
2. Touch [Time].
The date/time setup menu is displayed.



Set date

1. Touch [Date].
2. Touch the date information on the screen .
A submenu is displayed.
3. Touch ▲ or ▼ to set year, month and day.



Set clock mode

1. Touch [Clock mode].
2. Touch [12Hr] or [24Hr] to switch clock mode.

Set time

1. Touch [Time].
2. Touch the time on the screen, a submenu is displayed.
3. Touch ▲ or ▼ to set hour and minute.



Tip:

When date/time is set, touch the upper left corner of screen to exit.

Radio mode

Select radio as playing source

Open the SOURCE MENU and then touch [Radio].



Select one radio band

Press the [BAND] key on remote control or touch the [📶] icon on the user interface to select one radio band among FM1, FM2, FM3, AM1 and AM2.

Tune

Auto tuning

Press the [⏪] / [⏩] key on the remote control briefly or hold [⏪] / [⏩] icon on the user interface more than 1 second to seek a higher / lower station.

To stop searching, repeat the operation above or press other keys having radio functions.

Note:

When a station is received, searching stops and the station is played.

Manual tuning

Method 1:

During manual tuning, the frequency will be changed in steps.

Press the [▲] or [▼] key on remote control or touch the [⏪] / [⏩] icon on the user interface to tune in a higher / lower station.

Method 2:

1. Touch the numeric keypad icon [1234567890]. Numeric keyboard is displayed, touch number to input frequency.
2. Touch [⏪] to delete the input number step by step.
3. Touch [C] to clear all of the input numbers.
4. Touch [✓] to enter.



Preset station

The unit has 5 bands, such as FM1, FM2, FM3, AM1, AM2, and Each band can store 6 stations; hence the unit can store 30 stations in total.

Search stations automatically

Touch [🔍] to search station and store 6 strongest stations in current band automatically.

Manual store

1. Tune to a station.
2. Touch [➡️].
3. Touch one of the channels 01 to 06 to save the select band.

Tune to a preset station

1. Touch [Radio].
2. Select band.
3. Touch one of the preset channels (01 to 06) on the bottom of the screen.

Radio mode

Local Seeking

Touch the [LOC] icon and choose the Radio Local or Distance.

When the [LOC] icon turns bright, only stations with sufficient signal strength will be detected.

EQ Selection

Press the [EQ] icon and enter the EQ setup.

RDS Basics

RDS service availability varies with areas. Please understand if RDS service is not available in your area, the following service is not available.

AF Mode

AF (Alternative Frequency): When the radio signal strength is poor, enabling the AF function will allow the unit to automatically search another station with the same PI (program identification) as the current station but with stronger signal strength.

Touch [AF] on the screen to turn on/off AF function.

AF turns red: AF function is activated.

AF turns gray: AF function is disabled.

TA Mode

Some RDS FM stations periodically provide traffic information.

TP (Traffic Program Identification)

This station can broadcast traffic information.

TA (Traffic Announcements Identification)

Radio announcements on traffic conditions or EON station.

Touch [TA] on the screen to turn on/off TA function.

When TA mode is turned on, the TA indicator will turn red.

When traffic announcement is received, the unit will temporarily switch to the tuner mode (regardless of the current mode) and begin broadcasting the announcement at TA volume level.

After the traffic announcement is over, it will return to the previous mode and volume level. When TA is turned on, SEEK, SCAN, AMS function can only be received or saved when traffic program identification (TP) code is received.

EON default is on.

Adjust RDS Settings

1. In Radio menu, touch [≡].
The option menu is displayed.
2. Touch on the selected option to change the setting.
 - [RDS]: to turn on or off "RDS" function.
 - [CT]: to turn on or off "Clock Time" synchronization function.
 - [TA VOL]: Touch [◀] or [▶] to adjust traffic announcement volume.
 - [PTY List]: to set pairing code.



PLAY

Load Disc

You can play video, audio or images stored on the following discs:

- DVD Video, DVD-R, DVD-RW
- VCD
- Audio CD, CD-R, CD-RW

Note:

Ensure that the disc contains playable content.

Eject the Disc

Press the [▲] key on the front panel or remote control to eject the disc. When the disc is ejected, the unit switches to the previous source.

Touch Screen Controls

The touch key areas for DVD playback are outlined below:

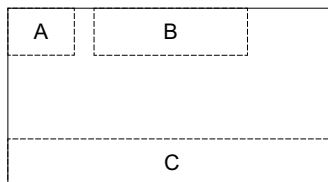

- A: Return the main menu
- B: Play the video and display playback information
- C: Display onscreen control menu

Connect USB/iPod Device

1. Open the USB door.
2. Insert the small end of the supplied USB/iPod cable to the USB socket, then connect the other end of the cable to your USB/iPod device.

* You can also connect the USB/iPod to the rear USB port.



Remove the USB/iPod Device

1. Select other source on the main menu.
2. Remove the USB/iPod device.



Insert SD/MMC Card

1. Open SD/MMC card cover.
2. Insert the SD/MMC card into the SD/MMC card slot.
Play starts automatically.



Remove the SD/MMC Card

1. Select other source on the main menu.
2. Press the card unit you hear a click sound.
3. Remove the SD or MMC card.

PLAY

Play/Pause

1. Once a disc,USB or SD/MMC card is inserted, play starts automatically.
For DVD movie, if a menu appears, press [▶] to start play.
2. To pause, touch [⏏].
To resume play, touch [▶].
3. Skip to previous/next track/chapter, press [⏮] / [⏭] key.



(DVD)

Previous/Next

Touch [⏮] / [⏭] key on the screen to skip to previous/next track/chapter.

Fast Forward/Backward

Touch [⏩] / [⏪] key on the screen repeatedly to playback fast forward/backward.

Search for a Folder

For video files

1. Touch [🎬] to display all available video folders.
2. Touch a folder, then touch [⬆] or [⬇] to select a file.
3. Touch [▶] to start play.
4. Touch [■] to stop and return to the root menu.



(CD/MP3)

For audio files

1. Touch [🎵] to display all available audio folders.
2. Touch a folder, then touch [⬆] or [⬇] to select a file.
3. Touch [▶] to start play.
4. Touch [■] to stop and return to the root menu.

For picture files

1. Touch [🖼️] to display all available picture folders
2. Touch a folder, then touch [⬆] or [⬇] to select a picture.
3. Touch [▶] to view the picture.
4. Touch [■] to exit playing and return to the root.







Repeat

For DVD/VCD movie disc:

1. Touch bottom half of the screen to display menu on the screen, if necessary.
2. Touch [1/2] to display the 2nd menu.
3. Touch [Repeat] to select:
 - DVD
 - Repeat chapter: play the current chapter repeatedly.
 - Repeat title: play all chapters in the title repeatedly..
 - Repeat off: cancel repeat play.
 - VCD
 - Repeat single: play the current single repeatedly.
 - Repeat all: play all in the all repeatedly.
 - Repeat off: cancel repeat play.

PLAY

For CD/MP3/WMA files:

1. Touch anywhere except the upper left corner to display menu on the screen, if necessary.
2. Touch [] to select:
 - []: Play the current chapter repeatedly.
 - []: Play all the tracks in the folder repeatedly.
 - []: Cancel repeat play

Tip

You can also press REPEAT on the remote control to select repeated play mode.

Repeat A-B

You can repeat a specific of video file (repeat A-B).

1. Touch bottom half of the screen to display control menu, if necessary.
2. Touch [1/2] to display the 2nd menu, if necessary.
3. Touch [A-B] repeatedly to mark:
 - Repeat A-: the start of the section to repeat.
 - Repeat A-B: the end of the section to repeat.The selected section plays repeatedly.
4. To exit A-B repeat mode, touch A-B repeatedly, [Repeat A-B off] is displayed.

Random Play

You can play audio tracks/files in random order.

During play, touch [RDM] on the remote control repeatedly to turn random play on or off.

Select Audio Mode

When you play VCDs, you can select an audio mode (R/L/Stereo).

1. During play, touch bottom half of the screen to display menu on the screen, if necessary.
2. Touch [1/2] to display the 2nd menu.
3. Touch [Audio] repeatedly until the audio mode is selected.



Select Subtitle Language

For DVD or Divx discs that contain two or more subtitle languages.

1. During play, touch bottom half of the screen to display menu on the screen, if necessary.
2. Touch [1/2] to display the 2nd menu.
3. Touch [Sub Title] repeatedly to select a language.
 - The selected language is displayed.

Tip

You may also press SUBTITLE on the remote control repeatedly to select subtitle language.

Change View Angle

Some DVDs contain alternate scenes, such as scenes recorded from different camera angles. For such DVDs, you can select from the available alternate scenes.

1. During play, touch bottom half of the screen to display menu on the screen, if necessary.
2. Press [ANGLE] repeatedly on the remote control.
 - The view angle is changed.

PLAY

Rotate Pictures

1. When you view pictures, touch bottom half of the screen to display menu on the screen, if necessary.
2. Touch [Rotate] repeatedly to rotate the picture.

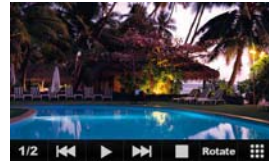

Zoom

You can zoom in pictures for a close view.

1. When you view pictures, touch bottom half of the screen to display menu on the screen, if necessary.
2. Touch [1/2] to display the 2nd menu, if necessary.
3. Touch [Zoom] repeatedly to zoom in the picture.
4. Use [↑], [↓], [←], [→] keys to pan through the enlarged picture.



Bluetooth mode

You can make or receive phone calls with Bluetooth-enabled phones through the unit. You can also listen to music from a Bluetooth-enabled device.

Pair the Bluetooth-enabled devices

To connect your Bluetooth device to the unit, you need to pair the device to the unit. Pairing needs only to be done once. You can pair up to five devices.



1. Turn on the Bluetooth function on the device.
2. Search for Bluetooth device with the device.
3. Select "CE6904" in the pairing list.
4. Enter default password "0000".
If pairing succeeds, phone call record is displayed.



Tip:

- The operational range between this unit and a Bluetooth device is approximately 10 meters (30 feet).
- Before you connect a Bluetooth device to this unit, familiarize yourself with the Bluetooth capabilities of the device.
- Compatibility with all Bluetooth device is not guaranteed.
- Any obstacle between this unit and a Bluetooth device can reduce the operational range.
- Keep this unit away from any other electronic device that may cause interference.







Disconnect Bluetooth device

To disconnect one device, touch [] (Blue).
[] (Green) is displayed.

Tip

- The device will also be disconnected when the device is moved beyond the operational range.
- If you want to reconnect the device to the unit, place it within the operational range.
- If you do not want to reconnect the device to the unit automatically, touch [], then touch [Auto connect] until [Off] appears after [Auto connect]. For details, see the "Adjust Bluetooth settings" section.

Make a call

1. Select [Bluetooth] in the home menu.
 2. Pair the phone with the unit.
 3. Touch [], [] to select the paired phone, touch it to select.
 4. Touch [], [] to search for phone number from the following list:
 - [Missed calls]
 - [Received calls]
 - [Dialed calls]
 - [Phone book]
- Or touch [] to dial number directly, then touch [] to dial.



Bluetooth mode

Receive call

By default, all incoming calls are received automatically.

1. If there is incoming call, [Incoming call...] flashed on the screen.
Speak into the Bluetooth microphone.
2. When conversation ends, touch [] (red) to terminate the call.



Tip



- You can select to receive calls manually by set [Auto answer] to [Off] status.

Switch Phone Call to the Mobile

If you do not want your passenger to hear your incoming call, you can switch the call to the mobile.

1. During talking, touch [].
The voice is transferred from the unit's loudspeaker to the mobile phone.

Adjust Bluetooth Settings

1. In Bluetooth menu, touch [].
The option menu is displayed.
2. Touch on the selected option to change the setting.
 - [Bluetooth]: to turn on or off "Bluetooth" function.
 - [Auto Connect]: to turn on or off "Auto connect" function.
 - [Auto Answer]: to turn on or off "Auto answer" function.
 - [Pairing Code]: to set pairing code.
 - [Phone Book Sync]: to synchronize phone book, touch [] on the sub-menu popped out.

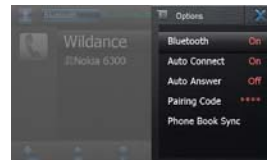

Tip

- You can also adjust Bluetooth settings in the "Settings" menu.

iPod

Select iPod as playing source

Turn on the unit's power, and connect an iPod to the unit via a iPod cable, the unit will load the iPod automatically.

Play

On the iPod main menu, operate the iPod via touch panel.

For audio files

1. When the music root menu appears on the screen, touch an option (such as PlayLists, Artists...), then touch [↑] or [↓] to select a file.
2. Touch the selected option to play back.
3. To pause, touch [||].
To resume play, touch [▶].
4. Skip to previous/next track, press [⏮] / [⏭] key.



NowPlaying: If you return to the root menu when playing a song, you can touch [▶] to continue the previous playback.

For video files

1. Touch [🎬] to display video folders root.
2. Touch an option, then touch [↑] or [↓] to select a file.
3. Touch [▶] to start play.
4. Touch [■] to stop and return to the root menu.

For picture files

1. Touch [🖼️] to return to playlist menu.
2. Touch [📷], then operate on your iPod.

Adjust sound

Adjust volume

To adjust volume, rotate the volume knob on the front panel.

Mute

When playback, press the VOLUME knob on the panel or [] on the screen (if available), the sound is cut off.



To resume sound, press the button again.

Select preset equalizer

You can select preset equalizer:







- [User]
- [Techno]
- [Rock]
- [Classic]
- [Jazz]
- [Optimal]
- [Flat]
- [Pop]



1. Touch [] on the screen.
The current Equalizer setting is displayed.
2. Touch [+] or [-] to select an EQ.
3. Touch [+] or [-] to adjust below settings:
 - [Bass] bass range: -14 to +14
 - [Mid] middle range: -14 to +14
 - [Treb]treble range: -14 to +14
 - [LPH]low pass filter range: 60, 80, 100, 200
 - [MPF]middle pass filter range: 0.5K, 1K, 1.5K, 2.5K
 - [HPF]high pass filter rang: 10K, 12.5K, 15K, 17.5K
4. Touch [] to restore the above settings into default settings.
5. Touch the upper left corner of the screen to exit.

Adjust fader/balance

You can also adjust the front and rear speaker balance, the left and right speaker balance, and subwoofer settings.

1. Touch [] on the screen.
2. Touch [].
Below options are displayed:
3. Touch [+] or [-] to select subwoofer volume.
 - [Sub] subwoofer volume: 0 to 24.
4. Touch [], [] or [], [] to adjust fader/balance value.
 - [Fade] fader range: - 24 to +24 (F=front range, R=rear range)
 - [Balance] balance range: -24 to +24 (L=left range, R=rear range)
5. Touch the upper left corner of the screen to exit.



SETUP

Display System

1. Touch the upper left corner to display main menu.
2. Touch [Settings].
The settings menu is displayed.



Adjust video settings

1. Touch [Video].
2. Touch an option repeatedly to select:
3. Touch the upper left corner of the screen to exit.

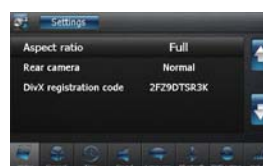

Video settings	Options	Description
Aspect ratio	Full	For widescreen display
	Normal	For normal display
Rear camera	Normal	When you drive in reverse, the rear view displayed in normally.
	Mirror	When you drive in reverse, the rear view is displayed inmirror.
DivX registration code	View code for DivX registration.	

Adjust general Settings

1. Touch [General], if necessary.
2. Touch [↑] or [↓] to highlight a setting.
3. Touch on the option to display/select an option.
4. Touch blank area of the screen to exit.



General settings	Options	Description
Radio region	USA	Select one that matches your location.
	Asia	
	Japan	
	Europe	
	Europe (LW)	
Blackout	Off	Never turn on the screen saver.
	10S	Turn on the screen saver automatically 10 seconds after last operation.
	20S	Turn on the screen saver automatically 20 seconds after last operation.
Beep	On	Burn on the beep sound. Each time you press a button, the unit beeps.
	Off	Turn off the beep sound.
Wallpaper	Black/Shore Waves/Lotus Flower/Smart Cars/Dense Flowers	You can select the fond wall paper.
Calibration	Calibrate the touch screen.	

Adjust time settings

Please reference for the page 7.

SETUP

Adjust sound settings

1. Touch [Sound].
2. Touch an option repeatedly to select:
3. Touch the upper left corner of the screen to exit.



Sound settings	Options	Description
Subwoofer	On	Turn on the subwoofer.
	Off	Turn off the subwoofer
Subwoofer filter	80Hz	Select subwoofer filter criteria.
	120Hz	
	160Hz	
Loudness	On	The dynamic Bass Boost functions is on.
	Off	The loudness function is off.

Adjust language settings

1. Touch [Language].
2. Touch an option repeatedly to select.
3. Touch the upper left corner of the screen to exit.



Language settings	Description
OSD	Select on-screen display language.
DVD audio	Select DVD audio language. Options available are depends on DVD disc.
DVD subtitle	Select DVD subtitle language. Options available are depends on DVD disc.
Disc menu	Select DVD menu language. Options available are depends on DVD disc.

Adjust Bluetooth settings

1. Touch [Bluetooth].
2. Touch an option repeatedly to select.
3. Touch the upper left corner of the screen to exit.



Bluetooth settings	Options	Description
Bluetooth	On	Turn on the Bluetooth function.
	Off	Turn off the Bluetooth function.
Auto connect	On	If the pre-paired device is within the effective range, the unit re-connects to pre-paired device automatically.
	Off	Need to re-connect manually.
Auto answer	On	Answer paired phone call automatically.
	Off	Answer phone call manually.
Microphone	Internal	Use internal microphone
	External	Use external microphone (need to be connected)
Pairing code		Set the password for pairing the unit with other Bluetooth device.

SETUP

Adjust DVD rating



1. Touch [DVD rating].
2. Touch an option repeatedly to select.
3. Touch the upper left corner of the screen to exit.



DVD rating	Options	Description
Set password		Set password to restrict the play of discs. The supper password is 4321.
Rating level	Kid safe	Acceptable for children.
	G	Acceptable for general viewers.
	PG	Parental guidance suggested.
	PG-13	Unsuitable for children under age 13.
	PG-R	Recommend parents to restrict children under 17 to view.
	R	Restricted recommend parents to guide children under 17 to view.
	NC-17	Unsuitable for children under age 17.
Adult	Acceptable for adults only.	
Load factory		Restore to default settings.

Adjust volume settings

You can set different volume for different modes.

1. Touch [Volume].
The volume setting sub-menu is displayed.
2. Touch on a source.
 - [DVD] · [AV-IN1]
 - [USB] · [AV-IN2]
 - [SDHC] · [Navigation]
 - [Radio] · [iPod]]
 - [Bluetooth] ·
3. Touch [] or [] to assign value: 0 to 12.
When switches to the source, the volume increases automatically.
4. Touch the upper left corner of the screen to exit.



Other modes

Listen to other devices

You can connect an external audio/video device to be unit.

1. Connect the car audio to the device with the supplied AV cable.
2. Touch the upper left corner to display the main menu.
3. Touch [AV-IN1] / [AV-IN2].
4. Operated the connected the device(see the instructions manual of the device).

Tip

If you connected the system to other audio device through the REAR OUT L/R connectot(see "Connect wires" section), touch [AV-IN] to listen to that device.

Reset

When the unit hangs up, you can reset it.

Press RESET with a ball-point pen or similar tool.

Tip

When the unit is reset,all the settings remain unchanged.

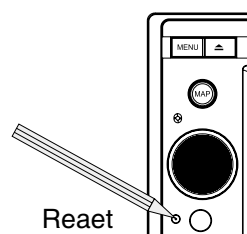

Remove the unit

To repair ,replace fuse ,or replace the unit with another car audio,remove it from the dashboard.

1. Take off the trim plate.
2. Screw off the four screws on the left/right side of the unit.
3. Pull the unit out from the dashboard.

Replace fuse

If there is no power,the fuse may be damaged and need to be replaced.

1. Take out the unit from dashbpard.
2. Check the electric connection.
3. Buy a fuse that matches the voltage of the damaged fuse.
4. Replace the fuse.

GPS

1. Touch the upper left corner to display home menu.
2. Touch [Navigation], the navigation menu is display in a few seconds.
3. Refer to the map manual to operate the navigation tool.

Tip:

You can press [NAV] button of the panel to enter/exit the navigation system.

Other modes

User-Defined Wallpaper

1. Entry

Select Setting mode on the Source menu, touch [wallpaper] in the General setting, then touch the downwards button of the listed submenu until you find [user defined], touch it to enter user-defined wallpaper management.

2. Load picture from SD Card and use it as wallpaper

If you insert the SD Card with pictures in it after your entry, you may have to wait several seconds for the SD Card reading. Otherwise you may use it directly.

To Select a picture in SD Card, you should touch " Search SD Card" button first, then the directories and the files will be listed. If you select a directory and then touch "√" button , you will enter the directory. If you select a picture and then touch "√" button, the picture will be loaded into the flash and used as current wallpaper at the same time.

Touch the button below "√" to go back to view the pictures in flash.

Touch the button at the right side of the display of directory to go back to the upper directory.

3. Use or delete pictures in flash

After the 1st step, you can see the pictures in flash listed out, you can preview them by select one of them, then touch the "√" button to use it as wallpaper.

You can also delete pictures in flash which you are not currently using. Select one and touch the garbage box button.

Device connections

Parking Brake Cable Connections

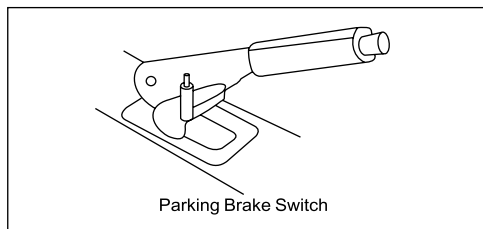
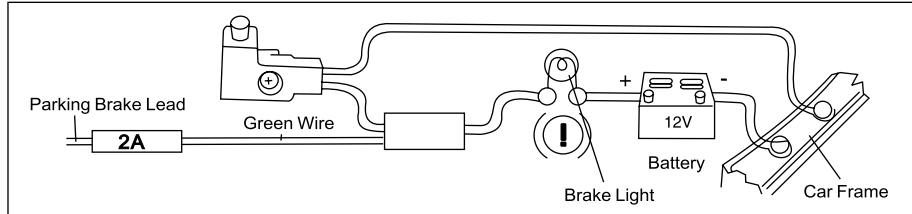

Reverse Driving Cable Connections

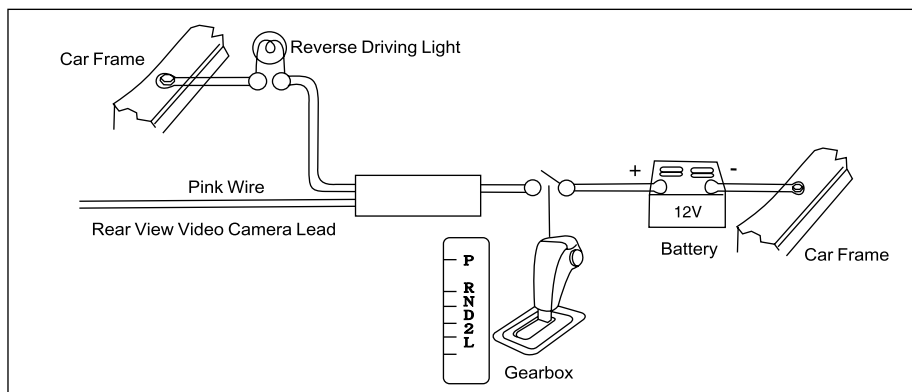

Device connections

Installation Guide

1. If relevant, remove any other audio system from the car.
2. Perform the required electrical connections:
 - If necessary, connect the hand brake wire to your hand brake contact in order to activate the video display when playing a DVD (when the car is parked).
 - Connect the wire that activates the reversing camera to the reversing sensor or to a reversing light. If necessary, connect your reversing camera to the car radio's reversing camera input using a video cable (not supplied).
 - Ensure that you now place the USB cable located at the back of the unit in such a way that it comes out of the dashboard or the glove box.
3. Then check that everything works before installing the main unit.
4. Remove the two screws on the top of the unit, otherwise, the unit will not work.
5. Install the car radio in the dashboard using the supplied screws (M5x6mm).
6. Attach the outer trim frame.
If you are not sure how to install this unit correctly, contact a qualified technician.

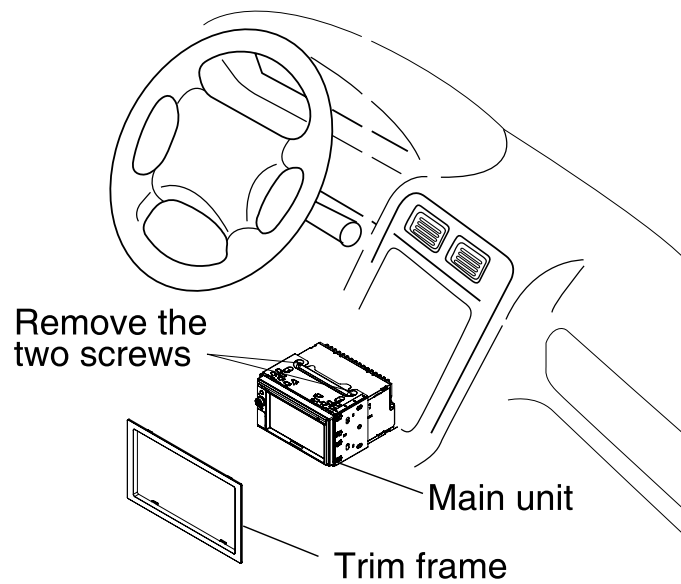

Specifications

General

Reference Supply Voltage.....	12V(DC)
Operating Voltage Range.....	10.5 - 15.8V(DC)
Max Operating Current.....	15A
Grounding System.....	Car Battery Negative Pole
Dimensions(WXHXD).....	178X100X173mm
Weight(main unit).....	2.5kg

FM

Signal Noise Ratio.....	≥ 55dB
Residual Noise Sensitivity(S/N=30dB).....	18dB μ V
Frequency Response(\pm 3dB).....	20Hz~12.5KHz
Station Seeking Level.....	20~28dB μ V
Distortion.....	≤ 1.0%
Stereo Separation(1KHz).....	≥ 25dB
Antenna Impedance.....	75 Ω

AM

Residual Noise Sensitivity (S/N=20dB).....	30dB μ V
Selectivity (\pm 9KHz).....	≥ 50dB

LCD

Screen size.....	6.2 inches(16:9)
Display resolution.....	800X480dots
Contrast ratio.....	400
Brightness.....	280cd/m ²

DVD Player

Signal / Noise Ratio.....	80dB
Dynamic Range.....	80dB
Distortion(line out).....	≤ 0.1%
Frequency Response(\pm 3dB).....	20Hz~20KHz
Maximum Output Power.....	4x45W
Load Impedance.....	4 Ω

AUX IN

Distortion.....	≤ 0.5%
Frequency Response(\pm 3dB).....	20Hz~20KHz
Audio Input Level.....	1Vrms

Audio

Audio Output Impedance.....	100 Ω
Audio Output Level.....	4Vrms(Max)

Video

Normal Video Input Level(CVBS).....	1.0 \pm 0.2V
Video Input Impedance.....	75 Ω
Video Output Impedance.....	75 Ω
Video Output Level.....	1.0 \pm 0.2V

Environment

Operating Temperature.....	-10°C ~ +60°C
Storing Temperature.....	-20°C ~ +70°C
Operating Humidity.....	45%~80%RH
Storing Humidity.....	30%~90%RH

Notice:

When the unit is operated extremely, such as operated with maximum power output for a long time, or the temperature is over 70°C, it will enter heat protection mode, the volume will be lower automatically. This is normal.

Specifications

Supported formats:

- USB or memory file format:FAT16,FAT32
- Mp3 bit rate(date rate):32-320 Kbps and variable bit rate
- WMA v9 or earlier
- Directory nesting up to a maximum of 8 levels
- Number of albums/folders:maximum 99
- Number of tracks/titles:maximum 999
- ID3 tag v2.0 or later
- File name in Unicode UTF8(maximum length:128 bytes)

Unsupported formats:

- Empty albums:an empty album is an album that does not contain MP3/WMA files,and is not be shown in the display.
- Unsupported file formats are skipped.For example,Word documents(.doc) or Mp3 files with extension.dlf are ignored and not played.
- AAC,WMV,PCM audio files
- DRM protected WMA files(.wav,.m4a,.m4p,.mp4,.aac)
- WMA files in Lossless format

Supported MP3 disc format:

- ISO9660,Joliet
- Maximum title number:512(depending on file name length)
- Maximum album number:255
- Supported sampling frequencies:32kHz,44.1kHz,48kHz
- Supported Bit-rates:32-320Kbps and variable bit rate

Supported video formats:

- DVD
- MP4
- Xvid

Region code

According to DVD sale region, the whole world is divided into six regions. A DVD disc can be played back only when its region code is compatible with that of the player in use.

Region 1: USA, Canada, East Pacific Ocean Islands;

Region 2: Japan, West Europe, North Europe, Egypt, South Africa, Middle East;

Region 3: Taiwan of China, Hong Kong of China, South Korea, Thailand, Indonesia, South East Asia;

Region 4: Australia, New Zealand, Mid & south America, South Pacific Ocean Islands/Oceania;

Region 5: Russia, Mongolia, India, Middle Asia, East Europe, North Korea, North Africa, North West Asia;

Region 6: Chinese Mainland.

Cautions of disc using

1) DO NOT use irregular shaped disc

2) Disc Cleaning

Use a dry, soft cloth to wipe the disc from center to edge, only neutral detergent can be used.

3) When playing a new disc

New disc may have some rough spots around the inner and outer edges. If such a disc is used, remove these rough spots with a pencil or ball-point pen, etc.

Troubleshooting

Warning

Never remove the casing of this apparatus.

To keep the warranty valid, never try to repair the system yourself. If you encounter problems when using this apparatus, check the following points before requesting service. If the problem remains unsolved, please contact your dealer.

No power

- Car engine has not been started. Start the car engine.
- Connections is ncorrect.
- Fuse has been damaged. Replace fuse.

No sound

- Volume is too low. Adjust volume.
- Speaker connections is incorrect.

No response to the remote control

- Ensure that the path between the remote control and the unit is clear from obstacles.
- From a close distance, point the remote control directly at the unit.
- Replace the remote control battery.
- The function does not work. Refer to the instructions.

Disc does not play

- Disc is upside down. Ensure the printed side is upwards.
- Disc is dirty. Clean the disc with a clean, soft, lint-free cloth. Wipe the disc outwards from the center.
- Disc is defective. Try another disc.
- Incompatible disc is used. Try another disc.
- Disc rating exceeds the restrict setting. Change the rating settings to lower one.
- Disc region code is not compatible with the unit. Use disc with proper region code.

No image

- Parking brake wire connection is incorrect. Check the parking wiring.

Image flashes or distorted

- Video DVD settings do not match with the DVD. Adjust video DVD settings.
- Video connection is improper. Check the connections.

Noise in broadcasts

- Signals are too weak. Select other stations with stronger signals.
- Check the connection of the car antenna.
- Change broadcast from stereo to mono.

Preset stations lost

- Battery cable is not correctly connected. Connect the battery cable to the terminal that is always live.

Troubleshooting

Fuse is broken

- The Fuse type is incorrect. Replace it with a 15A fuse.
- Speaker wire or power wire is grounded.
Check the connections.

Display show ERR-12

- USB date error. Check the USB device.

About Bluetooth device

Music playback is unavailable on the system even after successful Bluetooth connection.

- The device cannot be used with the system to play music.

The audio quality is poor after connection with a Bluetooth-enabled device.

- The Bluetooth reception is poor. Move the device closer to the system or remove any obstacle between the device and the system.

Cannot connect with the system.

- The device does not support the profiles required for the system.
- The Bluetooth function of the device is not enabled. Refer to the user manual of the device for how to enable the function.
- The system is not in the pairing mode.
- The system is already connected with another Bluetooth-enabled device. Disconnect that device or all other connected devices and then try again.

The paired mobile phone connects and disconnects constantly.

- The Bluetooth reception is poor. Move the mobile phone closer to the system or remove any obstacle between the mobile phone and the system.
- Some mobile phones may connect and disconnect constantly when you make or end calls. This does not indicate any malfunction of the system.
- For some mobile phones, the Bluetooth connection may be deactivated automatically as a power-saving feature. This does not indicate any malfunction of the system.

Appendix

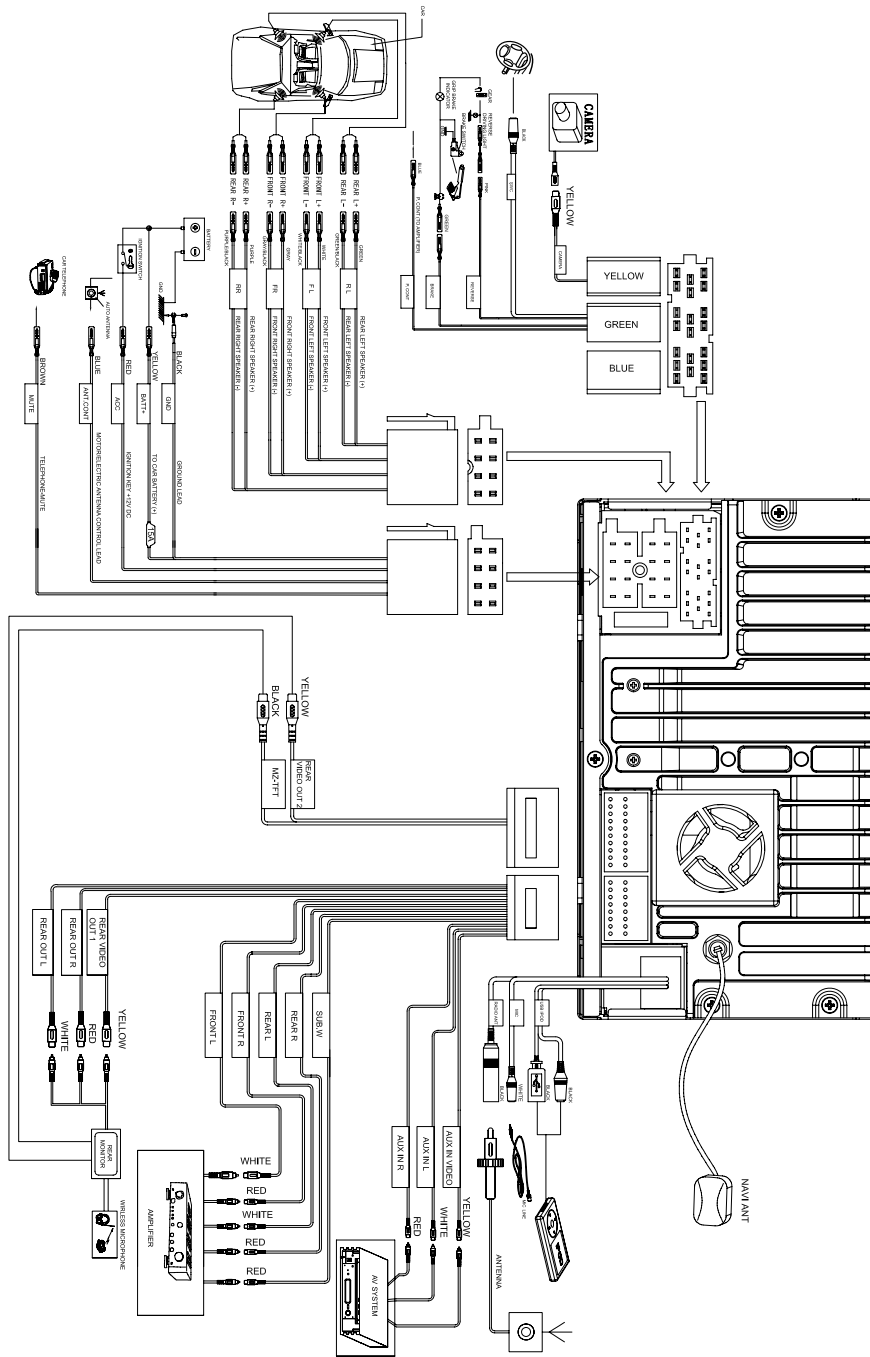

FCC warning statement

This equipment has been tested and found to comply with the limits for a Class B digital device, pursuant to part 15 of the FCC Rules. These limits are designed to provide reasonable protection against harmful interference in a residential installation. This equipment generates, uses and can radiate radio frequency energy and, if not installed and used in accordance with the instructions, may cause harmful interference to radio communications. However, there is no guarantee that interference will not occur in a particular installation. If this equipment does cause harmful interference to radio or television reception, which can be determined by turning the equipment off and on, the user is encouraged to try to correct the interference by one or more of the following measures:

- Reorient or relocate the receiving antenna.
- Increase the separation between the equipment and receiver.
- Connect the equipment into an outlet on a circuit different from that to which the receiver is connected.
- Consult the dealer or an experienced radio/TV technician for help

This equipment complies with FCC radiation exposure limits set forth for an uncontrolled environment. This equipment should be installed and operated with minimum 20 cm between the radiator and your body. This transmitter must not be collocated or operating in conjunction with any other antenna or transmitter unless authorized to do so by the FCC.

Changes or modifications not expressly approved by the party responsible for compliance could void the user's authority to operate the equipment.