

RYDEEN[®]

find your road

Owner's Manual

DVA6

English

Manual de Instrucciones

DVA6

Español

Guide de l'Utilisateur

DVA6

Français



Android Powered - 2 Din Multimedia Receiver with Built-in Bluetooth

Android Powered - 2 Din Multimedia Receiver with Built-in Bluetooth

Moteur Android- Multimédia 2 Din Récepteur avec Bluetooth Intégré

Welcome Statement & Warnings

Thank you for purchasing the RYDEEN DVA6, that it will make your driving experience easier & hassle-free.

The DVA6 provides an easy-to-use touch screen user interface and innovative functionality in a stylish design that replaces the factory radio.

Please read this Owner's Manual carefully. If you have any further questions about your DVA6 operation, feel free to call RYDEEN, Toll Free at 1-877-777-8811 (within USA only) for product support, or visit our website: www.rydeenmobile.com.

⚠ PRECAUTIONS & WARNINGS ⚠

IMPORTANT INFORMATION

PLEASE READ CAREFULLY BEFORE USING THIS PRODUCT

We recommend that you read and follow all information and instructions in this Owner's Manual for the best performance and satisfaction of your DVA6.

- Your DVA6 navigation software **IS NOT** a substitute for personal judgment. The route suggestions should never supersede any local traffic regulation, personal judgment or knowledge of safe driving practices. Before making any maneuvers (for example, a U-turn or a left turn) suggested by the DVA6 system, please be sure that such a maneuver can be completed legally and safely. Do not follow route suggestions that could put you or your vehicle in a potentially unsafe or illegal circumstance.
- You should not depend on DVA6 to locate emergency services (such as police, fire stations, hospitals and clinics). The database may not include all emergency service providers. It is the best to call your local police department and ask for directions in these situations.
- Set the unit volume at a level that will allow you to hear outside traffic and emergency vehicles.
- Avoid placing cell phones or wireless transceiver devices near the GPS antenna as their signals may weaken or interfere with the GPS satellite signal being received by your DVA6, causing it to perform poorly.
- **The DVA6 should not be programmed while driving. The driver can only program the unit while the vehicle is parked in a safe location.**
- **Moving pictures display on the DVA6 screen should not be watched or touched while the vehicle is in motion.**
- **Parking brake safety system should be installed correctly according to the instruction on the owner's manual. Otherwise, RYDEEN and its retailers are not responsible for any accident caused by improper installation or misuse of the DVA6 unit.**
- **SEVERE INJURY RISK -DO NOT** mount your DVA6 on the surface of, or in the deployment field of your vehicle's driver and passenger airbag units.
- Position the unit in a location that does not obstruct the driver's view of the road, instruments or vehicle controls.
- Position the unit so the screen can be viewed with just a quick glance. Glance at the unit screen or manipulate the in-route touch screen controls **ONLY WHEN VEHICLE IS COMPLETELY STOPPED AND IT IS SAFE** to do so.
- Be sure the DVA6 unit is securely attached to the vehicle's dash structure with the supplied bracket and screws.
- **DO NOT** attempt to modify or disassemble the DVA6 unit, personal injury or damage could result. If a problem occurs, stop using the system immediately and contact RYDEEN. Changes or modifications to the DVA6 will void the warranty and its compliance with FCC rules thus making it illegal to use.
- If you notice any of the following: (unidentified liquid on the unit; smoke rising out of the unit; unusual odor emanating from the unit) – **STOP USING THE UNIT IMMEDIATELY.** Contact the nearest RYDEEN retailer or call RYDEEN Customer Service for assistance Toll Free @ 1-877-777-8811 (within USA only).
- **DO NOT** mount your DVA6 on any non-automotive form of transportation (motorcycles, bikes, ATV's, watercraft).

WARNINGS

- Avoid dropping your DVA6 unit or subjecting it to excessive shock and vibrations as this may cause it to malfunction.
- DO NOT use any sharp object to operate your unit's touch-screen display. Excessive force could damage the LCD display.
- Keep the DVA6 unit out of reach of small children. Removable parts (microSD memory card) can be a choking hazard.
- The DVA6 unit IS NOT WATERPROOF. Avoid exposing it to rain or other forms of excessive moisture. Water damage is not covered under the warranty.

WARNINGS

- THE FOLLOWING INSTRUCTIONS ARE INTENDED FOR AUTHORIZED RYDEEN MOBILE INSTALLERS ONLY
- PROFESSIONAL INSTALLATION BY AUTHORIZED RYDEEN RETAILER REQUIRED TO BE COVERED UNDER WARRANTY

Technical Support Contact Info

If you have other questions about the RYDEEN DVA6, please contact your retailer or Technical Support:

- Telephone: **1-877-777-8811 (within USA only)**
- **techdept@rydeenmobile.com**
- Web Address: **www.rydeenmobile.com**

Precautions

Thank you for purchasing this product. Please read through the Owner's Manual to learn how to properly operate the DVA6 unit. After you have finished reading the manual, please keep it in a safe place for future reference.

Only connect the unit to a 12-volt power supply with proper negative grounding.

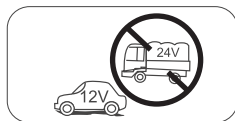

Never install this unit where the operation and condition for driving safely is compromised.

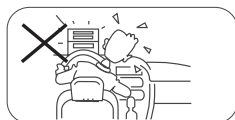

Never use the video display while the car is in motion. The use of video playback while driving is a violation of traffic laws and increases the risk of traffic accidents.



To ensure safe driving, please adjust the volume to a safe & comfortable level in case of emergency situations.

Never expose this unit, amplifier or speakers to moisture or water to prevent electronic sparks or fires.

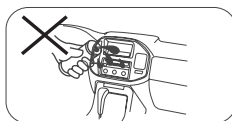

Please don't change the fuse on the power cord without professional guidance, using an improper fuse may cause damage to this unit or even cause fire.

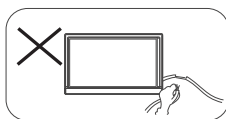

Please power off this unit at once and send it back to the after-sales service center or the dealer /distributor you purchased from if one of the following symptoms is found:

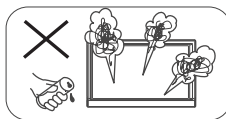

- No audio output;
- No image output;
- Water or other obstacle enters the unit;
- Smoking;
- Peculiar smell.

To provide a clear demonstration and an alternative for easy understanding of the operation of this unit, graphic illustration was used. However, this illustration is not necessary printed as the actual image found on the unit.

Precautions

Warning

Operate the unit correctly according to the instruction manual to prevent unnecessary problems.

CAUTIONS ON HANDLING

This product is a CLASS 1 LASER PRODUCT. Use of controls or adjustments or performance of procedures other than those specified herein may result in hazardous radiation exposure. Do not open covers and do not repair yourself. Refer servicing to qualified personnel.

Two laser products

Wave length: CD: 780nm DVD: 650nm
Laser power: No hazardous radiation is emitted with safety protection.
To reduce the risk of fire electric shock, and annoying interference, use only the included components.

Caution of disc using

1. **DO NOT use irregular shaped disc.**

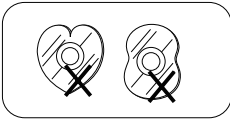

2. **Disc Cleaning.** Use a dry, soft cloth to wipe the disc from center to edge, only neutral detergent can be used.

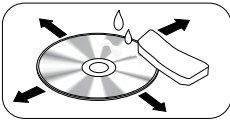

3. **When playing a new disc.** New disc may have some rough spots around the inner and outer edges. If such a disc is used, remove these rough spots with a pencil or ball-point pen, etc.

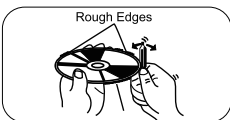

Contents

Welcome Statement & Warnings	2
Technical Support Contact Info	3
Precautions	4
Control Panel	6
Remote Control.....	7
Basic Operations.....	9
Turn On/Off the Power.....	9
Mute.....	9
Adjust the Volume.....	9
Playing Source Selection.....	9
When Vehicle is Put in Reverse	9
When Parking Brake Applied.....	9
Wallpaper.....	9
Main menu.....	10
Main Menu.....	10
Applications Menu	10
Disc Operation	10
Radio Operations.....	13
SD/USB Operations	14
Bluetooth Operations.....	17
Internet	19
3G APN Settings.....	19
Wi-Fi Settings	20
Create Wi-Fi Hotspot	20
Visit Website.....	21
E-mail.....	21
Other Mode.....	21
Navigation Operations	21
AUX Operations.....	21
Steering Wheel Control.....	21
i-Mode (Siri) Function	22
Google Calendar Configuration	22
Delete Gmail Account.....	23
System settings.....	24
Sound setting.....	25
Device Connections	26
Wiring Diagram.....	28
Troubleshooting	29
Specifications	30
One Year Limited Warranty	31
FCC Compliance Statement	32
Disclaimer	32

Control Panel

Press [] knob (5) to turn on the unit.

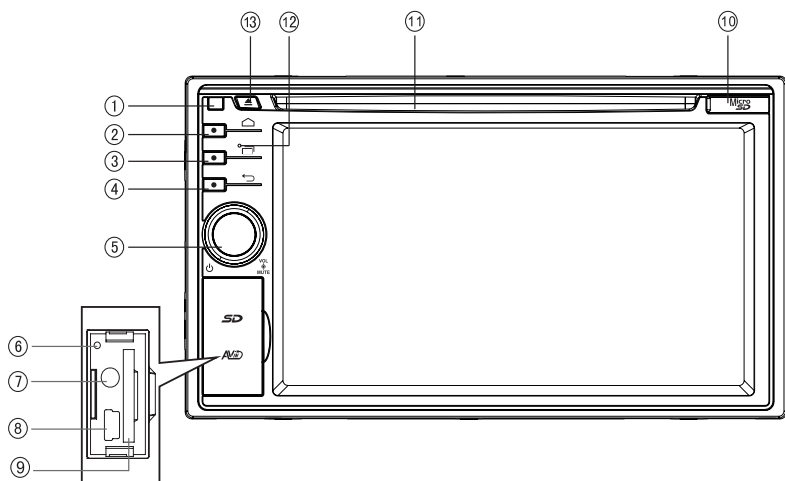

1. Remote Sensor

2. HOME Button

Show main menu

3. MENU Button

Show MENU options

4. BACK Button

Back to previous MENU.

5. VOL Knob

- > Power "ON" / "Standby Mode" (Press)
- > Adjust Volume (rotate)
- > Mute the Volume (press when on)
- > Power "OFF" (long press)

6. Reset

Load factory settings

7. AUX in Jack

8. Mini USB Connector

9. SD Card Slot

10. Micro SD Card Slot

11. Disc Slot

Insert the disc with label side facing up.

12. Microphone (Built in and External Microphone)

We recommend to use External Microphone for better Quality. Internal Mic. is just for urgent use, in case of External Mic. broken.

13. Eject

Eject disc (when disc inserted)

• Default Path:

1. Path of SD Card(®): /sdcard/sd_media
2. Path of USB(®): /sdcard/external_usb
3. Path of Micro SD Card(®): /sdcard/external_sd

To install a new map, please install the apk file first, then start the application and set the path.

Remote Control

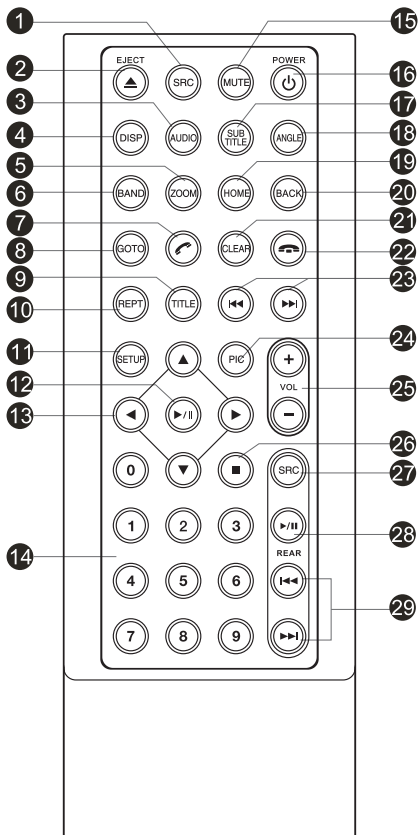

1. Change playing source in sequence
2. Eject the disc
3. Select audio language
Show music catalog
4. Display playback information
5. Zoom
6. Select radio band
7. Call out - Outgoing call
8. Go-to search
9. DVD title
10. Repeat playback
11. Setup menu
12. Play / Pause
13. Move the cursor up/down/left/right.
Up/down: Manual tuning
14. Numeric keys
15. Mute the volume
16. Unit power
17. Select DVD subtitle language
18. Select DVD angle
19. Show / exit home menu
20. Return to previous display
21. Clear information
22. Hang up
23. Previous/Next
Auto tuning (long press)
Fast backward/forward (long press)
24. Display settings
25. Adjust volume
26. Stop playback
- Rear zone (not used)
27. Change next rear source
28. Play/Pause
29. Previous/Next track
Fast backward/forward (long press)

Remote Control

Notes of remote control using

- 1) Aim the remote control at the remote sensor on the unit.
- 2) Remove the battery from the remote control or insert a battery insulator if the battery has not been used for a month or longer.
- 3) DO NOT store the remote control under direct sunlight or in high temperature environment, or it may not function properly.
- 4) The battery can work for 6 months under normal conditions. If the remote control doesn't work, change the battery.
- 5) Use "button shaped" lithium battery "CR2025"(3V) only.
- 6) DO NOT recharge, disassemble, heat or expose the battery to fire.
- 7) Insert the battery in proper direction according to the (+) and (-).
- 8) Store the battery out of children reach it can be hazardous if swallowed to avoid the risk of accident.

Uninstall Battery

Slide out the battery compartment tray at the bottom on the back of the remote control.

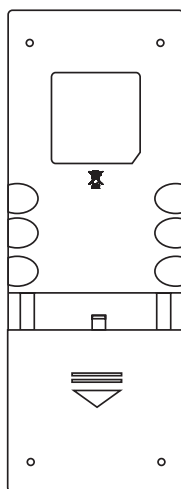

PULL OUT

Install Battery

Use button-shaped lithium battery CR2025 (3V) only. Insert the battery to the battery tray with proper direction according to the (+) and (-) poles.

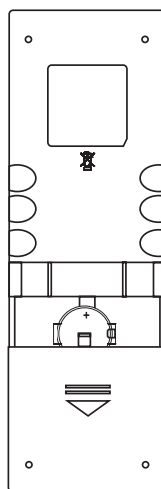

PUSH IN

Basic Operations

Turn On/Off the Power

1. Press the [VOL] knob to turn on the unit.
The unit will go back to the last source used prior to the radio being powered off.
2. When on, press the [VOL] knob to “Standby Mode” the unit.
3. When on, long press the [VOL] knob to turn off the unit.

Mute

Press the [VOL] knob to mute the sound.

-  **Note:**
- Pressing the [VOL] knob again or adjusting volume will unmute.

Adjust the Volume

Rotate the [VOL] knob to increase or decrease the volume level.
The adjustable range of volume is 0 to 50.

Playing Source Selection

1. Press the [] button on the panel to show main source menu.
2. Touch desired icon on the bottom of the screen to enter corresponding working mode, such as Disc, Navi, Radio, etc.
Drag left/right to scroll.

When Vehicle is Put in Reverse

If the rear view video camera is connected, the unit automatically switches to CAMERA source during reverse driving. The unit returns to the previous source after the vehicle has been taken out of reverse.

When Parking Brake Applied

1. If 'PRK SW' cable is connected to hand brake switch, the video display of the TFT monitor will be controlled by driving status, system setup and input video sources.
2. When the car is moving forward, and a video source is being played, the screen will display a warning disclaimer and a blank screen. The warning screen will prevent the driver from watching images.

Wallpaper

1. Long press the blank area of the main menu.

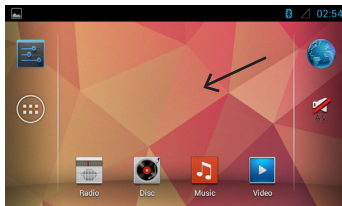

2. Select a source from:
[Gallery]: to visit the gallery of mobile storage.
[Live wallpapers]: to show the wallpapers with animation stored in the unit. Drag up/down to scroll.
[Wallpapers]: to show the wallpapers stored in the unit. Drag left/right to scroll.
3. Select desired picture to view, touch [Set wallpaper] or [OK] to confirm selection.

Main Menu

Press the [] button on the panel to enter main source menu.





1. Indicator of mobile storages.
2. Hold and drag down to show the notifications.
3. Wireless signal and time indicator.
4. Enter settings menu
5. Show applications list.
6. Access web browser.
7. AV Off
8. Car AV system source bar:
Touch and hold the center of the bar and drag left/right to show more icons.
Touch desired icon to enter corresponding mode.

Applications Menu

Touch [] to enter applications menu.

1. IN-CAR
Show the Car AV applications.
2. APPS
Show the Android applications installed.
3. WIDGETS
Show the widget applications.

In the list menu, drag left/right to scroll.
Touch and hold an icon for more than 2 seconds to add shortcut to the desktop. To delete the shortcut, hold it and drag to the [] on the bottom, and release after it turns red.
Touch the [] button on the panel to exit.

Insert a Disc

Insert a disc into the slot, and the unit will change to disc mode automatically.

Notes:

- Please confirm whether there is a disc in the unit before you insert another one.
- The unit will exit current playing source and enter DVD mode when one disc is inserted.
- The following disc formats are supported: CD-R, CD-RW, DVD-R, DVD+R, DVD-RW, DVD + RW .

Eject the Disc

Press [] on the panel to eject the disc.

Notes:

- After ejecting the disc, the unit reverts to another source automatically.
- If the disc is not removed from the unit within 10 seconds, the disc will be reloaded to prevent accidental damage.

Disc Playback

When a disc is inserted, the display will show "Loading...". For MP3/WMA or a disc with mixed files, reading time may exceed 1 minute.

DVD Playback Menu

During playback, touch the screen (except top left corner) to show control buttons.

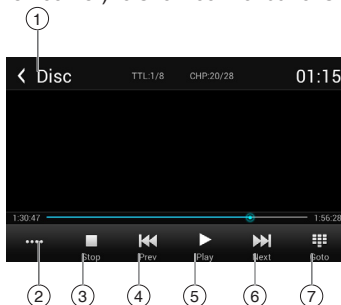

1. Return to home menu
2. Show more control buttons
3. Stop playback
4. Previous chapter
Fast backward (long press)
5. Play/Pause

Disc Operation

- Next chapter
Fast forward (long press)
- To enter search menu

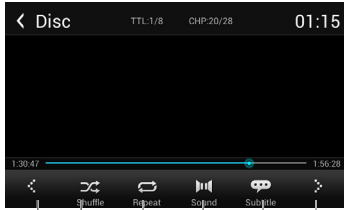

- Previous page of control buttons
- Random play
- Repeat play
- Select audio channel
- Select subtitle language
- Next page of control buttons

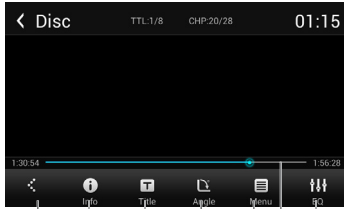

- Show DVD informations
- Show DVD title
- Select viewing angle
- Show DVD menu
- Progress bar
- Enter EQ menu

CD Playback

Insert a CD in the disc slot, and the unit will read the disc. For some discs, you will need to choose Music/Video/Photo for playback.

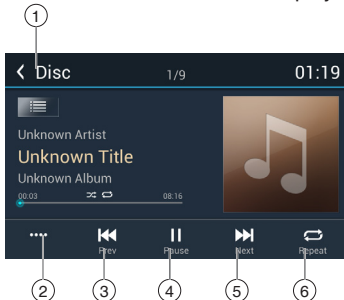

- Return to home menu
- Show more control buttons
- Previous track
Fast backward (long press)
- Play/Pause
- Next track
Fast forward (long press)
- Repeat play

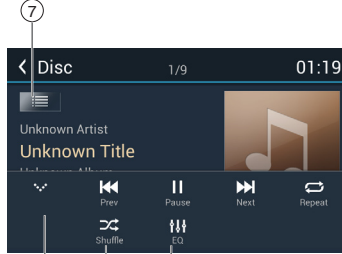

- Show file list
- Hide the second line of control buttons
- Shuffle play
- Enter EQ menu

Mixed Disc Playback

When inserting a mixed disc, the unit will read the disc and show the files list. For some discs, you need to choose Music/Video/Photo to play back.

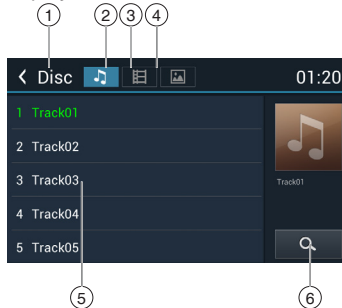

- Return to home menu
- Show music list
- Show video list
- Show photo list
- File/Folder list
Drag the list up/down to scroll.
Touch a file name to visit it.
- Enter search menu

Disc Operation

When viewing a picture, touch the screen (except top left corner) to show control buttons.

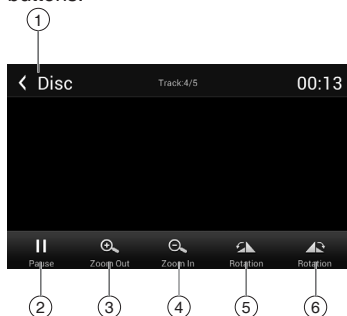

1. Return to home menu
2. Play/Pause
3. Zoom out
4. Zoom in
5. Rotate counterclockwise
6. Rotate clockwise

* Video/Audio playback reference DVD/CD playback.

Stop Playback Temporarily

1. During playback, press **II** to pause playback. The sound will be muted.
2. Press **▶** to continue playback.

Select Desired Track/Chapter

Press **◀** or **▶** to skip to the previous or next track/chapter.

Fast Forward/Backward During Playback

Press and hold **◀◀** or **▶▶** button to fast backward or forward during playback. During the fast forward or backward operation, the volume will be muted.

Repeat

During playback, press **↺** button on screen to select repeat playback.

- Default setting is off.

Note:

If you do not select Repeat on, when the entire disc or TITLE playback has finished, the system will stop. If no other control, after 5 minutes the unit will turn into standby mode.

Random Track Playback (for CD/VCD/MP3/WMA Only)

You can play all the tracks in random order.

1. During playback, press **[↻]** button on the screen to select random playback.
2. Press again to select normal playback.

Search

For DVD/VCD:

1. Touch [Go-to] on the control bar.
2. Input the chapter number.
3. Touch [OK] to confirm.

For Mixed disc:

1. Touch [🔍] icon.
2. Input the file name.
3. Touch [Done] to confirm.

DVD Audio Select

Press **[🔊]** button to select audio language to listen if the DVD has multiple audio languages.

VCD Audio Select

Press **[🔊]** button to select audio channel to listen (L, R, Stereo).

DVD Subtitle Select

Press **[🗨️]** button to select the subtitle language to show if the DVD has multiple language subtitles.

DVD Title Select

Touch **[T]** button to display title or chapter list, touch desired title to play.

Radio Operations

Select [Radio] on the main menu to enter radio mode.



1. Return to home menu
2. Preset stations list
3. Current frequency
4. Preset stations of current band
Touch 1~6 to listen to preset station.
5. Show more control buttons
6. Tune backward
Auto tune backward. (long press)
7. Search and store preset stations automatically
8. Tune forward
Auto tune forward. (long press)
9. Band switch

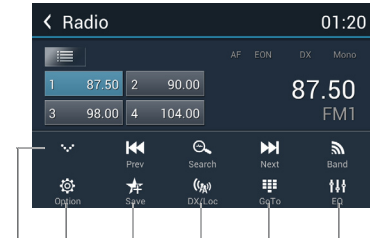



10. Hide the second line of control buttons
11. Show RDS options
12. Save stations manually
13. To receive local / distant radio stations
14. Goto station by inputting frequency
15. Enter EQ menu

Select One Radio Band



Touch the [] button to select one radio band among FM1, FM2, FM3, AM1 and AM2.

Manual Tuning

During manual tuning, the frequency will be changed in steps.

Touch the [] or [] button on the operation bar to tune in a lower/higher station.

Auto Tuning

Hold the [] or [] button on the operation bar for more than 2 seconds to seek a lower/higher station.

To stop searching, repeat the operation above or press other buttons having radio functions.

Note:

When a station is received, searching stops and the station is played.

Auto Store

Only stations with sufficient signal strength will be detected and stored in the memory.

To start automatic station search, touch the [] button on the operation bar.

To stop auto store, press other buttons having radio functions.

Note:

After auto store, the previous stored stations will be overwritten.

Manual Store

1. When one expected radio station has been detected, touch [] button on the operation bar to show the preset station store list.
2. Touch to select an item on the list to store the current station in the memory.
3. Touch top left of the screen to exit.

Radio Operations

Recall the Stored Stations

Method 1:

Touch the 1~6 on the left of screen to listen to the preset station of current band.

Method 2:

1. Touch [≡] button on the screen to show the preset stations list.
2. Select a band
3. Touch a station on the list to listen to.
4. Touch top left of the screen to exit.

Local Seeking

When LOCAL seeking is on, only radio stations with strong radio signal will be received.

To open LOCAL function, touch [●●●] button on the operation bar, then touch the [(L)] button to select "Loc" or "DX".

Note

The number of radio stations that can be received will decrease after the Loc seeking mode is on.

Key Search

Touch [≡] button on the operation bar to show key search menu.

Touch the keypad to input the frequency, touch [OK] to goto the station directly.

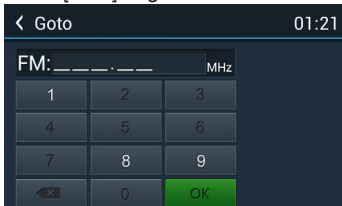

Touch [<x>] to clear all the digits.

SD/USB Operations

Using an SD Card

1. Open the card slot cap, insert an SD card into the corresponding slot, the unit will load the files automatically.
2. To remove the card, you should first select another source, in order to avoid damaging the card, press the card slightly, and take off the card after it pops out.

Using USB Device

1. Connect your USB device to the USB cable.
When connecting a USB device, the unit will read the files automatically.
2. To remove the USB device, you should first select another source, in order to avoid damaging the USB device.

Music Playback

Select [Music] on the applications menu, the unit will display all the music on the mobile storages.

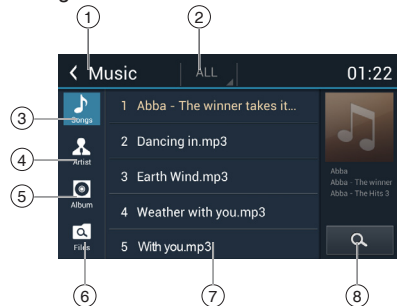

1. Return to home menu
2. Select file source
3. List the files by song name
Touch a song to start play.
4. List the files by artist
5. List the files by album
6. Show the folders
7. List window
Drag up/down to scroll.
Touch an item to select.
8. Enter search menu.

SD/USB Operations

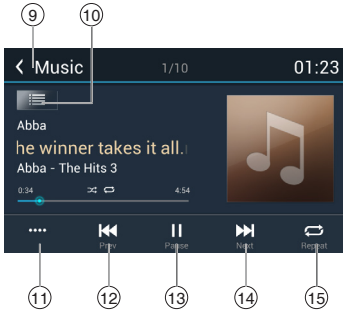

9. Return to home menu
10. Show list menu
11. Show more control buttons
12. Previous track
Fast backward (long press)
13. Play/Pause
14. Next track
Fast forward (long press)
15. Repeat play

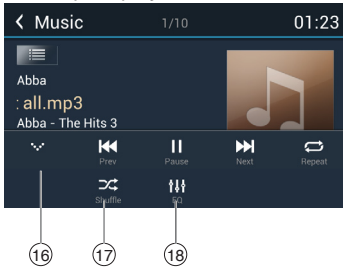

16. Hide the second line of control buttons.
17. Shuffle play
18. Enter EQ menu.

Play/Pause

When playing, press [**||**] button to pause, and the sound will be mute.
Press [**▶**] button to play.

Previous/Next Track

Press **⏮** or **⏭** button to go to previous or next track.

Fast Forwarding or Reversing

Press and hold **⏮** or **⏭** button to fast backward / forward.

Select Music by Artist

1. Touch [Artists] on the left of the screen.
2. Touch an artist shown on the list.
3. Select a song to play.

Select Music by Album

1. Touch [Albums] on the left of the screen.
2. Touch an album shown on the list.
3. Select a song to play.

Select Music by Song Name

1. Touch [Songs] on the left of the screen.
2. Select a song to play.

Video Playback

Select [Video] on the applications menu, the unit will display all the video files on the storages.

During playback, touch the screen(except top left corner) to show control buttons.

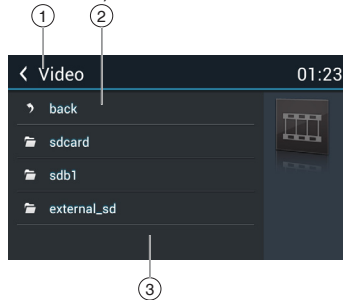

1. Return to home menu
2. Back
3. Folder/File list
Drag up/down to scroll, touch to access.

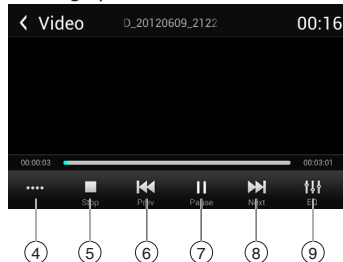

SD/USB Operations

4. Show more control buttons
5. Stop playback
6. Previous chapter
Fast backward (long press)
7. Play/Pause
8. Next chapter
Fast forward (long press)
9. Enter EQ menu

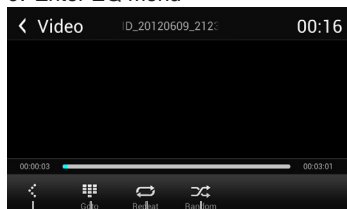

10. Show previous page of control buttons
11. Enter search menu
12. Repeat play
13. Random play

Notes

- *Disconnect USB storage devices from the unit when not in use.*
- *Use an optional cable to connect the USB audio player/USB memory as any device connected directly to the unit will protrude out from the unit and may be dangerous.*
- *Do not use unauthorized products.*

Using an Android mobile phone as a USB storage device

If you want to use your Android mobile phone as a USB storage device.

1. Connect your Android mobile phone to the unit with a USB cable.
2. Set USB connection type of your mobile phone to "Mount SD card".
 - * If you select "Charge only", it won't be recognized by the unit.
3. In the setting menu of the unit, select "Storage", then "Mount USB disk".

Gallery Operations

1. Select [Gallery] on the APPS menu.
2. Select one gallery to show the picture list.

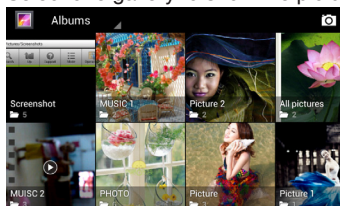

3. Touch to view it.



Drag left/right to scroll.

Touch the top right corner to delete the photo.

Touch top left corner to back.

Bluetooth Operations

The Bluetooth allows you to utilize your car's built-in audio system for handsfree wireless mobile phone or music communication. Some Bluetooth mobile phones have the audio features, and some portable audio players support Bluetooth feature. This system can play audio data stored in a Bluetooth audio device. The car stereo with Bluetooth will be able to retrieve phonebook contacts, received calls, dialed calls, missed calls, incoming calls, outgoing call and listen to music.

Notes:

- This system will not operate or may operate improperly with some Bluetooth audio players.
- The unit cannot guarantee the compatibility of all mobile phones together with the unit.
- Audio playback will be set to the same volume level as set during telephone call. This can cause problems, if extreme volume level is set during the telephone call.

Touch [BT Phone] on the main menu to enter Bluetooth Phone mode.

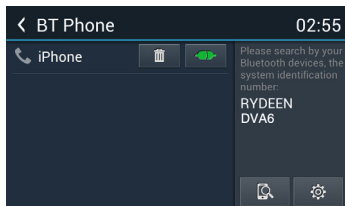

1. If the Bluetooth function of the unit is off, the unit will ask you to turn it on. (Default setting is on)
2. Turn on Bluetooth function of your mobile phone.
3. Search for new Bluetooth devices on your phone. Select the model name from the pairing list on the mobile phone, and enter password (Default password: 0000) Or touch [🔍] button on the screen to search mobile Bluetooth devices.

After connect successfully, the unit show following menu.

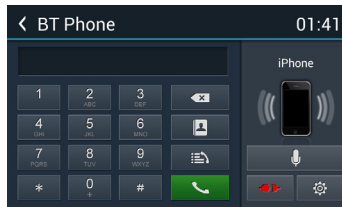

Making a Call

• Dial Number

1. Input numbers by digit-keys on the screen. Touch [X] to clear the digits.
2. Touch [📞] button to dial out.
3. Touch [📞] button to terminate call.

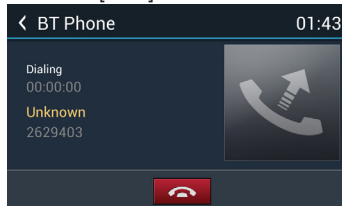

• Answering a call

You can answer an incoming call by pressing the [📞] button.

Touch [📞] button to reject an incoming call.

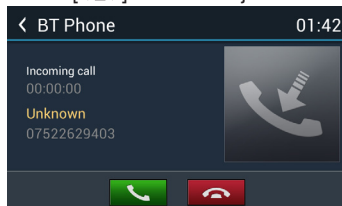

• Disconnect

To disconnect a paired device, touch [Disconnect] button.

Call from Phonebook

1. Touch [👤] button to show your phone book.
2. Select a number to select and touch [📞] button to dial out.
3. Touch [🔍] to search a contact name.

Bluetooth Operations

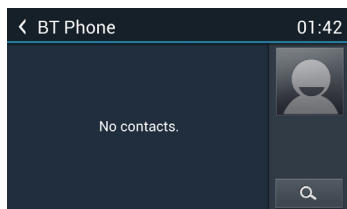

Call History

Access Call History by touching [] button.

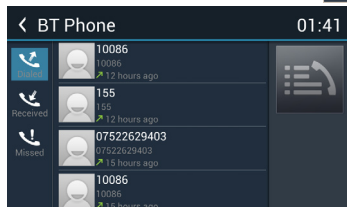

Then select a number from Dialed/Missed/Received calls.

Bluetooth Audio Streaming

What is audio streaming?

Audio streaming is a technique for transferring audio data such that it can be processed as a steady and continuous stream. Users can stream music from their external audio player to their car stereo wirelessly and listen to the tracks through the car's speakers. Please consult your nearest dealer for more information on the product of wireless audio streaming transmitter offered.

CAUTION

Please avoid operating your connected mobile phone while audio streaming as this may cause noise or the sound to cut in and out on playback.

Audio streaming may or may not resume after telephone interrupt as this is dependent on your mobile phone.

Touch [BT Music] button to play music on your mobile phone.

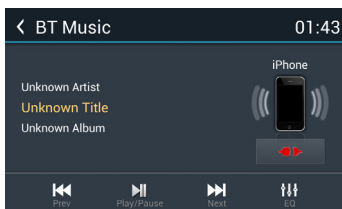

: Previous track

: Play/Pause

: Next track

Bluetooth Settings

Touch [] button to show Bluetooth setting menu.

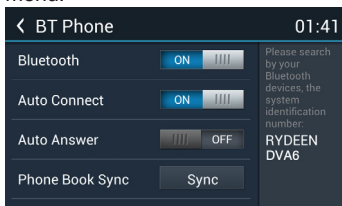

3G APN Settings

Note:

Contact the manufacturer for latest compatible 3G devices.

User set the APN to access the internet.

1. Insert the 3G dongle.
2. Select [] on the main menu to enter the setting interface.
3. Click the [Wireless & networks] to enter the Wireless & network settings and click [more...].

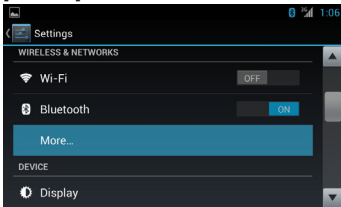

4. Click [Mobile network] to enter the Mobile network settings.

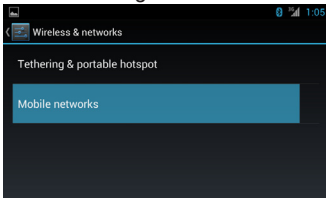

5. Click the [Access Point Names].

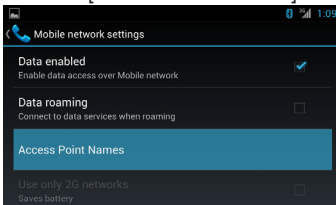

6. Press the [] button on the front panel, then click the [New APN].

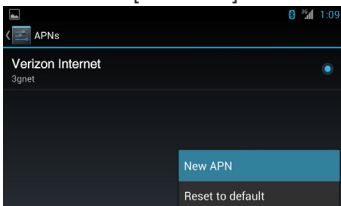

7. Must setup following options: Name, APN, MCC, MNC.

Touch the dialogue box to show keypad, and input your desired name.

APN according to the operator to determine.

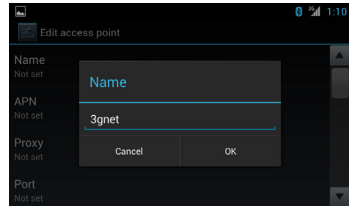

The unit will detect your 3G module to determine the MCC and MNC.

8. Then press the [] button and click the "Save" button.

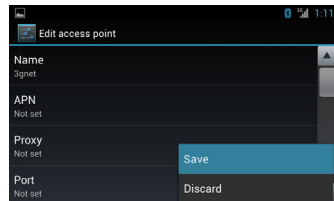

9. Select the APN, 3G icon appears on the top right corner of the taskbar.

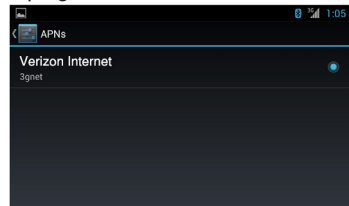

Wi-Fi Settings

This unit generally supports the following:
realtek 8188cu, 8188eu.

1. Connect the Wi-Fi dongle to the unit.
Touch the [] icon on the main menu to enter setting menu, and turn on Wi-Fi (if necessary).

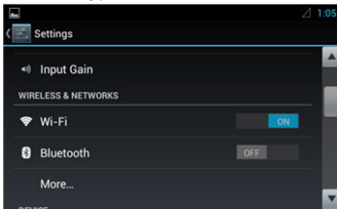

2. Touch [] to enter WiFi setting menu.

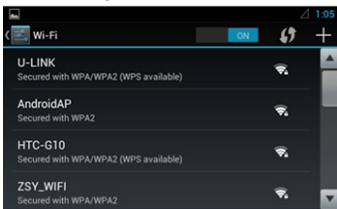

3. Touch an available WiFi hotspot.



4. Touch [] and input the password, touch [Connect] to confirm.

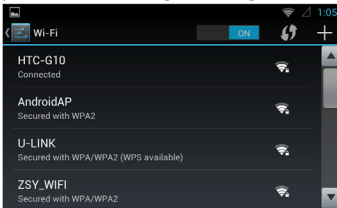

5. After successfully connected, the [] icon appears on the top right corner of the screen. Now you can access internet.

Create Wi-Fi Hotspot

User can use the unit to create a personal Wi-Fi hotspot. All your other Wi-Fi enabled devices will then be able to connect to this hotspot and share the primary internet connection.

1. Connect the Wifi and 3G dongle to the USB slots on the rear of the unit.
Refer to “Device Connections”.
2. Touch the [] icon on the main menu, and drag down to “WIRELESS & NETWORKS”.

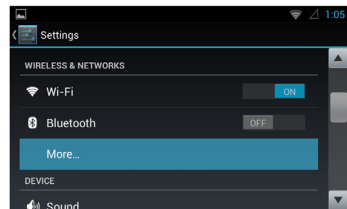

3. Select “More...”.

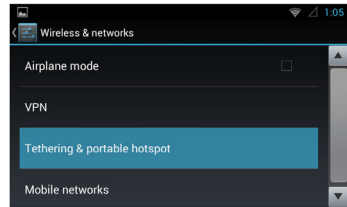

4. Touch “Tethering & portable hotspot”.



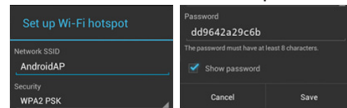

5. Touch “Portable Wi-Fi hotspot”.



After setting done, you can touch “Set up Wi-Fi hotspot” to modify the settings.

If your device can't connect to the Wi-Fi hotspot:

1. Check the Wi-Fi network.
The  icon will appear on the top left of the screen after setting successfully. If not, check your Wi-Fi dongle connection and the Hotspot settings.
2. Check the 3G network.
If the signal indicator  on the top taskbar turns grey, the network is unavailable, check your 3G dongle connection and 3G settings.
3. Be sure to input the correct password.
4. There may be too many devices connected to the hotspot.

Visit Website

To access the internet, you must setup "wireless & network" in system settings menu.

Select [] on the main menu to view a website.

Touch the dialog box on the upper side of the screen to show keypad. Input the website address, and touch [Go] to visit it. Drag the web page to scroll.

E-mail

Select [Email] or other mail software on the applications menu.

First you must setup an account, or sign into an existing account. Enter your Email address and password. Then you can send/receive E-mails through the unit.

Navigation Operations

To navigate by the unit, simply select the desired navigation application on the main menu. Then navigate by the touch screen.

AUX Operations

Select [Aux In 1] on the main menu to visit front auxiliary device, and select [AUX IN 2] to enter rear auxiliary device.

Steering Wheel Control

Select [SWC] on the main menu to enter SWC setting menu.

1. Touch number button to select a SWC button.



2. Select a function.
3. Press each individual steering wheel control button for each corresponding function.
4. Touch [Study] to program.
5. Once the final steering wheel control button is programmed, the functions are saved and the programming will end.
6. Touch [Reset] to reset the programming.



i-Mode (Siri) Function

1. Turn on the bluetooth function of both the unit and smartphone.
Make sure the smartphone has internet access (iPhone 4S, iPhone 5, iPhone 5S, iPad, Samsung Galaxy, etc.).
2. Turn on the 'Siri' application of iPhone/iPad or 'Talk Assistant' application of Android phones.
3. Pair your phone to the unit through the Bluetooth module.
4. Touch [] to select i-Mode on.
5. When speaking through the external microphone of the unit, voice signals will be transferred to the phone.

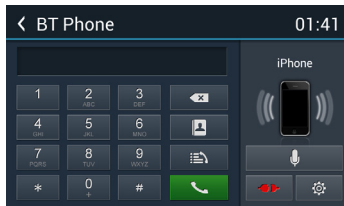
The phone will process the data and search the relative information on local memory or the internet, then transfer the result back to the unit.



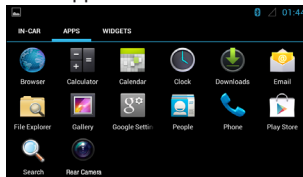

Google Calendar Configuration

1. Ensure the network is available, refer to the <Internet>.
2. Touch [] icon on the main menu, select [Date & time] in the settings menu, then set the correct local time.
3. Touch [] icon on the main menu to enter applications menu and select "APPS".

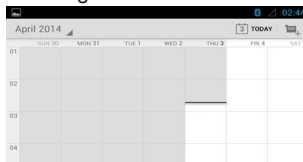

Select the Calendar icon to show the following menu.



Touch the  icon on the top right corner, the unit will pop up the following menu when you use the Calendar for the first time.

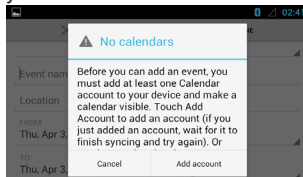

Touch "Add account".

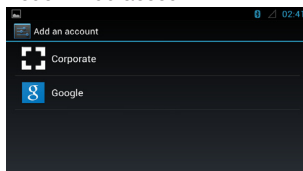

Select "Google".

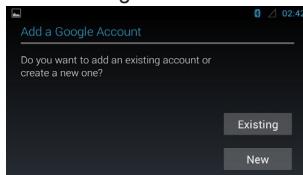

Other Mode

If you want to establish a new account, please touch [New].

If you want to use an existing account, please touch [Existing].

After select "Existing", input your mail account and password. Then touch [▶].

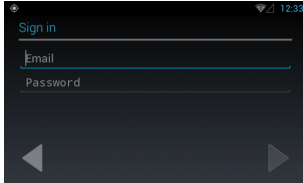

Touch [OK] button to confirm

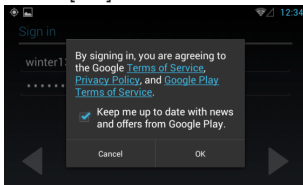

Touch [▶] to finish setting.

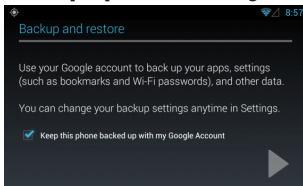

4. Select Calendar in APPS menu to show the calendar and the arrangements. You can select a date to view the details.

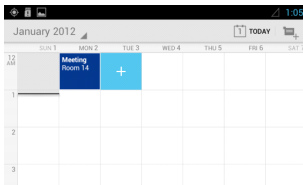

To add a new event, touch the  icon on the top right corner, or touch [+] icon on the blank area.

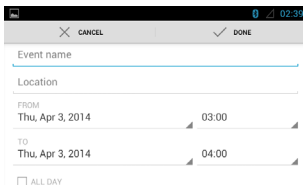

Delete Gmail Account

1. Touch [] icon on the main menu to enter settings menu, slide down the screen to find "Google".

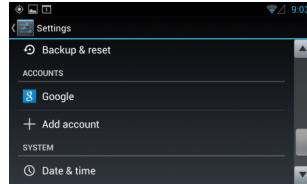

2. Touch [Google], if you logged on a google account before, the address appears.

Select the mail address to show the details. Press the [] button on the front panel to pop up the sub-menu.

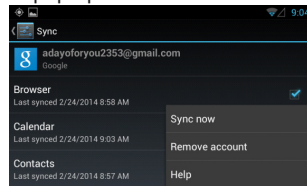

Select "Remove account" to delete this account.

System settings

Select [] on the main menu to enter settings mode.

Drag up/down to scroll the options.

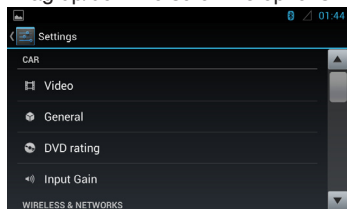

CAR

Video

Video input option: Choose video input mode

Rear camera option: Choose rear camera display mode.

General

Lighting: Choose button backlight.

Radio region: Choose radio region.

Radio range: Choose radio Frequency: local or distance.

Blackout: Choose screen blackout off, 10s or 20s.

Beep: Turn on or off button beep sound.

Calibration: To calibrate the screen.

DVD rating

DVD audio: Choose DVD audio language.

DVD subtitle: Choose DVD subtitle language.

Disc menu: Choose DVD menu language.

Set password: To set password for rating.

Input 4-digit password, touch [✓] to confirm, touch [DEL] to delete a number inputted. Touch [X] to exit.

Rating level: To setup the rating level.

Kid safe, G, PG, PG-13, PG-R, R, NC-17, Adult.

Input Gain

Choose input volume gain of each source.

WIRELESS & NETWORKS

To setup the wireless configuration, such as Wi-Fi, VPN, 3G network.

* For 3G APN settings, refer to “Internet”.

DEVICE

To setup the Sound, Display, and Storage, Applications management.

PERSONAL

To Setup Location services, Security and Language & keyboard, etc.

ACCOUNTS

Accounts management.

SYSTEM

To setup Date, time and Accessibility, etc.

Sound setting

Select [EQ] on the menu to enter sound setting mode.

Touch to select a preset EQ on upper side of the screen from Flat, Pop, User, Techno, Rock, Classic and Jazz.

Touch [◀] or [▶] to adjust the level, Center Frequency and Q for Bass/Mid/Treb.



Touch [Speaker icon] to enter Fader/Balance/Subwoofer setting menu.

Touch [◀] or [▶] to setup Balance, touch [▲] or [▼] to setup Fader.

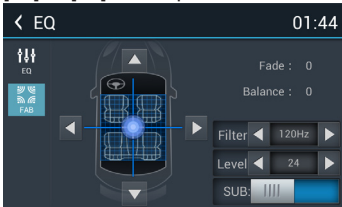

Sub Woofer

Sub woofer: Turn on/off the sub woofer playback.

Sub woofer filter: Touch [◀] or [▶] to select subwoofer Filter.

Sub woofer Level: Touch [◀] or [▶] to adjust subwoofer Level.

Notes of connection

- This unit is designed to be used in a vehicle with a 12-volt battery and negative grounding. Before installing this unit to a recreational vehicle, a bus, or a truck, make sure the battery voltage is appropriate for this unit to be used, otherwise, have a professionally installed transformer to convert the output voltage to 12V.
- To avoid short circuit in the electrical system, ensure that the negative battery cable is disconnected before installation.
- To prevent short circuit in the wiring and damaging to this unit, secure all wirings with cable clamp or adhesive tape. Route the wirings in a secured, out of heating place without touching any moving parts such as gear shift, handbrake, and seat rails to prevent the wiring insulation being melted / worn off.
- Never pass the yellow power cord through the installation hole into the engine compartment and connect to the car battery. Otherwise, a high possibility of serious short circuit to the electrical system may occur.
- If you need to replace the fuse, please replace with a 15A fuse. Using no fuse or a fuse with an improper rating may cause damage to the unit or a potential fire. If a proper fuse is installed and problems continue to occur, please contact your local retailer or installer.
- DO NOT connect other equipments with the car battery to avoid battery overheating.
- Please make sure all the wiring connections & the cables of the speakers are well-insulated. Otherwise, this unit may be damaged by short circuit.
- If there is no ACC available, please connect ACC lead to the power supply with a switch.
- If an external power amplifier is connected, please don't connect P.CONT lead to the power lead of the external power amplifier, otherwise, electric spark or other damage may result.
- Never ground the speaker output to prevent the damage to the built-in power amplifier.

Device Connections

Parking Brake Cable Connections

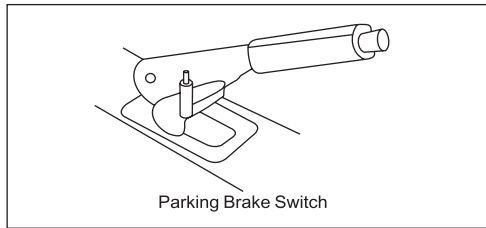
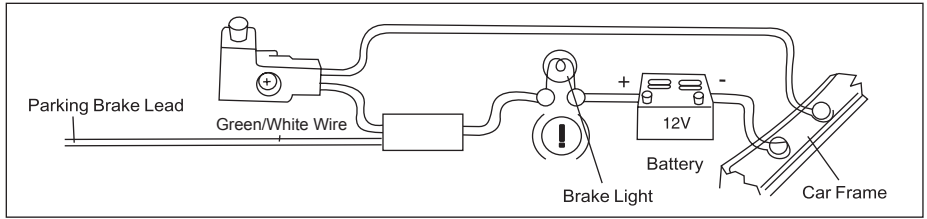

Back Up Camera Connections

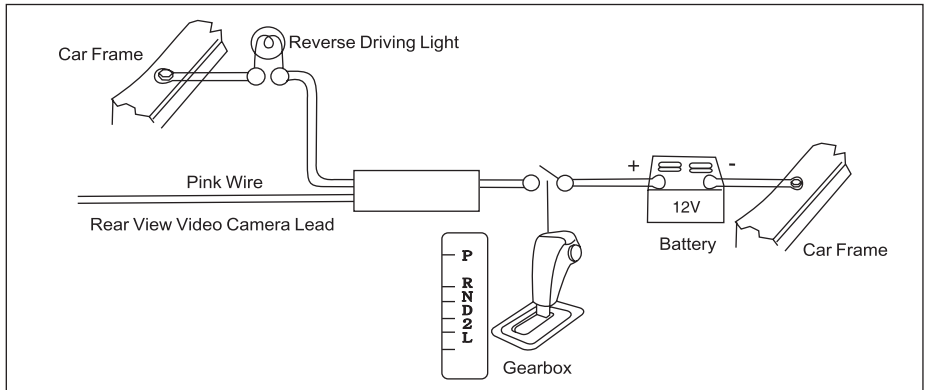

Device Connections

Wiring Diagram

English

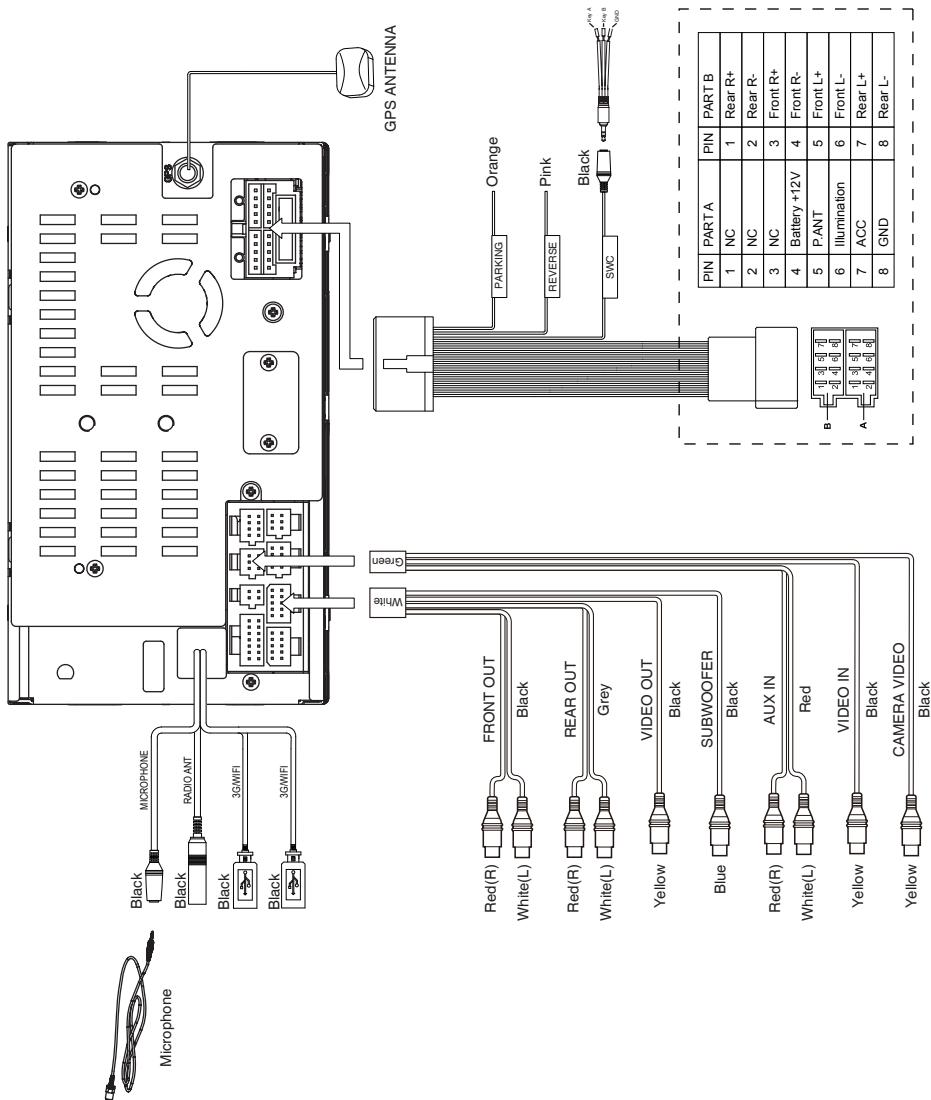

Troubleshooting

The following checklist can help you solve the problems which you may encounter when using the unit. Before consulting it, check the connections and follow the instructions in the user manual.

Problem	Possible cause	Solution
General		
The unit will not switch on.	Car ignition is not on. Cable is not properly connected. Fuse is burnt.	Turn your car key in the ignition. Check cable connection. Replace fuse with a new fuse of the same capacity.
No sound	Volume is set at minimum or the mute function is on.	Check the volume or switch the mute function off.
The unit or screen does not function normally.	The unit system is unstable.	Press the RESET button.
DVD mode		
The appliance will not play discs.	The disc is inserted incorrectly. The disc is dirty or damaged.	Disc must be inserted with the label side facing up. Clean the disc and check for damage. Try another disc.
Sound skips due to vibration.	Mounting angle is over 30°. Mounting is unstable.	Adjust mounting angle to less than 30°. Mount the unit securely with the supplied parts.
TUNER mode		
Unable to receive stations.	The antenna is not connected properly.	Connect the antenna properly.
Poor quality reception of radio station.	The antenna is not fully extended or it is broken.	Fully extend the antenna and if broken, replace it with a new one.
Preset stations are lost.	The battery cable is not properly connected.	Connect the permanent live on the unit to the permanent live on the vehicle.
USB/SD mode		
Unable to insert USB device or SD card.	The memory card or USB device has been inserted the wrong way round.	Insert SD card / USB the other way around.
The USB device or SD card cannot be read.	NTFS format is not supported.	Check that the USB disk file system is in FAT or FAT32 format. Due to different formats, some models of USB storage devices or MP3 players may not be read.
Remote control		
The remote control is not working or does not work properly	The battery is low or empty.	Change the batteries.

Specifications

General

Reference Supply Voltage.....	12V(DC)
Operating Voltage Range.....	10.5 - 15.8V(DC)
Max Operating Current.....	15A
Grounding System.....	Car Battery Negative Pole
Dimensions(WXHXD).....	178X101.5X159mm
Weight(main unit).....	1.9kg

FM

Signal Noise Ratio.....	≥ 55dB
Usable Sensitivity(S/N=30dB).....	≤ 15dBμV
Frequency Response(-3dB).....	20Hz~7KHz
Station Seeking Level.....	20~28dBμV
Distortion.....	≤ 1.0%
Stereo Separation(1KHz).....	≥ 25dB
Antenna Impedance.....	75Ω

AM

Usable Sensitivity(S/N=20dB).....	≤ 30dBμV
Frequency Response(-3dB).....	50Hz~2KHz

LCD

Screen size.....	6.2 inches(16:9)
Display resolution.....	800X480dots
Contrast ratio.....	400
Brightness.....	400cd/m ²

DVD Player

Signal / Noise Ratio.....	≥ 70dB
Dynamic Range.....	≥ 70dB
Distortion(line out).....	≤ 0.8%
Frequency Response(±3dB).....	20Hz~20KHz
Maximum Output Power.....	4x45W
Load Impedance.....	4Ω

AUX IN

Distortion.....	≤ 0.8%
Frequency Response(±3dB).....	20Hz~20KHz
Audio Input Level.....	500mV

Audio

Audio Output Impedance.....	10KΩ
Audio Output Level.....	2Vrms(Max)

Video

Normal Video Input Level(CVBS).....	1.0±0.2V
Video Input Impedance.....	75Ω
Video Output Impedance.....	75Ω
Video Output Level.....	1.0±0.2V

Environment

Operating Temperature.....	-10°C ~ +60°C
Storing Temperature.....	-20°C ~ +70°C
Operating Humidity.....	45%~80%RH
Storing Humidity.....	30%~90%RH

Notice:

When the unit is operated in extreme conditions, such as operated with maximum power output for a long time, or the temperature is over 70°C, it will enter heat protection mode, the volume will automatically be lowered. This is normal.

One Year Limited Warranty

Rydeen North America Inc. (a manufacturer of “Rydeen” products) warrants this product (DVA6) only to the original purchaser as described following:

Warranty Period

Rydeen warrants this product for a period of one (1) year from the original purchase date with proof of purchase.

Warranty Coverage

This warranty covers all defects in material and workmanship except as specified below.

1. Installation by anyone other than an authorized Rydeen Mobile Retailer voids the warranty.
2. Any products distributed outside of the USA by Rydeen North America Inc. (Rydeen) or which is not purchased in the USA or Canada unless the product is purchased through the USA Military Exchange Service.
3. Any product(s) which are purchased from an unauthorized retailer (in store or online).
4. Any products in which the serial number label or the model number label are removed, torn, modified or replicated.
5. Any damage defects or malfunctions resulting from any of following:
 - a) When defect occurs during shipment of product (freight carrier’s responsibility).
 - b) Installation or removal of product.
 - c) Accidents, act of nature, misuse, abuse, neglect, unauthorized product modification or failure to follow product owner’s manual instructions.
 - d) Any repair or attempt to repair without RYDEEN authorization.
 - e) Any other cause which is not related to product defect.
 - f) Any cosmetic damages due to normal wear and tear.
 - g) Any consumable items (such as fuse or batteries).

If any problems develop with your Rydeen products during or after the Limited Warranty Period, or if you have any questions regarding the operation or installation of the product, you should contact your Rydeen retailer. If the problem or your question is not handled to your satisfaction, please contact Rydeen Customer Service Department at 1-877-777-8811 (within the USA only) Monday - Friday between 9:00 AM to 4:00 PM Pacific Standard Time or visit www.rydeenmobile.com.

If warranty service is required for your Rydeen product:

1. Please call Rydeen Customer Service Department and obtain a Return Authorization Number (“RA”) Number.
2. Please pay for any shipping charge to Rydeen Customer Service Department. Rydeen will pay the return shipping charge, if the repair or service was performed during the warranty period. Rydeen will ship freight collect (recipient is responsible for shipping charge) if Rydeen determine; the service was performed outside of warranty period or exclusions described above warranty coverage. Rydeen will not accept warranty service requests from outside of the U.S.A. even if product was purchased in the USA.
3. Please include a copy of your original purchase receipt including Rydeen product model number, purchase date, retailer name/address and a RA Number whenever your product is sent for warranty service.
4. Rydeen will pay for all labor and material expenses for covered product during warranty period.
5. Shipping address for Rydeen Customer Service Department is following:

Rydeen North America Inc. (a manufacturer of Rydeen products), 2701 Plaza Del Amo, Unit 705, Torrance, California 90503, USA

FCC Statement

This device complies with Part 15 of the FCC Rules. Operation is subject to the following two conditions:

- (1) This device may not cause harmful interference, and
- (2) This device must accept any interference received, including interference that may cause undesired operation.

Changes or modifications not expressly approved by the party responsible for compliance could void the user's authority to operate the equipment.

NOTE: This equipment has been tested and found to comply with the limits for a Class B digital device, pursuant to Part 15 of the FCC Rules. These limits are designed to provide reasonable protection against harmful interference in a residential installation.

This equipment generates uses and can radiate radio frequency energy and, if not installed and used in accordance with the instructions, may cause harmful interference to radio communications. However, there is no guarantee that interference will not occur in a particular installation. If this equipment does cause harmful interference to radio or television reception, which can be determined by turning the equipment off and on, the user is encouraged to try to correct the interference by one or more of the following measures:

Reorient or relocate the receiving antenna.

Increase the separation between the equipment and receiver.

Connect the equipment into an outlet on a circuit different from that to which the receiver is connected.

Consult the dealer or an experienced radio/TV technician for help.

FCC Radiation Exposure Statement

This equipment complies with FCC radiation exposure limits set forth for an uncontrolled environment. This equipment should be installed and operated with minimum distance 20cm between the radiator & your body.

Disclaimer

The information in this user manual is for general guidance. Images in the manual may not represent the exact images that are displayed in the operating system software. Some features described in the manual may not be available or the features described may be limited, depending on the updated software or any other reasons.

RYDEEN[®]
find your road

rydeenmobile.com

Rydeen North America Inc.
dba Rydeen Mobile Electronics
2701 Plaza Del Amo, Unit 705, Torrance, California 90503 USA
Phone: 1-877-777-8811 Fax: 1-310-943-3778

Copyright © 2013 Rydeen North America Inc. All Rights Reserved.
RYDEEN® is a registered trademark of Rydeen North America Inc.

These materials are protected by copyright law and international treaties. Any unauthorized use, reproduction or distribution of these materials, or any portion herein, will result in severe civil and criminal penalties and fines. Violators will be prosecuted to the fullest extent of the law.

P/N: 127075006163