

ADAYO

DV7B01

**DVD/CD/VCD/MP3/WMA/USB PLAYER
BLUETOOTH WITH FM/AM TUNER**

Operation Instructions

Warnings

1. Only connect this unit to a 12V DC power supply with negative grounding.

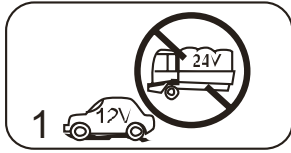

2. Never install this unit where the operation for safety driving is restrained.



3. Never use the video display function in the front when driving to prevent the violation of laws & regulations and also to reduce the risk of traffic accident except using the rear view video camera.



4. Never expose this unit, amplifier, speakers to moisture or water to prevent electronic sparks or fires.



5. Please don't change the fuse in the power cord without professional guidance, improper fuse may cause damage to this using unit or even cause fire.

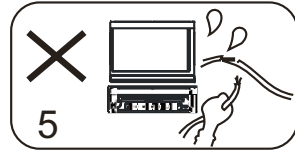

6. Please power off this unit at once and send it back to the after-sales service center or the dealer / distributor you purchased from if one of the following symptoms is found:

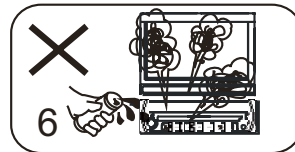

- (a) No audio output;
- (b) No image output;
- (c) Water or other obstacle enters the unit;
- (d) Smoking;
- (e) Peculiar smell.

7. To ensure safe driving, please adjust the volume to a safe and comfort level in case of emergency situations.

Precautions

1. Never disassemble or adjust the unit without any professional guide. For details, please consult any professional car shop / dealer for inquiry.
2. If the front panel or TFT monitor is squalid, please use a clean silicone cloth and neutral detergent to wipe off the spot. Using a rough cloth and non-neutral detergent such as alcohol for cleaning may result in scratching or decoloration to the applicant.
3. If any abnormal behavior of the unit is found, please refer to trouble shooting guide of this manual. If no relevant information is found, please press the [RESET] key on the front panel to resume factory default.
4. If you have parked the car in hot or cold weather for a long time, please wait until the temperature in the car becomes normal before operating the unit.
5. Using in-car heater in low temperature environment may result in beads coagulate inside the unit, Do not use the unit in this situation, eject the disc and wipe off the bead on the disc. If the unit still doesn't work after a few hours, please contact with after-sales service center.
6. No fierce impact to the LCD monitor when it is in open position for preventing the damage to any mechanisms inside.
7. To prevent the damage to the screen, avoid touching it with sharp objects.
8. The monitor employs auto motorizing mechanism, please don't push, pull, or swivel the monitor manually to prevent damage to the core mechanism.
9. To provide a clear demonstration and an alternative for easy understanding to the operation of this unit, graphic illustrations are used. However, these illustrations are some different from the actual images displayed on the screen.

10. During operating the unit, “” will display if the current operation is not available or illegal.

11. Operate the unit correctly according to this manual to prevent unnecessary problem. The guarantee won't be valid if the problem is caused by inappropriate operation.

Declaration

This product incorporates copyright protection technology that is protected by U.S patents and other intellectual property rights. Use of this copyright protection technology must be authorized by Macrovision, and is intended for home and other limited viewing uses only unless otherwise authorized by Macrovision.

Reverse engineering or disassembly is prohibited.

Cautions of disc using

1. **DO NOT use irregular shaped disc**

2. **Disc Cleaning**

Use a dry, soft cloth to wipe the disc from center to edge, only neutral detergent can be used.

3. **When playing a new disc**

New disc may have some rough spots around the inner and outer edges. If such a disc is used, remove these rough spots with a pencil or ball-point pen, etc.

Contents

Before using	
Front panel	1
Remote Control	2
Basic operations	
Power on / off	4
Audible beep confirmation	4
Mute	4
Open SOURCE MENU	4
Playing source selection	4
Volume adjustment	4
Using the TFT Monitor	4
System reset	4
Change aspect ratio	4
Image settings	4
Radio mode	
Select radio as playing source	5
Select one radio band	5
Tune	5
Manual tuning	5
Preset station	5
Search Stations Automatically	5
EQ Selection	5
Playback	
Insert a disc	6
Eject the disc	6
Touch screen controls	6
Controlling Playback	6
Connect an USB Device	6
Play	6
Pause	6
Stop	6
Previous/Next	6
Search for a Folder	6
Repeat playback	7
Repeat A-B	7
Shuffle (Random) Play	7
PBC function	7
Select Audio Mode	7
Select Subtitle Language	7
Change Viewing Angle	7
Playback Information	8
For DVD	8
For VCD	8
Elapsed Time	8
Direct Track Entry	8
Rotate Pictures	8
Zoom	8
Other modes	
Listen to Other Devices	9
Camera	9
Steering Wheel Control Programming	9
Setup	
Display System	10
Adjust General Settings	10
Adjust Video Settings	10
Adjust Time Settings	11
Adjust Audio settings	11
Adjust Language Settings	11
Adjust DVD Rating	12
Adjust Volume Settings	12
EQ	
Select Preset Equalizer	13
Adjust EQ Parameters	13
Adjust FAD BAL	13
Troubleshooting	13
Device connections	
Notes of connection	16
Control Cables	16
Region Code	16
Parking Brake Cable Connections	17
Reverse Driving Cable Connections	17
Installation and uninstall	
Notes of installation	18
Installation procedures	18
Remove the unit	18
Trim ring installation	18
Trim ring uninstall	18
Specifications	19
Appendix	
FCC Statement	20
FCC Radiation Exposure Statement	20
Wiring Diagram	21

Before using

Front panel

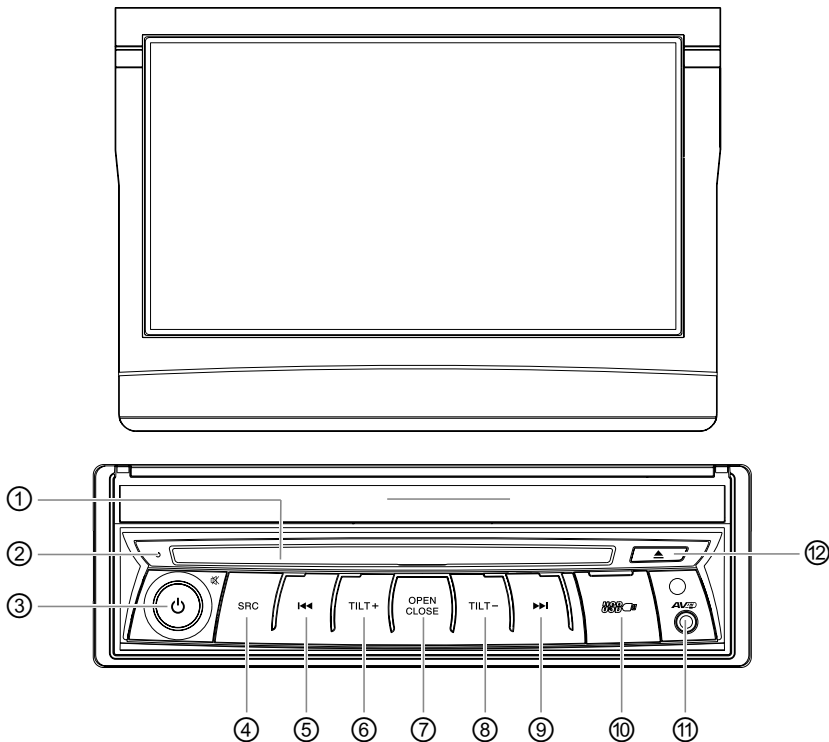

1. Disc slot
2. Reset the unit
3. [VOL / P / M] Knob: Unit power / Adjust volume / Mute audio outputs
4. [SRC] Key: Switch to the current source and the main menu
5. [$\text{I} \ll$] Key: Auto search / Next / Move cursor to the right
6. [TILT+] Knob: Increase the display angle
7. [OPEN/CLOSE] Key: Open / Close the TFT monitor
8. [TILT-] Knob: Decrease the display angle
9. [$\text{I} \gg$] Key: Auto search / Previous / Move cursor to the left
10. USB Slot
11. AV IN jack
12. Eject disc

Before using

Remote Control

1. [SRC]Key:select playing source
2. [EJECT]Key: Eject disc
3. [AUDIO] Key: Select audio channel
4. [VOL+/-] Key: Adjust volume
5. [ZOOM] Key: Image zoom in/out
6. [▶/BAND] Key: Select radio band / Fast playback / Slow playback
7. [WIDE] Key: Change display mode
8. [PRESET ▲ / ▼] Key: Select preset radio station
9. [EQ] Key: Enter/Exit the EQ setting
- 10.[GOTO] Key: GOTO search
- 11.[OPEN/CLOSE] Key: Open / Close the TFT monitor
- 12.[TILT ^ / v] Key: Adjusting display tilting angle
- 13.[RPT A-B] Key: A-B repeat
- 14.[RPT] Key: Repeat playback
- 15.[MUTE] Key: Mute audio outputs
- 16.[POWER] Key: Unit power
- 17.[SUBTITLE] Key: Select DVD subtitle language
- 18.[ANGLE] Key: Select view angle
- 19.[MENU] Key: DVD MENU / PBC
- 20.[TITLE] Key: DVD TITLE
- 21.[SETUP] Key: Setup menu
- 22.[▶▶] Key: Fast Forward / Move cursor up
- 23.[▶▶] Key: Auto search / Next / Move cursor to the right
- 24.[▶||] Key: Play / Pause / Enter
- 25.[◀◀] Key:Auto search / Previous / Move cursor to the left
- 26.[PIC] Key: Image setting
- 27.[◀◀] Key: Fast Reverse/ Move cursor down
- 28.[■] Key: Stop Playback
- 29.[DISP/CLEAR] Key: Display information / Clear information
- 30.[0~9] Key: Numeric keys
- 31.[RDM] Key: Random playback
- 32.[INT] Key: Intro playback

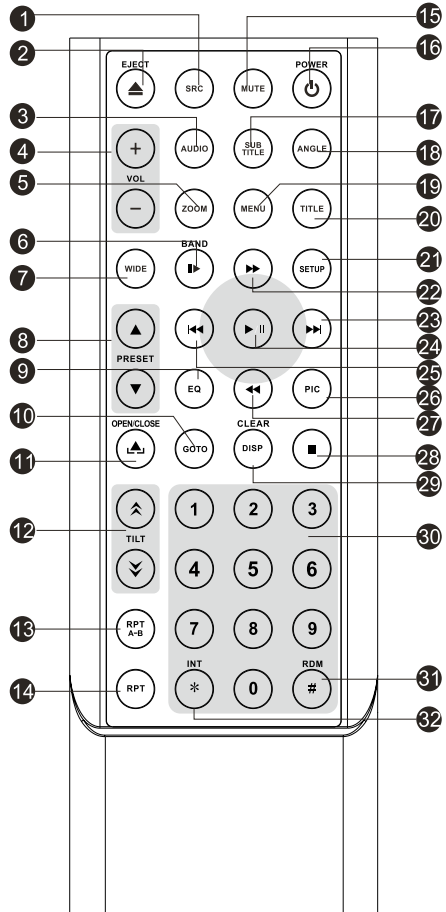

Note:

Your remote control may differ slightly from the one pictured here. The above diagram is for illustrative purpose only.

Before using

Notes of remote control using

- 1) Aim the remote control at the remote sensor on the unit.
- 2) Remove the battery from the remote control or insert a battery insulator if the battery has not been used for a month or longer.
- 3) DO NOT store the remote control under direct sunlight or in high temperature environment, or it may not function properly.
- 4) The battery can work for 6 months under normal condition. If the remote control can't work, please change the battery.
- 5) Use "button shaped" lithium battery "CR2025" (3V) only.
- 6) DO NOT recharge, disassemble, heat or expose the battery in fire.
- 7) Insert the battery in proper direction according to the (+) and (-) poles.
- 8) Store the battery in a place where children cannot reach to avoid the risk of accident.

Uninstall Battery

Slide out the battery compartment tray at the bottom on the back of the remote control.

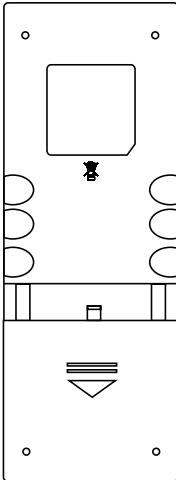

↓ PULL OUT

Install Battery

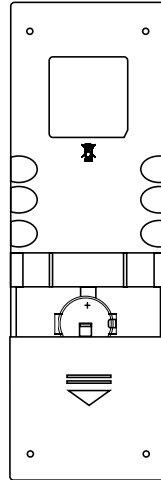

Use button-shaped lithium battery "CR2025 (3V)" only. Insert the battery to the battery tray with proper direction according to the (+) and (-) poles.



PUSH IN ↑

Basic operations

Power on / off

Press the [] key to turn the unit on. The buttons on the front of the unit light up and the current mode status appears on the LCD. Press the [] key to power off the unit.

Audible beep confirmation

An audible beep tone confirms each function selection. The Beep tone can be disabled through the Setup menu.

Mute

Press the volume knob on the front panel or press the [MUTE] key on the remote control to mute the volume from the unit.

Open SOURCE MENU

Press the [SRC] key on the front panel or remote control or touch the top left corner of the screen to open the SOURCE MENU.

Do the above operation again to return to the original source.

Playing source selection

Open the SOURCE MENU, and then touch the source you desired or select one source by moving the cursor and then confirm.

Volume adjustment

Volume Increase/Decrease

To increase or decrease the volume level, turn the rotary encoder on the front panel. When the volume level reaches "0" or "50", a beep sounds, indicating that the adjustment limit has been reached. The TFT screen displays the volume level for 3 seconds.

Programmable turn-on volume

This feature allows the user to select a turn-on volume setting regardless of the volume setting prior to turning the unit off. To program a specific turn-on volume level, turn the rotary encoder to adjust the volume to the desired turn-on volume. Push and hold the rotary encoder while the blue speaker icon and level indication is displayed on the screen. The unit will beep to confirm your turn-on volume setting.

Using the TFT Monitor

Open / Close monitor

Press the [OPEN/CLOSE] key on the front panel or remote control to push the display panel out or in.

Change the monitor tilt angle

Due to the inherent character of LCD, you will get different vision impressions when you watch it from different angles.

The display angle of this unit can be changed; hence you can select the best angle where you can get the best vision impression.

Press the [TILT] key on the display panel or the remote control to adjust the tilt angle one step at a time.

Press and hold the [TILT] key on the display panel or the remote control to adjust the tilt angle continuously.

System reset

To correct a system halt or other illegal operation, use the tip of a pen to press the [RESET] key located on the panel. After a system reset, the unit restores all factory default settings.



Note:

If the unit is reset while a DVD is playing, the DVD resumes play once the reset is complete.

Change aspect ratio

Press the [WIDE] key on the remote control to adjust the aspect ratio.

Image settings

1. Enter image setting mode
Press the [PIC] key on the remote control.
2. Select one item to adjust
Touch the []/[] icon on the user interface to adjust the value.
3. Exit image setting mode
To exit image setting mode, repeat the first step or stop operation for some seconds.

Radio mode

Select radio as playing source





Open the SOURCE MENU and then touch [Radio].

Select one radio band

Press the [BAND] key on the remote control or touch the [] icon on the user interface to select one radio band among FM1, FM2, FM3, AM1 and AM2.

Tune

Auto tuning

Press the [] / [] key on the remote control or touch the [] / [] icon on the user interface to seek a higher / lower station. To stop searching, repeat the operation above or press other keys having radio functions.



Note:

When a station is received, searching stops and the station is played.



Manual tuning

Method 1:

During manual tuning, the frequency will be changed in steps.

Touch the [] / [] icon on the user interface to tune in a higher / lower station.

Method 2:

1. Touch the numeric keypad icon [].
Numeric keyboard is displayed, touch numbers to input frequency.
2. Touch [] to delete the input numbers step by step.
3. Touch [**OK**] to enter.

Preset station

The unit has 5 bands, such as FM1, FM2, FM3, AM1, AM2, and each band can store 6 stations; hence the unit can store 30 stations in total.

Manual store

1. Tune to a station.
2. Touch and hold one of the channels 1 to 6 to save the selected band.



Search Stations Automatically

Touch [] to search station and store the 6 strongest stations in the current band automatically.

Recalling a station

1. Select a band (if needed).
2. Touch an on-screen preset button to select the corresponding stored station.

Local radio station seeking (LOC)

When the Local function is on, only radio stations with a strong local radio signal are played. To activate the Local function in the AM/FM tuner mode, touch [] on the screen. The Options tab is revealed. Touch [] icon and choose the Radio Local or Distance. When the Local function is active, the LOC indicator at the top of the screen is illuminated. When the Distant function is active, the DX indicator at the top of the screen is illuminated.

EQ Selection

Touch the [] icon and enter the EQ setup.

Playback

Insert a disc

Upon inserting a disc, the unit will switch to [DISP] mode automatically.

Notes:

1. Please confirm whether there is a disc in the unit before you insert another one.
2. Some recorded discs, such as CD-R, CD-RW, DVD-R, DVD+R, DVD-RW, DVD+RW cannot be played back because of different recording status. Otherwise, the discs without being closed could not be played back.
3. About the cautions of disc using, please refer to the appendix.
4. Don't pledge to be compatible with all disc.

Eject the disc

Press the [▲] key on the front panel or remote control to eject the disc.

Touch screen controls

The touch key areas for DVD playback are outlined below:

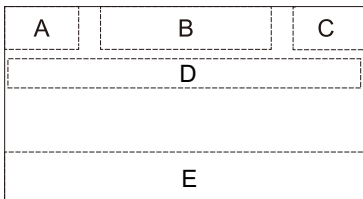

- A: Return to the main menu
B: Disc type
C: Time display
D: Play the video and display playback information
E: Display onscreen control menu

Controlling Playback

To access the on-screen controls, touch the screen anywhere except for the upper left corner and touch again to cancel display.

Connect an USB Device

1. Open the USB door.
2. Connect an USB device into the USB connector. Play starts automatically.

Notes:

1. If there are audio files supported in the USB stick, the system will enter the audio

files menu automatically.

If there are no audio files, but there are video files supported in the USB stick, the system will enter the video files menu automatically.

If there are no audio or video files, but there are picture files supported in the USB stick, the system will enter the picture files menu automatically.

If there no above audio/video/picture files supported in the USB stick, the screen will display: There are no audio/video/picture files supported.

2. Not all kinds of USB devices are compatible with the unit.

Play

Once a disc, or a USB device is inserted, play starts automatically.

Pause

When play the audio/vedio file, press the [▶/||] key on the remote control or open the on-screen control icons menu and then touch the [▶/||] icon, press the [▶/||] again and continue to play.

Stop

For audio files or video files, press the [■] key on the remote control or open the on-screen control icons menu and then touch the [■] icon to stop. Press the [▶/||] to resume from the pausing point.

Touch the [■] icon again to stop entirely, and press the [■] key on the remote control. Press the [▶/||] to playback from the top file.

Previous/Next

Touch [⏮] / [⏭] key on the screen to skip to previous / next track / chapter.

Search for a Folder

For Folder Control

1. Touch [🔍] to display all available folders.
2. Touch a folder, then touch the desired file.
3. Touch the file again to start play.

Playback

For Audio Files

1. Touch [] to display all available audio folders.
2. Touch a folder, then touch the desired file.
3. Touch the file again to start play.

For Video Files

1. Touch [] to display all available video folders.
2. Touch a folder, then touch the desired file.
3. Touch the file again to start play.

For Picture Files

1. Touch [] to display all available picture folders
2. Touch a folder, then touch the desired file.
3. Touch the file again to start play.

Repeat playback

Press the [RPT] key on the remote control or open the on-screen control icons menu and then touch the [] icon to switch the repeat modes as below:

Disc type	Repeat mode
DVD	Repeat chapter → Repeat title → Repeat all → Repeat off
VCD(PBC off)	Repeat one → Repeat all → Repeat off
CD	Repeat one → Repeat all → Repeat off
MP3/WMA	Repeat one → Repeat folder → Repeat all → Repeat off
MPEG	Repeat one → Repeat folder → Repeat all → Repeat off
Picture	Repeat one → Repeat folder → Repeat all → Repeat off

Note:

When play the VCD disc, open the [PBC] function and the [repeat] function is abated.

Repeat A-B

When a DVD, VCD is played back, you can play back the contents between the time points from A to B repeatedly:

Repeat A- → Repeat A-B → Repeat A-B Off

Shuffle (Random) Play

You can play audio tracks/files in random order.

During play CD, press the [RDM] key on the remote control repeatedly to turn shuffle play on or off.

Note:

when the [shuffle] turn off, the unit resume natural play from the current sequence.

PBC function

This function is available for the VCD discs with PBC function (Ver 2.0 or higher).

Press the [MENU] key on the remote control or open the on-screen control icons menu and then touch the [] icon repeatedly to activate this function.



Press again to cancel.

Notes:

1. When PBC is on, playback goes back to the track list and starts from the first track.
2. When PBC is on, fast motion playback, slow motion playback or skip search is available but repeat playback and searching for a particular chapter or track is prohibited.
3. If you do the operation of random playback, scan playback or searching playback when PBC is on, PBC will be off automatically.



Select Audio Mode

When you play VCDs, you can select an audio mode (R/L/Stereo).

1. During play, touch bottom half of the screen to display menu on the screen, if necessary.
2. Touch [] to display the 2nd menu.
Touch [] repeatedly until the audio mode is selected.

Select Subtitle Language

For DVD discs that contain two or more subtitle languages.

1. During play, touch the screen to display menu on the screen, if necessary.
2. Touch [] to display the 2nd menu.
3. Touch [] repeatedly to select a language.
The selected language is displayed.

Change Viewing Angle

Some DVDs contain alternate scenes, such as scenes recorded from different camera angles.

For such DVDs, you can select from the

Playback

available alternate scenes.

1. During play, touch the screen to display menu on the screen, if necessary.
2. Press [] repeatedly on the remote control.
The viewing angle is changed.

Playback Information

Touch the screen when playing back DVD and VCD discs and the playback information will be displayed on the top area of the TFT.

For DVD

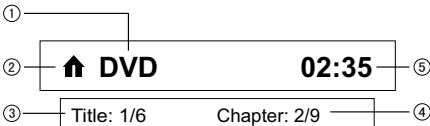

1. Disc type.
2. Return to the main menu.
3. DVD Title information. "1/6" indicates that this DVD has 6 titles and the title playing back now is the first title.
4. DVD Chapter information. "2/9" indicates that current title has 9 chapters and the chapter playing back now is the fifth chapter.
5. Time display.

For VCD

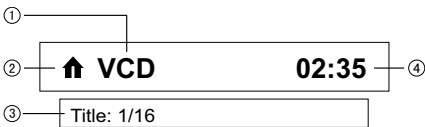

1. Disc type.
2. Return to the main menu.
3. VCD Track information. "1/16" indicates that this VCD has 16 tracks and the track playing back now is the first title.
4. Time display.

Elapsed Time



1. Elapsed time of the current track.
2. Total time of the current track.

Direct Track Entry

To select a track directly, touch the [] icon on screen control to display the direct entry menu. Enter the desired track using the on-screen number pad. Press [**OK**] to the selected track.

Rotate Pictures

1. When you view pictures, touch the screen to display menu on the screen, if necessary.
2. Touch [] repeatedly to rotate the picture.

Zoom

You can zoom in pictures for a close view.

1. When you view pictures, touch the screen to display menu on the screen, if necessary.
2. Touch [] repeatedly to zoom in the picture.

Other modes

Listen to Other Devices

You can connect an external audio/video device to the unit.

1. Connect the external device with the supplied AV cable.
2. Touch the upper left corner to display the main menu.
3. Touch [**Aux 1**] / [**Aux 2**] to access external device.

Camera

This player is "camera ready". Before accessing any camera features, you must purchase and install a rear video camera. Once the rear camera is connected and operating properly, the CAMERA source mode will become active. While the camera is not installed, the CAMERA option appears gray, indicating the function is not available.

The playing source will change to "CAMERA" mode automatically when you reverse your car.

Steering Wheel Control Programming

1. Touch the upper left corner to display home menu.
2. Touch [**SWC**], the SWC menu will display.
3. Adjust each key with an individual function.
4. Touch [**Program**] to program.
5. Press each individual steering wheel control button for each corresponding function.
6. Once the final steering wheel control button is programmed, the functions are saved and the programming will end.
7. Touch and hold [**Reset**] to reset the programming.

Setup

Display System

1. Touch the upper left corner to display the main menu.
2. Touch [].
The settings menu is displayed.

Adjust General Settings

1. Touch [**General**], if necessary.
2. Touch to highlight a setting.
3. Touch to display/select an option.
4. Touch blank area of the screen to exit.

General settings	Options	Description
Radio region	USA/China/Japan/Europe/Europe (LW)/OIRT	Select one that matches your location.
Radio range	Local	Select Local to receive only stations with extremely strong signal.
	Distance	
Beep	On	Turn on the beep sound. Each time you press a button, the unit beeps.
	Off	Turn off the beep sound.
Calibration	Start	Calibrate the touch screen.

Calibration

When the touch operation is not sensitive or valid, you should calibrate the touch screen using the calibration setting function.

Adjust the response positions of the touch panel as followings:

1. Press the [**Calibration**] option on the setup menu to enter.
2. Touch [**Yes**] to enter.
3. Press and hold the center of [+] for 5 seconds, the [+] will move automatically.
4. Aim at center of [+], follow the path as shown in the figure. Once steps 1-4 are complete the system will automatically exit calibrating mode.

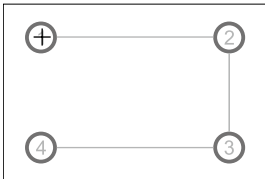

Adjust Video Settings

1. Touch [Video].
2. Touch an option repeatedly to select.

Video settings	Options	Description
Aspect Ratio	Full	Adjust aspect ratio.
	Normal	
Rear Camera	Mirror	Reverse the camera image as if looking through a rear-view mirror.
	Normal	
Parking	On	Disable video when driving.
	Off	Enable video when driving.

When in Park "On" mode, the screen will display WARNING information if you play the video. The arning screen will prevent the driver from watching videos for safety.

Setup

Adjust Time Settings

1. Touch [**Time**].
2. Touch an option repeatedly to select:
3. Touch blank area of the screen to exit.

Sound settings	Options	Description
Date	Year / Mon / Day	Touch [▲] or [▼] to set year, month and day.
Clock mode	12Hr/24Hr	Touch [12Hr] or [24Hr] to switch clock mode.
Time	Hour / Min / AM / PM	Touch [▲] or [▼] to set hour and minutes. Touch [▲] or [▼] to set AM/PM (only for 12Hr).

Adjust Audio settings

1. Touch [**Audio**].
2. Touch an option repeatedly to select.
3. Touch blank area of the screen to exit.

Audio settings	Options	Description
Sub woofer	On	Turn on the subwoofer.
	Off	Turn off the subwoofer
Sub woofer filter	80Hz	Select a crossover frequency to set a cut-off frequency for the subwoofer's LFP (low-pass filter).
	120Hz	
	160Hz	
Loudness Switch	Off	Select low frequency boost only or high and low frequency boost.
	Lo Boost	
	HiGLo	
Loudness Center	400Hz	Select loudness center frequency.
	800Hz	
	2.4KHz	

Adjust Language Settings

1. Touch [**Language**].
2. Touch an option repeatedly to select.
3. Touch blank area of the screen to exit.

Language settings	Description
OSD	Select on-screen display language.
DVD audio	Select DVD audio language. Options available depending on DVD disc.
DVD subtitle	Select DVD subtitle language. Options available depending on DVD disc.
Disc menu	Select DVD menu language. Options available depending on DVD disc.

Setup

Adjust DVD Rating

1. Touch [DVD].
2. Touch an option repeatedly to select.
3. Touch blank area of the screen to exit.

DVD rating	Options	Description
Set password		Set password to restrict the play of discs. The default password is 1234.
Rating level	Kid safe	Acceptable for children.
	G	Acceptable for general viewers.
	PG	Parental guidance suggested.
	PG-13	Unsuitable for children under age 13.
	PG-R	Recommend parents to restrict viewing for children under 17.
	R	Restricted re-parental guidance is advised for children under the age of 17.
	NC-17	Unsuitable for children under age 17.
Adult	Acceptable for adults only.	
Load factory		Restore to default settings.
Version Info		The Version Sub-menu is used to identify the model and resident operation system as well as the hardware and software versions.

Adjust Volume Settings

You can set different volumes for different modes.

1. Touch [Volume].
The volume setting sub-menu is displayed.
2. Touch to select a source.
3. Touch [▲] or [▼] to assign value: 0 to 12.
When switching to the source, the volume increases automatically.
4. Touch blank area to close the sub-menu and touch top left of the screen to exit setting menu.

Select Preset Equalizer

1. Enter the EQ setup mode
Touch the [EQ] icon in the user interface and the EQ setup interface will display on the screen.
2. Select EQ mode
Touch the desired EQ selection: [POP] / [TECHNO] / [ROCK] / [CLASSIC] / [JAZZ] / [OPTIMAL] / [USER], and the EQ mode will change.

Adjust EQ Parameters

Touch [◀] / [▶] to adjust the level of Bass / Mid / Treb.



Adjust FAD BAL

You can adjust front/back/left/right balance of the speaker and the subwoofer volume to get balanced listening effect according to the surroundings and your interest.

1. Enter the EQ setup mode
Touch the [EQ] icon in the EQ interface.
2. Adjust subwoofer volume
Touch [◀] / [▶] "SUB VOL" to adjust subwoofer volume from -12 to +12.
3. Adjust fader / balance value
Touch [▲] / [▼] / [◀] / [▶] to adjust fader / balance value from -12 to +12.
[▲]: Front speaker
[▼]: Rear speaker
[◀]: Left speaker
[▶]: Right speaker



Notes:

1. The EQ mode will change to 'User' automatically when you adjust the frequency value in all modes besides 'User'.
2. The value of Sub is independent of EQ mode and can be adjusted separately.

Troubleshooting

What appears to be trouble is not always serious. Please check the following points before calling a service center.

Problem	Cause	Corrective action
General		
Unit can not power on	Unit fuse blown.	Install new fuse with correct rating.
	Car battery fuse blown.	Install new fuse with correct rating.
	Illegal operation	Reset the unit.
Remote control does not work	Battery depleted.	Change the battery.
	Battery installed incorrectly.	Install the battery correctly.
No/low audio output	Improper audio output connection.	Check wiring and correct.
	Volume set too low.	Increase volume level.
	Speakers damaged.	Replace speakers.
	Heavily biased volume balance.	Adjust the channel balance to center position.
Poor sound quality or distortion	Speaker wiring is in contact with metal part of car.	Insulate all speaker wiring connections.
	Piratic disc is in use.	Use original disc.
	Speaker power rating does not match unit.	Replace speakers.
	Wrong connections.	Check wiring and correct.
Tel-Mute malfunction	Speaker is shorted.	Check wiring and correct.
	MUTE wire is grounded.	Check the 'MUTE' wiring and correct.
Unit resets itself when engine is off	Incorrect connection between ACC and BATT.	Check wiring and correct.
TFT monitor		
Monitor does not open automatically	TFT Auto Open is turned off.	Turn TFT Auto Open on.
Warning information is shown at all times	Parking break wiring is not correct.	Check wiring and correct.
Flashing image or interference appears on screen	The color system of DVD disc does not match the monitor.	Adjust the color system of the DVD disc playing back or the monitor in use.
	Piratic disc is in use.	Use original disc.
	Video cable damaged.	Replace cables.
	Improper video signal connections.	Check wiring and correct.

Troubleshooting

(Continued)

Problem	Cause	Corrective action
Disc playback		
Cannot insert disc	A disc inside the unit already.	Eject current disc and insert new one.
Disc does not play back	Disc is warped or scratched.	Use disc in good condition.
	Disc is dirty or wet.	Clean disc with soft cloth.
	Incompatible disc is used.	Use compatible disc.
	Disc is inserted upside down.	Insert disc with label side up.
	Disc region code is not compatible with unit.	Use disc with proper region code.
PBC cannot be used during VCD playback	PBC is not available on the disc.	Use disc with PBC available.
Repeat or search function is invalid during VCD playback	PBC is on.	Turn PBC off.
Error messages		
No disc	Disc is dirty.	Clean disc with soft cloth.
	Disc is upside down.	Insert disc with label side up.
	No disc inside.	Insert disc.
Bad disc	Disc is dirty.	Clean disc with soft cloth.
	Disc is upside down.	Insert disc with label side up.
Unknown disc	Disc format is not compatible with this unit.	Use disc with compatible format.
Region Error	DVD region code is not compatible with this unit.	Use disc with compatible region code.

Device connections

Notes of connection

- This unit is designed to be used in a vehicle with a 12-volt battery and negative grounding. Before installing this unit to a recreational vehicle, a bus, or a truck, make sure the battery voltage is appropriate for this unit to be used, otherwise, install a transformer by professional to convert the output voltage to 12V.
- To avoid short circuit in the electrical system, ensure that the negative battery cable is disconnected before installation.
- To prevent short circuit in the wiring and damaging to this unit, secure all wirings with cable clamp or adhesive tape. Route the wirings in a secured, out of heating place without touching any moving parts such as gear shift, handbrake, and seat rails to prevent the wiring insulation being melted / wore off.
- Never pass the yellow power cord through the installation hole into the engine compartment and connect to the car battery. Otherwise, a high possibility of serious short circuit to the electrical system may be occurred.
- Replacing a new fuse with 15A rating when the old one is broken, using no fuse or fuse with improper rating may cause damage to this unit or even fires. If a proper fuse is installed and electrical problems still occur, please contact with any professional car shops for inquiry.
- Do not connect other equipments with the car battery to avoid battery overheating.
- Please make sure all the wiring connections & the cables of the speakers are well-insulated. Otherwise, this unit may be damaged by short circuit.
- If there is no ACC available, Please connect ACC lead to the power supply with a switch.
- If an external power amplifier is connected, please don't connect P.CONT lead to the power lead of the external power amplifier, otherwise, electric spark or other damage may be resulted.
- Never ground the speaker output to prevent the damage to the built-in power amplifier.
- The minimum rating of the speakers connected to this unit is 50W with 4 to 8Ω impedance.

Control Cables

Auto Brightness Control

To avoid the display being too bright at night time, if the headlight cable is connected to ILLUMI, turning on the headlight will dim the backlight of the TFT LCD and vice versa.

Telephone Mute

If the MUTE cable is connected to a car phone, other audio outputs mute when one call is received by the car phone.

Reverse Driving

If a rear view camera is connected with the unit, the playing source switches to CAMERA automatically when you start reverse driving.

As the reverse driving is done, the playing source switches to the previous.

Parking Brake

1. If "PRK SW" cable is connected to hand brake switch, "PRK display on the TFT monitor will be controlled by this function.
Parking cable function ceases when the playing source is CAMERA.
2. The monitor displays the blue screen with warning information to prevent the driver watching video contents during driving, but the passengers at the rear seat can watch video contents normally.

Region Code

According to DVD sale region, the whole world is divided into six regions. A DVD disc can be played back only when its region code is compatible with that of the player in use.

Region 1: USA, Canada, East Pacific Ocean Islands;

Region 2: Japan, West Europe, North Europe, Egypt, South Africa, Middle East;

Region 3: Taiwan of China, Hong Kong of China, South Korea, Thailand, Indonesia, South East Asia;

Region 4: Australia, New Zealand, Mid & south America, South Pacific Ocean Islands/Oceania;

Region 5: Russia, Mongolia, India, Middle Asia, East Europe, North Korea, North Africa, North West Asia;

Region 6: Chinese Mainland.

Device connections

Parking Brake Cable Connections

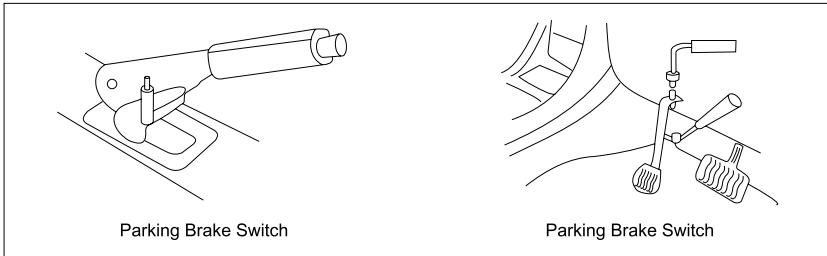
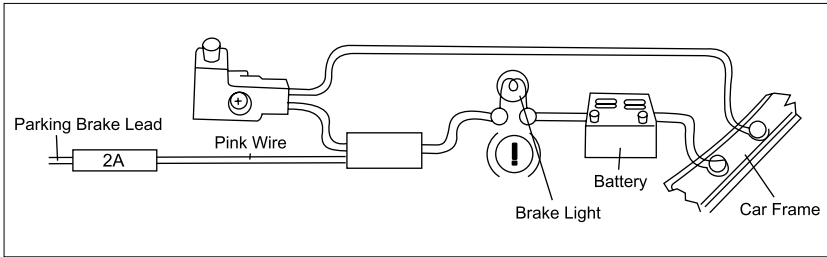

Reverse Driving Cable Connections

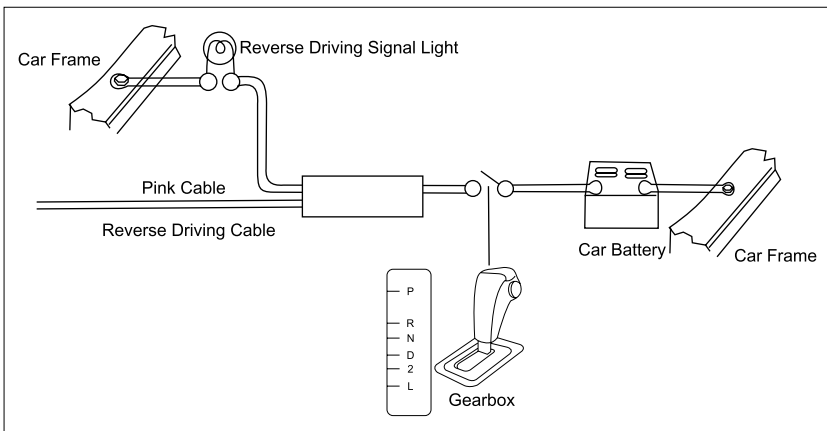

Installation and uninstal

Notes of installation

1. Before installation, please make sure proper connections are conducted and the unit operates normally. Improper connection may result in damage to the unit.
2. Use only accessories designed and manufactured for this unit and other unauthorized accessories may result in damage to the unit.
3. Before installation, please fasten all power cables.
4. Do not install the unit in the place where close to hot area to prevent damage to electrical components such as the laser head.
5. Install the unit horizontally. Installing the unit more than 30 degree vertically may result in worse performance.
6. To prevent electric spark, connect the positive pole first and then the negative pole.
7. Do not block the cooling fan exit to ensure sufficient heating dissipation of this unit, or it may result in damage to this unit.

Installation procedures

1. If relevant, remove any other audio system from the car.
2. Insert the mounting sleeve into the dashboard. Fix it firmly in place by folding down the metal tabs.
3. Perform the required electrical connections.
4. Then check that everything works before installing the main unit.
5. Remove the two screws on the top of the unit, otherwise, the unit will not work.
6. Install the car radio in the dashboard using the supplied screw (M4x10mm) and put a rubber sheath over the screw.
7. Attach the outer trim frame. If you are not sure how to install this unit correctly, contact a qualified technician.

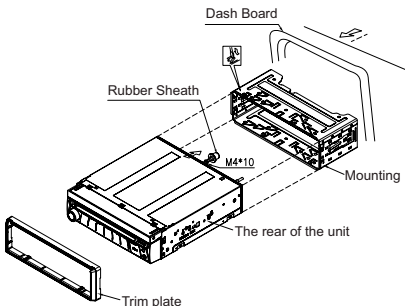

Remove the unit

1. Switch off the power of the unit.
2. Remove the trim plate.
3. Insert both L-Keys into the hole on the front of the set until they lock.
4. Pull out the unit.

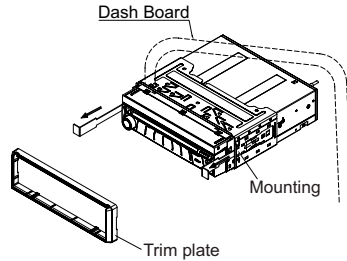

Trim ring installation

Attach the trim ring around the front panel with two indentions on one side facing upwards.

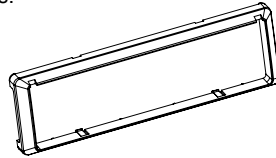

Trim ring uninstall

Disassemble trim ring

1. Push the trim ring upward and pull out the upper part.

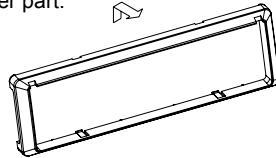

2. Push the trim ring downward and pull out the lower part.

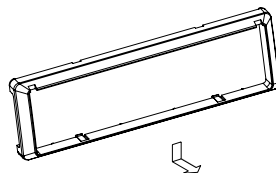

Specifications

General

Reference Supply Voltage: 12V DC
Operating Voltage Range: 10.5~15.8V(DC)
Max Operating Current: 10A
Grounding System: Car Battery Negative Pole
Installation Dimension(WxHxD) output:
178x50x(165+25)mm
Installation Angle: 0°~30°
Net Weight: 2.3kg

FM

Frequency Range: 87.5-107.9MHz
Residual Noise Sensitivity (S/N=30dB): 12dB μ V
Signal Noise Ratio: 55dB
Station Seeking Level: 20~30dB μ V
Distortion: 1.5%
Stereo Separation(1KHz): 25dB
Antenna Impedance: 75 Ω

AM

Frequency Range: 530-1710KHz
Residual Noise Sensitivity (S/N=20dB): 30dB μ V
Selectivity (\pm 10KHz): 40dB

DVD player

Signal / Noise Ratio: 90dB
Dynamic Range: 90dB
Distortion(line out): 0.1%
Frequency Response(\pm 3dB): 20Hz~20KHz
Max Output Power: 4 \times 45W
Load Impedance: 4 Ω

AUX IN

Distortion: 0.5%
Frequency Response(\pm 3dB): 20Hz~20KHz
Audio Input Level: 0.4Vrms

Audio

Audio Output Impedance: 200 Ω
Audio Output Level: 2Vrms(Max)
Audio Input Level: 0.4Vrms
(Under normal audio input level and maximum volume)

Video

Normal Video Input Level (CVBS): 1.0 \pm 0.2V
Video Input Impedance: 75 Ω
Video Output Impedance: 75 Ω
Video Output Level: 1.0 \pm 0.2V
(Under normal video input level)

TFT monitor

Screen Diagonal: 7 inches
Usable Display Area: 154.1(W) \times 87.0 (H)
Resolution: 1440 (W) \times 234 (H)
Brightness: 400cd/m²
Video Output Level: 1.0 \pm 0.2V
(Measure the center brightness after 30 minutes)
Contrast: 300(TYP.)
Response Time:
Rise: 12ms
Fall: 18ms
Viewing Angle:
From Top: 40°
From bottom: 65°
Horizontally: \pm 65°
LCD Life Cycle: 10000 hours(at 25°C)

Environment

Operating Temperature: -10°C~+60°C
Storing Temperature: -20°C~+70°C
Operating Humidity: 45%~80%RH
Storing Humidity: 30%~90%RH

Note:

Specifications are subject to possible modifications for improvement without further notice.

Appendix

FCC Statement

1. This device complies with Part 15 of the FCC Rules.
Operation is subject to the following two conditions:
 - (1) This device may not cause harmful interference.
 - (2) This device must accept any interference received, including interference that may cause undesired operation.
2. Changes or modifications not expressly approved by the party responsible for compliance could void the user's authority to operate the equipment.

NOTE:

This equipment has been tested and found to comply with the limits for a Class B digital device, pursuant to Part 15 of the FCC Rules. These limits are designed to provide reasonable protection against harmful interference in a residential installation.

This equipment generates uses and can radiate radio frequency energy and, if not installed and used in accordance with the instructions, may cause harmful interference to radio communications. However, there is no guarantee that interference will not occur in a particular installation. If this equipment does cause harmful interference to radio or television reception, which can be determined by turning the equipment off and on, the user is encouraged to try to correct the interference by one or more of the following measures:

- Reorient or relocate the receiving antenna.
- Increase the separation between the equipment and receiver.
- Connect the equipment into an outlet on a circuit different from that to which the receiver is connected.
- Consult the dealer or an experienced radio/TV technician for help.

FCC Radiation Exposure Statement

This equipment complies with FCC radiation exposure limits set forth for an uncontrolled environment. This equipment should be installed and operated with minimum distance of 20 centimeters between the radiator and your body.

This item incorporates copy protection technology that is protected by U.S. patents and other intellectual property rights of Rovi Corporation. Reverse engineering and disassembly are prohibited.

The Bluetooth® word mark and logos are registered trademarks owned by Bluetooth SIG, Inc.

 **DOLBY** Manufactured under license from
DIGITAL Dolby Laboratories.

"Dolby" and the double-D symbol are trademarks of Dolby Laboratories.

DivX®, DivX Certified® and associated logos are trademarks of Rovi Corporation or its subsidiaries and are used under license. Covered by one or more of the following U.S. patents:

7,295,673; 7,460,668; 7,515,710; 7,519,274
ABOUT DIVX VIDEO: DivX® is a digital video format created by DivX, LLC, a subsidiary of Rovi Corporation. This is an official DivX Certified® device that plays DivX video. Visit divx.com for more information and software tools to convert your files into DivX video.

ABOUT DIVX VIDEO-ON-DEMAND: This DivX Certified® device must be registered in order to play purchased DivX Video-on-Demand (VOD) movies. To obtain your registration code, locate the DivX VOD section in your device setup menu. Go to vod.divx.com for more information on how to complete your registration.

DivX Certified® to play DivX® video, including premium content.

Wiring Diagram

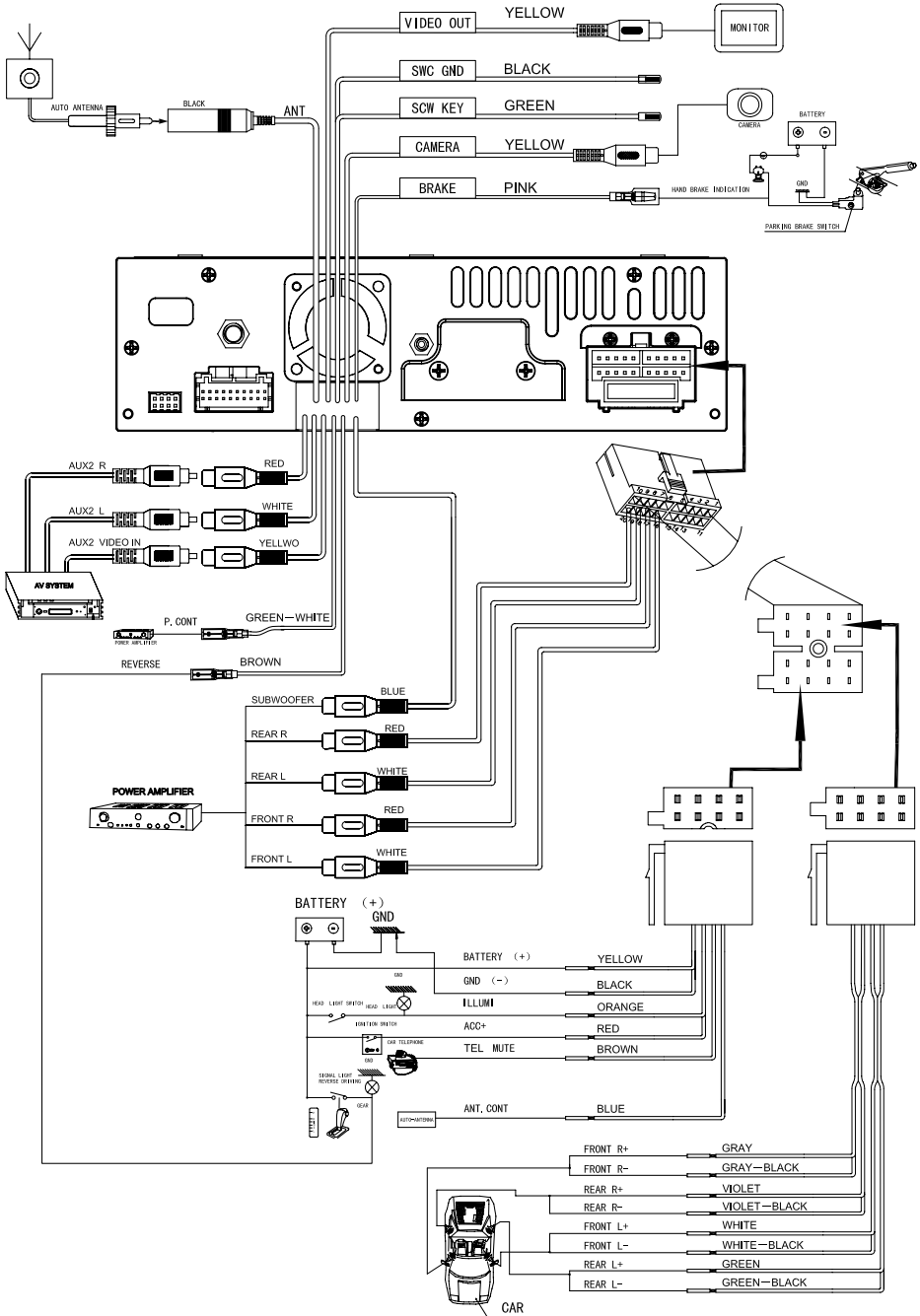



P.N.: 127075005684