

FCC TEST REPORT

For

Elexa Consumer Products Inc.

Guardian Valve Controller

Model No.: GVC1

Prepared For : Elexa Consumer Products Inc.
Address : 2275 Half Day Road, Suite 333, Bannockburn, Illinois, United States

Prepared By : Shenzhen Anbotek Compliance Laboratory Limited
Address : 1/F., Building 1, SEC Industrial Park, No.0409 Qianhai Road, Nanshan District, Shenzhen, Guangdong, China
Tel: (86) 755-26066544 Fax: (86) 755-26014772

Report Number : R0217080021W1
Date of Test : Aug. 09~Oct. 16, 2017
Date of Report : Oct. 16, 2017

Contents

1. General Information.....	5
1.1. Client Information.....	5
1.2. Description of Device (EUT).....	5
1.3. Auxiliary Equipment Used During Test.....	5
1.4. Description of Test Modes.....	6
1.5. List of channels.....	6
1.6. Description Of Test Setup.....	7
1.7. Test Equipment List.....	8
1.8. Measurement Uncertainty.....	8
1.9. Description of Test Facility.....	9
2. Summary of Test Results.....	10
3. Conducted Emission Test.....	11
3.1. Test Standard and Limit.....	11
3.2. Test Setup.....	11
3.3. Test Procedure.....	11
3.4. Test Data.....	11
4. Radiation Spurious Emission and Band Edge.....	16
4.1. Test Standard and Limit.....	16
4.2. Test Setup.....	16
4.3. Test Procedure.....	17
4.4. Test Data.....	18
5. Maximum Peak Output Power Test.....	25
5.1. Test Standard and Limit.....	25
5.2. Test Setup.....	25
5.3. Test Procedure.....	25
5.4. Test Data.....	25
6. 6DB Occupy Bandwidth Test.....	28
6.1. Test Standard and Limit.....	28
6.2. Test Setup.....	28
6.3. Test Procedure.....	28
6.4. Test Data.....	28
7. Power Spectral Density Test.....	31
7.1. Test Standard and Limit.....	31
7.2. Test Setup.....	31
7.3. Test Procedure.....	31
7.4. Test Data.....	31
8. 100kHz Bandwidth of Frequency Band Edge Requirement.....	34
8.1. Test Standard and Limit.....	34
8.2. Test Setup.....	34
8.3. Test Procedure.....	34
8.4. Test Data.....	34
9. Antenna Requirement.....	38

9.1. Test Standard and Requirement..... 38
9.2. Antenna Connected Construction..... 38
APPENDIX I -- TEST SETUP PHOTOGRAPH..... 39
APPENDIX II -- EXTERNAL PHOTOGRAPH..... 41
APPENDIX III -- INTERNAL PHOTOS..... 45



TEST REPORT

Applicant : Elexa Consumer Products Inc.
Manufacturer : Zmartgears Limited.
Product Name : Guardian Valve Controller
Model No. : GVC1
Trade Mark : N.A.
Rating(s) : Input DC 12V 2A (Adapter Input 100-240V, 50/60Hz, 0.8A Max)

Test Standard(s) : FCC Part15 Subpart C 2016, Section 15.247

Test Method(s) : ANSI C63.10: 2013, KDB558074 D01 DTS Meas Guidance v04

The device described above is tested by Shenzhen Anbotek Compliance Laboratory Limited to determine the maximum emission levels emanating from the device and the severe levels of the device can endure and its performance criterion. The measurement results are contained in this test report and Shenzhen Anbotek Compliance Laboratory Limited is assumed full of responsibility for the accuracy and completeness of these measurements. Also, this report shows that the EUT (Equipment Under Test) is technically compliant with the FCC Part 15 Subpart C requirements.

This report applies to above tested sample only and shall not be reproduced in part without written approval of Shenzhen Anbotek Compliance Laboratory Limited.

Date of Test : Aug. 09~Oct. 16, 2017

Prepared by :  : 
(Tested Engineer / Winkey Wang)

Reviewer : 
(Project Manager / Tangcy. T)

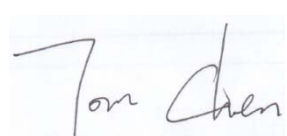
Approved & Authorized Signer : 
(Manager / Tom Chen)

1. General Information

1.1. Client Information

Applicant	:	Elexa Consumer Products Inc.
Address	:	2275 Half Day Road, Suite 333, Bannockburn, Illinois, United States
Manufacturer	:	Zmartgears Limited.
Address	:	4/F, Building A3, Digital Tech Park Gaoxin South 7th Rd, Science Park, Nanshan District, SZ 518057, GD, CN

1.2. Description of Device (EUT)

Product Name	:	Guardian Valve Controller	
Model No.	:	GVC1	
Trade Mark	:	N.A.	
Test Power Supply	:	AC 120V, 60Hz via adapter/AC 240V, 60Hz via adapter	
Product Description	:	Operation Frequency:	2402MHz~2480MHz
	:	Transfer Rate:	1 Mbits/s
	:	Number of Channel:	40 Channels
	:	Modulation Type:	FSK
	:	Antenna Type:	PCB Antenna
	:	Antenna Gain(Peak):	2.0 dBi
<p>Remark: 1) For a more detailed features description, please refer to the manufacturer's specifications or the User's Manual. 2) This report is for BT4.0.</p>			

1.3. Auxiliary Equipment Used During Test

Adapter	:	Manufacturer: AQUIL STAR PRECISION INDUSTRIAL(SHENZHEN)CO., LTD M/N: ASSA67A-120200 Input: 100-240V~50/60Hz 0.8A Output: 12.0V, 2.0A
---------	---	---

1.4. Description of Test Modes

To investigate the maximum EMI emission characteristics generated from EUT, the test system was pre-scanning tested based on the consideration of following EUT operation mode or test configuration mode which possibly have effect on EMI emission level. Each of these EUT operation mode(s) or test configuration mode(s) mentioned above was evaluated respectively.

Pretest Mode	Description
Mode 1	CH00
Mode 2	CH19
Mode 3	CH39
Mode 4	Keeping TX mode

For Conducted Emission	
Final Test Mode	Description
Mode 4	Keeping TX mode

For Radiated Emission	
Final Test Mode	Description
Mode 1	CH00
Mode 2	CH19
Mode 3	CH39

Note:

- (1) The measurements are performed at the highest, middle, lowest available channels.
- (2) The data rate was set in 1Mbps for radiated emission due to the highest RF output power.

1.5. List of channels

Channel	Freq. (MHz)	Channel	Freq. (MHz)	Channel	Freq. (MHz)	Channel	Freq. (MHz)	Channel	Freq. (MHz)
00	2402	09	2420	18	2438	27	2456	36	2474
01	2404	10	2422	19	2440	28	2458	37	2476
02	2406	11	2424	20	2442	29	2460	38	2478
03	2408	12	2426	21	2444	30	2462	39	2480
04	2410	13	2428	22	2446	31	2464		
05	2412	14	2430	23	2448	32	2466		
06	2414	15	2432	24	2450	33	2468		
07	2416	16	2434	25	2452	34	2470		
08	2418	17	2436	26	2454	35	2472		

1.6. Description Of Test Setup

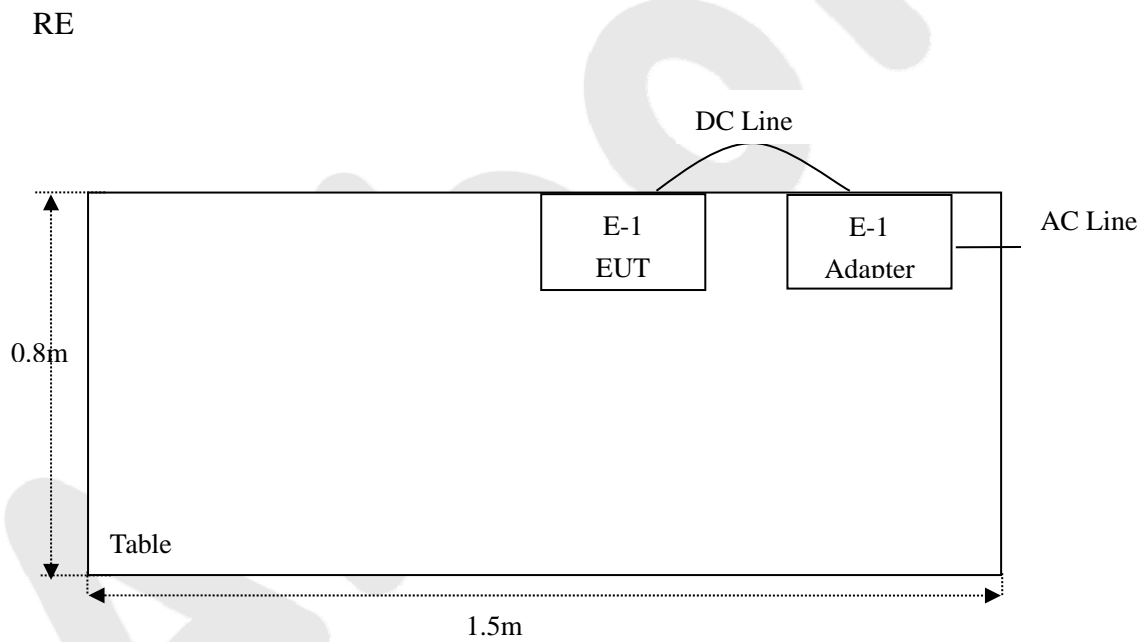
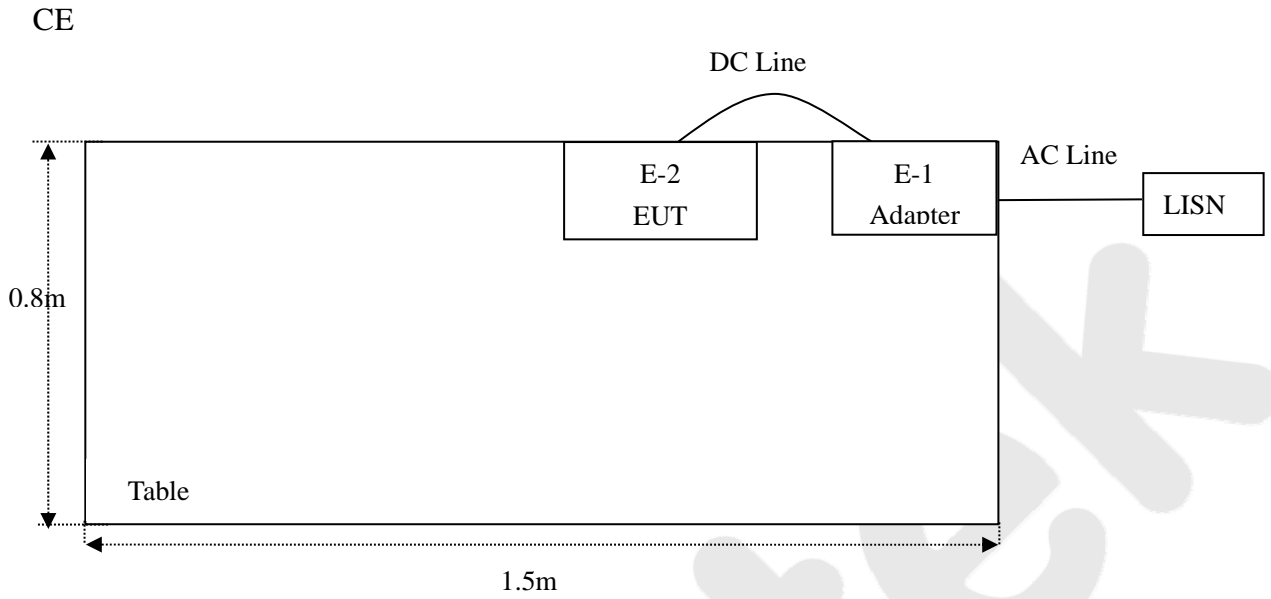

1.7. Test Equipment List

Item	Equipment	Manufacturer	Model No.	Serial No.	Last Cal.	Cal. Interval
1.	L.I.S.N. Artificial Mains Network	Rohde & Schwarz	ENV216	100055	May 27, 2017	1 Year
2.	EMI Test Receiver	Rohde & Schwarz	ESCI	100627	May 27, 2017	1 Year
3.	RF Switching Unit	Compliance Direction	RSU-M2	38303	May 27, 2017	1 Year
4.	Spectrum Analysis	Agilent	E4407B	US39390582	May 27, 2017	1 Year
5.	Preamplifier	SKET Electronic	BK1G18G30 D	KD17503	May 27, 2017	1 Year
6.	EMI Test Receiver	Rohde & Schwarz	ESPI	101604	May 27, 2017	1 Year
7.	Double Ridged Horn Antenna	Instruments corporation	GTH-0118	351600	May 31, 2017	1 Year
8.	Bilog Broadband Antenna	Schwarzbeck	VULB9163	VULB 9163-289	May 31, 2017	1 Year
9.	Loop Antenna	Schwarzbeck	HFH2-Z2	100047	Apr. 03, 2017	1 Year
10.	Pre-amplifier	SONOMA	310N	186860	May 27, 2017	1 Year
11.	EMI Test Software EZ-EMC	SHURPLE	N/A	N/A	N/A	N/A
12.	Power Sensor	DAER	RPR3006W	15I00041SN045	May 27, 2017	1 Year
13.	Power Sensor	DAER	RPR3006W	15I00041SN046	May 27, 2017	1 Year
14.	MXA Spectrum Analysis	Agilent	N9020A	MY51170037	May 27, 2017	1 Year
15.	MXG RF Vector Signal Generator	Agilent	N5182A	MY48180656	May 27, 2017	1 Year
16.	Signal Generator	Agilent	E4421B	MY41000743	May 27, 2017	1 Year
17.	DC Power supply	IVYTECH	IV6003	1601D6030007	May 26, 2017	1 Year
18.	TEMP&HUMI PROGRAMMABLE CHAMBER	Sertep	ZJ-HWHS80 B	ZJ-17042804	Mar. 03, 2017	1 Year

1.8. Measurement Uncertainty

Radiation Uncertainty	:	Ur = 4.1 dB (Horizontal)
		Ur = 4.3 dB (Vertical)
Conduction Uncertainty	:	Uc = 3.4dB

1.9. Description of Test Facility

The test facility is recognized, certified, or accredited by the following organizations:

FCC-Registration No.: 184111

Shenzhen Anbotek Compliance Laboratory Limited, EMC Laboratory has been registered and fully described in a report filed with the (FCC) Federal Communications Commission. The acceptance letter from the FCC is maintained in our files. Registration No. 184111, July 31, 2017.

ISED-Registration No.: 8058A-1

Shenzhen Anbotek Compliance Laboratory Limited, EMC Laboratory has been registered and fully described in a report filed with the (ISED) Innovation, Science and Economic Development Canada. The acceptance letter from the ISED is maintained in our files. Registration 8058A-1, June 13, 2016.

Test Location

All Emissions tests were performed at

Shenzhen Anbotek Compliance Laboratory Limited. at 1/F., Building 1, SEC Industrial Park, No.0409 Qianhai Road, Nanshan District, Shenzhen, Guangdong, China

2. Summary of Test Results

Standard Section	Test Item	Result
15.203/15.247(c)	Antenna Requirement	PASS
15.207	Conducted Emission	PASS
15.205/15.209	Spurious Emission	PASS
15.247(b)(3)	Conducted Peak Output Power	PASS
15.247(a)(2)	6dB Occupied Bandwidth	PASS
15.247(e)	Power Spectral Density	PASS
15.247(d)	Band Edge	PASS
Remark: "N/A" is an abbreviation for Not Applicable.		

3. Conducted Emission Test

3.1. Test Standard and Limit

Test Standard	FCC Part15 Section 15.207		
Test Limit	Frequency	Maximum RF Line Voltage (dBuV)	
		Quasi-peak Level	Average Level
	150kHz~500kHz	66 ~ 56 *	56 ~ 46 *
	500kHz~5MHz	56	46
5MHz~30MHz	60	50	

Remark: (1) *Decreasing linearly with logarithm of the frequency.
(2) The lower limit shall apply at the transition frequency.

3.2. Test Setup

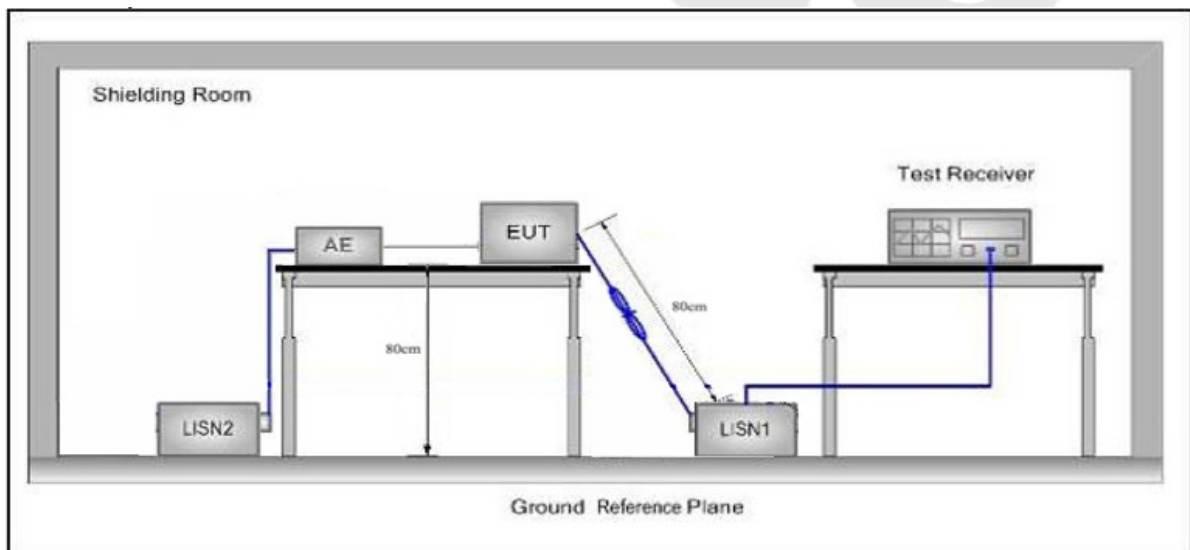

3.3. Test Procedure

The EUT system is connected to the power mains through a line impedance stabilization network (L.I.S.N.). This provides a 50ohm coupling impedance for the EUT system. Please refer the block diagram of the test setup and photographs. Both sides of AC line are checked to find out the maximum conducted emission. In order to find the maximum emission levels, the relative positions of equipment and all of the interface cables shall be changed according to FCC ANSI C63.10-2013 on Conducted Emission Measurement.

The bandwidth of test receiver (ESCI) set at 9kHz.

The frequency range from 150kHz to 30MHz is checked.

3.4. Test Data

Please to see the following pages

Conducted Emission Test Data

Test Site: 1# Shielded Room
 Operating Condition: Keeping TX mode
 Test Specification: AC 120V, 60Hz via adapter
 Comment: Live Line
 Tem.:25°C Hum.:50%

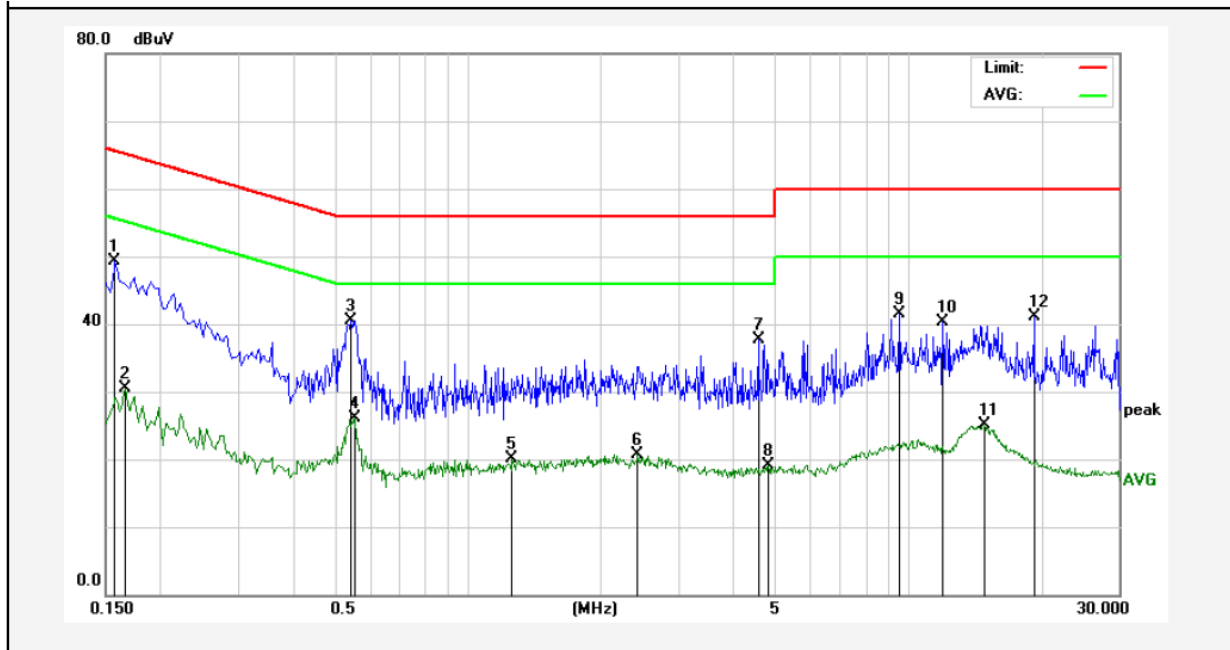

No.	Freq. (MHz)	Reading (dBuV)	Factor (dB)	Result (dBuV)	Limit dBuV	Over Limit (dB)	Detector	Remark
1	0.1580	29.35	19.90	49.25	65.56	-16.31	QP	
2	0.1660	10.55	19.90	30.45	55.15	-24.70	AVG	
3	0.5420	20.48	19.99	40.47	56.00	-15.53	QP	
4	0.5540	6.09	20.00	26.09	46.00	-19.91	AVG	
5	1.2620	0.07	20.13	20.20	46.00	-25.80	AVG	
6	2.4300	0.56	20.15	20.71	46.00	-25.29	AVG	
7	4.5700	17.49	20.20	37.69	56.00	-18.31	QP	
8	4.7980	-1.14	20.20	19.06	46.00	-26.94	AVG	
9	9.5020	21.26	20.33	41.59	60.00	-18.41	QP	
10	11.9819	20.04	20.31	40.35	60.00	-19.65	QP	
11	14.7980	4.78	20.26	25.04	50.00	-24.96	AVG	
12	19.3060	20.79	20.33	41.12	60.00	-18.88	QP	

Conducted Emission Test Data

Test Site: 1# Shielded Room
 Operating Condition: Keeping TX mode
 Test Specification: AC 120V, 60Hz via adapter
 Comment: Neutral Line
 Tem.:25°C Hum.:50%

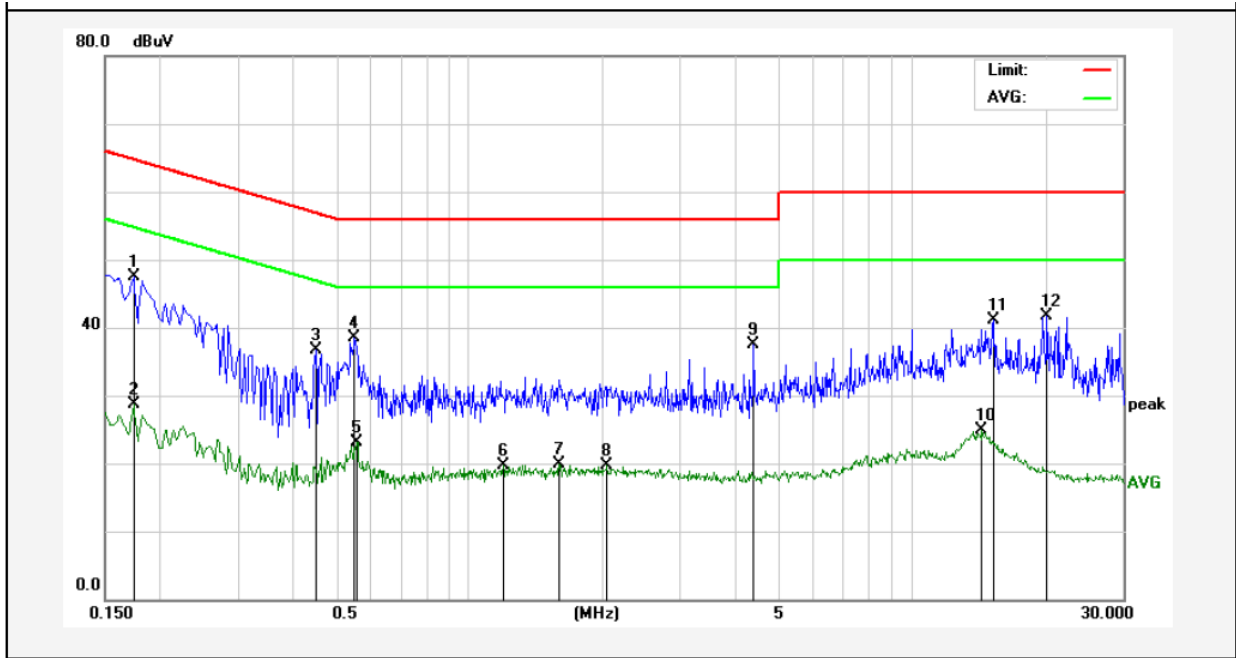

No.	Freq. (MHz)	Reading (dBuV)	Factor (dB)	Result (dBuV)	Limit dBuV	Over Limit (dB)	Detector	Remark
1	0.1740	27.60	19.90	47.50	64.76	-17.26	QP	
2	0.1740	8.71	19.90	28.61	54.76	-26.15	AVG	
3	0.4500	16.81	19.96	36.77	56.87	-20.10	QP	
4	0.5500	18.60	19.99	38.59	56.00	-17.41	QP	
5	0.5580	3.16	20.00	23.16	46.00	-22.84	AVG	
6	1.1940	-0.39	20.12	19.73	46.00	-26.27	AVG	
7	1.5940	-0.30	20.13	19.83	46.00	-26.17	AVG	
8	2.0500	-0.49	20.14	19.65	46.00	-26.35	AVG	
9	4.3900	17.38	20.19	37.57	56.00	-18.43	QP	
10	14.3900	4.55	20.27	24.82	50.00	-25.18	AVG	
11	15.3100	20.81	20.26	41.07	60.00	-18.93	QP	
12	20.2260	21.34	20.34	41.68	60.00	-18.32	QP	

Conducted Emission Test Data

Test Site: 1# Shielded Room
 Operating Condition: Keeping TX mode
 Test Specification: AC 240V, 60Hz via adapter
 Comment: Live Line
 Tem.:25°C Hum.:50%

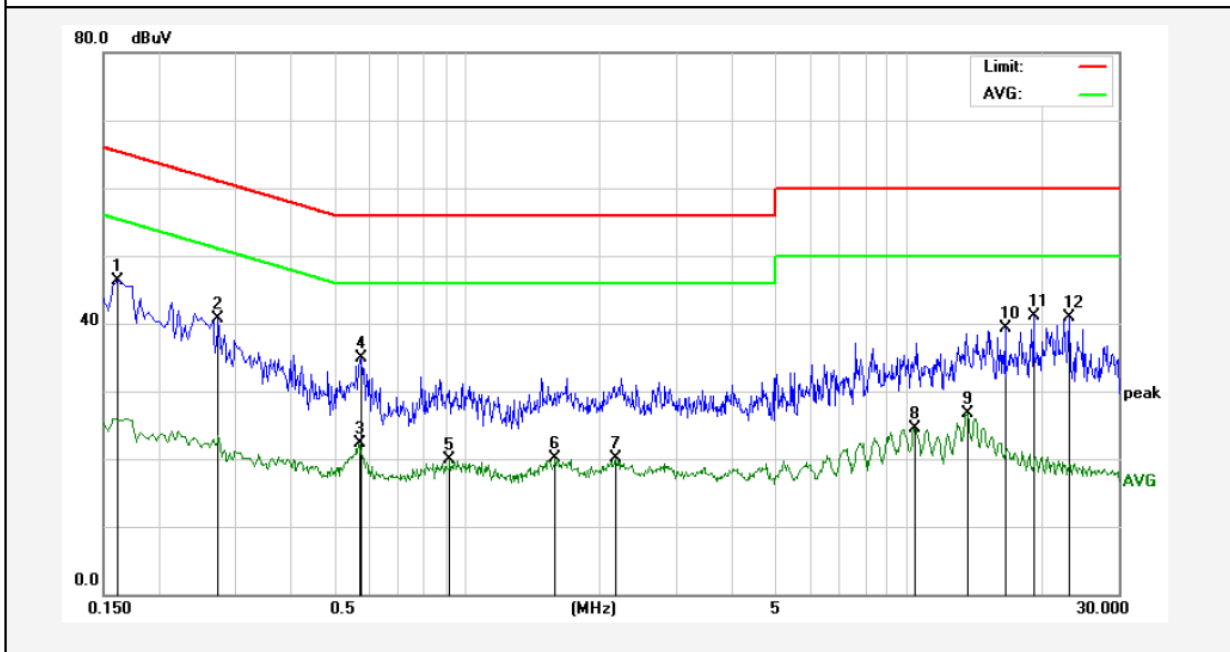

No.	Freq. (MHz)	Reading (dBuV)	Factor (dB)	Result (dBuV)	Limit dBuV	Over Limit (dB)	Detector	Remark
1	0.1620	26.48	19.90	46.38	65.36	-18.98	QP	
2	0.2740	20.80	19.89	40.69	60.99	-20.30	QP	
3	0.5700	2.22	20.00	22.22	46.00	-23.78	AVG	
4	0.5780	14.84	20.00	34.84	56.00	-21.16	QP	
5	0.9180	-0.28	20.10	19.82	46.00	-26.18	AVG	
6	1.5900	-0.09	20.13	20.04	46.00	-25.96	AVG	
7	2.1740	0.05	20.14	20.19	46.00	-25.81	AVG	
8	10.3300	4.25	20.33	24.58	50.00	-25.42	AVG	
9	13.6420	6.45	20.28	26.73	50.00	-23.27	AVG	
10	16.6540	19.10	20.29	39.39	60.00	-20.61	QP	
11	19.2740	20.81	20.33	41.14	60.00	-18.86	QP	
12	23.2139	20.54	20.30	40.84	60.00	-19.16	QP	

Conducted Emission Test Data

Test Site: 1# Shielded Room
 Operating Condition: Keeping TX mode
 Test Specification: AC 240V, 60Hz via adapter
 Comment: Neutral Line
 Tem.:25°C Hum.:50%

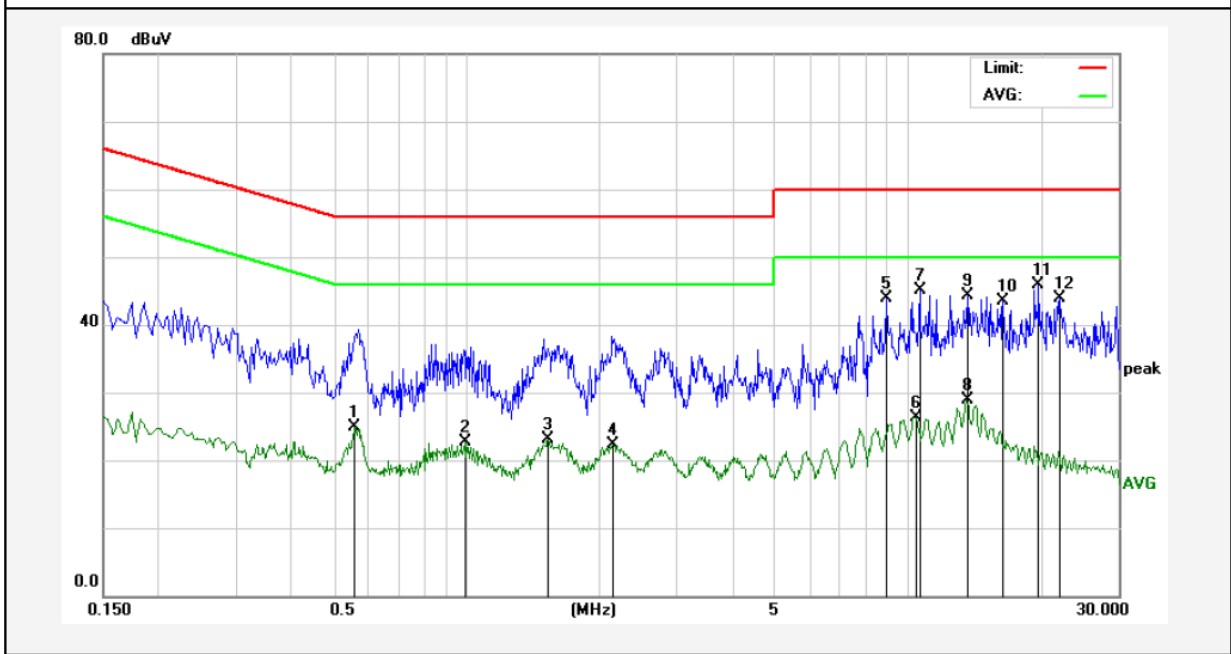

No.	Freq. (MHz)	Reading (dBuV)	Factor (dB)	Result (dBuV)	Limit dBuV	Over Limit (dB)	Detector	Remark
1	0.5580	4.99	20.00	24.99	46.00	-21.01	AVG	
2	0.9940	2.53	20.12	22.65	46.00	-23.35	AVG	
3	1.5300	2.97	20.13	23.10	46.00	-22.90	AVG	
4	2.1540	2.24	20.14	22.38	46.00	-23.62	AVG	
5	8.9620	23.55	20.31	43.86	60.00	-16.14	QP	
6	10.4140	6.06	20.33	26.39	50.00	-23.61	AVG	
7	10.6300	24.73	20.33	45.06	60.00	-14.94	QP	
8	13.5980	8.66	20.28	28.94	50.00	-21.06	AVG	
9	13.6820	24.00	20.28	44.28	60.00	-15.72	QP	
10	16.4340	23.18	20.28	43.46	60.00	-16.54	QP	
11	19.8140	25.49	20.34	45.83	60.00	-14.17	QP	
12	22.1060	23.54	20.31	43.85	60.00	-16.15	QP	

4. Radiation Spurious Emission and Band Edge

4.1. Test Standard and Limit

Test Standard	FCC Part15 C Section 15.209 and 15.205				
Test Limit	Frequency (MHz)	Field strength (microvolt/meter)	Limit (dBuV/m)	Remark	Measurement distance (m)
	0.009MHz~0.490MHz	2400/F(kHz)	-	-	300
	0.490MHz-1.705MHz	24000/F(kHz)	-	-	30
	1.705MHz-30MHz	30	-	-	30
	30MHz~88MHz	100	40.0	Quasi-peak	3
	88MHz~216MHz	150	43.5	Quasi-peak	3
	216MHz~960MHz	200	46.0	Quasi-peak	3
	960MHz~1000MHz	500	54.0	Quasi-peak	3
	Above 1000MHz	500	54.0	Average	3
-		-	74.0	Peak	3

Remark:

- (1)The lower limit shall apply at the transition frequency.
- (2) 15.35(b), Unless otherwise specified, the limit on peak radio frequency emissions is 20dB above the maximum permitted average emission limit applicable to the equipment under test. This peak limit applies to the total peak emission level radiated by the device.

4.2. Test Setup

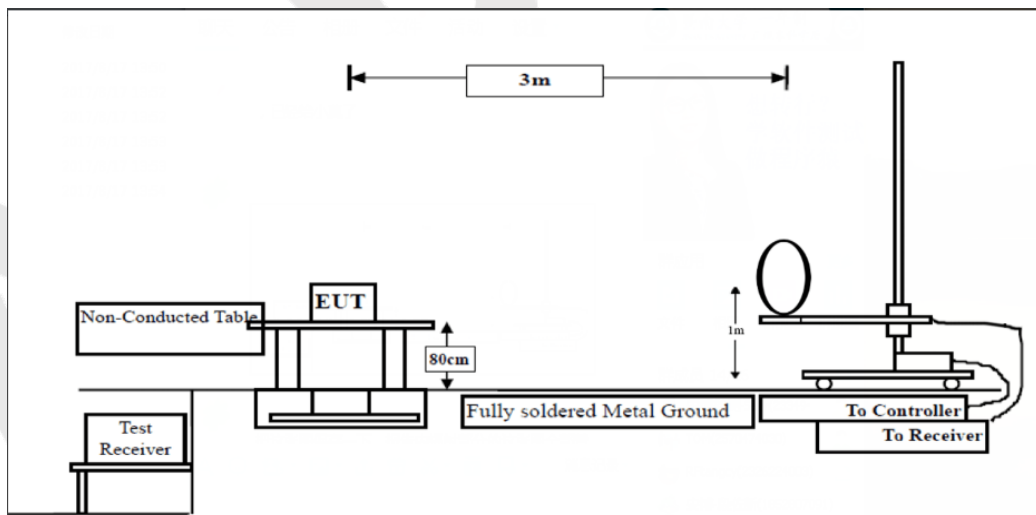

Figure 1. Below 30MHz

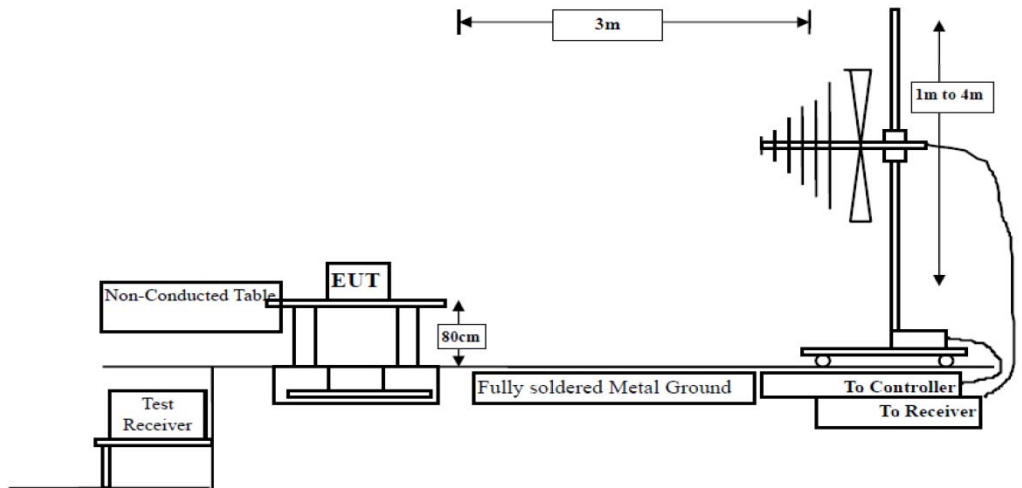

Figure 2. 30MHz to 1GHz

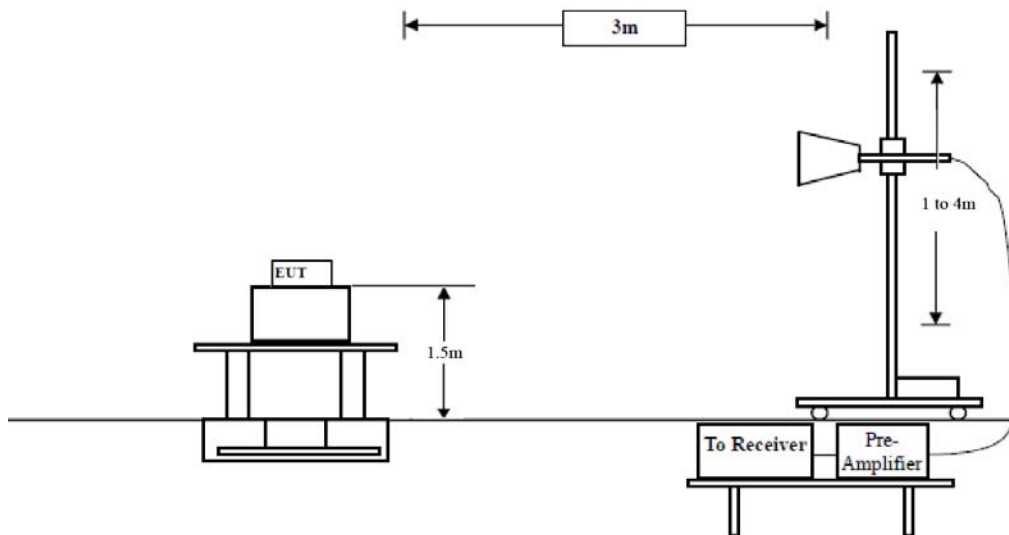

Figure 3. Above 1 GHz

4.3. Test Procedure

For below 1GHz: The EUT is placed on a turntable, which is 0.8m above the ground plane.

For above 1GHz: The EUT is placed on a turntable, which is 1.5m above the ground plane.

The turn table can rotate 360 degrees to determine the position of the maximum emission level. The EUT is set 3 meters away from the receiving antenna which is mounted on a antenna tower. The antenna can be moved up and down from 1 to 4 meters to find out the maximum emission level. Rotated the EUT through three orthogonal axes to determine the maximum emissions, both horizontal and vertical polarization of the antenna are set on test. The EUT is tested in 9*6*6 Chamber. The device is evaluated in xyz orientation.

For 9kHz to 150kHz, Set the spectrum analyzer as:

RBW = 200Hz, VBW =1kHz, Detector= Quasi-Peak, Trace mode= Max hold, Sweep- auto couple.

For 150kHz to 30MHz, Set the spectrum analyzer as:

RBW = 9KHz, VBW =30kHz, Detector= Quasi-Peak, Trace mode= Max hold, Sweep- auto couple.

For 30MHz to 1000MHz, Set the spectrum analyzer as:

RBW = 100kHz, VBW =300kHz,Detector= Quasi-Peak, Trace mode= Max hold, Sweep- auto couple.

For above 1GHz,Set the spectrum analyzer as:

RBW =1MHz, VBW =1MHz, Detector= Peak, Trace mode= Max hold, Sweep- auto couple.

RBW =1MHz, VBW =10Hz, Detector= Average, Trace mode= Max hold, Sweep- auto couple.

4.4. Test Data

PASS

During the test, Pre-scan all kind of the place mode (X-axis, Y-axis, Z-axis), and found the X-axis is the worst case.

The test results of 9kHz-30MHz and above 18000MHz are attenuated more than 20dB below the permissible limits, so the results don't record in the report.

Test Results (30~1000MHz)

Job No.: 0217080021W1 Temp.(°C)/Hum.(%RH): 24.3°C/55%RH
 Standard: FCC PART 15C Power Source: AC 120V/60Hz
 Test Mode: TX Mode Polarization: Horizontal

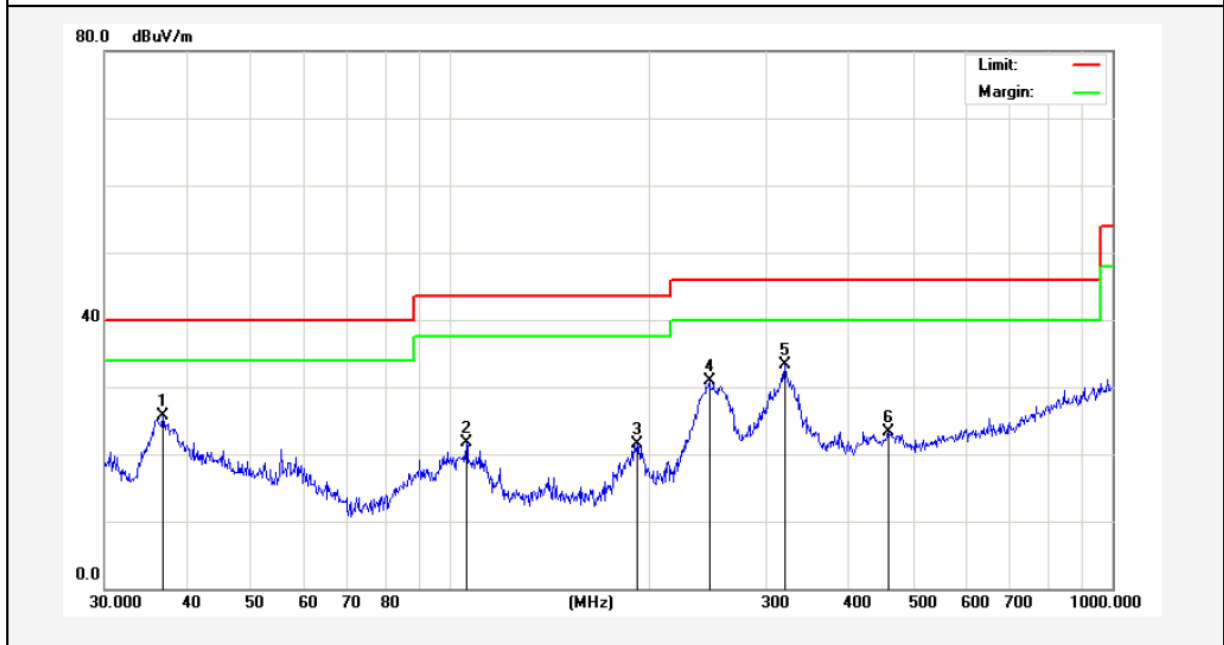

No.	Freq. (MHz)	Reading (dBuV/m)	Factor (dB/m)	Result (dBuV/m)	Limit (dBuV/)	Over Limit (dB)	Detector	Height (cm)	degree (deg)	Remark
1	36.7662	39.03	-13.25	25.78	40.00	-14.22	QP	300	17	
2	105.6415	42.48	-20.69	21.79	43.50	-21.71	QP	300	63	
3	191.0738	42.51	-20.92	21.59	43.50	-21.91	QP	300	101	
4	245.9509	49.31	-18.36	30.95	46.00	-15.05	QP	300	147	
5	319.9370	48.58	-15.27	33.31	46.00	-12.69	QP	300	201	
6	459.1143	35.46	-12.10	23.36	46.00	-22.64	QP	300	263	

Test Results (30~1000MHz)

Job No.: 0217080021W1 Temp.(°C)/Hum.(%RH): 24.3°C/55%RH
 Standard: FCC PART 15C Power Source: AC 120V/60Hz
 Test Mode: TX Mode Polarization: Vertical

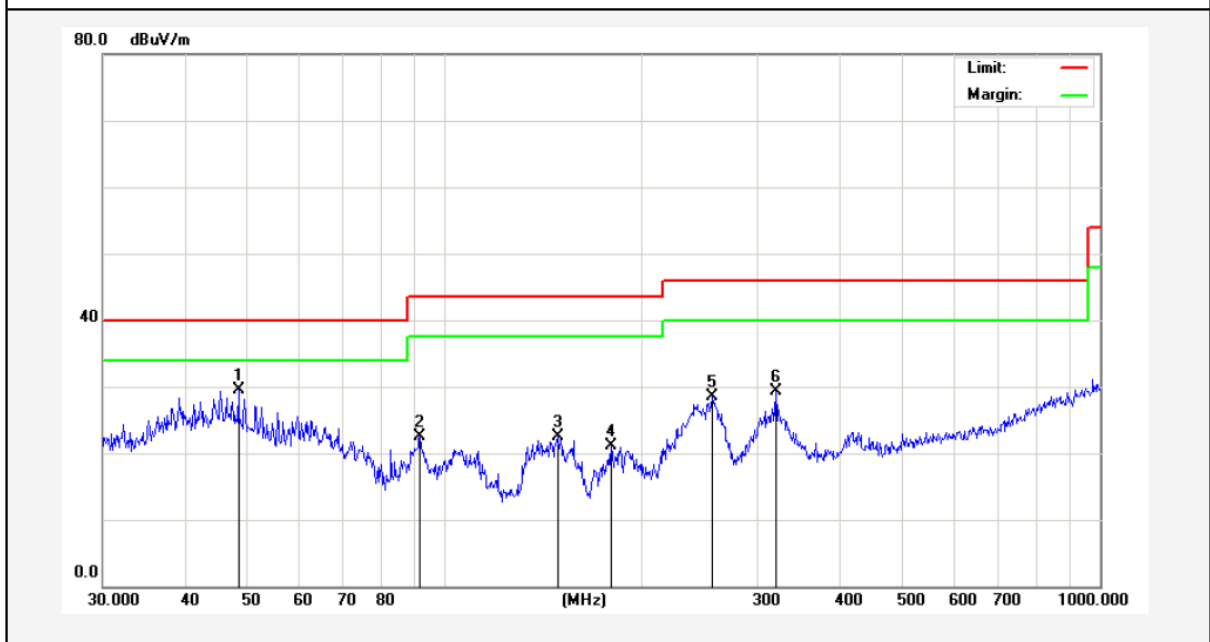

No.	Freq. (MHz)	Reading (dBuV/m)	Factor (dB/m)	Result (dBuV/m)	Limit (dBuV/)	Over Limit (dB)	Detector	Height (cm)	degree (deg)	Remark
1	48.3318	43.45	-13.91	29.54	40.00	-10.46	QP	300	17	
2	91.4949	39.92	-17.32	22.60	43.50	-20.90	QP	300	196	
3	148.4410	40.78	-18.36	22.42	43.50	-21.08	QP	300	156	
4	179.3863	37.99	-16.89	21.10	43.50	-22.40	QP	300	234	
5	255.6231	42.52	-14.02	28.50	46.00	-17.50	QP	300	63	
6	319.9370	43.59	-14.26	29.33	46.00	-16.67	QP	300	103	



Test Results (Above 1000MHz)

Test Mode: TX Mode					Test channel: Lowest			
Peak Value								
Frequency (MHz)	Read Level (dBuV)	Antenna Factor (dB/m)	Cable Loss (dB)	Preamp Factor (dB)	Level (dBuV/m)	Limit (dBuV/m)	Over Limit (dB)	Pol.
4804.00	38.26	34.04	6.58	34.09	44.79	74.00	-29.21	V
7206.00	32.47	37.11	7.73	34.50	42.81	74.00	-31.19	V
9608.00	32.04	39.31	9.23	34.79	45.79	74.00	-28.21	V
12010.00	*					74.00		V
14412.00	*					74.00		V
4804.00	42.75	34.04	6.58	34.09	49.28	74.00	-24.72	H
7206.00	34.31	37.11	7.73	34.50	44.65	74.00	-29.35	H
9608.00	31.55	39.31	9.23	34.79	45.30	74.00	-28.70	H
12010.00	*					74.00		H
14412.00	*					74.00		H
Average Value								
Frequency (MHz)	Read Level (dBuV)	Antenna Factor (dB/m)	Cable Loss (dB)	Preamp Factor (dB)	Level (dBuV/m)	Limit (dBuV/m)	Over Limit (dB)	Pol.
4804.00	26.90	34.04	6.58	34.09	33.43	54.00	-20.57	V
7206.00	21.04	37.11	7.73	34.50	31.38	54.00	-22.62	V
9608.00	20.06	39.31	9.23	34.79	33.81	54.00	-20.19	V
12010.00	*					54.00		V
14412.00	*					54.00		V
4804.00	31.23	34.04	6.58	34.09	37.76	54.00	-16.24	H
7206.00	23.28	37.11	7.73	34.50	33.62	54.00	-20.38	H
9608.00	19.87	39.31	9.23	34.79	33.62	54.00	-20.38	H
12010.00	*					54.00		H
14412.00	*					54.00		H

Test Results (Above 1000MHz)

Test Mode: TX Mode					Test channel: Middle			
Peak Value								
Frequency (MHz)	Read Level (dBuV)	Antenna Factor (dB/m)	Cable Loss (dB)	Preamp Factor (dB)	Level (dBuV/m)	Limit (dBuV/m)	Over Limit (dB)	Pol.
4880.00	36.92	34.38	6.69	34.09	43.90	74.00	-30.10	V
7320.00	31.57	37.22	7.78	34.53	42.04	74.00	-31.96	V
9760.00	31.24	39.46	9.35	34.80	45.25	74.00	-28.75	V
12200.00	*					74.00		V
14640.00	*					74.00		V
4880.00	41.12	34.38	6.69	34.09	48.10	74.00	-25.90	H
7320.00	33.29	37.22	7.78	34.53	43.76	74.00	-30.24	H
9760.00	30.62	39.46	9.35	34.80	44.63	74.00	-29.37	H
12200.00	*					74.00		H
14640.00	*					74.00		H
Average Value								
Frequency (MHz)	Read Level (dBuV)	Antenna Factor (dB/m)	Cable Loss (dB)	Preamp Factor (dB)	Level (dBuV/m)	Limit (dBuV/m)	Over Limit (dB)	Pol.
4880.00	25.82	34.38	6.69	34.09	32.80	54.00	-21.20	V
7320.00	20.31	37.22	7.78	34.53	30.78	54.00	-23.22	V
9760.00	19.41	39.46	9.35	34.80	33.42	54.00	-20.58	V
12200.00	*					54.00		V
14640.00	*					54.00		V
4880.00	30.00	34.38	6.69	34.09	36.98	54.00	-17.02	H
7320.00	22.46	37.22	7.78	34.53	32.93	54.00	-21.07	H
9760.00	19.11	39.46	9.35	34.80	33.12	54.00	-20.88	H
12200.00	*					54.00		H
14640.00	*					54.00		H

Test Results (Above 1000MHz)

Test Mode: TX Mode					Test channel: Highest			
Peak Value								
Frequency (MHz)	Read Level (dBuV)	Antenna Factor (dB/m)	Cable Loss (dB)	Preamp Factor (dB)	Level (dBuV/m)	Limit (dBuV/m)	Over Limit (dB)	Pol.
4960.00	36.49	34.72	6.79	34.09	43.91	74.00	-30.09	V
7440.00	31.29	37.34	7.82	34.57	41.88	74.00	-32.12	V
9920.00	30.99	39.62	9.46	34.81	45.26	74.00	-28.74	V
12400.00	*					74.00		V
14880.00	*					74.00		V
4960.00	40.61	34.72	6.79	34.09	48.03	74.00	-25.97	H
7440.00	32.97	37.34	7.82	34.57	43.56	74.00	-30.44	H
9920.00	30.33	39.62	9.46	34.81	44.60	74.00	-29.40	H
12400.00	*					74.00		H
14880.00	*					74.00		H
Average Value								
Frequency (MHz)	Read Level (dBuV)	Antenna Factor (dB/m)	Cable Loss (dB)	Preamp Factor (dB)	Level (dBuV/m)	Limit (dBuV/m)	Over Limit (dB)	Pol.
4960.00	25.52	34.72	6.79	34.09	32.94	54.00	-21.06	V
7440.00	20.11	37.34	7.82	34.57	30.70	54.00	-23.30	V
9920.00	19.23	39.62	9.46	34.81	33.50	54.00	-20.50	V
12400.00	*					54.00		V
14880.00	*					54.00		V
4960.00	29.67	34.72	6.79	34.09	37.09	54.00	-16.91	H
7440.00	22.24	37.34	7.82	34.57	32.83	54.00	-21.17	H
9920.00	18.90	39.62	9.46	34.81	33.17	54.00	-20.83	H
12400.00	*					54.00		H
14880.00	*					54.00		H

Remark:

1. Level =Receiver Read level + Antenna Factor + Cable Loss – Preamplifier Factor
2. “*”, means this data is the too weak instrument of signal is unable to test.

Radiated Band Edge:

Test Mode: GFSK					Test channel: Lowest			
Peak Value								
Frequency (MHz)	Read Level (dBuV)	Antenna Factor (dB/m)	Cable Loss (dB)	Preamp Factor (dB)	Level (dBuV/m)	Limit (dBuV/m)	Over Limit (dB)	Pol.
2390.00	46.68	29.15	3.41	34.01	45.23	74.00	-28.77	H
2400.00	64.01	29.16	3.43	34.01	62.59	74.00	-11.41	H
2390.00	47.59	29.15	3.41	34.01	46.14	74.00	-27.86	V
2400.00	66.45	29.16	3.43	34.01	65.03	74.00	-8.97	V
Average Value								
Frequency (MHz)	Read Level (dBuV)	Antenna Factor (dB/m)	Cable Loss (dB)	Preamp Factor (dB)	Level (dBuV/m)	Limit (dBuV/m)	Over Limit (dB)	Pol.
2390.00	36.37	29.15	3.41	34.01	34.92	54.00	-19.08	H
2400.00	47.83	29.16	3.43	34.01	46.41	54.00	-7.59	H
2390.00	36.58	29.15	3.41	34.01	35.13	54.00	-18.87	V
2400.00	44.84	29.16	3.43	34.01	43.42	54.00	-10.58	V

Test Mode: GFSK					Test channel: Highest			
Peak Value								
Frequency (MHz)	Read Level (dBuV)	Antenna Factor (dB/m)	Cable Loss (dB)	Preamp Factor (dB)	Level (dBuV/m)	Limit (dBuV/m)	Over Limit (dB)	Pol.
2483.50	49.23	29.28	3.53	34.03	48.01	74.00	-25.99	H
2500.00	47.68	29.30	3.56	34.03	46.51	74.00	-27.49	H
2483.50	50.71	29.28	3.53	34.03	49.49	74.00	-24.51	V
2500.00	49.04	29.30	3.56	34.03	47.87	74.00	-26.13	V
Average Value								
Frequency (MHz)	Read Level (dBuV)	Antenna Factor (dB/m)	Cable Loss (dB)	Preamp Factor (dB)	Level (dBuV/m)	Limit (dBuV/m)	Over Limit (dB)	Pol.
2483.50	39.24	29.28	3.53	34.03	38.02	54.00	-15.98	H
2500.00	36.70	29.30	3.56	34.03	35.53	54.00	-18.47	H
2483.50	40.77	29.28	3.53	34.03	39.55	54.00	-14.45	V
2500.00	36.94	29.30	3.56	34.03	35.77	54.00	-18.23	V

Remark:

- Level = Receiver Read level + Antenna Factor + Cable Loss – Pre-amplifier Factor

5. Maximum Peak Output Power Test

5.1. Test Standard and Limit

Test Standard	FCC Part15 C Section 15.247 (b)(3)
Test Limit	30dBm

5.2. Test Setup

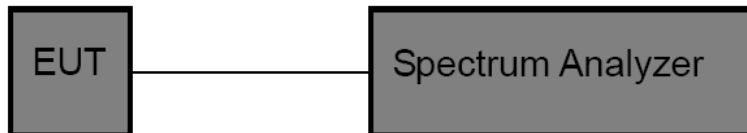

5.3. Test Procedure

This procedure shall be used when the measurement instrument has available a resolution bandwidth that is greater than the DTS bandwidth.

1. Set the RBW \geq DTS bandwidth.
2. Set the VBW \geq 3*RBW.
3. Set the span \geq 3*RBW.
4. Detector = peak.
5. Sweep time = auto couple.
6. Trace mode = max hold.
7. Allow trace to fully stabilize.
8. Use peak marker function to determine the peak amplitude level.

5.4. Test Data

Test Item	: Max. peak output power	Test Mode	: CH Low ~ CH High
Test Voltage	: AC 120V/60Hz	Temperature	: 24°C
Test Result	: PASS	Humidity	: 55%RH

Channel Frequency (MHz)	Peak Power output (dBm)	Limit (dBm)	Results
2402	1.021	30	PASS
2440	1.436	30	PASS
2480	1.732	30	PASS

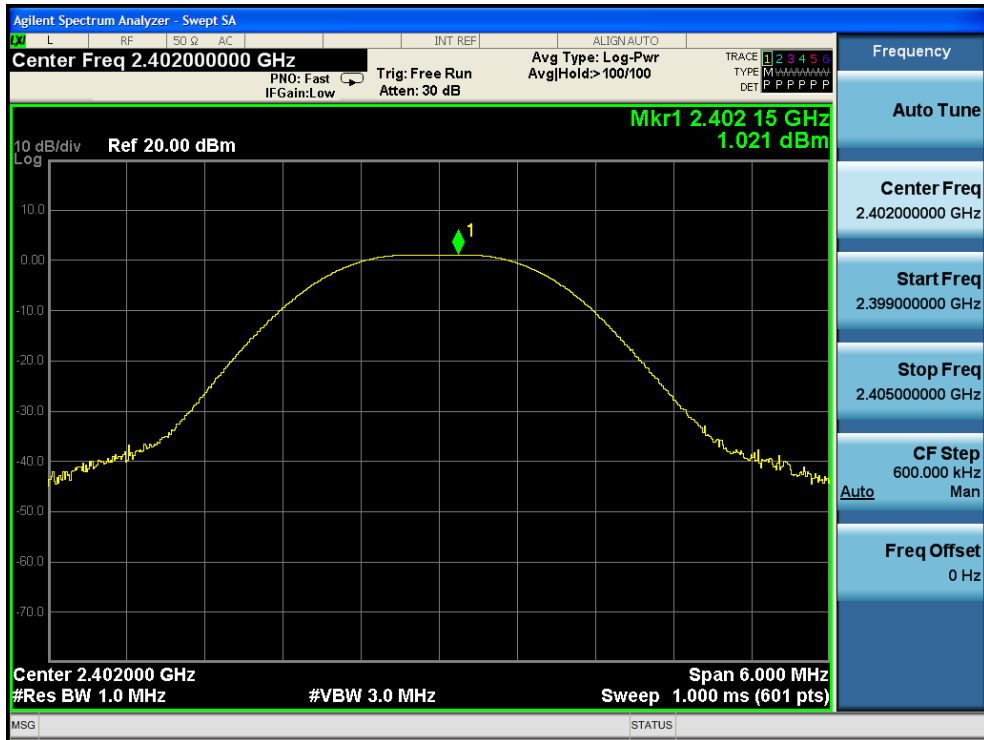

CH: Low

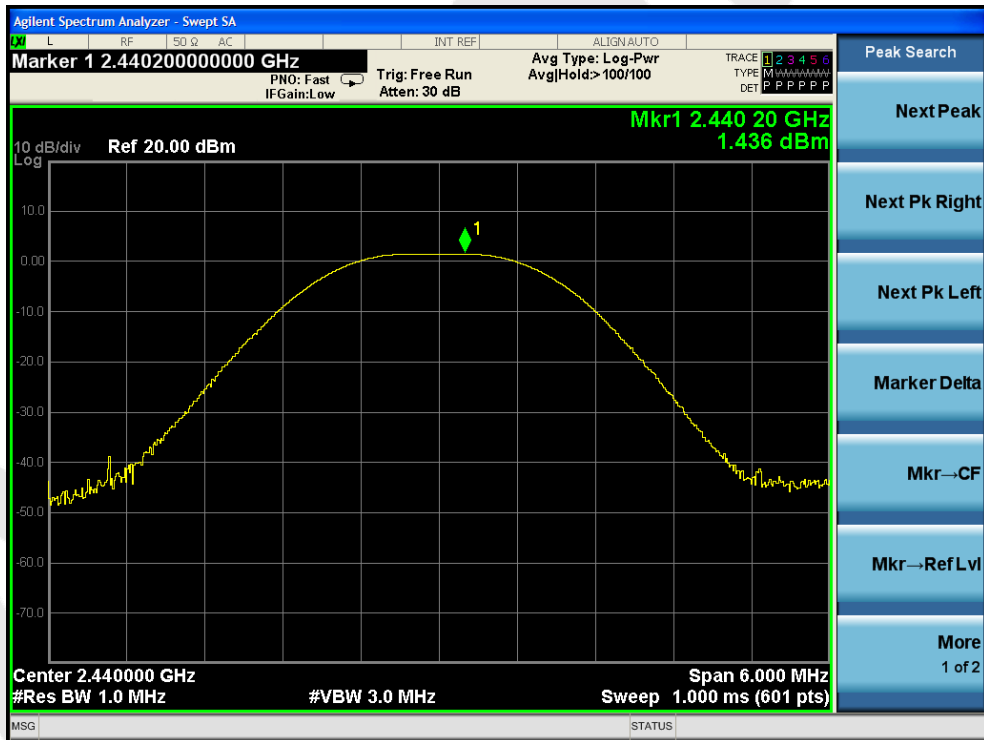

CH: Middle

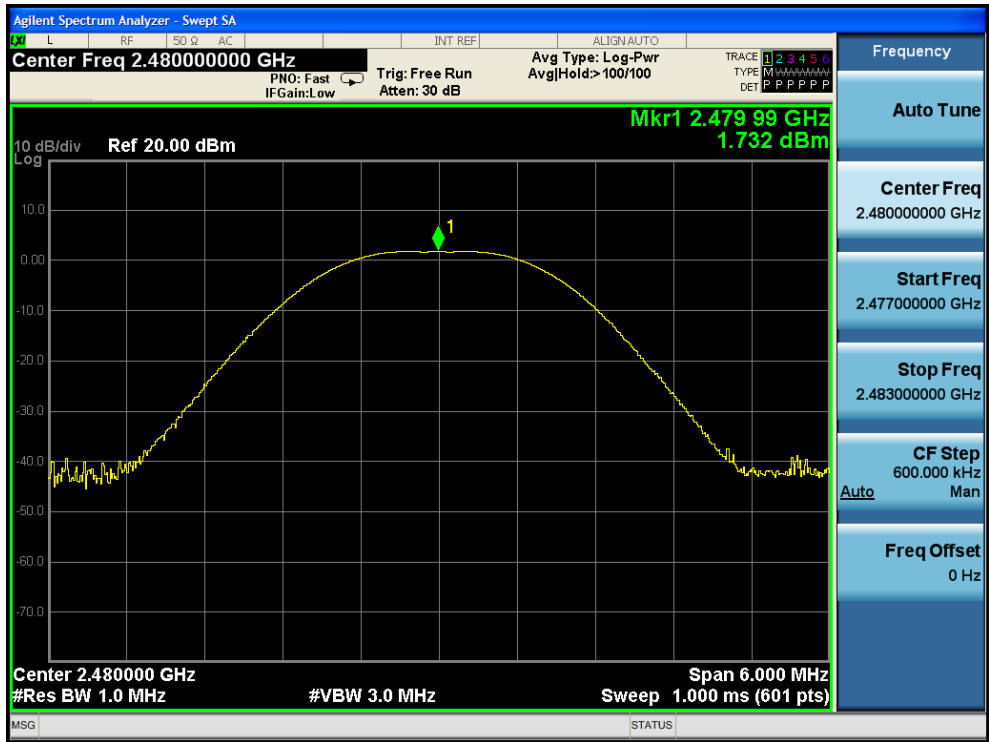

CH: High

6. 6dB Occupy Bandwidth Test

6.1. Test Standard and Limit

Test Standard	FCC Part15 C Section 15.247 (a)(2)
Test Limit	>500kHz

6.2. Test Setup

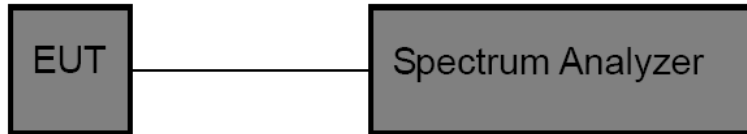

6.3. Test Procedure

1. Place the EUT on the table and set it in the transmitting mode.
2. Remove the antenna from the EUT and then connect a low loss RF cable from the antenna port to the spectrum analyzer.
3. Set the spectrum analyzer as:
 RBW = 100kHz, VBW \geq 3*RBW = 300kHz,
 Detector= Peak
 Trace mode= Max hold.
 Sweep- auto couple.
4. Mark the peak frequency and -6dB (upper and lower) frequency.
5. Repeat until all the rest channels are investigated.

6.4. Test Data

Test Item	: 6dB Bandwidth	Test Mode	: CH Low ~ CH High
Test Voltage	: AC 120V/60Hz	Temperature	: 24°C
Test Result	: PASS	Humidity	: 55%RH

Channel	Frequency(MHz)	Bandwidth (kHz)	Limit (kHz)	Results
Low	2402	666.0	>500	PASS
Middle	2440	663.6		PASS
High	2480	667.5		PASS

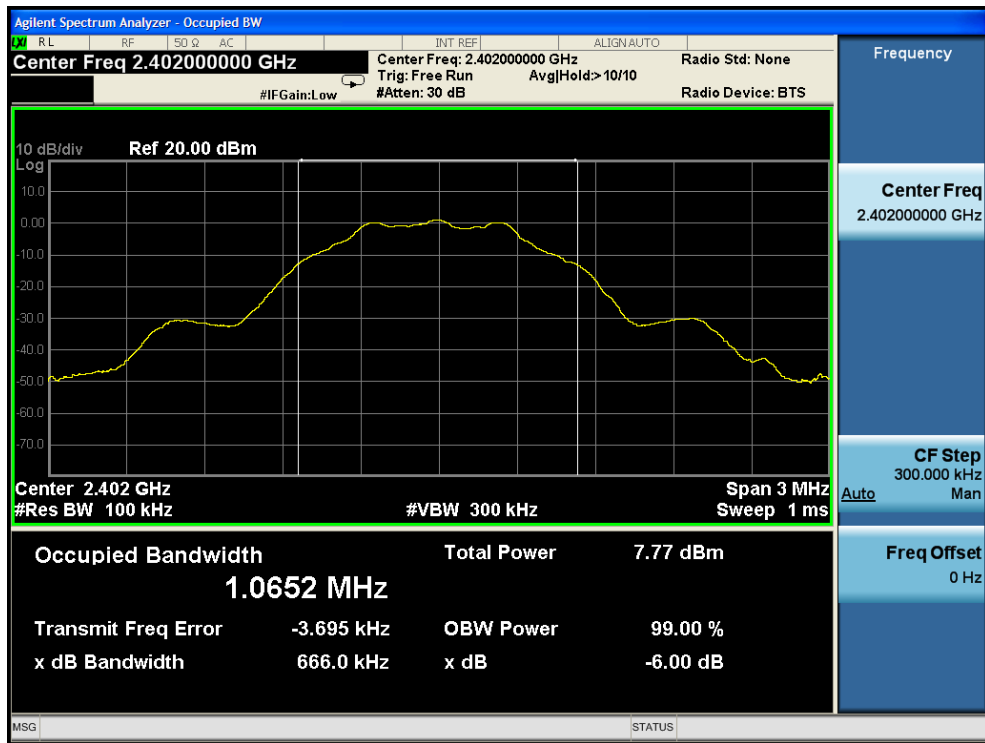

CH: Low

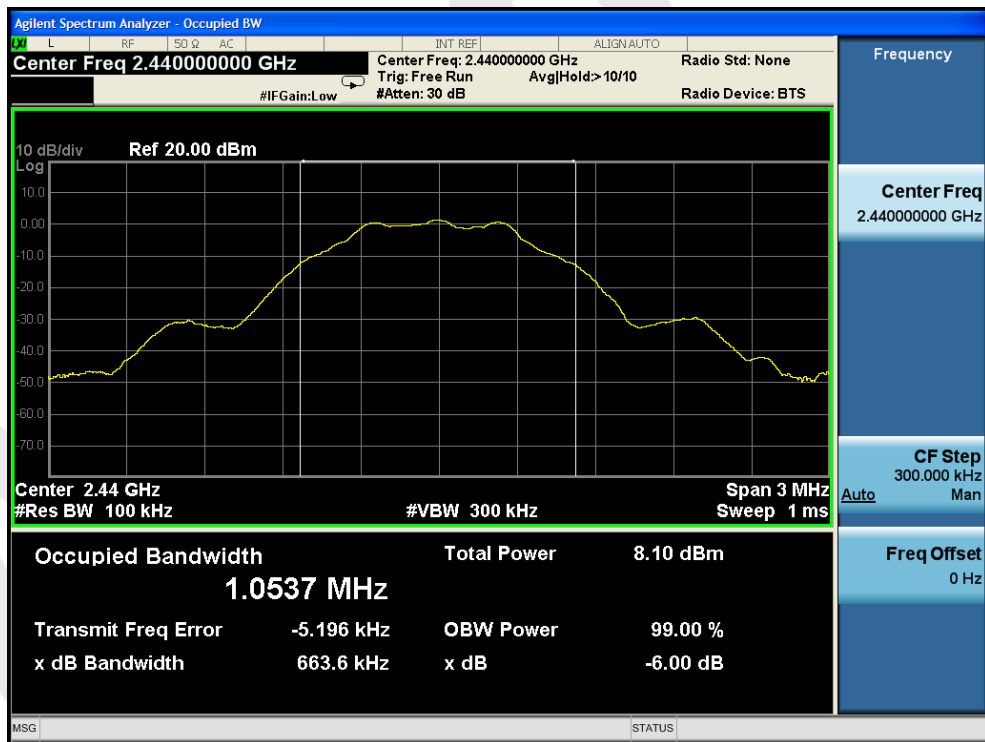

CH: Middle

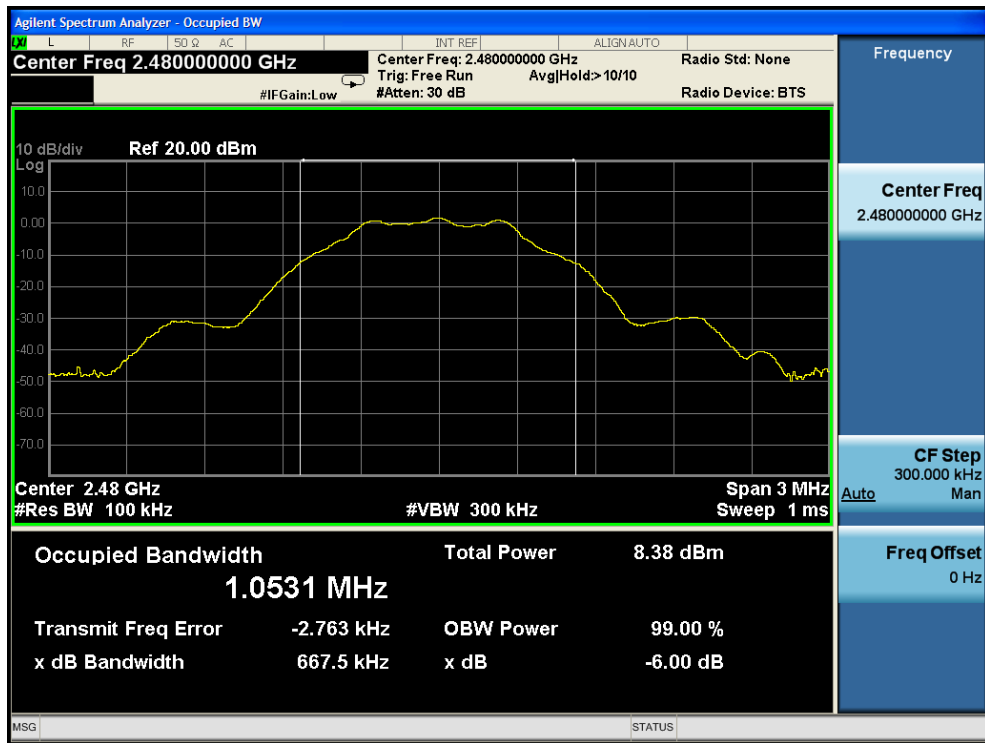

CH: High

7. Power Spectral Density Test

7.1. Test Standard and Limit

Test Standard	FCC Part15 C Section 15.247 (e)
Test Limit	8dBm

7.2. Test Setup

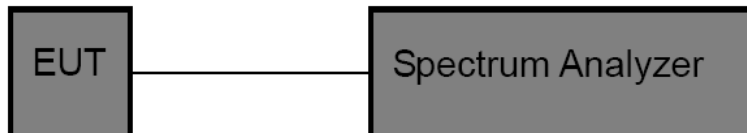

7.3. Test Procedure

1. Place the EUT on the table and set it in transmitting mode. Remove the antenna from the EUT and then connect a low loss RF cable from the antenna port to the spectrum analyzer.
2. Set the spectrum analyzer as RBW = 3kHz, VBW = 10kHz, Span = 1.5xDTS BW
3. Record the max. reading.
4. Repeat the above procedure until the measurements for all frequencies are completed.

7.4. Test Data

Test Item	: Power Spectral Density	Test Mode	: CH Low ~ CH High
Test Voltage	: AC 120V/60Hz	Temperature	: 24°C
Test Result	: PASS	Humidity	: 55%RH

Channel	Frequency (MHz)	PPSD (dBm/3KHz)	Limit (dBm/3KHz)	Results
Low	2402	-14.238	8.00	PASS
Middle	2440	-14.104	8.00	PASS
High	2480	-13.636	8.00	PASS

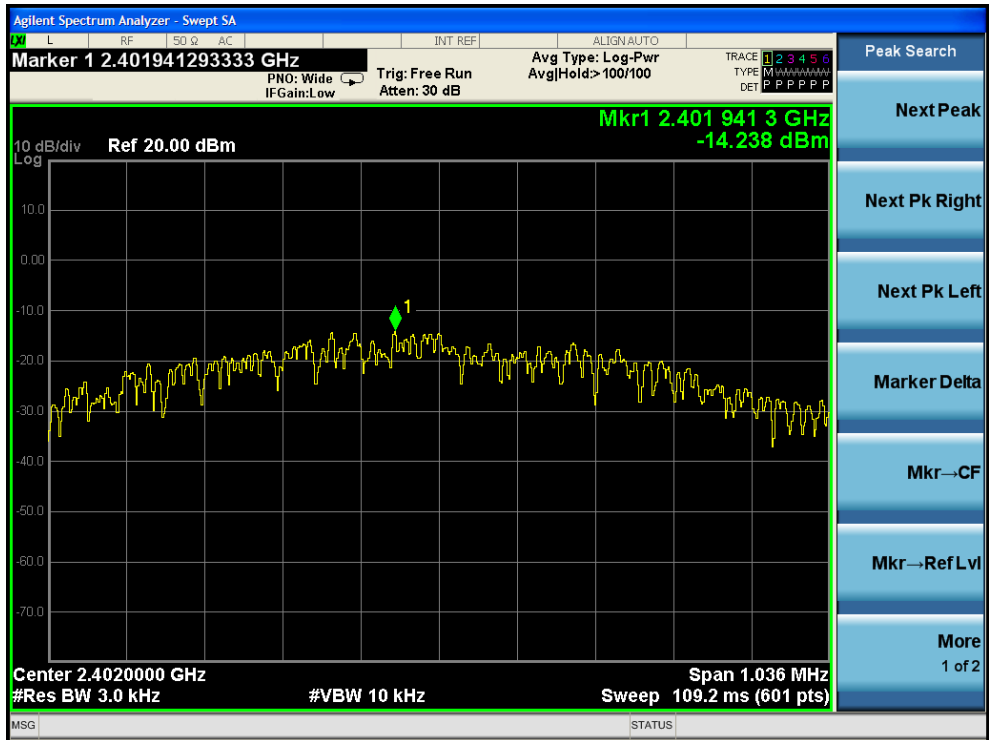

CH: Low



CH: Middle

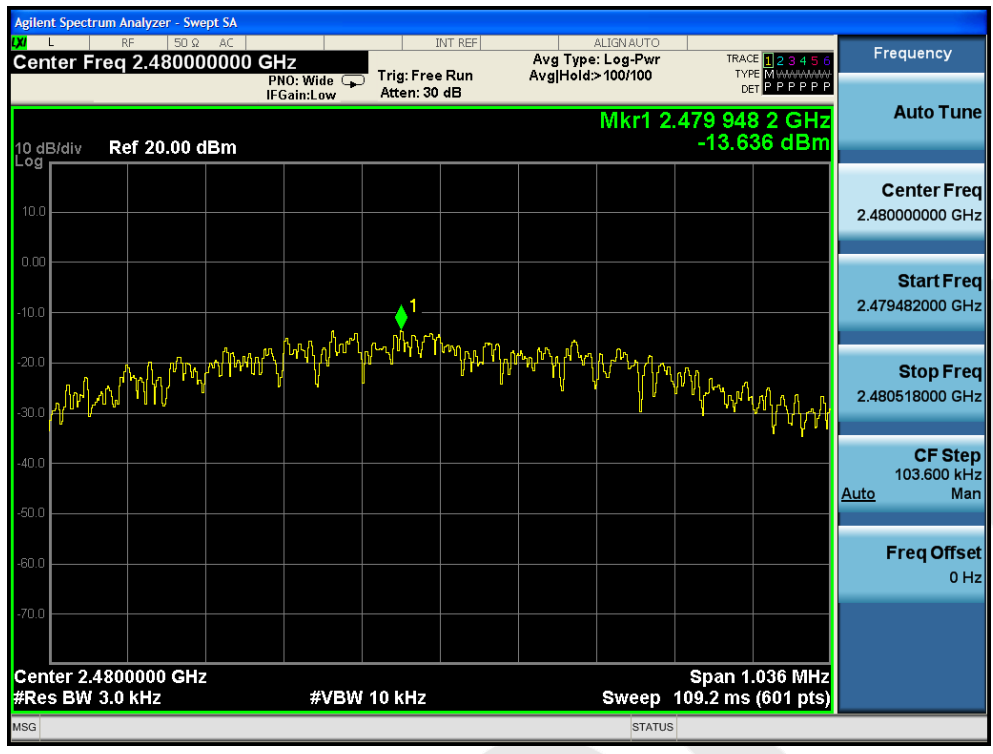

CH: High

8. 100kHz Bandwidth of Frequency Band Edge Requirement

8.1. Test Standard and Limit

Test Standard	FCC Part15 C Section 15.247 (d)
Test Limit	in any 100 kHz bandwidth outside the frequency bands in which the spread spectrum intentional radiator in operating, the radio frequency power that is produced by the intentional radiator shall be at least 20dB below that in the 100kHz bandwidth within the band that contains the highest level of the desired power, In addition, radiated emissions which fall in the restricted bands, as defined in §15.205(a), must also comply with the radiated emission limits specified in15.209(a).

8.2. Test Setup

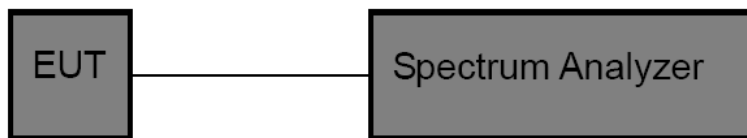

8.3. Test Procedure

Using the following spectrum analyzer setting:

1. Set the RBW = 100KHz.
2. Set the VBW = 300KHz.
3. Sweep time = auto couple.
4. Detector function = peak.
5. Trace mode = max hold.
6. Allow trace to fully stabilize.

8.4. Test Data

Test Item	: Band edge	Test Mode	: CH Low ~ CH High
Test Voltage	: AC 120V/60Hz	Temperature	: 24°C
Test Result	: PASS	Humidity	: 55%RH

Frequency Band (MHz)	Delta Peak toBand Emission (dBc)	Limit (dBc)	Results
2400	44.929	>20	PASS
2483.5	59.654	>20	PASS

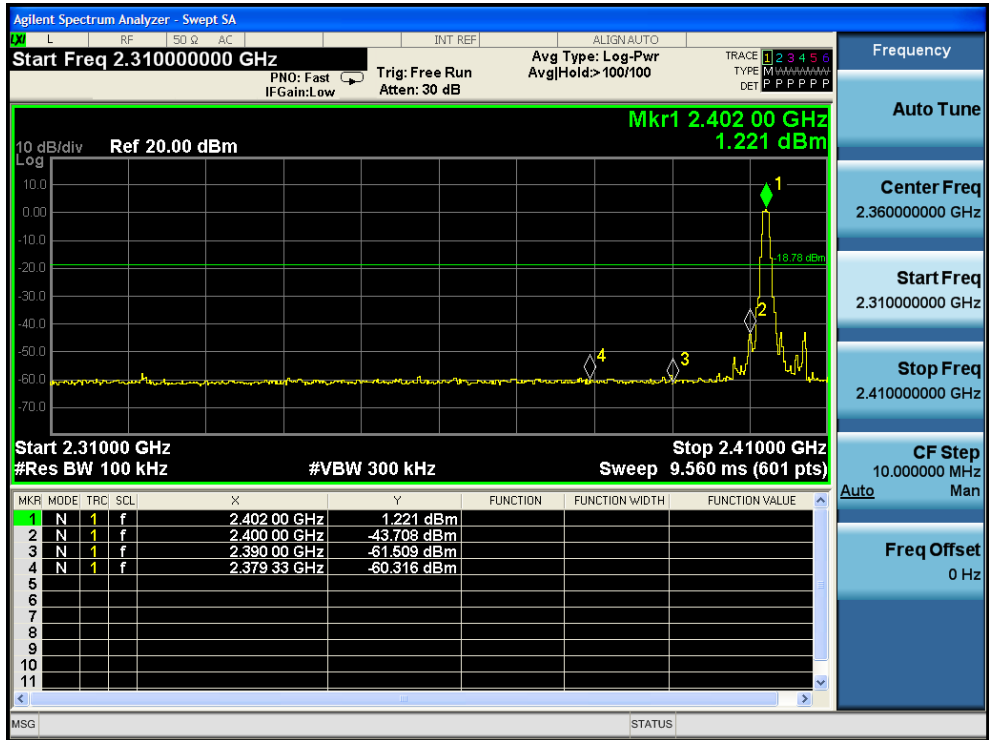

CH: Low

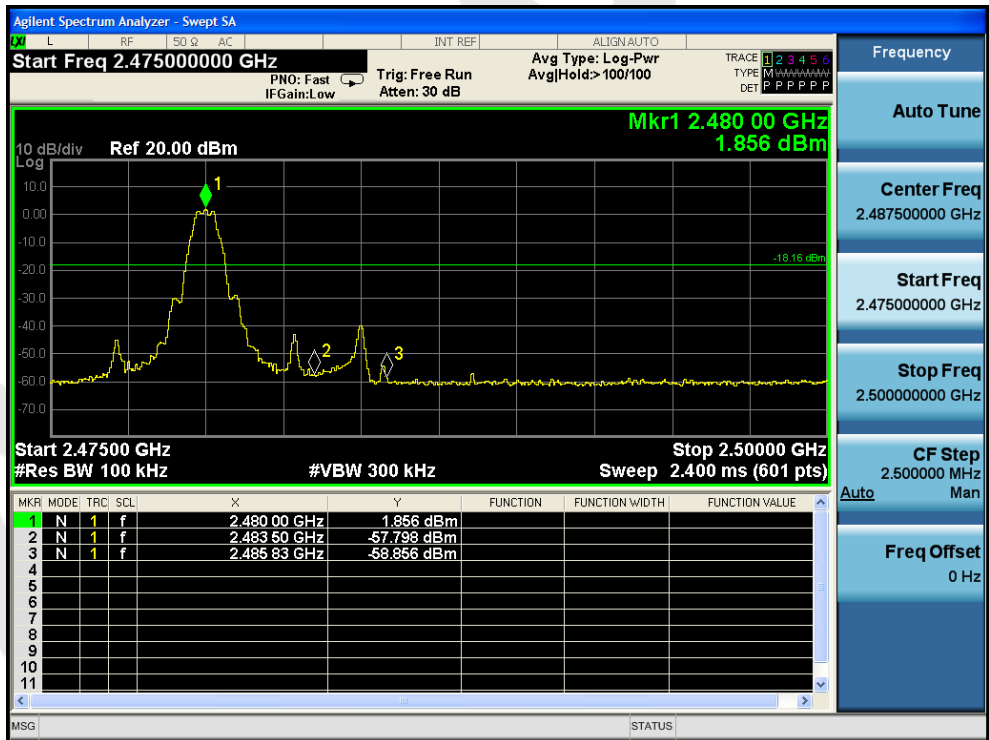

CH: High

Conducted Emission Method



CH: Low



CH: Middle



CH: High

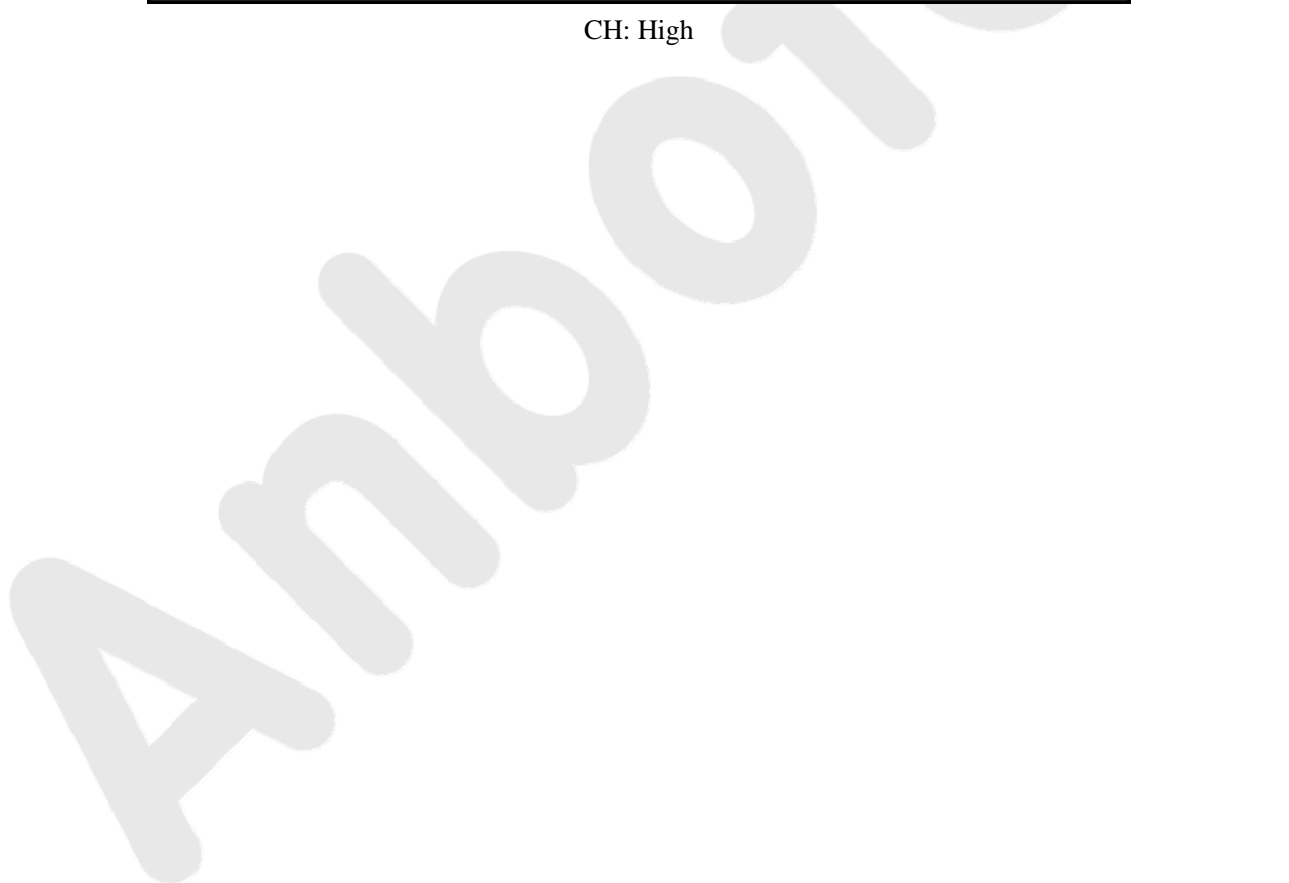

9. Antenna Requirement

9.1. Test Standard and Requirement

Test Standard	FCC Part15 Section 15.203 /247(c)
Requirement	<p>1) 15.203 requirement: An intentional radiator shall be designed to ensure that no antenna other than that furnished by the responsible party shall be used with the device. The use of a permanently attached antenna or of an antenna that uses a unique coupling to the intentional radiator, the manufacturer may design the unit so that a broken antenna can be replaced by the user, but the use of a standard antenna jack or electrical connector is prohibited.</p> <p>2) 15.247(c) (1)(i) requirement: Systems operating in the 2400-2483.5 MHz band that is used exclusively for fixed. Point-to-point operations may employ transmitting antennas with directional gain greater than 6dBi provided the maximum conducted output power of the intentional radiator is reduced by 1 dB for every 3 dB that the directional gain of the antenna exceeds 6 dBi.</p>

9.2. Antenna Connected Construction

The bluetooth antenna is a PCB antenna which permanently attached, and the best case gain of the antenna is 2.0 dBi. It complies with the standard requirement.

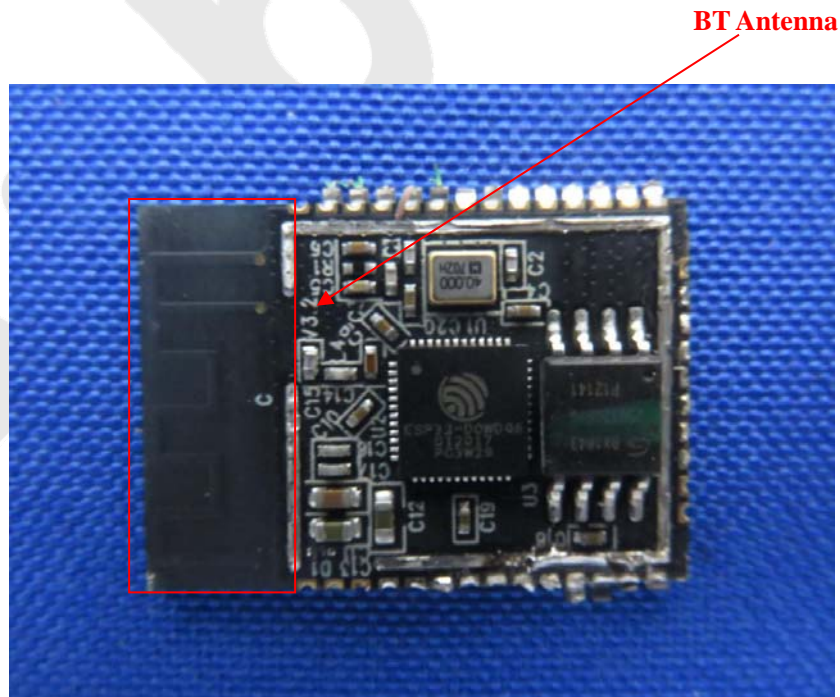

APPENDIX I -- TEST SETUP PHOTOGRAPH

Photo of Conducted Emission Test



Photo of Radiation Emission Test

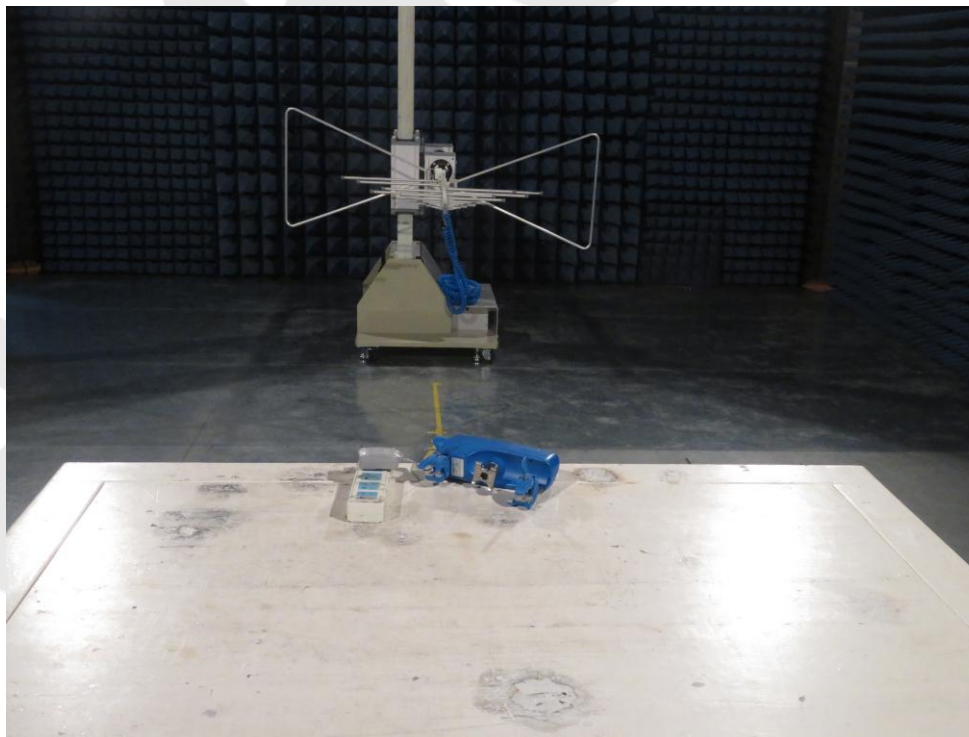

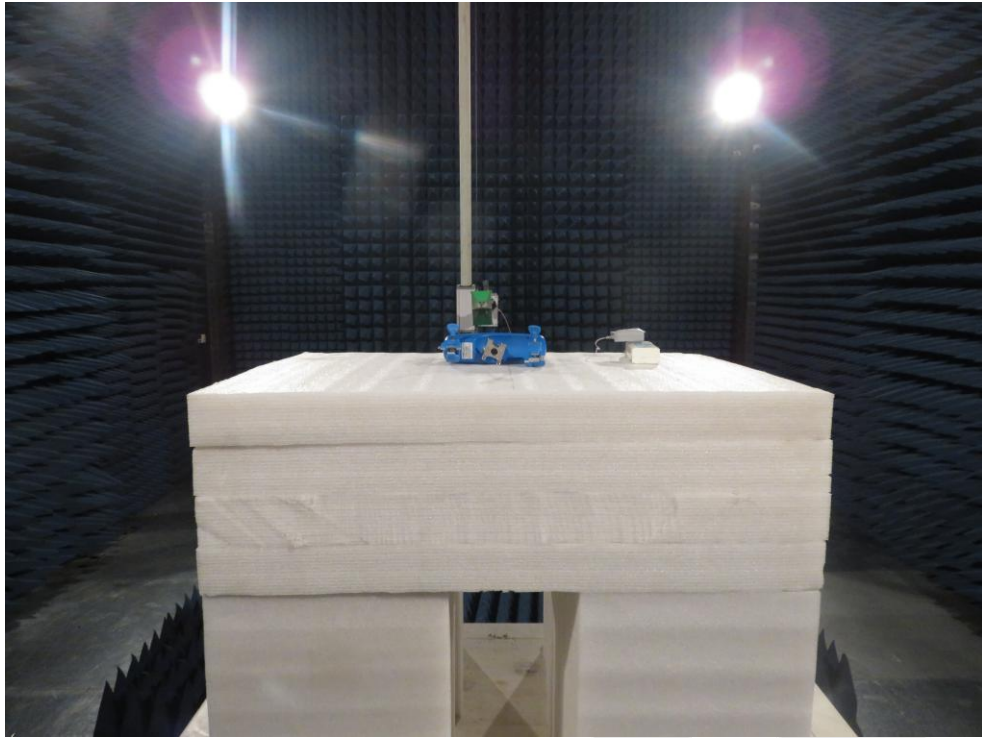

Anbotek

APPENDIX II -- EXTERNAL PHOTOGRAPH

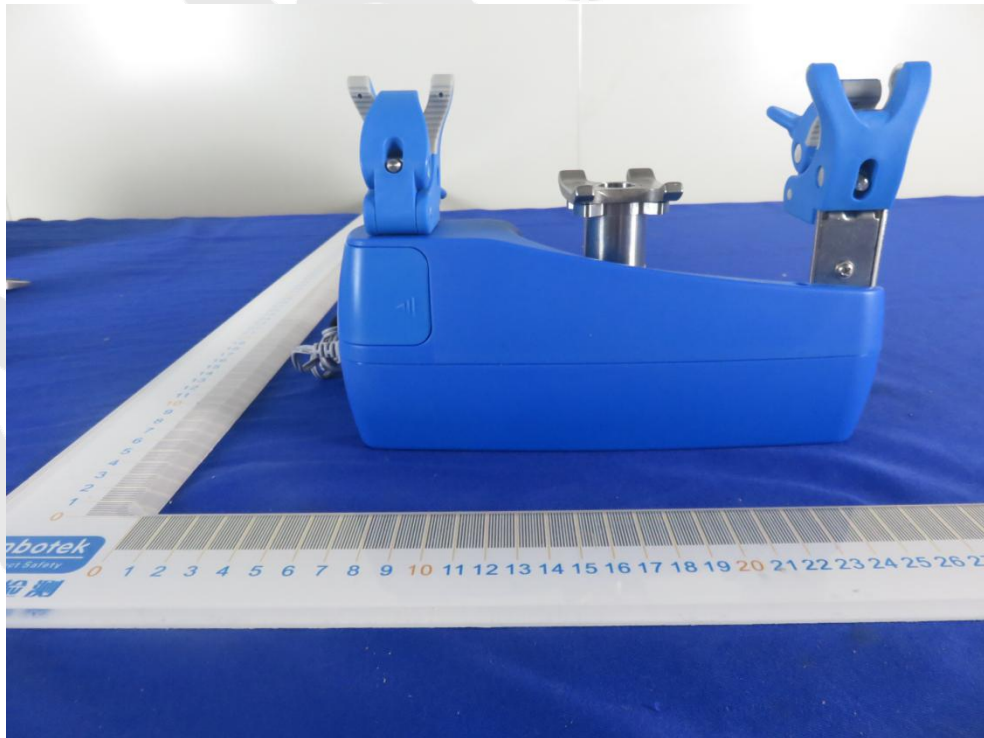

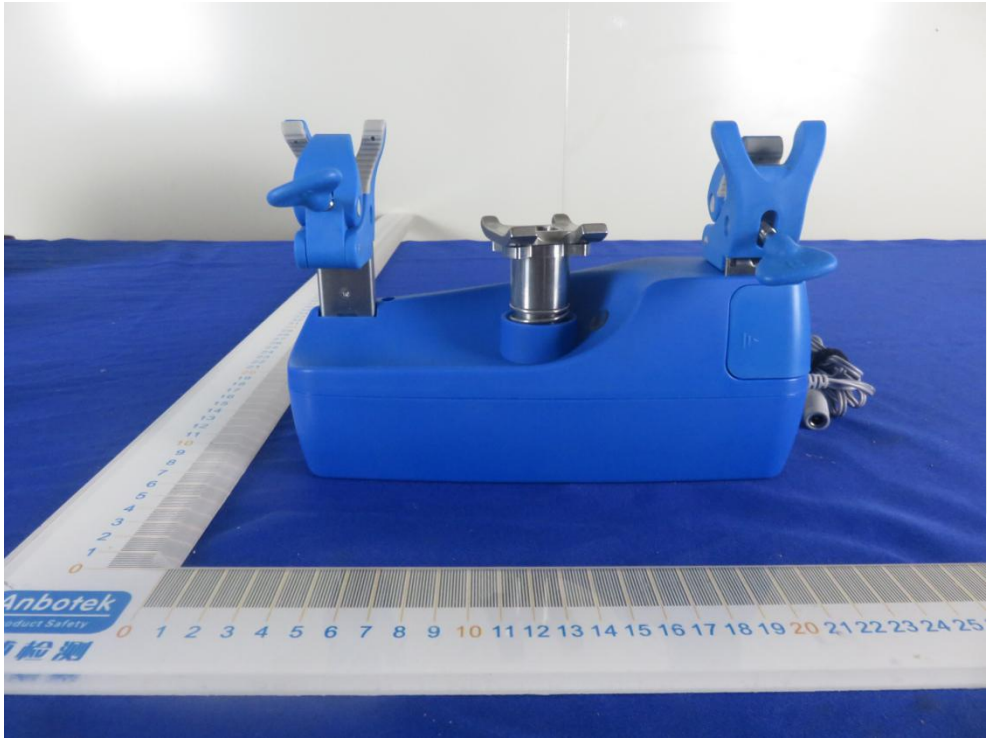

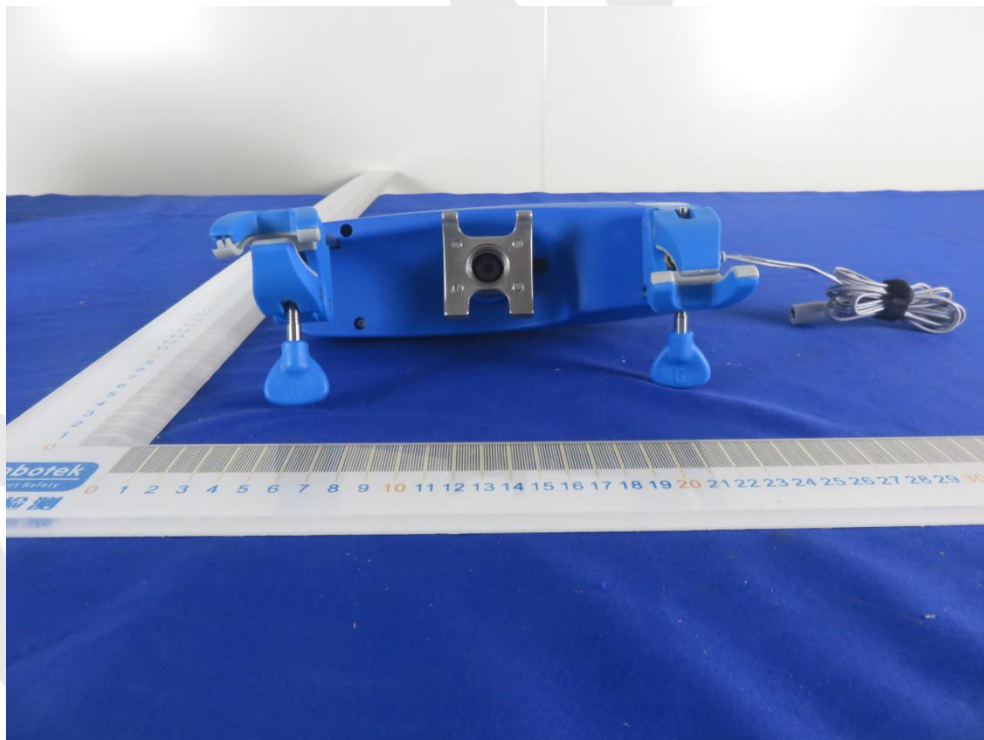

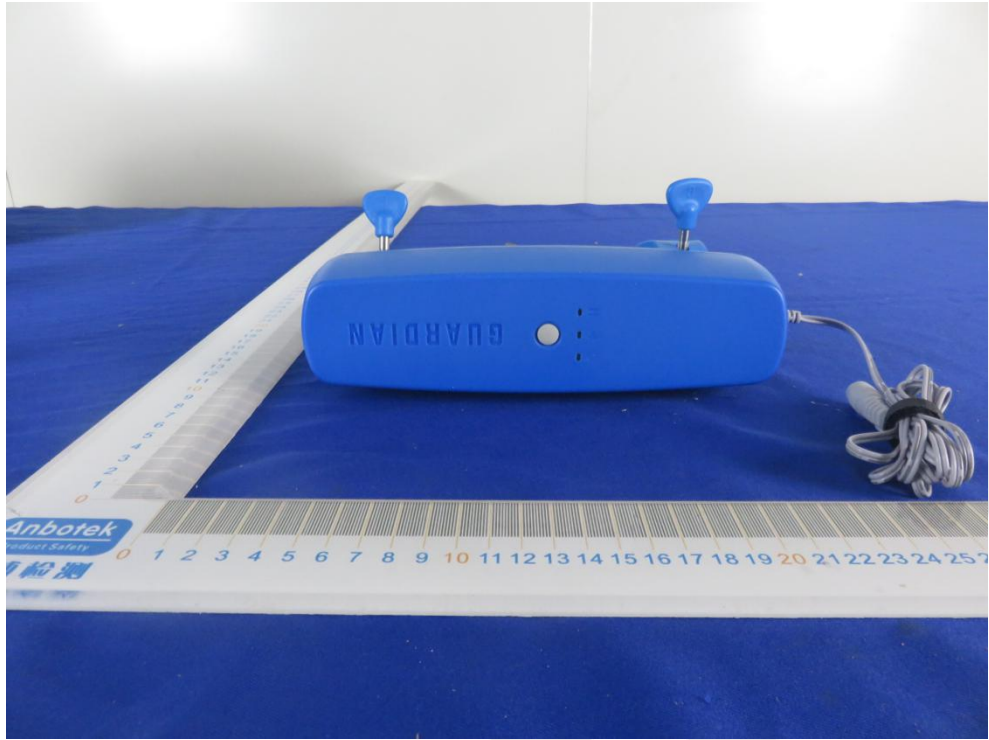

APPENDIX III -- INTERNAL PHOTOS

