



Hermon Laboratories Ltd.
P.O. Box 23, Binyamina 3055001, Israel
Tel. +972 4628 8001
Fax. +972 4628 8277
E-mail: mail@hermonlabs.com

TEST REPORT

ACCORDING TO:

FCC 47CFR part 15 subpart C §15.247 (FHSS) and subpart B,
RSS-247 Issue 2:2017, RSS-Gen Issue 5:2018, ICES-003 Issue 6:2016

FOR:

ARAD TECHNOLOGIES

Water meter

Model: INTERPRETER5

FCC ID: VIDINTRLG5

IC: 10232A-INTERLG5

This report is in conformity with ISO/IEC 17025. The "A2LA Accredited" symbol endorsement applies only to the tests and calibrations that are listed in the scope of Hermon Laboratories accreditation. The test results relate only to the items tested. This test report shall not be reproduced in any form except in full with the written approval of Hermon Laboratories Ltd.

Table of contents

1	Applicant information	3
2	Equipment under test attributes	3
3	Manufacturer information	3
4	Test details	3
5	Tests summary	4
6	EUT description	6
6.1	General information	6
6.2	Test configuration	6
6.3	Transmitter characteristics	7
7	Transmitter tests according to 47CFR part 15 subpart C and RSS-247 requirements	8
7.1	20 dB bandwidth	8
7.2	Carrier frequency separation	16
7.3	Number of hopping frequencies	19
7.4	Average time of occupancy	22
7.5	Peak output power	25
7.6	Field strength of spurious emissions	33
7.7	Band edge radiated emissions	47
7.8	Antenna requirements	55
8	Unintentional emissions according to 47CFR part 15 subpart B	56
8.1	Radiated emission measurements	56
9	APPENDIX B Test equipment and ancillaries used for tests	59
10	APPENDIX C Test equipment correction factors	60
11	APPENDIX A Test laboratory description	64
12	APPENDIX D Measurement uncertainties	65
13	APPENDIX E Specification references	66
14	APPENDIX F Abbreviations and acronyms	67



1 Applicant information

Client name: ARAD TECHNOLOGIES
Address: POB 537, HaMada 4, Yokneam Ind. Zone, Yokneam Ilit 20692, Israel
Telephone: 04-9935222 Ext.277
Fax: 04-9935227
E-mail: viorel.negreanu@aradtec.com
Contact name: Mr.Vily Negreanu

2 Equipment under test attributes

Product name: Water meter
Product type: Transceiver
Model(s): INTERPRETER5
Serial number: 18M00A34E2
Hardware version: P4
Software release: 07.02/08.02
Receipt date 26-Dec-18

3 Manufacturer information

Manufacturer name: ARAD TECHNOLOGIES
Address: POB 537, HaMada 4, Yokneam Ind. Zone, Yokneam Ilit 20692, Israel
Telephone: 04-9935222 Ext.277
Fax: 04-9935227
E-Mail: viorel.negreanu@aradtec.com
Contact name: Mr.Vily Negreanu

4 Test details

Project ID: 32166
Location: Hermon Laboratories Ltd. P.O. Box 23, Binyamina 3055001, Israel
Test started: 30-Jan-19
Test completed: 10-Jun-19
Test specification(s): FCC 47CFR part 15 subpart C §15.247 (FHSS) and subpart B
RSS-247 Issue 2:2017, RSS-Gen Issue 5:2018, ICES-003 Issue 6:2016

5 Tests summary



Test	Status
Transmitter characteristics	
Section 15.247(a)1 / RSS-247 section 5.1(c), 20 dB bandwidth	Pass
Section 15.247(b) / RSS-247 section 5.4(a), Peak output power	Pass
Section 15.247(c) / RSS-247 section 5.5, Radiated spurious emissions	Pass
Section 15.247(a)1 / RSS-247 section 5.1(b), Frequency separation	Pass
Section 15.247(a)1 / RSS-247 section 5.1(c), Number of hopping frequencies	Pass
Section 15.247(a)1 / RSS-247 section 5.1(c), Average time of occupancy	Pass
Section 15.247(b)5, RF exposure	Pass*
Section 15.247(c) / RSS-247 section 5.5, Emissions at band edges	Pass
Section 15.203 / RSS Gen Section 6.8, Antenna requirements	Pass
Section 15.207(a), Conducted emission	Not required
Unintentional emissions	
Section 15.107, Conducted emission at AC power port	Not required
Section 15.109 / ICES-003 , section 6.2, Radiated emission	Pass

* Pass, the exhibit to the application of certification is provided.

This test report supersedes the previously issued test report identified by Doc ID: ARARAD_FCC.32166_Int_Rev3

Testing was completed against all relevant requirements of the test standard. The results obtained indicate that the product under test complies in full with the requirements tested.

The test results relate only to the items tested. Pass/ fail decision was based on nominal values.

	Name and Title	Date	Signature
Tested by:	Mr. A. Morozov test engineer EMC & Radio Mrs. E. Pitt test engineer EMC & Radio	30-Jan-19 – 10-Jun-19	 
Reviewed by:	Mrs. S Peysahov Sheynin test engineer EMC & Radio	01-Aug-19 – 16-Aug-19	



HERMON LABORATORIES

Approved by:	Mr. S. Samokha, technical manager, EMC and Radio	18-Aug-19	
---------------------	--	-----------	---

6 EUT description

Note: The following data in this clause is provided by the customer and represents his sole responsibility

6.1 General information

Measurement head with embedded radio and antenna. Unit can be attached to various devices that create rotating magnetic field in case of water flow. The Measurement head senses the magnetic field, decodes the read and sends it to the network.

The device has basically 2 modes of operation –

1. “Network mode” – in this mode unit is connected to the network and should meet FCC part 15.247.
2. Technician mode –
 - a. Unit operated by a technician.
 - b. Unit works at single channel.

For the technician mode, unit should meet FCC part 15.249.

This test report is provided to support certification per FCC part 15 subpart C section 15.247.

6.2 Test configuration

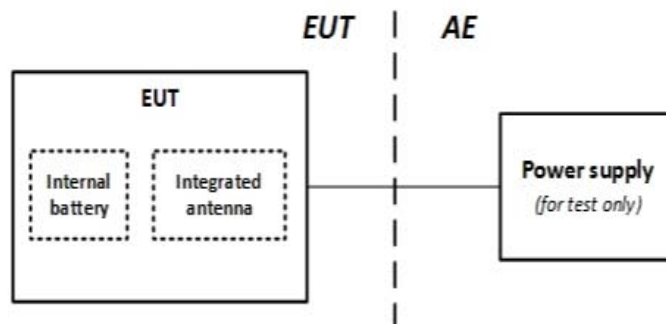



6.3 Transmitter characteristics

Type of equipment				
X	Stand-alone (Equipment with or without its own control provisions)			
	Combined equipment (Equipment where the radio part is fully integrated within another type of equipment)			
	Plug-in card (Equipment intended for a variety of host systems)			
Intended use		Condition of use		
	fixed	Always at a distance more than 2 m from all people		
X	mobile	Always at a distance more than 20 cm from all people		
	portable	May operate at a distance closer than 20 cm to human body		
Assigned frequency ranges		902 – 928 MHz		
Operating frequencies		902.3 – 927.8 MHz for 2FSK 903.8 – 927.4 MHz for GFSK		
Maximum rated output power		At transmitter 50 Ω RF output connector		
		Peak output power		
		28.24 dBm for 2FSK 9.6 kbps		
		28.51 dBm for 2FSK 19.2 kbps		
		27.99 dBm for 2FSK 38.4 kbps		
		29.39 dBm for GFSK 50.0 kbps		
Is transmitter output power variable?		X	No	
			Yes	
			continuous variable	
			stepped variable with stepsize	dB
			minimum RF power	dBm
	maximum RF power	dBm		
Antenna connection				
unique coupling	standard connector	X	integral	
			with temporary RF connector	
		X	without temporary RF connector	
Antenna/s technical characteristics				
Type	Manufacturer	Model number	Gain	
Integrated	AT	NA	0 dBi	
Type of modulation / data rate		2FSK 9.6 kbps 2FSK 19.2 kbps 2FSK 38.4 kbps GFSK 50.0 kbps		
Modulating test signal (baseband)		PRBS		
Transmitter power source				
X	Battery	Nominal rated voltage	3.6 V	
	DC	Nominal rated voltage		
	AC mains	Nominal rated voltage		
		Frequency		
Common power source for transmitter and receiver		X	yes	
			no	
Spread spectrum technique used		X	Frequency hopping (FHSS)	
			Digital transmission system (DTS)	
			Hybrid	
Spread spectrum parameters for transmitters tested per FCC 15.247 only				
FHSS	Total number of hops	256 for 2FSK 60 for GFSK		
	Bandwidth per hop	22.552 kHz for 2FSK 9.6 kbps 42.42 kHz for 2FSK 19.2 kbps 88.836 kHz for 2FSK 38.4 kbps 96.481 kHz for GFSK 50.0 kbps		
	Max. separation of hops	101.9 kHz for 2FSK 400.0 kHz for GFSK		



Test specification: Section 15.247(a)(1), RSS-247 section 5.1(c) 20 dB bandwidth			
Test procedure: ANSI C63.10 section 7.8.7			
Test mode: Compliance		Verdict: PASS	
Date(s): 06-Jun-19			
Temperature: 24 °C	Relative Humidity: 46 %	Air Pressure: 1012 hPa	Power: 3.6 VDC
Remarks:			

7 Transmitter tests according to 47CFR part 15 subpart C and RSS-247 requirements

7.1 20 dB bandwidth

7.1.1 General

This test was performed to measure the 20 dB bandwidth of the transmitter hopping channel. Specification test limits are given in Table 7.1.1.

Table 7.1.1 The 20 dB bandwidth limits

Assigned frequency, MHz	Maximum bandwidth, kHz	Modulation envelope reference points*, dBc
902.0 – 928.0	250	20
2400.0 – 2483.5	NA	
5725.0 – 5850.0	1000	

* - Modulation envelope reference points provided in terms of attenuation below the peak of modulated carrier.

7.1.2 Test procedure

7.1.2.1 The EUT was set up as shown in Figure 7.1.1, energized and its proper operation was checked.

7.1.2.2 The EUT was set to transmit modulated carrier at maximum data rate.

7.1.2.3 The transmitter bandwidth was measured with spectrum analyzer as frequency delta between reference points on modulation envelope and provided in Table 7.1.2 and associated plot.

7.1.2.4 The test was repeated for each data rate and each modulation format.

Figure 7.1.1 The 20 dB bandwidth test setup





Test specification: Section 15.247(a)(1), RSS-247 section 5.1(c) 20 dB bandwidth			
Test procedure: ANSI C63.10 section 7.8.7			
Test mode: Compliance		Verdict: PASS	
Date(s): 06-Jun-19			
Temperature: 24 °C	Relative Humidity: 46 %	Air Pressure: 1012 hPa	Power: 3.6 VDC
Remarks:			

Table 7.1.2 The 20 dB bandwidth test results

ASSIGNED FREQUENCY BAND: 902.0 – 928.0 MHz
 DETECTOR USED: Peak
 SWEEP TIME: Auto
 VIDEO BANDWIDTH: ≥ RBW
 MODULATION ENVELOPE REFERENCE POINTS: 20.0 dBc
 MODULATING SIGNAL: PRBS
 FREQUENCY HOPPING: Disabled

Carrier frequency, MHz	Type of modulation	Data rate, kbps	Symbol rate, Msymbols/s	20 dB bandwidth, kHz	Limit, kHz	Margin, kHz	Verdict
902.3	2FSK	9.6	NA	22.225	250	-227.775	Pass
		19.2		41.948	250	-208.052	Pass
		38.4		88.836	250	-161.164	Pass
915.0	2FSK	9.6	NA	22.552	250	-227.448	Pass
		19.2		42.420	250	-207.580	Pass
		38.4		88.605	250	-161.395	Pass
927.8	2FSK	9.6	NA	22.430	250	-227.570	Pass
		19.2		41.977	250	-208.023	Pass
		38.4		88.265	250	-161.735	Pass

ASSIGNED FREQUENCY BAND: 902.0 – 928.0 MHz
 DETECTOR USED: Peak
 SWEEP TIME: Auto
 VIDEO BANDWIDTH: ≥ RBW
 MODULATION ENVELOPE REFERENCE POINTS: 20.0 dBc
 MODULATING SIGNAL: PRBS
 FREQUENCY HOPPING: Disabled

Carrier frequency, MHz	Type of modulation	Data rate, kbps	Symbol rate, Msymbols/s	20 dB bandwidth, kHz	Limit, kHz	Margin, kHz	Verdict
903.8	GFSK	50	NA	91.225	250	-158.775	Pass
915.0	GFSK	50	NA	91.353	250	-158.647	Pass
927.4	GFSK	50	NA	96.481	250	-153.519	Pass

Reference numbers of test equipment used

HL 0337	HL 2909	HL 4136					
---------	---------	---------	--	--	--	--	--

Full description is given in Appendix A.



Test specification: Section 15.247(a)(1), RSS-247 section 5.1(c) 20 dB bandwidth			
Test procedure: ANSI C63.10 section 7.8.7			
Test mode: Compliance		Verdict: PASS	
Date(s): 06-Jun-19			
Temperature: 24 °C	Relative Humidity: 46 %	Air Pressure: 1012 hPa	Power: 3.6 VDC
Remarks:			

Plot 7.1.1 The 20 dB bandwidth test result at low frequency with 2FSK 9.6 kbps

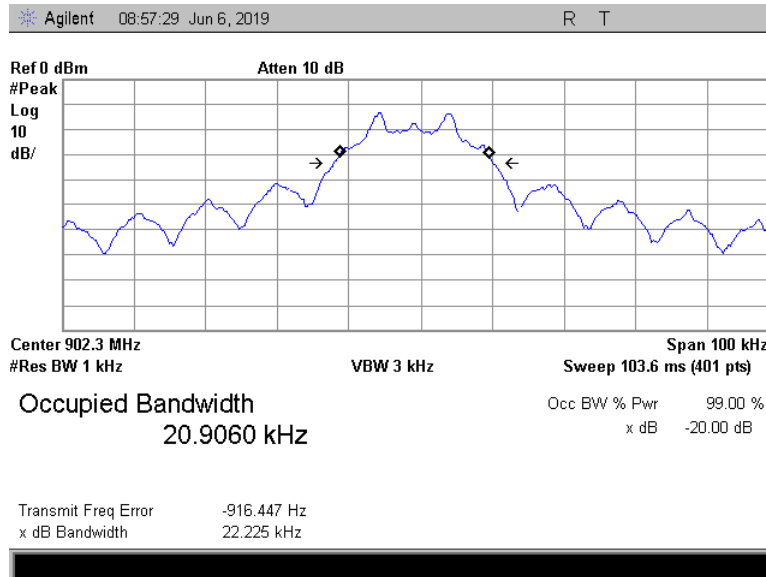

Plot 7.1.2 The 20 dB bandwidth test result at low frequency with 2FSK 19.2 kbps

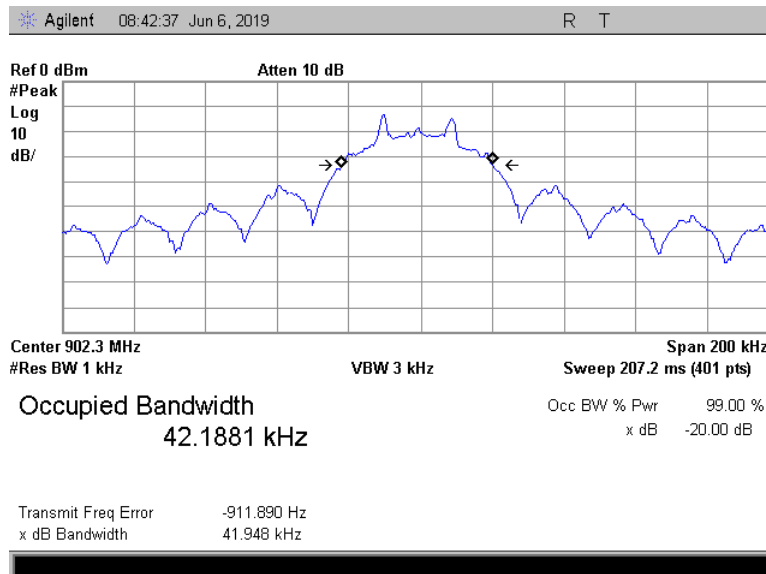



Test specification: Section 15.247(a)(1), RSS-247 section 5.1(c) 20 dB bandwidth			
Test procedure: ANSI C63.10 section 7.8.7			
Test mode: Compliance		Verdict: PASS	
Date(s): 06-Jun-19			
Temperature: 24 °C	Relative Humidity: 46 %	Air Pressure: 1012 hPa	Power: 3.6 VDC
Remarks:			

Plot 7.1.3 The 20 dB bandwidth test result at low frequency with 2FSK 38.4 kbps

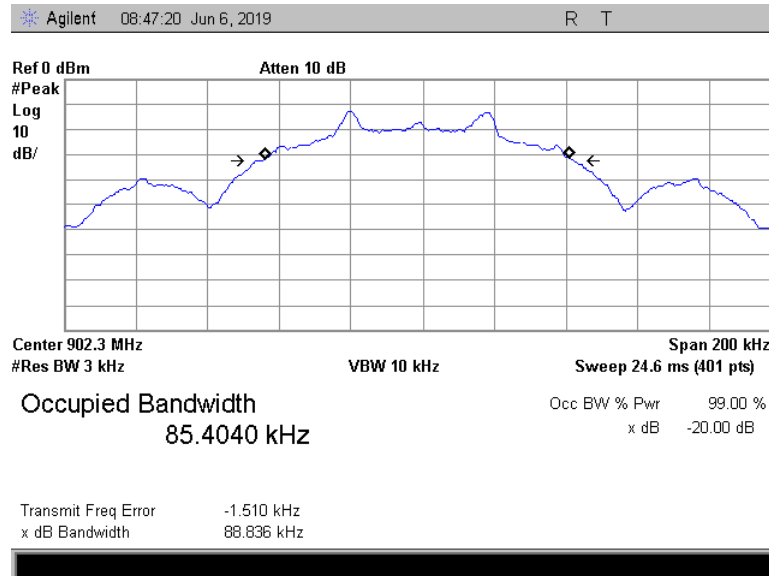

Plot 7.1.4 The 20 dB bandwidth test result at low frequency with QPSK 50.0 kbps

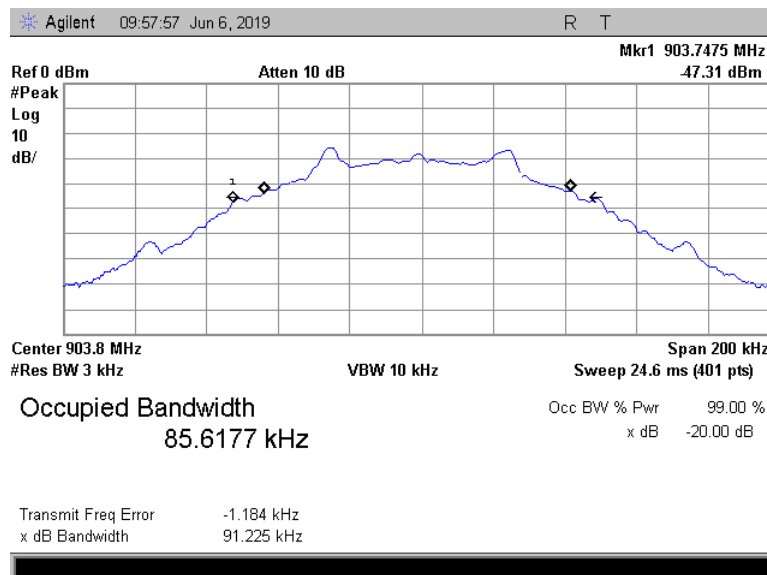



Test specification: Section 15.247(a)(1), RSS-247 section 5.1(c) 20 dB bandwidth			
Test procedure: ANSI C63.10 section 7.8.7			
Test mode: Compliance		Verdict: PASS	
Date(s): 06-Jun-19			
Temperature: 24 °C	Relative Humidity: 46 %	Air Pressure: 1012 hPa	Power: 3.6 VDC
Remarks:			

Plot 7.1.5 The 20 dB bandwidth test result at mid frequency with 2FSK 9.6 kbps

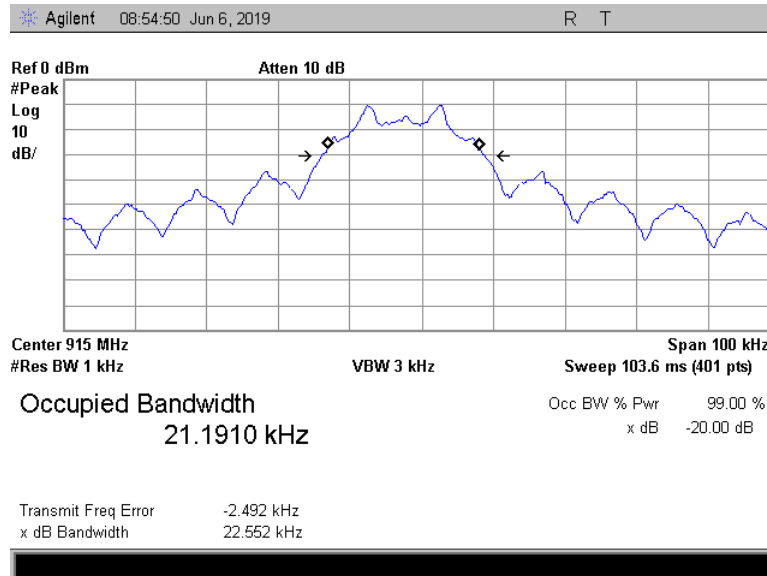

Plot 7.1.6 The 20 dB bandwidth test result at mid frequency with 2FSK 19.2 kbps

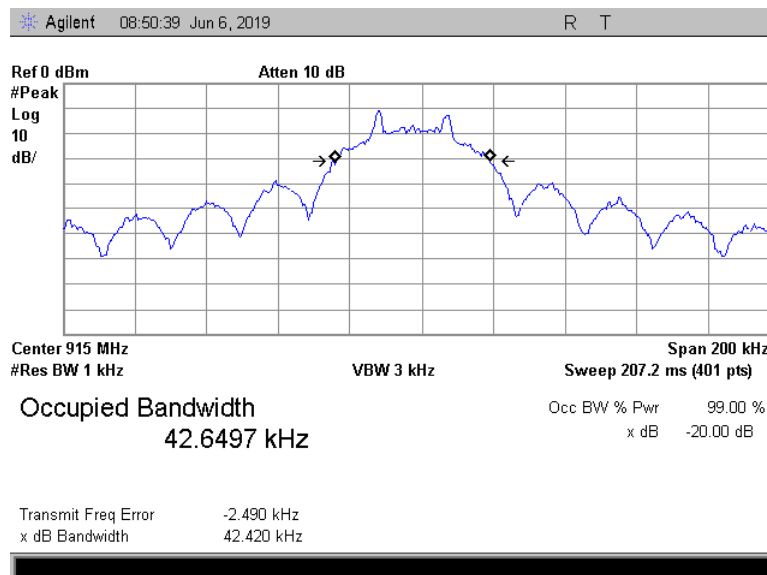



Test specification: Section 15.247(a)(1), RSS-247 section 5.1(c) 20 dB bandwidth			
Test procedure: ANSI C63.10 section 7.8.7			
Test mode: Compliance		Verdict: PASS	
Date(s): 06-Jun-19			
Temperature: 24 °C	Relative Humidity: 46 %	Air Pressure: 1012 hPa	Power: 3.6 VDC
Remarks:			

Plot 7.1.7 The 20 dB bandwidth test result at mid frequency with 2FSK 38.4 kbps

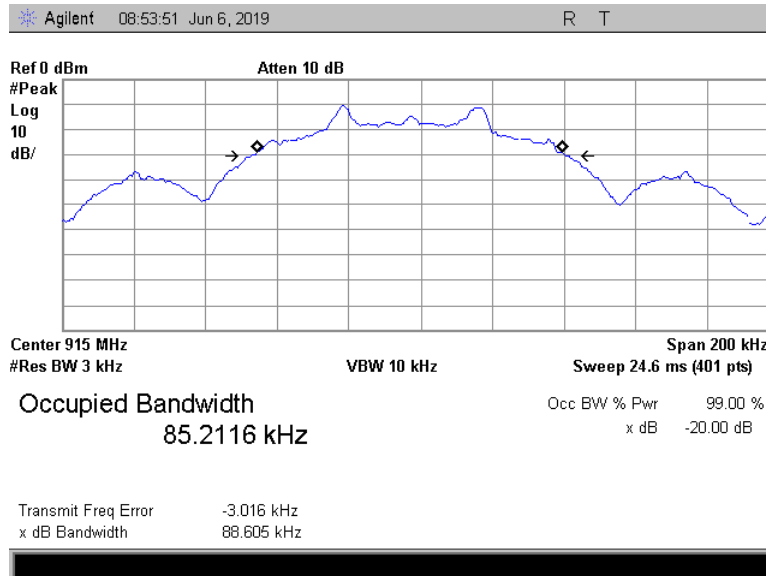

Plot 7.1.8 The 20 dB bandwidth test result at mid frequency with QPSK 50.0 kbps

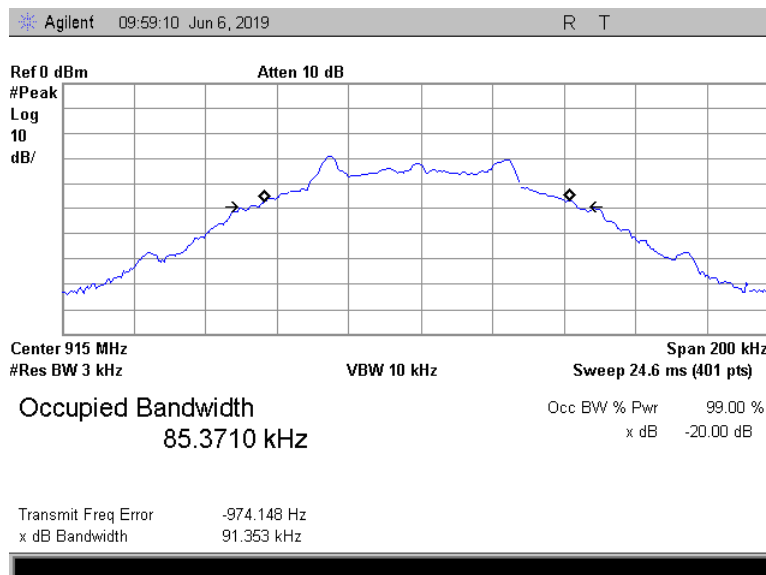



HERMON LABORATORIES

Test specification: Section 15.247(a)(1), RSS-247 section 5.1(c) 20 dB bandwidth			
Test procedure: ANSI C63.10 section 7.8.7			
Test mode: Compliance		Verdict: PASS	
Date(s): 06-Jun-19			
Temperature: 24 °C	Relative Humidity: 46 %	Air Pressure: 1012 hPa	Power: 3.6 VDC
Remarks:			

Plot 7.1.9 The 20 dB bandwidth test result at high frequency with 2FSK 9.6 kbps

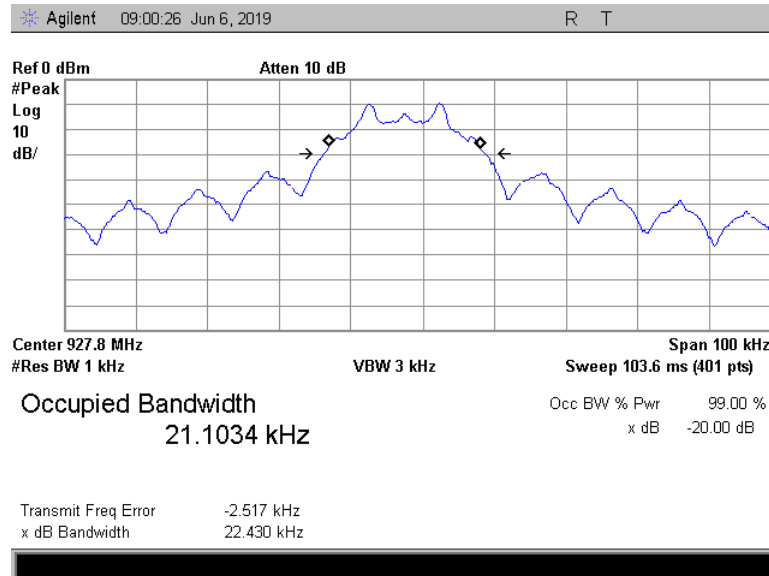

Plot 7.1.10 The 20 dB bandwidth test result at high frequency with 2FSK 19.2 kbps

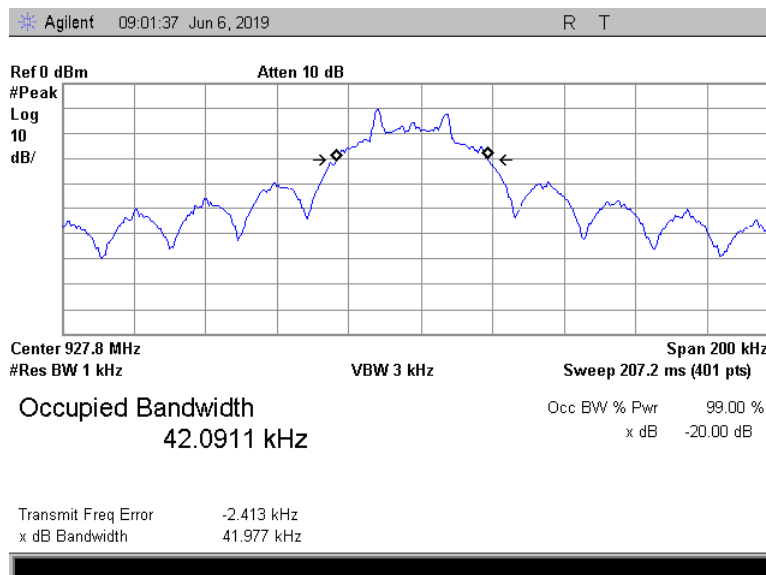



Test specification: Section 15.247(a)(1), RSS-247 section 5.1(c) 20 dB bandwidth			
Test procedure: ANSI C63.10 section 7.8.7			
Test mode: Compliance		Verdict: PASS	
Date(s): 06-Jun-19			
Temperature: 24 °C	Relative Humidity: 46 %	Air Pressure: 1012 hPa	Power: 3.6 VDC
Remarks:			

Plot 7.1.11 The 20 dB bandwidth test result at high frequency with 2FSK 38.4 kbps

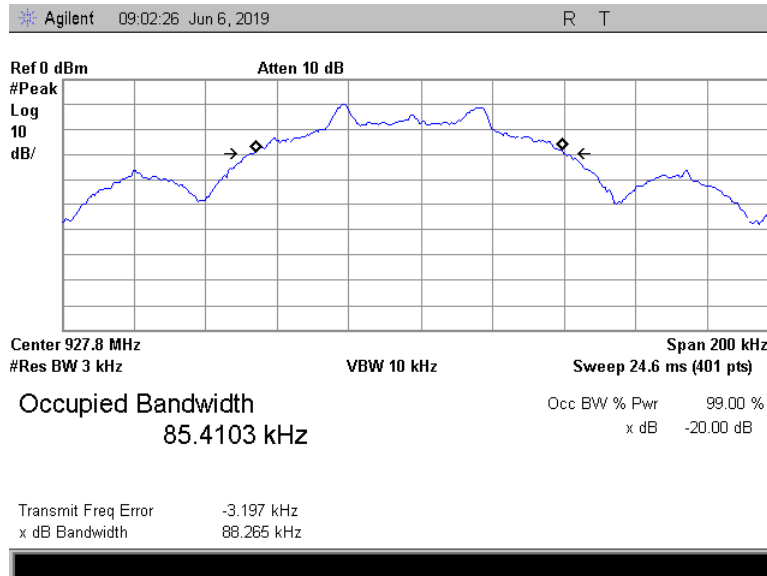

Plot 7.1.12 The 20 dB bandwidth test result at high frequency with QPSK 50.0 kbps

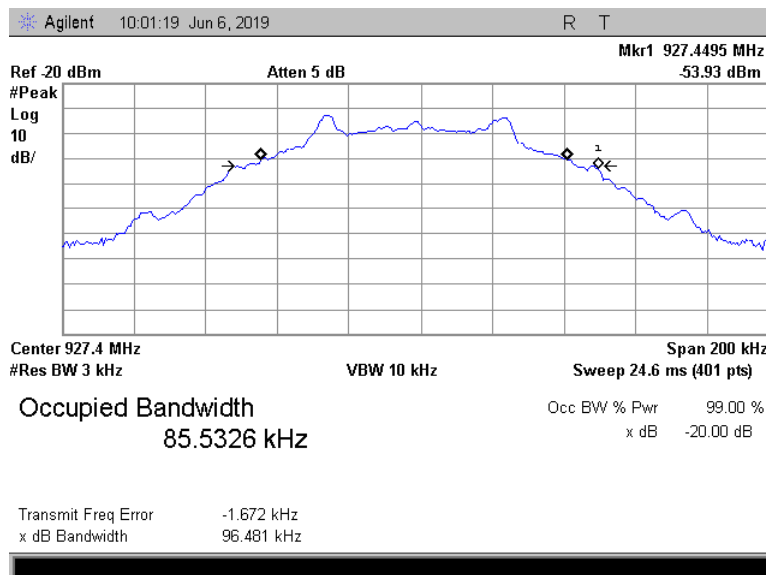



Test specification: Section 15.247(a)1, RSS-247 section 5.1(b) Frequency separation			
Test procedure: ANSI C63.10 section 7.8.3			
Test mode: Compliance		Verdict: PASS	
Date(s): 05-May-19			
Temperature: 25 °C	Relative Humidity: 48 %	Air Pressure: 1014 hPa	Power: 3.6 VDC
Remarks:			

7.2 Carrier frequency separation

7.2.1 General

This test was performed to measure frequency separation between the peaks of adjacent channels. Specification test limits are given in Table 7.2.1.

Table 7.2.1 Carrier frequency separation limits

Assigned frequency range, MHz	Carrier frequency separation	
	Output power 30 dBm	Output power 21 dBm
902.0 – 928.0	25 kHz or 20 dB bandwidth of the hopping channel, whichever is greater	25 kHz or two-thirds of the 20 dB bandwidth of the hopping channel, whichever is greater
2400.0 – 2483.5		
5725.0 – 5850.0		

7.2.2 Test procedure

- 7.2.2.1 The EUT was set up as shown in Figure 7.5.1, energized with frequency hopping function enabled and its proper operation was checked.
- 7.2.2.2 The spectrum analyzer span was set to capture the carrier frequency and both of adjacent channels, the lower and the higher. The resolution bandwidth was set wider than 1 % of the frequency span.
- 7.2.2.3 The spectrum analyzer was set in max hold mode and allowed trace to stabilize.
- 7.2.2.4 The frequency separation between the peaks of adjacent channels was measured as provided in Table 7.2.2 and associated plots.

Figure 7.2.1 Carrier frequency separation test setup





Test specification: Section 15.247(a)1, RSS-247 section 5.1(b) Frequency separation			
Test procedure: ANSI C63.10 section 7.8.3			
Test mode: Compliance		Verdict: PASS	
Date(s): 05-May-19			
Temperature: 25 °C	Relative Humidity: 48 %	Air Pressure: 1014 hPa	Power: 3.6 VDC
Remarks:			

Table 7.2.2 Carrier frequency separation test results

ASSIGNED FREQUENCY: 902-928 MHz
 MODULATION: 2FSK
 BIT RATE: 38.4 kbps
 DETECTOR USED: Peak
 RESOLUTION BANDWIDTH: ≥ 1% of the span
 VIDEO BANDWIDTH: ≥ RBW
 FREQUENCY HOPPING: Enabled
 20 dB BANDWIDTH: 88.836 kHz

Carrier frequency separation, kHz	Limit, kHz	Margin*	Verdict
101.9	88.836	-13.064	Pass

* - Margin = Carrier frequency separation – specification limit.

ASSIGNED FREQUENCY: 902-928 MHz
 MODULATION: GFSK
 BIT RATE: 50 kbps
 DETECTOR USED: Peak
 20 dB BANDWIDTH: 96.481 kHz

Carrier frequency separation, kHz	Limit, kHz	Margin*	Verdict
400	96.481	-303.519	Pass

Reference numbers of test equipment used

HL 3818	HL 4135					
---------	---------	--	--	--	--	--

Full description is given in Appendix A.



HERMON LABORATORIES

Test specification: Section 15.247(a)1, RSS-247 section 5.1(b) Frequency separation			
Test procedure: ANSI C63.10 section 7.8.3			
Test mode: Compliance	Verdict: PASS		
Date(s): 05-May-19			
Temperature: 25 °C	Relative Humidity: 48 %	Air Pressure: 1014 hPa	Power: 3.6 VDC
Remarks:			

Plot 7.2.1 Carrier frequency separation 2FSK

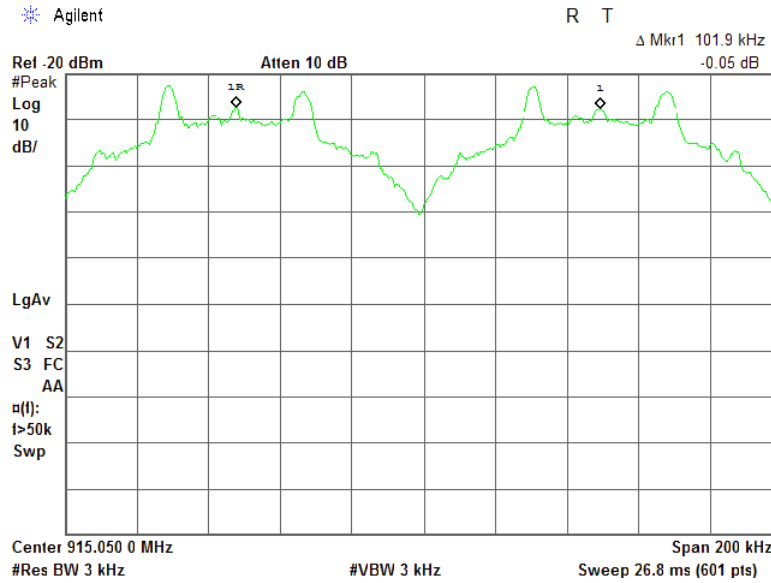

Plot 7.2.2 Carrier frequency separation GFSK

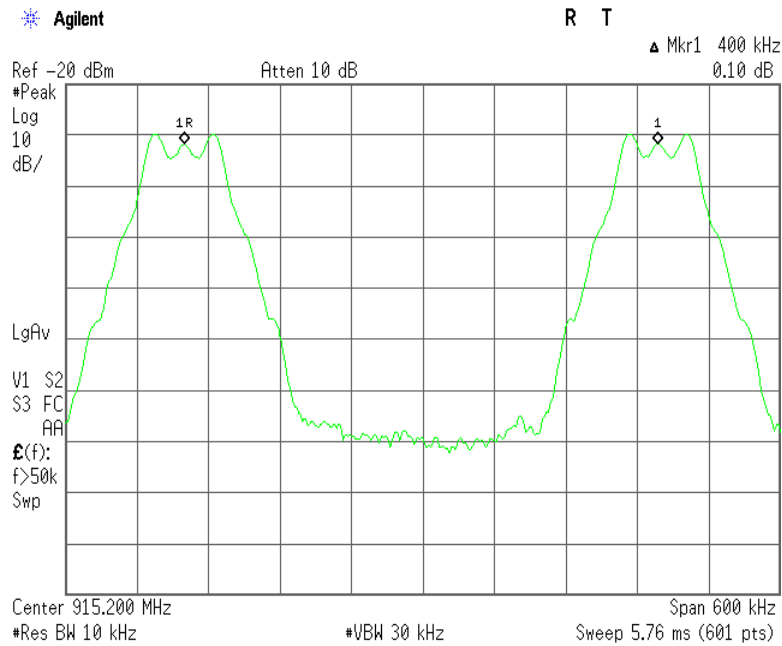



Test specification: Section 15.247(a)1, RSS-247 section 5.1(c) Number of hopping frequencies			
Test procedure: ANSI C63.10 section 7.8.3			
Test mode: Compliance		Verdict: PASS	
Date(s): 05-May-19			
Temperature: 25 °C	Relative Humidity: 48 %	Air Pressure: 1014 hPa	Power: 3.6 VDC
Remarks:			

7.3 Number of hopping frequencies

7.3.1 General

This test was performed to calculate the number of hopping frequencies used by the EUT. Specification test limits are given in Table 7.3.1

Table 7.3.1 Minimum number of hopping frequencies

Assigned frequency range, MHz	Number of hopping frequencies
902.0 – 928.0	50 (if the 20 dB bandwidth is less than 250 kHz) 25 (if the 20 dB bandwidth is 250 kHz or greater)
2400.0 – 2483.5	15
5725.0 – 5850.0	75

7.3.2 Test procedure

7.3.2.1 The EUT was set up as shown in Figure 7.3.1, energized with frequency hopping function enabled and its proper operation was checked.

7.3.2.2 Initially the spectrum analyzer span was set equal to frequency band of operation and the resolution bandwidth was set wider than 1 % of the frequency span. If the separate hopping channels were not clearly resolved the frequency band of operation was broken to sections and the resolution bandwidth was set wider than 1 % of the frequency span of each section.

7.3.2.3 The spectrum analyzer was set in max hold mode and allowed trace to stabilize.

7.3.2.4 The number of frequency hopping channels was calculated as provided in Table 7.3.2 and associated plots.

Figure 7.3.1 Hopping frequencies test setup





Test specification: Section 15.247(a)1, RSS-247 section 5.1(c) Number of hopping frequencies			
Test procedure: ANSI C63.10 section 7.8.3			
Test mode: Compliance		Verdict: PASS	
Date(s): 05-May-19			
Temperature: 25 °C	Relative Humidity: 48 %	Air Pressure: 1014 hPa	Power: 3.6 VDC
Remarks:			

Table 7.3.2 Hopping frequencies test results

ASSIGNED FREQUENCY: 902-928 MHz
 DETECTOR USED: Peak
 VIDEO BANDWIDTH: ≥ RBW
 FREQUENCY HOPPING: Enabled
 MODULATION: 2FSK
 BIT RATE: 38.4

Number of hopping frequencies	Minimum number of hopping frequencies	Margin*	Verdict
256	50	206	Pass

MODULATION: GFSK
 BIT RATE: 50.0

Number of hopping frequencies	Minimum number of hopping frequencies	Margin*	Verdict
60	50	10	Pass

* - Margin = Number of hopping frequencies – Minimum number of hopping frequencies.

Reference numbers of test equipment used

HL 3818	HL 4135					
---------	---------	--	--	--	--	--

Full description is given in Appendix A.

Plot 7.3.1 Number of hopping frequencies 2FSK

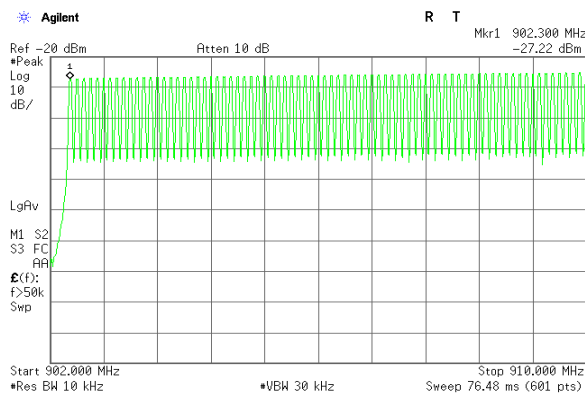

78 channels from 256 channels



Test specification: Section 15.247(a)1, RSS-247 section 5.1(c) Number of hopping frequencies			
Test procedure: ANSI C63.10 section 7.8.3			
Test mode: Compliance	Verdict: PASS		
Date(s): 05-May-19			
Temperature: 25 °C	Relative Humidity: 48 %	Air Pressure: 1014 hPa	Power: 3.6 VDC
Remarks:			

Plot 7.3.2 Number of hopping frequencies 2FSK

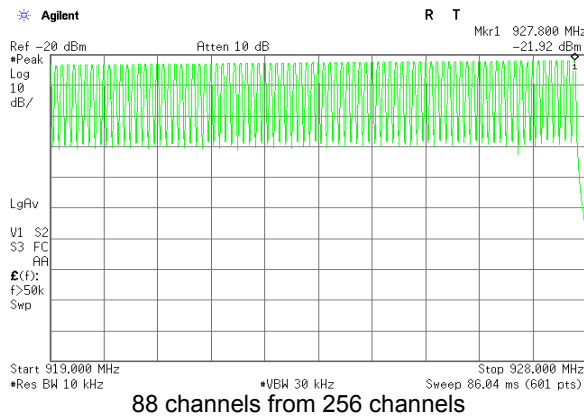
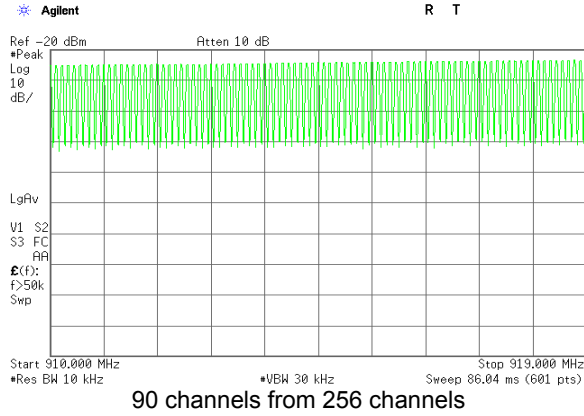

Plot 7.3.2 Number of hopping frequencies GFSK

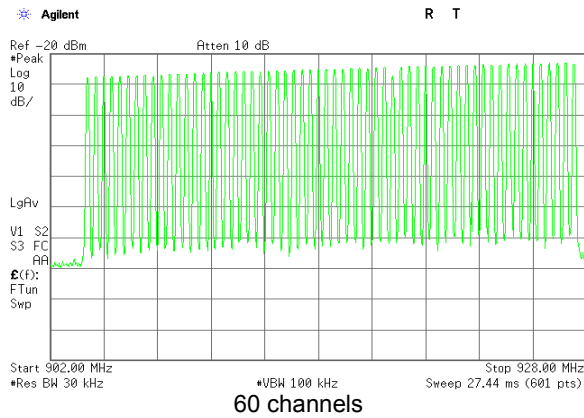



Test specification: Section 15.247(a), RSS-247 section 5.1(c) Average time of occupancy			
Test procedure: ANSI C63.10 section 7.8.4			
Test mode: Compliance		Verdict: PASS	
Date(s): 05-May-19			
Temperature: 25 °C	Relative Humidity: 48 %	Air Pressure: 1014 hPa	Power: 3.6 VDC
Remarks:			

7.4 Average time of occupancy

7.4.1 General

This test was performed to calculate the average time of occupancy (dwell time) on any frequency channel of the EUT. Specification test limits are given in Table 7.4.1.

Table 7.4.1 Average time of occupancy limits

Assigned frequency range, MHz	Maximum average time of occupancy, s	Investigated period, s	Number of hopping frequencies
902.0 – 928.0	0.4	20.0	≥ 50
902.0 – 928.0	0.4	10.0	< 50
2400.0 – 2483.5	0.4	0.4 × N	N (≥ 15)
5725.0 – 5850.0	0.4	30.0	≥ 75

7.4.2 Test procedure

7.4.2.1 The EUT was set up as shown in Figure 7.4.1, energized with frequency hopping function enabled and its proper operation was checked.

7.4.2.2 The spectrum analyzer span was set to zero centered on a hopping channel.

7.4.2.3 The single transmission duration and period were measured with oscilloscope.

7.4.2.4 The average time of occupancy was calculated as the single transmission time multiplied by the investigated period and divided by the single transmission period.

7.4.2.5 The test was repeated at each data rate and modulation type as provided in Table 7.4.2 and associated plots.

Figure 7.4.1 Average time of occupancy test setup

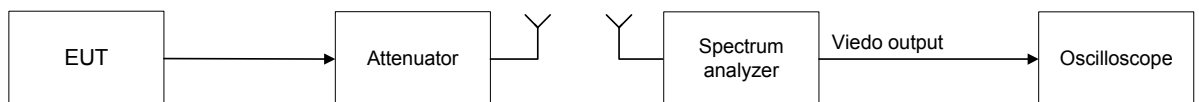



Test specification: Section 15.247(a), RSS-247 section 5.1(c) Average time of occupancy			
Test procedure: ANSI C63.10 section 7.8.4			
Test mode: Compliance		Verdict: PASS	
Date(s): 05-May-19			
Temperature: 25 °C	Relative Humidity: 48 %	Air Pressure: 1014 hPa	Power: 3.6 VDC
Remarks:			

Table 7.4.2 Average time of occupancy test results

ASSIGNED FREQUENCY: 902-928 MHz
DETECTOR USED: Peak
RESOLUTION BANDWIDTH: 100 kHz
VIDEO BANDWIDTH: 300 kHz
INVESTIGATED PERIOD: 20 s
FREQUENCY HOPPING: Enabled
MODULATION: 2FSK
NUMBER OF HOPPING FREQUENCIES: 256

Carrier frequency, MHz	Single transmission duration, ms	Number Transmission within 20 s	Average time of occupancy*, s	Bit rate, kbps	Symbol rate, Msymbol/s	Limit, s	Margin, s**	Verdict
915	196.500	2	0.393	38.4	NA	0.4	-0.007	Pass

MODULATION: GFSK
NUMBER OF HOPPING FREQUENCIES: 60

Carrier frequency, MHz	Single transmission duration, ms	Number Transmission within 20 s	Average time of occupancy*, s	Bit rate, kbps	Symbol rate, Msymbol/s	Limit, s	Margin, s**	Verdict
915	196.750	2	0.394	50	NA	0.4	-0.006	Pass

* - Average time of occupancy = Single transmission duration × Number of transmissions within 20s
** - Margin = Average time of occupancy – specification limit.

Reference numbers of test equipment used

HL 3818	HL 4135						
---------	---------	--	--	--	--	--	--

Full description is given in Appendix A.



HERMON LABORATORIES

Test specification: Section 15.247(a), RSS-247 section 5.1(c) Average time of occupancy			
Test procedure: ANSI C63.10 section 7.8.4			
Test mode: Compliance		Verdict: PASS	
Date(s): 05-May-19			
Temperature: 25 °C	Relative Humidity: 48 %	Air Pressure: 1014 hPa	Power: 3.6 VDC
Remarks:			

Plot 7.4.1 Single transmission duration

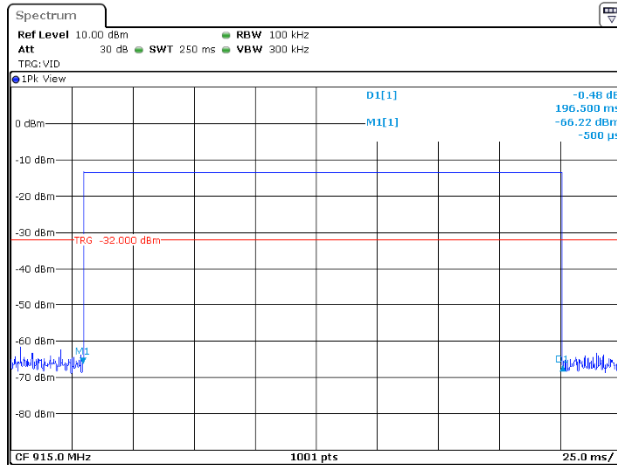

2FSK (38.4 kbps)

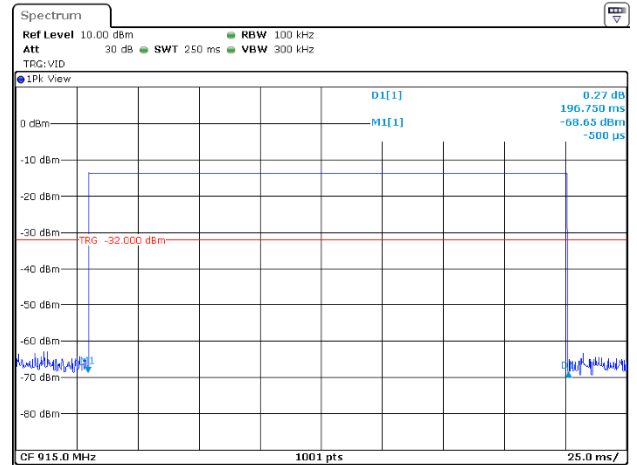

GFSK (50 kbps)

Plot 7.4.2 Single transmission period

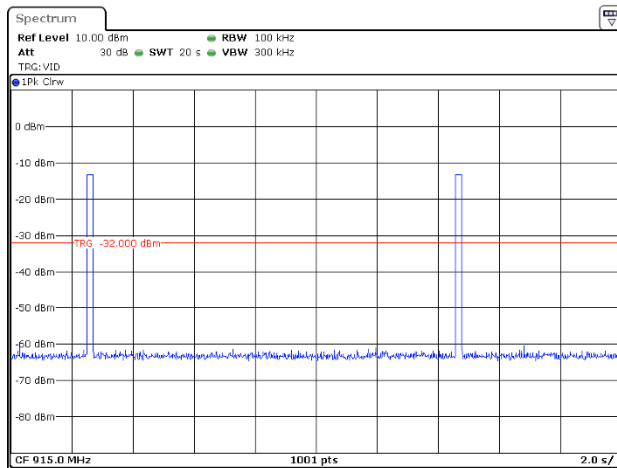

2FSK (38.4 kbps)

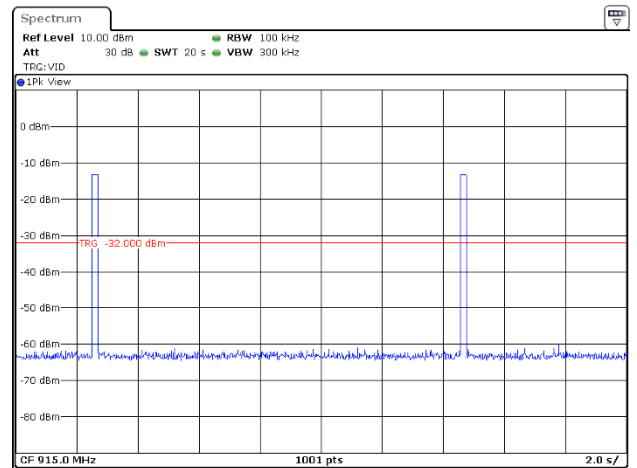

GFSK (50 kbps)



Test specification: Section 15.247(b), RSS-247 section 5.4(a) Peak output power			
Test procedure: ANSI C63.10 section 7.8.5			
Test mode: Compliance		Verdict: PASS	
Date(s): 05-May-19			
Temperature: 25 °C	Relative Humidity: 48 %	Air Pressure: 1014 hPa	Power: 3.6 VDC
Remarks:			

7.5 Peak output power

7.5.1 General

This test was performed to measure the maximum peak output power radiated by transmitter. Specification test limits are given in Table 7.5.1.

Table 7.5.1 Peak output power limits

Assigned frequency range, MHz	Peak output power*		Equivalent field strength limit @ 3m, dB(μV/m)*	Maximum antenna gain, dBi
	W	dBm		
902.0 – 928.0	0.25 (<50 hopping channels)	24.0(<50 hopping channels)	125.2 (<50 hopping channels)	6.0*
	1.0 (≥50 hopping channels)	30.0 (≥50 hopping channels)	131.2 (≥50 hopping channels)	
2400.0 – 2483.5	0.125 (<75 hopping channels)	21.0(<75 hopping channels)	122.2 (<75 hopping channels)	
	1.0 (≥75 hopping channels)	30.0 (≥75 hopping channels)	131.2 (≥75 hopping channels)	
5725.0 – 5850.0	1.0	30.0	131.2	

*- Equivalent field strength limit was calculated from the peak output power as follows: $E = \sqrt{(30 \times P \times G)/r}$, where P is peak output power in Watts, r is antenna to EUT distance in meters and G is transmitter antenna gain in dBi.

** - The limit is provided in terms of conducted RF power at the antenna connector. If transmitting antennas of directional gain greater than 6 dBi are used, the peak output power limit shall be reduced below the stated value as follows:

- by 1 dB for every 3 dB that the directional gain of antenna exceeds 6 dBi for fixed point-to-point transmitters operate in 2400-2483.5 MHz band;
- without any corresponding reduction for fixed point-to-point transmitters operate in 5725-5850 MHz band;
- by the amount in dB that the directional gain of antenna exceeds 6 dBi for the rest of transmitters.

7.5.2 Test procedure

7.5.2.1 The EUT was set up as shown in Figure 7.5.1, energized and its proper operation was checked.

7.5.2.2 The EUT was adjusted to produce maximum available to end user RF output power.

7.5.2.3 The frequency span of spectrum analyzer was set approximately 5 times wider than 20 dB bandwidth of the EUT and the resolution bandwidth was set wider than 20 dB bandwidth of the EUT. To find maximum radiation the turntable was rotated 360° and the measuring antenna height was swept in both vertical and horizontal polarizations.

7.5.2.4 The maximum field strength of the EUT carrier frequency was measured as provided in Table 7.5.2 and associated plots.

7.5.2.5 The maximum peak output power was calculated from the field strength of carrier as follows:

$$P = (E \times d)^2 / (30 \times G),$$

where P is the peak output power in W, E is the field strength in V/m, d is the test distance and G is the transmitter numeric antenna gain over an isotropic radiator.

The above equation was converted in logarithmic units for 3 m test distance:

$$\text{Peak output power in dBm} = \text{Field strength in dB}(\mu\text{V/m}) - \text{Transmitter antenna gain in dBi} - 95.2 \text{ dB}$$

7.5.2.6 The worst test results (the lowest margins) were recorded in Table 7.5.2.



HERMON LABORATORIES

Test specification: Section 15.247(b), RSS-247 section 5.4(a) Peak output power			
Test procedure: ANSI C63.10 section 7.8.5			
Test mode: Compliance		Verdict: PASS	
Date(s): 05-May-19			
Temperature: 25 °C	Relative Humidity: 48 %	Air Pressure: 1014 hPa	Power: 3.6 VDC
Remarks:			

Figure 7.5.1 Setup for carrier field strength measurements

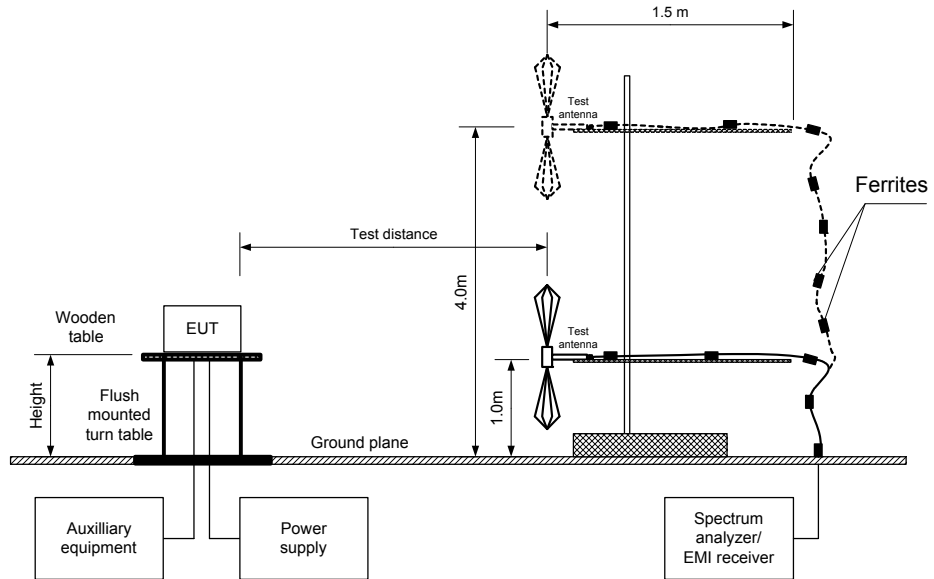



Test specification: Section 15.247(b), RSS-247 section 5.4(a) Peak output power			
Test procedure: ANSI C63.10 section 7.8.5			
Test mode: Compliance		Verdict: PASS	
Date(s): 05-May-19			
Temperature: 25 °C	Relative Humidity: 48 %	Air Pressure: 1014 hPa	Power: 3.6 VDC
Remarks:			

Table 7.5.2 Peak output power test results

ASSIGNED FREQUENCY: 902-928 MHz
TEST DISTANCE: 3 m
TEST SITE: Semi anechoic chamber
EUT HEIGHT: 0.8 m
DETECTOR USED: Peak
TEST ANTENNA TYPE: Biconilog (30 MHz – 1000 MHz)
DETECTOR USED: Peak
RESOLUTION BANDWIDTH: 100 kHz
VIDEO BANDWIDTH: 300 kHz
FREQUENCY HOPPING: Disabled
MODULATION: 2FSK
BITRATE: 9.6 kbps

Frequency, MHz	Field strength, dB(μV/m)	Antenna polarization	Antenna height, m	Azimuth, degrees*	EUT antenna gain, dBi	Peak output power, dBm**	Limit, dBm	Margin, dB***	Verdict
902.3	122.84	Vertical	1.0	0	0	27.64	30.0	-2.36	Pass
915.0	123.44	Vertical	1.0	243	0	28.24	30.0	-1.76	Pass
927.8	121.96	Vertical	1.0	329	0	26.76	30.0	-3.24	Pass

MODULATION: 2FSK
BITRATE: 19.2 kbps

Frequency, MHz	Field strength, dB(μV/m)	Antenna polarization	Antenna height, m	Azimuth, degrees*	EUT antenna gain, dBi	Peak output power, dBm**	Limit, dBm	Margin, dB***	Verdict
902.3	123.38	Vertical	1.0	0	0	28.18	30.0	-1.82	Pass
915.0	123.71	Vertical	1.0	328	0	28.51	30.0	-1.49	Pass
927.8	122.22	Vertical	1.0	328	0	27.02	30.0	-2.98	Pass

MODULATION: 2FSK
BITRATE: 38.4 kbps

Frequency, MHz	Field strength, dB(μV/m)	Antenna polarization	Antenna height, m	Azimuth, degrees*	EUT antenna gain, dBi	Peak output power, dBm**	Limit, dBm	Margin, dB***	Verdict
902.3	122.61	Vertical	1.0	0	0	27.41	30.0	-2.59	Pass
915.0	123.19	Vertical	1.0	238	0	27.99	30.0	-2.01	Pass
927.8	122.04	Vertical	1.0	0	0	26.84	30.0	-3.16	Pass

MODULATION: GFSK
BITRATE: 50 kbps

Frequency, MHz	Field strength, dB(μV/m)	Antenna polarization	Antenna height, m	Azimuth, degrees*	EUT antenna gain, dBi	Peak output power, dBm**	Limit, dBm	Margin, dB***	Verdict
903.8	123.48	Vertical	1.0	105	0	28.28	30.0	-1.72	Pass
915.0	124.59	Vertical	1.0	45	0	29.39	30.0	-0.61	Pass
927.4	123.31	Vertical	1.0	117	0	28.11	30.0	-1.89	Pass

*- EUT front panel refer to 0 degrees position of turntable.

** - Peak output power was calculated from the field strength of carrier as follows: $P = (E \times d)^2 / (30 \times G)$, where P is the peak output power in W, E is the field strength in V/m, d is the test distance in meters and G is the transmitter numeric antenna gain over an isotropic radiator. The above equation was converted in logarithmic units for 3 m test distance: Peak output power in dBm = Field strength in dB(μV/m) - Transmitter antenna gain in dBi - 95.2 dB

*** - Margin = Peak output power – specification limit.

Reference numbers of test equipment used

HL 3903	HL 4360	HL 5288	HL 5405				
---------	---------	---------	---------	--	--	--	--



HERMON LABORATORIES

Test specification: Section 15.247(b), RSS-247 section 5.4(a) Peak output power			
Test procedure: ANSI C63.10 section 7.8.5			
Test mode: Compliance		Verdict: PASS	
Date(s): 05-May-19			
Temperature: 25 °C	Relative Humidity: 48 %	Air Pressure: 1014 hPa	Power: 3.6 VDC
Remarks:			

Full description is given in Appendix A.



Test specification: Section 15.247(b), RSS-247 section 5.4(a) Peak output power			
Test procedure: ANSI C63.10 section 7.8.5			
Test mode: Compliance		Verdict: PASS	
Date(s): 05-May-19			
Temperature: 25 °C	Relative Humidity: 48 %	Air Pressure: 1014 hPa	Power: 3.6 VDC
Remarks:			

Plot 7.5.1 Field strength of carrier at low frequency 2FSK 9.6 kbps

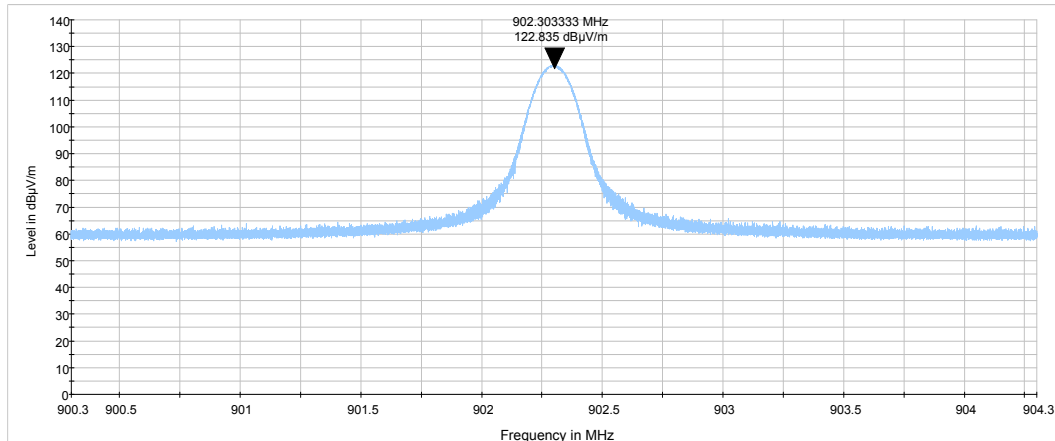

Plot 7.5.2 Field strength of carrier at mid frequency 2FSK 9.6 kbps

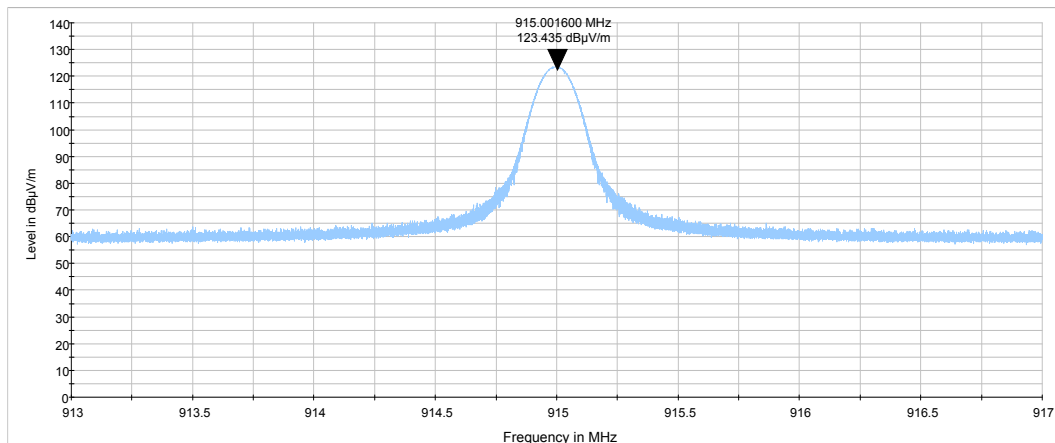

Plot 7.5.3 Field strength of carrier at high frequency 2FSK 9.6 kbps

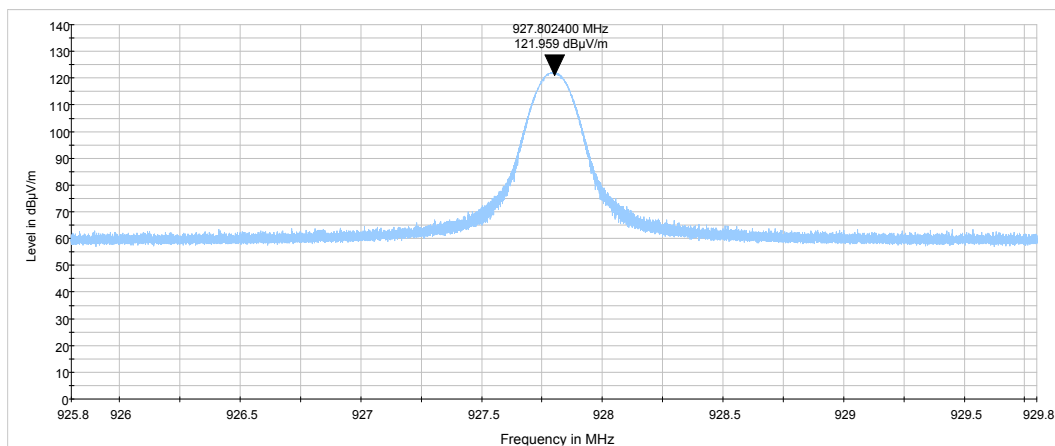



HERMON LABORATORIES

Test specification: Section 15.247(b), RSS-247 section 5.4(a) Peak output power			
Test procedure: ANSI C63.10 section 7.8.5			
Test mode: Compliance		Verdict: PASS	
Date(s): 05-May-19			
Temperature: 25 °C	Relative Humidity: 48 %	Air Pressure: 1014 hPa	Power: 3.6 VDC
Remarks:			

Plot 7.5.4 Field strength of carrier at low frequency 2FSK 19.2 kbps

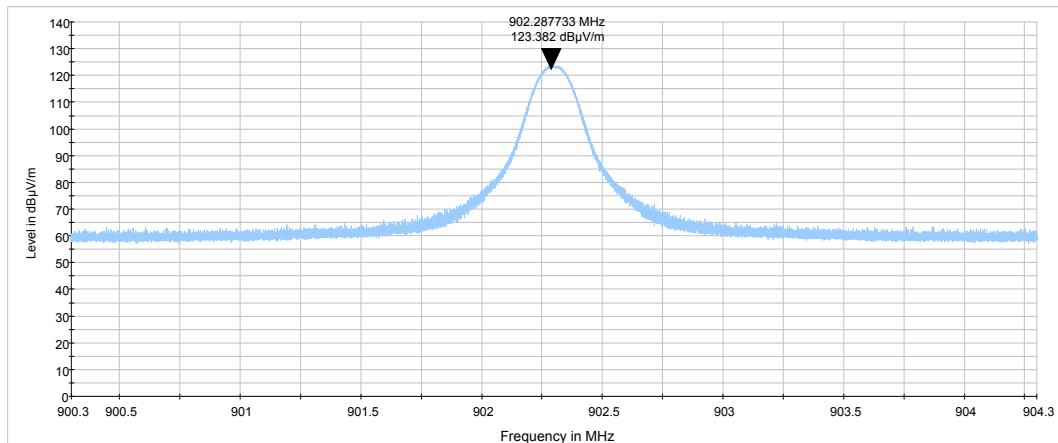

Plot 7.5.5 Field strength of carrier at mid frequency 2FSK 19.2 kbps

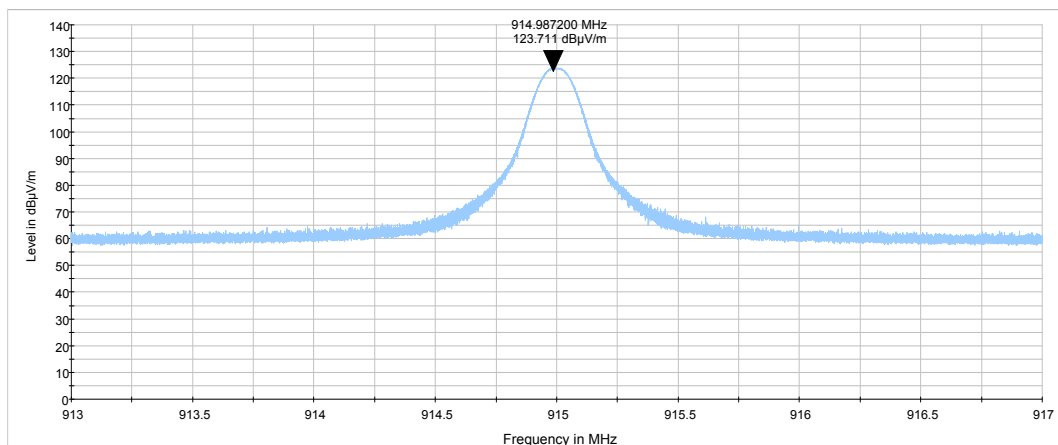

Plot 7.5.6 Field strength of carrier at high frequency 2FSK 19.2 kbps

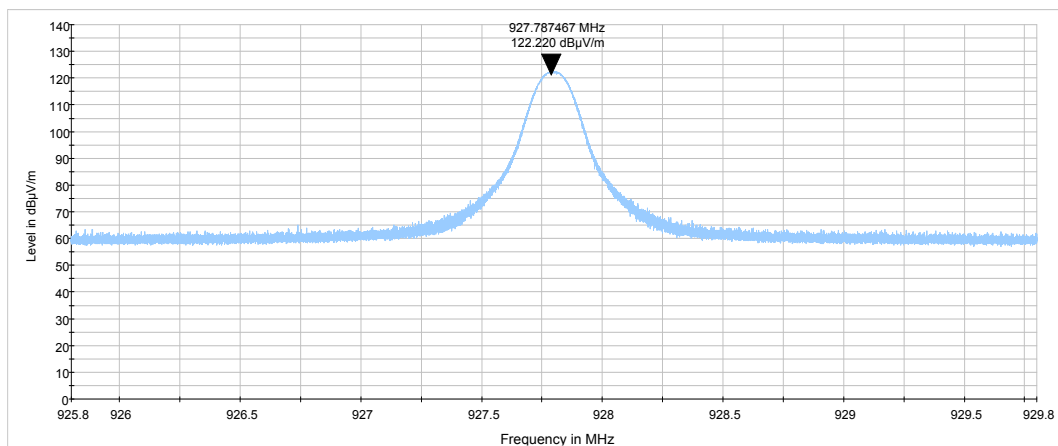



HERMON LABORATORIES

Test specification: Section 15.247(b), RSS-247 section 5.4(a) Peak output power			
Test procedure: ANSI C63.10 section 7.8.5			
Test mode: Compliance		Verdict: PASS	
Date(s): 05-May-19			
Temperature: 25 °C	Relative Humidity: 48 %	Air Pressure: 1014 hPa	Power: 3.6 VDC
Remarks:			

Plot 7.5.7 Field strength of carrier at low frequency 2FSK 38.4 kbps

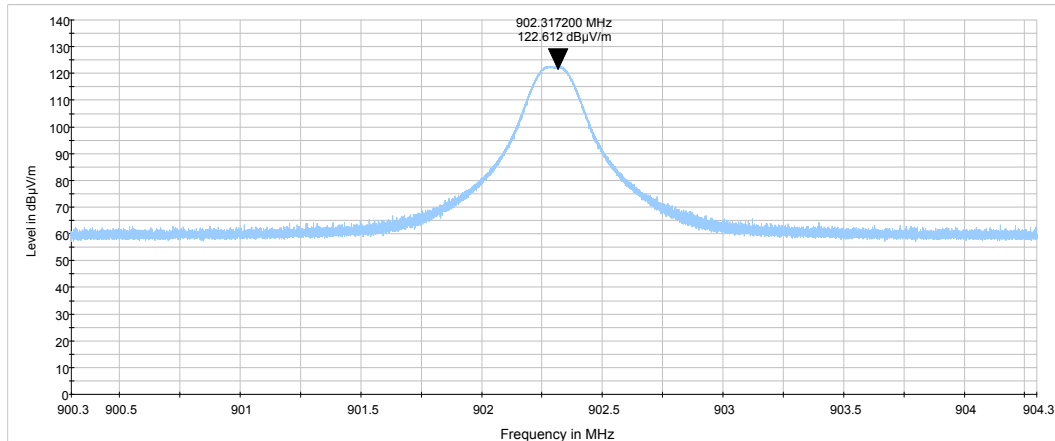

Plot 7.5.8 Field strength of carrier at mid frequency 2FSK 38.4 kbps

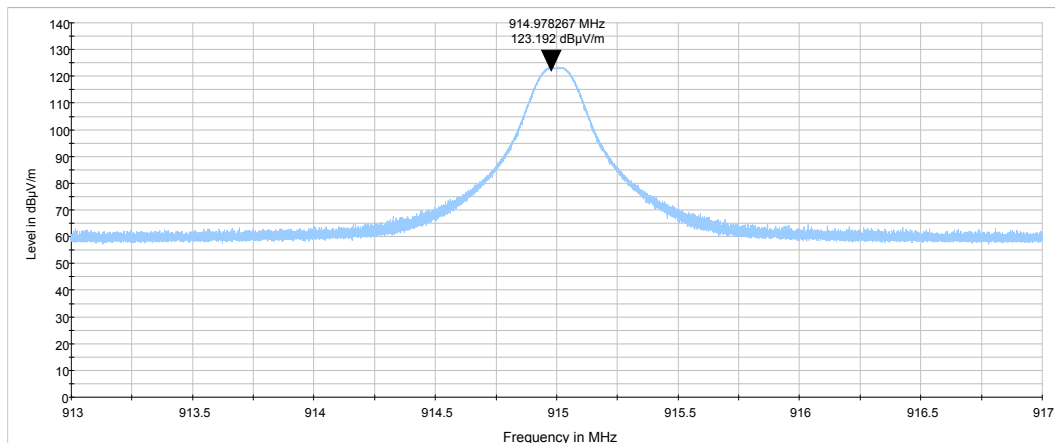

Plot 7.5.9 Field strength of carrier at high frequency 2FSK 38.4 kbps

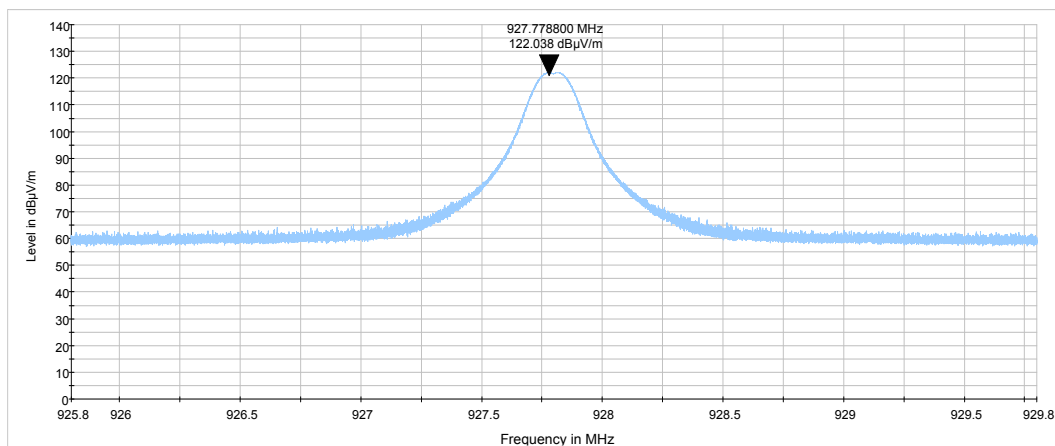



Test specification: Section 15.247(b), RSS-247 section 5.4(a) Peak output power			
Test procedure: ANSI C63.10 section 7.8.5			
Test mode: Compliance		Verdict: PASS	
Date(s): 05-May-19			
Temperature: 25 °C	Relative Humidity: 48 %	Air Pressure: 1014 hPa	Power: 3.6 VDC
Remarks:			

Plot 7.5.10 Field strength of carrier at low frequency GFSK 50 kbps

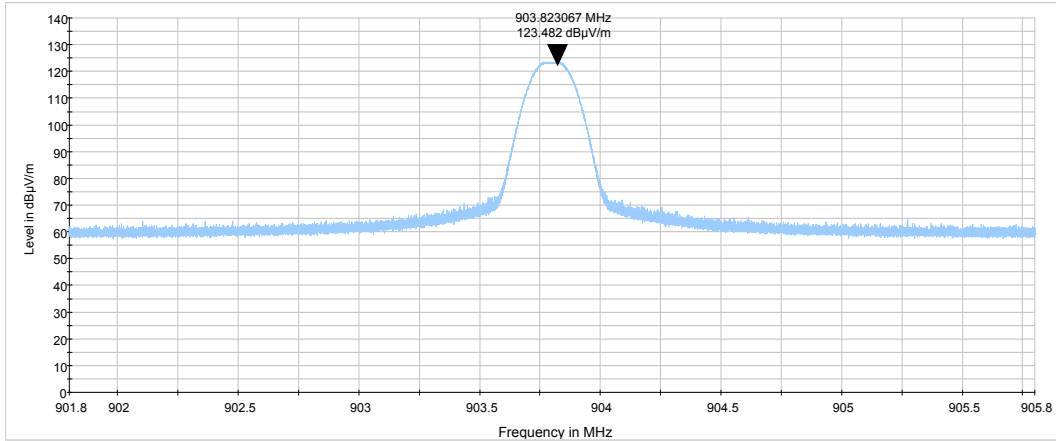

Plot 7.5.11 Field strength of carrier at mid frequency GFSK 50 kbps

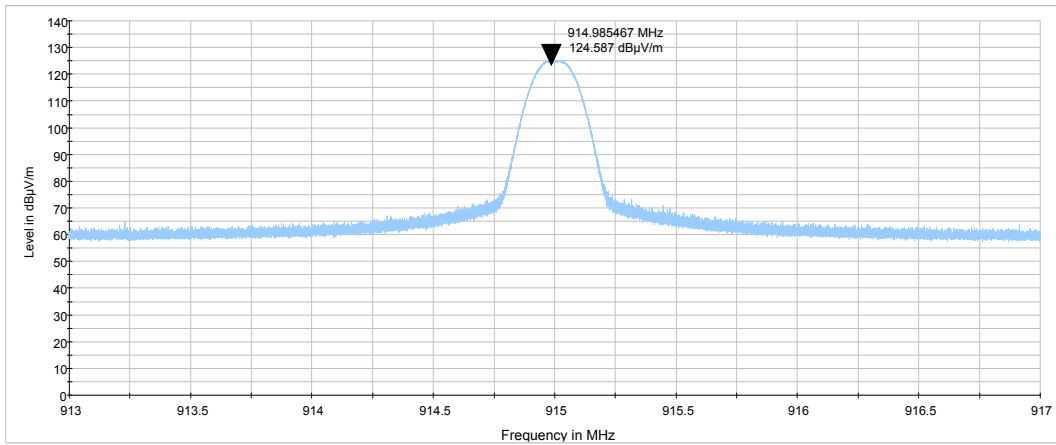

Plot 7.5.12 Field strength of carrier at high frequency GFSK 50 kbps

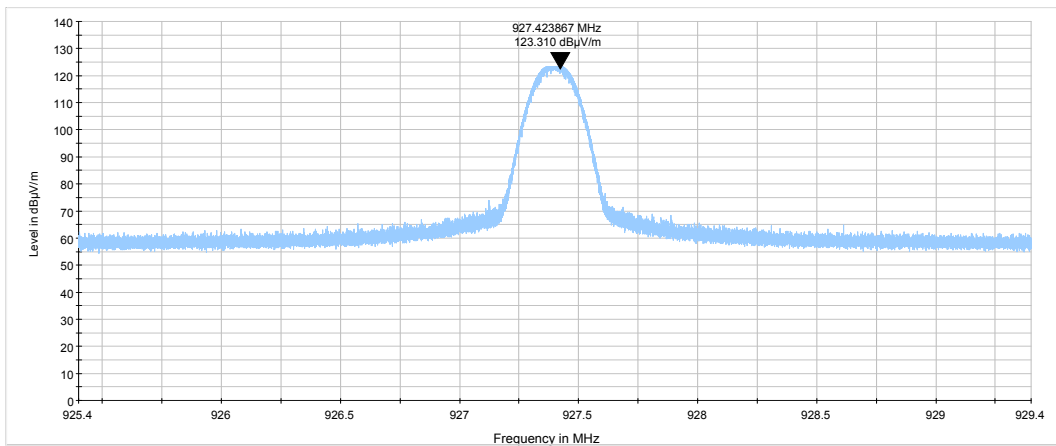



Test specification: Section 15.247(d), RSS-247 section 5.5 Radiated spurious emissions			
Test procedure: ANCI C63.10 section 6.5 & 6.6			
Test mode: Compliance		Verdict: PASS	
Date(s): 31-Jan-19			
Temperature: 24 °C	Relative Humidity: 56 %	Air Pressure: 1010 hPa	Power: 3.6 VDC
Remarks:			

7.6 Field strength of spurious emissions

7.6.1 General

This test was performed to measure field strength of spurious emissions from the EUT. Specification test limits are given in Table 7.6.1.

Table 7.6.1 Radiated spurious emissions limits

Frequency, MHz	Field strength at 3 m within restricted bands, dB(μV/m)***			Attenuation of field strength of spurious versus carrier outside restricted bands, dBc***
	Peak	Quasi Peak	Average	
0.009 – 0.090	148.5 – 128.5	NA	128.5 – 108.5**	20.0
0.090 – 0.110	NA	108.5 – 106.8**	NA	
0.110 – 0.490	126.8 – 113.8	NA	106.8 – 93.8**	
0.490 – 1.705	NA	73.8 – 63.0**	NA	
1.705 – 30.0*		69.5		
30 – 88		40.0		
88 – 216		43.5		
216 – 960		46.0		
960 - 1000		54.0		
1000 – 10 th harmonic	74.0	NA	54.0	

*- The limit for 3 m test distance was calculated using the inverse square distance extrapolation factor as follows:

$$\text{Lim}_{S_2} = \text{Lim}_{S_1} + 40 \log (S_1/S_2),$$

where S_1 and S_2 – standard defined and test distance respectively in meters.

** - The limit decreases linearly with the logarithm of frequency.

*** - The field strength limits applied from the lowest radio frequency generated in the device, without going below 9 kHz up to the tenth harmonic of the highest fundamental frequency.

7.6.2 Test procedure for spurious emission field strength measurements in 9 kHz to 30 MHz band

7.6.2.1 The EUT was set up as shown in Figure 7.6.1, energized and the performance check was conducted.

7.6.2.2 The specified frequency range was investigated with antenna connected to spectrum analyzer/ EMI receiver. To find maximum radiation the turntable was rotated 360° and the measuring antenna was rotated around its vertical axis.

7.6.2.3 The worst test results (the lowest margins) were recorded and shown in the associated plots.

7.6.3 Test procedure for spurious emission field strength measurements above 30 MHz

7.6.3.1 The EUT was set up as shown in Figure 7.6.2, Table 7.6.3, energized and the performance check was conducted.

7.6.3.2 The specified frequency range was investigated with antenna connected to spectrum analyzer/ EMI receiver. To find maximum radiation the turntable was rotated 360°, the measuring antenna height was changed from 1 to 4 m, its polarization was switched from vertical to horizontal.

7.6.3.3 The worst test results (the lowest margins) were recorded and shown in the associated plots.



Test specification: Section 15.247(d), RSS-247 section 5.5 Radiated spurious emissions			
Test procedure: ANCI C63.10 section 6.5 & 6.6			
Test mode: Compliance		Verdict: PASS	
Date(s): 31-Jan-19			
Temperature: 24 °C	Relative Humidity: 56 %	Air Pressure: 1010 hPa	Power: 3.6 VDC
Remarks:			

Figure 7.6.1 Setup for spurious emission field strength measurements below 30 MHz

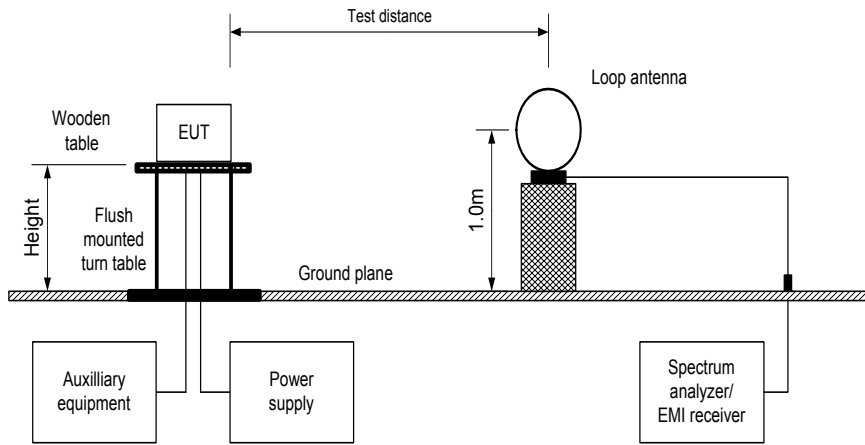
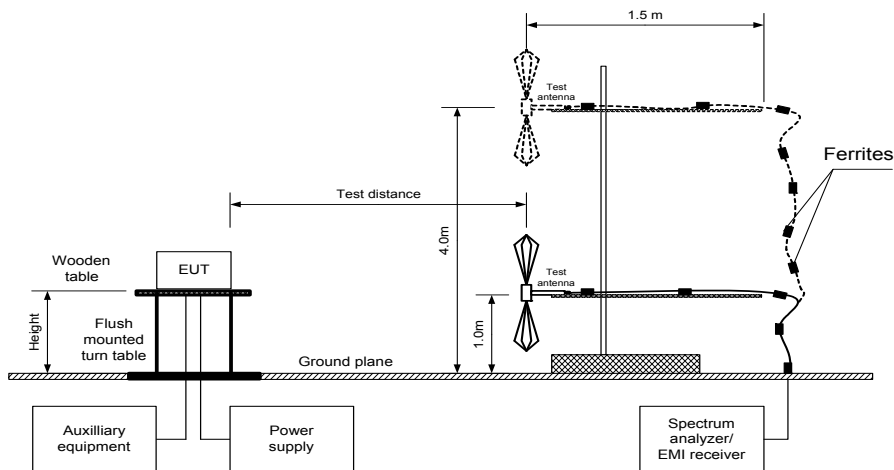

Figure 7.6.2 Setup for spurious emission field strength measurements from 30 to 1000 MHz





Test specification: Section 15.247(d), RSS-247 section 5.5 Radiated spurious emissions			
Test procedure: ANCI C63.10 section 6.5 & 6.6			
Test mode: Compliance		Verdict: PASS	
Date(s): 31-Jan-19			
Temperature: 24 °C	Relative Humidity: 56 %	Air Pressure: 1010 hPa	Power: 3.6 VDC
Remarks:			

Figure 7.6.3 Setup for spurious emission field strength measurements above 1000 MHz

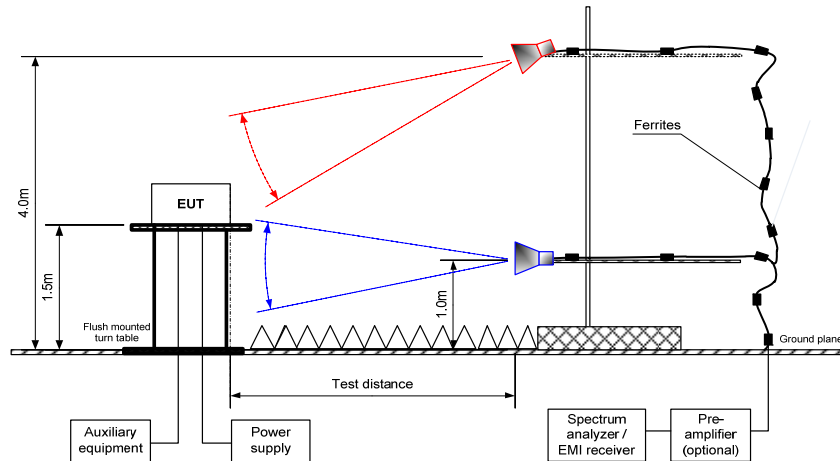

Table 7.6.2 Field strength of emissions outside restricted bands

ASSIGNED FREQUENCY: 902-928 MHz
 INVESTIGATED FREQUENCY RANGE: 0.009 - 9500 MHz
 TEST DISTANCE: 3 m
 MODULATION: 2FSK
 BIT RATE: 9.6 kbps
 DETECTOR USED: Peak
 RESOLUTION BANDWIDTH: 100 kHz
 VIDEO BANDWIDTH: 300 kHz
 TEST ANTENNA TYPE: Active loop (9 kHz – 30 MHz)
 Biconilog (30 MHz – 1000 MHz)
 Double ridged guide (above 1000 MHz)
 FREQUENCY HOPPING: Disabled

Frequency, MHz	Field strength of spurious, dB(μV/m)	Antenna polarization	Antenna height, m	Azimuth, degrees*	Field strength of carrier, dB(μV/m)	Attenuation below carrier, dBc	Limit, dBc	Margin, dB**	Verdict
Low carrier frequency									
901.925	79.85	Vertical	1.12	56	122.84	42.99	20.0	22.99	Pass
1804.774	62.96	Vertical	1.78	17		59.18		39.18	
Mid carrier frequency									
901.787	51.45	Vertical	1.32	125	123.44	71.99	20.0	51.99	Pass
1830.136	68.05	Horizontal	2.30	-121		55.39		35.39	
High carrier frequency									
901.812	53.13	Vertical	1.00	-78	121.96	68.83	20.0	48.83	Pass
928.009	85.56	Vertical	1.00	87		36.40		16.40	
1855.499	71.95	Vertical	1.00	-90		50.01		30.01	

*- EUT front panel refers to 0 degrees position of turntable.

**- Margin = Attenuation below carrier – specification limit.



Test specification: Section 15.247(d), RSS-247 section 5.5 Radiated spurious emissions			
Test procedure: ANCI C63.10 section 6.5 & 6.6			
Test mode: Compliance		Verdict: PASS	
Date(s): 31-Jan-19			
Temperature: 24 °C	Relative Humidity: 56 %	Air Pressure: 1010 hPa	Power: 3.6 VDC
Remarks:			

Table 7.6.3 Field strength of spurious emissions above 1 GHz within restricted bands

ASSIGNED FREQUENCY: 902-928 MHz
 INVESTIGATED FREQUENCY RANGE: 1000 - 9500 MHz
 TEST DISTANCE: 3 m
 MODULATION: 2FSK
 MODULATING SIGNAL: PRBS
 BIT RATE: 9.6 kbps
 DETECTOR USED: Peak
 RESOLUTION BANDWIDTH: 1000 kHz
 TEST ANTENNA TYPE: Double ridged guide
 FREQUENCY HOPPING: Disabled

Frequency, MHz	Antenna		Azimuth, degrees*	Peak field strength			Average field strength				Verdict
	Polarization	Height, m		Measured, dB(μV/m)	Limit, dB(μV/m)	Margin, dB**	Measured, dB(μV/m)	Calculated, dB(μV/m)	Limit, dB(μV/m)	Margin, dB***	
Low carrier frequency											
1097.254	Vertical	204	113	42.55	74.0	-31.45	36.27	NA	54.0	-17.73	Pass
2707.130	Vertical	178	79	52.67	74.0	-21.33	50.56	NA	54.0	-3.44	
3609.210	Vertical	231	110	44.01	74.0	-29.99	35.57	NA	54.0	-18.43	
Mid carrier frequency											
1110.185	Vertical	185	149	41.05	74.0	-32.95	33.86	NA	54.0	-20.14	Pass
2744.843	Horizontal	101	82	50.73	74.0	-23.27	48.33	NA	54.0	-5.67	
3659.935	Vertical	100	39	44.92	74.0	-29.08	37.53	NA	54.0	-16.47	
High carrier frequency											
1036.424	Vertical	152	138	41.72	74.0	-32.28	30.43	NA	54.0	-23.57	Pass
2783.230	Horizontal	230	57	52.52	74.0	-21.48	50.57	NA	54.0	-3.43	
3711.180	Vertical	230	113	43.20	74.0	-30.80	34.60	NA	54.0	-19.40	

*- EUT front panel refers to 0 degrees position of turntable.
 **- Margin = Measured field strength - specification limit.
 ***- Margin = Calculated field strength - specification limit,
 where Calculated field strength = Measured field strength + average factor.

Table 7.6.4 Average factor calculation

Transmission pulse		Transmission burst		Transmission train duration, ms	Average factor, dB
Duration, ms	Period, ms	Duration, ms	Period, ms		
NA	NA	NA	NA	NA	NA

*- Average factor was calculated as follows
 for pulse train shorter than 100 ms:

$$Average\ factor = 20 \times \log_{10} \left(\frac{Pulse\ duration}{Pulse\ period} \times \frac{Burst\ duration}{Train\ duration} \times Number\ of\ bursts\ within\ pulse\ train \right)$$

for pulse train longer than 100 ms:

$$Average\ factor = 20 \times \log_{10} \left(\frac{Pulse\ duration}{Pulse\ period} \times \frac{Burst\ duration}{100ms} \times Number\ of\ bursts\ within\ 100ms \right)$$



Test specification: Section 15.247(d), RSS-247 section 5.5 Radiated spurious emissions			
Test procedure: ANCI C63.10 section 6.5 & 6.6			
Test mode: Compliance		Verdict: PASS	
Date(s): 31-Jan-19			
Temperature: 24 °C	Relative Humidity: 56 %	Air Pressure: 1010 hPa	Power: 3.6 VDC
Remarks:			

Table 7.6.5 Field strength of spurious emissions below 1 GHz within restricted bands

ASSIGNED FREQUENCY: 902-928 MHz
 INVESTIGATED FREQUENCY RANGE: 0.009 – 1000 MHz
 TEST DISTANCE: 3 m
 MODULATION: 2FSK
 TEST ANTENNA TYPE: Active loop (9 kHz – 30 MHz)
 Biconilog (30 MHz – 1000 MHz)
 FREQUENCY HOPPING: Disabled

Frequency, MHz	Peak emission, dB(µV/m)	Quasi-peak			Antenna polarization	Antenna height, m	Turn-table position**, degrees	Verdict
		Measured emission, dB(µV/m)	Limit, dB(µV/m)	Margin, dB*				
Low carrier frequency								
975.033	41.03	36.33	54.0	-17.67	Vertical	101	92	Pass
985.631	39.13	34.89	54.0	-19.11	Vertical	101	97	
Mid carrier frequency								
974.991	43.99	40.59	54.0	-13.41	Vertical	103	74	Pass
992.997	39.98	35.59	54.0	-18.41	Vertical	103	92	
High carrier frequency								
966.809	44.19	40.31	54.0	-13.69	Vertical	101	92	Pass
974.991	44.84	41.58	54.0	-12.42	Vertical	102	92	
983.181	40.46	35.40	54.0	-18.60	Vertical	102	92	

*- Margin = Measured emission - specification limit.
 **- EUT front panel refer to 0 degrees position of turntable.



HERMON LABORATORIES

Test specification: Section 15.247(d), RSS-247 section 5.5 Radiated spurious emissions			
Test procedure: ANCI C63.10 section 6.5 & 6.6			
Test mode: Compliance		Verdict: PASS	
Date(s): 31-Jan-19			
Temperature: 24 °C	Relative Humidity: 56 %	Air Pressure: 1010 hPa	Power: 3.6 VDC
Remarks:			

Table 7.6.6 Restricted bands according to FCC section 15.205

MHz	MHz	MHz	MHz	MHz	GHz
0.09 - 0.11	8.37625 - 8.38675	73 - 74.6	399.9 - 410	2690 - 2900	10.6 - 12.7
0.495 - 0.505	8.41425 - 8.41475	74.8 - 75.2	608 - 614	3260 - 3267	13.25 - 13.4
2.1735 - 2.1905	12.29 - 12.293	108 - 121.94	960 - 1240	3332 - 3339	14.47 - 14.5
4.125 - 4.128	12.51975 - 12.52025	123 - 138	1300 - 1427	3345.8 - 3358	15.35 - 16.2
4.17725 - 4.17775	12.57675 - 12.57725	149.9 - 150.05	1435 - 1626.5	3600 - 4400	17.7 - 21.4
4.20725 - 4.20775	13.36 - 13.41	156.52475 - 156.52525	1645.5 - 1646.5	4500 - 5150	22.01 - 23.12
6.215 - 6.218	16.42 - 16.423	156.7 - 156.9	1660 - 1710	5350 - 5460	23.6 - 24
6.26775 - 6.26825	16.69475 - 16.69525	162.0125 - 167.17	1718.8 - 1722.2	7250 - 7750	31.2 - 31.8
6.31175 - 6.31225	16.80425 - 16.80475	167.72 - 173.2	2200 - 2300	8025 - 8500	36.43 - 36.5
8.291 - 8.294	25.5 - 25.67	240 - 285	2310 - 2390	9000 - 9200	Above 38.6
8.362 - 8.366	37.5 - 38.25	322 - 335.4	2483.5 - 2500	9300 - 9500	

Table 7.6.7 Restricted bands according to RSS-Gen

MHz	MHz	MHz	MHz	MHz	GHz
0.09 - 0.11	8.291 - 8.294	16.80425 - 16.80475	399.9 - 410	3260 - 3267	10.6 - 12.7
2.1735 - 2.1905	8.362 - 8.366	25.5 - 25.67	608 - 614	3332 - 3339	13.25 - 13.4
3.020 - 3.026	8.37625 - 8.38675	37.5 - 38.25	960 - 1427	3345.8 - 3358	14.47 - 14.5
4.125 - 4.128	8.41425 - 8.41475	73 - 74.6	1435 - 1626.5	3500 - 4400	15.35 - 16.2
4.17725 - 4.17775	12.29 - 12.293	74.8 - 75.2	1645.5 - 1646.5	4500 - 5150	17.7 - 21.4
4.20725 - 4.20775	12.51975 - 12.52025	108 - 138	1660 - 1710	5350 - 5460	22.01 - 23.12
5.677 - 5.683	12.57675 - 12.57725	156.52475 - 156.52525	1718.8 - 1722.2	7250 - 7750	23.6 - 24
6.215 - 6.218	13.36 - 13.41	156.7 - 156.9	2200 - 2300	8025 - 8500	31.2 - 31.8
6.26775 - 6.26825	16.42 - 16.423	240 - 285	2310 - 2390	9000 - 9200	36.43 - 36.5
6.31175 - 6.31225	16.69475 - 16.69525	322 - 335.4	2655 - 2900	9300 - 9500	Above 38.6

Reference numbers of test equipment used

HL 0446	HL 0604	HL 3903	HL 4360	HL 4933	HL 5405		
---------	---------	---------	---------	---------	---------	--	--

Full description is given in Appendix A.



Test specification: Section 15.247(d), RSS-247 section 5.5 Radiated spurious emissions			
Test procedure: ANCI C63.10 section 6.5 & 6.6			
Test mode: Compliance		Verdict: PASS	
Date(s): 31-Jan-19			
Temperature: 24 °C	Relative Humidity: 56 %	Air Pressure: 1010 hPa	Power: 3.6 VDC
Remarks:			

Plot 7.6.1 Radiated emission measurements from 9 kHz to 30 MHz at the low carrier frequency

TEST SITE: Semi anechoic chamber
TEST DISTANCE: 3 m
ANTENNA POLARIZATION: Vertical

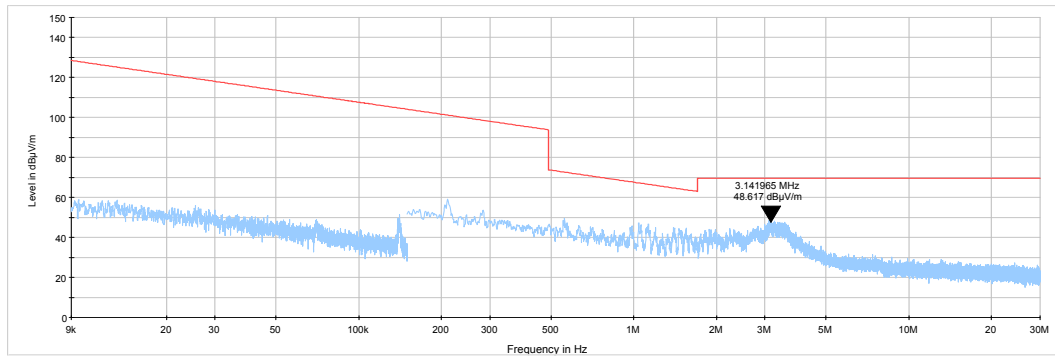

Plot 7.6.2 Radiated emission measurements from 9 kHz to 30 MHz at the mid carrier frequency

TEST SITE: Semi anechoic chamber
TEST DISTANCE: 3 m
ANTENNA POLARIZATION: Vertical

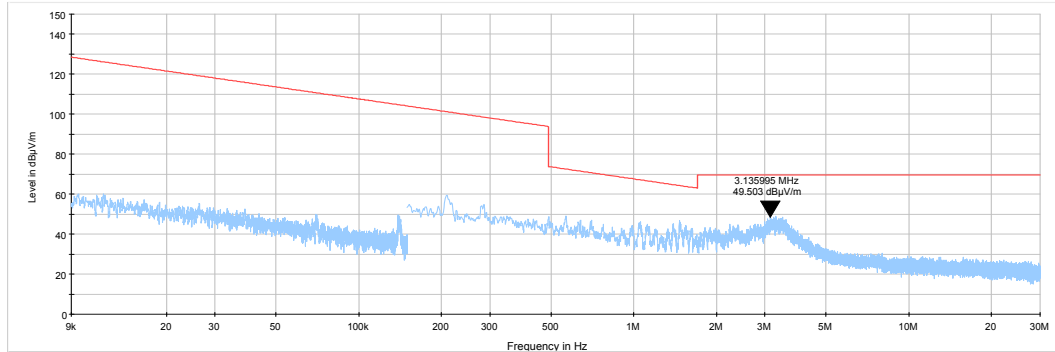

Plot 7.6.3 Radiated emission measurements from 9 kHz to 30 MHz at the high carrier frequency

TEST SITE: Semi anechoic chamber
TEST DISTANCE: 3 m
ANTENNA POLARIZATION: Vertical

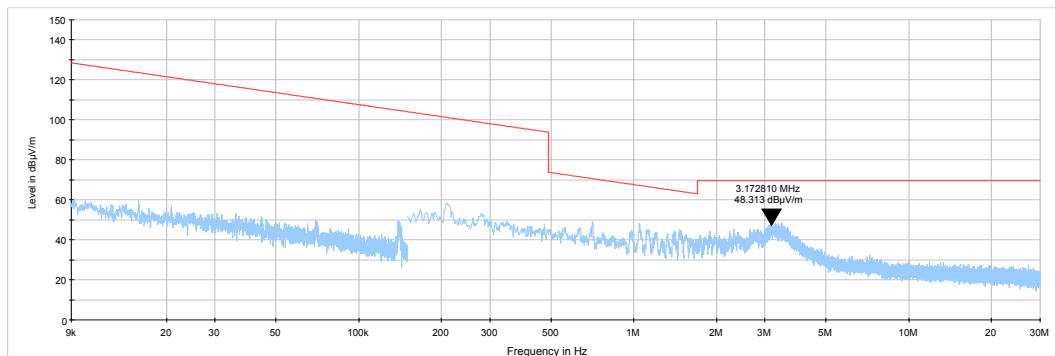



HERMON LABORATORIES

Test specification: Section 15.247(d), RSS-247 section 5.5 Radiated spurious emissions			
Test procedure: ANCI C63.10 section 6.5 & 6.6			
Test mode: Compliance		Verdict: PASS	
Date(s): 31-Jan-19			
Temperature: 24 °C	Relative Humidity: 56 %	Air Pressure: 1010 hPa	Power: 3.6 VDC
Remarks:			

Plot 7.6.4 Radiated emission measurements from 30 to 800 MHz at the low carrier frequency

TEST SITE: Semi anechoic chamber
TEST DISTANCE: 3 m
ANTENNA POLARIZATION: Vertical and Horizontal

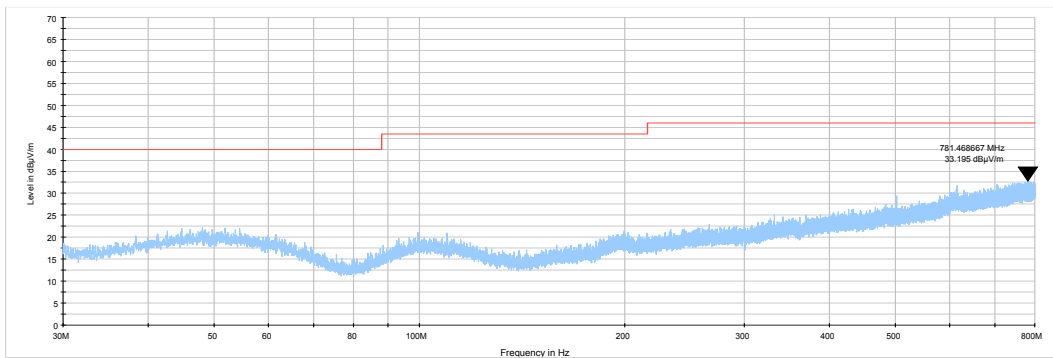

Plot 7.6.5 Radiated emission measurements from 800 to 902 MHz at the low carrier frequency

TEST SITE: Semi anechoic chamber
TEST DISTANCE: 3 m
ANTENNA POLARIZATION: Vertical and Horizontal

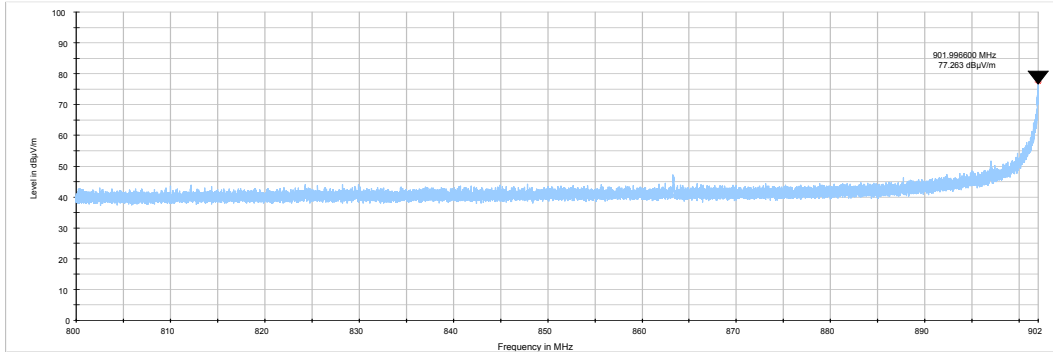



HERMON LABORATORIES

Test specification: Section 15.247(d), RSS-247 section 5.5 Radiated spurious emissions			
Test procedure: ANCI C63.10 section 6.5 & 6.6			
Test mode: Compliance		Verdict: PASS	
Date(s): 31-Jan-19			
Temperature: 24 °C	Relative Humidity: 56 %	Air Pressure: 1010 hPa	Power: 3.6 VDC
Remarks:			

Plot 7.6.6 Radiated emission measurements from 30 to 902 MHz at the mid carrier frequency

TEST SITE: Semi anechoic chamber
TEST DISTANCE: 3 m
ANTENNA POLARIZATION: Vertical and Horizontal

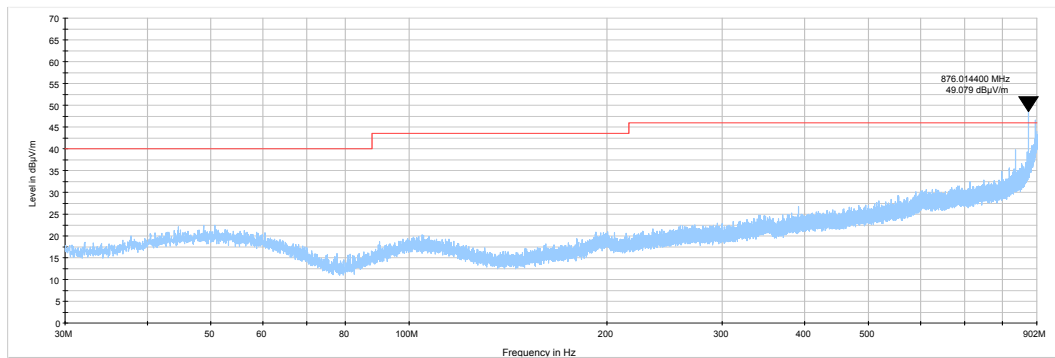

Plot 7.6.7 Radiated emission measurements from 30 to 902 MHz at the high carrier frequency

TEST SITE: Semi anechoic chamber
TEST DISTANCE: 3 m
ANTENNA POLARIZATION: Vertical and Horizontal

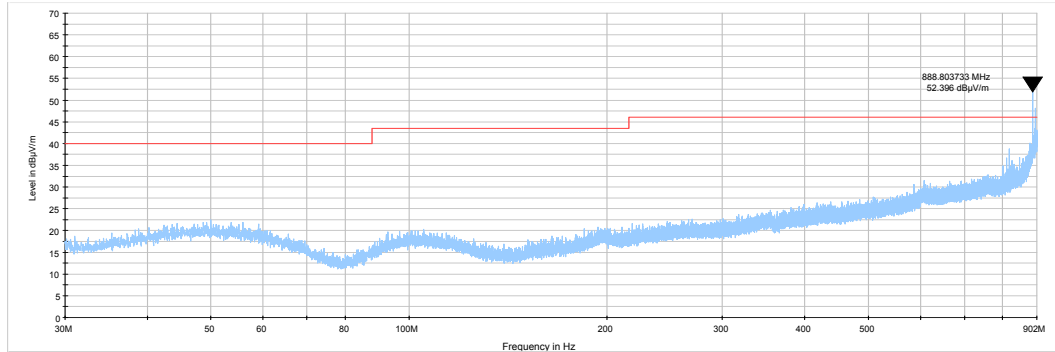



Test specification: Section 15.247(d), RSS-247 section 5.5 Radiated spurious emissions			
Test procedure: ANCI C63.10 section 6.5 & 6.6			
Test mode: Compliance		Verdict: PASS	
Date(s): 31-Jan-19			
Temperature: 24 °C	Relative Humidity: 56 %	Air Pressure: 1010 hPa	Power: 3.6 VDC
Remarks:			

Plot 7.6.8 Radiated emission measurements from 928 to 960 MHz at the low carrier frequency

TEST SITE: Semi anechoic chamber
TEST DISTANCE: 3 m
ANTENNA POLARIZATION: Vertical and Horizontal

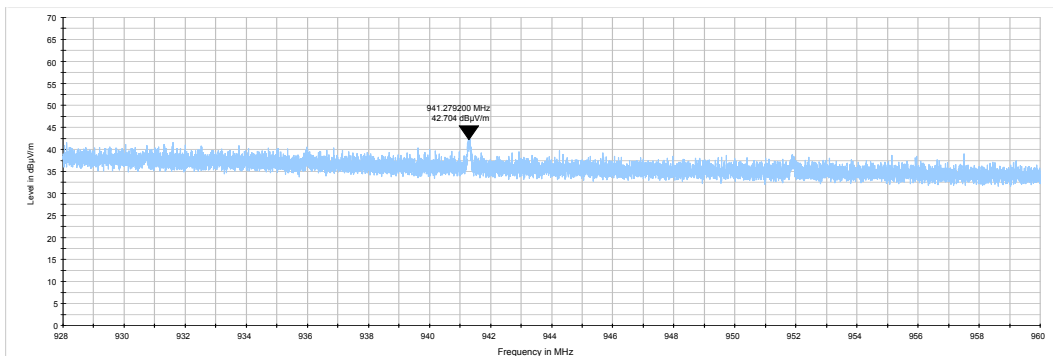

Plot 7.6.9 Radiated emission measurements from 928 to 960 MHz at the mid carrier frequency

TEST SITE: Semi anechoic chamber
TEST DISTANCE: 3 m
ANTENNA POLARIZATION: Vertical and Horizontal

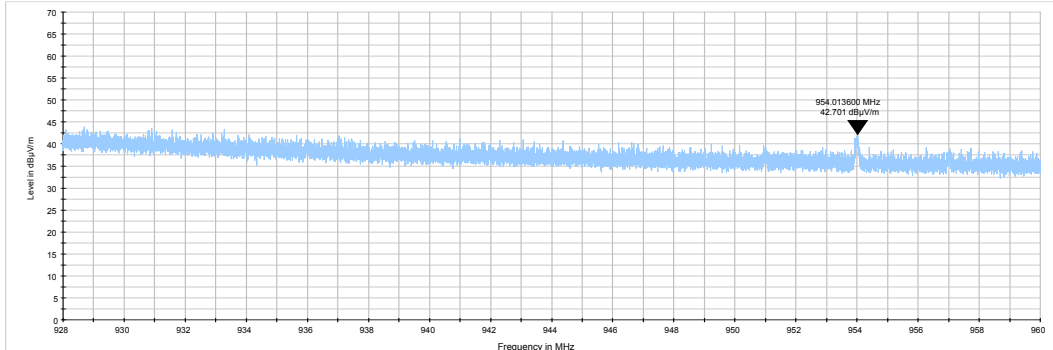

Plot 7.6.10 Radiated emission measurements from 928 to 960 MHz at the high carrier frequency

TEST SITE: Semi anechoic chamber
TEST DISTANCE: 3 m
ANTENNA POLARIZATION: Vertical and Horizontal

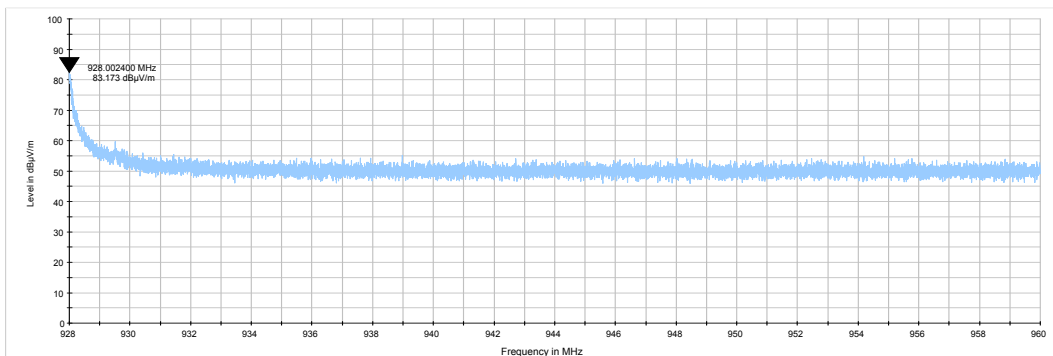



HERMON LABORATORIES

Test specification: Section 15.247(d), RSS-247 section 5.5 Radiated spurious emissions			
Test procedure: ANCI C63.10 section 6.5 & 6.6			
Test mode: Compliance		Verdict: PASS	
Date(s): 31-Jan-19			
Temperature: 24 °C	Relative Humidity: 56 %	Air Pressure: 1010 hPa	Power: 3.6 VDC
Remarks:			

Plot 7.6.11 Radiated emission measurements from 960-1000 MHz at the low carrier frequency

TEST SITE: Semi anechoic chamber
TEST DISTANCE: 3 m
ANTENNA POLARIZATION: Vertical and Horizontal

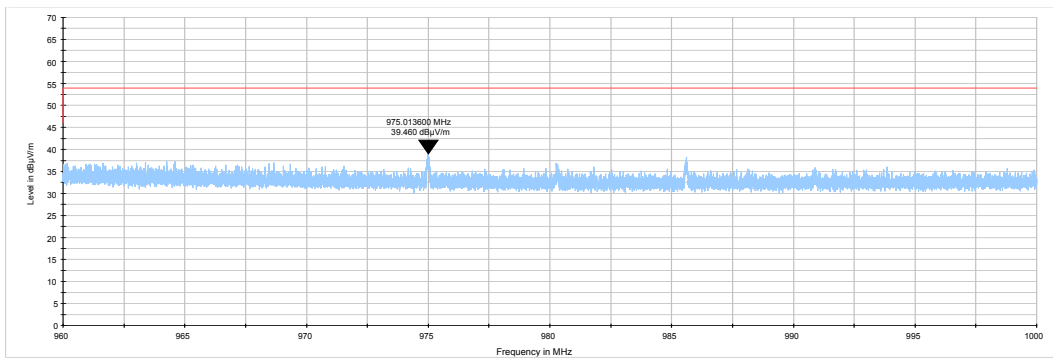

Plot 7.6.12 Radiated emission measurements from 960-1000 MHz at the mid carrier frequency

TEST SITE: Semi anechoic chamber
TEST DISTANCE: 3 m
ANTENNA POLARIZATION: Vertical and Horizontal

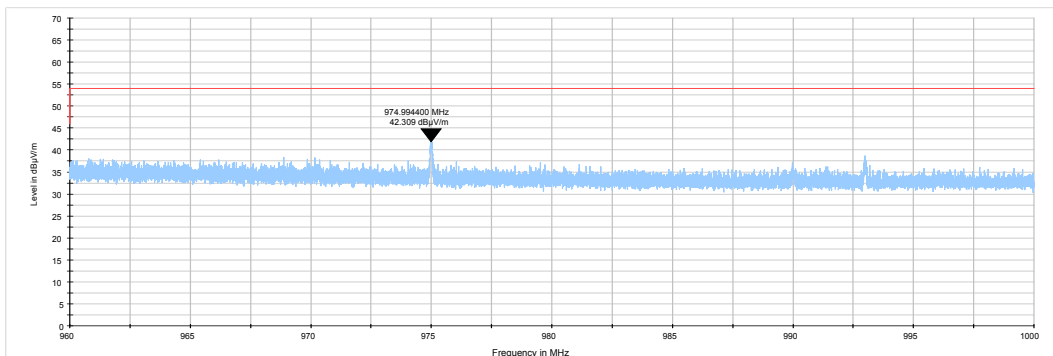

Plot 7.6.13 Radiated emission measurements from 960-1000 MHz at the high carrier frequency

TEST SITE: Semi anechoic chamber
TEST DISTANCE: 3 m
ANTENNA POLARIZATION: Vertical and Horizontal

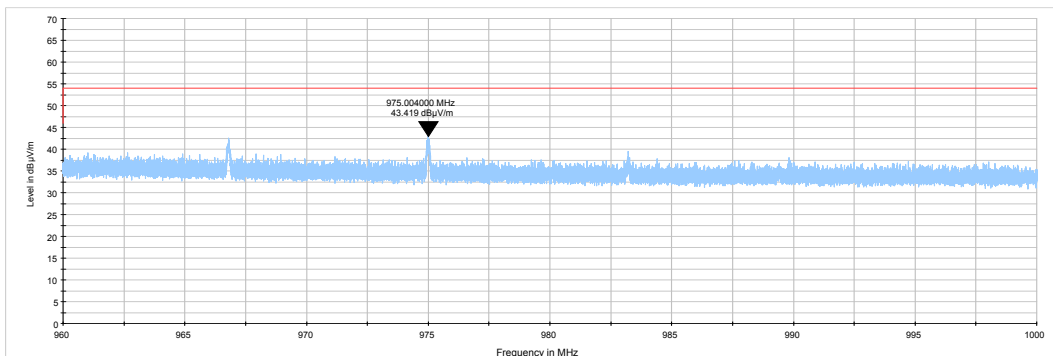



HERMON LABORATORIES

Test specification: Section 15.247(d), RSS-247 section 5.5 Radiated spurious emissions			
Test procedure: ANCI C63.10 section 6.5 & 6.6			
Test mode: Compliance		Verdict: PASS	
Date(s): 31-Jan-19			
Temperature: 24 °C	Relative Humidity: 56 %	Air Pressure: 1010 hPa	Power: 3.6 VDC
Remarks:			

Plot 7.6.14 Radiated emission measurements from 1 – 9.5 GHz at the low carrier frequency

TEST SITE: Semi anechoic chamber
TEST DISTANCE: 3 m
ANTENNA POLARIZATION: Vertical and Horizontal

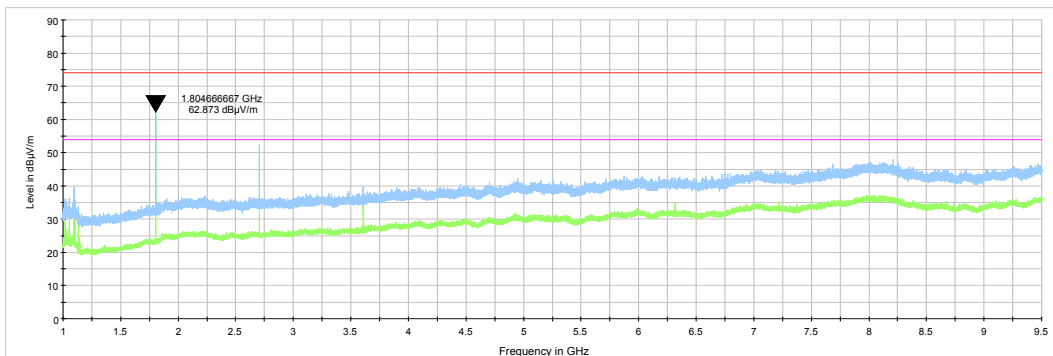

Plot 7.6.15 Radiated emission measurements from 1 – 2.5 GHz at the mid carrier frequency

TEST SITE: Semi anechoic chamber
TEST DISTANCE: 3 m
ANTENNA POLARIZATION: Vertical and Horizontal

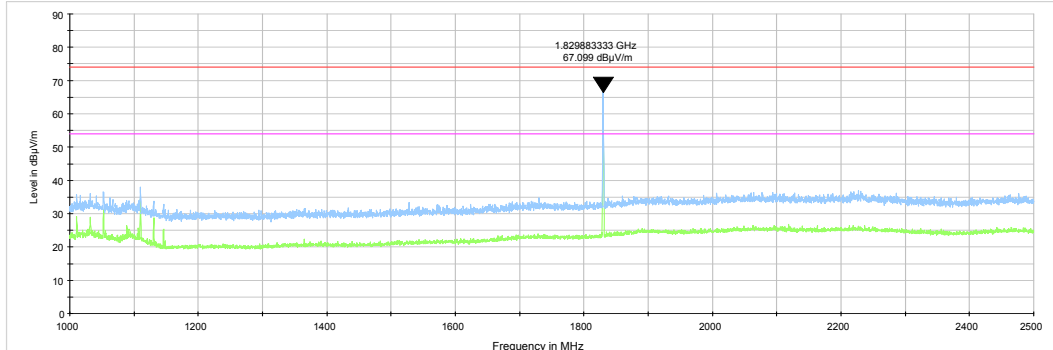

Plot 7.6.16 Radiated emission measurements from 2.5 – 3 GHz at the mid carrier frequency

TEST SITE: Semi anechoic chamber
TEST DISTANCE: 3 m
ANTENNA POLARIZATION: Vertical and Horizontal

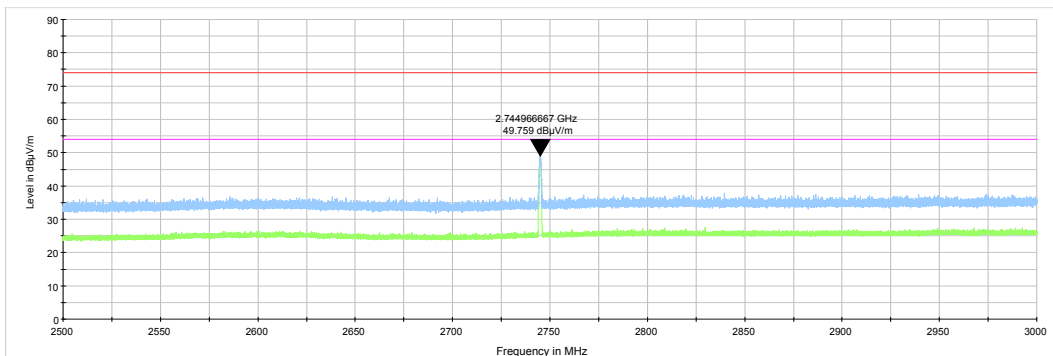



Test specification: Section 15.247(d), RSS-247 section 5.5 Radiated spurious emissions			
Test procedure: ANCI C63.10 section 6.5 & 6.6			
Test mode: Compliance		Verdict: PASS	
Date(s): 31-Jan-19			
Temperature: 24 °C	Relative Humidity: 56 %	Air Pressure: 1010 hPa	Power: 3.6 VDC
Remarks:			

Plot 7.6.17 Radiated emission measurements from 3 – 9.5 GHz at the mid carrier frequency

TEST SITE: Semi anechoic chamber
TEST DISTANCE: 3 m
ANTENNA POLARIZATION: Vertical and Horizontal

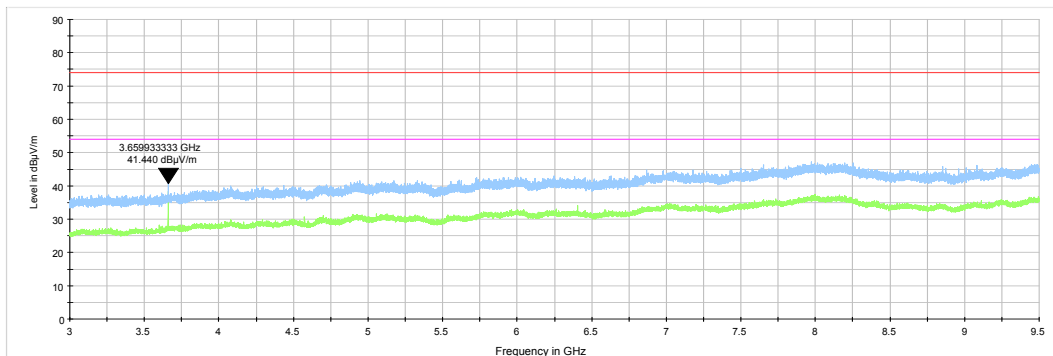

Plot 7.6.18 Radiated emission measurements from 1 – 2.5 GHz at the high carrier frequency

TEST SITE: Semi anechoic chamber
TEST DISTANCE: 3 m
ANTENNA POLARIZATION: Vertical and Horizontal

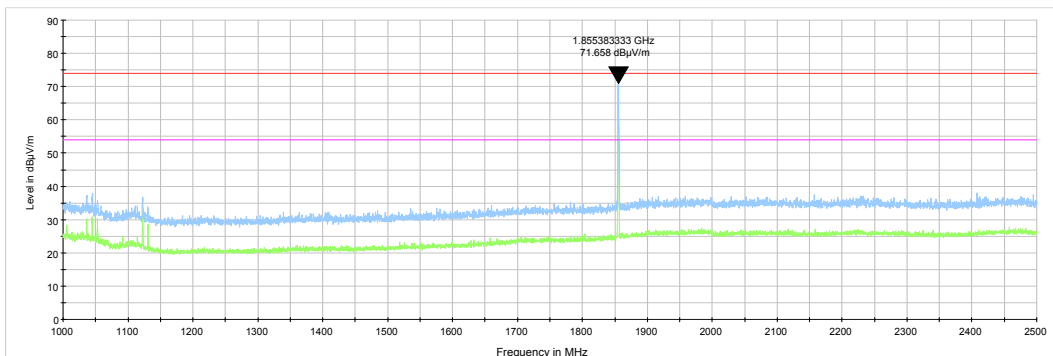

Plot 7.6.19 Radiated emission measurements from 2.5 – 3.9 GHz at the high carrier frequency

TEST SITE: Semi anechoic chamber
TEST DISTANCE: 3 m
ANTENNA POLARIZATION: Vertical and Horizontal

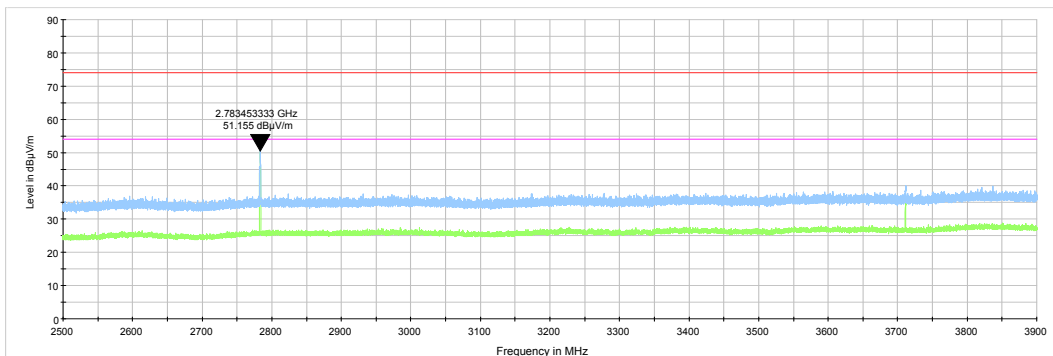



HERMON LABORATORIES

Test specification: Section 15.247(d), RSS-247 section 5.5 Radiated spurious emissions			
Test procedure: ANCI C63.10 section 6.5 & 6.6			
Test mode: Compliance		Verdict: PASS	
Date(s): 31-Jan-19			
Temperature: 24 °C	Relative Humidity: 56 %	Air Pressure: 1010 hPa	Power: 3.6 VDC
Remarks:			

Plot 7.6.20 Radiated emission measurements from 3.9 – 9.5 GHz at the high carrier frequency

TEST SITE: Semi anechoic chamber
TEST DISTANCE: 3 m
ANTENNA POLARIZATION: Vertical and Horizontal

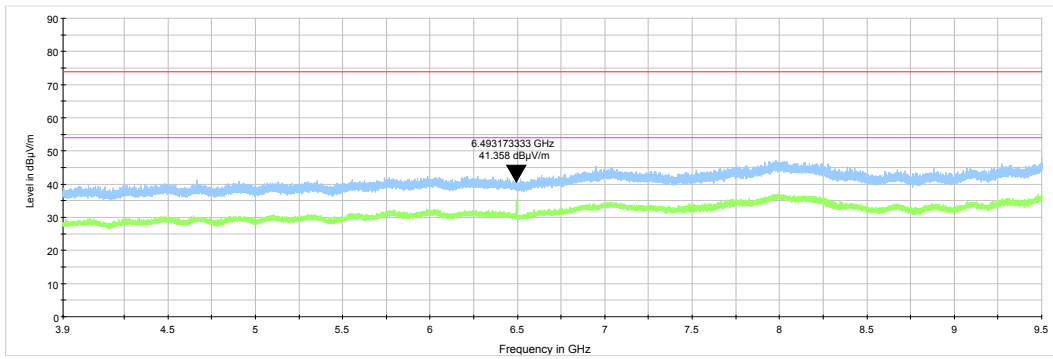



Test specification: Section 15.247(d), RSS-247 section 5.5 Emissions at band edges			
Test procedure: ANSI C63.10 section 6.10			
Test mode: Compliance		Verdict: PASS	
Date(s): 06-Jun-19			
Temperature: 24 °C	Relative Humidity: 47 %	Air Pressure: 1012 hPa	Power: 3.6 VDC
Remarks:			

7.7 Band edge radiated emissions

7.7.1 General

This test was performed to measure emissions, radiated from the EUT at the assigned frequency band edges. Specification test limits are given in Table 7.7.1.

Table 7.7.1 Band edge emission limits

Assigned frequency, MHz	Attenuation below carrier*, dBc	Field strength at 3 m within restricted bands, dB(µV/m)	
		Peak	Average
902.0 – 928.0	20.0	74.0	54.0
2400.0 – 2483.5			
5725.0 – 5850.0			

* - Band edge emission limit is provided in terms of attenuation below the peak of modulated carrier measured with the same resolution bandwidth.

7.7.2 Test procedure

- 7.7.2.1 The EUT was set up as shown in Figure 7.7.1, energized normally modulated at the maximum data rate with its hopping function disabled and its proper operation was checked.
- 7.7.2.2 The EUT was adjusted to produce maximum available to end user RF output power at the lowest carrier frequency.
- 7.7.2.3 The spectrum analyzer span was set to capture the carrier frequency and associated modulation products. The resolution bandwidth was set wider than 1 % of the frequency span.
- 7.7.2.4 The spectrum analyzer was set in max hold mode and allowed trace to stabilize. The highest emission level within the authorized band was measured.
- 7.7.2.5 The maximum band edge emission and modulation product outside of the band were measured as provided in Table 7.7.2 and associated plots and referenced to the highest emission level measured within the authorized band.
- 7.7.2.6 The above procedure was repeated with the EUT adjusted to produce maximum RF output power at the highest carrier frequency.
- 7.7.2.7 The above procedure was repeated with the frequency hopping function enabled.

Figure 7.7.1 Band edge emission test setup





Test specification: Section 15.247(d), RSS-247 section 5.5 Emissions at band edges			
Test procedure: ANSI C63.10 section 6.10			
Test mode: Compliance		Verdict: PASS	
Date(s): 06-Jun-19			
Temperature: 24 °C	Relative Humidity: 47 %	Air Pressure: 1012 hPa	Power: 3.6 VDC
Remarks:			

Table 7.7.2 Band edge emission test results

ASSIGNED FREQUENCY RANGE: 902.0 – 928.0 MHz
DETECTOR USED: Peak
RESOLUTION BANDWIDTH: 100 kHz
VIDEO BANDWIDTH: 300 kHz
MODULATION: 2FSK
BIT RATE: 9.6 kbps

Frequency, MHz	Band edge emission, dBm	Emission at carrier, dBm	Attenuation below carrier, dBc	Limit, dBc	Margin, dB*	Verdict
Frequency hopping disabled						
902.000	-90.61	-42.73	47.88	20.0	27.88	Pass
928.000	-82.91	-45.94	36.97		16.97	
Frequency hopping enabled						
901.977	-27.49	0.25	27.74	20.0	7.74	Pass
928.002	-28.55	-3.78	24.77		4.77	

*- Margin = Attenuation below carrier – specification limit.

MODULATION: 2FSK
BIT RATE: 38.4 kbps

Frequency, MHz	Band edge emission, dBm	Emission at carrier, dBm	Attenuation below carrier, dBc	Limit, dBc	Margin, dB*	Verdict
Frequency hopping disabled						
902.000	-82.47	-42.73	39.74	20.0	19.74	Pass
928.000	-53.61	-25.50	28.11		8.11	
Frequency hopping enabled						
901.897	-35.28	-5.49	29.79	20.0	9.79	Pass
928.022	-29.74	-3.97	25.77		5.77	

*- Margin = Attenuation below carrier – specification limit.

MODULATION: GFSK
BIT RATE: 50.0 kbps

Frequency, MHz	Band edge emission, dBm	Emission at carrier, dBm	Attenuation below carrier, dBc	Limit, dBc	Margin, dB*	Verdict
Frequency hopping disabled						
902.000	-86.20	-24.64	61.56	20.0	41.56	Pass
928.000	-78.58	-19.69	58.89		38.89	
Frequency hopping enabled						
901.771	-56.97	-10.35	46.62	20.0	26.62	Pass
928.099	-43.51	-7.41	36.10		16.10	

*- Margin = Attenuation below carrier – specification limit.

Reference numbers of test equipment used

HL 0337	HL 4135	HL 4355				
---------	---------	---------	--	--	--	--

Full description is given in Appendix A.



HERMON LABORATORIES

Test specification: Section 15.247(d), RSS-247 section 5.5 Emissions at band edges			
Test procedure: ANSI C63.10 section 6.10			
Test mode: Compliance		Verdict: PASS	
Date(s): 06-Jun-19			
Temperature: 24 °C	Relative Humidity: 47 %	Air Pressure: 1012 hPa	Power: 3.6 VDC
Remarks:			

Plot 7.7.1 The lowest band edge emission at low carrier frequency with 2FSK 9.6 kbps with hopping function disabled

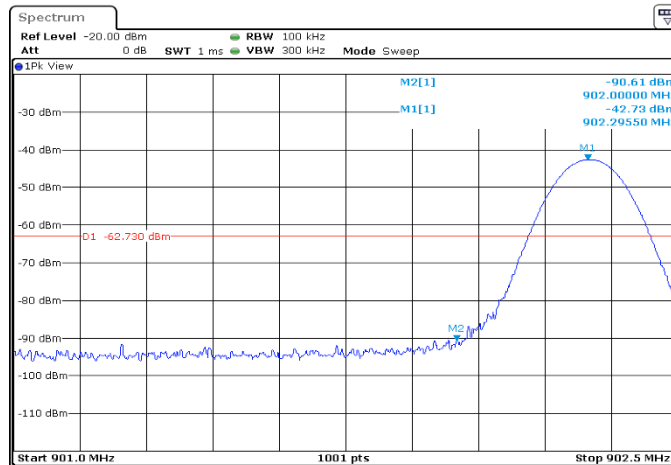

Plot 7.7.2 The lowest band edge emission at low carrier frequency with 2FSK 9.6 kbps with hopping function enabled

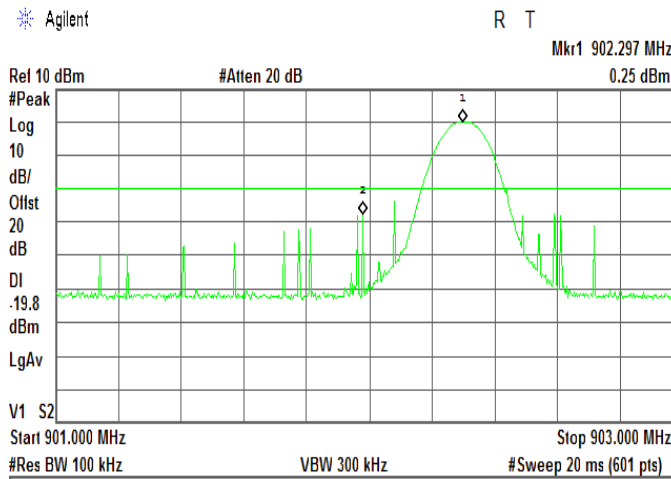



HERMON LABORATORIES

Test specification: Section 15.247(d), RSS-247 section 5.5 Emissions at band edges			
Test procedure: ANSI C63.10 section 6.10			
Test mode: Compliance		Verdict: PASS	
Date(s): 06-Jun-19			
Temperature: 24 °C	Relative Humidity: 47 %	Air Pressure: 1012 hPa	Power: 3.6 VDC
Remarks:			

Plot 7.7.3 The highest band edge emission at high carrier frequency with 2FSK 9.6 kbps with hopping function disabled

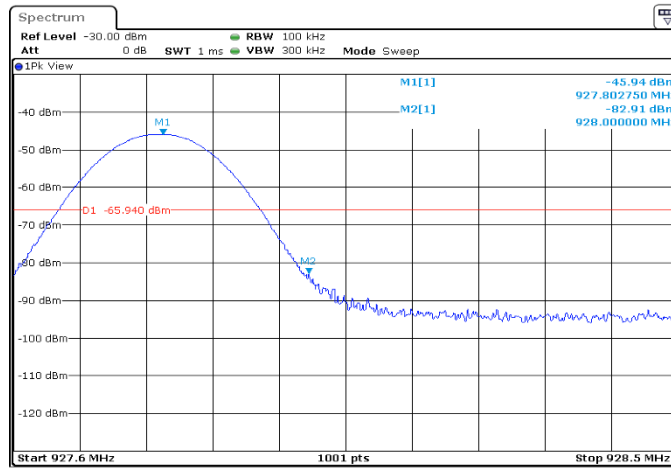

Plot 7.7.4 The highest band edge emission at high carrier frequency with 2FSK 9.6 kbps with hopping function enabled

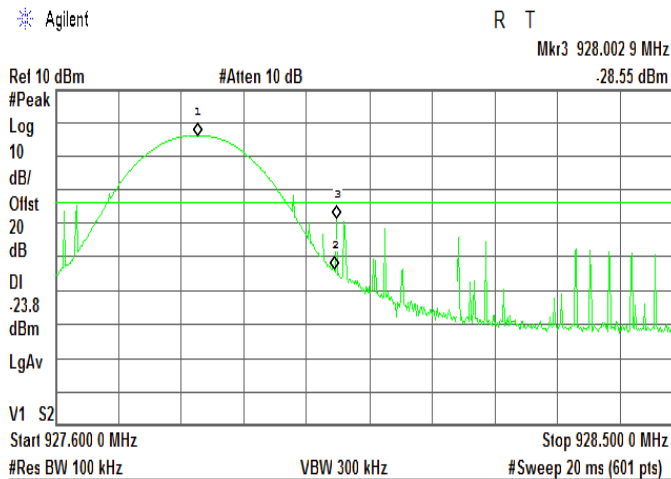



HERMON LABORATORIES

Test specification: Section 15.247(d), RSS-247 section 5.5 Emissions at band edges			
Test procedure: ANSI C63.10 section 6.10			
Test mode: Compliance		Verdict: PASS	
Date(s): 06-Jun-19			
Temperature: 24 °C	Relative Humidity: 47 %	Air Pressure: 1012 hPa	Power: 3.6 VDC
Remarks:			

Plot 7.7.5 The lowest band edge emission at low carrier frequency with 2FSK 38.4 kbps with hopping function disabled

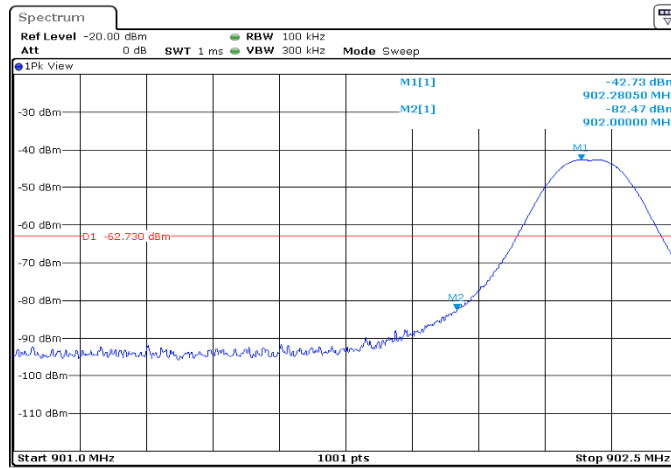

Plot 7.7.6 The lowest band edge emission at low carrier frequency with 2FSK 38.4 kbps with hopping function enabled

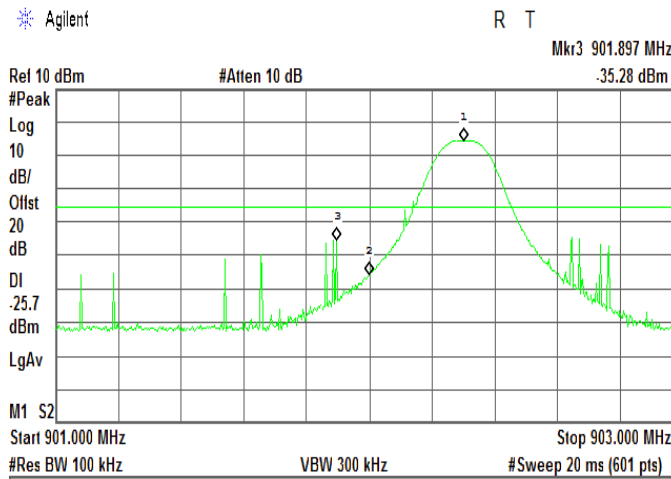



HERMON LABORATORIES

Test specification: Section 15.247(d), RSS-247 section 5.5 Emissions at band edges			
Test procedure: ANSI C63.10 section 6.10			
Test mode: Compliance		Verdict: PASS	
Date(s): 06-Jun-19			
Temperature: 24 °C	Relative Humidity: 47 %	Air Pressure: 1012 hPa	Power: 3.6 VDC
Remarks:			

Plot 7.7.7 The highest band edge emission at high carrier frequency with 2FSK 38.4 kbps with hopping function disabled

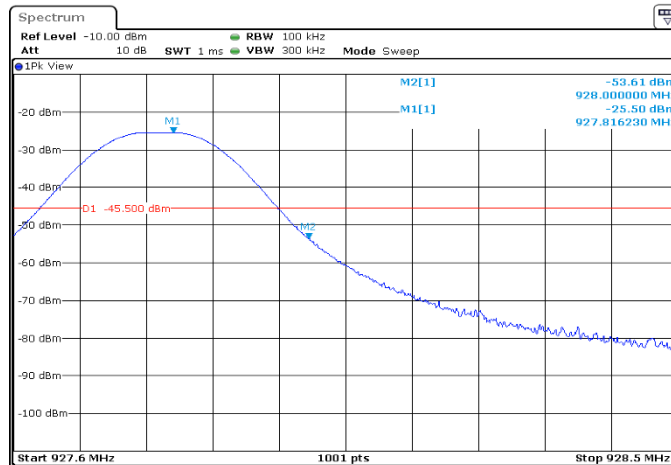

Plot 7.7.8 The highest band edge emission at high carrier frequency with 2FSK 38.4 kbps with hopping function enabled

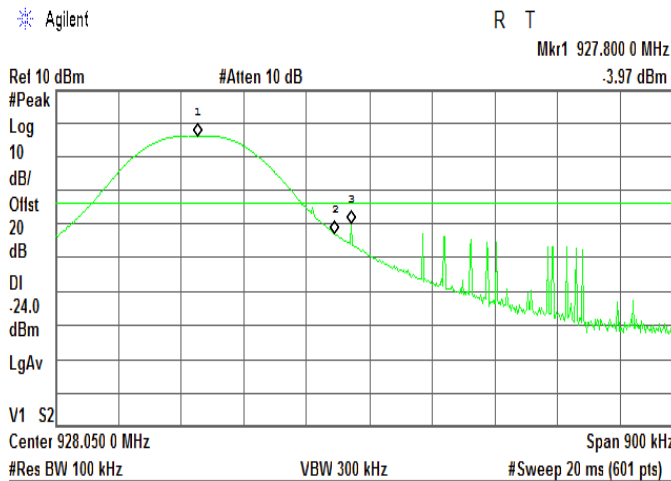



Test specification: Section 15.247(d), RSS-247 section 5.5 Emissions at band edges			
Test procedure: ANSI C63.10 section 6.10			
Test mode: Compliance		Verdict: PASS	
Date(s): 06-Jun-19			
Temperature: 24 °C	Relative Humidity: 47 %	Air Pressure: 1012 hPa	Power: 3.6 VDC
Remarks:			

Plot 7.7.9 The lowest band edge emission at low carrier frequency with GFSK 50.0 kbps with hopping function disabled

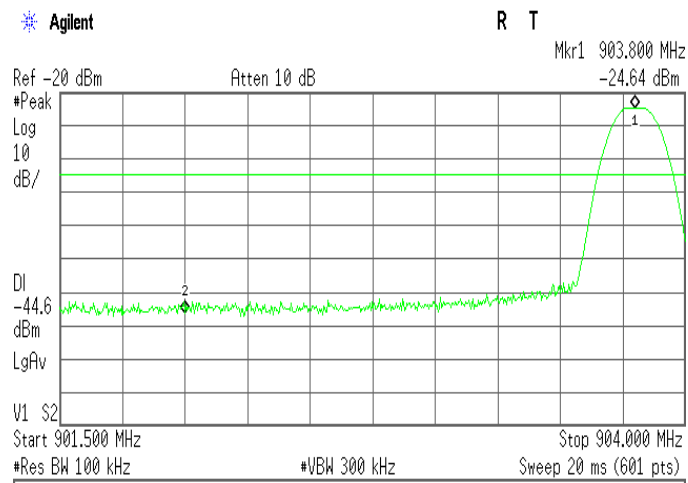

Plot 7.7.10 The lowest band edge emission at low carrier frequency with GFSK 50.0 kbps with hopping function enabled

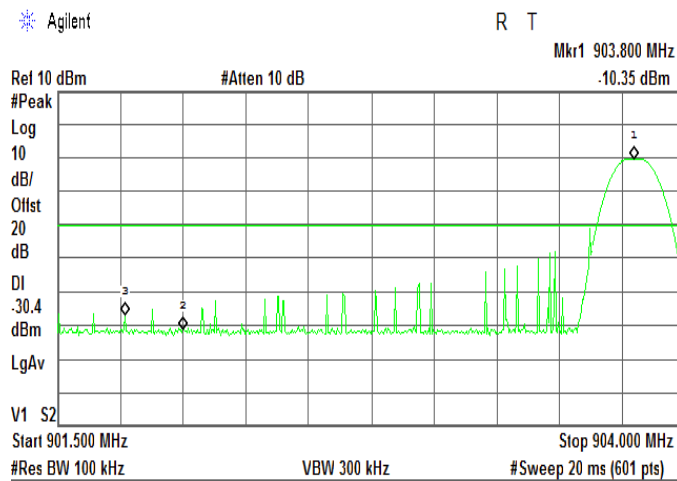



Test specification: Section 15.247(d), RSS-247 section 5.5 Emissions at band edges			
Test procedure: ANSI C63.10 section 6.10			
Test mode: Compliance		Verdict: PASS	
Date(s): 06-Jun-19			
Temperature: 24 °C	Relative Humidity: 47 %	Air Pressure: 1012 hPa	Power: 3.6 VDC
Remarks:			

Plot 7.7.11 The highest band edge emission at high carrier frequency GFSK 50.0 kbps without hopping function disabled

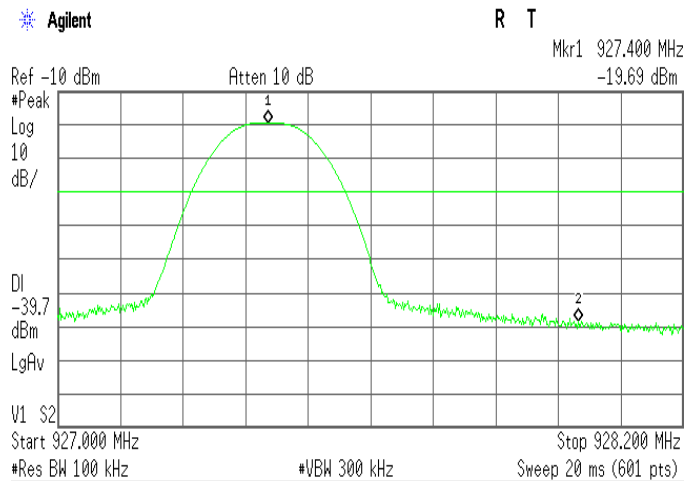

Plot 7.7.12 The highest band edge emission at high carrier frequency GFSK 50.0 kbps without hopping function enabled

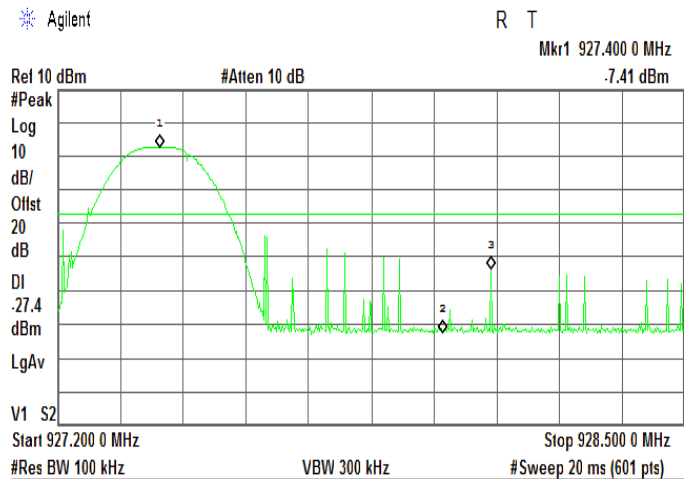



Test specification: FCC Part 15 section 203 / RSS Gen Section 6.8, Antenna requirements			
Test procedure: Visual inspection			
Test mode: Compliance		Verdict: PASS	
Date(s): 14-Feb-19			
Temperature: 23 °C	Relative Humidity: 44 %	Air Pressure: 1009 hPa	Power:
Remarks:			

7.8 Antenna requirements

The EUT was verified for compliance with antenna requirements. A transmitter shall be designed to ensure that no antenna other than that furnished by the responsible party will be used with the device. It may be either permanently attached or employs a unique antenna connector for every antenna proposed for use with the EUT. This requirement does not apply to professionally installed transmitters.

The rationale for compliance with the above requirements was either visual inspection results or supplier declaration. The summary of results is provided in Table 7.8.1.

Table 7.8.1 Antenna requirements

Requirement	Rationale	Verdict
The transmitter antenna is permanently attached	Visual inspection	Comply
The transmitter employs a unique antenna connector	NA	
The transmitter requires professional installation	NA	



Test specification: Section 15.109, ICES-003 , section 6.2 , Class B Radiated emission			
Test procedure: ANSI C63.4, Sections 12.2.5			
Test mode: Compliance		Verdict: PASS	
Date(s): 31-Jan-19			
Temperature: 24 °C	Relative Humidity: 56 %	Air Pressure: 1010 hPa	Power: 3.6 VDC
Remarks:			

8 Unintentional emissions according to 47CFR part 15 subpart B

8.1 Radiated emission measurements

8.1.1 General

This test was performed to measure radiated emissions from the EUT enclosure. Specification test limits are given in Table 8.1.1.

Table 8.1.1 Radiated emission test limits

Frequency, MHz	Class B limit, dB(μV/m)		Class A limit, dB(μV/m)	
	10 m distance	3 m distance	10 m distance	3 m distance
30 - 88	29.5*	40.0	39.0	49.5*
88 - 216	33.0*	43.5	43.5	54.0*
216 - 960	35.5*	46.0	46.4	56.9*
Above 960	43.5*	54.0	49.5	60.0*

* The limit for test distance other than specified was calculated using the inverse linear distance extrapolation factor as follows: $Lim_{S2} = Lim_{S1} + 20 \log(S1/S2)$, where $S1$ and $S2$ – standard defined and test distance respectively in meters.

8.1.2 Test procedure for measurements in semi-anechoic chamber

8.1.2.1 The EUT was set up as shown in Figure 8.1.1 and associated photograph/s, energized and the performance check was conducted.

8.1.2.2 The specified frequency range was investigated with biconilog antenna connected to EMI receiver. To find maximum radiation the turntable was rotated 360°, the measuring antenna height was changed from 1 to 4 m, its polarization was switched from vertical to horizontal and the EUT cables position was varied.

8.1.2.3 The worst test results (the lowest margins) were recorded in Table 8.1.2 and shown in the associated plots.

Figure 8.1.1 Setup for radiated emission measurements in anechoic chamber, table-top equipment

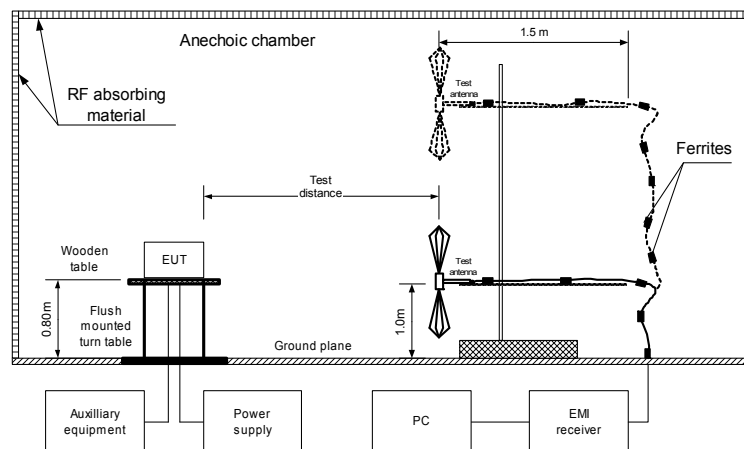



Test specification: Section 15.109, ICES-003 , section 6.2 , Class B Radiated emission			
Test procedure: ANSI C63.4, Sections 12.2.5			
Test mode: Compliance		Verdict: PASS	
Date(s): 31-Jan-19			
Temperature: 24 °C	Relative Humidity: 56 %	Air Pressure: 1010 hPa	Power: 3.6 VDC
Remarks:			

Table 8.1.2 Radiated emission test results

EUT SET UP: TABLE-TOP
 LIMIT: Class B
 EUT OPERATING MODE: Receive
 TEST SITE: SEMI ANECHOIC CHAMBER
 TEST DISTANCE: 3 m
 DETECTORS USED: PEAK / QUASI-PEAK
 FREQUENCY RANGE: 30 MHz – 1000 MHz
 RESOLUTION BANDWIDTH: 120 kHz

Frequency, MHz	Peak emission, dB(μV/m)	Quasi-peak			Antenna polarization	Antenna height, m	Turn-table position**, degrees	Verdict
		Measured emission, dB(μV/m)	Limit, dB(μV/m)	Margin, dB*				
No emission were found								Pass

TEST SITE: SEMI ANECHOIC CHAMBER
 TEST DISTANCE: 3 m
 DETECTORS USED: PEAK / AVERAGE
 FREQUENCY RANGE: 1000 MHz – 5000 MHz
 RESOLUTION BANDWIDTH: 1000 kHz

Frequency, MHz	Peak			Average			Antenna polarization	Antenna height, m	Turn-table position**, degrees	Verdict
	Measured emission, dB(μV/m)	Limit, dB(μV/m)	Margin, dB*	Measured emission, dB(μV/m)	Limit, dB(μV/m)	Margin, dB*				
No emission were found										Pass

*- Margin = Measured emission - specification limit.
 **- EUT front panel refer to 0 degrees position of turntable.

Reference numbers of test equipment used

HL 0604	HL 3903	HL 4360	HL 4933	HL 5405			
---------	---------	---------	---------	---------	--	--	--

Full description is given in Appendix A.



Test specification: Section 15.109, ICES-003 , section 6.2 , Class B Radiated emission			
Test procedure: ANSI C63.4, Sections 12.2.5			
Test mode: Compliance		Verdict: PASS	
Date(s): 31-Jan-19			
Temperature: 24 °C	Relative Humidity: 56 %	Air Pressure: 1010 hPa	Power: 3.6 VDC
Remarks:			

Plot 8.1.1 Radiated emission measurements in 30 - 1000 MHz range, vertical and horizontal antenna polarization

TEST SITE: Semi anechoic chamber
LIMIT: Class B
TEST DISTANCE: 3 m
EUT OPERATING MODE: Receive

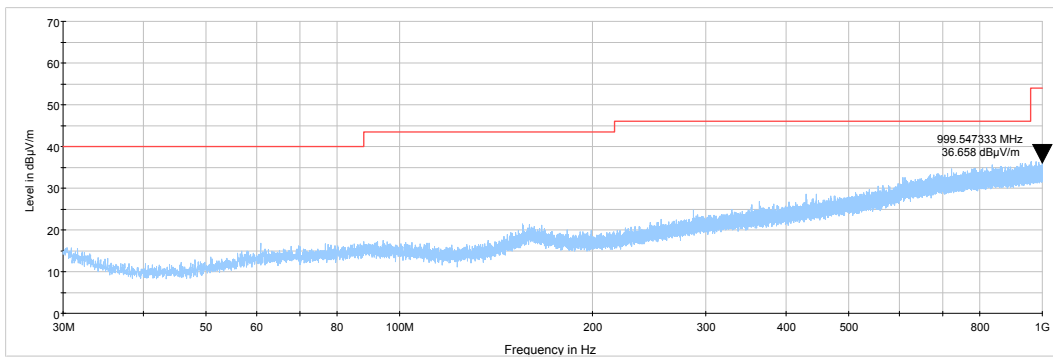

Plot 8.1.2 Radiated emission measurements in 1 - 5 GHz range, vertical and horizontal antenna polarization

TEST SITE: Semi anechoic chamber
LIMIT: Class B
TEST DISTANCE: 3 m
EUT OPERATING MODE: Receive

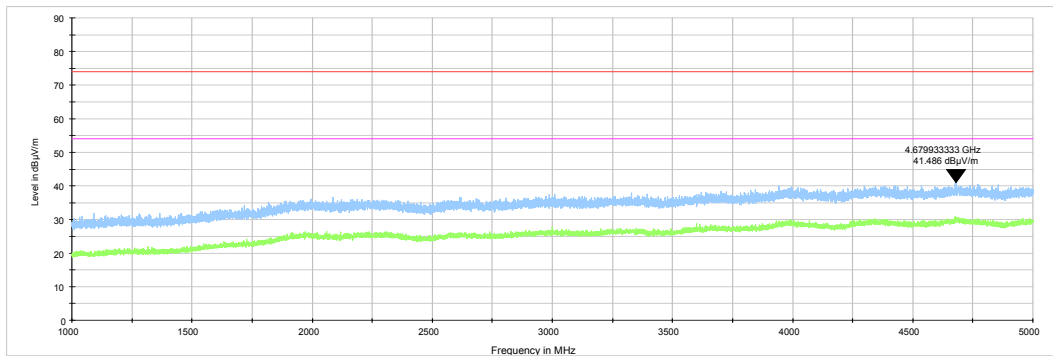

**9 APPENDIX A Test equipment and ancillaries used for tests**

HL No	Description	Manufacturer	Model	Ser. No.	Last Cal./ Check	Due Cal./ Check
0337	Probe Set, Hand held, 5 probes	Electro-Metrics	EHFP-30	238	26-Jun-19	26-Jun-20
0446	Antenna, Loop, Active, 10 (9) kHz - 30 MHz	EMCO	6502	2857	24-Feb-19	24-Feb-20
0604	Antenna BiconiLog Log-Periodic/T Bow-TIE, 26 - 2000 MHz	EMCO	3141	9611-1011	03-Jun-18	03-Jun-20
2909	Spectrum analyzer, ESA-E, 100 Hz to 26.5 GHz	Agilent Technologies	E4407B	MY41444762	04-Apr-19	04-Apr-20
3818	PSA Series Spectrum Analyzer, 3 Hz- 44 GHz	Agilent Technologies	E4446A	MY48250288	24-Apr-19	24-Apr-20
3903	Microwave Cable Assembly, 40.0 GHz, 1.5 m, SMA/SMA	Huber-Suhner	SUCOFLEX 102A	1226/2A	07-Apr-19	07-Apr-20
4135	Shield Box	TESCOM CO., LTD	TC-5916A	5916A000136	24-Apr-19	24-Apr-20
4136	Shield Box	TESCOM CO., LTD	TC-5916A	5916A000137	24-Apr-19	24-Apr-20
4355	Signal and Spectrum Analyzer, 9 kHz to 7 GHz	Rohde & Schwarz	FSV 7	101630	28-Jun-18	28-Jul-19
4360	EMI Test Receiver, 20 Hz to 40 GHz.	Rohde & Schwarz	ESU40	100322	31-Dec-18	31-Dec-19
4933	Active Horn Antenna, 1 GHz to 18 GHz	COM-POWER CORPORATION	AHA-118	701046	06-Jan-19	06-Jan-20
5288	Trilog Antenna, 25 MHz - 8 GHz, 100W	Frankonia	ALX-8000E	00809	08-Feb-19	08-Feb-22
5405	RF cable, 18 GHz, N-N, 6 m	Huber-Suhner	SF118/11N(x2)	500023/118	01-Aug-18	01-Aug-19



10 APPENDIX B Test equipment correction factors

HL 0446: Active Loop Antenna
EMCO, model: 6502, s/n 2857

Frequency,	Measured antenna factor, dBS/m	Measurement uncertainty, dB
10	-33.4	±1.0
20	-37.8	±1.0
50	-40.5	±1.0
75	-41.0	±1.0
100	-41.2	±1.0
150	-41.2	±1.0
250	-41.1	±1.0
500	-41.2	±1.0
750	-41.3	±1.0
1000	-41.3	±1.0

Frequency,	Measured antenna factor, dBS/m	Measurement uncertainty, dB
2000	-41.4	±1.0
3000	-41.4	±1.0
4000	-41.5	±1.0
5000	-41.5	±1.0
10000	-41.7	±1.0
15000	-42.1	±1.0
20000	-42.7	±1.0
25000	-44.2	±1.0
30000	-45.8	±1.0

The antenna factor shall be added to receiver reading in dB μ V to obtain field strength in dB μ A/m.

HL 0604: Antenna BiconiLog Log-Periodic/T Bow-TIE
EMCO, model 3141, serial number 9611-1011

Frequency, MHz	Antenna factor, dB/m		
	Measured	Last	Deviation
30	12.1	12.6	-0.5
35	9.1	9.5	-0.4
40	8.0	8.3	-0.3
45	8.3	8.6	-0.3
50	9.0	9.1	-0.1
60	10.5	10.7	-0.2
70	11.4	11.3	0.1
80	12.3	12.2	0.1
90	13.4	13.2	0.2
100	13.0	13.0	0.0
120	11.4	11.4	0.0
140	12.5	12.4	0.1
160	14.9	14.8	0.1
180	14.4	14.0	0.4
200	13.7	13.9	-0.2
250	16.3	16.4	-0.1
300	17.2	17.5	-0.3
400	19.8	20.2	-0.4
500	22.0	22.4	-0.4
600	24.3	24.5	-0.2
700	25.8	25.6	0.2
800	26.9	26.6	0.3
900	27.3	28.0	-0.7
1000	28.5	29.3	-0.8

The antenna factor shall be added to receiver reading in dB μ V to obtain field strength in dB μ V/m.



HL 4933: Active Horn Antenna
COM-POWER CORPORATION, model: AHA-118, s/n 701046

Frequency, MHz	Measured antenna factor (with preamplifier), dB/m
1000	-16.1
1500	-15.1
2000	-10.9
2500	-11.9
3000	-11.1
3500	-10.6
4000	-8.6
4500	-8.3
5000	-5.9
5500	-5.7
6000	-3.3
6500	-4.0
7000	-2.2
7500	-1.7
8000	1.1
8500	-0.8
9000	-1.5
9500	-0.2

Frequency, MHz	Measured antenna factor (with preamplifier), dB/m
10000	1.8
10500	1.0
11000	0.3
11500	-0.5
12000	3.1
12500	1.4
13000	-0.3
13500	-0.4
14000	2.5
14500	2.2
15000	1.9
15500	0.5
16000	2.1
16500	1.2
17000	0.6
17500	3.1
18000	4.2

The antenna factor shall be added to receiver reading in dB μ V to obtain field strength in dB μ V/m.



HL 5288: Trilog Antenna
Frankonia, model: ALX-8000E, s/n: 00809
30-1000 MHz

Frequency, MHz	Antenna factor, dB/m
30	14.96
35	15.33
40	16.37
45	17.56
50	17.95
60	16.87
70	13.22
80	10.56
90	13.61
100	15.46
120	14.03
140	12.23

Frequency, MHz	Antenna factor, dB/m
160	12.67
180	13.34
200	15.40
250	16.42
300	17.28
400	19.98
500	21.11
600	22.90
700	24.13
800	25.25
900	26.35
1000	27.18

The antenna factor shall be added to receiver reading in dB μ V to obtain field strength in dB μ V/m.

Above 1000 MHz

Frequency, MHz	Antenna factor, dB/m
1000	26.9
1100	28.1
1200	28.4
1300	29.6
1400	29.1
1500	30.4
1600	30.7
1700	31.5
1800	32.3
1900	32.6
2000	32.5
2100	32.9
2200	33.5
2300	33.2
2400	33.7
2500	34.6
2600	34.7
2700	34.6
2800	35.0
2900	35.5
3000	36.2
3100	36.8
3200	36.8
3300	37.0
3400	37.5
3500	38.2

Frequency, MHz	Antenna factor, dB/m
3600	38.9
3700	39.4
3800	39.4
3900	39.6
4000	39.7
4100	39.8
4200	40.5
4300	40.9
4400	41.1
4500	41.4
4600	41.3
4700	41.6
4800	41.9
4900	42.3
5000	42.7
5100	43.0
5200	42.9
5300	43.5
5400	43.6
5500	44.3
5600	44.7
5700	45.0
5800	45.0
5900	45.3
6000	45.9

The antenna factor shall be added to receiver reading in dB μ V to obtain field strength in dB μ V/m.



HL 5405: RF Cable
Huber-Suhner, model: SF118/11N(x2), s/n: 500023/118
Calibration date: 01-Aug-2018

Set / Applied, MHz	Measured, dB	Uncertainty, dB
0.1	0.01	±0.07
50	0.23	±0.07
100	0.32	±0.07
200	0.45	±0.08
300	0.55	±0.08
400	0.64	±0.08
500	0.71	±0.08
600	0.78	±0.08
700	0.85	±0.08
800	0.91	±0.08
900	0.97	±0.08
1000	1.02	±0.08
1100	1.07	±0.08
1200	1.12	±0.08
1300	1.16	±0.08
1400	1.21	±0.08
1500	1.25	±0.08
1600	1.30	±0.08
1700	1.34	±0.08
1800	1.38	±0.08
1900	1.42	±0.08
2000	1.47	±0.08
2500	1.64	±0.10
3000	1.81	±0.10
3500	1.97	±0.10
4000	2.11	±0.10
4500	2.25	±0.10
5000	2.38	±0.10
5500	2.48	±0.10
6000	2.59	±0.10
6500	2.72	±0.10
7000	2.84	±0.13
7500	2.97	±0.13
8000	3.08	±0.13
8500	3.21	±0.13
9000	3.31	±0.13
9500	3.42	±0.13
10000	3.52	±0.13

11 APPENDIX C Test laboratory description

Tests were performed at Hermon Laboratories Ltd., which is a fully independent, private, EMC, Radio, Safety, Environmental and Telecommunication testing facility.

Hermon Laboratories is recognized and accredited by the Federal Communications Commission (USA) for relevant parts of Code of Federal Regulations 47 (CFR 47), Test Firm Registration Number is 927748, Designation Number is IL1001; Recognized by Innovation, Science and Economic Development Canada for wireless and terminal testing (ISED), ISED #2186A, CAB identifier is IL1001; Certified by VCCI, Japan (the registration numbers are R-10808 for OATS, R-1082 for anechoic chamber, G-10869 for RE measurements above 1 GHz, C-10845 for conducted emissions site and T-11606 for conducted emissions at telecommunication ports).

The laboratory is accredited by American Association for Laboratory Accreditation (USA) according to ISO/IEC 17025 for electromagnetic compatibility, product safety, telecommunications testing, environmental simulation and calibration (for exact scope please refer to Certificate No. 839.01, 839.03 and 839.04)

Address: P.O. Box 23, Binyamina 3055001, Israel
Telephone: +972 4628 8001
Fax: +972 4628 8277
e-mail: mail@hermonlabs.com
website: www.hermonlabs.com

Person for contact: Mr. Michael Nikishin, EMC and radio group manager

**12 APPENDIX D Measurement uncertainties****Expanded uncertainty at 95% confidence in Hermon Labs EMC measurements**

Test description	Expanded uncertainty
Conducted carrier power at RF antenna connector	Below 12.4 GHz: ± 1.7 dB 12.4 GHz to 40 GHz: ± 2.3 dB
Conducted emissions at RF antenna connector	9 kHz to 2.9 GHz: ± 2.6 dB 2.9 GHz to 6.46 GHz: ± 3.5 dB 6.46 GHz to 13.2 GHz: ± 4.3 dB 13.2 GHz to 22.0 GHz: ± 5.0 dB 22.0 GHz to 26.8 GHz: ± 5.5 dB 26.8 GHz to 40.0 GHz: ± 4.8 dB
Occupied bandwidth	± 8.0 %
Duty cycle, timing (Tx ON / OFF) and average factor measurements	± 1.0 %
Conducted emissions with LISN	9 kHz to 150 kHz: ± 3.9 dB 150 kHz to 30 MHz: ± 3.8 dB
Radiated emissions at 3 m measuring distance Horizontal polarization Vertical polarization	Biconilog antenna: ± 5.3 dB Biconical antenna: ± 5.0 dB Log periodic antenna: ± 5.3 dB Double ridged horn antenna: ± 5.3 dB Biconilog antenna: ± 6.0 dB Biconical antenna: ± 5.7 dB Log periodic antenna: ± 6.0 dB Double ridged horn antenna: ± 6.0 dB

Hermon Laboratories is accredited by A2LA for calibration according to present requirements of ISO/IEC 17025 and NCSL Z540-1. The accreditation is granted to perform calibration of parameters that are listed in the Scope of Hermon Laboratories Accreditation.

Hermon Laboratories calibrates its reference and transfer standards by calibration laboratories accredited to ISO/IEC 17025 by a mutually recognized Accreditation Body or by a recognized national metrology institute. All reference and transfer standards used in the calibration system are traceable to national or international standards.

In-house calibration of all test and measurement equipment is performed on a regular basis according to Hermon Laboratories calibration procedures, manufacturer calibration/verification procedures or procedures defined in the relevant standards. The Hermon Laboratories test and measurement equipment is calibrated within the tolerances specified by the manufacturers and/or by the relevant standards.



HERMON LABORATORIES

13 APPENDIX E

Specification references

FCC 47CFR part 15:2018	Radio Frequency Devices.
ANSI C63.4:2014	American National Standard for Methods of Measurement of Radio-Noise Emissions from Low-Voltage Electrical and Electronic Equipment in the Range of 9 kHz to 40 GHz.
ANSI C63.10:2013	American National Standard of Procedures for Compliance Testing of Unlicensed Wireless Devices
RSS-247:2017, Issue 2	Digital Transmission Systems (DTSs), Frequency Hopping Systems (FHSs) and License Exempt Local Area Network (LE-LAN) Devices
RSS-Gen:2018, Issue 5	General Requirements for Compliance of Radio Apparatus
ICES-003:2016, Issue 6	Information Technology Equipment (Including Digital Apparatus) – Limits and methods of measurement
558074 D01 DTS Meas_Guidance v05	Guidance for compliance measurements on Digital Transmission System, Frequency Hopping Spread Spectrum System, and Hybrid System Devices operating under section 15.247 of the FCC rules



14 APPENDIX F

Abbreviations and acronyms

A	ampere
AC	alternating current
AM	amplitude modulation
AVRG	average (detector)
cm	centimeter
dB	decibel
dBm	decibel referred to one milliwatt
dB(μ V)	decibel referred to one microvolt
dB(μ V/m)	decibel referred to one microvolt per meter
dB(μ A)	decibel referred to one microampere
DC	direct current
EIRP	equivalent isotropically radiated power
ERP	effective radiated power
EUT	equipment under test
F	frequency
GHz	gigahertz
GND	ground
H	height
HL	Hermon laboratories
Hz	hertz
k	kilo
kHz	kilohertz
LO	local oscillator
m	meter
MHz	megahertz
min	minute
mm	millimeter
ms	millisecond
μ s	microsecond
NA	not applicable
NB	narrow band
OATS	open area test site
Ω	Ohm
PM	pulse modulation
PS	power supply
ppm	part per million (10^{-6})
QP	quasi-peak
RE	radiated emission
RF	radio frequency
rms	root mean square
Rx	receive
s	second
T	temperature
Tx	transmit
V	volt
WB	wideband

END OF DOCUMENT