



EMC TEST REPORT

Report No.: SET2018-07153

Product Name: Microwave Oven

FCC ID : VG8XM145AXX-P

Applicant: Guangdong Midea Kitchen Appliances Manufacturing Co., Ltd.

Address No.6, Yong An Road, Beijiao, Shunde, Foshan, China

Received Date: 2018-06-11

Tested Date: 2018-06-13—2018-06-14

Issued by: CCIC Southern Electronic Product Testing (Shenzhen) Co., Ltd.

Lab Location: Building 28/29, East of Shigu Xili Industrial Zone, Nanshan District
Shenzhen, Guangdong 518055, China

Tel: 86 755 26627338 **Fax:** 86 755 26627238

This test report consists of **21** pages in total. It may be duplicated completely for legal use with the approval of the applicant. It should not be reproduced except in full, without the written approval of our laboratory. The client should not use it to claim product endorsement by CCIC-SET. The test results in the report only apply to the tested sample. The test report shall be invalid without all the signatures of testing engineers, reviewer and approver. Any objections must be raised to CCIC-SET within 15 days since the date when the report is received. It will not be taken into consideration beyond this limit.



Test Report

Product Name..... Microwave Oven

Model No. XM145AYY-P, XM145AYYY-P

Applicant..... Guangdong Midea Kitchen Appliances Manufacturing Co., Ltd.

Applicant Address..... No.6, Yong An Road, Beijiao, Shunde, Foshan, China

Manufacturer Guangdong Midea Kitchen Appliances Manufacturing Co., Ltd.

Manufacturer Address No.6, Yong An Road, Beijiao, Shunde, Foshan, China

Test Standards 47 CFR Part 18

Test Result PASS

Tested by Chris You
Chris You Test Engineer 2018.06.14

Reviewed by Zhu Qi
Zhu Qi Senior Engineer 2018.06.14

Approved by Smart Li
Smart Li, Manager 2018.06.14



TABLE OF CONTENTS

1.	GENERAL INFORMATION	5
1.1	GENERAL DESCRIPTION OF EUT	5
1.2	Test Standards and Results.....	6
1.3	Facilities and Accreditations.....	7
1.3.1	Facilities	7
1.3.2	Measurement Uncertainty	7
2.	EQUIPMENTS LIST	8
3.	EMC EMISSION TEST.....	9
3.1	Test Procedure.....	9
3.1.1	Frequency For Normal Voltage	9
3.1.2	Frequency For Line Voltage	9
3.1.3	Measurement data	10
3.2	RADIATION HAZARD TEST.....	10
3.2.1	Test Setup	10
3.2.2	Limit.....	10
3.2.3	Test results.....	10
3.3	RF OUTPUT POWER MEASUREMENT	11
3.3.1	Test Standard.....	11
3.3.2	EUT Operating mode	11
3.3.3	Test Data.....	11
4.	CONDUCTED EMISSION	12
4.1.1	Conducted Emission Limit.....	12
4.1.2	Test Procedure	12
4.1.3	Test Setup	12
5.	RADIATED EMISSION	15
5.1.1	Radiated Emission Limits	15
5.1.2	Test Setup.....	15
	APPENDIX I: PHOTOGRAPHS OF EMC TEST CONFIGURATION	20



Change History		
Issue	Date	Reason for change
1.0	2018.06.14	First edition



1. GENERAL INFORMATION

1.1 GENERAL DESCRIPTION OF EUT

EUT Name : Microwave Oven
 Trade Name..... : 
 Brand Name..... : 
 Hardware Version..... : N/A
 Software Version : N/A
 Model XM145AYY-P, XM145AYYY-P

(XM145AYY-P, XM145AYYY-P model designations as follow:

X=E or A ; M: indicate microwave function;

145: "1" indicate the microwave output power is 1100W, "45" indicate cavity capacity is 45 liters;

A: indicate the design No.;

YY or YYY= 0-9 or A-Z, indicate different appearance;

P: indicated the painted cavity,

Model EM145A2SR-P was chosen for the final testing.)

Power Supply : 120V AC/60Hz

Rated input Power(microwave): 1550W

Rated output Power(microwave): 1100W

Frequency : 2450MHz(ClassB/Group 2)

Magnetron Model..... : 2M392J

Magnetron Manufacturer ... : WITOL

Description of Support Units :
 -Load for power output measurement: 1100 milliliters of water in the beaker located in the center of the oven.
 -Load for frequency measurement: 1100 milliliters of water in the beaker located in the center of the oven.
 -Load for measurement of radiation on second and third harmonic: Two loads, one of 770 and the other of 330 milliliters, of water are used. Each load is tested both with the beaker located in the center of the oven and with it in the right front corner.
 -Load for all other measurements: 770 milliliters of water, with the beaker located in the center of the oven.

Note 1: The EUT have the following typical setups during the test: Setup1: Running;

*Note 2:*For a more detailed description, please refer to Specification or User’s Manual supplied by the applicant and/or manufacturer.



1.2 Test Standards and Results

The objective of the report is to perform testing according to 47 CFR Part 18:

No.	Identity	Document Title
1	47 CFR Part 18:2017	Radio Frequency Devices

Test detailed items/section required by FCC rules and results are as below:

Emission			
Standard	Item	Class / Severity	Result
47 CFR PART 18	Conducted Emission (150 kHz to 30 MHz)	18.307(b)	PASS
	Radiated Emission (30 MHz to 1 GHz)	18.305(b)	PASS



1.3 Facilities and Accreditations

1.3.1 Facilities

CNAS-Lab Code: L1659

CCIC-SET is a third party testing organization accredited by China National Accreditation Service for Conformity Assessment (CNAS) according to ISO/IEC 17025. The accreditation certificate number is L1659.

FCC-Registration No.: CN5031

CCIC Southern Electronic Product Testing (Shenzhen) Co., Ltd. EMC Laboratory has been registered and fully described in a report filed with the FCC (Federal Communications Commission). The acceptance letter from the FCC is maintained in our files. Designation Number: CN5031, valid time is until December 31, 2018.

ISED Registration: 11185A-1

CCIC Southern Electronic Product Testing (Shenzhen) Co., Ltd. EMC Laboratory has been registered by Certification and Engineering Bureau of Industry Canada for the performance of radiated measurements with Registration No. 11185A-1 on Aug. 04, 2016, valid time is until Aug. 03, 2019.

NVLAP Lab Code: 201008-0

CCIC-SET is a third party testing organization accredited by NVLAP according to ISO/IEC 17025. The accreditation certificate number is 201008-0 Test Environment Conditions

During the measurement, the environmental conditions were within the listed ranges:

Temperature (°C):	15°C - 35°C
Relative Humidity (%):	25% -75%
Atmospheric Pressure (kPa):	86kPa-106kPa

1.3.2 Measurement Uncertainty

The uncertainty is calculated using the methods suggested in the "Guide to the Expression of Uncertainty in Measurement" (GUM) published by ISO.

Uncertainty of Conducted Emission:	Uc = 3.6 dB (k=2)
Uncertainty of Radiated Emission:	Uc = 4.5 dB (k=2)



2. EQUIPMENTS LIST

A. Equipments List:

Description	Manufacturer	Model	Equipment No.	Calibration Date	Calibration Due. Date
Test Receiver	ROHDE&SCHWARZ	ESIB7	A0501375	2018.06.03	2019.06.02
Test Receiver	ROHDE&SCHWARZ	ESIB26	A0304218	2018.06.03	2019.06.02
Semi-Anechoic Chamber	Albatross	9m*6m*6m	A0412372	2018.05.09	2019.05.08
Test Antenna - Bi-Log	HP	CBL6111A	A9704202	2018.06.03	2019.06.02
Test Antenna – Horn	ROHDE&SCHWARZ	HF906	A0304225	2018.06.03	2019.06.02
Anechoic Chamber	Albatross	SAC-5MAC 12.8x6.8x6.4m	A0304210	2018.05.09	2019.05.08
Amplifier 1G~18GHz	ROHDE&SCHWARZ	MITEQ AFS42-00101800	A0509366	2018.06.03	2019.06.02
Amplifier 20M~3GHz	Compliance Direction System	PAP-0203H	A0509377	2018.06.03	2019.06.02
Cable	SUNHNER	SUCOFLEX 100	/	2018.06.03	2019.06.02
Cable	SUNHNER	SUCOFLEX 104	MY1758/4	2018.06.03	2019.06.02
Test Receiver	ROHDE&SCHWARZ	ESCI	A130901475	2017.09.09	2018.09.08
LISN	ROHDE&SCHWARZ	ENV216	/	2018.01.05	2019.01.04
Cable	MATCHING PAD	W7	/	2018.06.03	2019.06.02
EMF Meter	NARDA	ELT-400	A0510311	2017.09.01	2018.09.01
EMF Probe	NARDA	B-Field Probe	A0510311	2017.09.01	2018.09.01
Digital Power meter	YOKOGWA	WT210	A1006680	2018.04.18	2019.04.17
Digital Temperature Meter	YOKOGWA	MV2040	A1008687	2017.06.16	2018.06.15



3. EMC EMISSION TEST

3.1 Test Procedure

Test Requirement: 47 CFR PART 18

Test Method: FCC/OST MP-5:1986

Power Supply: AC 120V/ 60Hz

Frequency Range: 2400-2500MHz

Detector: Peak

Limit: ISM equipment may be operated at any frequency above 9KHz and the frequency band 2400-2500MHz is allocated for use by ISM equipment

ISM frequency	Tolerance
6.78 MHz	±15.0 kHz
13.56 MHz	±7.0 kHz
27.12 MHz	±163.0 kHz
40.68 MHz	±20.0 kHz
915 MHz	±13.0 MHz
2,450 MHz	±50.0 MHz
5,800 MHz	±75.0 MHz
24,125 MHz	±125.0 MHz
61.25 GHz	±250.0 MHz
122.50 GHz	±500.0 MHz
245.00 GHz	±1.0 GHz

3.1.1 Frequency For Normal Voltage

The operating frequency was measured using a spectrum analyzer. Starting with the EUT at room temperature, a 770mL water load was placed in the center of the oven and the oven was operated at maximum output power. The fundamental operating frequency was monitored until the water load was reduced to 20 percent of the original load.

3.1.2 Frequency For Line Voltage

The EUT was operated / warmed by at least 10 minutes of use with a 770mL water load at room temperature at the beginning of the test. Then the operating frequency was monitored as the input voltage was varied between 80 and 125 percent of the nominal rating.



3.1.3 Measurement data

Operating Mode	Frequency(MHz)
Normal Voltage	2401.7-2476.9
Line Voltage	2411.1-2471.0

3.2 RADIATION HAZARD TEST

3.2.1 Test Setup

The EUT was set-up according to the FCC MP-5 and FCC Part 18 for radiation Hazard measurement. The measurement was using a microwave leakage meter to measure the radiation leakage in the as-received condition with the oven door closed A 770mL water load in a breaker was located in the center of the oven and the microwave oven was set to maximum power. While the oven operating, the microwavemeter will check the leakage and then record the maximum leakage.

3.2.2 Limit

A maximum of $1.0\text{mW}/\text{cm}^2$ is allowed in according with the applicable FCC standards

3.2.3 Test results

There was no microwave leakage exceeding a power level of $0.19\text{mW}/\text{cm}^2$ Observed at any point 5cm or more from the external surface of the oven



3.3 RF OUTPUT POWER MEASUREMENT

3.3.1 Test Standard

Test Requirement	47 CFR PART 18
Test Method	FCC/OST MP-5:1986
Power Supply	AC120/60Hz

3.3.2 EUT Operating mode

Test the EUT in microwave mode with full power.

3.3.3 Test Data

Mass of Water(g)	Mass of the container(g)	ambient temperature (°C)	Initial temperature(°C)	Final temperature(°C)	Heating Time(S)	Output Power(Watt)
1100	280	23.5	19.8	36.0	120	649.95

Formula:

$$P = \frac{4.2 \times m_w(T_2 - T_1) + 0.9 \times m_c(T_2 - T_0)}{t}$$

P is the microwave power output, in watts

M_w is the mass of the water, in grams

M_c is the mass of the container, in grams

T₀ is the ambient temperature, in degrees Celsius

T₁ is Initial temperature of the water, in degrees Celsius

T₂ is final temperature of the water, in degrees Celsius

T is heating time, in seconds, excluding the magnetron filament heating-up time

4. CONDUCTED EMISSION

4.1.1 Conducted Emission Limit

Frequency range (MHz)	Conducted Limit (dB μ V)	
	Quasi-peak	Average
0.15 - 0.50	66 to 56	56 to 46
0.50 - 5	56	46
5 - 30	60	50

Note:

- The limit decreases linearly with the logarithm of the frequency in the range 0.05 MHz to 0.5 MHz.
- The lower limit is applicable at the transition frequency.

4.1.2 Test Procedure

The EUT is placed on a 0.8m high insulating table, which stands on the grounded conducting floor, and keeps 0.4m away from the grounded conducting wall. The EUT is connected to the power mains through a LISN which provides 50 Ω /50 μ H of coupling impedance for the measuring instrument. The Common Antenna is used for the call between the EUT and the System Simulator (SS). A Pulse Limiter is used to protect the measuring instrument. The factors of the whole test system are calibrated to correct the reading.

4.1.3 Test Setup

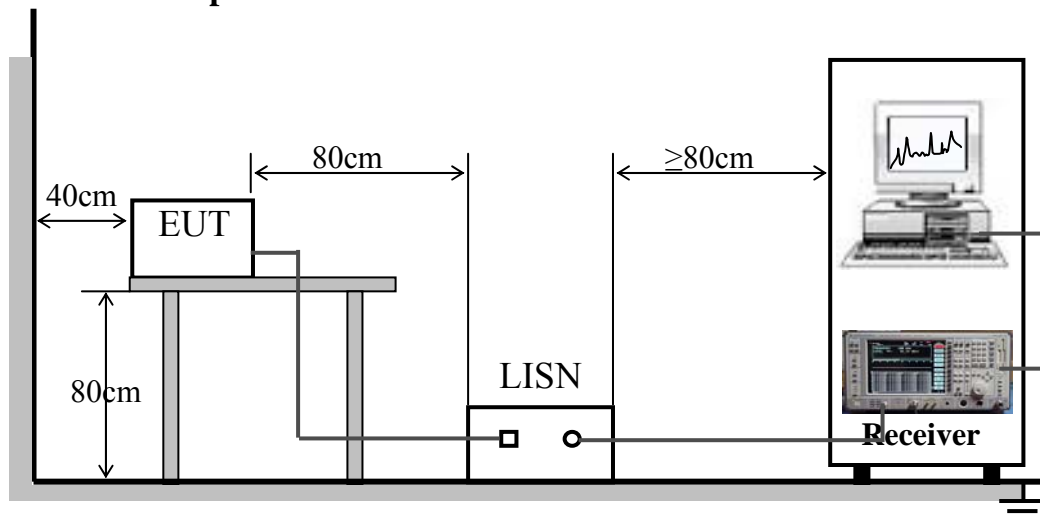

A. Test Result:

Mains terminal disturbance voltage, L phase

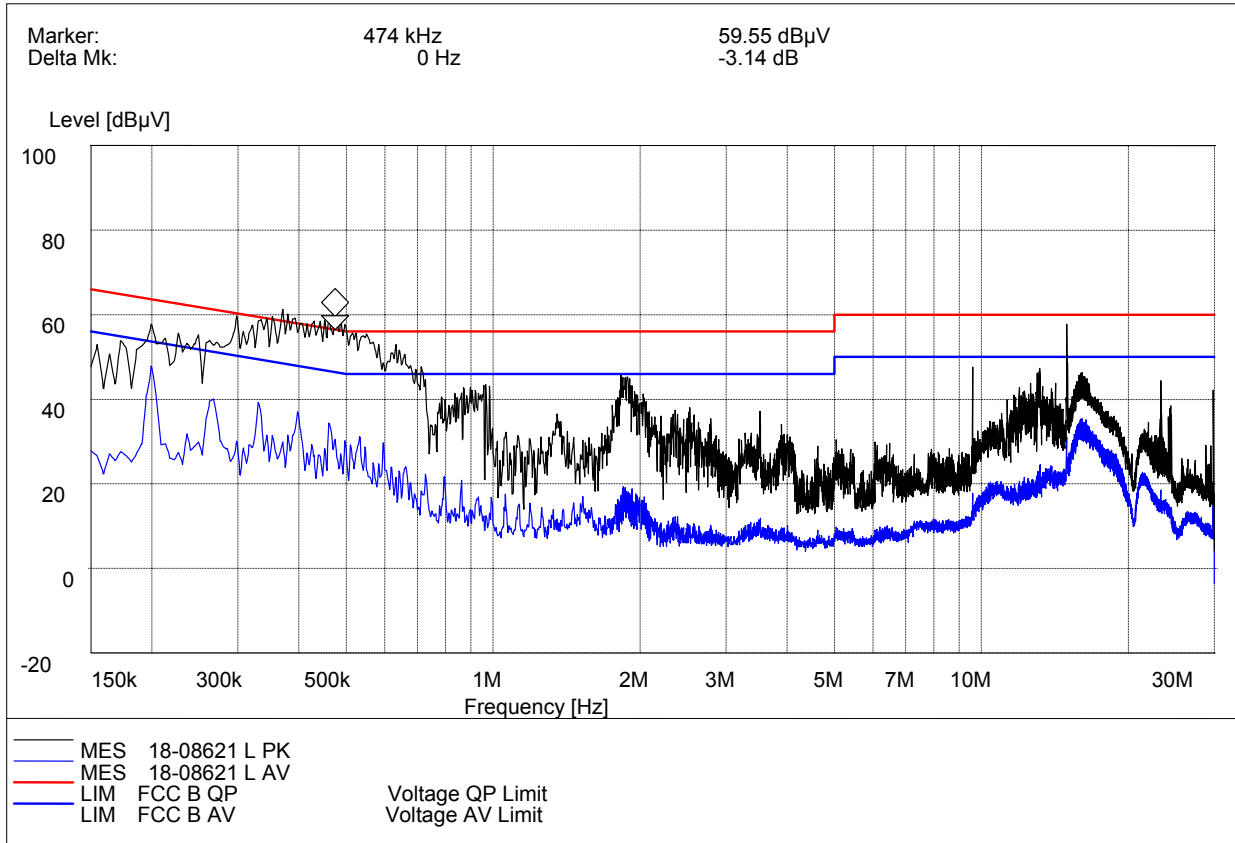

(Plot A: L Phase)

Conducted Disturbance at Mains Terminals							
L Test Data							
QP				AV			
Frequency (MHz)	Limits (dBµV)	Measurement Value (dBµV)	Margin (dB)	Frequency (MHz)	Limits (dBµV)	Measurement Value (dBµV)	Margin (dB)
0.1995	63.60	54.22	9.38	0.1995	53.60	45.73	7.87
0.3300	59.50	55.39	4.11	0.3300	49.50	39.85	9.65
0.474	56.40	53.3	3.1	0.474	46.40	37.45	8.95
0.550	56.00	48.98	7.02	0.550	46.00	30.57	15.43
1.88	56.00	41.62	14.38	1.88	46.00	20.27	25.73
14.94	60.00	45.32	14.68	14.94	50.00	28.76	21.24

Mains terminal disturbance voltage, Setup 2, N phase

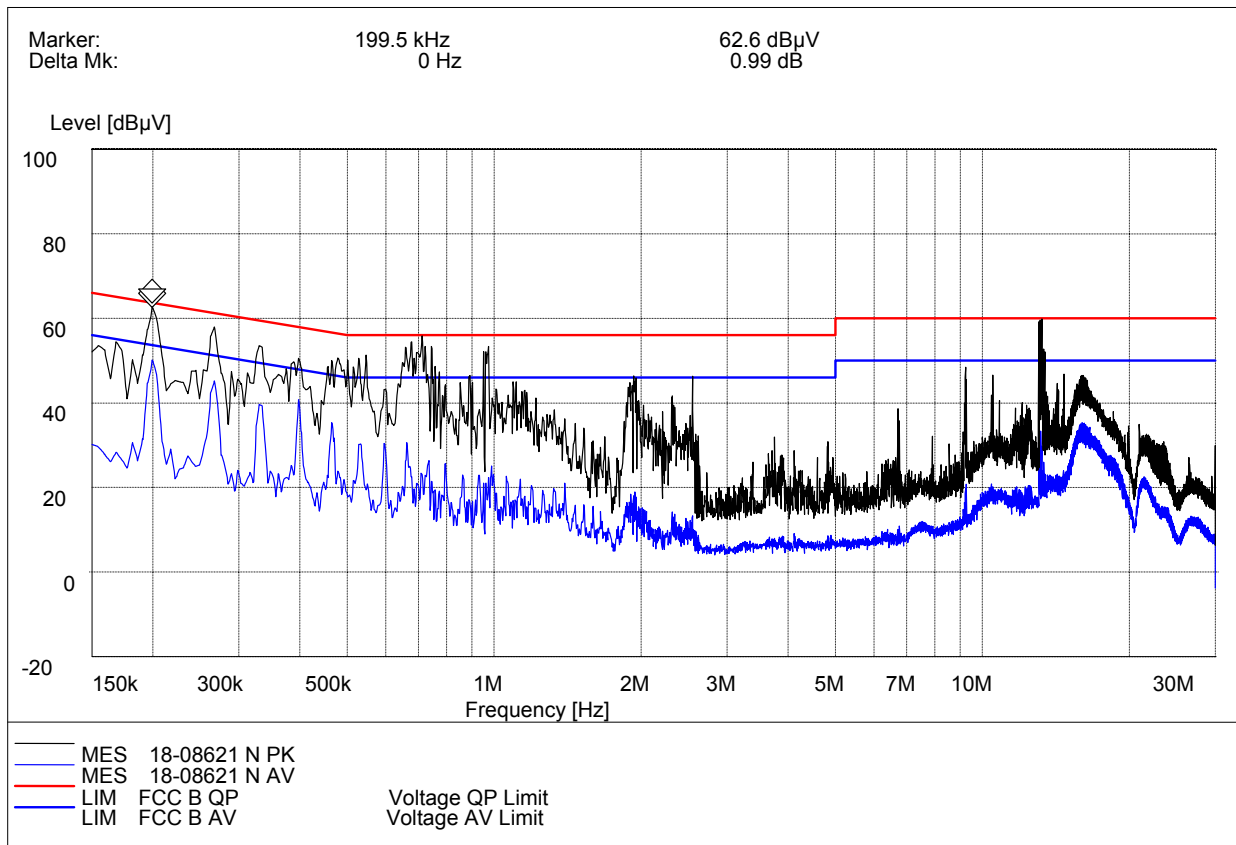

(Plot B: N Phase)

Conducted Disturbance at Mains Terminals							
N Test Data							
QP				AV			
Frequency (MHz)	Limits (dB μ V)	Measurement Value (dB μ V)	Margin (dB)	Frequency (MHz)	Limits (dB μ V)	Measurement Value (dB μ V)	Margin (dB)
0.1995	63.60	58.46	5.14	0.1995	53.60	48.32	5.28
0.267	61.20	55.02	6.18	0.267	51.20	46.53	4.67
0.397	57.90	46.87	11.03	0.397	47.90	40.47	7.43
0.7125	56.0	42.54	13.46	0.7125	46.00	28.69	17.31
0.9735	56.0	41.23	14.77	0.9735	46.00	24.71	21.29
13.1495	60.0	42.18	17.82	13.1495	50.00	27.82	22.18

Test Result: PASS

5. RADIATED EMISSION

5.1.1 Radiated Emission Limits

- (a) ISM equipment operation on a frequency specified in §18.301 is permitted unlimited radiated energy in the band specified for that frequency.
- (b) The field strength levels of emissions which lie outside the bands specified in §18.301, unless otherwise indicated, shall not exceed the following:

RF Power generated by equipment(watts)	Field strength limit(uV/m) @300m
Below 500	25
500 or more	$25 * \text{SQRT}(\text{power}/500)$

Power =550.2W according to cluse7.2.2

Limit= $20\lg(25 * \text{SQRT}(\text{power}/500)) + 20\lg(300/3)$ @ 3m distance.

5.1.2 Test Setup

For radiated emissions from 30MHz to1GHz

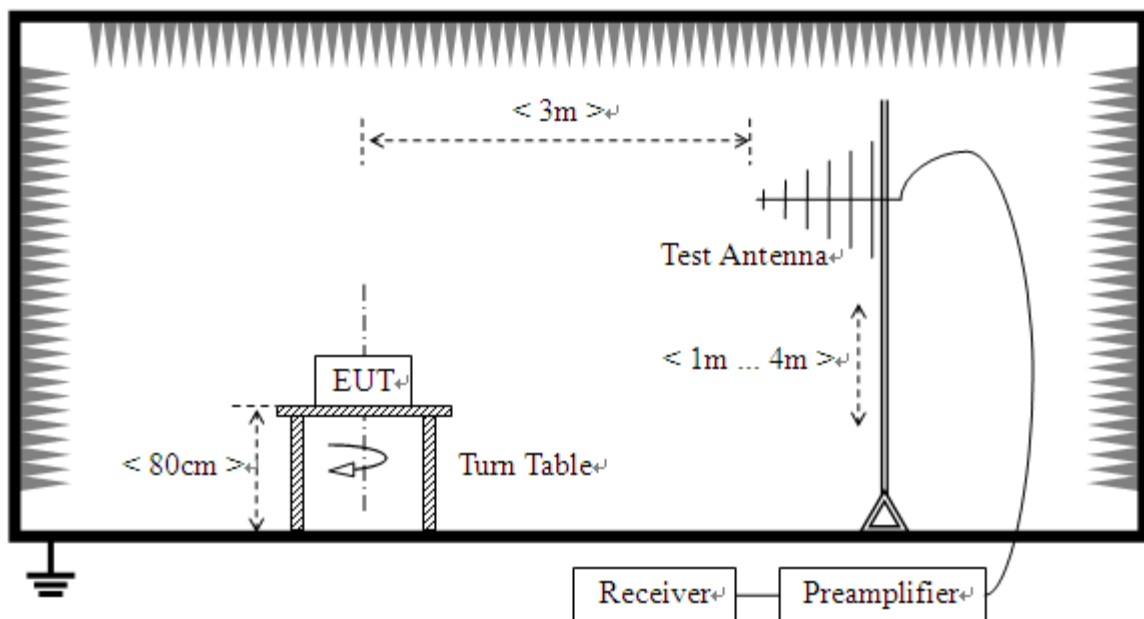

For radiated emissions above 1GHz

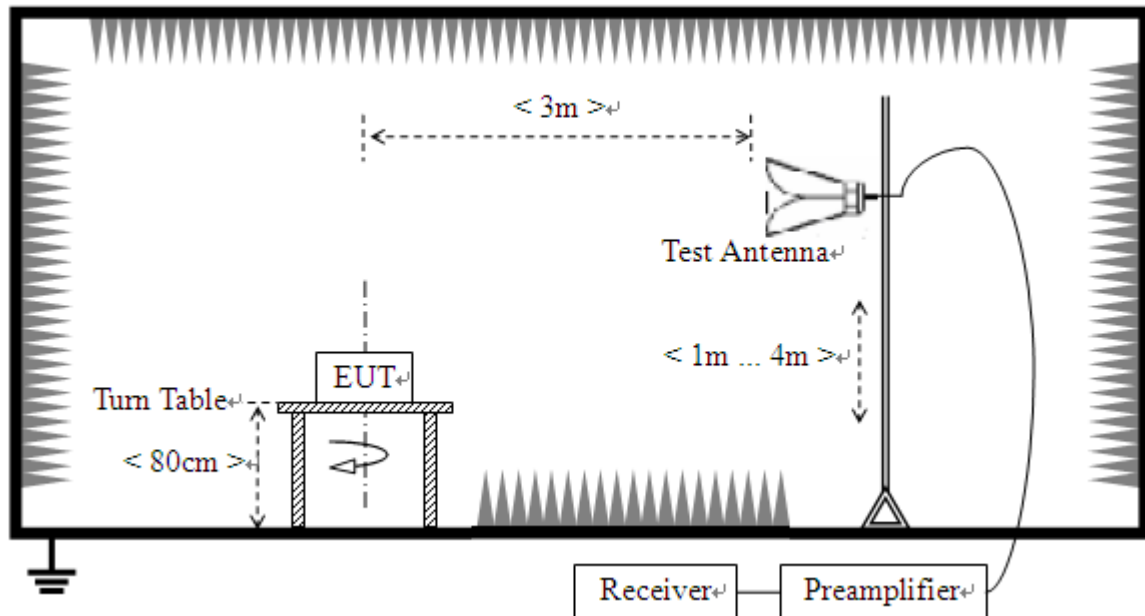

5.1.3 Test Procedure

- The measuring distance of at 3 m shall be used for measurements at frequency up to 1GHz. For frequencies above 1GHz, any suitable measuring distance may be used.
- The EUT was placed on the top of a rotating table 0.8 meters above the ground at a 3 meter open area test site. The table was rotated 360 degrees to determine the position of the highest radiation.
- The height of the equipment or of the substitution antenna shall be 0.8 m; the height of the test antenna shall vary between 1 m to 4 m. Both horizontal and vertical polarizations of the antenna are set to make the measurement.
- The initial step in collecting conducted emission data is a spectrum analyzer peak detector mode pre-scanning the measurement frequency range. Significant peaks are then marked and then Quasi Peak detector mode re-measured.
- If the Peak Mode measured value compliance with and lower than Quasi Peak Mode Limit, the EUT shall be deemed to meet QP Limits and then no additional QP Mode measurement performed.
- For the actual test configuration, please refer to the related Item –EUT Test Photos.

Note: Both horizontal and vertical antenna polarities were tested and performed pretest to three orthogonal axis. The worst case emissions were reported



Test Result:

Radiation disturbances, antenna polarization: Vertical

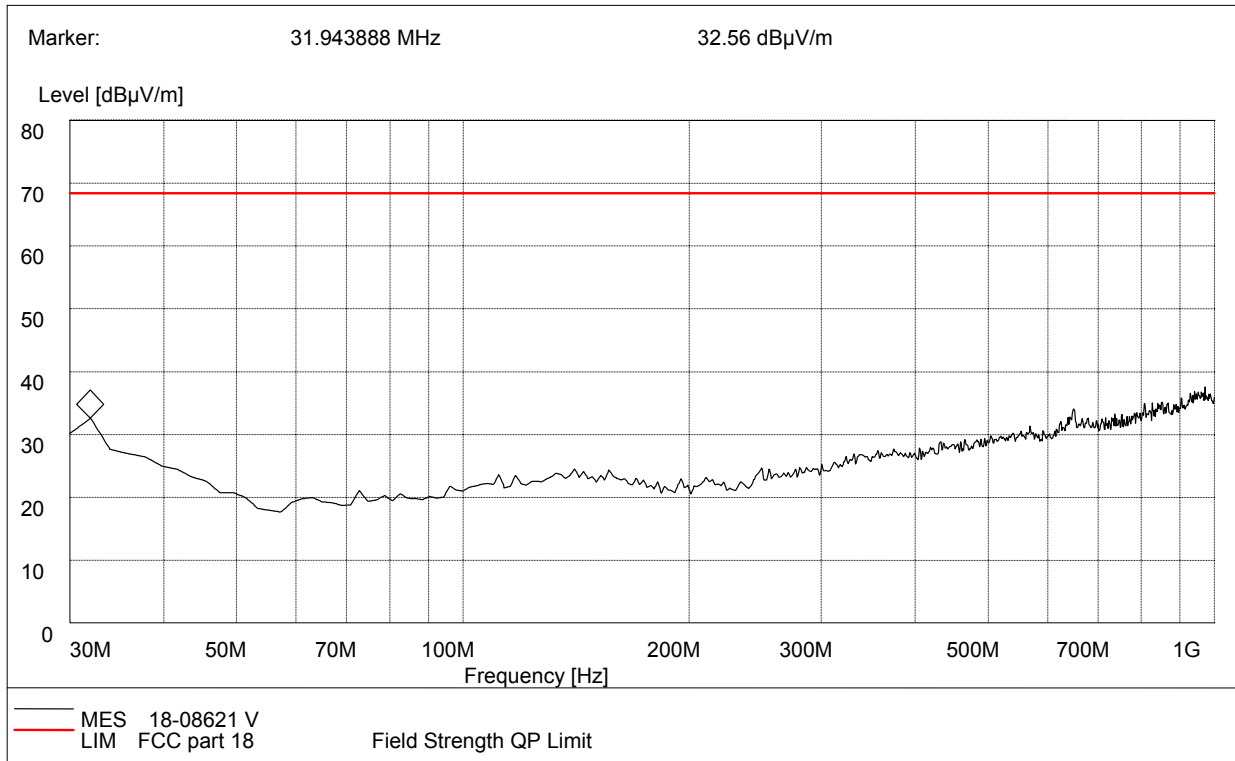

(Plot C: Test Antenna Vertical 30M - 1G)

Frequency (MHz)	QuasiPeak (dB μ V/m)	Bandwidth (kHz)	Antenna height (cm)	Limit (dB μ V/m)	Margin (dB)	Antenna	Verdict
31.52	29.35	120.000	112.0	68.37	39.02	Vertical	Pass



Radiation disturbances, antenna polarization:Horizontal

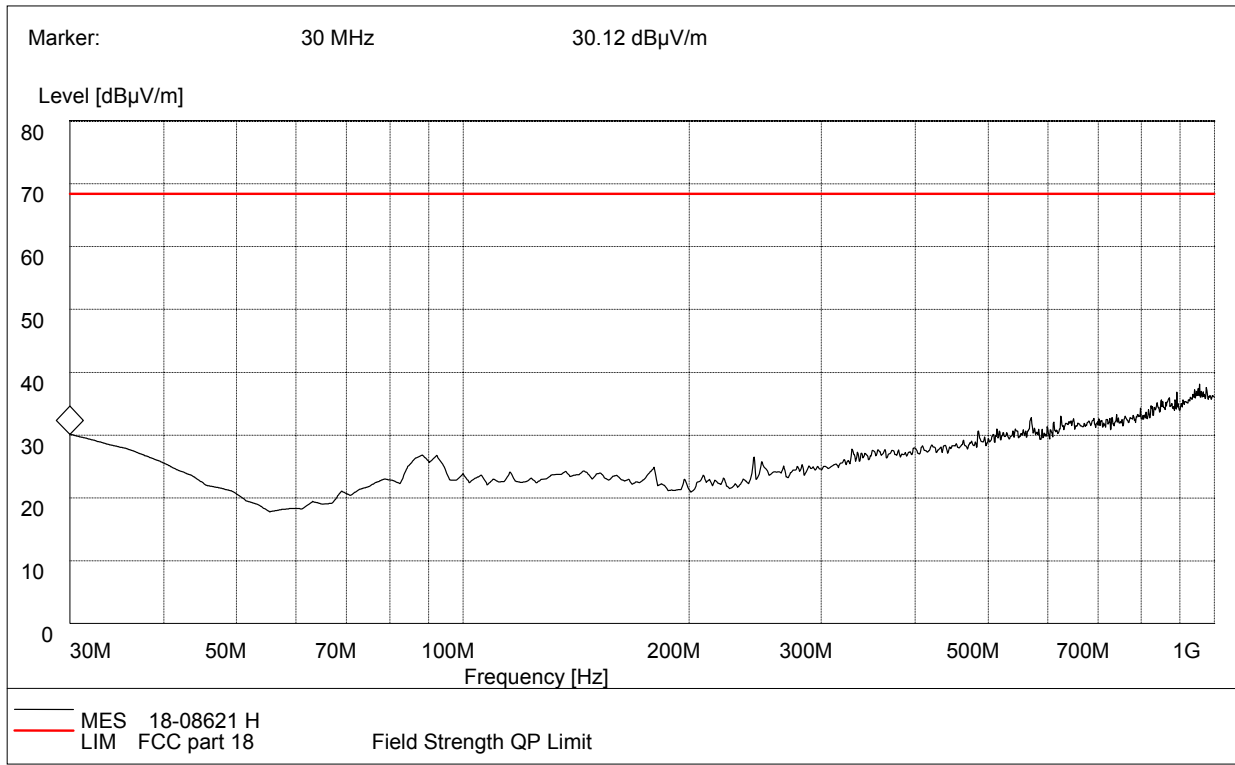

(Plot D: Test Antenna Horizontal 30M - 1G)

Frequency (MHz)	QuasiPeak (dBµV/m)	Bandwidth (kHz)	Antenna height (cm)	Limit (dBµV/m)	Margin (dB)	Antenna	Verdict
30.01	27.34	120.000	123.0	68.37	38.32	Horizontal	Pass

**Above 1GHz**

NO.	Freq. [MHz]	Level [dB μ V/m]	Factor [dB]	Limit [dB μ V/m]	Margin [dB]	Height [cm]	Angle [°]	Polarity
1	1221.11	60.44	-20.98	68.37	7.93	100	170	Vertical
2	2207.60	54.09	-16.46	68.37	14.28	100	80	Vertical
3	2394.69	61.69	-15.58	68.37	6.68	100	130	Vertical
4	2700.85	60.05	-14.45	68.37	8.32	100	50	Vertical
5	4886.44	60.01	-10.09	68.37	8.36	100	270	Vertical
6	7369.68	62.69	-0.79	68.37	5.68	100	100	Vertical

NO.	Freq. [MHz]	Level [dB μ V/m]	Factor [dB]	Limit [dB μ V/m]	Margin [dB]	Height [cm]	Angle [°]	Polarity
1	1221.11	57.40	-20.98	68.37	10.97	100	160	Vertical
2	2241.62	57.99	-16.22	68.37	10.38	100	50	Vertical
3	2700.85	62.75	-14.45	68.37	5.62	100	160	Vertical
4	4231.61	53.87	-9.28	68.37	14.50	100	250	Vertical
5	4903.45	59.08	-10.08	68.37	9.29	100	350	Vertical
6	13577.7	57.69	13.64	68.37	10.68	100	230	Vertical

REMARKS:

1. Emission Level(dBuV/m) = Raw Value(dBuV) + Correction Factor(dB/m)
2. Correction Factor(dB/m) = Antenna Factor(dB/m) + Cable Factor(dB)
- Pre-Amplifier Factor(dB)

APPENDIX I: PHOTOGRAPHS OF EMC TEST CONFIGURATION

1. Radiated Emission Measurement below 1GHz

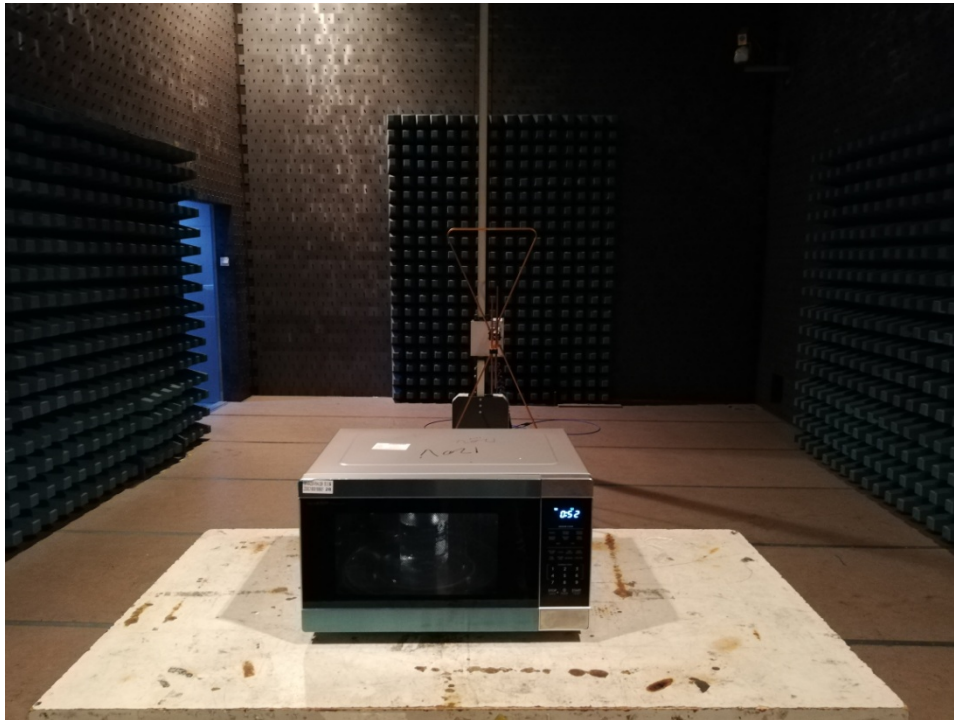

2. Radiated Emission Measurement above 1GHz



3. Conducted emission at AC mains input/output port Measurement



End of Report