



EMC TEST REPORT

Report No.: SET2020-07779

Product Name: Microwave Oven

Trade Name: Midea

Model No. : EM025F##, AM025F##, EM025F***, AM025F***

FCC ID : VG8XM025FXX-Y

Applicant: Guangdong Midea Kitchen Appliances Manufacturing Co.,Ltd.

Received Date: 2020-07-07

Tested Date: 2020-07-10 to 2020-07-14

Issued by: CCIC Southern Testing Co., Ltd.

Lab Location: Electronic Testing Building, No.43 Shahe Road, Xili Street, Nanshan District, Shenzhen, Guangdong, China

Tel: 86 755 26627338 **Fax:** 86 755 26627238

This test report consists of **21** pages in total. It may be duplicated completely for legal use with the approval of the applicant. It should not be reproduced except in full, without the written approval of our laboratory. The client should not use it to claim product endorsement by CCIC-SET. The test results in the report only apply to the tested sample. The test report shall be invalid without all the signatures of testing engineers, reviewer and approver. Any objections must be raised to CCIC-SET within 15 days since the date when the report is received. It will not be taken into consideration beyond this limit.



Test Report

Product Name..... Microwave Oven

Model No. EM025F##, AM025F##, EM025F***, AM025F***

Trade name Midea

Applicant..... Guangdong Midea Kitchen Appliances Manufacturing Co.,Ltd.

Applicant Address..... No.6, Yong An Road, Beijiao, Shunde, Foshan, China

Manufacturer Guangdong Midea Kitchen Appliances Manufacturing Co.,Ltd.

Manufacturer Address No.6, Yong An Road, Beijiao, Shunde, Foshan, China

Test Standards 47 CFR Part 18

Test Result..... PASS

Tested by *Fang Yun Lei*
 Fang Yun Lei Test Engineer 2020.07.15

Reviewed by *Chris You*
 Chris You Senior Engineer 2020.07.15

Approved by *Shuangwen Zhang*

 Shuangwen Zhang, Manager 2020.07.15



TABLE OF CONTENTS

1.	GENERAL INFORMATION	5
1.1	GENERAL DESCRIPTION OF EUT	5
1.2	Test Standards and Results.....	6
1.3	Facilities and Accreditations.....	7
1.3.1	Facilities	7
1.3.2	Measurement Uncertainty	7
2.	EQUIPMENTS LIST	8
3.	EMC EMISSION TEST.....	9
3.1	Test Procedure.....	9
3.1.1	Frequency For Normal Voltage	9
3.1.2	Frequency For Line Voltage	9
3.1.3	Measurement data	10
3.2	RADIATION HAZARD TEST.....	10
3.2.1	Test Setup	10
3.2.2	Limit.....	10
3.2.3	Test results.....	10
3.3	RF OUTPUT POWER MEASUREMENT	11
3.3.1	Test Standard.....	11
3.3.2	EUT Operating mode	11
3.3.3	Test Data.....	11
4.	CONDUCTED EMISSION	12
4.1.1	Conducted Emission Limit.....	12
4.1.2	Test Procedure	12
4.1.3	Test Setup	12
5.	RADIATED EMISSION	15
5.1.1	Radiated Emission Limits	15
5.1.2	Test Setup.....	15
5.1.3	Test Procedure	16
APPENDIX I: PHOTOGRAPHS OF EMC TEST CONFIGURATION.....		20



Change History		
Issue	Date	Reason for change
1.0	2020.07.15	First edition



1. GENERAL INFORMATION

1.1 GENERAL DESCRIPTION OF EUT

EUT Name : Microwave Oven
 Trade Name.....: Midea
 Brand Name.....: N/A
 Model EM025F##, AM025F##, EM025F***, AM025F*** model designations as follow:
 A or E: “A” indicates Rotating type knob; “E” indicates Film type keypad.
 M: indicates microwave function;
 025: "0" indicate the microwave output power is 1000W, “25” indicates cavity capacity is 25 liters;
 F: indicate the design No.,
 ## or ***: “#”, “*” = 0-9, A-Z or blank, indicates different appearance;
 Model AM025FJT was selected for the final testing.

Power Supply : 120V AC/60Hz
 Rated input Power(microwave): 1500W
 Rated output Power(microwave): 1000W
 Frequency : 2450MHz(ClassB/Group 2)
 Magnetron Model..... : 2M392J
 Magnetron Manufacturer ... : WITOL
 Description of Support Units: -Load for power output measurement: 1000 milliliters of water in the beaker located in the center of the oven.
 -Load for frequency measurement: 1000 milliliters of water in the beaker located in the center of the oven.
 -Load for measurement of radiation on second and third harmonic: Two loads, one of 700 and the other of 300 milliliters, of water are used. Each load is tested both with the beaker located in the center of the oven and with it in the right front corner.
 -Load for all other measurements: 700 milliliters of water, with the beaker located in the center of the oven.

Note 1: The EUT have the following typical setups during the test: Setup1: Running;
Note 2: For a more detailed description, please refer to Specification or User’s Manual supplied by the applicant and/or manufacturer.



1.2 Test Standards and Results

The objective of the report is to perform testing according to 47 CFR Part 18:

No.	Identity	Document Title
1	47 CFR Part 18:2017	Radio Frequency Devices

Test detailed items/section required by FCC rules and results are as below:

Emission			
Standard	Item	Class / Severity	Result
47 CFR PART 18	Conducted Emission (150 kHz to 30 MHz)	18.307(b)	PASS
	Radiated Emission (30 MHz to 1 GHz)	18.305(b)	PASS



1.3 Facilities and Accreditations

1.3.1 Facilities

FCC-Registration No.: CN5031

CCIC Southern Testing Co., Ltd. EMC Laboratory has been registered and fully described in a report filed with the FCC (Federal Communications Commission). The acceptance letter from the FCC is maintained in our files. DesignationNumber: CN5031, valid time is until December 31, 2020.

ISED Registration: 11185A-1

CCIC Southern Testing Co., Ltd. EMC Laboratory has been registered by Certification and Engineering Bureau of Industry Canada for the performance of radiated measurements with Registration No. 11185A-1 on Aug. 04, 2016, valid time is until Aug. 03, 2020.

NVLAP Lab Code: 201008

CCIC Southern Testing Co., Ltd. is a third party testing organization accredited by NVLAP according to ISO/IEC 17025. The accreditation certificate number is 201008.

Test Environment Conditions

During the measurement, the environmental conditions were within the listed ranges:

Temperature (°C):	15°C- 35°C
Relative Humidity (%):	25% -75%
Atmospheric Pressure (kPa):	86kPa-106kPa

1.3.2 Measurement Uncertainty

The uncertainty is calculated using the methods suggested in the "Guide to the Expression of Uncertainty in Measurement" (GUM) published by ISO.

Uncertainty of Conducted Emission:	Uc = 3.6 dB (k=2)
Uncertainty of Radiated Emission:	Uc = 4.5 dB (k=2)



2. EQUIPMENTS LIST

A. Equipments List:

Description	Manufacturer	Model	Serial No.	Calibration Date	Calibration Due. Date
Test Receiver	KEYSIGHT	N9038A	A141202036	2019.11.21	2020.11.21
LISN	ROHDE&SCHWARZ	ESH2-Z5	A0304221	2020.07.30	2021.06.29
Shield Room	Xinju Electronics	L7300*W4500* H3100	A181003226	2018.09.06	2021.09.05
EMI Test Receiver	ROHDE&SCHWARZ	ESIB7	A0501375	2019.07.30	2020.07.29
Broadband Ant.	2786	ETC	A150402239	2018.09.17	2021.09.16
3M Anechoic Chamber	Albatross	SAC-3MAC 9*6*6m	A0412375	2019.03.26	2023.03.25
EMI Test Receiver	ROHDE&SCHWARZ	ESW26	A180502935	2019.09.22	2020.09.22
System Simulator	ROHDE&SCHWARZ	CMW500	A150802214	2019.07.30	2021.07.29
5M Anechoic Chamber	Albatross	SAC-5MAC 12.8x6.8x6.4m	A0304210	2019.03.25	2023.03.24
EMI Horn Ant.	ROHDE&SCHWARZ	HF906	A0304225	2019.04.17	2022.04.17
Spectrum Analyzer	KEYSIGHT	E7515A	A160702555	2019.04.01	2021.04.01



3. EMC EMISSION TEST

3.1 Test Procedure

Test Requirement: 47 CFR PART 18

Test Method: FCC/OST MP-5:1986

Power Supply: AC 120V/ 60Hz

Frequency Range: 22410-2468MHz

Detector: Peak

Limit: ISM equipment may be operated at any frequency above 9KHz and the frequency band 2400-2500MHz is allocated for use by ISM equipment

ISM frequency	Tolerance
6.78 MHz	±15.0 kHz
13.56 MHz	±7.0 kHz
27.12 MHz	±163.0 kHz
40.68 MHz	±20.0 kHz
915 MHz	±13.0 MHz
2,450 MHz	±50.0 MHz
5,800 MHz	±75.0 MHz
24,125 MHz	±125.0 MHz
61.25 GHz	±250.0 MHz
122.50 GHz	±500.0 MHz
245.00 GHz	±1.0 GHz

3.1.1 Frequency For Normal Voltage

The operating frequency was measured using a spectrum analyzer. Starting with the EUT at room temperature, a 1000mL water load was placed in the center of the oven and the oven was operated at maximum output power. The fundamental operating frequency was monitored until the water load was reduced to 20 percent of the original load.

3.1.2 Frequency For Line Voltage

The EUT was operated / warmed by at least 10 minutes of use with a 1000mL water load at room temperature at the beginning of the test. Then the operating frequency was monitored as the input voltage was varied between 80 and 125 percent of the nominal rating.



3.1.3 Measurement data

Operating Mode	Frequency(MHz)
Normal Voltage	2410.1-2468.8
Line Voltage	2411.5-2470.2

3.2 RADIATION HAZARD TEST

3.2.1 Test Setup

The EUT was set-up according to the FCC MP-5 and FCC Part 18 for radiation Hazard measurement. The measurement was using a microwave leakage meter to measure the radiation leakage in the as-received condition with the oven door closed A 700mL water load in a breaker was located in the center of the oven and the microwave oven was set to maximum power. While the oven operating, the microwavemeter will check the leakage and then record the maximum leakage.

3.2.2 Limit

A maximum of 1.0mW/cm²is allowed in according with the applicable FCC standards

3.2.3 Test results

There was no microwave leakage exceeding a power level of 0.15 mW/cm²Observed at any point 5cm or more from the external surface of the oven



3.3 RF OUTPUT POWER MEASUREMENT

3.3.1 Test Standard

Test Requirement	47 CFR PART 18
Test Method	FCC/OST MP-5:1986
Power Supply	AC120/60Hz

3.3.2 EUT Operating mode

Test the EUT in microwave mode with full power.

3.3.3 Test Data

Mass of Water(g)	Mass of the container(g)	ambient temperature (°C)	Initial temperature(°C)	Final temperature(°C)	Heating Time(S)	Output Power(Watt)
1000	280	20.0	10	32	120	795.2

Formula:

$$P = \frac{4.2 \times m_w(T_2 - T_1) + 0.9 \times m_c(T_2 - T_0)}{t}$$

P is the microwave power output, in watts

M_w is the mass of the water, in grams

M_c is the mass of the container, in grams

T₀ is the ambient temperature, in degrees Celsius

T₁ is Initial temperature of the water, in degrees Celsius

T₂ is final temperature of the water, in degrees Celsius

T is heating time, in seconds, excluding the magnetron filament heating-up time

4. CONDUCTED EMISSION

4.1.1 Conducted Emission Limit

Frequency range (MHz)	Conducted Limit (dB μ V)	
	Quasi-peak	Average
0.15 - 0.50	66 to 56	56 to 46
0.50 - 5	56	46
5 - 30	60	50

Note:

- The limit decreases linearly with the logarithm of the frequency in the range 0.05 MHz to 0.5 MHz.
- The lower limit is applicable at the transition frequency.

4.1.2 Test Procedure

The EUT is placed on a 0.8m high insulating table, which stands on the grounded conducting floor, and keeps 0.4m away from the grounded conducting wall. The EUT is connected to the power mains through a LISN which provides 50 Ω /50 μ H of coupling impedance for the measuring instrument. The Common Antenna is used for the call between the EUT and the System Simulator (SS). A Pulse Limiter is used to protect the measuring instrument. The factors of the whole test system are calibrated to correct the reading.

4.1.3 Test Setup

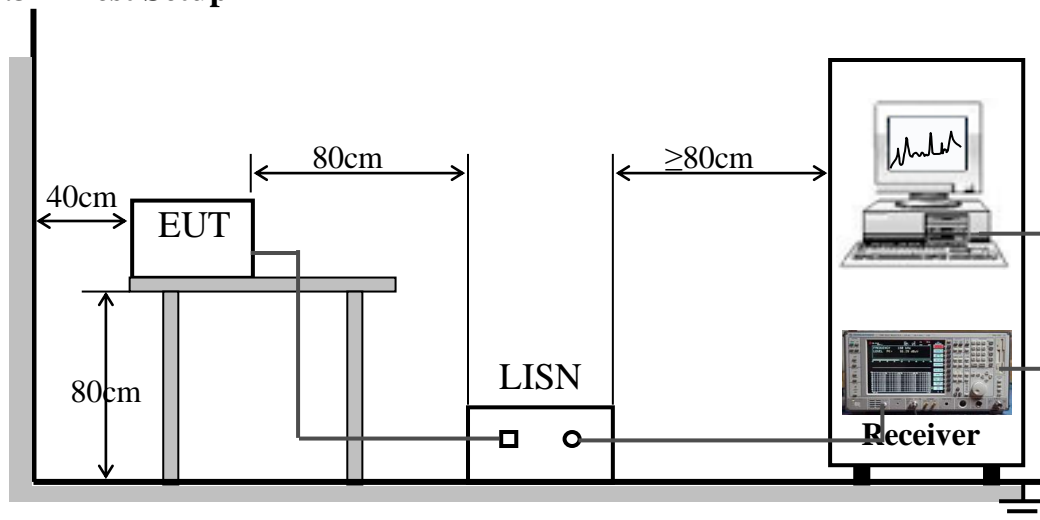

A. Test Result:

Mains terminal disturbance voltage, Setup1,L phase

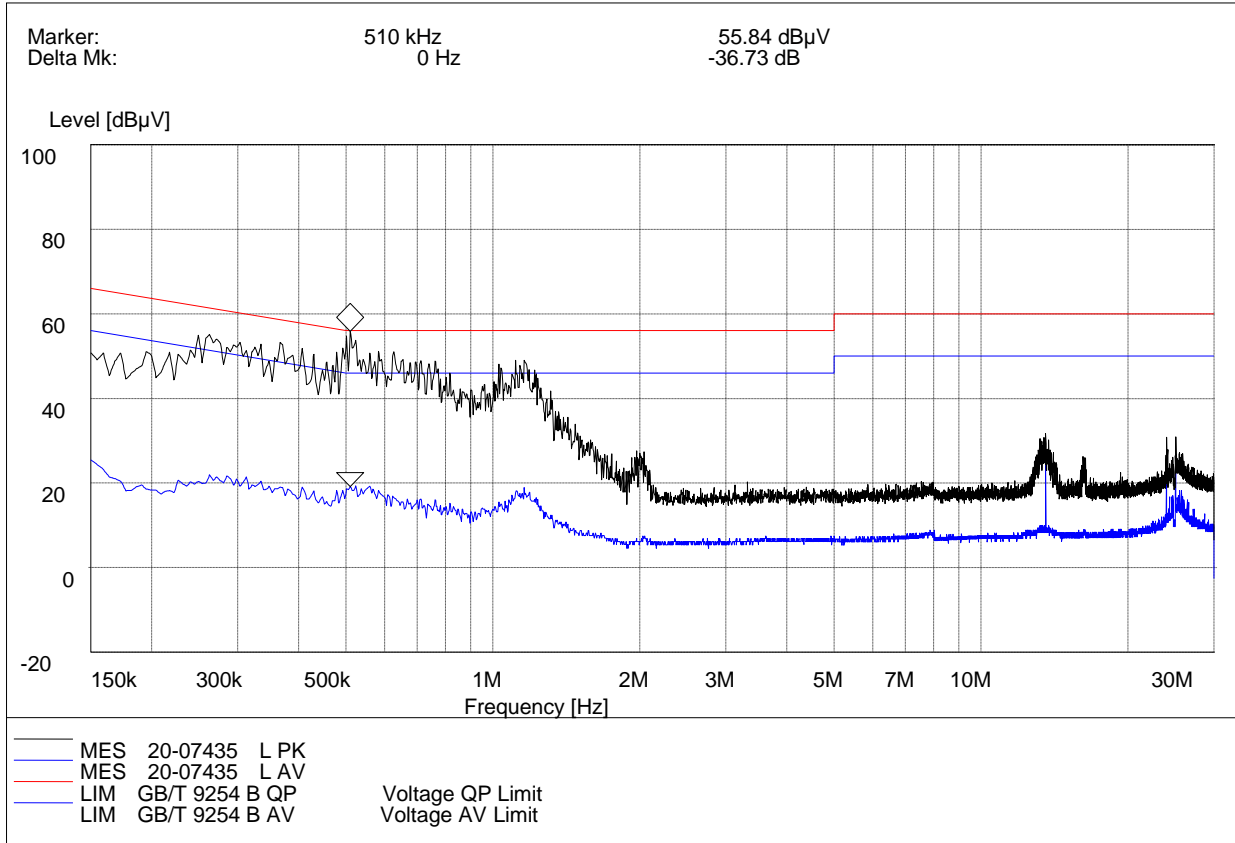

(Plot A: L Phase)

Conducted Disturbance at Mains Terminals							
L Test Data							
QP				AV			
Frequency (MHz)	Limits (dBµV)	Measurement Value (dBµV)	Margin (dB)	Frequency (MHz)	Limits (dBµV)	Measurement Value (dBµV)	Margin (dB)
0.510	56.00	48.26	7.74	0.510	46.00	19.11	26.89
0.582	56.00	48.79	7.21	0.582	46.00	18.42	27.58
0.627	56.00	47.69	8.31	0.627	46.00	16.59	29.41
0.694	56.00	46.35	9.65	0.694	46.00	15.00	31.00
0.366	58.60	50.74	7.86	0.366	48.60	18.79	29.81
0.262	61.40	53.29	8.11	0.262	51.40	21.9	29.5

Mains terminal disturbance voltage, Setup 1, N phase

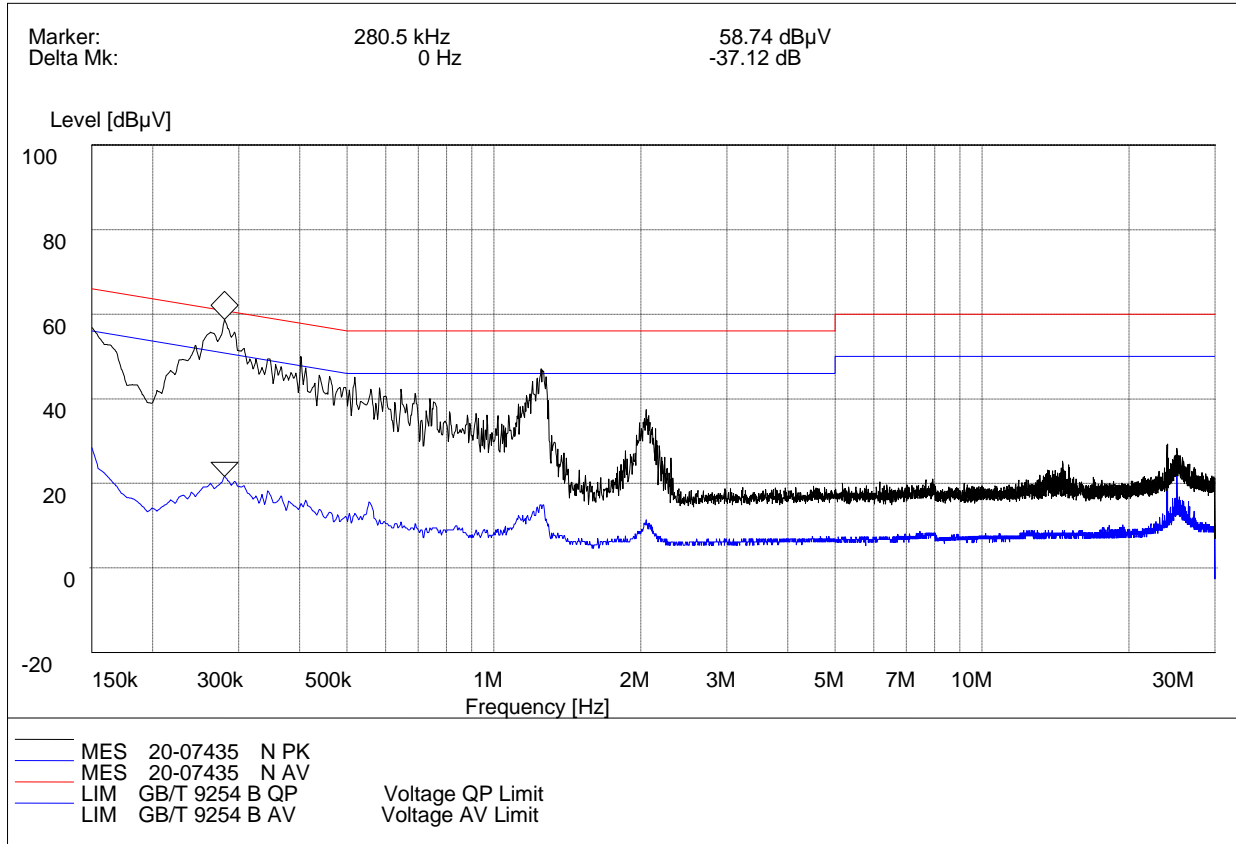

(Plot B: N Phase)

Conducted Disturbance at Mains Terminals							
N Test Data							
QP				AV			
Frequency (MHz)	Limits (dBµV)	Measurement Value (dBµV)	Margin (dB)	Frequency (MHz)	Limits (dBµV)	Measurement Value (dBµV)	Margin (dB)
0.280	60.80	54.67	6.13	0.280	50.80	21.62	29.18
0.402	57.80	48.53	9.27	0.402	47.80	15.06	32.74
0.519	56.00	43.59	12.41	0.519	46.00	13.00	33.00
0.645	56.00	40.37	15.63	0.645	46.00	8.47	37.53
1.250	56.00	44.28	11.72	1.250	46.00	14.52	31.48
2.040	56.00	34.99	21.01	2.040	46.00	11.39	34.61

Test Result: PASS

5. RADIATED EMISSION

5.1.1 Radiated Emission Limits

- (a) ISM equipment operation on a frequency specified in §18.301 is permitted unlimited radiated energy in the band specified for that frequency.
- (b) The field strength levels of emissions which lie outside the bands specified in §18.301, unless otherwise indicated, shall not exceed the following:

RF Power generated by equipment(watts)	Field strength limit(uV/m) @300m
Below 500	25
500or more	$25 * \text{SQRT}(\text{power}/500)$

Power = 795.2W

Limit= $20\lg(25 * \text{SQRT}(\text{power}/500)) + 20\lg(300/3)$ @ 3m distance.

5.1.2 Test Setup

For radiated emissions from 30MHz to 1GHz

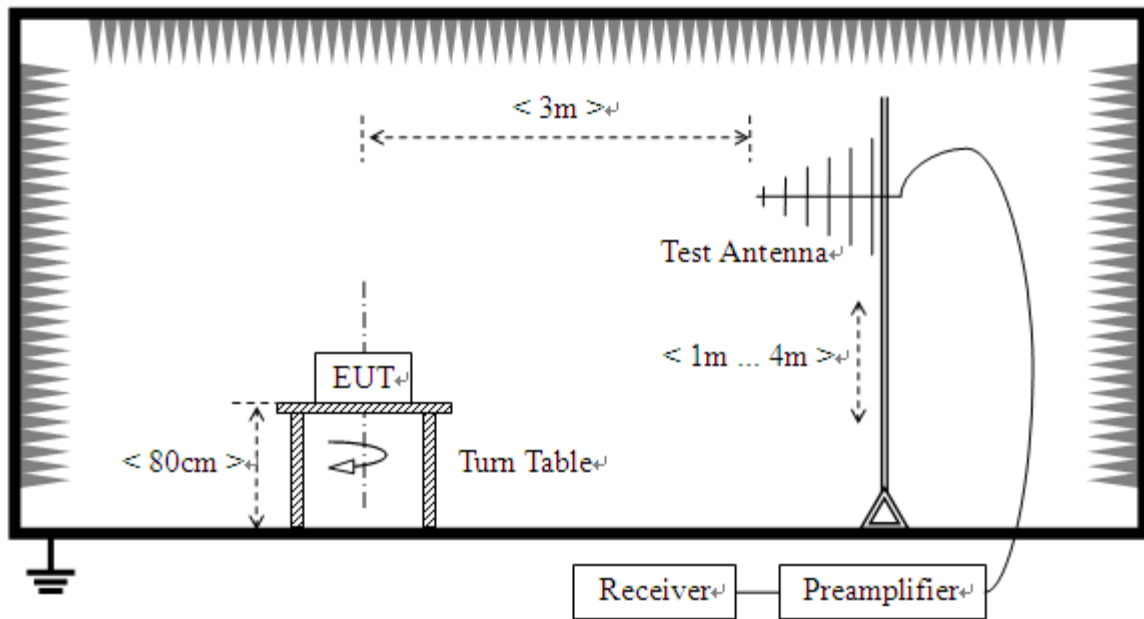

For radiated emissions above 1GHz

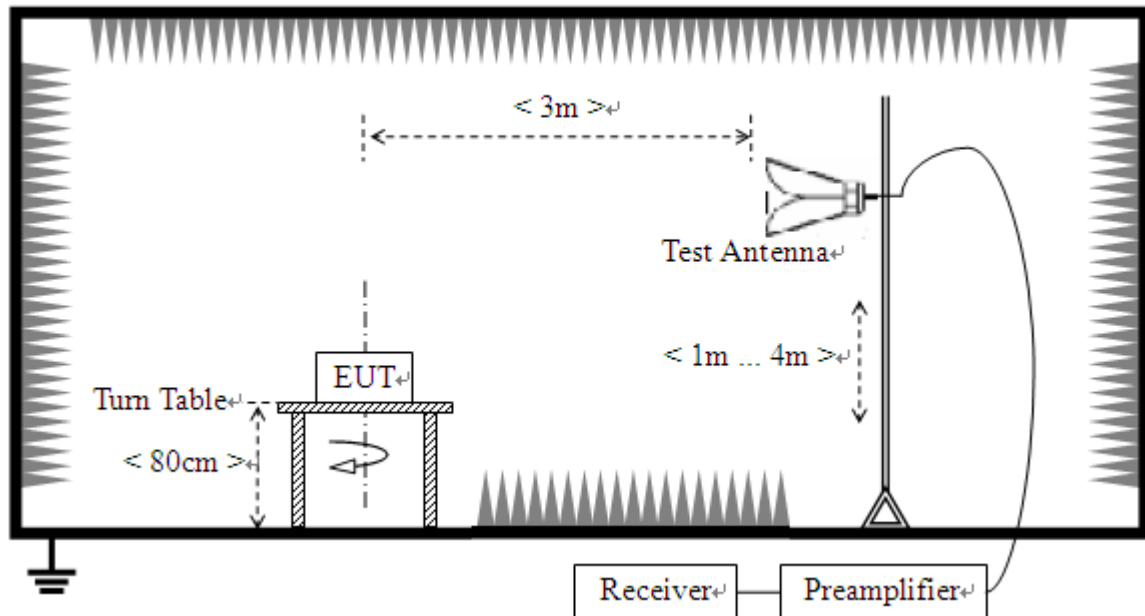

5.1.3 Test Procedure

- The measuring distance of at 3 m shall be used for measurements at frequency up to 1GHz. For frequencies above 1GHz, any suitable measuring distance may be used.
- The EUT was placed on the top of a rotating table 0.8 meters above the ground at a 3 meter open area test site. The table was rotated 360 degrees to determine the position of the highest radiation.
- The height of the equipment or of the substitution antenna shall be 0.8 m; the height of the test antenna shall vary between 1 m to 4 m. Both horizontal and vertical polarizations of the antenna are set to make the measurement
- The initial step in collecting conducted emission data is a spectrum analyzer peak detector mode pre-scanning the measurement frequency range. Significant peaks are then marked and then Quasi Peak detector mode re-measured.
- If the Peak Mode measured value compliance with and lower than Quasi Peak Mode Limit, the EUT shall be deemed to meet QP Limits and then no additional QP Mode measurement performed.
- For the actual test configuration, please refer to the related Item –EUT Test Photos.

Note: Both horizontal and vertical antenna polarities were tested and performed pretest to three orthogonal axis. The worst case emissions were reported



Test Result:

Radiation disturbances, antenna polarization: Setup1, Horizontal

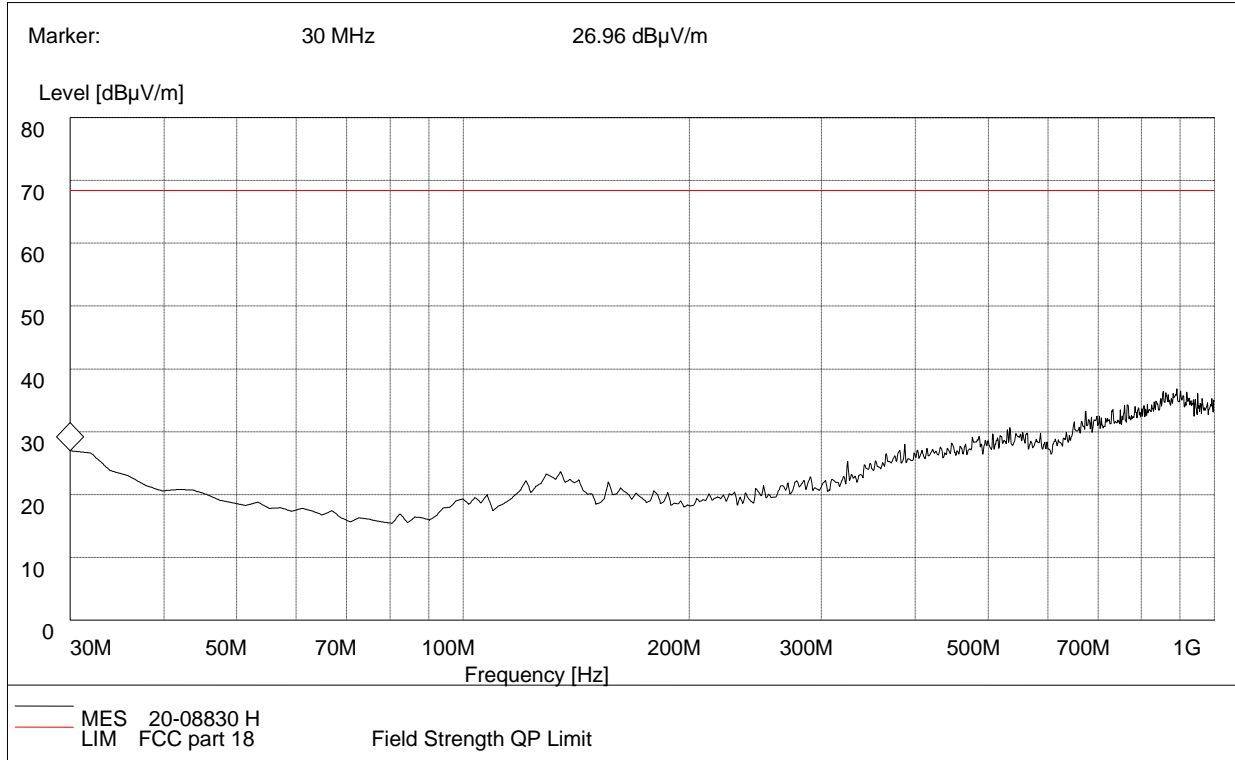

(Plot C: Test Antenna Vertical30M - 1G)

Frequency (MHz)	QuasiPeak (dBµV/m)	Bandwidth (kHz)	Antenna height (cm)	Limit (dBµV/m)	Margin (dB)	Antenna	Verdict
30.08	26.98	120.000	112.0	69.97	42.99	Horizontal	Pass



Radiation disturbances, antenna polarization: Setup1, Vertical

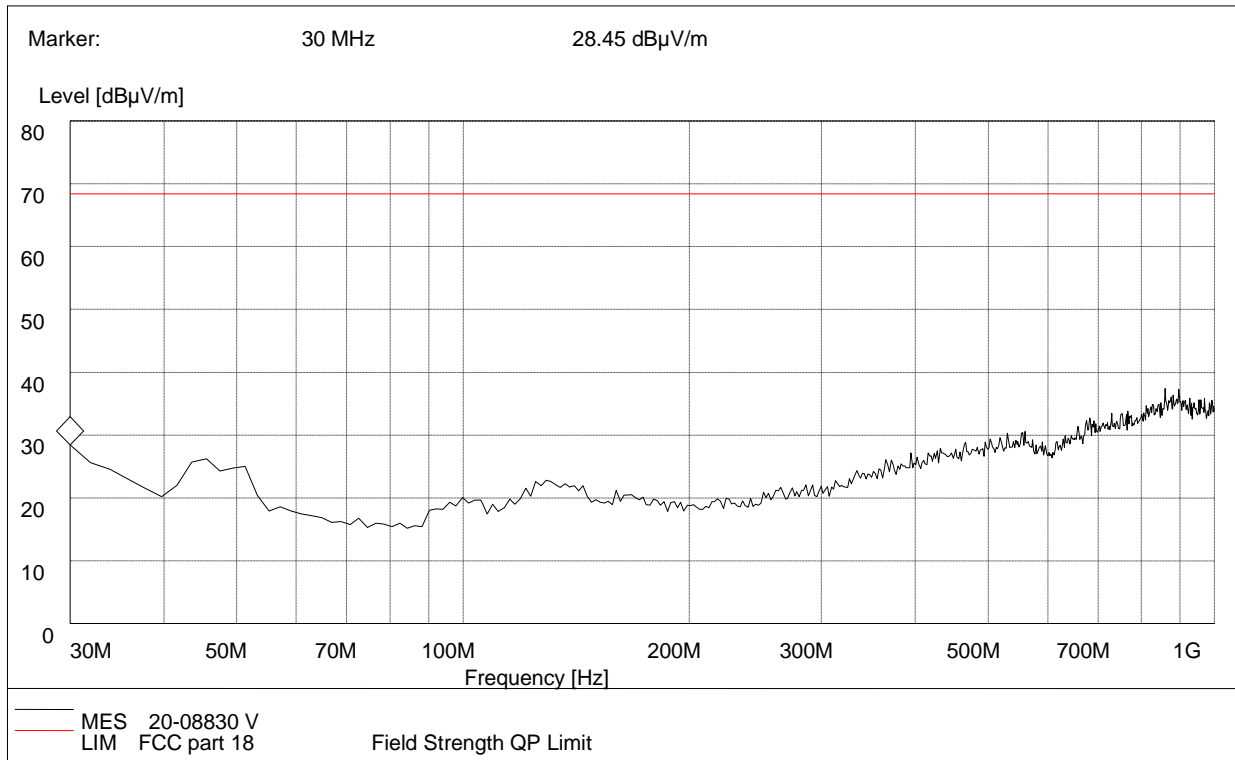

(Plot D: Test Antenna Horizontal 30M - 1G)

Frequency (MHz)	QuasiPeak (dBµV/m)	Bandwidth (kHz)	Antenna height (cm)	Limit (dBµV/m)	Margin (dB)	Antenna	Horizontal
30.63	27.06	120.000	123.0	69.97	42.91	Vertical	Pass

**Above 1GHz Setup1**

NO.	Freq. [MHz]	Level [dB μ V/m]	Factor [dB]	Limit [dB μ V/m]	Margin [dB]	Height [cm]	Angle [°]	Polarity
1	2186.04	62.08	-8.31	69.97	7.89	100	200	Horizontal
2	2402.85	62.46	-7.19	69.97	7.51	100	220	Horizontal
3	4919.47	63.26	3.56	69.97	6.71	100	190	Horizontal
4	7380.84	62.85	7.61	69.97	7.12	100	20	Horizontal
5	8290.57	61.84	8.40	69.97	8.13	100	70	Horizontal
6	9859.21	62.46	11.38	69.97	7.51	100	110	Horizontal

NO.	Freq. [MHz]	Level [dB μ V/m]	Factor [dB]	Limit [dB μ V/m]	Margin [dB]	Height [cm]	Angle [°]	Polarity
1	1726.93	55.57	-9.28	69.97	14.40	100	110	Vertical
2	2190.29	56.92	-8.30	69.97	13.05	100	80	Vertical
3	2449.61	61.54	-7.23	69.97	8.43	100	160	Vertical
4	4247.81	60.40	1.59	69.97	9.57	100	130	Vertical
5	8299.07	61.73	8.35	69.97	8.24	100	260	Vertical
6	10471.3	62.57	11.17	69.97	7.40	100	180	Vertical

REMARKS:

1. Emission Level(dBuV/m) = Raw Value(dBuV) + Correction Factor(dB/m)
2. Correction Factor(dB/m) = Antenna Factor(dB/m) + Cable Factor(dB)
- Pre-Amplifier Factor(dB)
3. For Set up 2 mode, The EUT's internal highest frequency is less than 108MHz, so test frequency range is up to 1000MHz. Other frequency reading was too low against the official limit that not recorded.

APPENDIX I: PHOTOGRAPHS OF EMC TEST CONFIGURATION

1. Radiated Emission Measurement below 1GHz



2. Radiated Emission Measurement above 1GHz

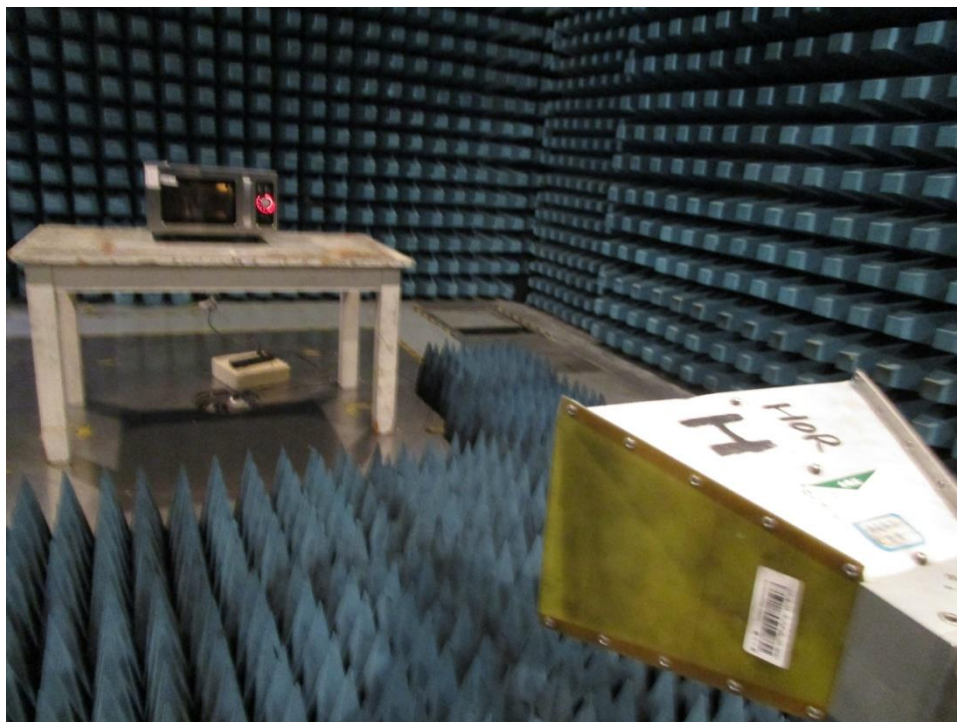

3. Conducted emission at AC mains input/output port Measurement



APPENDIX II: PHOTOGRAPHS OF PRODUCT PHOTO

External Photo



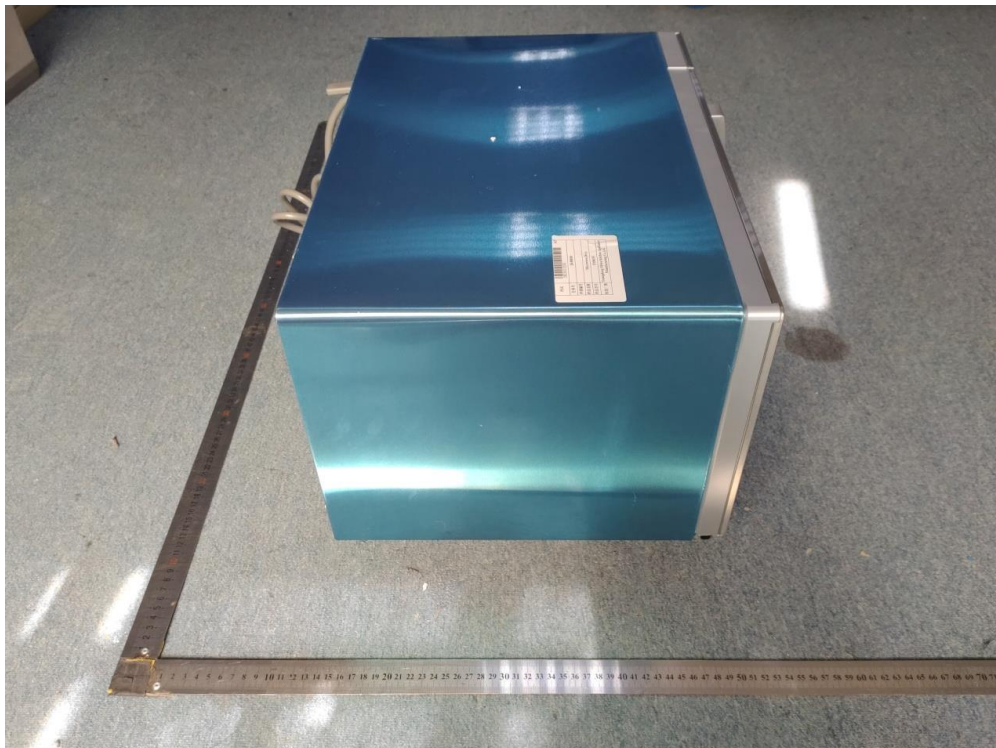
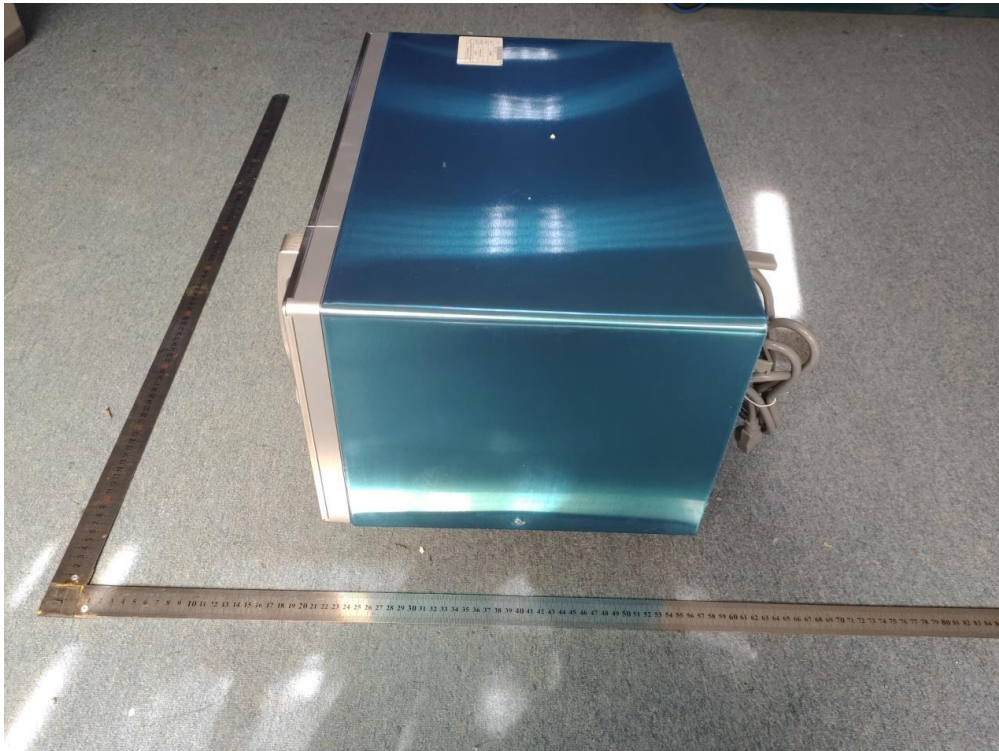

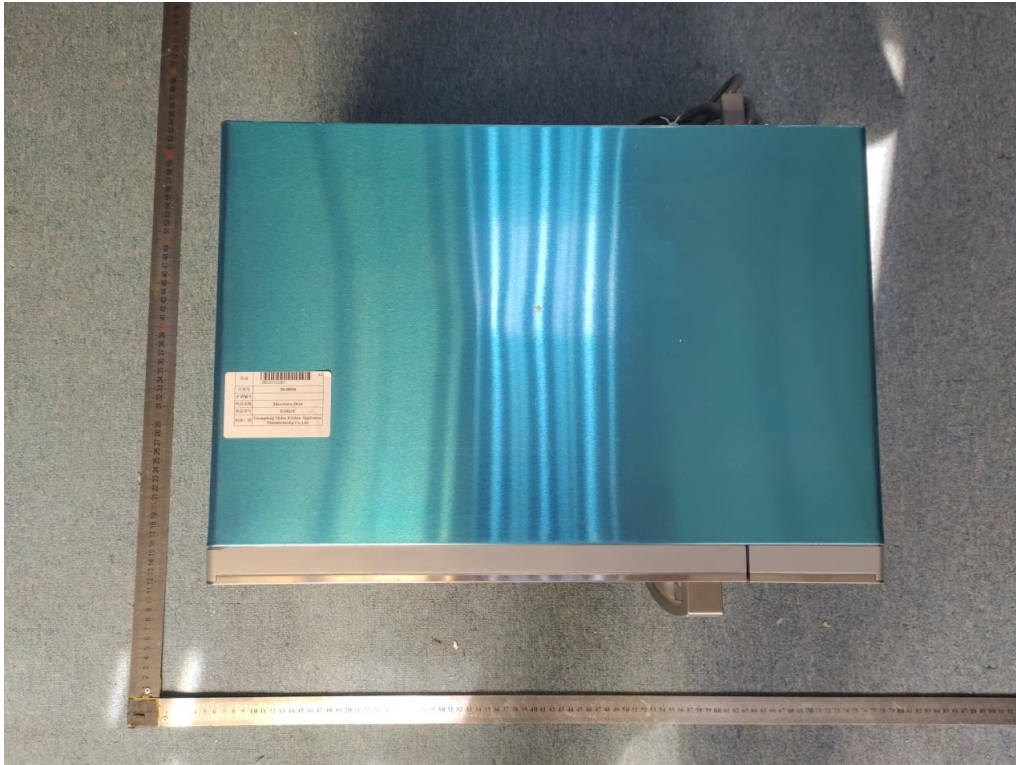

Internal Photo

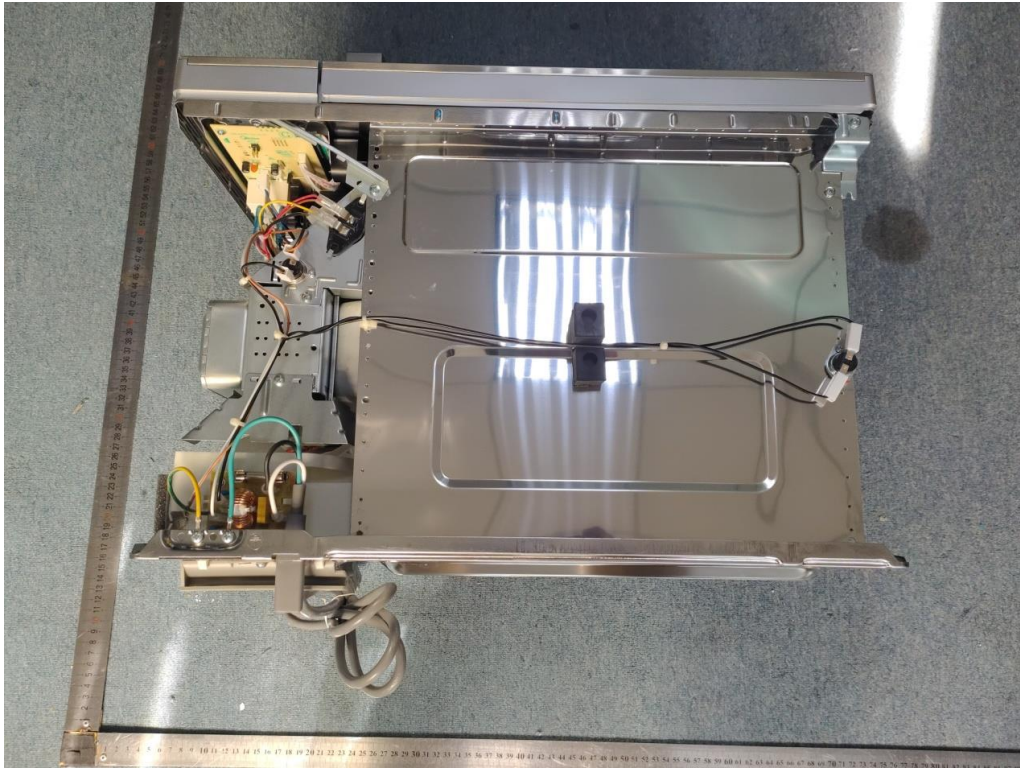

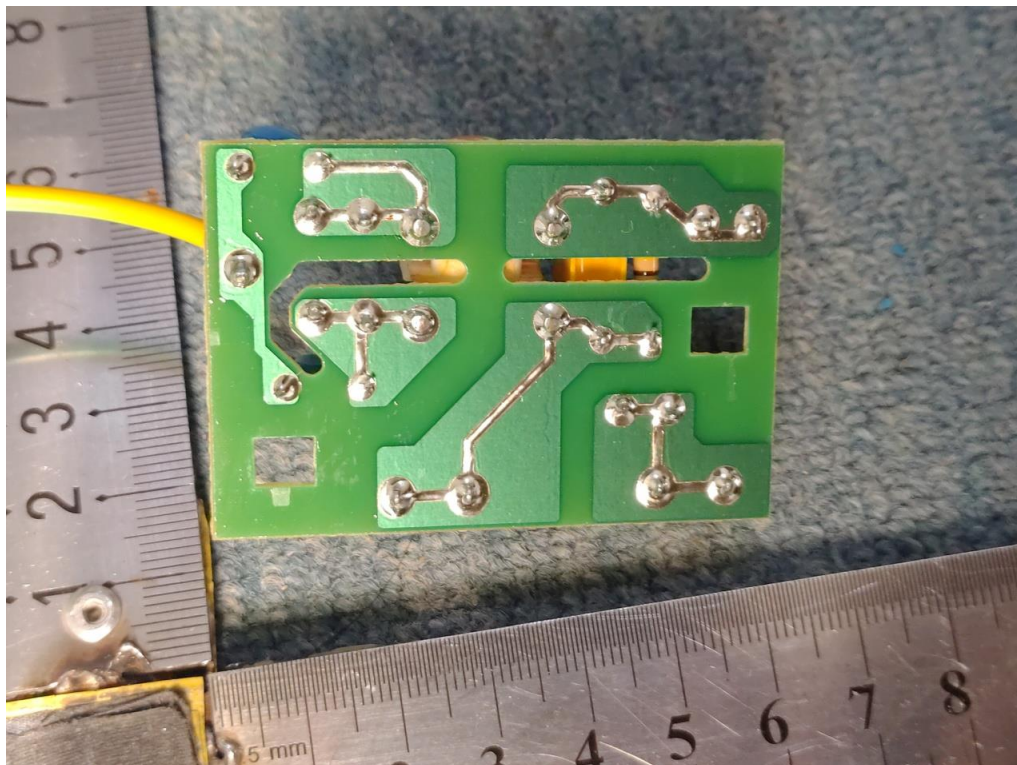
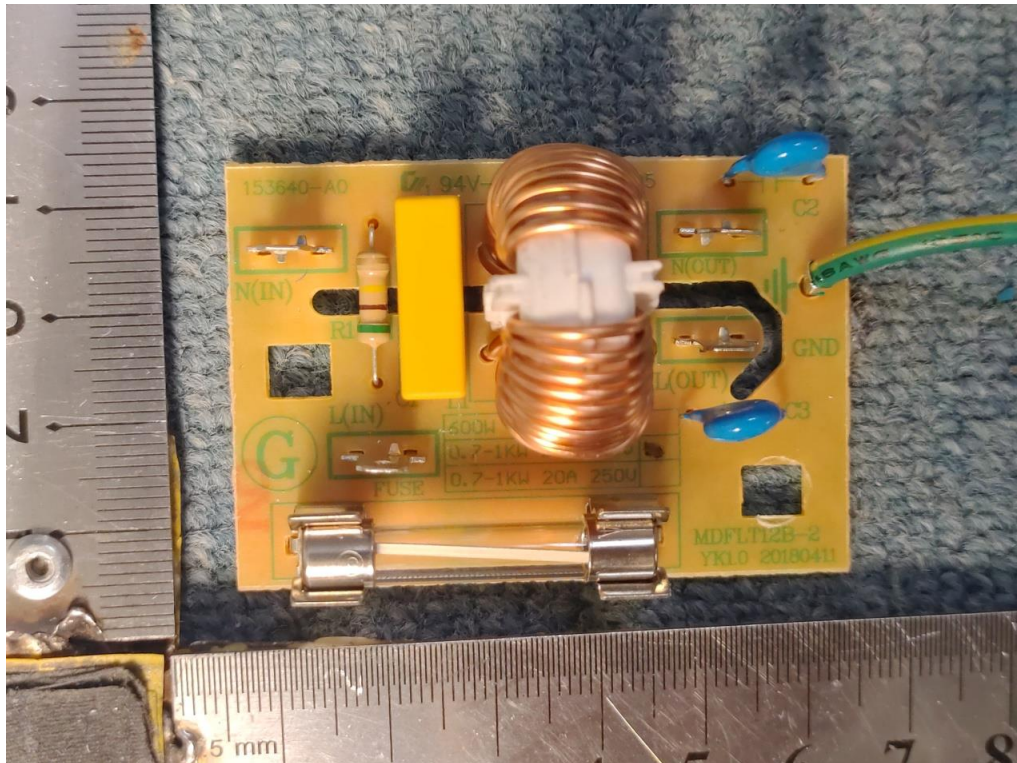

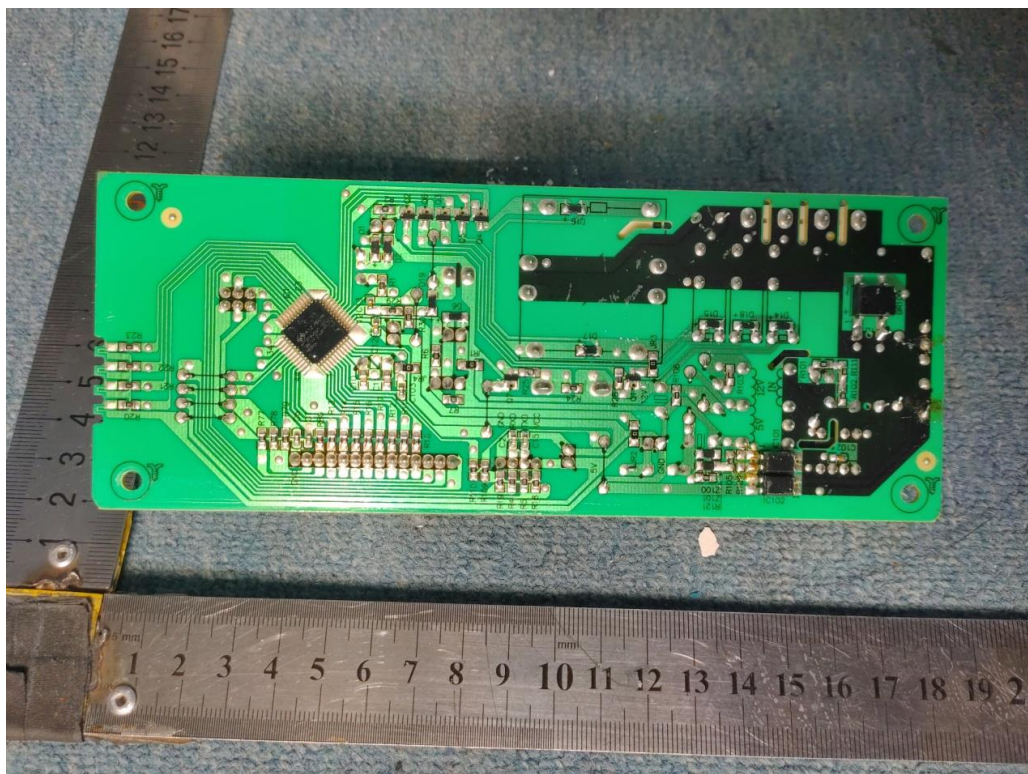
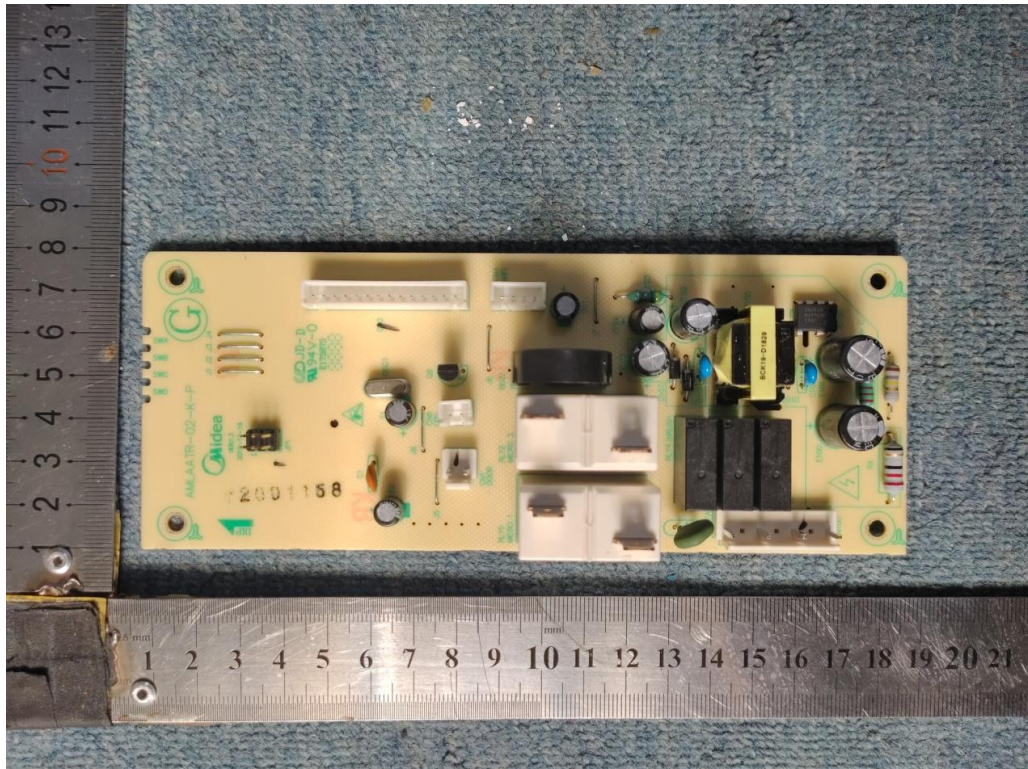

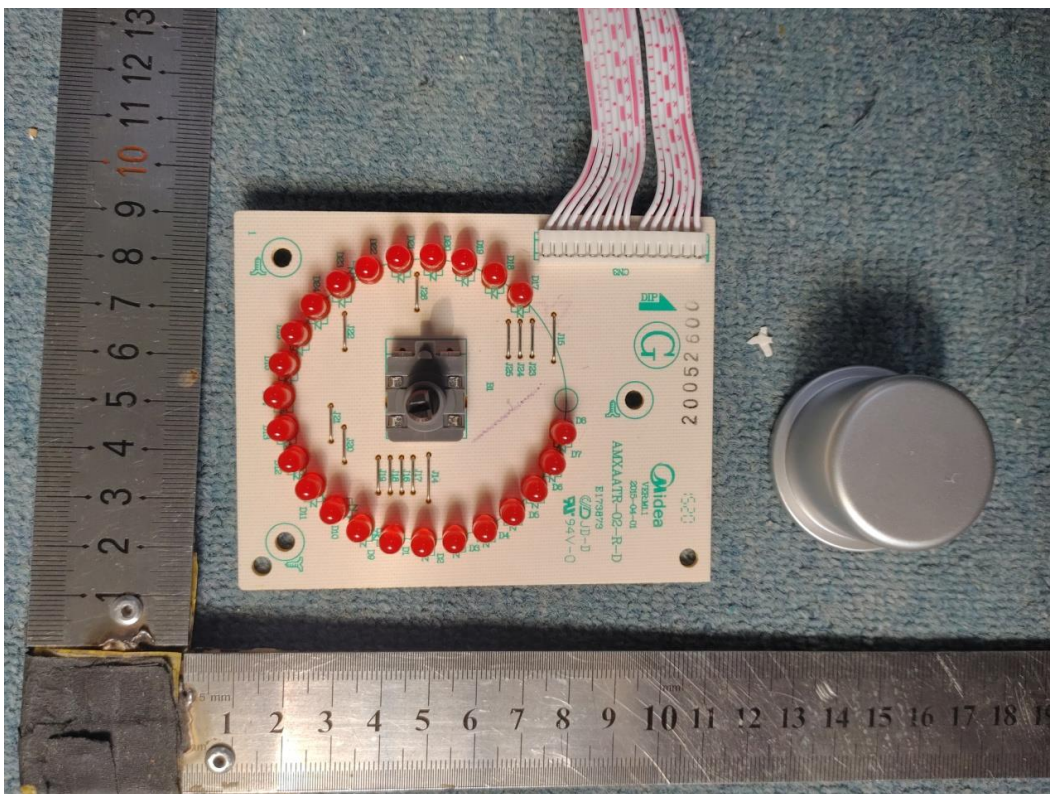
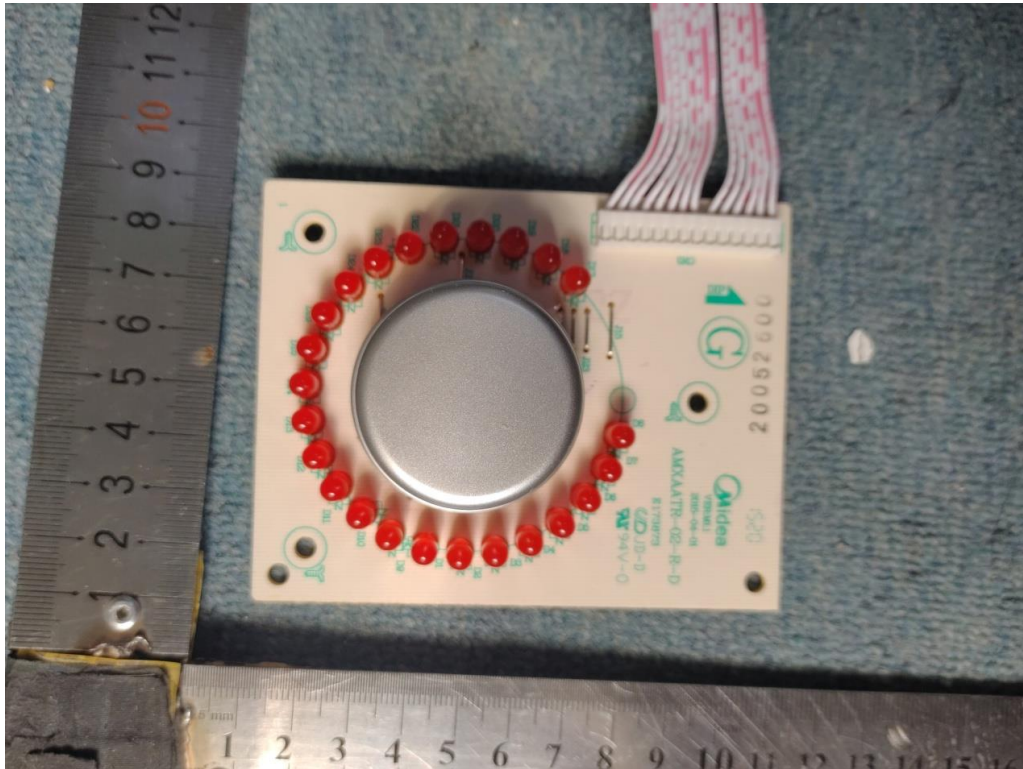

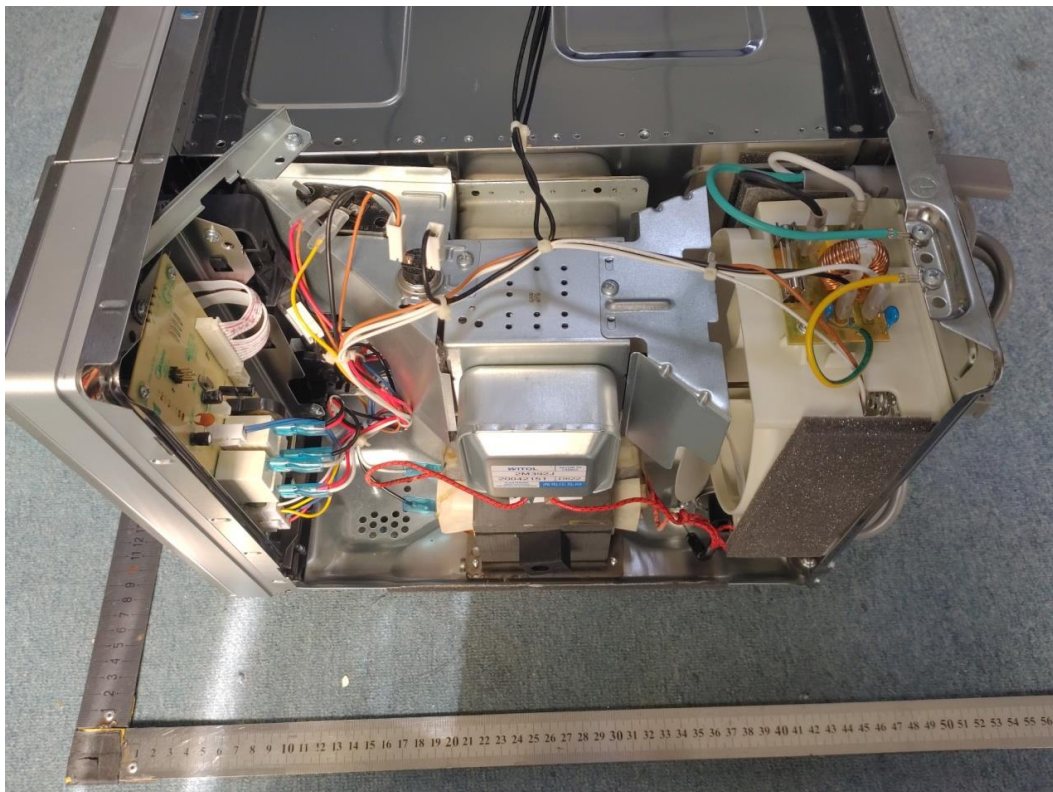
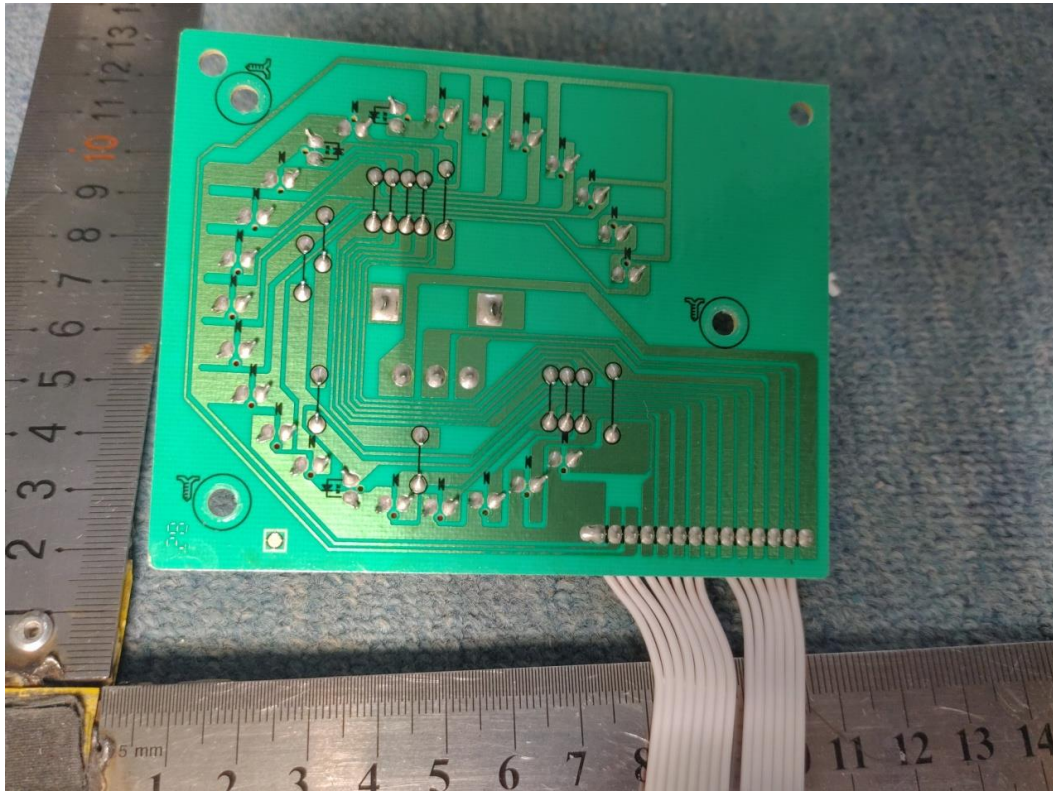

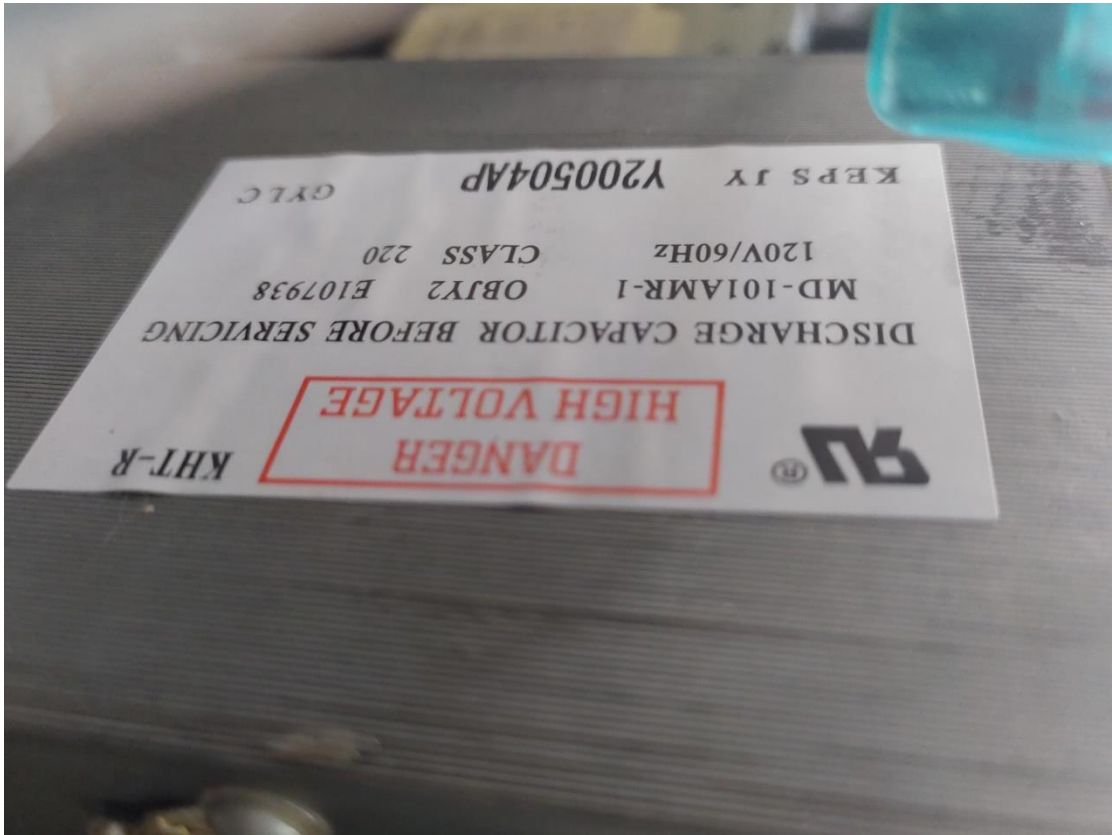

*** End Of Report ***