



FCC PART18 TEST REPORT

Report No.: 20240217G02271X-E

Product Name: Microwave Oven

Trade Name: Midea, TOSHIBA

Model No. : E(A)C034A##-S1, E(A)C034A***-S1, ML3-SEC34S(SS),
ML3-EC34SA(SS), CC-EC34SA(SS)

FCC ID : VG8XC034AYYY

Applicant: Guangdong Midea Kitchen Appliances Manufacturing Co., Ltd.

Received Date: 2024.02.02

Test Data: 2024.02.02-2024.02.20

Issued by: CCIC Southern Testing Co., Ltd.

Lab Location: Electronic Testing Building, No.43 Shahe Road, Xili Street, Nanshan District, Shenzhen, Guangdong, China

Tel: 86 755 26627338 **Fax:** 86 755 26627238

This test report consists of **31** pages in total. It may be duplicated completely for legal use with the approval of the applicant. It should not be reproduced except in full, without the written approval of our laboratory. The client should not use it to claim product endorsement by CCIC-SET. The test results in the report only apply to the tested sample. The test report shall be invalid without all the signatures of testing engineers, reviewer and approver. Any objections must be raised to CCIC-SET within 15 days since the date when the report is received. It will not be taken into consideration beyond this limit.



Test Report

Product Name..... Microwave Oven

Model No. E(A)C034A##-S1, E(A)C034A***-S1, ML3-SEC34S(SS),
ML3-EC34SA(SS), CC-EC34SA(SS)

Trade name..... Midea, TOSHIBA

Applicant..... Guangdong Midea Kitchen Appliances Manufacturing Co., Ltd.

Applicant Address..... No.6, Yong An Road, Beijiao, Shunde, Foshan, China

Manufacturer Guangdong Midea Kitchen Appliances Manufacturing Co., Ltd.

Manufacturer Address No.6, Yong An Road, Beijiao, Shunde, Foshan, China

Test Standards 47 CFR Part 18
47 CFR Part 15 Subpart B

Test Result..... PASS

Tested by Sun Jiaohui
Jiaohui Sun Test Engineer 2024.02.21

Reviewed by Chris You
Chris You Senior Engineer 2024.02.21

Approved by Yang Fan
Yang Fan, Manager 2024.02.21



TABLE OF CONTENTS

1.	GENERAL INFORMATION	5
1.1	GENERAL DESCRIPTION OF EUT	5
1.2	Test Standards and Results.....	7
1.3	Facilities and Accreditations.....	8
1.3.1	Facilities	8
1.3.2	Test Environment Conditions.....	8
1.3.3	Measurement Uncertainty	8
2.	EQUIPMENTS LIST	9
3.	EMC EMISSION TEST.....	10
3.1	Test Procedure.....	10
3.1.1	Frequency For Normal Voltage	10
3.1.2	Frequency For Line Voltage.....	10
3.1.3	Measurement data	11
3.2	RADIATION HAZARD TEST.....	11
3.2.1	Test Setup.....	11
3.2.2	Limit.....	11
3.2.3	Test results.....	11
3.3	RF OUTPUT POWER MEASUREMENT	12
3.3.1	Test Standard.....	12
3.3.2	EUT Operating mode	12
3.3.3	Test Data.....	12
4.	CONDUCTED EMISSION	13
4.1.1	Conducted Emission Limit.....	13
4.1.2	Test Procedure.....	13
4.1.3	Test Setup.....	13
5.	RADIATED EMISSION	20
5.1.1	Radiated Emission Limits	20
5.1.2	Test Setup.....	20
5.1.3	Test Procedure.....	21
APPENDIX I: PHOTOGRAPHS OF EMC TEST CONFIGURATION.....		30



Change History		
Issue	Date	Reason for change
1.0	2024.02.21	First edition



1. GENERAL INFORMATION

1.1 GENERAL DESCRIPTION OF EUT

EUT Name : Microwave Oven
 Trade Name..... : Midea, TOSHIBA
 Model..... : E(A)C034A##-S1, E(A)C034A***-S1, ML3-SEC34S(SS), ML3-EC34SA(SS), CC-EC34SA(SS) model designations as follows:
 E/A: “E” = Film type keypad type, “A” = Rotating type knob type;
 C: Microwave +Grill +Convection function;
 0: Indicates the microwave output power is 1000W,
 34: Indicates cavity capacity is 34 liters,
 A: Indicates the design No.;
 ## or ***: Indicates different appearance;
 S: Indicates Stainless Steel Cavity
 Customer models as “ML3-SEC34S(SS), ML3-EC34SA(SS), CC-EC34SA(SS)” with trade mark as “TOSHIBA”, they are identical to EC034AL7-S1 except for model number, trade mark and appearance.
 Model of EC034AL7-S1 was selected for final testing.

Power Supply : 120V AC/60Hz
 Rated input Power(microwave): 1500W
 Rated output Power(microwave): 1000W
 Convection Power : 1800W
 Grill Power..... : 1100W
 Frequency..... : 2450MHz(ClassB/Group 2)
 Magnetron Model..... : 2M319J
 Magnetron Manufacturer ... : WITOL
 Description of Support Units: -Load for power output measurement: 1000 milliliters of water in the beaker located in the center of the oven.
 -Load for frequency measurement: 1000 milliliters of water in the beaker located in the center of the oven.
 -Load for measurement of radiation on second and third harmonic: Two loads, one of 700 and the other of 300 milliliters, of water are used. Each load is tested both with the beaker located in the center of the oven and with it in the right front corner.

-Load for all other measurements: 700 milliliters of water, with the beaker located in the center of the oven.

Note 1: The EUT have the following typical setups during the test:

Setup1: Microwave heating mode(According to FCC PART 18);

Setup2: Grill mode(According to FCC PART 15B,digital device)

Setup3: Convection mode(According to FCC PART 15B,digital device)

Note 2: For a more detailed description, please refer to Specification or User’s Manual supplied by the applicant and/or manufacturer.

Note 3: This is an updating report based the original report #: “SET2022-06359” which was re-tested on February 2nd, 2024 to February 20th, 2024. Differences between them are as follow:

1. Difference in appearance & construction & PCB:

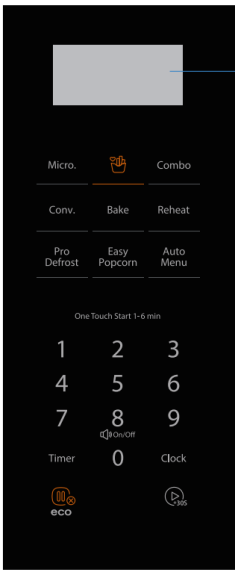
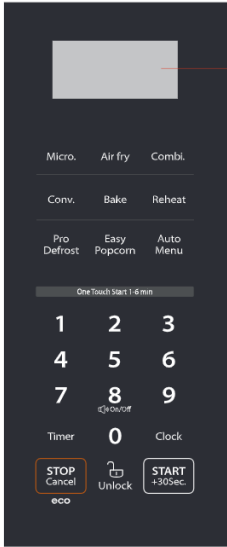
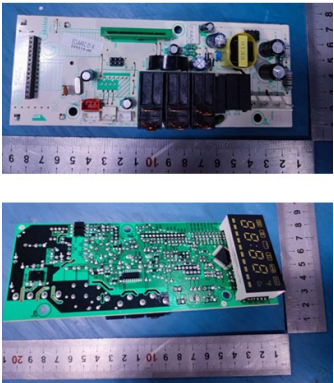
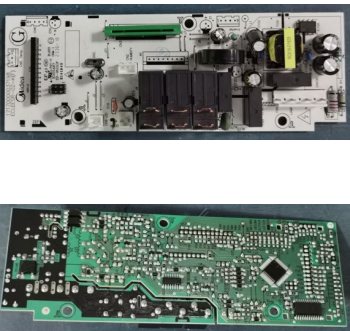
No.:	Original	New	Difference(s)
1			<p>Keypad: Updated front keypad to accommodate child lock function (Child resistant oven door function)</p>
2			<p>Mother board: Modified the peripheral circuit (non-RF circuit) and some individual components and PCB layout. The magnetron and other circuit are exactly same as before</p>

3	Not Applicable		The new one adds a solenoid valve locking mechanism, but the original is not.
---	----------------	---	---

2. Others are the same as before.

1.2 Test Standards and Results

The objective of the report is to perform testing according to 47 CFR Part 18:

No.	Identity	Document Title
1	47 CFR Part 18	Radio Frequency Devices
2	47 CFR Part 15 Subpart B	Radio Frequency Devices

Test detailed items/section required by FCC rules and results are as below:

Emission			
Standard	Item	Class / Severity	Result
47 CFR PART 18	Conducted Emission (150 kHz to 30 MHz)	18.307(b)	PASS
	Radiated Emission (30 MHz to 1 GHz)	18.305(b)	PASS
47 CFR PART 15	Conducted Emission (150 kHz to 30 MHz)	15.107	PASS
	Radiated Emission (30 MHz to 1 GHz)	15.109	PASS



1.3 Facilities and Accreditations

1.3.1 Facilities

CNAS-Lab Code: L1659

CCIC-SET is a third party testing organization accredited by China National Accreditation Service for Conformity Assessment (CNAS) according to ISO/IEC 17025. The accreditation certificate number is L1659.

FCC-Registration No.: CN1283

CCIC Southern Testing Co., Ltd EMC Laboratory has been registered and fully described in a report filed with the FCC (Federal Communications Commission). The acceptance letter from the FCC is maintained in our files. Designation Number: CN1283, valid time is until June 30,2025.

ISED Registration: 11185A-1

CCIC Southern Testing Co., Ltd. EMC Laboratory has been registered by Certification and Engineering Bureau of Industry Canada for the performance of radiated measurements with Registration No. 11185A-1 on Aug. 04, 2016, valid time is until June 30,2025.

A2LA Code: 5721.01

CCIC-SET is a third party testing organization accredited by A2LA according to ISO/IEC 17025. The accreditation certificate number is 5721.01.

1.3.2 Test Environment Conditions

During the measurement, the environmental conditions were within the listed ranges:

Temperature (°C):	15°C- 35°C
Relative Humidity (%):	25% -75%
Atmospheric Pressure (kPa):	86kPa-106kPa

1.3.3 Measurement Uncertainty

The uncertainty is calculated using the methods suggested in the "Guide to the Expression of Uncertainty in Measurement" (GUM) published by ISO.

Uncertainty of Conducted Emission:	Uc = 3.2 dB (k=2)
Uncertainty of Radiated Emission:(30MHz~1GHz)	Uc = 5.8 dB (k=2)
Uncertainty of Radiated Emission:(1~18GHz)	Uc = 5.1 dB (k=2)



2. EQUIPMENTS LIST

A. Equipment List:

Description	Manufacturer	Model	Serial No.	Calibration Date	Calibration Due. Date
Test Receiver	Rohde & Schwarz	ESIB26	A0304218	2023.10.20	2024.10.19
LISN	ROHDE&SCHWARZ	NSLK 8127	A210803670	2023.06.08	2024.06.07
Shield Room	Xinju Electronics	L9000*W4500* H3100	A181003230	2021.09.05	2024.09.04
EMI Test Receiver	ROHDE&SCHWARZ	ESIB7	A0501375	2023.03.16	2024.03.15
Broadband Ant.	ETC	MCTD2786	A150402240	2021.03.05	2024.03.04
3M Anechoic Chamber	Albatross	SAC-3MAC 9*6*6m	A0412375	2021.03.26	2024.03.25
EMI Test Receiver	ROHDE&SCHWARZ	ESW26	A180502935	2023.06.08	2024.06.07
5M Anechoic Chamber	Albatross	SAC-5MAC 12.8x6.8x6.4m	A0304210	2021.06.08	2024.06.07
EMI Horn Ant.	ETC	1209	A150402241	2023.05.16	2024.05.23
Spectrum Analyzer	ROHDE&SCHWARZ	ESW26	A180502935	2023.06.08	2024.06.07
Portable Spectrometer	ROHDE&SCHWARZ	FSH8	A140401672	2024.02.13	2025.02.12
Prode	ROHDE&SCHWARZ	TSEMF-B1	A140401671	2024.02.14	2025.02.13



3. EMC EMISSION TEST

3.1 Test Procedure

Test Requirement: 47 CFR PART 18

Test Method: FCC/OST MP-5:1986

Power Supply: AC 120V/ 60Hz

Frequency Range: 2400-2500MHz

Detector: Peak

Limit: ISM equipment may be operated at any frequency above 9KHz and the frequency band 2400-2500MHz is allocated for use by ISM equipment

ISM frequency	Tolerance
6.78 MHz	±15.0 kHz
13.56 MHz	±7.0 kHz
27.12 MHz	±163.0 kHz
40.68 MHz	±20.0 kHz
915 MHz	±13.0 MHz
2,450 MHz	±50.0 MHz
5,800 MHz	±75.0 MHz
24,125 MHz	±125.0 MHz
61.25 GHz	±250.0 MHz
122.50 GHz	±500.0 MHz
245.00 GHz	±1.0 GHz

3.1.1 Frequency For Normal Voltage

The operating frequency was measured using a spectrum analyzer. Starting with the EUT at room temperature, a 1000mL water load was placed in the center of the oven and the oven was operated at maximum output power. The fundamental operating frequency was monitored until the water load was reduced to 20 percent of the original load.

3.1.2 Frequency For Line Voltage

The EUT was operated / warmed by at least 10 minutes of use with a 1000mL water load at room temperature at the beginning of the test. Then the operating frequency was monitored as the input voltage was varied between 80 and 125 percent of the nominal rating.



3.1.3 Measurement data

Operating Mode	Frequency(MHz)
Normal Voltage	2431.8-2469.3
Line Voltage	2434.6-2473.2

3.2 RADIATION HAZARD TEST

3.2.1 Test Setup

The EUT was set-up according to the FCC MP-5 and FCC Part 18 for radiation Hazard measurement. The measurement was using a microwave leakage meter to measure the radiation leakage in the as-received condition with the oven door closed A 700mL water load in a breaker was located in the center of the oven and the microwave oven was set to maximum power. While the oven operating, the microwave meter will check the leakage and then record the maximum leakage.

3.2.2 Limit

A maximum of 1.0mW/cm²is allowed in according with the applicable FCC standards

3.2.3 Test results

Test location	Test result (mW/cm ²)	Limit(mW/cm ²)	Verdict
Left side	0.25	1.0	Pass
Right side	0.20	1.0	Pass
Front	0.34	1.0	Pass
Rear	0.23	1.0	Pass

There was no microwave leakage exceeding a power level of 0.34 m W/cm²Observed at any point 5cm or more from the external surface of the oven



3.3 RF OUTPUT POWER MEASUREMENT

3.3.1 Test Standard

Test Requirement	47 CFR PART 18
Test Method	FCC/OST MP-5:1986
Power Supply	AC120/60Hz

3.3.2 EUT Operating mode

Test the EUT in microwave mode with full power.

3.3.3 Test Data

Mass of Water(g)	Mass of the container(g)	ambient temperature (°C)	Initial temperature(°C)	Final temperature(°C)	Heating Time(S)	Output Power(Watt)
1000	280	19.2	10.8	31.3	120	742.9

Formula:

$$P = \frac{4.2 \times m_w(T_2 - T_1) + 0.9 \times m_c(T_2 - T_0)}{t}$$

P is the microwave power output, in watts

Mw is the mass of the water, in grams

Mc is the mass of the container, in grams

T0 is the ambient temperature, in degrees Celsius

T1 is Initial temperature of the water, in degrees Celsius

T2 is final temperature of the water, in degrees Celsius

T is heating time, in seconds, excluding the magnetron filament heating-up time

4. CONDUCTED EMISSION

4.1.1 Conducted Emission Limit

Frequency range (MHz)	Conducted Limit (dB μ V)	
	Quasi-peak	Average
0.15 - 0.50	66 to 56	56 to 46
0.50 - 5	56	46
5 - 30	60	50

Note:

- a) The limit decreases linearly with the logarithm of the frequency in the range 0.05 MHz to 0.5 MHz.
- b) The lower limit is applicable at the transition frequency.

4.1.2 Test Procedure

The EUT is placed on a 0.8m high insulating table, which stands on the grounded conducting floor, and keeps 0.4m away from the grounded conducting wall. The EUT is connected to the power mains through a LISN which provides 50 Ω /50 μ H of coupling impedance for the measuring instrument. The Common Antenna is used for the call between the EUT and the System Simulator (SS). A Pulse Limiter is used to protect the measuring instrument. The factors of the whole test system are calibrated to correct the reading.

4.1.3 Test Setup

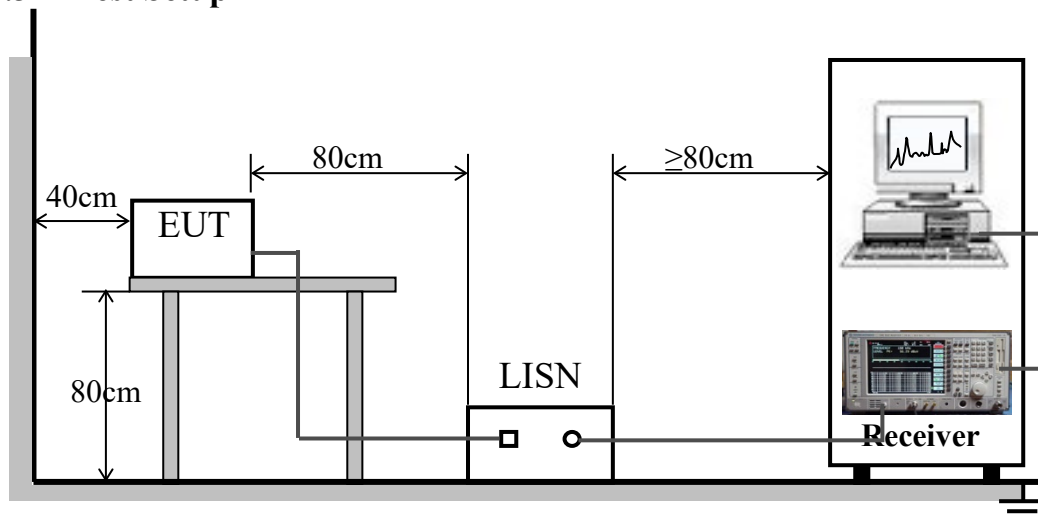

A. Test Result:

Mains terminal disturbance voltage, Setup1,L phase

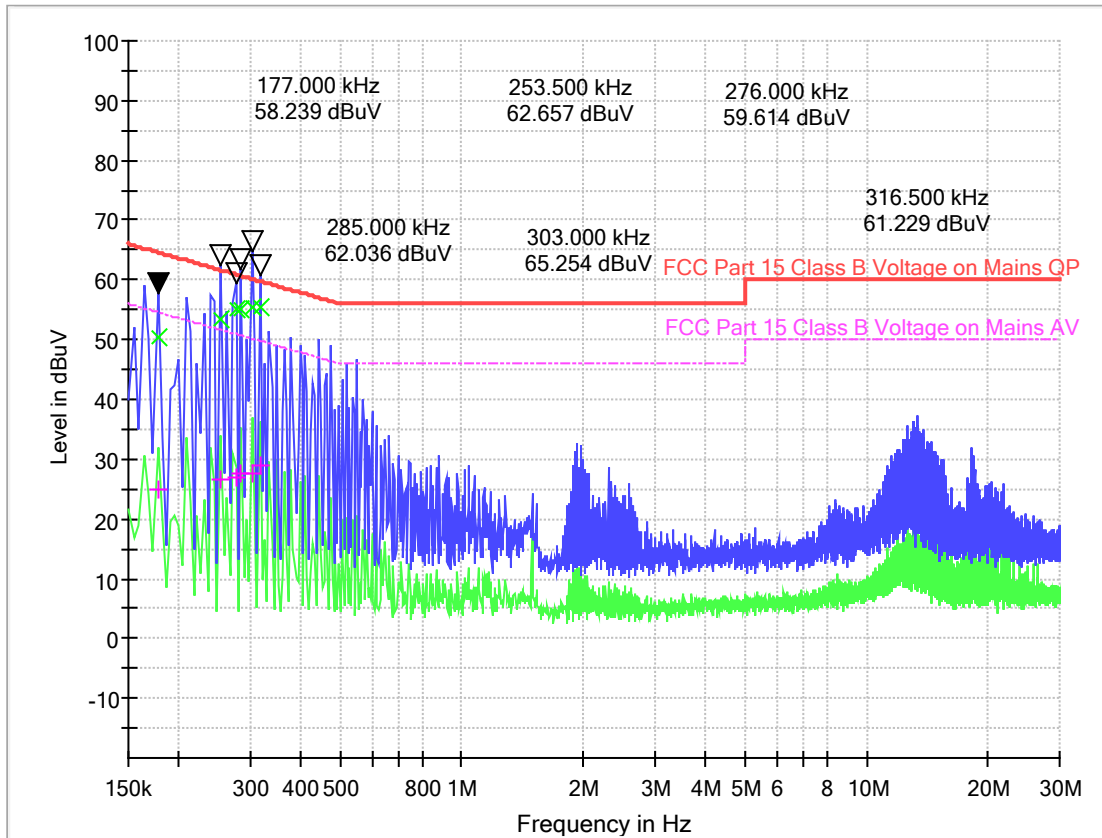

(Plot A: L Phase)

Frequency (MHz)	Quasi Peak (dB μ V)	Average (dB μ V)	Cabel Loss (dB)	Corr. (dB)	Margin - QPK	Limit - QPK	Margin - AV	Limit - AV (dB μ V)
0.177000	50.42	24.91	0.1	10.1	14.21	64.6	29.72	54.6
0.253500	53.33	26.60	0.1	10.1	8.31	61.6	25.04	51.6
0.276000	55.02	26.83	0.1	10.1	5.92	60.9	24.11	50.9
0.285000	55.05	27.49	0.1	10.1	5.62	60.7	23.18	50.7
0.303000	55.32	27.62	0.1	10.1	4.84	60.2	22.54	50.2
0.316500	55.55	29.07	0.1	10.1	4.25	59.8	20.73	49.8



Mains terminal disturbance voltage, Setup 1, N phase

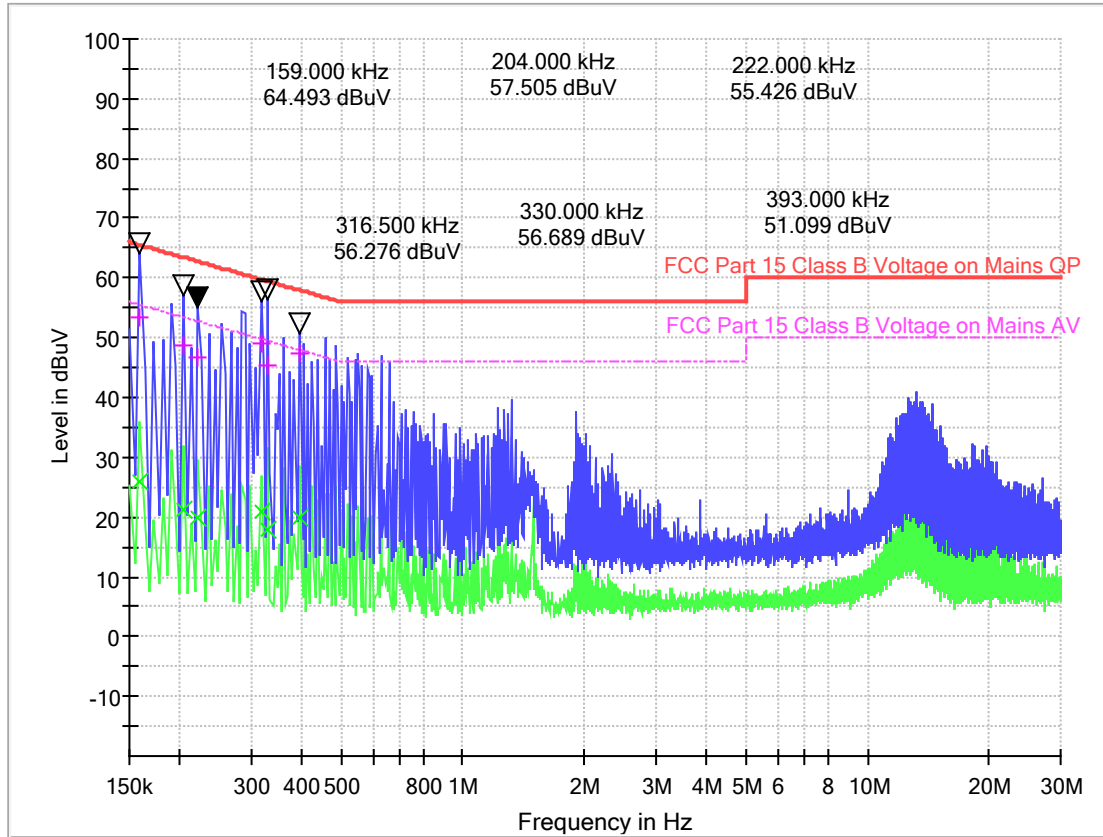

(Plot B: N Phase)

Frequency (MHz)	Quasi Peak (dB μ V)	Average (dB μ V)	Cabel Loss (dB)	Corr. (dB)	Margin - QPK	Limit - QPK	Margin - AV	Limit - AV (dB μ V)
0.159000	53.57	25.93	0.1	10.1	11.95	65.5	29.59	55.5
0.204000	48.58	21.32	0.1	10.1	14.87	63.4	32.13	53.4
0.222000	46.70	19.88	0.1	10.1	16.04	62.7	32.86	52.7
0.316500	49.14	20.95	0.1	10.1	10.66	59.8	28.85	49.8
0.330000	45.45	17.92	0.1	10.1	14.00	59.5	31.53	49.5
0.393000	47.47	19.94	0.1	10.1	10.53	58.0	28.06	48.0



Mains terminal disturbance voltage, Setup2,L phase

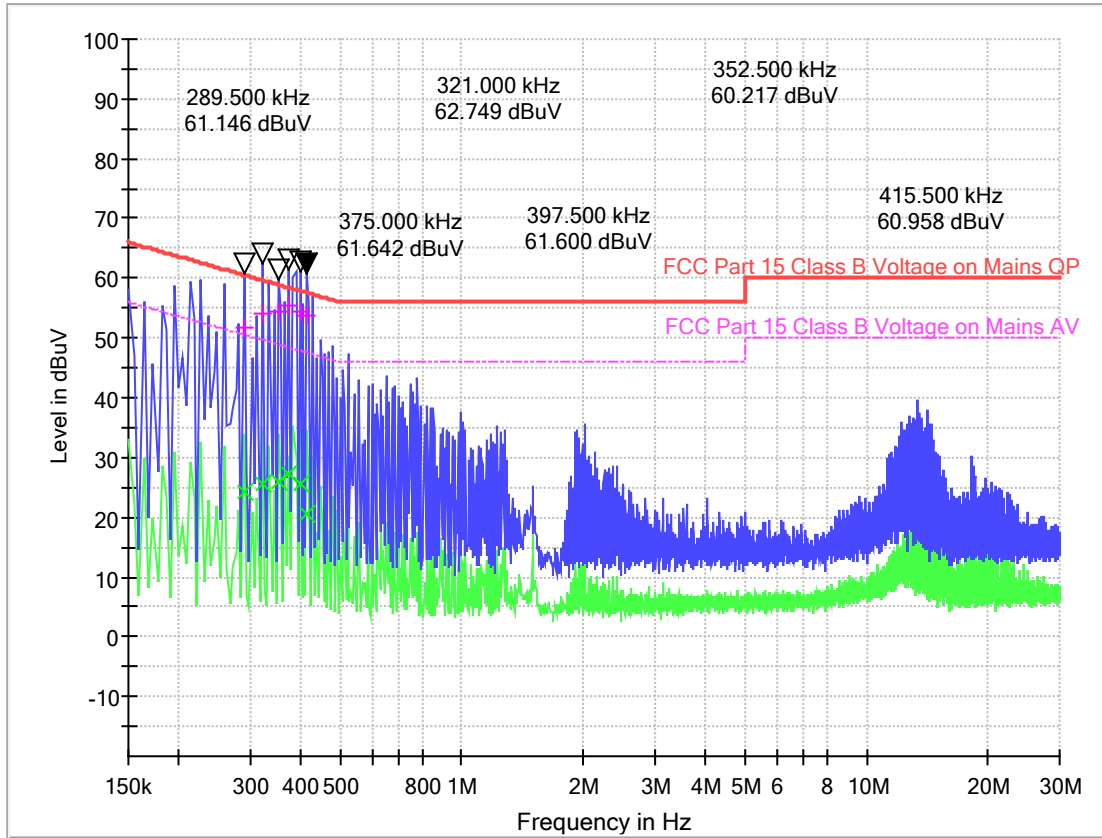

(Plot C: L Phase)

Frequency (MHz)	Quasi Peak	Average (dB μ V)	Cable Loss (dB)	Corr. (dB)	Margin - QPK	Limit - QPK	Margin - AV	Limit - AV (dB μ V)
0.289500	51.78	24.30	0.1	10.1	8.76	60.5	26.24	50.5
0.321000	54.17	25.71	0.1	10.1	5.51	59.7	23.97	49.7
0.352500	54.47	25.96	0.1	10.1	4.43	58.9	22.94	48.9
0.375000	55.27	27.35	0.1	10.1	3.12	58.4	21.04	48.4
0.397500	54.54	25.43	0.1	10.1	3.37	57.9	22.48	47.9
0.415500	53.68	20.50	0.1	10.1	3.86	57.5	27.04	47.5



Mains terminal disturbance voltage, Setup 2, N phase

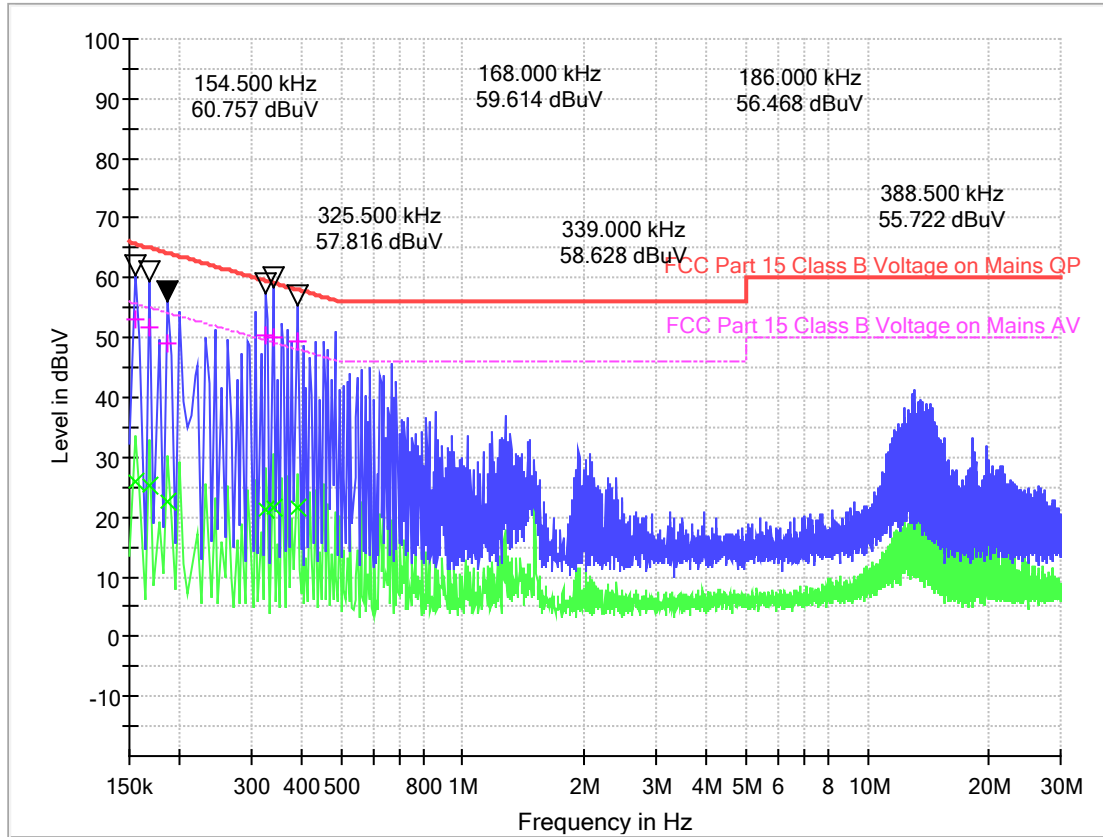

(Plot D: N Phase)

Frequency (MHz)	Quasi Peak	Average (dB μ V)	Cable Loss (dB)	Corr. (dB)	Margin - QPK	Limit - QPK	Margin - AV	Limit - AV (dB μ V)
0.154500	52.96	25.90	0.1	10.1	12.79	65.8	29.85	55.8
0.168000	51.79	25.16	0.1	10.1	13.27	65.1	29.90	55.1
0.186000	49.08	22.49	0.1	10.1	15.13	64.2	31.72	54.2
0.325500	50.25	21.21	0.1	10.1	9.32	59.6	28.36	49.6
0.339000	50.17	21.45	0.1	10.1	9.06	59.2	27.78	49.2
0.388500	49.27	21.57	0.1	10.1	8.83	58.1	26.53	48.1

Mains terminal disturbance voltage, Setup3,L phase

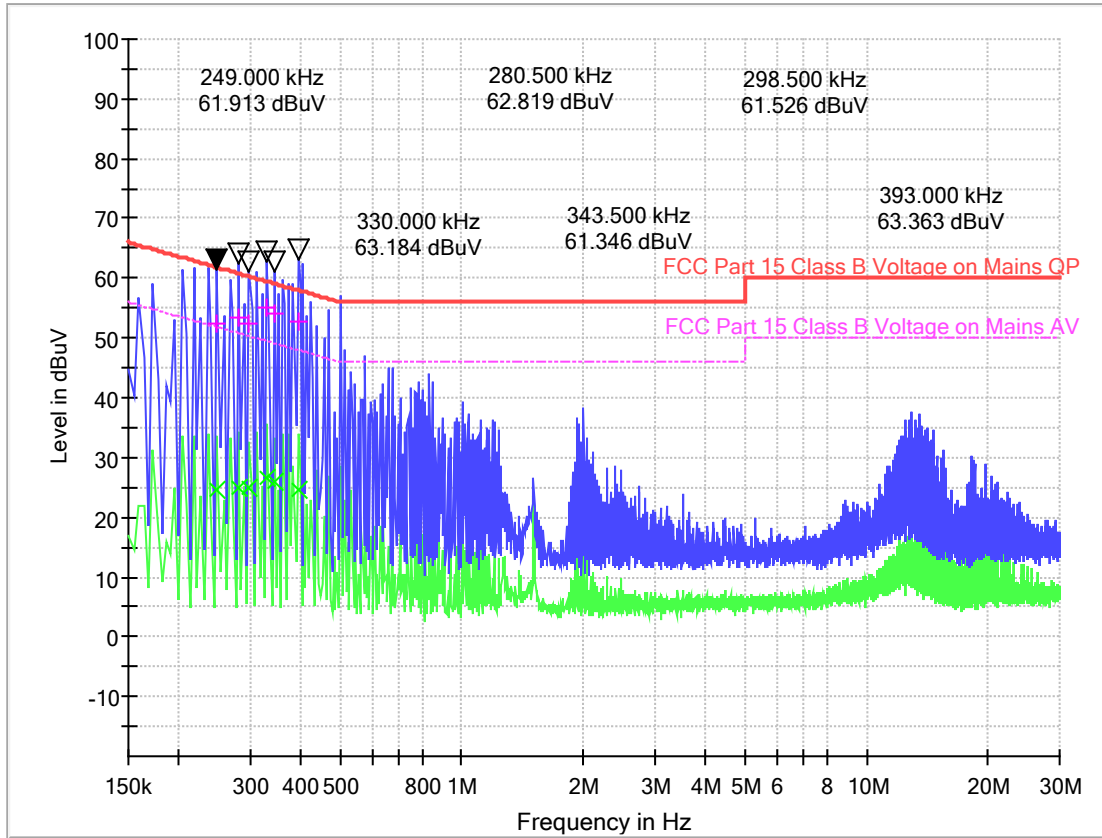

(Plot E: L Phase)

Frequency (MHz)	Quasi Peak	Average (dB μ V)	Cabel Loss (dB)	Corr. (dB)	Margin - QPK	Limit - QPK	Margin - AV	Limit - AV (dB μ V)
0.249000	52.47	24.70	0.1	10.1	9.32	61.8	27.09	51.8
0.280500	53.28	25.05	0.1	10.1	7.52	60.8	25.75	50.8
0.298500	52.56	24.79	0.1	10.1	7.72	60.3	25.49	50.3
0.330000	55.11	26.47	0.1	10.1	4.34	59.5	22.98	49.5
0.343500	54.08	25.82	0.1	10.1	5.04	59.1	23.30	49.1
0.393000	52.61	24.52	0.1	10.1	5.39	58.0	23.48	48.0



Mains terminal disturbance voltage, Setup 3, N phase

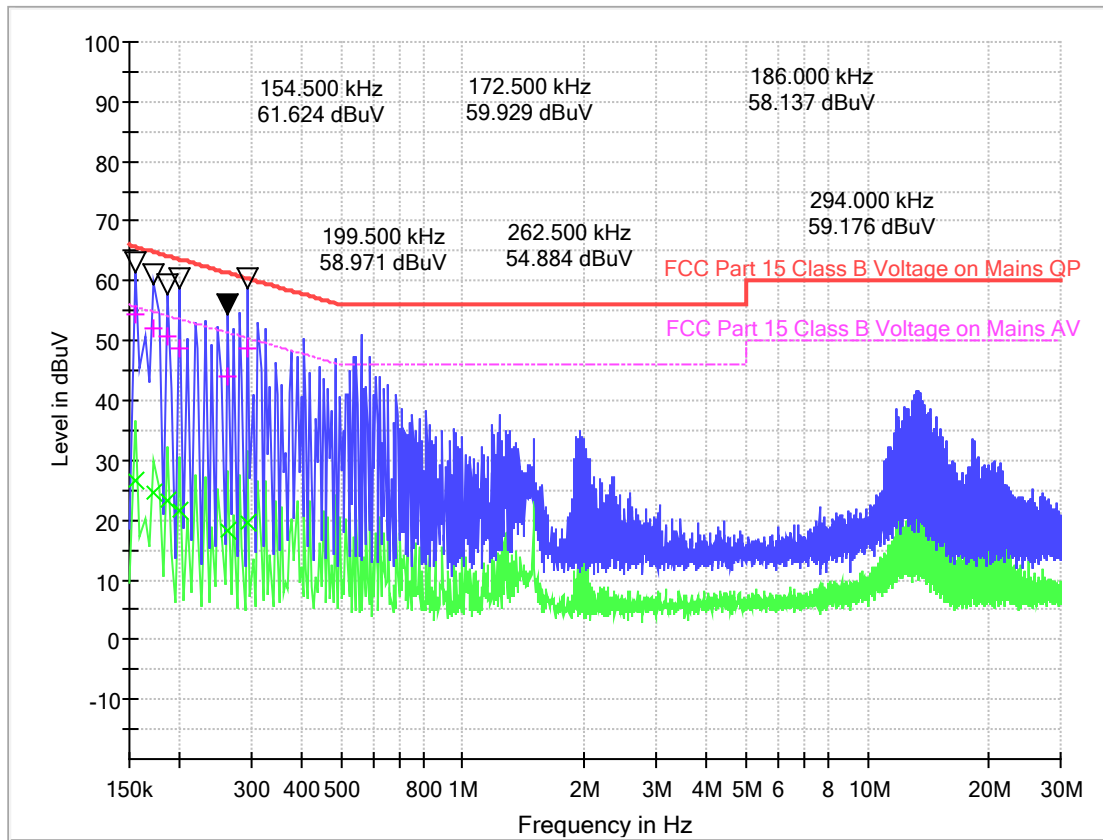

(Plot F: N Phase)

Frequency (MHz)	QuasiPea k	CAverage (dB μ V)	Cabel Loss (dB)	Corr. (dB)	Margin - QPK	Limit - QPK	Margin - AV	Limit - AV (dB μ V)
0.154500	54.32	26.63	0.1	10.1	11.43	65.8	29.12	55.8
0.172500	51.91	24.51	0.1	10.1	12.93	64.8	30.33	54.8
0.186000	50.60	23.24	0.1	10.1	13.61	64.2	30.97	54.2
0.199500	48.75	21.47	0.1	10.1	14.88	63.6	32.16	53.6
0.262500	43.99	18.21	0.1	10.1	17.36	61.4	33.14	51.4
0.294000	48.66	19.42	0.1	10.1	11.75	60.4	30.99	50.4

Test Result: PASS

5. RADIATED EMISSION

5.1.1 Radiated Emission Limits

- (a) ISM equipment operation on a frequency specified in §18.301 is permitted unlimited radiated energy in the band specified for that frequency.
- (b) The field strength levels of emissions which lie outside the bands specified in §18.301, unless otherwise indicated, shall not exceed the following:

RF Power generated by equipment(watts)	Field strength limit(uV/m) @300m
Below 500	25
500or more	$25 * \text{SQRT}(\text{power}/500)$

Power =742.9W

Limit= $20\lg(25 * \text{SQRT}(\text{power}/500)) + 20\lg(300/3)$ @ 3m distance.

5.1.2 Test Setup

For radiated emissions from 30MHz to1GHz

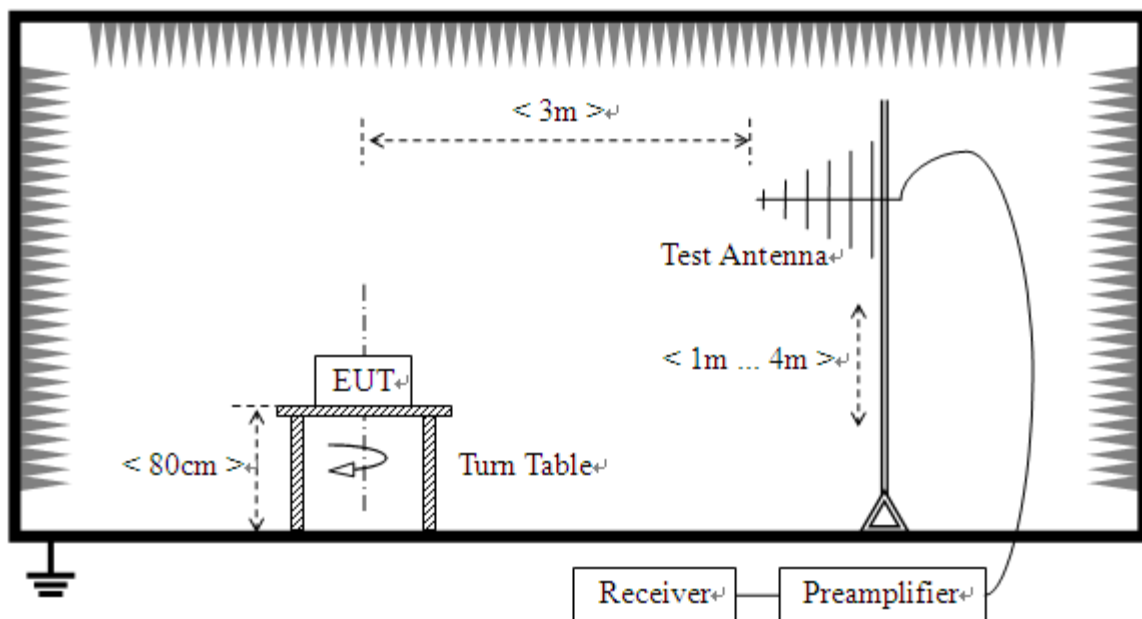

For radiated emissions above 1GHz

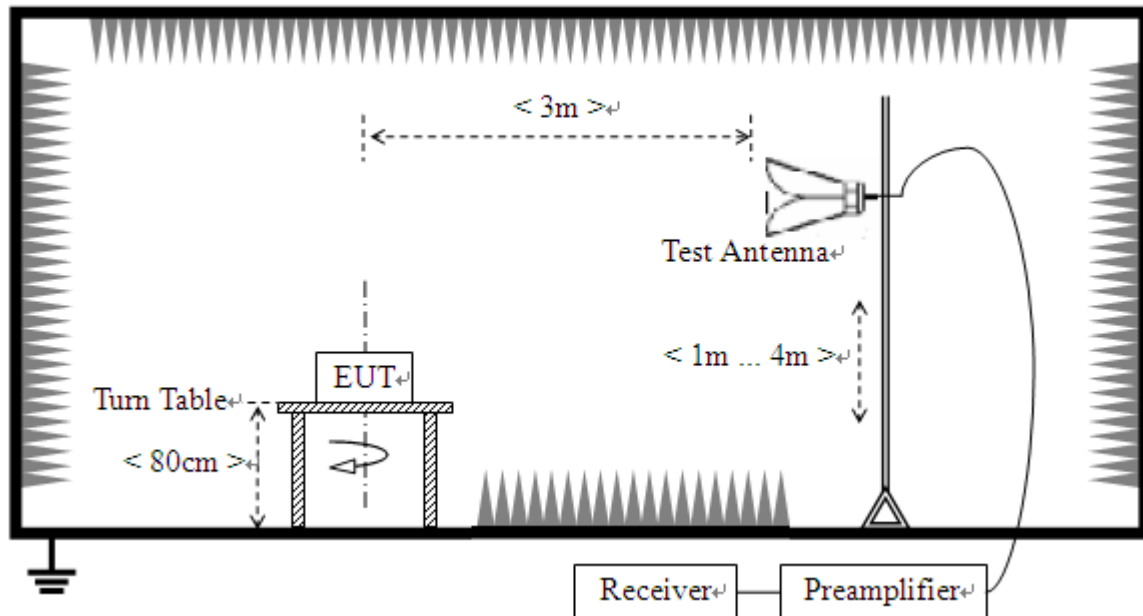

5.1.3 Test Procedure

- The measuring distance of at 3 m shall be used for measurements at frequency up to 1GHz. For frequencies above 1GHz, any suitable measuring distance may be used.
- The EUT was placed on the top of a rotating table 0.8 meters above the ground at a 3 meter open area test site. The table was rotated 360 degrees to determine the position of the highest radiation.
- The height of the equipment or of the substitution antenna shall be 0.8 m; the height of the test antenna shall vary between 1 m to 4 m. Both horizontal and vertical polarizations of the antenna are set to make the measurement
- The initial step in collecting conducted emission data is a spectrum analyzer peak detector mode pre-scanning the measurement frequency range. Significant peaks are then marked and then Quasi Peak detector mode re-measured.
- If the Peak Mode measured value compliance with and lower than Quasi Peak Mode Limit, the EUT shall be deemed to meet QP Limits and then no additional QP Mode measurement performed.
- For the actual test configuration, please refer to the related Item –EUT Test Photos.

Note: Both horizontal and vertical antenna polarities were tested and performed pretest to three orthogonal axis. The worst case emissions were reported

Test Result:

Radiation disturbances, antenna polarization: Setup1, Horizontal

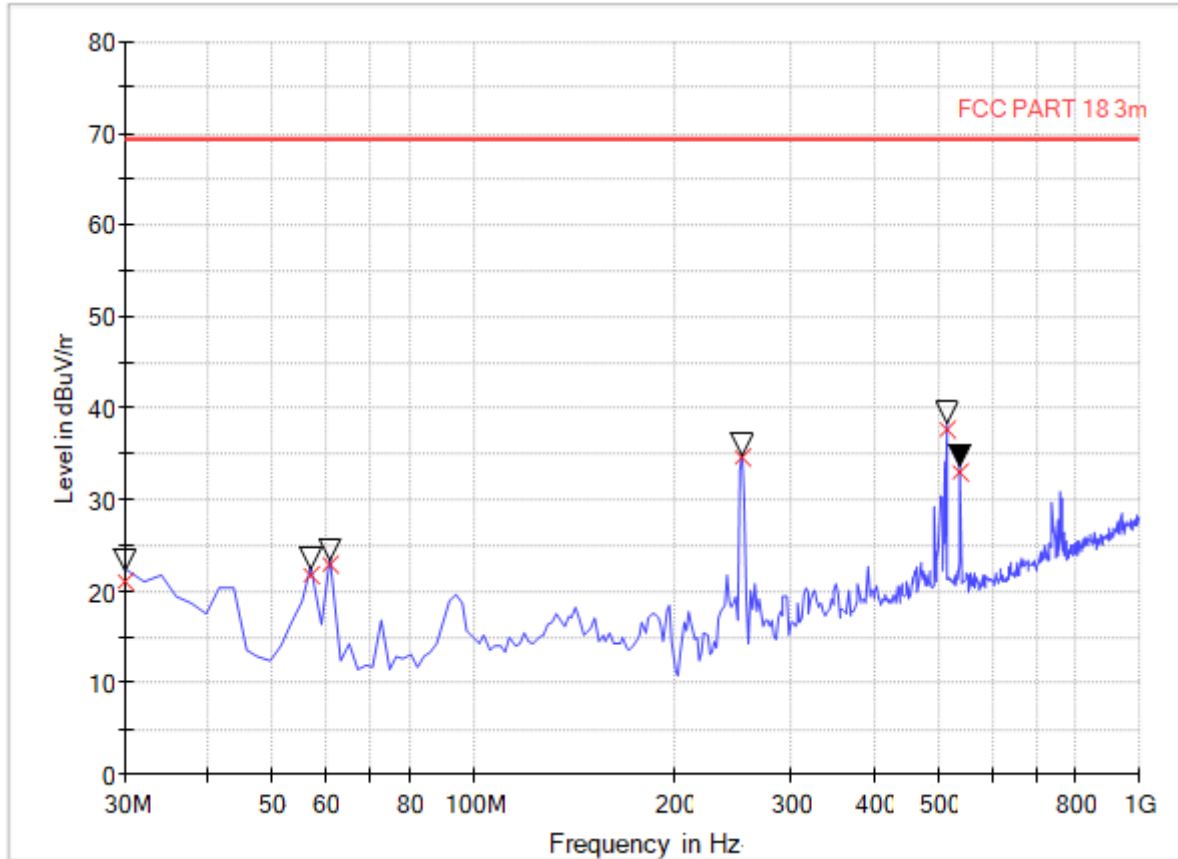

(Plot A: Test Antenna Horizontal 30M - 1G)

Frequency (MHz)	Quasi Peak (dB μ V/m)	Bandwidth (kHz)	Antenna height (cm)	Limit (dB μ V/m)	Margin (dB)	Antenna	Verdict
30.00	21.15	120.000	100.0	69.70	48.55	Horizontal	Pass
57.20	21.69	120.000	100.0	69.70	48.01	Horizontal	Pass
61.12	22.95	120.000	100.0	69.70	46.75	Horizontal	Pass
253.56	34.57	120.000	100.0	69.70	35.13	Horizontal	Pass
514.04	37.62	120.000	100.0	69.70	32.08	Horizontal	Pass
539.28	32.96	120.000	100.0	69.70	36.74	Horizontal	Pass

Radiation disturbances, antenna polarization:Setup1,Vertical

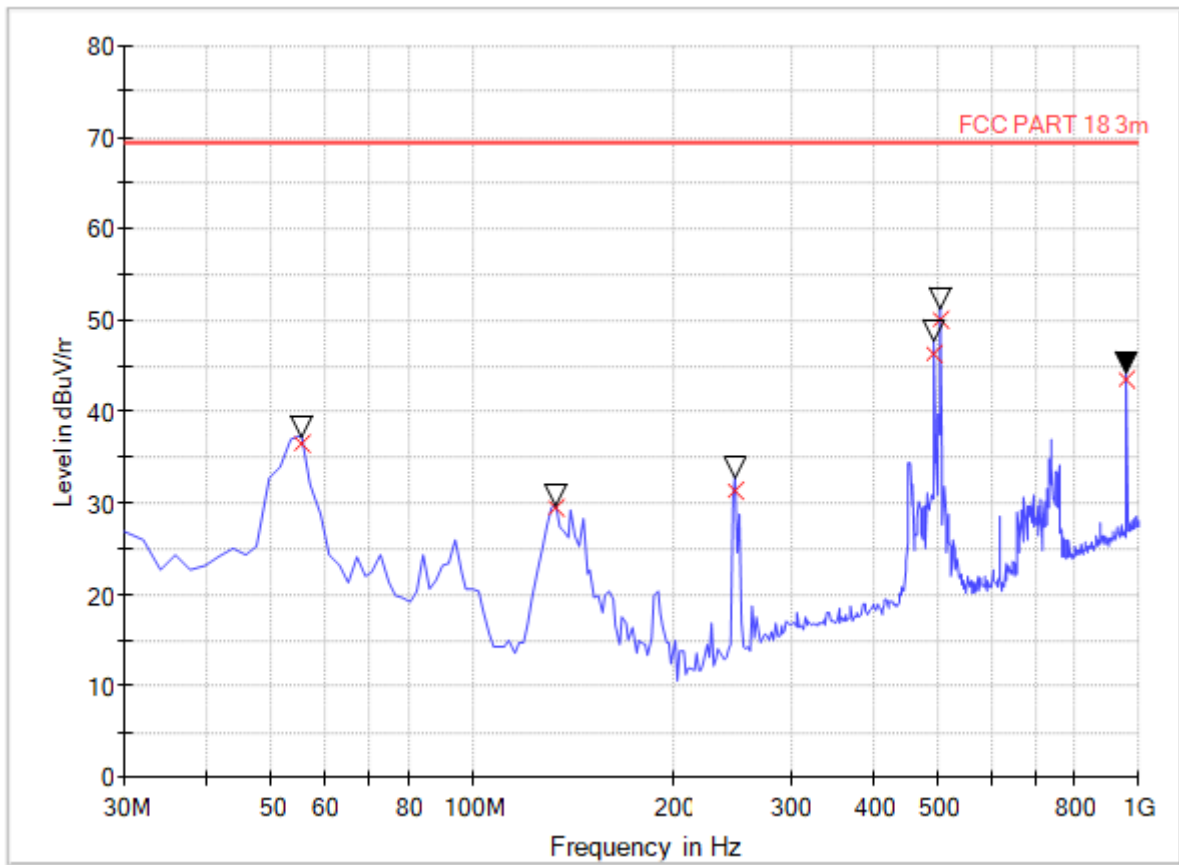

(Plot B: Test Antenna Vertical 30M - 1G)

Frequency (MHz)	Quasi Peak (dB μ V/m)	Bandwidth (kHz)	Antenna height (cm)	Limit (dB μ V/m)	Margin (dB)	Antenna	Horizontal
55.28	36.58	120.000	100.0	69.70	33.12	Vertical	Pass
133.04	29.46	120.000	100.0	69.70	40.24	Vertical	Pass
247.72	31.39	120.000	100.0	69.70	38.31	Vertical	Pass
492.64	46.20	120.000	100.0	69.70	23.50	Vertical	Pass
504.32	50.02	120.000	100.0	69.70	19.68	Vertical	Pass
959.16	43.41	120.000	100.0	69.70	26.29	Vertical	Pass

Radiation disturbances, antenna polarization: Setup2, Horizontal

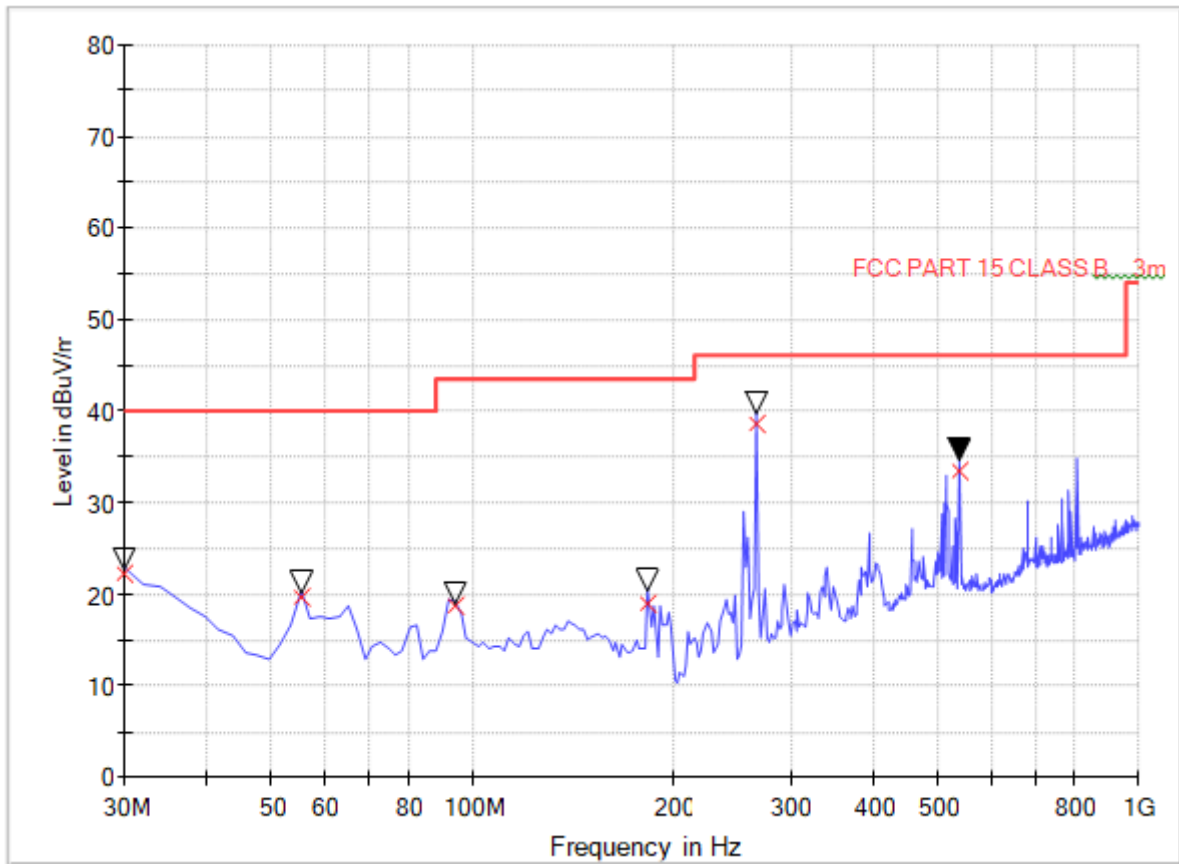

(Plot C: Test Antenna Horizontal30M - 1G)

Frequency (MHz)	Quasi Peak (dB μ V/m)	Bandwidth (kHz)	Antenna height (cm)	Limit (dB μ V/m)	Margin (dB)	Antenna	Verdict
30.00	22.15	120.000	100.0	40.00	17.85	Horizontal	Pass
55.28	19.70	120.000	100.0	40.00	20.30	Horizontal	Pass
94.16	18.63	120.000	100.0	43.50	24.87	Horizontal	Pass
183.56	19.00	120.000	100.0	43.50	24.50	Horizontal	Pass
267.16	38.63	120.000	100.0	46.00	7.37	Horizontal	Pass
539.28	33.55	120.000	100.0	46.00	12.45	Horizontal	Pass

Radiation disturbances, antenna polarization: Setup2, Vertical

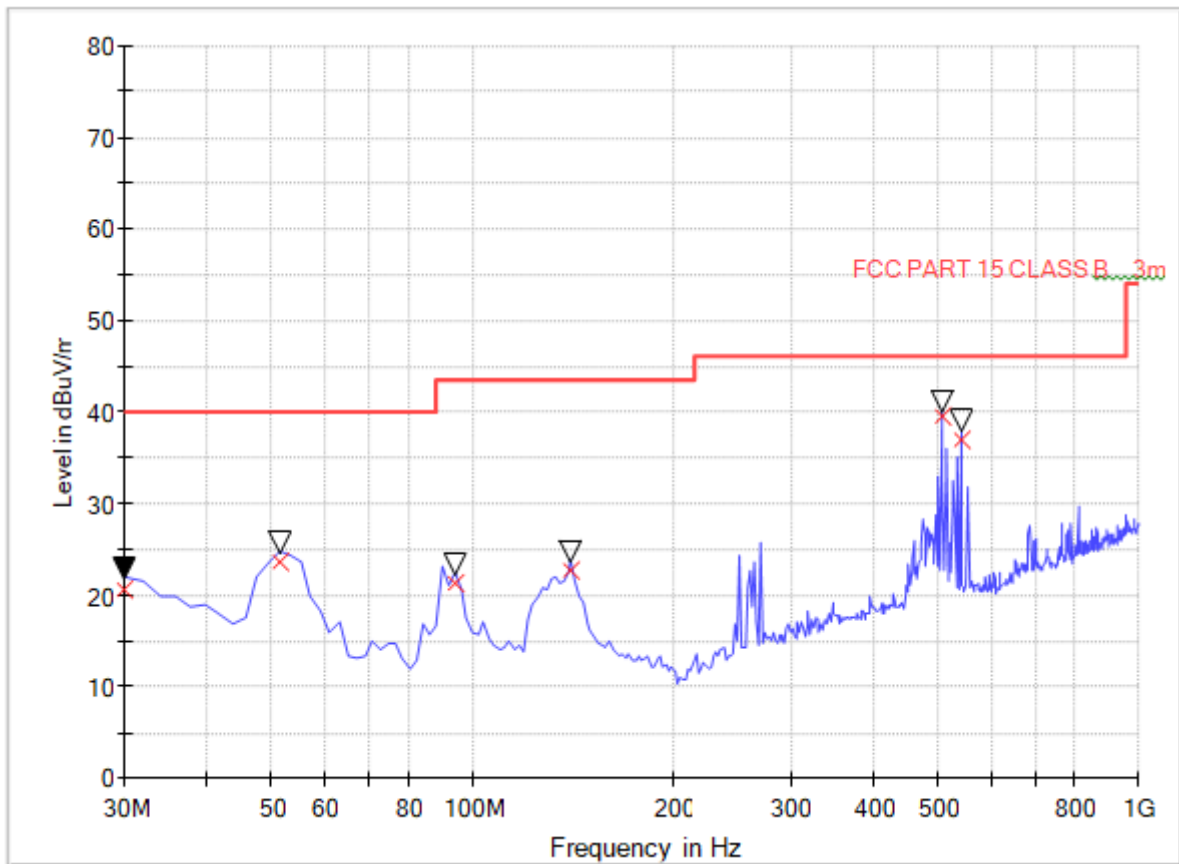

(Plot D: Test Antenna Vertical30M - 1G)

Frequency (MHz)	Quasi Peak (dB μ V/m)	Bandwidth (kHz)	Antenna height (cm)	Limit (dB μ V/m)	Margin (dB)	Antenna	Horizontal
30.00	20.47	120.000	100.0	40.00	19.53	Vertical	Pass
51.40	23.57	120.000	100.0	40.00	16.43	Vertical	Pass
94.16	21.32	120.000	100.0	43.50	22.18	Vertical	Pass
140.80	22.73	120.000	100.0	43.50	20.77	Vertical	Pass
506.24	39.61	120.000	100.0	46.00	6.39	Vertical	Pass
541.24	37.00	120.000	100.0	46.00	9.00	Vertical	Pass



Radiation disturbances, antenna polarization: Setup3, Horizontal

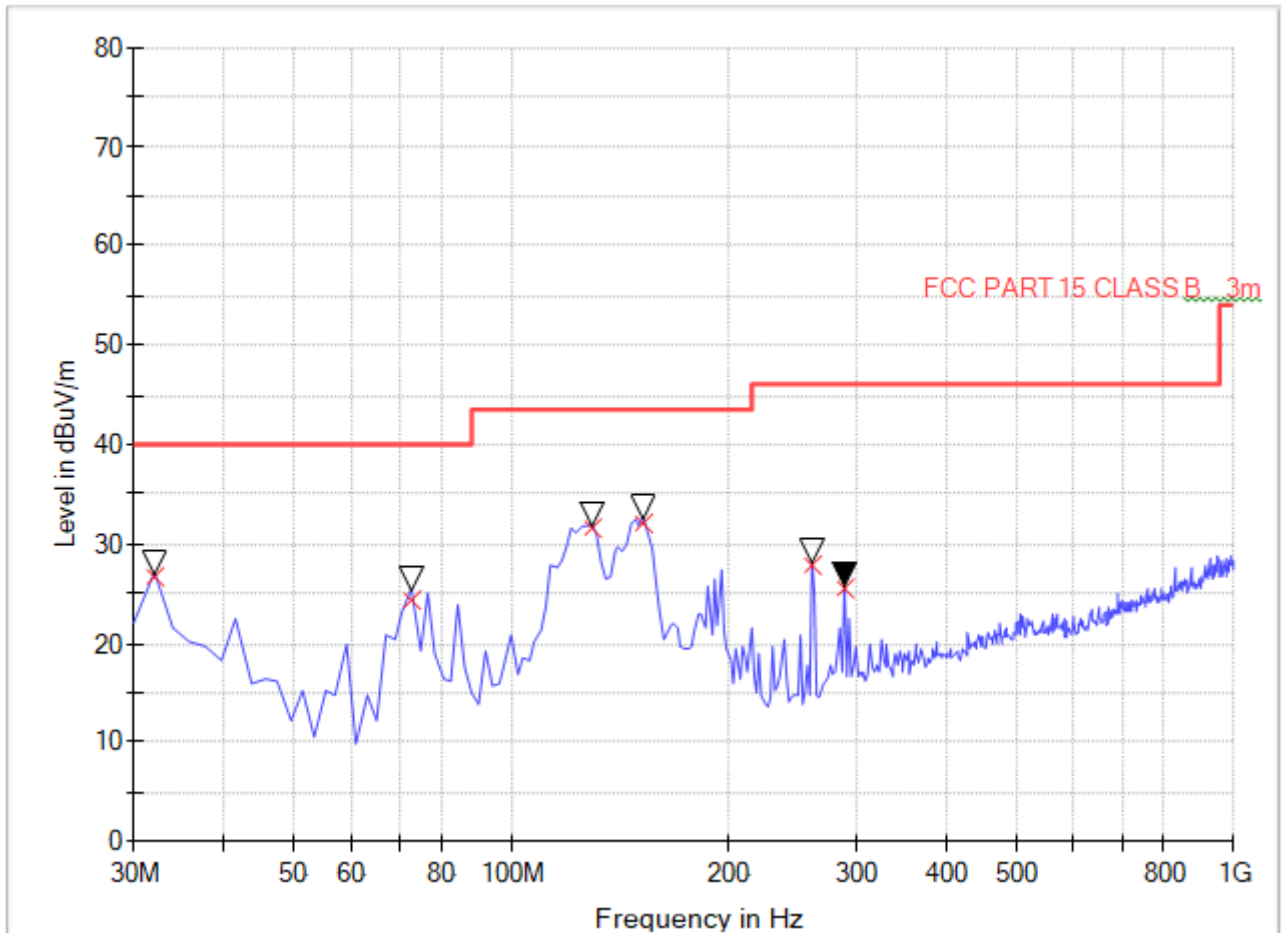

(Plot E: Test Antenna Horizontal30M - 1G)

Frequency (MHz)	Quasi Peak (dB μ V/m)	Bandwidth (kHz)	Antenna height (cm)	Limit (dB μ V/m)	Margin (dB)	Antenna	Verdict
31.96	26.76	120.000	100.0	40.00	13.24	Horizontal	Pass
72.76	24.32	120.000	100.0	40.00	15.68	Horizontal	Pass
129.12	31.55	120.000	100.0	43.50	11.95	Horizontal	Pass
152.48	32.09	120.000	100.0	43.50	11.41	Horizontal	Pass
261.32	27.90	120.000	100.0	46.00	18.10	Horizontal	Pass
288.52	25.52	120.000	100.0	46.00	20.48	Horizontal	Pass



Radiation disturbances, antenna polarization:Setup3, Vertical

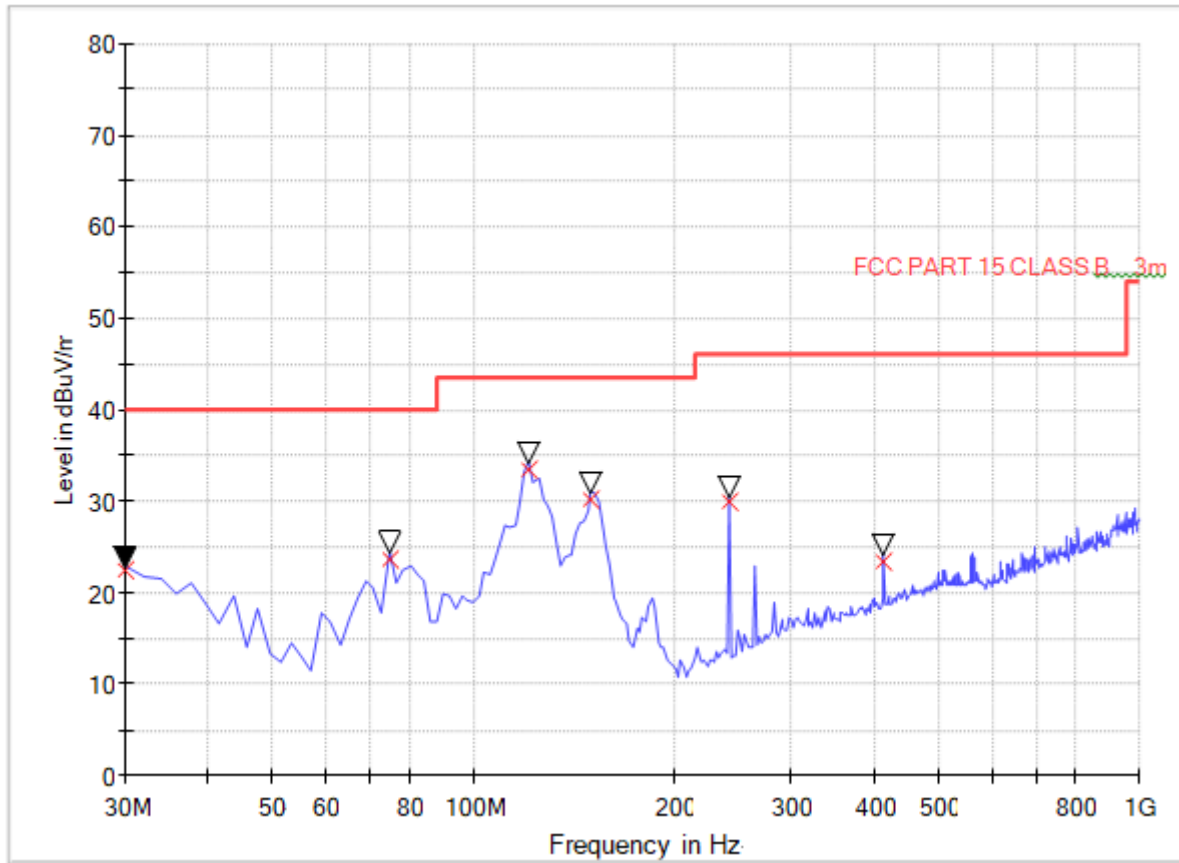

(Plot F: Test Antenna Vertical30M - 1G)

Frequency (MHz)	Quasi Peak (dB μ V/m)	Bandwidth (kHz)	Antenna height (cm)	Limit (dB μ V/m)	Margin (dB)	Antenna	Horizontal
30.00	22.55	120.000	100.0	40.00	17.45	Vertical	Pass
74.72	23.66	120.000	100.0	40.00	16.34	Vertical	Pass
121.36	33.46	120.000	100.0	43.50	10.04	Vertical	Pass
150.52	30.19	120.000	100.0	43.50	13.31	Vertical	Pass
241.88	29.89	120.000	100.0	46.00	16.11	Vertical	Pass
412.96	23.32	120.000	100.0	46.00	22.68	Vertical	Pass



Above 1GHz, Setup1

NO.	Freq. [MHz]	Level [dBμV/m]	Factor [dB]	Limit [dBμV/m]	Margin [dB]	Height [cm]	Angle [°]	Polarity
1	1888.47	51.37	-12.36	69.70	18.33	100	103	Horizontal
2	2381.60	50.61	-10.88	69.70	19.09	100	45	Horizontal
3	3503.88	53.03	-7.85	69.70	16.67	100	141	Horizontal
4	4745.19	58.73	-1.46	69.70	10.97	100	52	Horizontal
5	6989.75	60.45	2.10	69.70	9.25	100	164	Horizontal
6	11648.91	59.61	5.40	69.70	10.09	100	173	Horizontal

NO.	Freq. [MHz]	Level [dBμV/m]	Factor [dB]	Limit [dBμV/m]	Margin [dB]	Height [cm]	Angle [°]	Polarity
1	1782.20	55.44	-13.23	69.70	14.26	100	353	Vertical
2	2432.61	54.09	-10.75	69.70	15.61	100	54	Vertical
3	3423.11	56.31	-7.46	69.70	13.39	100	192	Vertical
4	4736.68	56.12	-1.47	69.70	13.58	100	321	Vertical
5	6959.99	61.00	2.31	69.70	8.70	100	344	Vertical
6	10165.29	60.29	4.94	69.70	9.41	100	233	Vertical

Above 1GHz Setup2,3(See Remark 3)

NO.	Freq. [MHz]	Level [dBμV/m]	Limit [dBμV/m]	Margin [dB]	Height [cm]	Angle [°]	Polarity
1	--	--	--	--	--	--	Vertical
2	--	--	--	--	--	--	Vertical
3	--	--	--	--	--	--	Vertical
4	--	--	--	--	--	--	Vertical
5	--	--	--	--	--	--	Vertical
6	--	--	--	--	--	--	Vertical

NO.	Freq. [MHz]	Level [dBμV/m]	Limit [dBμV/m]	Margin [dB]	Height [cm]	Angle [°]	Polarity
1	--	--	--	--	--	--	Horizontal
2	--	--	--	--	--	--	Horizontal
3	--	--	--	--	--	--	Horizontal
4	--	--	--	--	--	--	Horizontal
5	--	--	--	--	--	--	Horizontal
6	--	--	--	--	--	--	Horizontal



REMARKS:

1. Emission Level(dBuV/m) = Raw Value(dBuV) + Correction Factor(dB/m)
2. Correction Factor(dB/m) = Antenna Factor(dB/m) + Cable Factor(dB)
- Pre-Amplifier Factor(dB)
3. For Set up 2,3 mode, The EUT's internal highest frequency is less than 108MHz, so test frequency range is up to 1000MHz. Other frequency reading was too low against the official limit that not recorded.

APPENDIX I: PHOTOGRAPHS OF EMC TEST CONFIGURATION

1. Radiated Emission Measurement below 1GHz

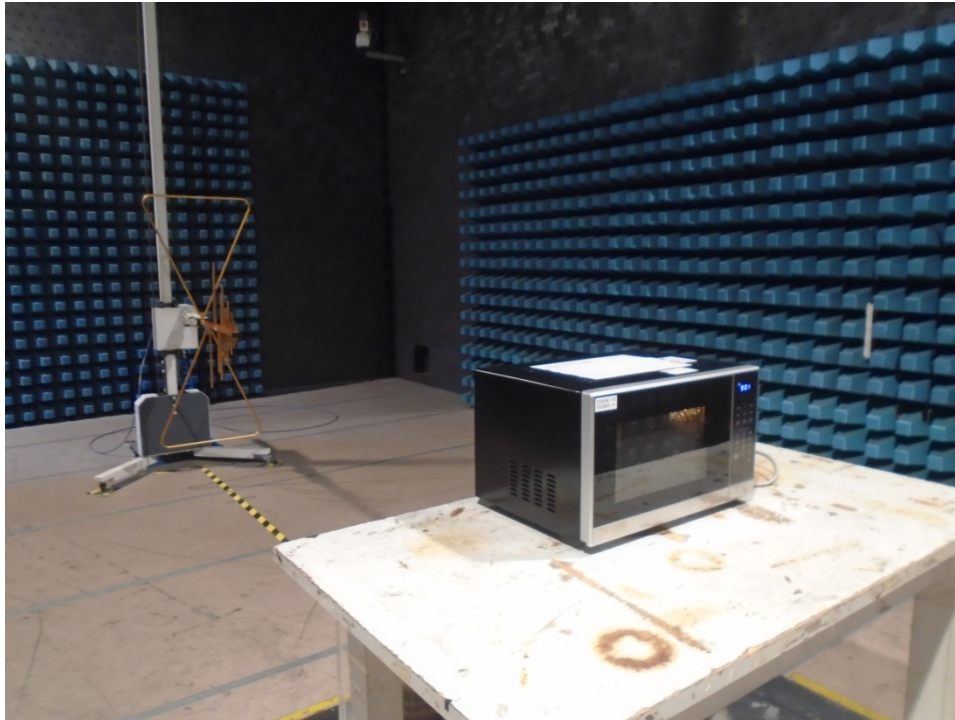

2. Radiated Emission Measurement above 1GHz

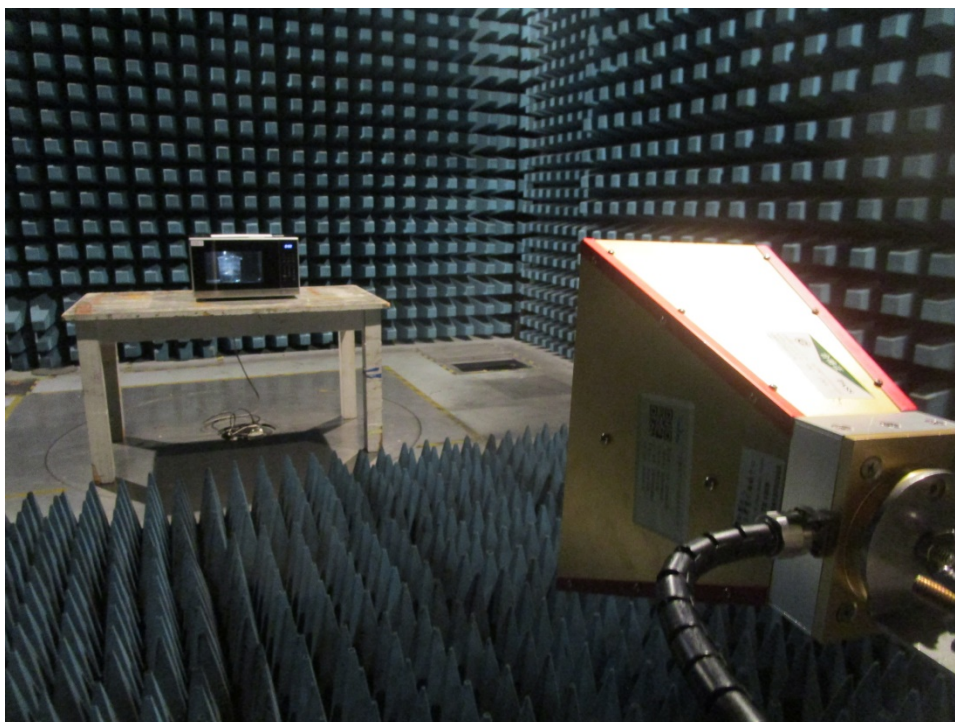

3. Conducted emission at AC mains input/output port Measurement

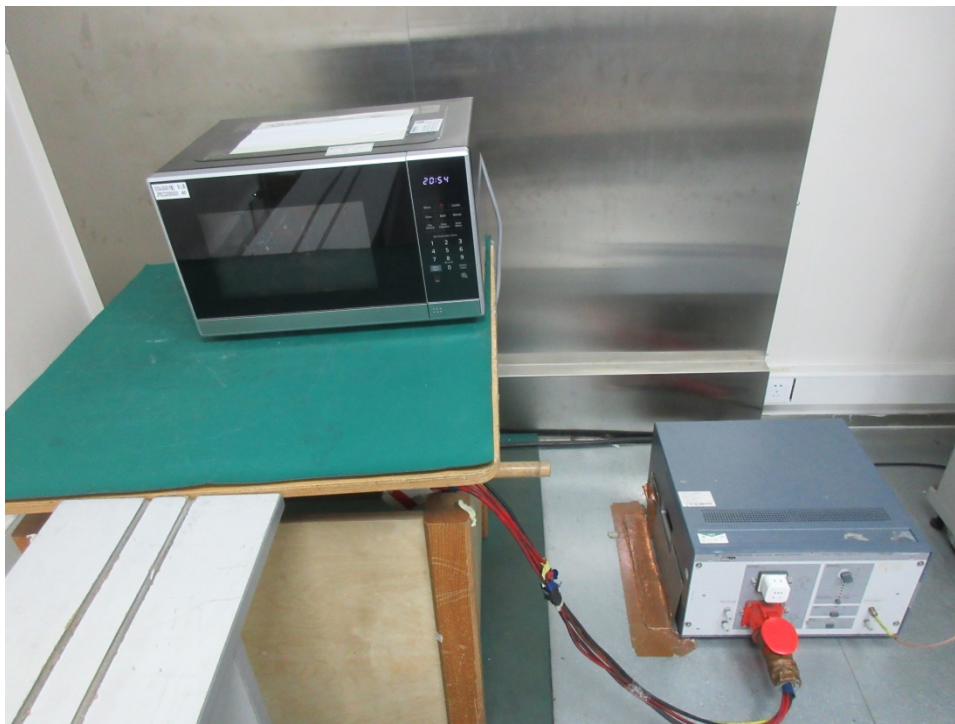

4. Radiation Hazard Test





APPENDIX II: PHOTOGRAPHS OF PRODUCT PHOTO

External Photo









Internal Photo

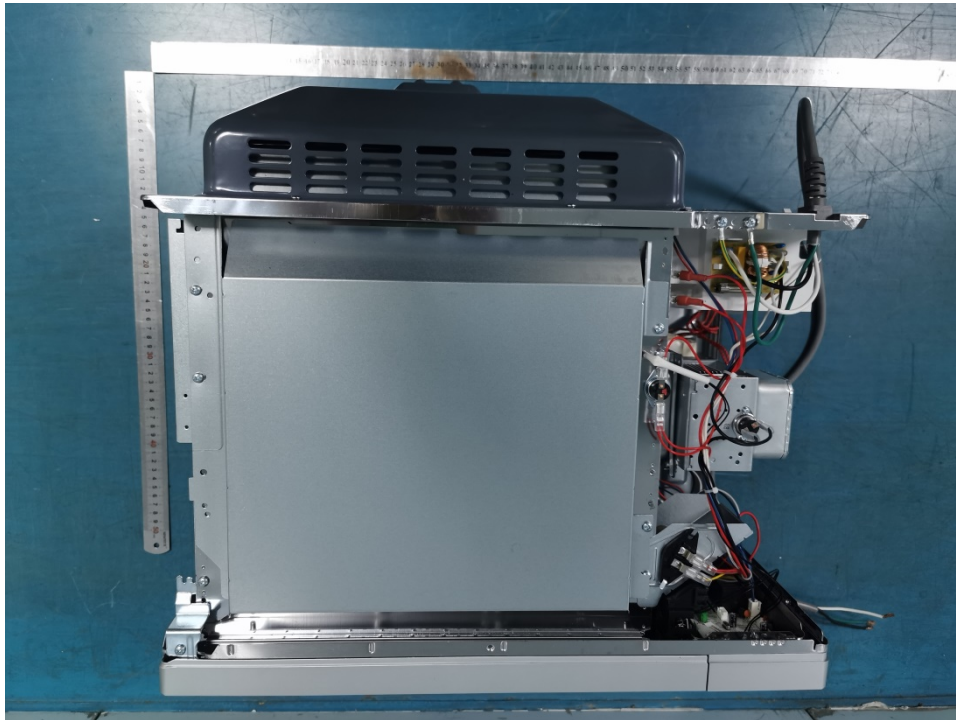

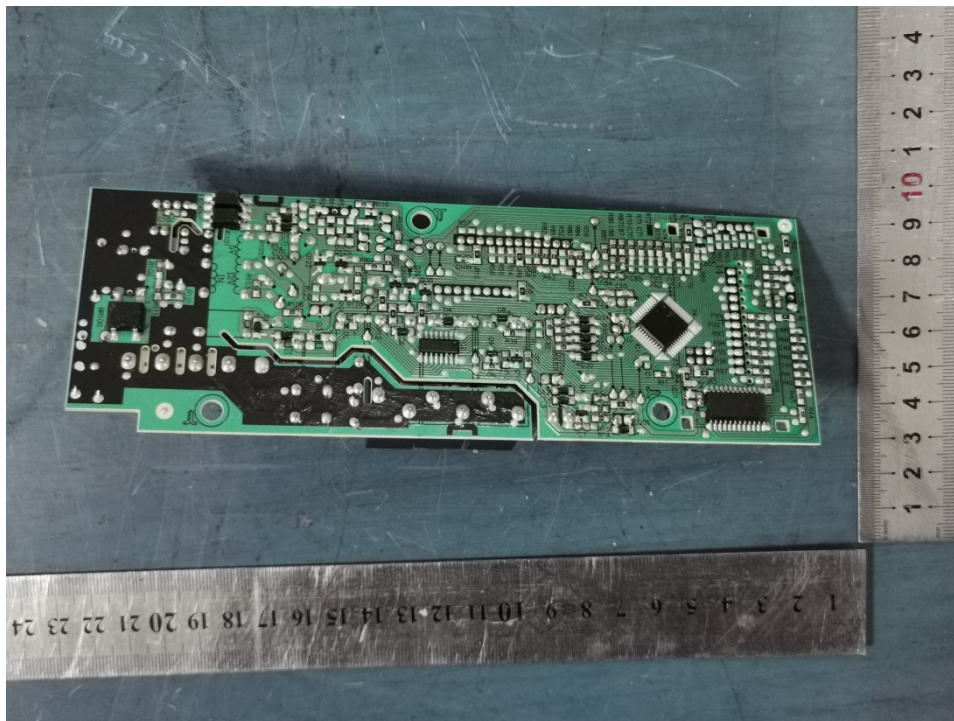
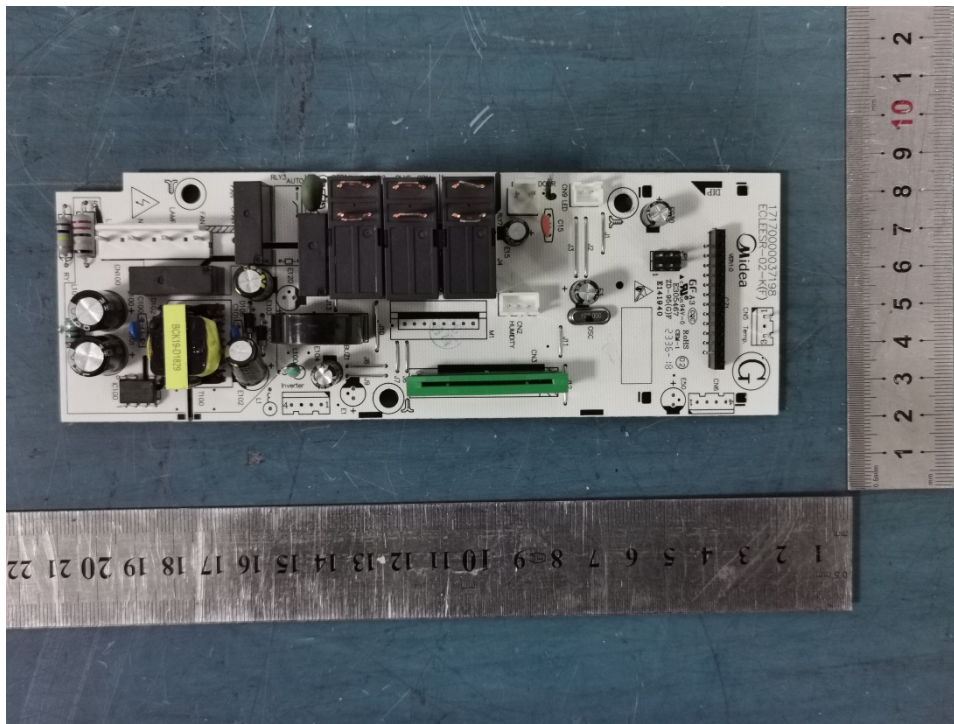

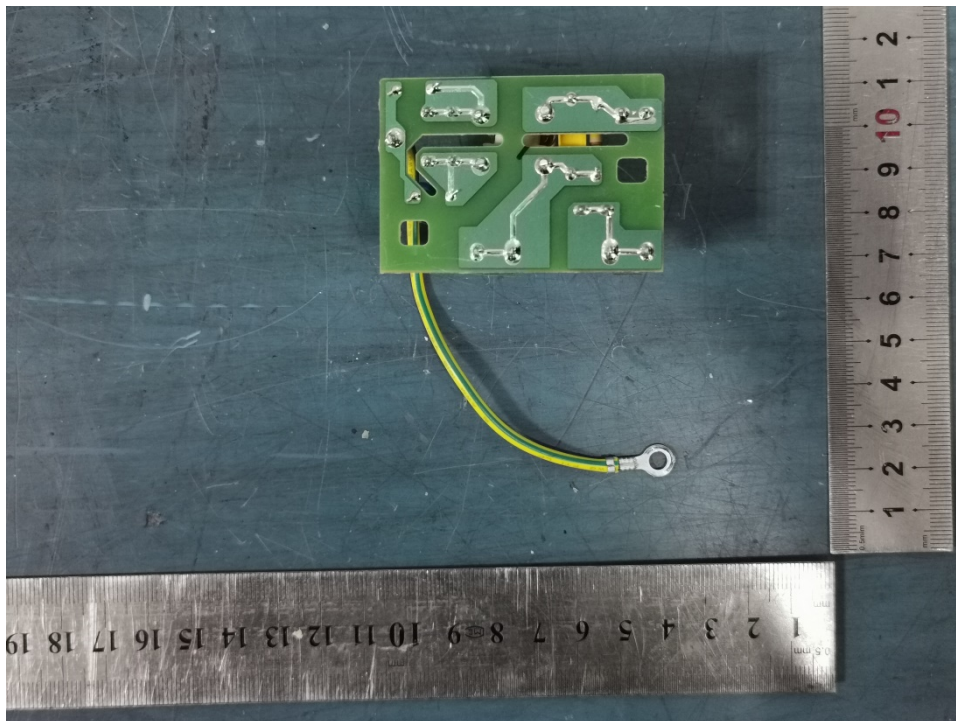
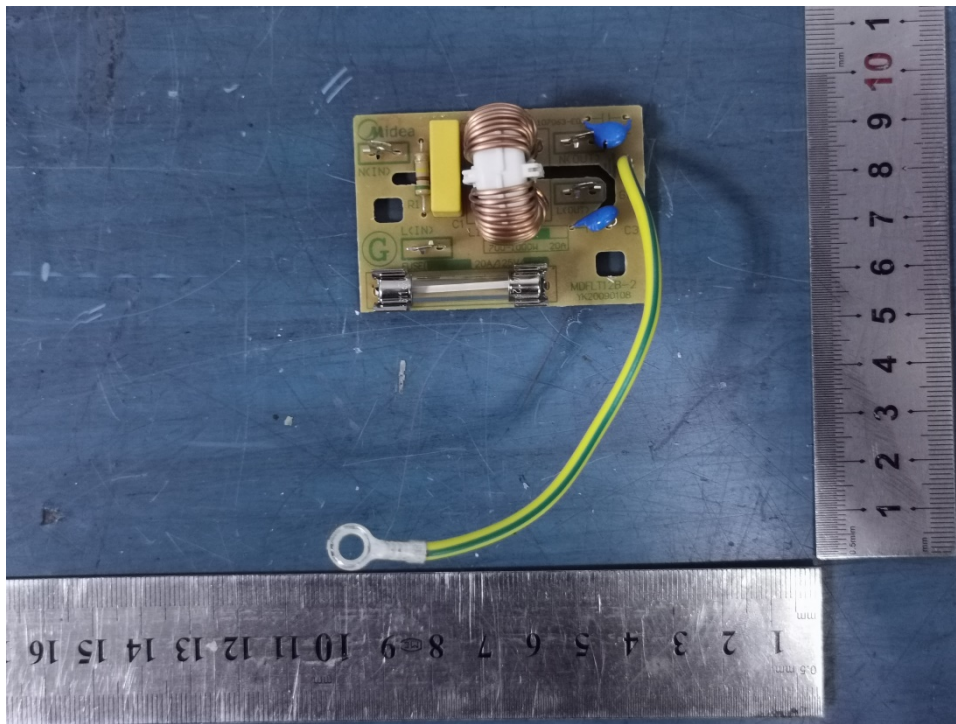

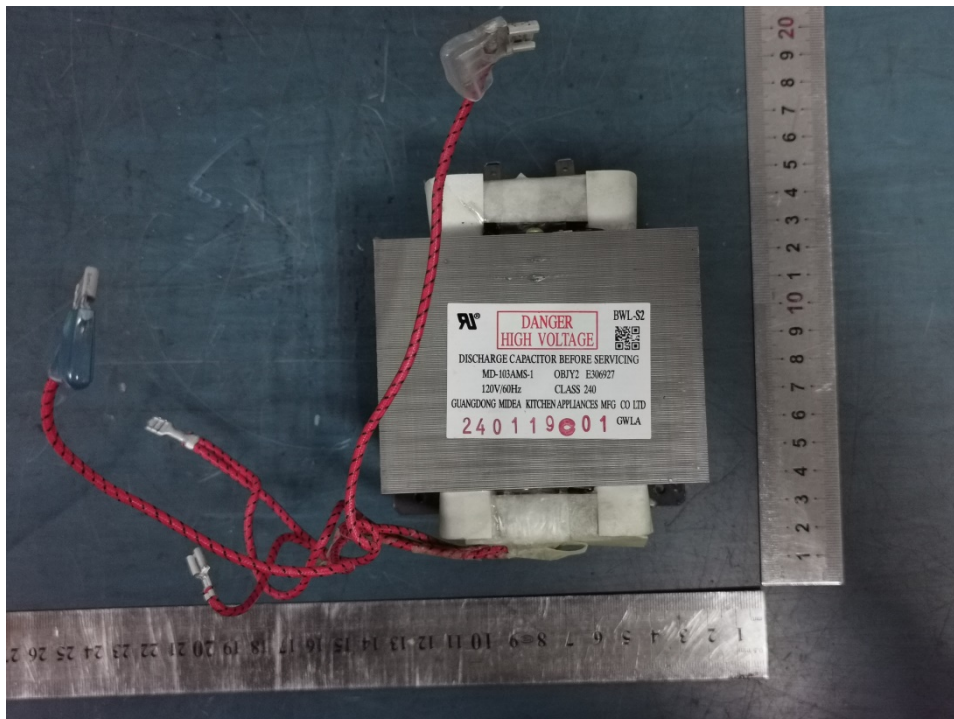

*** End of Report ***