

# TOSHIBA

## MICROWAVE OVEN INSTRUCTION MANUAL

TC034A2TX-SS

Please review this instruction manual before operating.

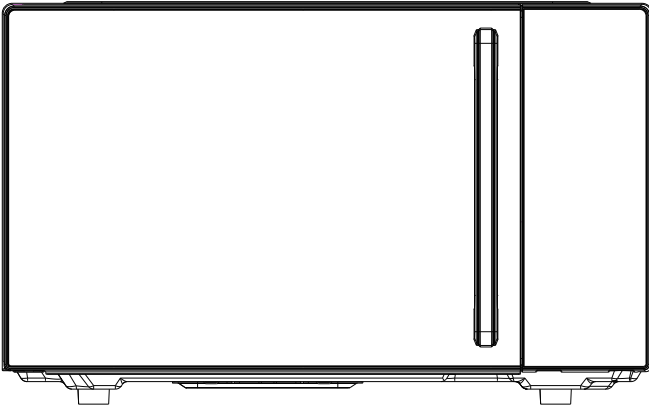

# CONTENTS

## PRODUCT SAFETY

Precautions to avoid possible exposure to excessive microwave energy .....	01
Important safety instructions .....	02
Grounding instructions .....	05
Radio interference .....	06
Utensils .....	06
Materials you can use in microwave oven .....	07
Materials can not be used in microwave oven .....	09

## PRODUCT SETTING

Setting up your oven .....	10
----------------------------	----

## INSTRUCTION FOR USE

Before using for the first time .....	13
Operation .....	14
1. Power levels .....	15
2. Clock setting .....	15
3. Kitchen timer .....	16
4. Microwave cook .....	17
5. Grill .....	17
6. Convection With Preheat .....	18
7. Convection Without Preheat .....	19
8. Combination .....	19
9. Weight Defrost .....	20
10. Time Defrost .....	21

11. Multi-stage cooking .....	21
12. Speed Cooking .....	22
13. Auto Menu .....	23
14. Airfry .....	24
15. Lock Function .....	25
16. ECO Function .....	26
17. Inquiring Function .....	26
18. Memory Function .....	26
19. Wifi Function .....	27

## MAINTENANCE

Trouble shooting .....	28
One year limited warranty .....	29



**NOTE**

BEFORE OPERATING THIS PRODUCT, READ, UNDERSTAND, AND FOLLOW THESE INSTRUCTIONS.

BE SURE TO SAVE THIS BOOKLIST FOR FUTURE REFERENCE.

The hardware and software after-sale service can be received from the authorized dealer. Software updates service will be available for 5 years from the manufacture via the OTA (Over-The-Air) download technology. Please contact the authorized dealer in your region for detailed information.

# PRODUCT SAFETY

## PRECAUTIONS TO AVOID POSSIBLE EXPOSURE TO EXCESSIVE MICROWAVE ENERGY

---

(a). Do not attempt to operate this oven with the door open since open door operation can result in harmful exposure to microwave energy.

It is important not to defeat or tamper with the safety interlocks.

(b). Do not place any object between the oven front face and the door or allow soil or cleaner residue to accumulate on sealing surfaces.

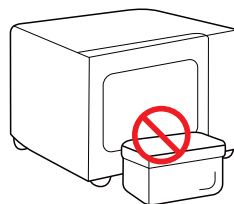

(c). Do not operate the oven if it is damaged. It is particularly important that the oven door closes properly and that there is no damage to the:

- (1). DOOR (bent)
- (2). HINGES AND LATCHES (broken or loosened)
- (3). DOOR SEALS AND SEALING SURFACES

(d). The oven should not be adjusted or repaired by anyone except properly qualified service personnel.

## SPECIFICATIONS

---

MODEL	TC034A2TX-SS
RATED VOLTAGE	120 V~ 60 Hz
MICROWAVE INPUT	1550W
MICROWAVE OUTPUT	1000W
GRILL	1100W
CONVECTION	1800W

# IMPORTANT SAFETY INSTRUCTIONS



When using electrical appliances basic safety precautions should be followed, including the following.

To reduce the risk of burns, electric shock, fire, injury to persons or exposure to excessive microwave energy.



Read all instructions before using the appliance.



Read and follow the specific: **"PRECAUTIONS TO AVOID POSSIBLE EXPOSURE TO EXCESSIVE MICROWAVE ENERGY"** found on page 1.



This appliance must be grounded. Connect only to properly grounded outlet. See "GROUNDING INSTRUCTIONS" found on page 5.



Install or locate this appliance only in accordance with the provided installation instructions.



As with any appliance, close supervision is necessary when used by children.



This appliance should be serviced only by qualified service personnel. Contact nearest authorized service facility for examination, repair, or adjustment.



When cleaning surfaces of door and oven that comes together on closing the door, use only mild, nonabrasive soaps, or detergent applied with a sponge or soft cloth.

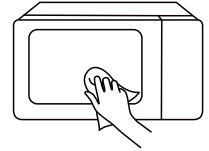

To reduce the risk of fire in the oven cavity:

1. Do not overcook food. Carefully attend appliance when paper, plastic, or other combustible materials are placed inside the oven to facilitate cooking.
2. Remove wire twist-ties from paper or plastic bag before placing bag in oven.
3. If material inside of the oven ignite, keep oven door closed, turn oven off, and disconnect the power cord, or shut off power at the fuse or circuit breaker panel.
4. Do not use the cavity for storage purposes. Do not leave paper products, cooking utensils, or food in the cavity when not in use.



Keep cord away from heated surface.

# IMPORTANT SAFETY INSTRUCTIONS



Liquids, such as water, coffee, or tea are able to overheat beyond the boiling point without appearing to be boiling. Visible bubbling or boiling when the container is removed from the microwave oven is not always present.

**THIS COULD RESULT IN VERY HOT LIQUID SUDDENLY BOILING**

**OVER WHEN THE CONTAINER IS DISTURBED OR A UTENSIL IS INSERTED INTO THE LIQUID.**

To reduce the risk of injury to persons:

1. Do not overheat the liquid.
2. Stir the liquid both before and halfway through heating it.
3. Do not use straight-sided containers with narrow necks.
4. After heating, allow the container to stand in the microwave oven for a short time before removing the container.
5. Use extreme care when inserting a spoon or other utensil into the container.

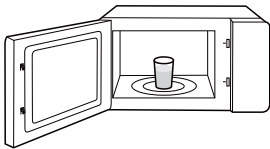

Oversized food or oversized metal utensils should not be inserted in a microwave/toaster oven as they may create a fire or risk of electric shock.

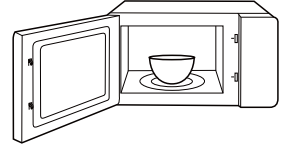

Some products such as whole eggs and sealed containers, for example, closed glass jars are able to explode and should not be heated in this oven.

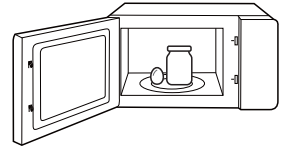

Do not store this appliance outdoors. Do not use this product near water - for example, near a kitchen sink, in a wet basement, near a swimming pool, or similar location.

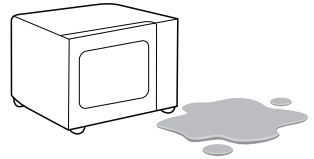

Do not immerse cord or plug in water or any other liquid.



# IMPORTANT SAFETY INSTRUCTIONS



Use this appliance only for its intended use as described in the manual.

Do not use corrosive chemicals or vapors in this appliance. This type of oven is specifically designed to heat, cook or dry food. It is not designed for industrial or laboratory use.

---



Do not operate this appliance if it has a damaged cord or plug, if it is not working properly, or if it has been damaged or dropped.

---



Do not cover or block any openings on the appliance.

---



Do not clean with metal scouring pads. Pieces can burn off the pad and touch electrical parts involving a risk of electric shock.



Do not let cord hang over edge of table or counter.

---



Do not use paper products when appliance is operated in the toaster mode.

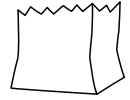

Do not store any materials, other than manufacturer's recommended accessories, in this oven when not in use.

---



Do not cover racks or any other part of the oven with metal foil. This will cause over-heating of the oven.

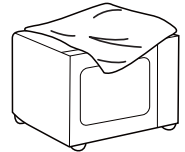

## SAVE THESE INSTRUCTIONS

## HOUSEHOLD USE ONLY (NOT FOR COMMERCIAL USE)

# GROUNDING INSTRUCTIONS

This appliance must be grounded. In the event of an electrical short circuit, grounding reduces the risk of electric shock by providing an escape wire for the electric current. This appliance is equipped with a cord having a grounding wire with a grounding plug. The plug must be plugged into an outlet that is properly installed and grounded.

**WARNING** - Improper use of the grounding can result in a risk of electric shock. Consult a qualified electrician or serviceman if the grounding instructions are not completely understood, or if doubt exists as to whether the appliance is properly grounded. If it is necessary to use an extension cord, use only a 3-wire extension cord that has a 3-blade grounded plug, and 3-slot receptacle that will accept the plug on the appliance. The marked rating of the extension cord shall be equal to or greater than the electrical rating of the appliance.



**DANGER**

**Electric Shock Hazard:**

Touching some of the internal components can cause serious personal injury or death. Do not disassemble this appliance.



**WARNING**

**Electric Shock Hazard:**

Improper use of the grounding can result in electric shock. Do not plug into an outlet until appliance is properly installed and grounded.

1. A short power-supply cord is provided to reduce the risks resulting from becoming entangled in or tripping over a longer cord.
2. Longer cord sets or extension cords are available and may be used if care is exercised in their use.
3. If a long cord or extension cord is used:
  - (1). The marked electrical rating of the cord set or extension cord should be at least as great as the electrical rating of the appliance.
  - (2). The extension cord must be a grounding-type 3-wire cord.
  - (3). The longer cord should be arranged so that it will not drape over the counter top or tabletop where it can be pulled on by children or tripped over unintentionally.



# RADIO INTERFERENCE

1. Operation of the microwave oven may cause interference to your radio, TV or similar equipment.
2. When there is interference, it may be reduced or eliminated by taking the following measures:
  - (1). Clean door and sealing surface of the oven.
  - (2). Reorient the receiving antenna of radio or television.
  - (3). Relocate the microwave oven with respect to the receiver.
  - (4). Move the microwave oven away from the receiver.
  - (5). Plug the microwave oven into a different outlet so that microwave oven and receiver are on different branch circuits.

**This device complies  
with part 18 of the FCC Rules.**

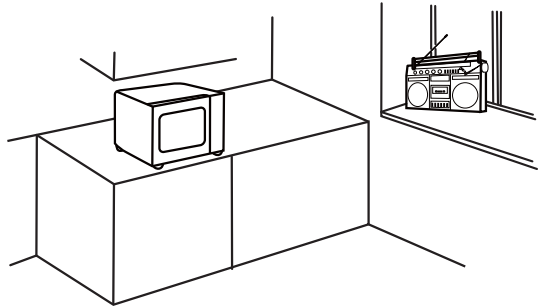

# UTENSILS



- Personal Injury Hazard:  
Tightly-closed utensils could explode. Closed containers should be opened and plastic pouches should be pierced before cooking. See the instructions on "Materials you can use in microwave oven or to be avoided in microwave oven."  
There may be certain non-metallic utensils that are not safe to use for microwaving. If in doubt, you can test the utensil in question following the procedure below.

## Utensil Test:

1. Fill a microwave-safe container with 1 cup of cold water (8.5 oz) along with the utensil in question.
2. Cook on maximum power for 1 min.
3. Carefully feel the utensil. If the empty utensil is warm, do not use it for microwave cooking.
4. Do not exceed 1 min cooking time.

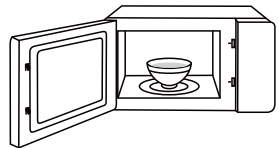



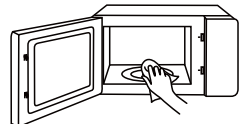





**KEEP THE CAVITY CLEAN**















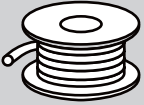

# MATERIALS YOU CAN USE IN MICROWAVE OVEN

UTENSILS	REMARKS
 Browning dish	Follow manufacturer's instructions. The bottom of browning dish must be at least 3/16 inch (5mm) above the turntable. Incorrect usage may cause the turntable to break. 
 Dinnerware	Microwave-safe only. Follow manufacturer's instructions. Do not use cracked or chipped dishes. 
 Glass jars	Always remove lid. Use only to heat food until just warm. Most glass jars are not heat resistant and may break. 
 Glassware	Heat-resistant oven glassware only. Make sure there is no metallic trim. Do not use cracked or chipped dishes. 
 Oven cooking bags	Follow manufacturer's instructions. Do not close with metal tie. Make slits to allow steam to escape. 
 Paper plates and cups	Use for short-term cooking/warming only. Do not leave oven unattended while cooking. 
 Paper towels	Use to cover food for reheating and absorbing fat. Use with supervision for a short-term cooking only. 
 Parchment paper	Use as a cover to prevent splattering or a wrap for steaming. 

# MATERIALS YOU CAN USE IN MICROWAVE OVEN

UTENSILS	REMARKS
 <p data-bbox="162 405 230 429">Plastic</p>	<p data-bbox="345 304 893 443">Microwave-safe only. Follow the manufacturer's instructions. Should be labeled "Microwave Safe". Some plastic containers soften, as the food inside gets hot. "Boiling bags" and tightly closed plastic bags should be slit, pierced or vented as directed by package.</p> 
 <p data-bbox="135 592 259 616">Plastic wrap</p>	<p data-bbox="342 523 915 576">Microwave-safe only. Use to cover food during cooking to retain moisture. Do not allow plastic wrap to touch food.</p> 
 <p data-bbox="122 761 273 785">Thermometers</p>	<p data-bbox="342 708 882 732">Microwave-safe only (meat and candy thermometers).</p> 
 <p data-bbox="144 920 251 944">Wax paper</p>	<p data-bbox="342 868 910 892">Use as a cover to prevent splattering and retain moisture.</p> 

# MATERIALS CAN NOT BE USED IN MICROWAVE OVEN

UTENSILS	REMARKS
 <p>Aluminum tray</p>	May cause arcing. Transfer food into microwave-safe dish. 
 <p>Food carton with metal handle</p>	May cause arcing. Transfer food into microwave-safe dish. 
 <p>Metal or metal trimmed utensils</p>	Metal shields the food from microwave energy. Metal trim may cause arcing. 
 <p>Metal twist ties</p>	May cause arcing and could cause a fire in the oven. 
 <p>Paper bags</p>	May cause a fire in the oven. 
 <p>Plastic foam</p>	Plastic foam may melt or contaminate the liquid inside when exposed to high temperature. 
 <p>Wood</p>	Wood will dry out when used in the microwave oven and may split or crack. 

## SETTING UP YOUR OVEN

### NAMES OF MICROWAVE OVEN PARTS AND ACCESSORIES

Remove the oven and all materials from the carton and oven cavity.

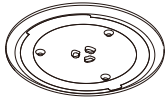

Glass turntable

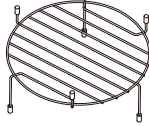

Grill Rack( Can not be used in microwave function and must be placed on the glass tray )

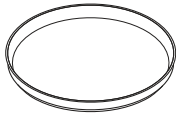

Bake Tray (Used for airfry, Microwave and grill)

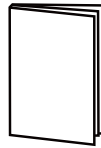

Instruction Manual

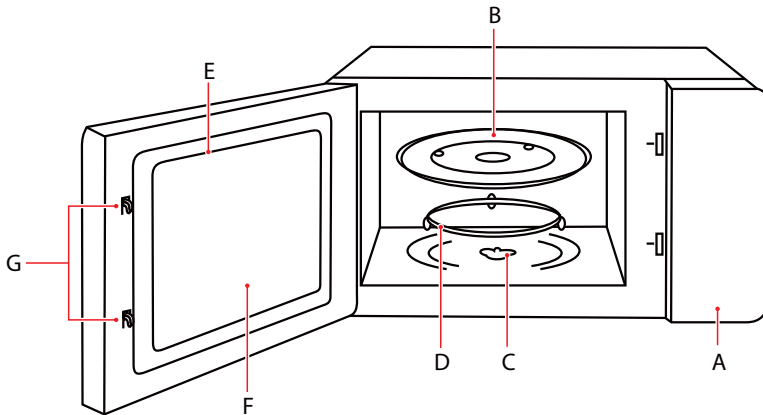

- A. Control panel
- B. Glass turntable
- C. Turntable shaft
- D. Turntable ring assembly

- E. Door assembly
- F. Observation window
- G. Safety interlock system

# SETTING UP YOUR OVEN

## TURNTABLE INSTALLATION

Cleaning the cooking compartment and putting the turntable in place.

For new installations, make sure all packaging and shipping tape has been removed from the turntable shaft.

Before using the appliance to prepare food for the first time, you will need to put the turntable in place correctly. You must clean the cooking compartment and accessories.

How to put the turntable in place:

1. Place the turntable ring assembly<sup>③</sup> into the recess in the cooking compartment.
2. Place the glass tray<sup>①</sup> on the turntable ring assembly<sup>③</sup>. Fit the raised, curved lines in the center of the glass tray bottom between the three spokes of the shaft. Make sure that the glass tray<sup>①</sup> engages in the turntable shaft<sup>②</sup> in the center of the cooking compartment floor. The rollers on the shaft should fit inside the turntable bottom ridge.

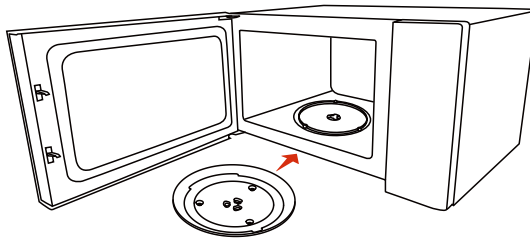
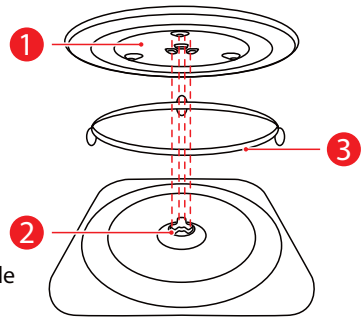

### NOTE

- Never use the appliance without the turntable. Make sure that it is properly engaged. The turntable can turn clockwise or anti-clockwise.
- Never place the glass tray upside down. The glass tray should never be restricted.
- Both glass tray and turntable ring assembly must always be used during cooking.
- All food and containers of food are always placed on the glass tray for cooking.
- Never restrict the movement of the turntable.
- If glass tray or turntable ring assembly cracks or breaks, contact your nearest authorized service center.

## COUNTERTOP INSTALLATION

Remove all packing material and accessories. Examine the oven for any damage such as dents or broken door. Do not install if oven is damaged.

Cabinet: Remove any protective film found on the microwave oven cabinet surface. Do not remove the light brown Mica cover that is attached to the oven cavity to protect the magnetron.

## INSTALLATION

1. Select a level surface that provide enough open space for the intake and/or outlet vents. A minimum clearance of 3.0 inches (7.5cm) is required between the oven and any adjacent walls. One side must be open.  
The minimum installation height is 3.0ft(91.6cm).
  - a. Leave a minimum clearance of 12 inches (30cm) above the oven.
  - b. Do not remove the legs from the bottom of the oven.
  - c. Blocking the intake and/or outlet openings can damage the oven.
  - d. Place the oven as far away from radios and TV as possible.Operation of microwave oven may cause interference to your radio or TV reception.

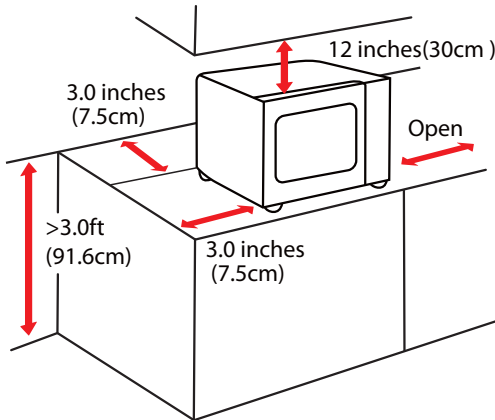

2. Plug microwave oven into a standard household outlet. Be sure the voltage and the frequency is the same as the voltage and the frequency on the rating label.



**NOTE**

- Do not install oven over a range cooktop or other heat-producing appliance. If installed near or over a heat source, the oven could be damaged and the warranty would be void.

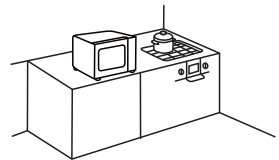

The accessible surface may be hot during operation

# INSTRUCTION FOR USE

## BEFORE USING FOR THE FIRST TIME

**It is normal that the stove may produce unpleasant odors when it is used for the first time.**

This section tells you what you need to do before using your microwave to prepare food for the first time. Read the section entitled "**SAFETY INFORMATION**" beforehand.

**"IMPORTANT SAFETY INFORMATION" on page 2.**

Before you can use your new appliance, you will need to put the turntable in place correctly. You must also clean the cooking compartment and accessories.

### **Cleaning the cooking compartment and putting the turntable in place**

Before using the appliance to prepare food for the first time, you must clean the cooking compartment and accessories.



**NOTE**

- Never use the appliance without the turntable.
- Make sure that it is properly engaged. The turntable can turn clockwise or anti-clockwise.



# OPERATION

## CONTROL PANEL AND FEATURES

---

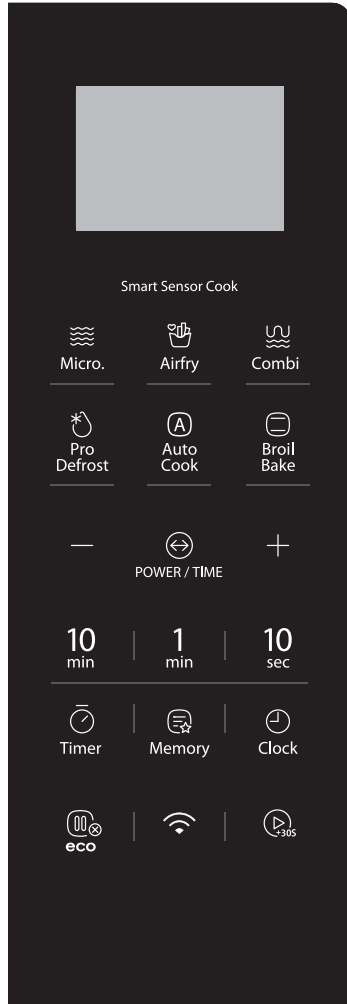

## 1. POWER LEVELS

Ten power levels are available.

LEVEL	POWER	DISPLAY
1	100%	P100
2	80%	P80
3	50%	P50
4	30%	P30
5	10%	P10

## 2. CLOCK SETTING

When the microwave oven is plugged into an outlet, "0:00" will display.

a Press Clock once.



b Press "+" or "-" to set the hour figures. it should be within 0~23.

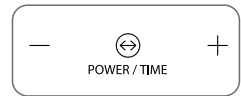

c Press  to confirm. the minute figures will flash.



d Press "+" or "-" to set the minute figures. it should be within 0~59.



e Press  to confirm.



### 3. KITCHEN TIMER

---

When the microwave oven is plugged into an outlet, "0:00" will display.

a Press Timer once.



b Press "+", "-", or "10min/1min/10s" to set the cook time. The maximum time is 95:00.



c Press  to start counting down.



•The kitchen timer is simply a timer, there are not any other programs during it.

### 4. MICROWAVE COOK

---

a Press Micro. more time to choose the power level.



or Press Micro. once, and then press "+", or "-" to set the power level.

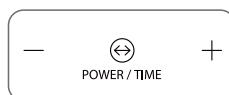

- b Press POWER/TIME once, and then press "+", "-", or "10min/1min/10s" to set the cook time . the maximum time is 95:00.



- c Press  to start cooking.



**NOTE**

- Press  to increase the cook time by 30 seconds during cooking.

## 5. GRILL

---

- a Press Broil/Bake once, "G-1" will display.



- b Press  to confirm.



- c Press POWER/TIME once, and then press "+", "-", or "10min/1min/10s" to set the cook time . the maximum time is 95:00.



- d Press  to start cooking.



**NOTE**

- When half of the time has passed, the buzzer will sound to remind you to turn the food over. If no operation, the oven will continue working.

## 6. Convection with preheat

---

a Press Broil/Bake twice, "100°F" will display.



b Press "+" or "-" to set the temperature, "100°F, 150°F.....425°F" are available.



c Press  to confirm.



d Press  to start preheating.

When the temperature has arrived, please open and then close the door to cancel preheat.



e Press "+", "-", or "10min/1min/10s" to set the cook time. The maximum time is 95:00.

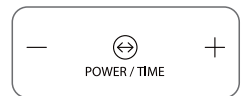

f Press  to start cooking.



## 7. Convection without preheat

---

a Press Broil/Bake twice, "100°F" will display.



- b Press "+" or "-" to set the temperature, "100°F,150°F.....425°F"are available.



- c Press  to confirm.



- d Press "+" or "-"to set the cook time . the maximum time is 95:00.



- e Press  to start cooking.



**NOTE**

- Press "10min", "1min", "10sec" to increase the corresponding cook time during setting or pause state.

## 8. COMBINATION

---

- a Press  more time to choose the mode.



- c Press "+", "-" or "10min/1min/10s"to set the cook time . the maximum time is 95:00.

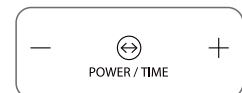

d Press  to start cooking.



## 9. WEIGHT DEFROST

---

a Press Pro Defrost once, "dEF1" will display.



b Press "+" or "-" to set the defrost weight, it should be within 4~70Oz.

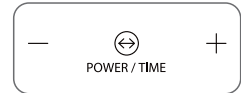

c Press  to start defrosting.



- The buzzer will sound twice to remind you of turning over the food during defrosting.

## 10. TIME DEFROST

---

a Press Pro Defrost twice, "dEF2" will display.



b Press "+", "-", or "10min/1min/10s" to set the cook time . the maximum time is 95:00.

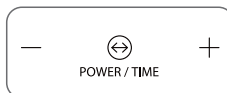

c Press  to start defrosting.



**NOTE**

- The buzzer will sound to remain you of turning over the food when half of the time has passed.
- The default power level is P30,it can not be changed.

## 11. MULTI-SATGE COOKING

---

a Press Pro Defrost twice, "dEF2" will display.



b Press "+", "-", or "10min/1min/10s" to set the cook time . the maximum time is 95:00.



c Press Broil/Bake once, "G-1" will display.





- d Press “+”, “-” or “10min/1min/10s” to set the cook time . the maximum time is 95:00.



- e Press  to start cooking.



**NOTE**

- Two cooking stages can be set in multi-stage cooking.
- If you set defrost function, it will work automatically in the first stage.
- Kitchen Timer, Auto menu, Speed cooking and Preheat cannot be set as one of the multi-stage.

## 12. SPEED COOKING

- a Press “+” or “-” to set the cook time for 95 minutes with P100 power level directly.



- b Press  to start cooking.



Or

- c Press  to start cooking with P100 power level for 30 seconds directly.



## 13. AUTO MENU

Press Auto Cook more time to choose the menu.

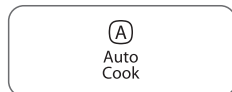

**a** or

Press Auto Cook once, and then press "+" or "-" to choose the menu.



**b** Press  to confirm.



**c** Press "+" or "-" to set the weight.



**d** Press  to start cooking.



## MENU CHART

MENU	DISPLAY	WEIGHT/ PORTION	POWER LEVEL
A01 PIZZA	8.00 Oz 14.00 Oz	8.00 Oz 14.00 Oz	400°F
A02 POTATO	1 (about 8Oz) 2 3	1 2 3	P100
A03 MEAT	8.00 Oz 12.00 Oz 16.00 Oz	8.00 Oz 12.00 Oz 16.00 Oz	P80
A04 FISH	8.00 Oz 12.00 Oz 16.00 Oz	8.00 Oz 12.00 Oz 16.00 Oz	P80

MENU	DISPLAY	WEIGHT/ PORTION	POWER LEVEL
A05 VEGETABLE	4.00 Oz	4.00 Oz	P100
	8.00 Oz	8.00 Oz	
	16.00 Oz	16.00 Oz	
A06 BEVERAGE	1 Cup(120ml)	1	P100
	2 Cups	2	
	3 Cups	3	
A07 PASTA	1.75 Oz(with cold water15.8Oz)	1.75 Oz	P80
	3.5 Oz(with cold water28.2Oz)	3.5 Oz	
A08 POPCORN	3.0 Oz	3.0 Oz	P100
	3.5 Oz	3.5 Oz	
A09 CHIFFON CAKE	16.00 Oz	16.00 Oz	325°F(with preheat)
A10 CHICKEN	16.00 OZ	16.00 OZ	P100+CONV,400°F
	24.00 OZ	24.00 OZ	
	32.00 OZ	32.00 OZ	
	40.00 OZ	40.00 OZ	
	48.00 OZ	48.00 OZ	

## 14. Air Fry

**a** Press Airfry once, "H01" will display.



**b** Press Airfry repeatedly or "+" , "-" to choose the menu



**c** Press  to start cooking.



## MENU CHART

MENU	DISPLAY	WEIGHT/ PORTION	POWER LEVEL
Frozen French Fries	H01	11 Oz	425°F(without preheat)
Frozen croquettes	H02	14 Oz	425°F(without preheat)
Frozen Squid	H03	10 Oz	425°F(without preheat)
Frozen Onion rings	H04	10 Oz	425°F(without preheat)
Frozen chicken nuggets	H05	12 Oz	425°F(without preheat)
Frozen Escalope	H06	14 Oz	425°F(without preheat)
Frozen Shrimps	H07	9 Oz	425°F(without preheat)
Vegetable	H08	11 Oz	425°F(without preheat)
Fresh Chicken wings	H09	18 Oz	425°F(without preheat)

## 15. LOCK FUNCTION

- a To lock the microwave so that it cannot be operated by children or other unintended users, press  pad for 3 seconds, the locked icon will display.



- b To unlock, press  pad for 3 seconds.

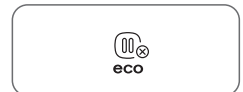

## 16. ECO FUNCTION

---

- a To enter ECO mode:  
In waiting state, press  once, the screen will turn off



- b To cancel ECO mode:  
In ECO mode, press any keys to cancel it.



## 17. INQUIRING FUNCTION

---

- a When oven is cooking or in paused mode, press Clock, the current time will appear for three seconds in the display.



## 18. MEMORY FUNCTION

---

Press "Memory" repeatedly to choose the procedure you have set, and then press  to start cooking directly, set the memorize procedure as follow steps:

- a Press "Memory" repeatedly to select memory 1-3 procedure.  
"1", "2" and "3" will display in order.



- b Press "Microwave" repeatedly to set the power level.



- c Press "+", "-", "10min/1min/10s" to set the cook time. the maximum time is 95:00.

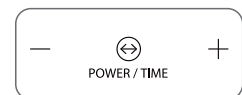

e Press  to save the current setting.





**NOTE**

- "Defrost" and "Auto Cook" cannot be set in memory function.
- If the power is not cut off, the procedure will be saved all the time.

## 19. WIFI CONNECTION

---

**a** Connect the network

Press and hold "  " for 3 seconds, till a beep sounds,"AP" and flashing "  " show on display.if it fails,"N0" will display,and the oven will return to standby after 30 seconds.



**b** Disconnect from the network

Press and hold "  " for 8 seconds, till a beep sounds,"-" flashes for few seconds, if the link has been removed successfully , the screen will display "8888" and then return to standby after 3 seconds.if it fails,"FFFF" will display,and the oven will return to standby after 3 seconds.



# CLEANING

With good care and cleaning, your appliance will retain its appearance and remain fully functioning for a long time to come. We will explain here how you should correctly care for and clean your appliance.



- Scratched glass in the appliance door may develop into a crack. Do not use a glass scraper, sharp or abrasive cleaning aids or detergents.
- The surface of the appliance may become damaged if it is not cleaned properly. Microwave energy may escape. Clean the appliance on a regular basis, and remove any food remnants immediately.
- Do not immerse the appliance in water or clean under a jet of water.

## Cleaning agent

To ensure that the different surfaces are not damaged by using the wrong cleaning agent, observe the information in the table. Wash new sponge cloths thoroughly before use.

### Do not use:



Harsh or abrasive cleaning agents



Metal or glass scrapers to clean the door panels

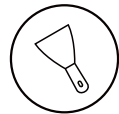

Metal or glass scrapers to clean the door seal



Hard scouring pads or sponges



Cleaning agents with a high alcohol content

## APPLIANCE FRONT

### Hot soapy water:

Clean using a dish cloth and then dry with a soft cloth. Do not use metal or glass scrapers for cleaning.

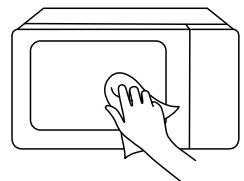

## APPLIANCE FRONT WITH STAINLESS STEEL

---

### Hot soapy water:

Clean using a dish cloth and then dry with a soft cloth. Remove splashes and patches of limescale, grease, starch and albumin immediately. Corrosion can form under these patches or splashes. Do not use glass cleaners or metal or glass scrapers for cleaning.

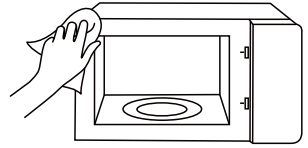

## COOKING COMPARTMENT MADE OF STAINLESS STEEL

---

### Hot soapy water or vinegar solution:

Clean using a dish cloth and then dry with a soft cloth. Do not use oven spray or any other aggressive oven cleaners or abrasive materials. Scouring pads, rough sponges and pan cleaners are also unsuitable. These items scratch the surface. Allow the interior surfaces to dry completely.

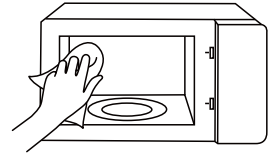

## RECESS IN THE COOKING COMPARTMENT

---

### Damp cloth:

Water must not be allowed to run into the appliance through the turntable drive. Dry the turntable drive with a cloth.

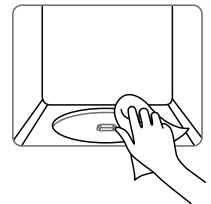

## TURNTABLE AND ROLLER RING

---

### Hot soapy water:

When placing the turntable back into its recess, it must engage properly.



## DOOR PANELS

---

### Glass cleaner:

Clean with a dish cloth. Do not use glass scrapers.



# MAINTENANCE

## TROUBLE SHOOTING

Check your problem by using the chart below and try the solutions for each problem.

If the microwave oven still does not work properly, contact the nearest authorized service center.

TROUBLE	POSSIBLE CAUSE	POSSIBLE REMEDY
Oven will not start	<ul style="list-style-type: none"><li>a. Electrical cord for oven is not plugged in.</li><li>b. Door is open.</li><li>c. Wrong operation is set.</li></ul>	<ul style="list-style-type: none"><li>a. Plug into the outlet.</li><li>b. Close the door and try again.</li><li>c. Check instructions</li></ul>
Arcing or sparking	<ul style="list-style-type: none"><li>a. Materials to be avoided in microwave oven were used.</li><li>b. The oven is operated when empty.</li><li>c. Spilled food remains in the cavity.</li></ul>	<ul style="list-style-type: none"><li>a. Use microwave-safe cookware only.</li><li>b. Do not operate with oven empty.</li><li>c. Clean cavity with wet towel.</li></ul>
Unevenly cooked foods	<ul style="list-style-type: none"><li>a. Materials to be avoided in microwave oven were used.</li><li>b. Food is not defrosted completely.</li><li>c. Cooking time, power level is not suitable.</li><li>d. Food is not turned or stirred.</li></ul>	<ul style="list-style-type: none"><li>a. Use microwave-safe cookware only.</li><li>b. Completely defrost food.</li><li>c. Use correct cooking time, power level.</li><li>d. Turn or stir food.</li></ul>
Overcooked foods	Cooking time, power level is not suitable.	Use correct cooking time, power level.
Undercooked foods	<ul style="list-style-type: none"><li>a. Materials to be avoided in microwave oven were used.</li><li>b. Food is not defrosted completely.</li><li>c. Oven ventilation ports are restricted.</li><li>d. Cooking time, power level is not suitable.</li></ul>	<ul style="list-style-type: none"><li>a. Use microwave-safe cookware only.</li><li>b. Completely defrost food.</li><li>c. Check to see that oven ventilation ports are not restricted.</li><li>d. Use correct cooking time, power level</li></ul>
Improper defrosting	<ul style="list-style-type: none"><li>a. Materials to be avoided in microwave oven were used.</li><li>b. Cooking time, power level is not suitable.</li><li>c. Food is not turned or stirred.</li></ul>	<ul style="list-style-type: none"><li>a. Use microwave-safe cookware only.</li><li>b. Use correct cooking time, power level.</li><li>c. Turn or stir food.</li></ul>

# ONE YEAR LIMITED WARRANTY

This product carries a warranty stating that it will be free from defects in material and workmanship for a period of one year from the date of purchase. This warranty is valid for the original retail purchaser from the date of initial retail purchase and is not transferable. Keep your original sales receipt.

## IMPORTANT:

1. This warranty does not cover damages resulting from accident, misuse or abuse, lack of reasonable care, the affixing of any attachments not provided with the product, loss of parts, or subjecting the appliance to any but the specified voltage. ( Read directions carefully. )
2. This warranty is void if this product is ever used for other than private household purposes.
3. This warranty is void if this product is ever used outside of United State.

If service is required during the warranty period, properly pack your unit. We recommend using the original carton and packing materials.

If additional assistance is needed, please contact customer assistance at:

customer@us.toshiba-lifestyle.com

855-204-5313

**Midea America Corp.** expressly disclaims all responsibility for consequential damages or incidental losses caused by use of the appliance. Some states do not allow this exclusion or limitation of incidental or consequential losses so the foregoing disclaimer may not apply to you. This warranty gives you specific legal rights, and you may also have other rights which may vary from state to state.

The serial number can be found on the back cabinet. We suggest that you record the serial number of your unit in the space below for future reference

Model Number : \_\_\_\_\_

Serial Number : \_\_\_\_\_

Product registration is not mandatory. Failure to complete and return the card or form does not diminish the consumer's warranty rights.

## SAVE THIS FOR YOUR RECORDS

Made in China

**#DetailsMatter**

Customercare@us.toshiba-lifestyle.com  
855-204-5313