

TOSHIBA

MICROWAVE OVEN INSTRUCTION MANUAL

Please review this instruction manual before operating.

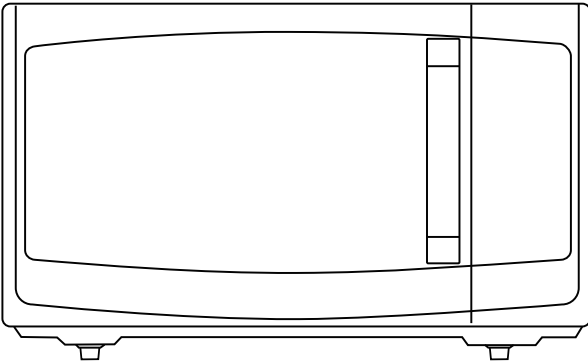

CONTENTS

PRODUCT SAFETY

Precautions to avoid possible exposure to excessive microwave energy	01
Important safety instructions	02
Grounding instructions	05
Radio interference	06
Utensils	06
Materials you can use in microwave oven	07
Materials can not be used in microwave oven	09

PRODUCT SETTING

Setting up your oven	10
----------------------------	----

INSTRUCTION FOR USE

Before using for the first time	13
Operation	14
1. Power Levels	15
2. Clock Setting	15
3. Kitchen Timer	16
4. Microwave Cook	16
5. Weight Defrost	17
6. Time Defrost	17
7. Multi-stage Cooking	18
8. Memory Function	19
9. Speed Cooking	20
10. Silent Mode	21
11. Lock Function	21
12. Eco Function	21

13. Inquiring Function	22
14. Wifi Function	22
15. Special Auto Menu	23
16. Auto Menu	24

MAINTENANCE

Trouble Shooting	27
One Year Limited Warranty	28



NOTE

BEFORE OPERATING THIS PRODUCT, READ, UNDERSTAND, AND FOLLOW THESE INSTRUCTIONS.

BE SURE TO SAVE THIS BOOKLIST FOR FUTURE REFERENCE.

The hardware and software after-sale service can be received from the authorized dealer. Software updates service will be available for 5 years from the manufacture via the OTA (Over-The-Air) download technology. Please contact the authorized dealer in your region for detailed information.

PRODUCT SAFETY

PRECAUTIONS TO AVOID POSSIBLE EXPOSURE TO EXCESSIVE MICROWAVE ENERGY

(a). Do not attempt to operate this oven with the door open since open door operation can result in harmful exposure to microwave energy.
It is important not to defeat or tamper with the safety interlocks.

(b). Do not place any object between the oven front face and the door or allow soil or cleaner residue to accumulate on sealing surfaces.

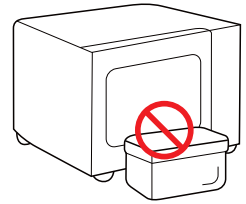

(c). Do not operate the oven if it is damaged. It is particularly important that the oven door closes properly and that there is no damage to the:
(1). DOOR (bent)
(2). HINGES AND LATCHES (broken or loosened)
(3). DOOR SEALS AND SEALING SURFACES

(d). The oven should not be adjusted or repaired by anyone except properly qualified service personnel.

SPECIFICATIONS

MODEL	EM925A2EA-PS0A
RATED VOLTAGE	120 V~ 60 Hz
MICROWAVE INPUT	1350 W
MICROWAVE OUTPUT	900 W

IMPORTANT SAFETY INSTRUCTIONS



When using electrical appliances basic safety precautions should be followed, including the following.

To reduce the risk of burns, electric shock, fire, injury to persons or exposure to excessive microwave energy.



Read all instructions before using the appliance.



Read and follow the specific: **"PRECAUTIONS TO AVOID POSSIBLE EXPOSURE TO EXCESSIVE MICROWAVE ENERGY"** found on page 1.



This appliance must be grounded. Connect only to properly grounded outlet. See "GROUNDING INSTRUCTIONS" found on page 5.



Install or locate this appliance only in accordance with the provided installation instructions.



As with any appliance, close supervision is necessary when used by children.



This appliance should be serviced only by qualified service personnel. Contact nearest authorized service facility for examination, repair, or adjustment.



When cleaning surfaces of door and oven that comes together on closing the door, use only mild, nonabrasive soaps, or detergent applied with a sponge or soft cloth.

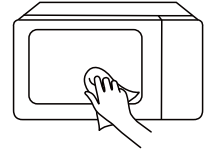

To reduce the risk of fire in the oven cavity:

1. Do not overcook food. Carefully attend appliance when paper, plastic, or other combustible materials are placed inside the oven to facilitate cooking.
2. Remove wire twist-ties from paper or plastic bag before placing bag in oven.
3. If material inside of the oven ignite, keep oven door closed, turn oven off, and disconnect the power cord, or shut off power at the fuse or circuit breaker panel.
4. Do not use the cavity for storage purposes. Do not leave paper products, cooking utensils, or food in the cavity when not in use.



Keep cord away from heated surface.

IMPORTANT SAFETY INSTRUCTIONS



Liquids, such as water, coffee, or tea are able to overheat beyond the boiling point without appearing to be boiling. Visible bubbling or boiling when the container is removed from the microwave oven is not always present.

THIS COULD RESULT IN VERY HOT LIQUID SUDDENLY BOILING

OVER WHEN THE CONTAINER IS DISTURBED OR A UTENSIL IS INSERTED INTO THE LIQUID.

To reduce the risk of injury to persons:

1. Do not overheat the liquid.
2. Stir the liquid both before and halfway through heating it.
3. Do not use straight-sided containers with narrow necks.
4. After heating, allow the container to stand in the microwave oven for a short time before removing the container.
5. Use extreme care when inserting a spoon or other utensil into the container.

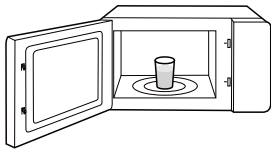

Some products such as whole eggs and sealed containers, for example, closed glass jars are able to explode and should not be heated in this oven.

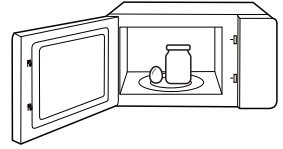

Do not store this appliance outdoors. Do not use this product near water - for example, near a kitchen sink, in a wet basement, near a swimming pool, or similar location.

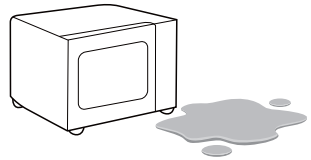

Do not immerse cord or plug in water or any other liquid.



IMPORTANT SAFETY INSTRUCTIONS



Use this appliance only for its intended use as described in the manual.

Do not use corrosive chemicals or vapors in this appliance. This type of oven is specifically designed to heat, cook or dry food.

It is not designed for industrial or laboratory use.



Do not operate this appliance if it has a damaged cord or plug, if it is not working properly, or if it has been damaged or dropped.



Do not cover or block any openings on the appliance.



Do not let cord hang over edge of table or counter.

SAVE THESE INSTRUCTIONS

HOUSEHOLD USE ONLY(NOT FOR COMMERCIAL USE)

GROUNDING INSTRUCTIONS

This appliance must be grounded. In the event of an electrical short circuit, grounding reduces the risk of electric shock by providing an escape wire for the electric current. This appliance is equipped with a cord having a grounding wire with a grounding plug. The plug must be plugged into an outlet that is properly installed and grounded.

WARNING - Improper use of the grounding can result in a risk of electric shock. Consult a qualified electrician or serviceman if the grounding instructions are not completely understood, or if doubt exists as to whether the appliance is properly grounded. If it is necessary to use an extension cord, use only a 3-wire extension cord that has a 3-blade grounded plug, and 3-slot receptacle that will accept the plug on the appliance. The marked rating of the extension cord shall be equal to or greater than the electrical rating of the appliance.



DANGER

Electric Shock Hazard:

Touching some of the internal components can cause serious personal injury or death. Do not disassemble this appliance.



WARNING

Electric Shock Hazard:

Improper use of the grounding can result in electric shock. Do not plug into an outlet until appliance is properly installed and grounded.

1. A short power-supply cord is provided to reduce the risks resulting from becoming entangled in or tripping over a longer cord.
2. Longer cord sets or extension cords are available and may be used if care is exercised in their use.
3. If a long cord or extension cord is used:
 - (1). The marked electrical rating of the cord set or extension cord should be at least as great as the electrical rating of the appliance.
 - (2). The extension cord must be a grounding-type 3-wire cord.
 - (3). The longer cord should be arranged so that it will not drape over the counter top or tabletop where it can be pulled on by children or tripped over unintentionally.

RADIO INTERFERENCE

1. Operation of the microwave oven may cause interference to your radio, TV or similar equipment.
2. When there is interference, it may be reduced or eliminated by taking the following measures:
 - (1). Clean door and sealing surface of the oven.
 - (2). Reorient the receiving antenna of radio or television.
 - (3). Relocate the microwave oven with respect to the receiver.
 - (4). Move the microwave oven away from the receiver.
 - (5). Plug the microwave oven into a different outlet so that microwave oven and receiver are on different branch circuits.

This device complies with part 18 of the FCC Rules.

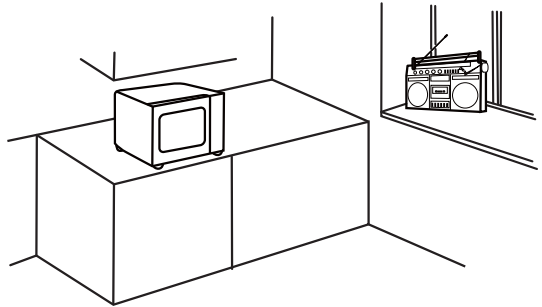

UTENSILS



- Personal Injury Hazard:
Tightly-closed utensils could explode. Closed containers should be opened and plastic pouches should be pierced before cooking. See the instructions on "Materials you can use in microwave oven or to be avoided in microwave oven."
There may be certain non-metallic utensils that are not safe to use for microwaving. If in doubt, you can test the utensil in question following the procedure below.

Utensil Test:

1. Fill a microwave-safe container with 1 cup of cold water (8.5 oz) along with the utensil in question.
2. Cook on maximum power for 1 min.
3. Carefully feel the utensil. If the empty utensil is warm, do not use it for microwave cooking.
4. Do not exceed 1 min cooking time.

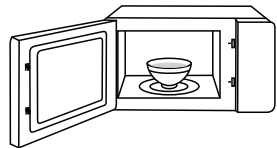



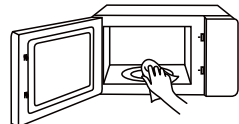





KEEP THE CAVITY CLEAN

















MATERIALS YOU CAN USE IN MICROWAVE OVEN

UTENSILS	REMARKS
 Browning dish	Follow manufacturer's instructions. The bottom of browning dish must be at least 3/16 inch (5mm) above the turntable. Incorrect usage may cause the turntable to break. 
 Dinnerware	Microwave-safe only. Follow manufacturer's instructions. Do not use cracked or chipped dishes. 
 Glass jars	Always remove lid. Use only to heat food until just warm. Most glass jars are not heat resistant and may break. 
 Glassware	Heat-resistant oven glassware only. Make sure there is no metallic trim. Do not use cracked or chipped dishes. 
 Oven cooking bags	Follow manufacturer's instructions. Do not close with metal tie. Make slits to allow steam to escape. 
 Paper plates and cups	Use for short-term cooking/warming only. Do not leave oven unattended while cooking. 
 Paper towels	Use to cover food for reheating and absorbing fat. Use with supervision for a short-term cooking only. 
 Parchment paper	Use as a cover to prevent splattering or a wrap for steaming. 

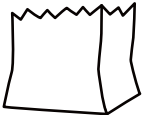
MATERIALS YOU CAN USE IN MICROWAVE OVEN

UTENSILS	REMARKS
 <p data-bbox="162 405 230 432">Plastic</p>	<p data-bbox="345 304 893 443">Microwave-safe only. Follow the manufacturer's instructions. Should be labeled "Microwave Safe". Some plastic containers soften, as the food inside gets hot. "Boiling bags" and tightly closed plastic bags should be slit, pierced or vented as directed by package.</p> 
 <p data-bbox="135 592 259 619">Plastic wrap</p>	<p data-bbox="345 523 915 580">Microwave-safe only. Use to cover food during cooking to retain moisture. Do not allow plastic wrap to touch food.</p> 
 <p data-bbox="122 761 273 788">Thermometers</p>	<p data-bbox="345 708 882 735">Microwave-safe only (meat and candy thermometers).</p> 
 <p data-bbox="144 920 251 948">Wax paper</p>	<p data-bbox="345 868 910 895">Use as a cover to prevent splattering and retain moisture.</p> 

MATERIALS CAN NOT BE USED IN MICROWAVE OVEN

UTENSILS	REMARKS
 <p>Aluminum tray</p>	May cause arcing. Transfer food into microwave-safe dish. 
 <p>Food carton with metal handle</p>	May cause arcing. Transfer food into microwave-safe dish. 
 <p>Metal or metal trimmed utensils</p>	Metal shields the food from microwave energy. Metal trim may cause arcing. 
 <p>Metal twist ties</p>	May cause arcing and could cause a fire in the oven. 
 <p>Paper bags</p>	May cause a fire in the oven. 
 <p>Plastic foam</p>	Plastic foam may melt or contaminate the liquid inside when exposed to high temperature. 
 <p>Wood</p>	Wood will dry out when used in the microwave oven and may split or crack. 

SETTING UP YOUR OVEN

NAMES OF MICROWAVE OVEN PARTS AND ACCESSORIES

Remove the oven and all materials from the carton and oven cavity.

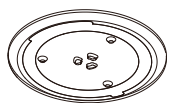

Glass turntable

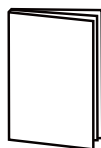

Instruction Manual

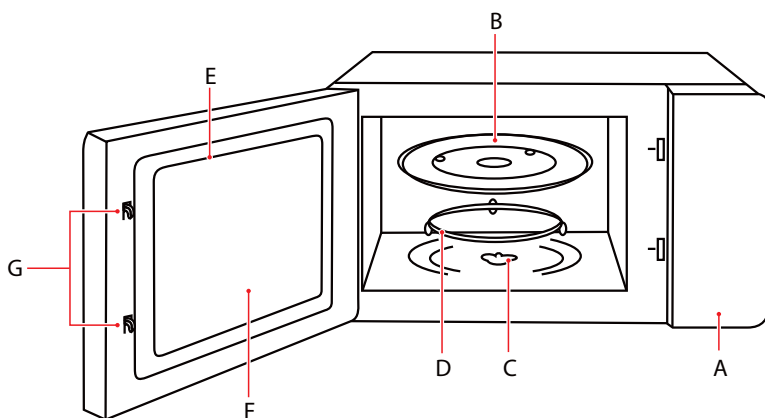

- A. Control panel
- B. Glass turntable
- C. Turntable shaft
- D. Turntable ring assembly

- E. Door assembly
- F. Observation window
- G. Safety interlock system

SETTING UP YOUR OVEN

TURNTABLE INSTALLATION

Cleaning the cooking compartment and putting the turntable in place.

For new installations, make sure all packaging and shipping tape has been removed from the turntable shaft.

Before using the appliance to prepare food for the first time, you will need to put the turntable in place correctly. You must clean the cooking compartment and accessories.

How to put the turntable in place:

1. Place the turntable ring assembly ③ into the recess in the cooking compartment.

2. Place the glass turntable ① on the turntable ring assembly ③. Fit the raised, curved lines in the center of the glass turntable bottom between the three spokes of the shaft.

Make sure that the glass turntable ① engages in the turntable shaft ② in the center of the cooking compartment floor. The rollers on the shaft should fit inside the turntable bottom ridge.

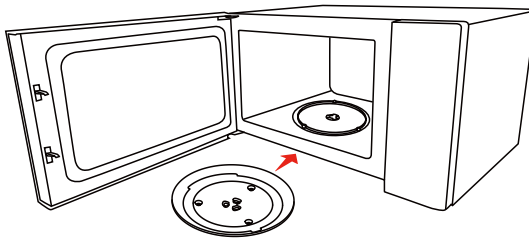
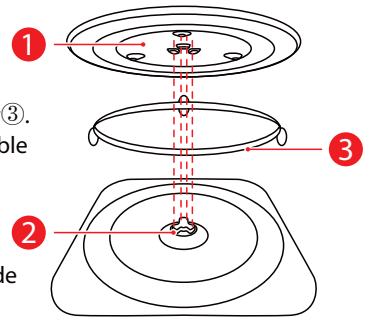

NOTE

- Never use the appliance without the turntable. Make sure that it is properly engaged. The turntable can turn clockwise or anti-clockwise.
- Never place the glass turntable upside down. The glass turntable should never be restricted.
- Both glass turntable and turntable ring assembly must always be used during cooking.
- All food and containers of food are always placed on the glass turntable for cooking.
- Never restrict the movement of the turntable.
- If glass turntable or turntable ring assembly cracks or breaks, contact your nearest authorized service center.

COUNTERTOP INSTALLATION

Remove all packing material and accessories. Examine the oven for any damage such as dents or broken door. Do not install if oven is damaged.

Cabinet: Remove any protective film found on the microwave oven cabinet surface. Do not remove the light brown Mica cover that is attached to the oven cavity to protect the magnetron.

INSTALLATION

1. Select a level surface that provide enough open space for the intake and/or outlet vents. A minimum clearance of 3.0 inches (7.5cm) is required between the oven and any adjacent walls. One side must be open.
The minimum installation height is 3.0ft(91.6cm).
 - a. Leave a minimum clearance of 12 inches (30cm) above the oven.
 - b. Do not remove the legs from the bottom of the oven.
 - c. Blocking the intake and/or outlet openings can damage the oven.
 - d. Place the oven as far away from radios and TV as possible.Operation of microwave oven may cause interference to your radio or TV reception.

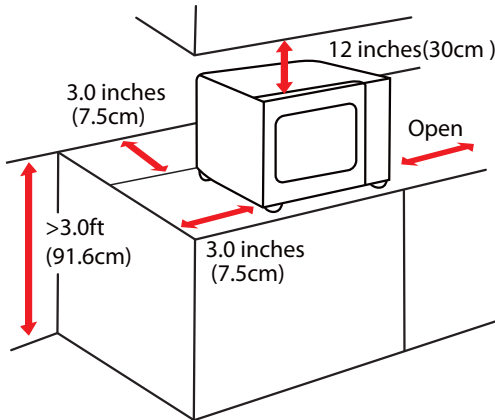

2. Plug microwave oven into a standard household outlet. Be sure the voltage and the frequency is the same as the voltage and the frequency on the rating label.



NOTE

- Do not install oven over a range cooktop or other heat-producing appliance. If installed near or over a heat source, the oven could be damaged and the warranty would be void.

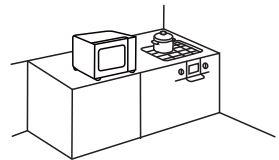

The accessible surface may be hot during operation

INSTRUCTION FOR USE

BEFORE USING FOR THE FIRST TIME

It is normal that the stove may produce unpleasant odors when it is used for the first time.

This section tells you what you need to do before using your microwave to prepare food for the first time. Read the section entitled "**SAFETY INFORMATION**" beforehand.

"IMPORTANT SAFETY INFORMATION" on page 2.

Before you can use your new appliance, you will need to put the turntable in place correctly. You must also clean the cooking compartment and accessories.

Cleaning the cooking compartment and putting the turntable in place

Before using the appliance to prepare food for the first time, you must clean the cooking compartment and accessories.



NOTE

- Never use the appliance without the turntable.
- Make sure that it is properly engaged. The turntable can turn clockwise or anti-clockwise.

OPERATION

CONTROL PANEL AND FEATURES

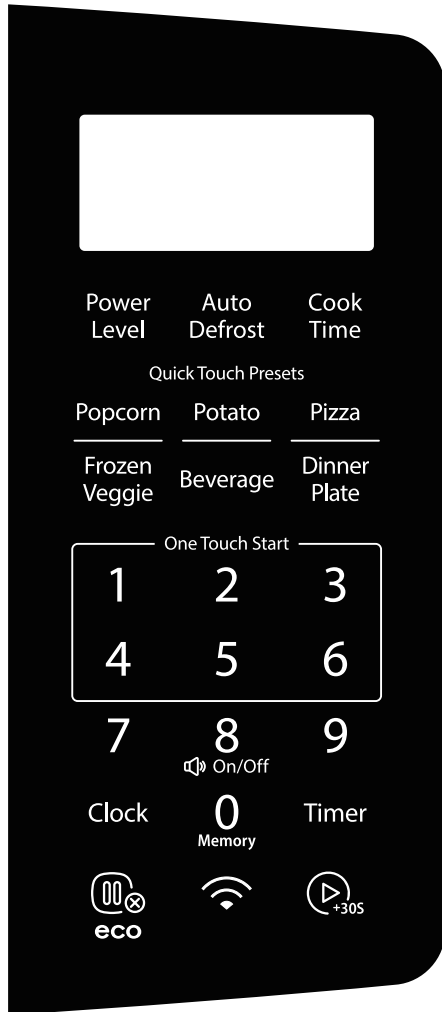

1. POWER LEVELS

11 power levels are available.

LEVEL	POWER	DISPLAY
1	100%	P100
2	90%	P90
3	80%	P80
4	70%	P70
5	60%	P60
6	50%	P50
7	40%	P40
8	30%	P30
9	20%	P20
10	10%	P10

2. CLOCK SETTING

When the microwave oven is plugged into an outlet , "00:00" will display.

a Press Clock once.

Clock

b Press number keys to set the hour figures, it should be within 1:00~12:59.

1 2 3

c Press Clock to confirm.

Clock



NOTE

• In the process of setting clock, if the "eco" pad is pressed or if there is no operation within 1 minute, the display will automatically return to the previous clock setting.

3. KITCHEN TIMER

When the microwave oven is plugged into an outlet, "00:00" will display.

a Press Timer once.

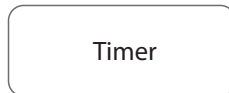

b Press number keys to set the time, it should be within 00:01~99:99.



c Press  to start counting down.



NOTE

- The Kitchen Timer setting is different from the Clock setting; it is simply a timer.
- During the Kitchen Timer function, no cooking function can be set into operation.

4. MICROWAVE COOK

a Press Cook Time once.



b Press number keys to set the time, it should be within 00:01~99:99.

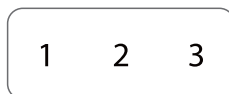

c Press Power Level once.

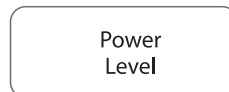

d Press number keys to set the power level.

1 2 3

c Press  to start cooking.



NOTE

• Press  to increase the cook time by 30 seconds during cooking.

5. WEIGHT DEFROST

a Press Auto Defrost once, "DEF1" will display

Auto
Defrost

b Press number keys to set the defrost weight.
it should be within 4~100 Oz.

1 2 3

c Press  to start defrosting.



6. TIME DEFROST

- a Press **Auto Defrost** twice, "dEF2" will display

Auto
Defrost

- b Press number keys to set the defrost time.
it should be within 0:01~99:99.

1 2 3

- c Press  to start defrosting.



NOTE

7. MULTI-SATGE COOKING

- a Press **Auto Defrost** twice, "dEF2" will display.

Auto
Defrost

- b Press number keys to set the defrost time.
it should be within 0:01~99:99.

1 2 3

c Press Cook Time once

Cook
Time

d Press number keys to set the cook time.

1 2 3

e Press Power Level once, PL10 will display.

Power
Level

f Press number keys to set the cook time.

1 2 3

c Press  to start defrosting.



NOTE

- Two cooking stages can be set in multi-stage cooking.
- If you set defrost function, it will work automatically in the first stage.
- Kitchen Timer, Auto menu, Speed cooking and Preheat cannot be set as one of the multi-stage.

7. MEMORY FUNCTION

- a Press **Memory** to program and choose up to three cooking procedures. Each procedure will be indicated by 1, 2 or 3 in the display.



- b Press  to start cooking.
two cooking stages can be set for each procedure.



To program a procedure, follow the steps listed below.

Example: Cook food at 80% Power Level for 3 minutes and 20 seconds; save as memory 2.

- Press **Memory** twice; screen displays 2.



- Press **Cook Time** once



- Press number keys to set the cook time.

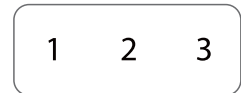

- Press **Power Level** once

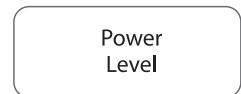

- Press number keys to set the power level.

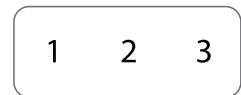

- Press "Memory" to save the procedure. Oven beeps once.



- To choose the procedure from the memory list, press "Memory" twice. Screen will display "2".



- Press  to start the procedure.



NOTE

- "Defrost" and "Auto Cook" cannot be set in memory function.
- If the power is not cut off, the procedure will be saved all the time.

8. SPEED COOKING

- a Press number keys "1-6" to set the cook time for "1-6" minutes with PL10 power level directly.



- b Press  to start cooking.



Or

- c Press  to start cooking with P100 power level for 30 seconds directly.



9. Silent mode

- a To activate the mute mode:
In waiting state, press and hold "8" for 3 seconds.
A long beep will sound. When you press the keys,
it does not make a sound.



- b To deactivate the mute mode:
In silent mode, press and hold "8" for 3 seconds.
A long beep will sound.



10. LOCK FUNCTION

- a To lock the microwave so that it cannot be operated by children
or other unintended users, press  pad for 3 seconds, the
locked icon will display.



- b To unlock, press  pad for 3 seconds.



11. ECO FUNCTION

- a To enter ECO mode:
In waiting state, press  once, the
screen will turn off



- b To cancel ECO mode:
In ECO mode, press any keys to cancel it.





12. INQUIRING FUNCTION

- a When oven is cooking or in paused mode,press Clock,the current time will appear for three seconds in the display.

A rectangular button with rounded corners and a thin black border. The word "Clock" is centered inside the button in a black, sans-serif font.

13. WIFI CONNECTION

- a Connect the network
Press and hold "  " for 3 seconds, till a beep sounds,"AP" and flashing "  " show on display.if it fails,"N0" will display,and the oven will return to standby after 30 seconds.



- b Disconnect from the network
Press and hold "  " for 8 seconds, till a beep sounds,"--" flashes for few seconds, if the link has been removed successfully , the screen will display "8888" and then return to standby after 3 seconds.if it fails,"FFFF" will display,and the oven will return to standby after 3 seconds.



13. AUTO MENU

a Press the desired menu key to choose correspond menu.

Sensor
Reheat

b Press  to start cooking.



MENU CHART

MENU	DISPLAY	WEIGHT/ PORTION	POWER LEVEL
Popcorn	1.75 Oz	1.75	P100
	3.0 Oz	3.0	
	3.5 Oz	3.5	
Potato	1	1	P100
	2	2	
	3	3	
Pizza	4 Oz	4.00	P100
	8 Oz	8.00	
	14 Oz	14.00	
Frozen Vegetable	4.00 Oz	4.00	P100
	8.00 Oz	8.00	
	16.00 Oz	16.00	
Beverage	1 cup(120ML)	1	P100
	2 cup(240ML)	2	
	3 cup(360ML)	3	
Dinner Plate	9 Oz	9	P100
	12 Oz	12	
	18 Oz	18	

CLEANING

With good care and cleaning, your appliance will retain its appearance and remain fully functioning for a long time to come. We will explain here how you should correctly care for and clean your appliance.



- Scratched glass in the appliance door may develop into a crack. Do not use a glass scraper, sharp or abrasive cleaning aids or detergents.
- The surface of the appliance may become damaged if it is not cleaned properly. Microwave energy may escape. Clean the appliance on a regular basis, and remove any food remnants immediately.
- Do not immerse the appliance in water or clean under a jet of water.

Cleaning agent

To ensure that the different surfaces are not damaged by using the wrong cleaning agent, observe the information in the table. Wash new sponge cloths thoroughly before use.

Do not use:



Harsh or abrasive cleaning agents



Metal or glass scrapers to clean the door panels

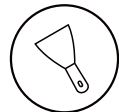

Metal or glass scrapers to clean the door seal



Hard scouring pads or sponges



Cleaning agents with a high alcohol content

APPLIANCE FRONT

Hot soapy water:

Clean using a dish cloth and then dry with a soft cloth. Do not use metal or glass scrapers for cleaning.

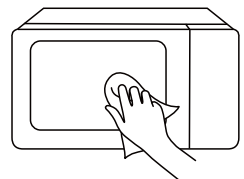

APPLIANCE FRONT WITH STAINLESS STEEL

Hot soapy water:

Clean using a dish cloth and then dry with a soft cloth. Remove splashes and patches of limescale, grease, starch and albumin immediately. Corrosion can form under these patches or splashes. Do not use glass cleaners or metal or glass scrapers for cleaning.

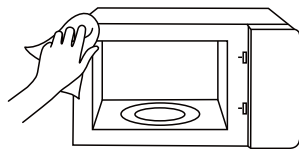

COOKING COMPARTMENT MADE OF STAINLESS STEEL

Hot soapy water or vinegar solution:

Clean using a dish cloth and then dry with a soft cloth. Do not use oven spray or any other aggressive oven cleaners or abrasive materials. Scouring pads, rough sponges and pan cleaners are also unsuitable. These items scratch the surface. Allow the interior surfaces to dry completely.

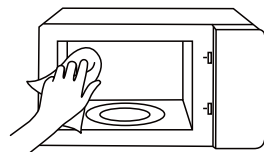

RECESS IN THE COOKING COMPARTMENT

Damp cloth:

Water must not be allowed to run into the appliance through the turntable drive. Dry the turntable drive with a cloth.

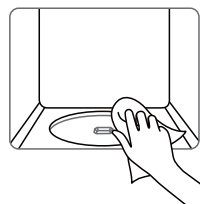

TURNTABLE AND ROLLER RING

Hot soapy water:

When placing the turntable back into its recess, it must engage properly.

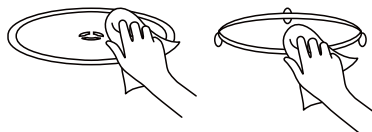

DOOR PANELS

Glass cleaner:

Clean with a dish cloth. Do not use glass scrapers.

MAINTENANCE

TROUBLE SHOOTING

Check your problem by using the chart below and try the solutions for each problem.

If the microwave oven still does not work properly, contact the nearest authorized service center.

TROUBLE	POSSIBLE CAUSE	POSSIBLE REMEDY
Oven will not start	<ul style="list-style-type: none">a. Electrical cord for oven is not plugged in.b. Door is open.c. Wrong operation is set.	<ul style="list-style-type: none">a. Plug into the outlet.b. Close the door and try again.c. Check instructions
Arcing or sparking	<ul style="list-style-type: none">a. Materials to be avoided in microwave oven were used.b. The oven is operated when empty.c. Spilled food remains in the cavity.	<ul style="list-style-type: none">a. Use microwave-safe cookware only.b. Do not operate with oven empty.c. Clean cavity with wet towel.
Unevenly cooked foods	<ul style="list-style-type: none">a. Materials to be avoided in microwave oven were used.b. Food is not defrosted completely.c. Cooking time, power level is not suitable.d. Food is not turned or stirred.	<ul style="list-style-type: none">a. Use microwave-safe cookware only.b. Completely defrost food.c. Use correct cooking time, power level.d. Turn or stir food.
Overcooked foods	Cooking time, power level is not suitable.	Use correct cooking time, power level.
Undercooked foods	<ul style="list-style-type: none">a. Materials to be avoided in microwave oven were used.b. Food is not defrosted completely.c. Oven ventilation ports are restricted.d. Cooking time, power level is not suitable.	<ul style="list-style-type: none">a. Use microwave-safe cookware only.b. Completely defrost food.c. Check to see that oven ventilation ports are not restricted.d. Use correct cooking time, power level
Improper defrosting	<ul style="list-style-type: none">a. Materials to be avoided in microwave oven were used.b. Cooking time, power level is not suitable.c. Food is not turned or stirred.	<ul style="list-style-type: none">a. Use microwave-safe cookware only.b. Use correct cooking time, power level.c. Turn or stir food.

ONE YEAR LIMITED WARRANTY

This product carries a warranty stating that it will be free from defects in material and workmanship for a period of one year from the date of purchase. This warranty is valid for the original retail purchaser from the date of initial retail purchase and is not transferable. Keep your original sales receipt.

IMPORTANT:

1. This warranty does not cover damages resulting from accident, misuse or abuse, lack of reasonable care, the affixing of any attachments not provided with the product, loss of parts, or subjecting the appliance to any but the specified voltage. (Read directions carefully.)
2. This warranty is void if this product is ever used for other than private household purposes.
3. This warranty is void if this product is ever used outside of United State.

If service is required during the warranty period, properly pack your unit. We recommend using the original carton and packing materials.

If additional assistance is needed, please contact customer assistance at:

customer@us.toshiba-lifestyle.com

855-204-5313

Midea America Corp. expressly disclaims all responsibility for consequential damages or incidental losses caused by use of the appliance. Some states do not allow this exclusion or limitation of incidental or consequential losses so the foregoing disclaimer may not apply to you. This warranty gives you specific legal rights, and you may also have other rights which may vary from state to state.

The serial number can be found on the back cabinet. We suggest that you record the serial number of your unit in the space below for future reference

Model Number : _____

Serial Number : _____

Product registration is not mandatory. Failure to complete and return the card or form does not diminish the consumer's warranty rights.

SAVE THIS FOR YOUR RECORDS

Made in China

#DetailsMatter

Customercare@us.toshiba-lifestyle.com
855-204-5313