



FCC PART18 TEST REPORT

Report No.: 20240217G03244X-E
Product Name: Microwave Oven
Trade Name: Midea, GE APPLIANCES
Model No. : XM245AYY-P1, XM245AYYY-P1, GCST16S1WTS, GCST16S1WBB, GCST16S1WTS, GCST16S1WSS
FCC ID : VG8EM245AXX-P1
Applicant: Guangdong Midea Kitchen Appliances Manufacturing Co.,Ltd
Received Date: 2024.02.28
Test Data: 2024.02.28-2024.02.29
Issued by: CCIC Southern Testing Co., Ltd.
Lab Location: Electronic Testing Building, No.43 Shahe Road, Xili Street, Nanshan District, Shenzhen, Guangdong, China
Tel: 86 755 26627338 **Fax:** 86 755 26627238

This test report consists of **22** pages in total. It may be duplicated completely for legal use with the approval of the applicant. It should not be reproduced except in full, without the written approval of our laboratory. The client should not use it to claim product endorsement by CCIC-SET. The test results in the report only apply to the tested sample. The test report shall be invalid without all the signatures of testing engineers, reviewer and approver. Any objections must be raised to CCIC-SET within 15 days since the date when the report is received. It will not be taken into consideration beyond this limit.



Test Report

Product Name..... Microwave Oven

Model No. XM245AYY-P1, XM245AYYY-P1, GCST16S1WTS,
GCST16S1WBB, GCST16S1WTS, GCST16S1WSS

Trade name Midea, GE APPLIANCES

Applicant..... Guangdong Midea Kitchen Appliances Manufacturing Co., Ltd.

Applicant Address..... No.6, Yong An Road, Beijiao, Shunde, Foshan, China

Manufacturer Guangdong Midea Kitchen Appliances Manufacturing Co., Ltd.

Manufacturer Address No.6, Yong An Road, Beijiao, Shunde, Foshan, China

Test Standards 47 CFR Part 18

Test Result..... PASS

Tested by Sun Jiaohui
Jiaohui Sun Test Engineer 2024.03.01

Reviewed by Chris You
Chris You Senior Engineer 2024.03.01

Approved by Yang Fan
Yang Fan, Manager 2024.03.01



TABLE OF CONTENTS

1.	GENERAL INFORMATION	5
1.1	GENERAL DESCRIPTION OF EUT	5
1.2	Test Standards and Results.....	7
1.3	Facilities and Accreditations.....	8
1.3.1	Facilities	8
1.3.2	Test Environment Conditions.....	8
1.3.3	Measurement Uncertainty	9
2.	EQUIPMENTS LIST	9
3.	EMC EMISSION TEST.....	10
3.1	Test Procedure.....	10
3.1.1	Frequency For Normal Voltage	10
3.1.2	Frequency For Line Voltage.....	10
3.1.3	Measurement data	11
3.2	RADIATION HAZARD TEST.....	11
3.2.1	Test Setup.....	11
3.2.2	Limit.....	11
3.2.3	Test results.....	11
3.3	RF OUTPUT POWER MEASUREMENT	11
3.3.1	Test Standard.....	11
3.3.2	EUT Operating mode	12
3.3.3	Test Data.....	12
4.	CONDUCTED EMISSION	13
4.1.1	Conducted Emission Limit.....	13
4.1.2	Test Procedure.....	13
4.1.3	Test Setup.....	13
5.	RADIATED EMISSION	16
5.1.1	Radiated Emission Limits	16
5.1.2	Test Setup.....	16
5.1.3	Test Procedure.....	17
APPENDIX I: PHOTOGRAPHS OF EMC TEST CONFIGURATION.....		21



Change History		
Issue	Date	Reason for change
1.0	2024.03.01	First edition



1. GENERAL INFORMATION

1.1 GENERAL DESCRIPTION OF EUT

EUT Name : Microwave Oven
 Trade Name..... : Midea, GE APPLIANCES
 Model..... : XM245AYY-P1, XM245AYYY-P1, GCST16S1WTS, GCST16S1WBB, GCST16S1WTS, GCST16S1WSS model designations as follow:
 X=E or A, on behalf of controller type;
 E: Film type keypad; A: Rotating type knob;
 M: indicates microwave function;
 245: “2” indicates the microwave output power is 1150W or 1200W, “45” indicates cavity capacity is 45 liters;
 A: indicates the design No.;
 YY or YYY: “Y” may be 0~9, A~Z or blank, indicates different appearance;
 -P1: indicates Painted (Steel) Cavity.
 Customer models as “GCST16S1WTS, GCST16S1WBB, GCST16S1WTS, GCST16S1WSS” with trade mark as “GE APPLIANCES”, they are identical to EM245A2GH-P1 except for model number, trade mark and appearance.
 Model of EM245A2GH-P1 was selected for final testing.

Power Supply : 120VAC/60Hz
 Rated input Power(microwave): 1600W
 Rated output Power(microwave): 1150W / 1200W
 Frequency..... : 2450MHz (ClassB / Group 2)
 Magnetron Model..... : 2M248J
 Magnetron Manufacturer ... : TOSHIBA
 Description of Support Units: -Load for power output measurement: 1150 milliliters of water in the beaker located in the center of the oven.
 -Load for frequency measurement: 1150milliliters of water in the beaker located in the center of the oven.
 -Load for measurement of radiation on second and third harmonic: Two loads, one of 805 and the other of 345 milliliters, of water are used. Each load is tested both with the beaker located in the center of the oven and with it in the right front corner.
 -Load for all other measurements: 805 milliliters of water, with

the beaker located in the center of the oven.



Note 1: The EUT have the following typical setups during the test:

Setup1: Microwave heating mode(According to FCC PART 18);

Note 2: For a more detailed description, please refer to Specification or User’s Manual supplied by the applicant and/or manufacturer.

Note 3: This is an updating report based the original report #: “64.790.10.139.01” which was re-tested on February 28, 2024 to February 29, 2024. Differences between them are as follow:

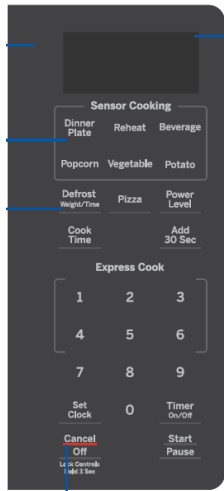
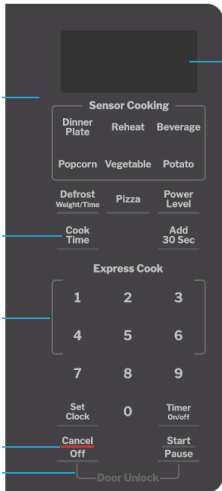
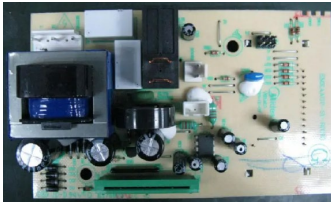
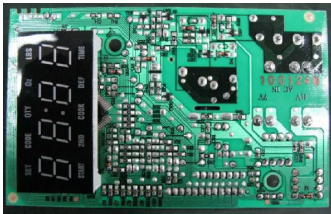
1. Difference in appearance & construction & PCB:

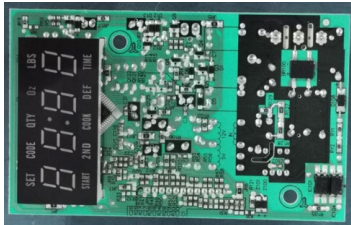
No.:	Original	New	Difference(s)
1			<p>Keypad: Updated front keypad to accommodate child lock function (Child resistant oven door function).</p>
2	 	 	<p>Mother board: Modified the peripheral circuit (non-RF circuit) and some individual components and PCB layout. The magnetron and other circuit are exactly same as before.</p>

3	Not Applicable		The new one adds a solenoid valve locking mechanism, but the original is not.
---	----------------	---	---

2. Others are the same as before.

1.2 Test Standards and Results

The objective of the report is to perform testing according to 47 CFR Part 18:

No.	Identity	Document Title
1	47 CFR Part 18	Radio Frequency Devices

Test detailed items/section required by FCC rules and results are as below:

Emission			
Standard	Item	Class / Severity	Result
47 CFR PART 18	Conducted Emission (150 kHz to 30 MHz)	18.307(b)	PASS
	Radiated Emission (30 MHz to 1 GHz)	18.305(b)	PASS



1.3 Facilities and Accreditations

1.3.1 Facilities

CNAS-Lab Code: L1659

CCIC-SET is a third party testing organization accredited by China National Accreditation Service for Conformity Assessment (CNAS) according to ISO/IEC 17025. The accreditation certificate number is L1659.

FCC-Registration No.: CN1283

CCIC Southern Testing Co., Ltd EMC Laboratory has been registered and fully described in a report filed with the FCC (Federal Communications Commission). The acceptance letter from the FCC is maintained in our files. Designation Number: CN1283, valid time is until June 30,2025.

ISED Registration: 11185A-1

CCIC Southern Testing Co., Ltd. EMC Laboratory has been registered by Certification and Engineering Bureau of Industry Canada for the performance of radiated measurements with Registration No. 11185A-1 on Aug. 04, 2016, valid time is until June 30,2025.

A2LA Code: 5721.01

CCIC-SET is a third party testing organization accredited by A2LA according to ISO/IEC 17025. The accreditation certificate number is 5721.01.

1.3.2 Test Environment Conditions

During the measurement, the environmental conditions were within the listed ranges:

Temperature (°C):	15°C- 35°C
Relative Humidity (%):	25% -75%
Atmospheric Pressure (kPa):	86kPa-106kPa



1.3.3 Measurement Uncertainty

The uncertainty is calculated using the methods suggested in the "Guide to the Expression of Uncertainty in Measurement" (GUM) published by ISO.

Uncertainty of Conducted Emission:	Uc = 3.2 dB (k=2)
Uncertainty of Radiated Emission:(30MHz~1GHz)	Uc = 5.8 dB (k=2)
Uncertainty of Radiated Emission:(1~18GHz)	Uc = 5.1 dB (k=2)
Radiation Hazard Measurement	Uc = 2.4 dB (k=2)

2. EQUIPMENTS LIST

A. Equipment List:

Description	Manufacturer	Model	Serial No.	Calibration Date	Calibration Due. Date
Test Receiver	Rohde & Schwarz	ESIB26	A0304218	2023.10.20	2024.10.19
LISN	ROHDE&SCHWARZ	NSLK 8127	A210803670	2023.06.08	2024.06.07
Shield Room	Xinju Electronics	L9000*W4500* H3100	A181003230	2021.09.05	2024.09.04
EMI Test Receiver	ROHDE&SCHWARZ	ESIB7	A0501375	2023.03.16	2024.03.15
Broadband Ant.	ETC	MCTD2786	A150402240	2021.03.05	2024.03.04
3M Anechoic Chamber	Albatross	SAC-3MAC 9*6*6m	A0412375	2021.03.26	2024.03.25
EMI Test Receiver	ROHDE&SCHWARZ	ESW26	A180502935	2023.06.08	2024.06.07
5M Anechoic Chamber	Albatross	SAC-5MAC 12.8x6.8x6.4m	A0304210	2021.06.08	2024.06.07
EMI Horn Ant.	ETC	MCTD-1209	A150402241	2024.05.16	2024.05.22
Spectrum Analyzer	ROHDE&SCHWARZ	ESW26	A180502935	2023.06.08	2024.06.07
Portable Spectrometer	ROHDE&SCHWARZ	FSH8	A140401672	2024.02.13	2025.02.12
Prode	ROHDE&SCHWARZ	TSEMF-B1	A140401671	2024.02.14	2025.02.13



3. EMC EMISSION TEST

3.1 Test Procedure

Test Requirement: 47 CFR PART 18

Test Method: FCC/OST MP-5:1986

Power Supply: 120VAC/60Hz

Frequency Range: 2400-2500MHz

Detector: Peak

Limit: ISM equipment may be operated at any frequency above 9KHz and the frequency band 2400-2500MHz is allocated for use by ISM equipment

ISM frequency	Tolerance
6.78 MHz	±15.0 kHz
13.56 MHz	±7.0 kHz
27.12 MHz	±163.0 kHz
40.68 MHz	±20.0 kHz
915 MHz	±13.0 MHz
2,450 MHz	±50.0 MHz
5,800 MHz	±75.0 MHz
24,125 MHz	±125.0 MHz
61.25 GHz	±250.0 MHz
122.50 GHz	±500.0 MHz
245.00 GHz	±1.0 GHz

3.1.1 Frequency For Normal Voltage

The operating frequency was measured using a spectrum analyzer. Starting with the EUT at room temperature, a 1100mL water load was placed in the center of the oven and the oven was operated at maximum output power. The fundamental operating frequency was monitored until the water load was reduced to 20 percent of the original load.

3.1.2 Frequency For Line Voltage

The EUT was operated / warmed by at least 10 minutes of use with a 1100mL water load at room temperature at the beginning of the test. Then the operating frequency was monitored as the input voltage was varied between 80 and 125 percent of the nominal rating.



3.1.3 Measurement data

Operating Mode	Frequency(MHz)
Normal Voltage	2433.6-2470.3
Line Voltage	2434.2-2470.5

3.2 RADIATION HAZARD TEST

3.2.1 Test Setup

The EUT was set-up according to the FCC MP-5 and FCC Part 18 for radiation hazard measurement. The measurement was using a microwave leakage meter to measure the radiation leakage in the as-received condition with the oven door closed A 805 mL water load in a breaker was located in the center of the oven and the microwave oven was set to maximum power. While the oven operating, the microwave meter will check the leakage and then record the maximum leakage.

3.2.2 Limit

A maximum of 1.0mW/cm²is allowed in according with the applicable FCC standards

3.2.3 Test results

Test location	Test result (mW/cm ²)	Limit(mW/cm ²)	Verdict
Left side	0.31	1.0	Pass
Right side	0.36	1.0	Pass
Front	0.40	1.0	Pass
Rear	0.27	1.0	Pass

There was no microwave leakage exceeding a power level of 0.40 m W/cm²Observed at any point 5cm or more from the external surface of the oven

3.3 RF OUTPUT POWER MEASUREMENT

3.3.1 Test Standard

Test Requirement	47 CFR PART 18
Test Method	FCC/OST MP-5:1986
Power Supply	120VAC/60Hz



3.3.2 EUT Operating mode

Test the EUT in microwave mode with full power.

3.3.3 Test Data

Mass of Water(g)	Mass of the container(g)	ambient temperature (°C)	Initial temperature(°C)	Final temperature(°C)	Heating Time(S)	Output Power(Watt)
1150	280	23.5	18.9	41.3	120	939.0

Formula:

$$P = \frac{4.2 \times m_w(T_2 - T_1) + 0.9 \times m_c(T_2 - T_0)}{t}$$

P is the microwave power output, in watts

Mw is the mass of the water, in grams

Mc is the mass of the container, in grams

T0 is the ambient temperature, in degrees Celsius

T1 is Initial temperature of the water, in degrees Celsius

T2 is final temperature of the water, in degrees Celsius

T is heating time, in seconds, excluding the magnetron filament heating-up time

4. CONDUCTED EMISSION

4.1.1 Conducted Emission Limit

Frequency range (MHz)	Conducted Limit (dB μ V)	
	Quasi-peak	Average
0.15 - 0.50	66 to 56	56 to 46
0.50 - 5	56	46
5 - 30	60	50

Note:

- The limit decreases linearly with the logarithm of the frequency in the range 0.15 MHz to 0.5 MHz.
- The lower limit is applicable at the transition frequency.

4.1.2 Test Procedure

The EUT is placed on a 0.8m high insulating table, which stands on the grounded conducting floor, and keeps 0.4m away from the grounded conducting wall. The EUT is connected to the power mains through a LISN which provides 50 Ω /50 μ H of coupling impedance for the measuring instrument. The Common Antenna is used for the call between the EUT and the System Simulator (SS). A Pulse Limiter is used to protect the measuring instrument. The factors of the whole test system are calibrated to correct the reading.

4.1.3 Test Setup

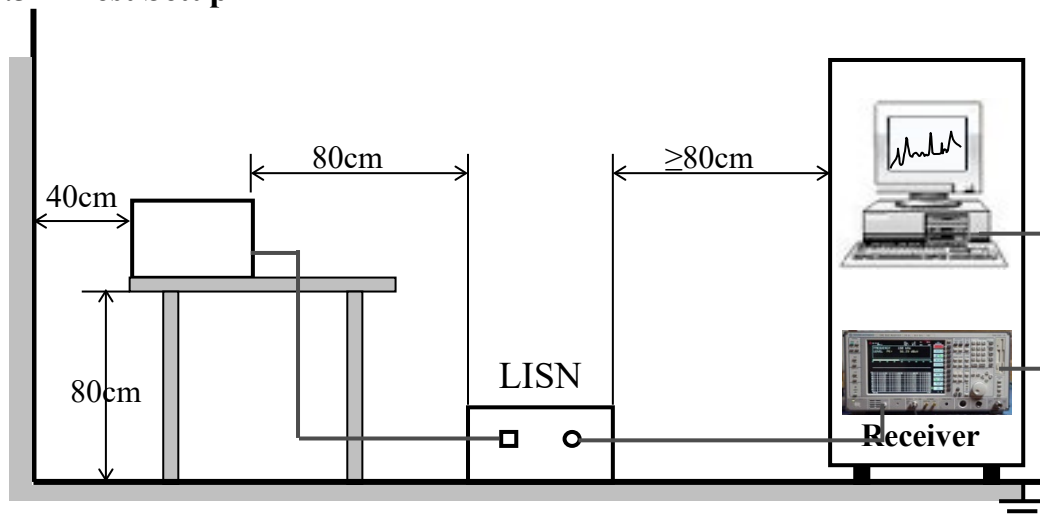

A. Test Result:

Mains terminal disturbance voltage, Setup1,L phase

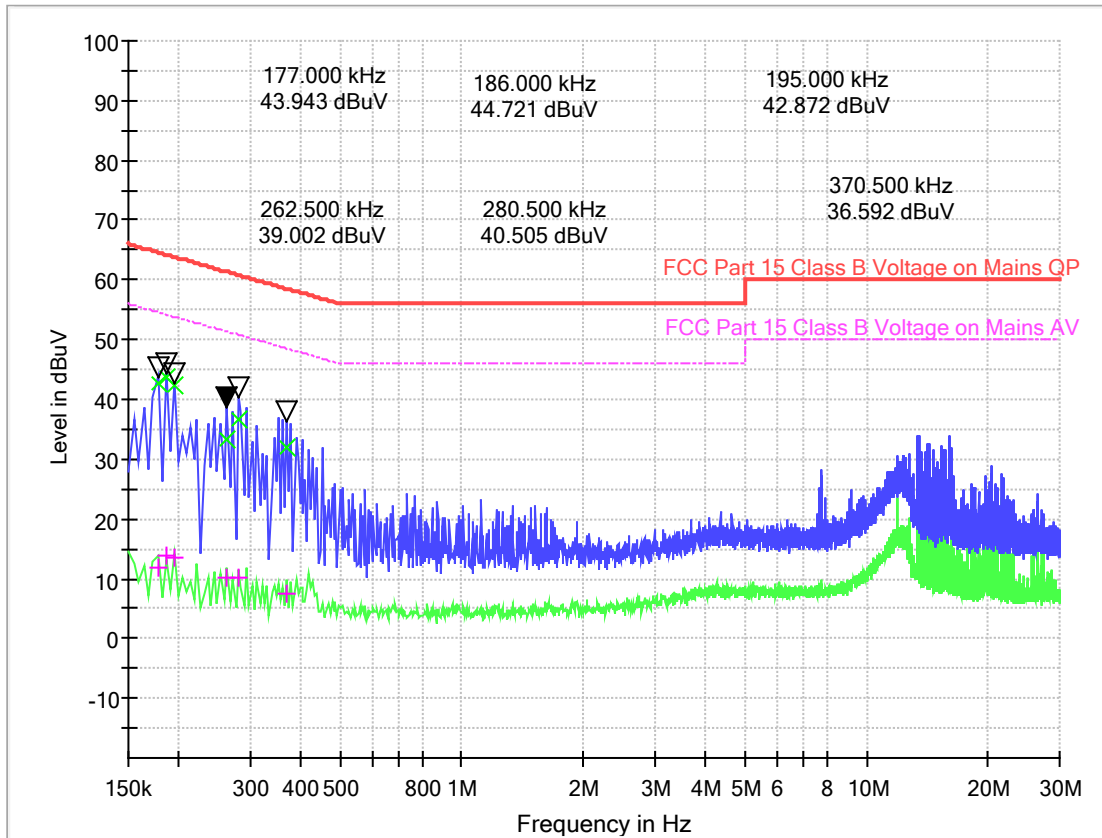

(Plot A: L Phase)

Frequency (MHz)	Quasi Peak	Average (dB μ V)	Cable Loss (dB)	Corr. (dB)	Margin - QPK	Limit - QPK	Margin - AV	Limit - AV (dB μ V)
0.177000	42.80	11.77	0.1	10.1	21.83	64.6	42.86	54.6
0.186000	43.82	13.85	0.1	10.1	20.39	64.2	40.36	54.2
0.195000	42.35	13.58	0.1	10.1	21.47	63.8	40.24	53.8
0.262500	33.14	10.17	0.1	10.1	28.21	61.4	41.18	51.4
0.280500	36.54	10.22	0.1	10.1	24.26	60.8	40.58	50.8
0.370500	32.07	7.65	0.1	10.1	26.42	58.5	40.84	48.5



Mains terminal disturbance voltage, Setup 1, N phase

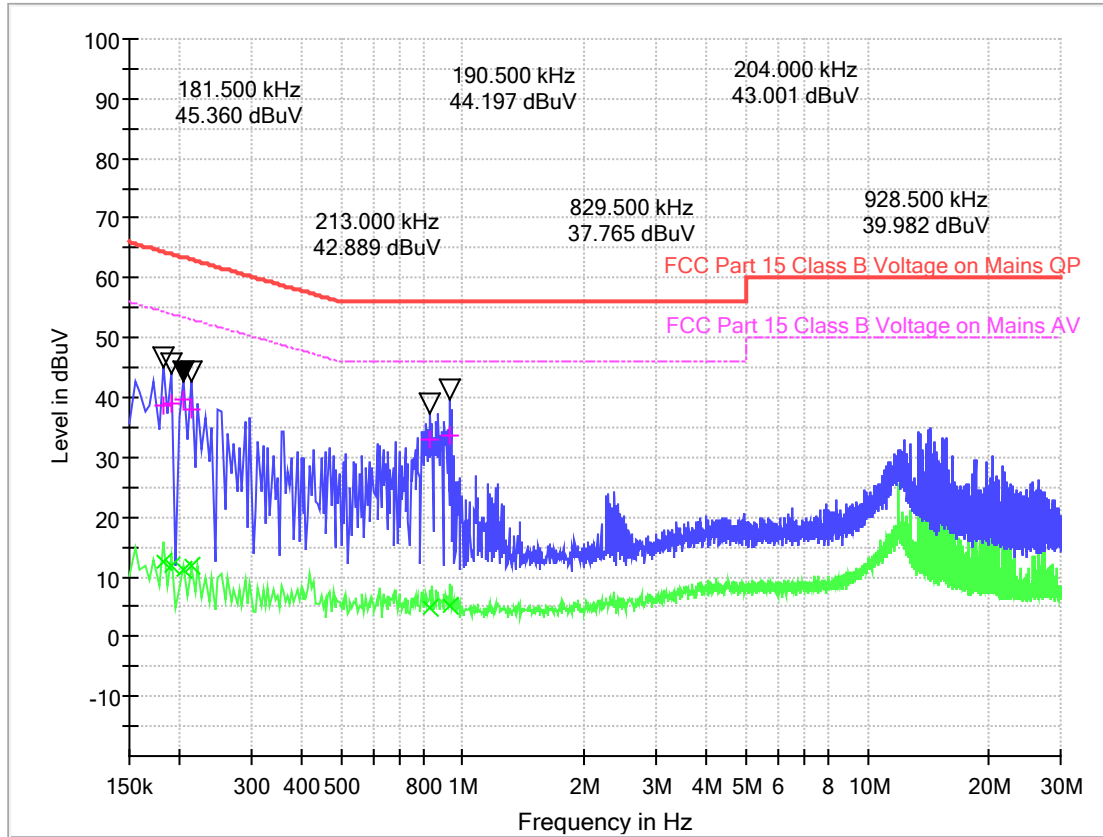

(Plot B: N Phase)

Frequency (MHz)	Quasi Peak	Average (dB μ V)	Cable Loss (dB)	Corr. (dB)	Margin - QPK	Limit - QPK	Margin - AV	Limit - AV (dB μ V)
0.181500	38.52	12.68	0.1	10.1	25.90	64.4	41.74	54.4
0.190500	39.01	11.93	0.1	10.1	25.00	64.0	42.08	54.0
0.204000	39.63	11.28	0.1	10.1	23.82	63.4	42.17	53.4
0.213000	37.85	11.68	0.1	10.1	25.24	63.1	41.41	53.1
0.829500	32.95	4.84	0.1	10.1	23.05	56.0	41.16	46.0
0.928500	33.48	5.10	0.2	10.2	22.52	56.0	40.90	46.0

Test Result: PASS

5. RADIATED EMISSION

5.1.1 Radiated Emission Limits

- (a) ISM equipment operation on a frequency specified in §18.301 is permitted unlimited radiated energy in the band specified for that frequency.
- (b) The field strength levels of emissions which lie outside the bands specified in §18.301, unless otherwise indicated, shall not exceed the following:

RF Power generated by equipment(watts)	Field strength limit(uV/m) @300m
Below 500	25
500or more	$25 * \text{SQRT}(\text{power}/500)$

Power =939.0W

Limit= $20\lg(25 * \text{SQRT}(\text{power}/500)) + 20\lg(300/3)$ @ 3m distance.

5.1.2 Test Setup

For radiated emissions from 30MHz to1GHz

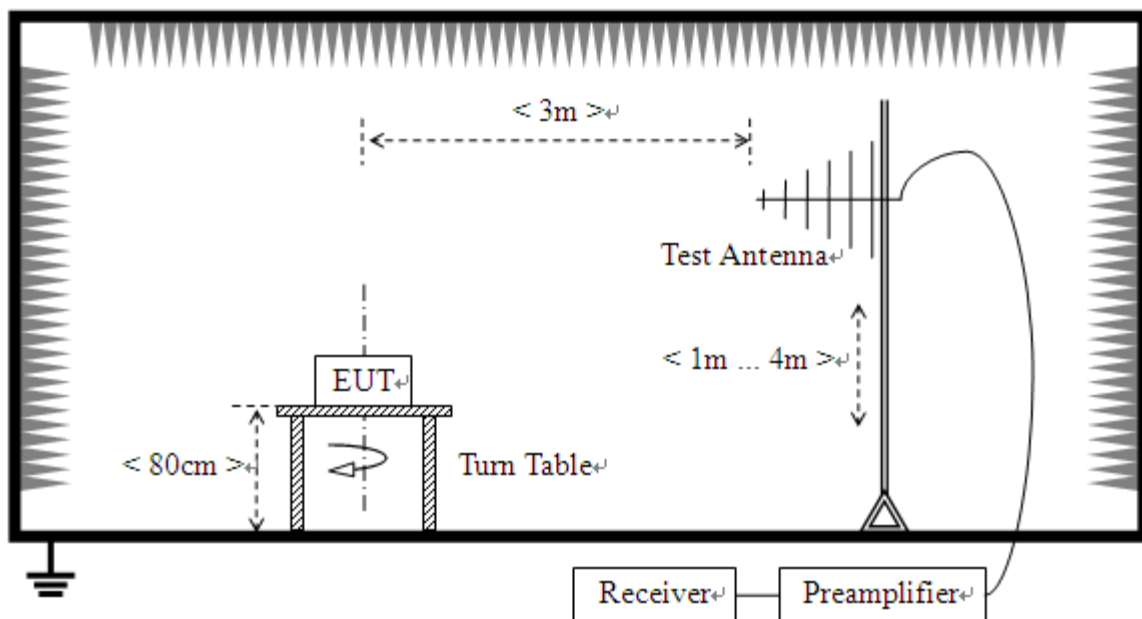

For radiated emissions above 1GHz

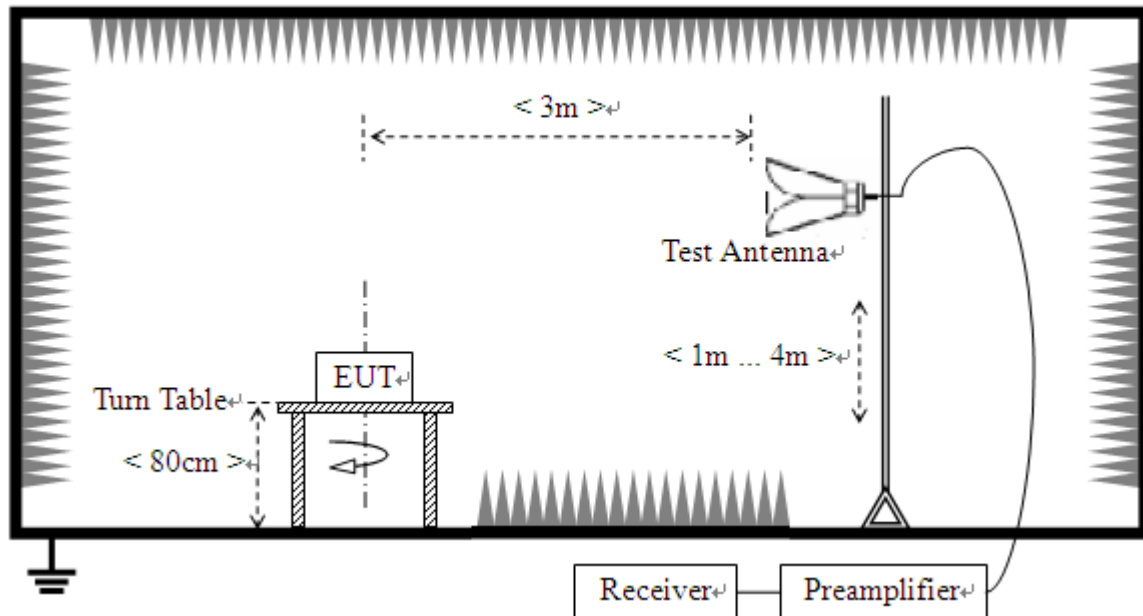

5.1.3 Test Procedure

- The measuring distance of at 3 m shall be used for measurements at frequency up to 1GHz. For frequencies above 1GHz, any suitable measuring distance may be used.
- The EUT was placed on the top of a rotating table 0.8 meters above the ground at a 3 meter open area test site. The table was rotated 360 degrees to determine the position of the highest radiation.
- The height of the equipment or of the substitution antenna shall be 0.8 m; the height of the test antenna shall vary between 1 m to 4 m. Both horizontal and vertical polarizations of the antenna are set to make the measurement
- The initial step in collecting conducted emission data is a spectrum analyzer peak detector mode pre-scanning the measurement frequency range. Significant peaks are then marked and then Quasi Peak detector mode re-measured.
- If the Peak Mode measured value compliance with and lower than Quasi Peak Mode Limit, the EUT shall be deemed to meet QP Limits and then no additional QP Mode measurement performed.
- For the actual test configuration, please refer to the related Item –EUT Test Photos.

Note: Both horizontal and vertical antenna polarities were tested and performed pretest to three orthogonal axis. The worst case emissions were reported

Test Result:

Radiation disturbances, antenna polarization: Setup1, Horizontal

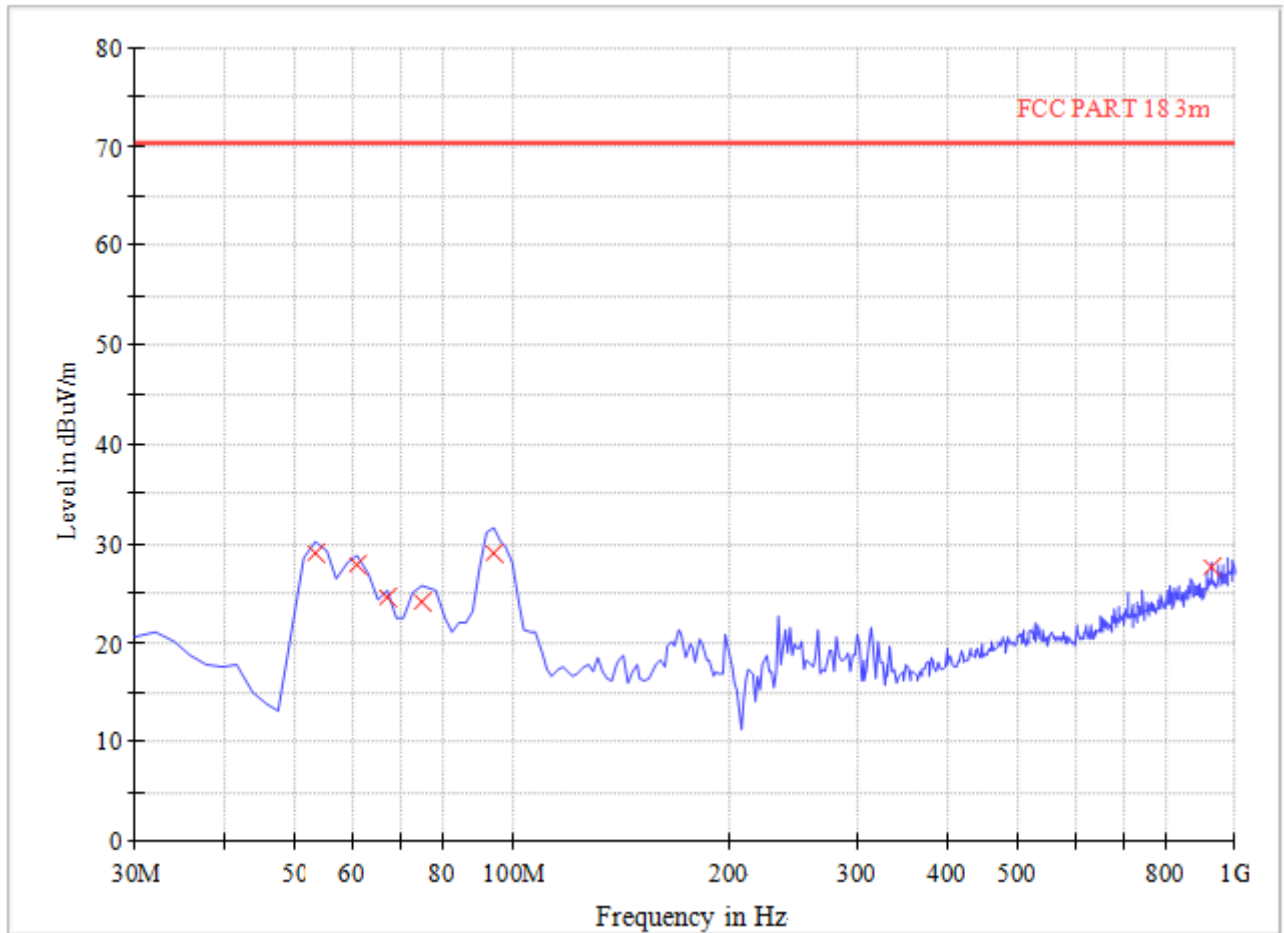

(Plot A: Test Antenna Horizontal 30M - 1G)

Frequency (MHz)	Quasi Peak (dB μ V/m)	Bandwidth (kHz)	Antenna height (cm)	Limit (dB μ V/m)	Margin (dB)	Antenna	Verdict
53.32	29.03	120.000	100.0	70.70	41.67	Horizontal	Pass
61.12	27.86	120.000	100.0	70.70	42.84	Horizontal	Pass
66.92	24.63	120.000	100.0	70.70	46.07	Horizontal	Pass
74.72	24.13	120.000	100.0	70.70	46.57	Horizontal	Pass
94.16	29.04	120.000	100.0	70.70	41.66	Horizontal	Pass
930.04	27.71	120.000	100.0	70.70	42.99	Horizontal	Pass



Radiation disturbances, antenna polarization: Setup1, Vertical

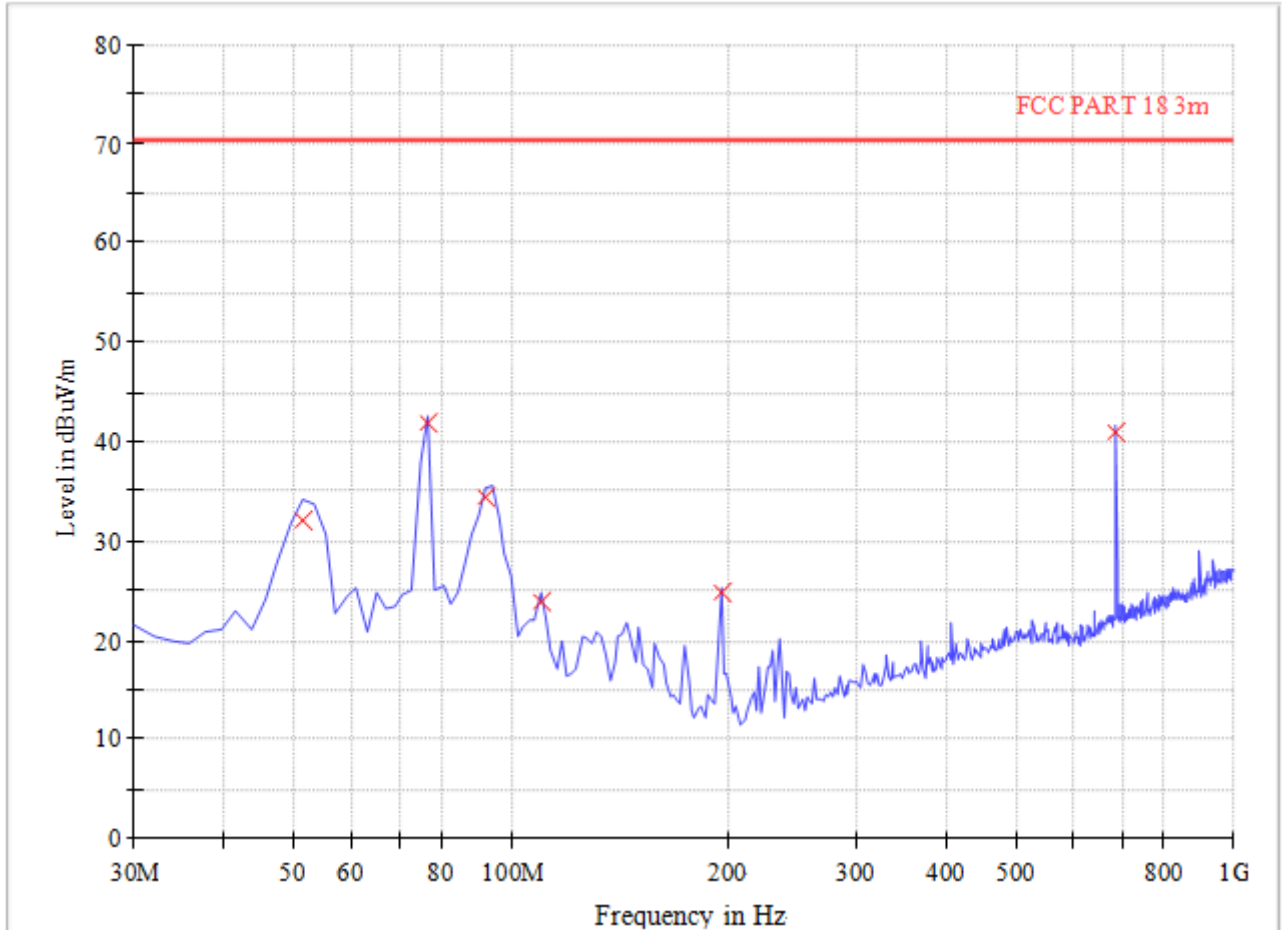

(Plot B: Test Antenna Vertical 30M - 1G)

Frequency (MHz)	Quasi Peak (dB μ V/m)	Bandwidth (kHz)	Antenna height (cm)	Limit (dB μ V/m)	Margin (dB)	Antenna	Verdict
51.40	32.06	120.000	100.0	70.70	38.64	Vertical	Pass
76.64	41.80	120.000	100.0	70.70	28.90	Vertical	Pass
92.20	34.41	120.000	100.0	70.70	36.29	Vertical	Pass
109.68	23.77	120.000	100.0	70.70	46.93	Vertical	Pass
195.24	24.74	120.000	100.0	70.70	45.96	Vertical	Pass
687.04	40.92	120.000	100.0	70.70	29.78	Vertical	Pass

**Above 1GHz, Setup1**

NO.	Freq. [MHz]	Level [dB μ V/m]	Factor [dB]	Limit [dB μ V/m]	Margin [dB]	Height [cm]	Angle [°]	Polarity
1	1722.68	61.95	-13.12	70.70	8.75	100	205	Vertical
2	2122.28	42.71	-11.74	70.70	27.99	100	339	Vertical
3	2432.61	64.66	-10.75	70.70	6.04	100	273	Vertical
4	5786.70	50.78	-1.08	70.70	19.92	100	79	Vertical
5	10802.95	54.43	5.50	70.70	16.27	100	336	Vertical
6	14059.26	58.44	8.65	70.70	12.26	100	323	Vertical

NO.	Freq. [MHz]	Level [dB μ V/m]	Factor [dB]	Limit [dB μ V/m]	Margin [dB]	Height [cm]	Angle [°]	Polarity
1	1760.94	53.74	-13.18	70.70	16.96	100	31	Horizontal
2	2432.61	63.18	-10.75	70.70	7.52	100	9	Horizontal
3	2568.64	58.00	-10.39	70.70	12.70	100	65	Horizontal
4	5195.80	49.93	-2.31	70.70	20.77	100	218	Horizontal
5	5761.19	53.59	-1.07	70.70	17.11	100	61	Horizontal
6	8877.22	56.79	3.81	70.70	13.91	100	1	Horizontal

APPENDIX I: PHOTOGRAPHS OF EMC TEST CONFIGURATION

1. Radiated Emission Measurement below 1GHz

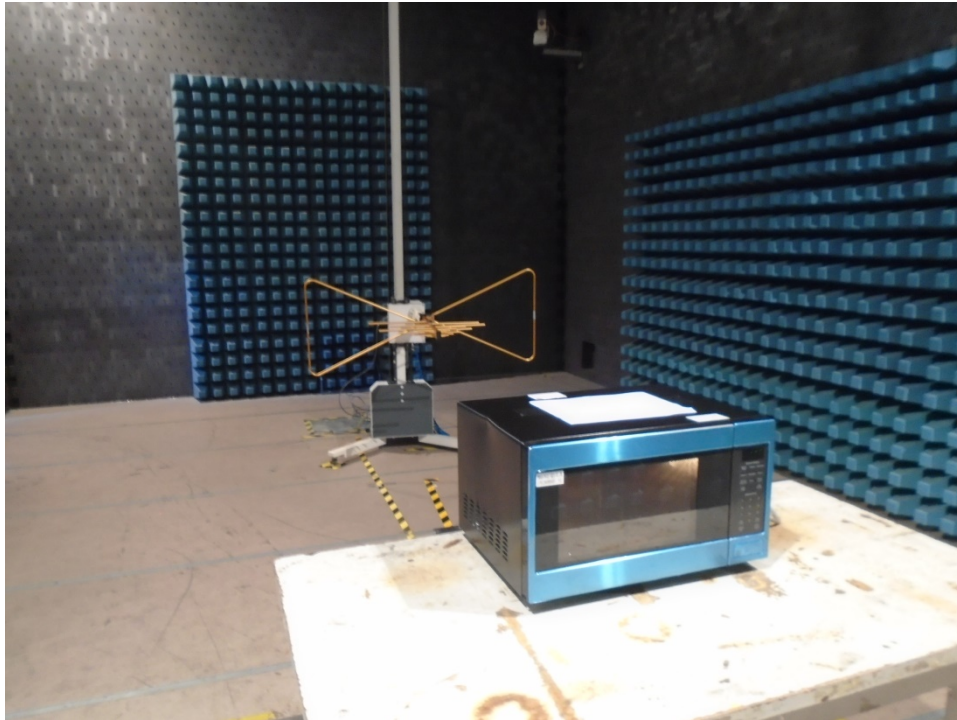

2. Radiated Emission Measurement above 1GHz

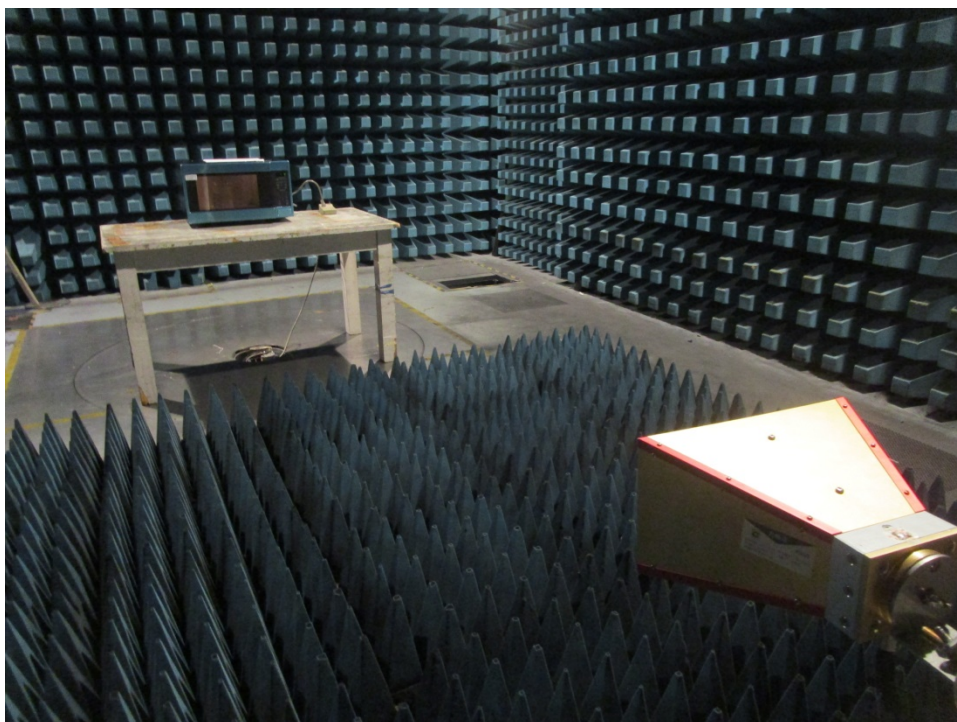

3. Conducted emission at AC mains input/output port Measurement

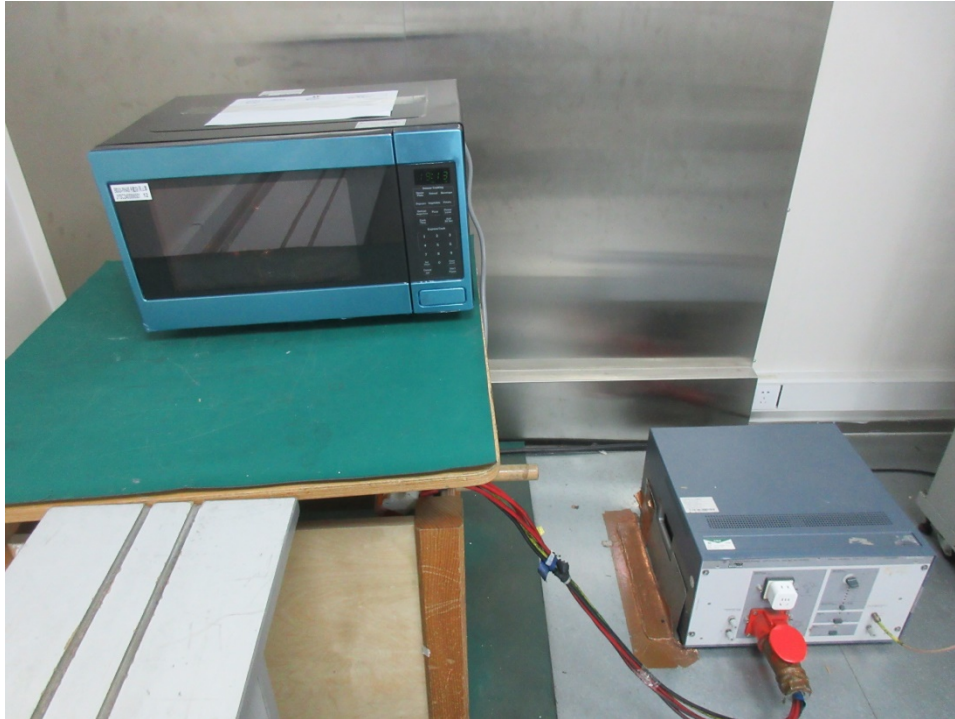

4. Radiation Hazard Test





APPENDIX II: PHOTOGRAPHS OF PRODUCT PHOTO

External Photo







Internal Photo



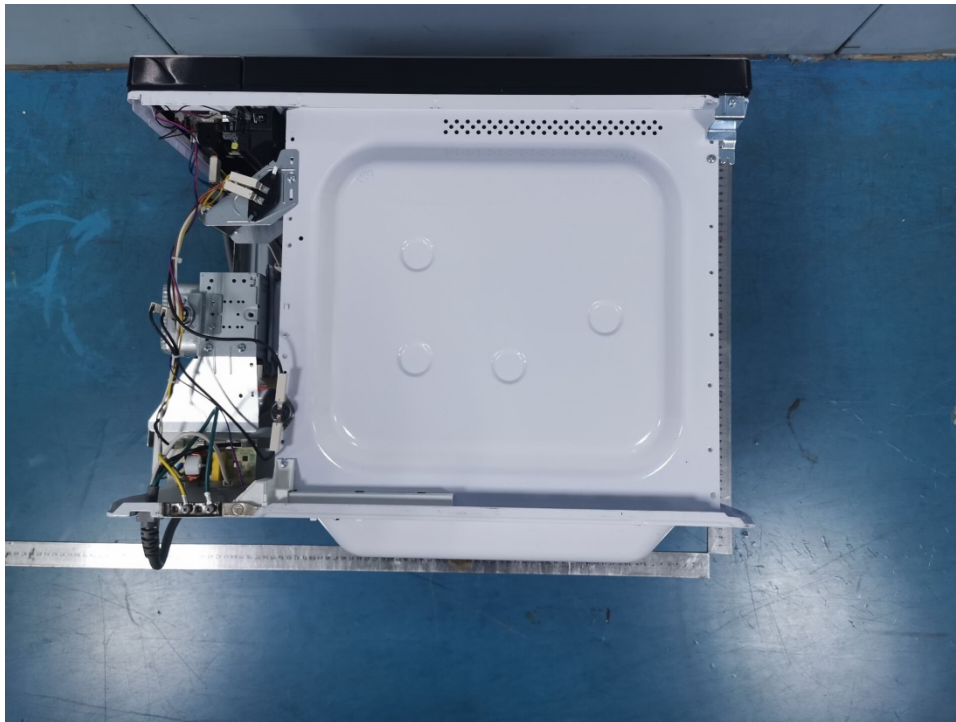

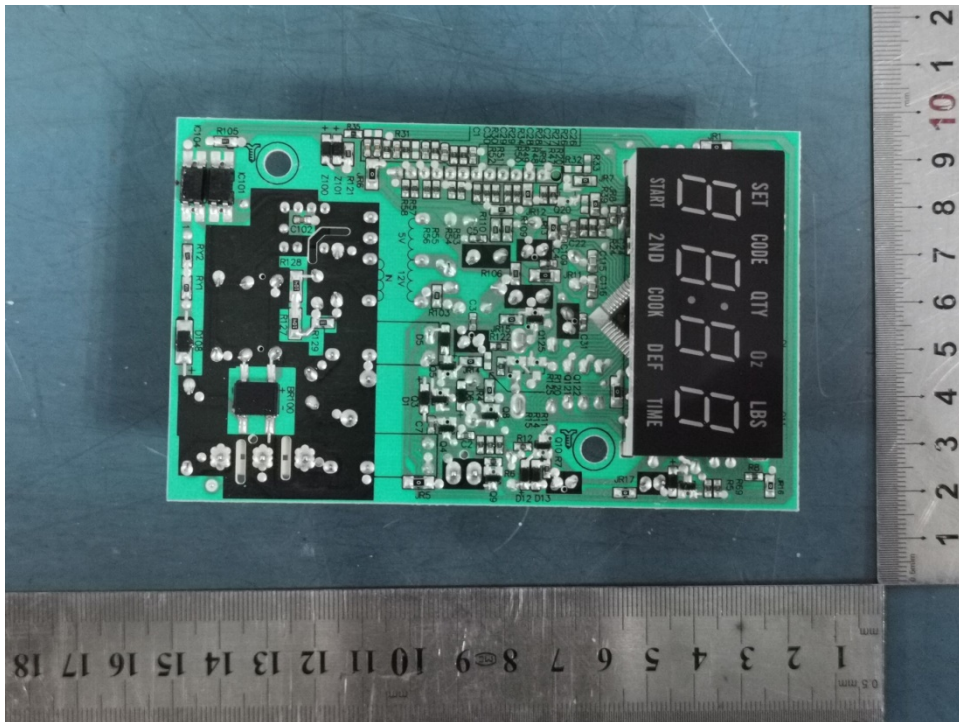
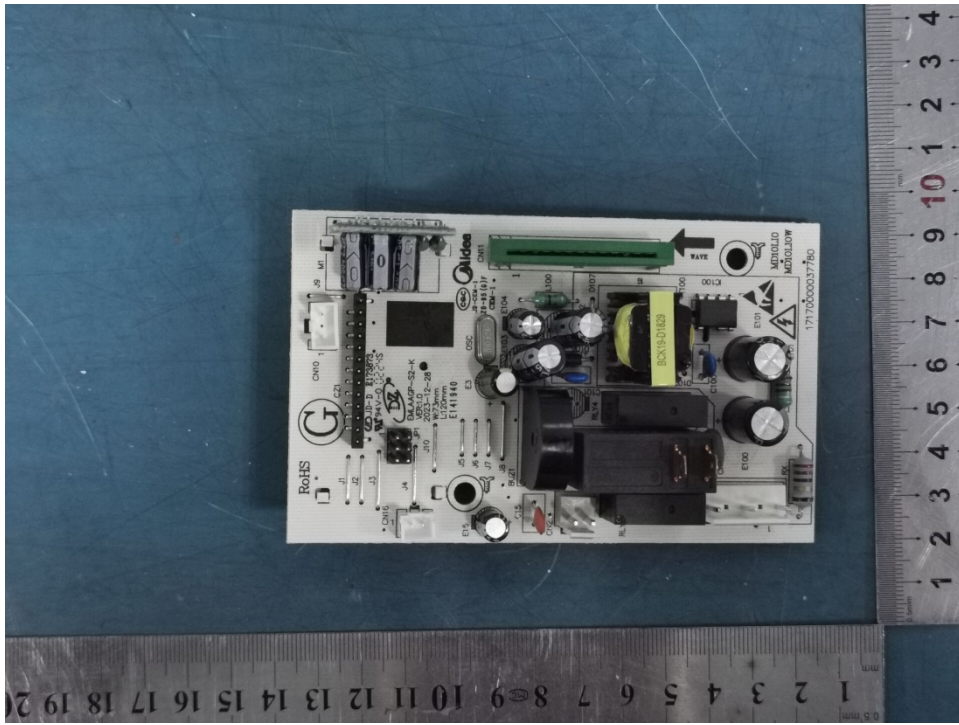

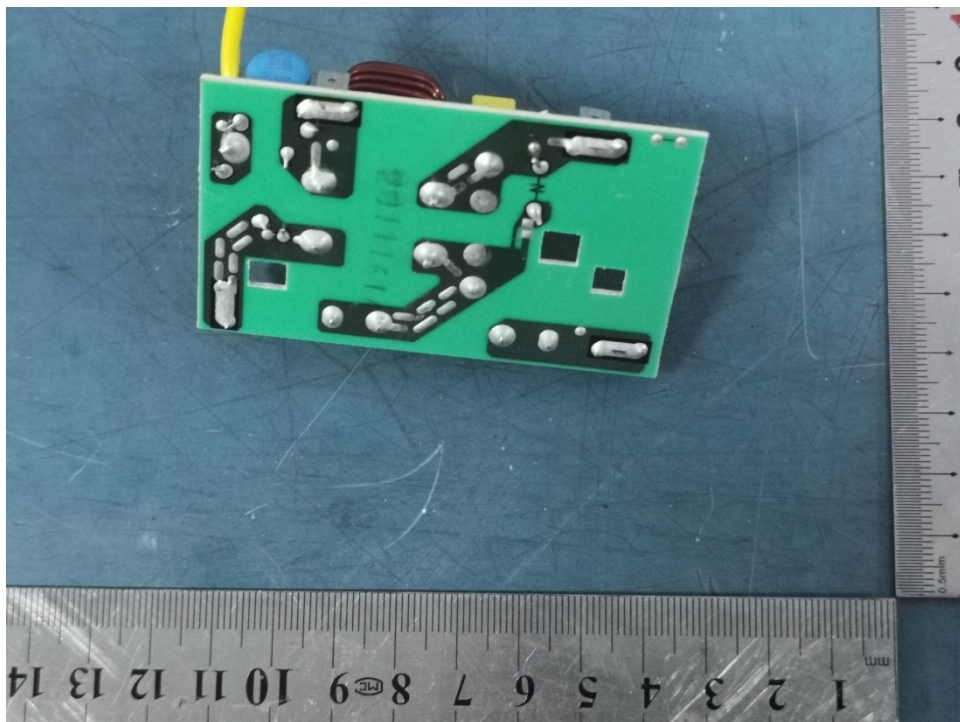
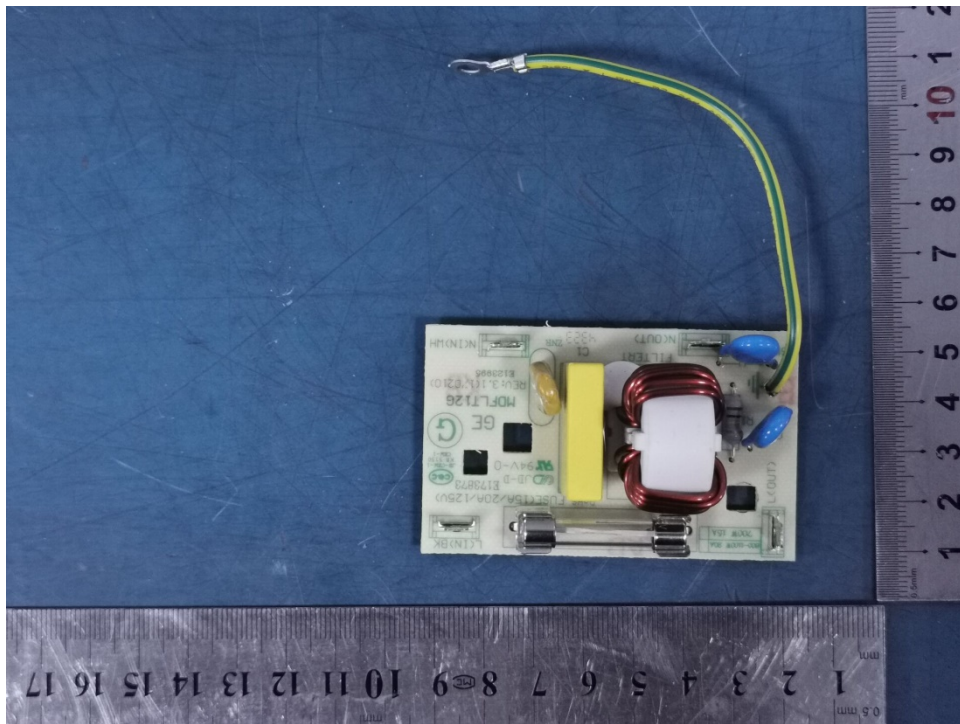

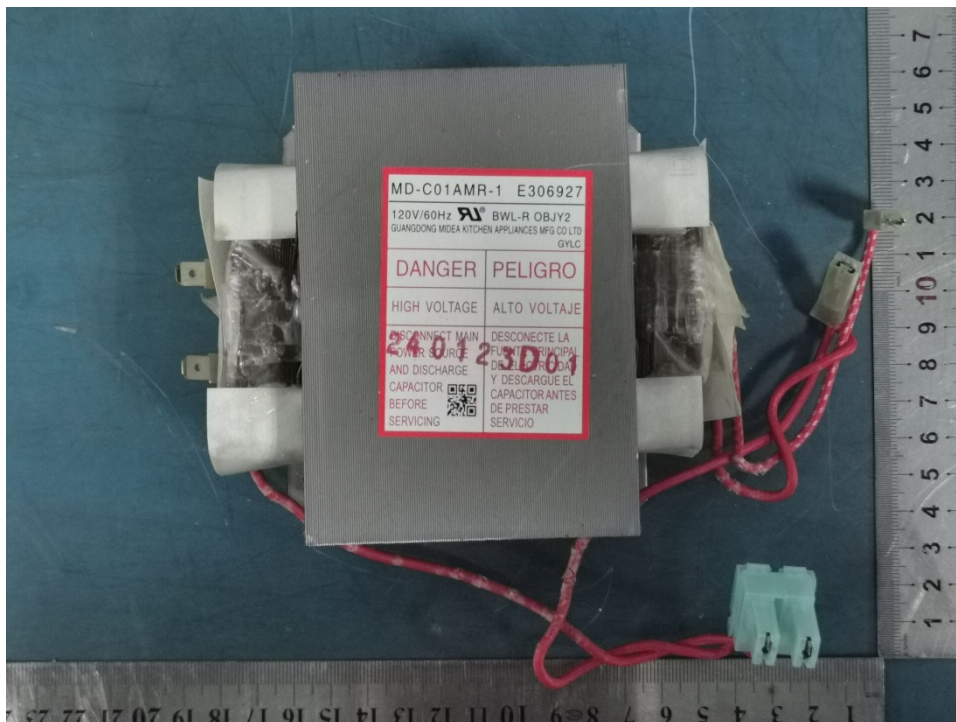

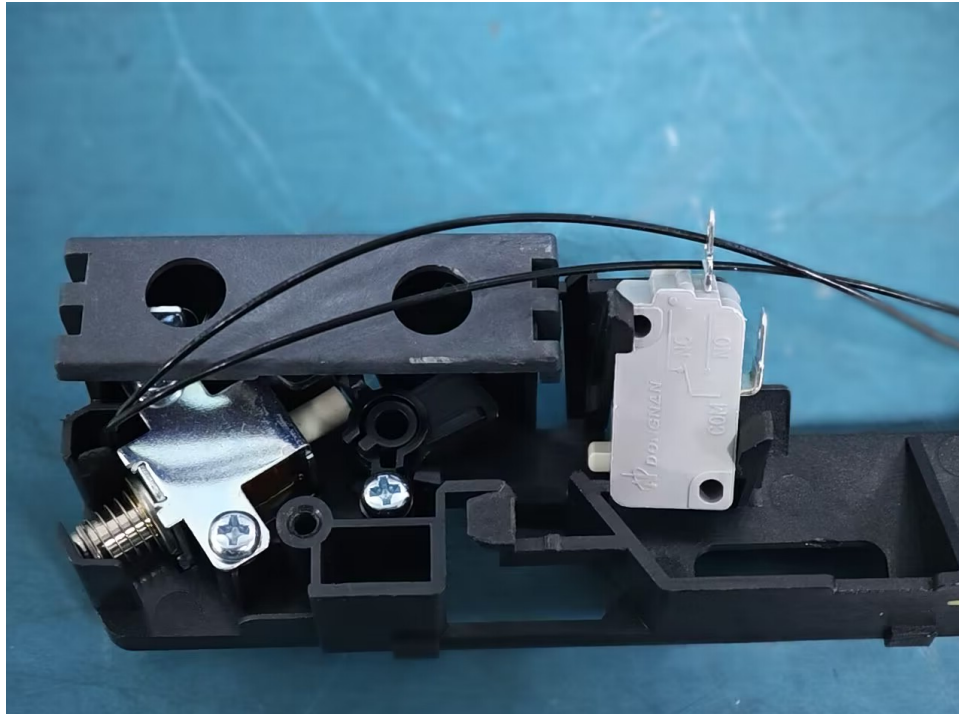
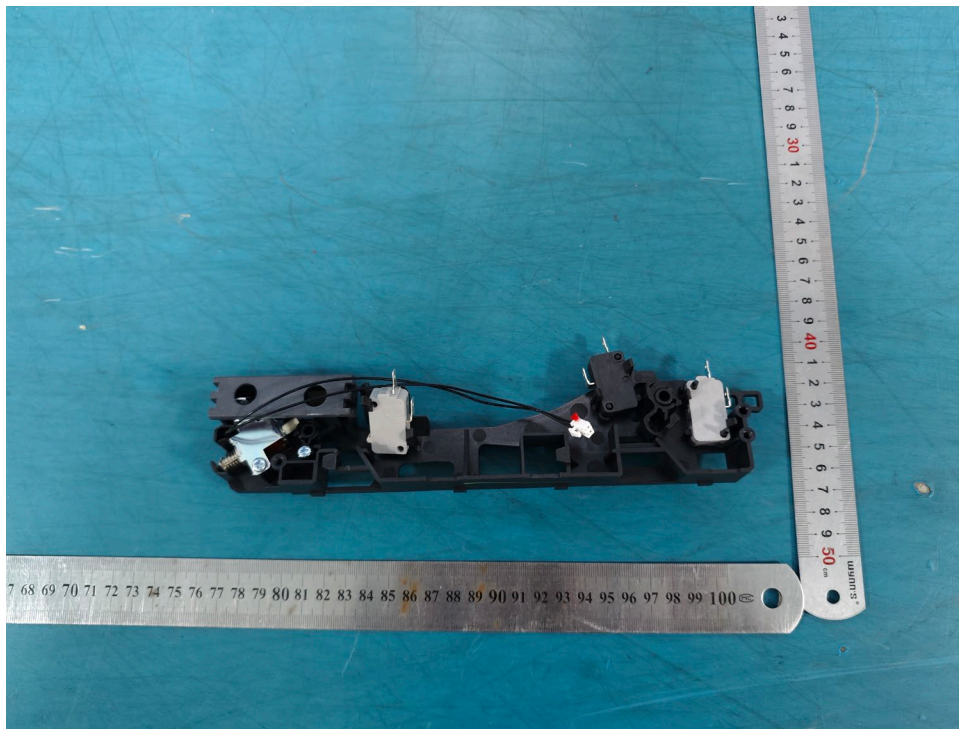

*** End of Report ***