

Microwave Convection Oven Instruction



TOSHIBA

PRECAUTIONS TO AVOID POSSIBLE EXPOSURE TO EXCESSIVE MICROWAVE ENERGY

- (a) Do not attempt to operate this oven with the door open since open door operation can result in harmful exposure to microwave energy.
It is important not to defeat or tamper with the safety interlocks.
- (b) Do not place any object between the oven front face and the door or allows soil or cleaner residue to accumulate on sealing surfaces.
- (c) Do not operate the oven if it is damaged. It is particularly important that the oven door close properly and that there is no damage to the:
 - (1) DOOR (bent)
 - (2) HINGES AND LATCHES (broken or loosened)
 - (3) DOOR SEALS AND SEALING SURFACES
- (d) The oven should not be adjusted or repaired by anyone except properly qualified service personnel.

RF exposure considerations

This equipment complies with FCC radiation exposure limits set forth for an uncontrolled environment. This equipment should be installed and operated with minimum distance 20cm between the radiator & your body. If the device built into a host as a portable usage, the additional RF exposure evaluation may be required.

Specifications

Rated Voltage:	120V~60Hz
Rated Input Power(Microwave):	1500W
Rated Output Power(Microwave):	1100 W
Oven Capacity:	1.3 cu.ft.
Turntable Diameter:	Ø12.4inch
External Dimensions:	20.4 x 16.6 x 12.4inch
Net Weight:	Approx. 35.05lbs

IMPORTANT SAFETY INSTRUCTIONS

When using electrical appliances basic safety precautions should be followed, including the following:

WARNING - To reduce the risk of burns, electric shock, fire, injury to persons or exposure to excessive microwave energy:

1. Read all instructions before using the appliance.
2. Read and follow the specific: "PRECAUTIONS TO AVOID POSSIBLE EXPOSURE TO EXCESSIVE MICROWAVE ENERGY" found on page 2.
3. This appliance must be grounded. Connect only to properly grounded outlet. See "GROUNDING INSTRUCTIONS" found on page 4.
4. Install or locate this appliance only in accordance with the provided installation instructions.
5. Some products such as whole eggs and sealed containers - for example, closed glass jars - are able to explode and should not be heated in this oven.
6. Use this appliance only for its intended use as described in the manual. Do not use corrosive chemicals or vapors in this appliance. This type of oven is specifically designed to heat, cook or dry food. It is not designed for industrial or laboratory use.
7. As with any appliance, close supervision is necessary when used by children.
8. Do not operate this appliance if it has a damaged cord or plug, if it is not working properly, or if it has been damaged or dropped.
9. This appliance should be serviced only by qualified service personnel. Contact nearest authorized service facility for examination, repair, or adjustment.
10. Do not cover or block any openings on the appliance.
11. Do not store this appliance outdoors. Do not use this product near water - for example, near a kitchen sink, in a wet basement, near a swimming pool, or similar location.
12. Do not immerse cord or plug in water.
13. Keep cord away from heated surface.
14. Do not let cord hang over edge of table or counter.
15. When cleaning surfaces of door and oven that comes together on closing the door, use only mild, nonabrasive soaps, or detergent applied with a sponge or soft cloth.
16. To reduce the risk of fire in the oven cavity:
 - (1). Do not overcook food. Carefully attend appliance when paper, plastic, or other combustible materials are placed inside the oven to facilitate cooking.
 - (2). Remove wire twist-ties from paper or plastic bag before placing bag in oven.
 - (3). If material inside of the oven ignite, keep oven door closed, turn oven off, and disconnect the power cord, or shut off power at the fuse or circuit breaker panel.
 - (4). Do not use the cavity for storage purposes. Do not leave paper products, cooking utensils, or food in the cavity when not in use.
17. Liquids, such as water, coffee, or tea are able to be overheated beyond the boiling point without appearing to be boiling. Visible bubbling or boiling when the container is removed from the microwave oven is not always present.

This device complies with Part 18 of the FCC Rules.

THIS COULD RESULT IN VERY HOT LIQUID SUDDENLY BOILING OVER WHEN THE CONTAINER IS DISTURBED OR A UTENSIL IS INSERTED INTO THE LIQUID.

To reduce the risk of injury to persons:

- (1) Do not overheat the liquid.
- (2) Stir the liquid both before and halfway through heating it.
- (3) Do not use straight-sided containers with narrow necks.
- (4) After heating, allow the container to stand in the microwave oven for a short time before removing the container.
- (5) Use extreme care when inserting a spoon or other utensil into the container.

SAVE THESE INSTRUCTIONS

GROUNDING INSTRUCTIONS

This appliance must be grounded. In the event of an electrical short circuit, grounding reduces the risk of electric shock by providing an escape wire for the electric current. This appliance is equipped with a cord having a grounding wire with a grounding plug. The plug must be plugged into an outlet that is properly installed and grounded.

WARNING - Improper use of the grounding can result in a risk of electric shock.

Consult a qualified electrician or serviceman if the grounding instructions are not completely understood, or if doubt exists as to whether the appliance is properly grounded. If it is necessary to use an extension cord, use only a 3-wire extension cord that has a 3-blade grounded plug, and 3-slot receptacle that will accept the plug on the appliance. The marked rating of the extension cord shall be equal to or greater than the electrical rating of the appliance.

DANGER - Electric Shock Hazard

Touching some of the internal components can cause serious personal injury or death. Do not disassemble this appliance.

WARNING - Electric Shock Hazard

Improper use of the grounding can result in electric shock. Do not plug into an outlet until appliance is properly installed and grounded.

1. A short power-supply cord is provided to reduce the risks resulting from becoming entangled in or tripping over a longer cord.
2. Longer cord sets or extension cords are available and may be used if care is exercised in their use.
3. If a long cord or extension cord is used:
 - (1) The marked electrical rating of the cord set or extension cord should be at least as great as the electrical rating of the appliance.
 - (2) The extension cord must be a grounding-type 3-wire cord.
 - (3) The longer cord should be arranged so that it will not drape over the counter top or tabletop where it can be pulled on by children or tripped over unintentionally.

RADIO INTERFERENCE

1. Operation of the microwave oven may cause interference to your radio, TV or similar equipment.
2. When there is interference, it may be reduced or eliminated by taking the following measures:
 - 1) Clean door and sealing surface of the oven
 - 2) Reorient the receiving antenna of radio or television.
 - 3) Relocate the microwave oven with respect to the receiver.
 - 4) Move the microwave oven away from the receiver.
 - 5) Plug the microwave oven into a different outlet so that microwave oven and receiver are on different branch circuits.

UTENSILS

CAUTION - Personal Injury Hazard

Tightly-closed utensils could explode. Closed containers should be opened and plastic pouches should be pierced before cooking.

See the instructions on "Materials you can use in microwave oven or to be avoided in microwave oven."

There may be certain non-metallic utensils that are not safe to use for microwaving. If in doubt, you can test the utensil in question following the procedure below.

Utensil Test:

1. Fill a microwave-safe container with 1 cup of cold water (250ml) along with the utensil in question.
2. Cook on maximum power for 1 minute.
3. Carefully feel the utensil. If the empty utensil is warm, do not use it for microwave cooking.
4. Do not exceed 1 minute cooking time.

Materials you can use in microwave oven

Utensils	Remarks
Browning dish	Follow manufacturer's instructions. The bottom of browning dish must be at least 3/16 inch (5mm) above the turntable. Incorrect usage may cause the turntable to break.
Dinnerware	Microwave-safe only. Follow manufacturer's instructions. Do not use cracked or chipped dishes.
Glass jars	Always remove lid. Use only to heat food until just warm. Most glass jars are not heat resistant and may break.
Glassware	Heat-resistant oven glassware only. Make sure there is no metallic trim. Do not use cracked or chipped dishes.
Oven cooking bags	Follow manufacturer's instructions. Do not close with metal tie. Make slits to allow steam to escape.
Paper plates and cups	Use for short-term cooking/warming only. Do not leave oven unattended while cooking.
Paper towels	Use to cover food for reheating and absorbing fat. Use with supervision for a short-term cooking only.
Parchment paper	Use as a cover to prevent splattering or a wrap for steaming.
Plastic	Microwave-safe only. Follow the manufacturer's instructions. Should be labeled "Microwave Safe". Some plastic containers soften, as the food inside gets hot. "Boiling bags" and tightly closed plastic bags should be slit, pierced or vented as directed by package.
Plastic wrap	Microwave-safe only. Use to cover food during cooking to retain moisture. Do not allow plastic wrap to touch food.
Thermometers	Microwave-safe only (meat and candy thermometers).
Wax paper	Use as a cover to prevent splattering and retain moisture.

Materials to be avoided in microwave oven

Utensils	Remarks
Aluminum tray	May cause arcing. Transfer food into microwave-safe dish.
Food carton with metal handle	May cause arcing. Transfer food into microwave-safe dish.
Metal or metal-trimmed utensils	Metal shields the food from microwave energy. Metal trim may cause arcing.
Metal twist ties	May cause arcing and could cause a fire in the oven.
Paper bags	May cause a fire in the oven.
Plastic foam	Plastic foam may melt or contaminate the liquid inside when exposed to high temperature.
Wood	Wood will dry out when used in the microwave oven and may split or crack.

SETTING UP YOUR OVEN

Names of Oven Parts and Accessories

Remove the oven and all materials from the carton and oven cavity.

Your oven comes with the following accessories:

Glass tray	1
Turntable ring assembly	1
Instruction Manual	1

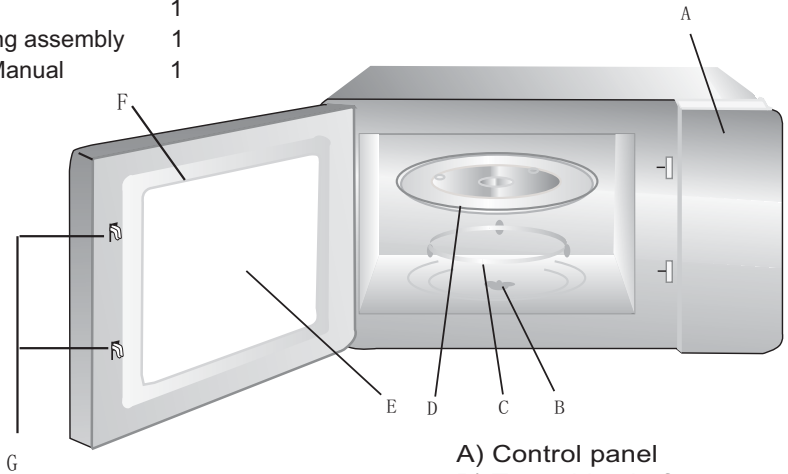

- A) Control panel
- B) Turntable shaft
- C) Turntable ring assembly
- D) Glass tray
- E) Observation window
- F) Door assembly
- G) Safety interlock system

Turntable Installation

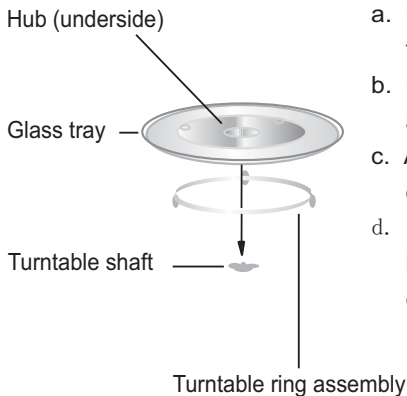

- a. Never place the glass tray upside down. The glass tray should never be restricted.
- b. Both glass tray and turntable ring assembly must always be used during cooking.
- c. All food and containers of food are always placed on the glass tray for cooking.
- d. If glass tray or turntable ring assembly cracks or breaks, contact your nearest authorized service center.

Countertop Installation

Remove all packing material and accessories. Examine the oven for any damage such as dents or broken door. Do not install if oven is damaged.

Cabinet : Remove any protective film found on the microwave oven cabinet surface. Do not remove the light brown Mica cover that is attached to the oven cavity to protect the magnetron.

Installation

1. Select a level surface that provide enough open space for the intake and/or outlet vents.

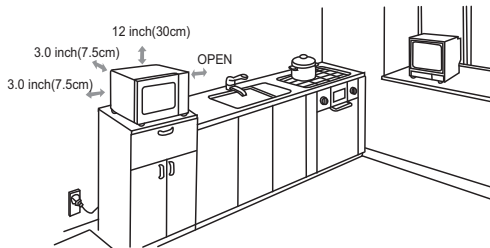

A minimum clearance of 3.0 inches (7.5cm) is required between the oven and any adjacent walls. One side must be open.

- (1) Leave a minimum clearance of 12 inches (30cm) above the oven.
- (2) Do not remove the legs from the bottom of the oven.

- (3) Blocking the intake and/or outlet openings can damage the oven.
 - (4) Place the oven as far away from radios and TV as possible. Operation of microwave oven may cause interference to your radio or TV reception.
2. Plug your oven into a standard household outlet. Be sure the voltage and the frequency is the same as the voltage and the frequency on the rating label.

WARNING: Do not install oven over a range cooktop or other heat-producing appliance. If installed near or over a heat source, the oven could be damaged and the warranty would be void.

Setting up Alexa on your microwave oven

Your microwave oven can be controlled with Alexa by using any Alexa-enabled device such as Echo or Echo Dot. To control your microwave oven using Alexa, you'll need to set up your microwave and connect to Alexa. To do so

1. Download the latest version of the Alexa App and "MSmartLife" App from the app store or Google Play.
2. Plug the microwave oven into a power outlet that is grounded.
3. Add devices in "MSmartLife" App (Refer to MSmartLife App Instruction)
 - 1) Click 【+】 on the APP card page.
Note: Before adding a new device, make sure the microwave is powered.
 - 2) Enter the correct WiFi password and click on the next step;
 - 3) Select Add[microwave oven]from the device list, add this model in the selection;
 - 4) According to the operation guidelines, the user needs to perform the corresponding operation confirmation on the device, and click[the next step] after the operation is completed;
 - 5) Waiting for connection, if the connection fails, please follow the APP guidelines for the next operation;
 - 6) Click[finish], the device adds successfully.
4. Set up Echo with Alexa app (Refer to Alexa App Instruction)
Link MSmartLife account to Alexa
 - 1) Tap"Toshiba iMicrowave" in the hamburger menu, then search .Select and tap [ENABLE] to enable the Toshiba iMicrowave.
 - 2) You will be redirected to the account link page.Type in your MSmartLife account and password ,then tap [Login] to link your MSmartLife account.
5. Control your smart devices through Echo
Discover devices
Echo needs to discover your smart devices before it controls them , you can Say"Alexa , discover devices" to Echo. Echo will discover devices which have already been added in the "MSmartLife "App.
you can also tap[DISCOVER] to discover the smart devices.
Control devices by voice commands.

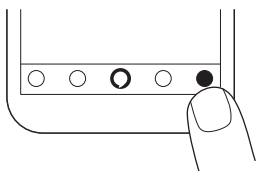

OPERATION

You can use your microwave oven without setting it up for Alexa control. However, we highly recommend using your microwave oven with Alexa control to unlock its full potential.

1. Clock Setting

When the microwave oven is plugged into a outlet, the oven will display " 0:00 "

- (1) Press " CLOCK ", LED will display 00:00, clock indicator will be lighted. The first hour figure will flash; ":" and the other "0" will be lighted.
- (2) Press the number keys and enter the correct time. For example, time is 10:12 now, please press "1,0,1,2" in turn.
- (3) Press " CLOCK " to finish clock setting, and the clock indicator will go out. ":" will flash and the clock will be lighted.
- (4) If the numbers input are not within the range of 1:00--12:59, the setting will be invalid until valid numbers are input.

Note: In the process of clock setting, if the " STOP/CANCEL " button is pressed or if there is no operation within 1 minute, the oven will go back to the former state automatically.

2. Kitchen Timer

- (1) Press " TIMER ", LED will display 00:00, clock indicator will be lighted.
- (2) Press the number keys and enter the correct timer. (The maximum time is 99 minutes and 99 seconds). If it exceeds the range, it does not respond to the input and at the same time beeps two hints.
- (3) Press " START/+30SEC " to confirm setting, LED will display the current time by counting down. Clock indicator will flash.
- (4) When the kitchen time arrives, clock indicator will go out. The buzzer will ring one time.
- (5) At the end of cooking, the bee rings and returns to standby status.

Note: Kitchen Timer is a timer.

That is to say it processes the function of alarming clock.

3. Microwave cook

- (1) Press " COOK TIME " twice, LED will always bright display "00:00". microwave indicator will be lighted.
- (2) Press number keys to input the cooking time; the maximum cooking time is 99 minutes and 99 seconds.

(3) Press " POWER LEVEL " once, LED will display "PL10". The default power is 100% power. Now you can press 0-10 number keys to adjust the power level. eleven power levels are available.

Level	10	9	8	7	6	5	4	3	2	1	0
Power	100%	90%	80%	70%	60%	50%	40%	30%	20%	10%	0%
Display	PL10	PL9	PL8	PL7	PL6	PL5	PL4	PL3	PL2	PL1	PL0

(4) Press " START/+30SEC. " to start cooking. microwave indicator will flash.

(5) At the end of cooking, the bee rings and returns to standby status.

Example: to cook the food with 50% microwave power for 15 minutes.

a. Press "COOK TIME " once."00:00" displays.

b.Press "1","5","0","0" in order.

c.Press "POWER LEVEL "once,then press "5" to select 50% microwave power.

d.Press "START/+30SEC. " to start cooking.

Note: In the process of cooking, if the " STOP/CANCEL " button is pressed or if there is no operation within 1 minutes, the oven will go back to the former setting automatically.

Cook by time

"Alexa, microwave for X."

To cook by time, say "Alexa, microwave for X", where X is the amount of time you'd like to cook for.

For example, to cook for 5 minutes, say "Alexa, microwave for 5 minutes" Or, to cook for 2 minutes and 39 seconds, say "Alexa, microwave for 2 minutes and 39 seconds"

"Alexa, add X to the microwave."

When your microwave is in use, you can ask it to cook for additional time by saying, "Alexa, add X to the microwave" where X is the amount of time you'd like to add. For example, to add 2 minutes to the cooking time while the microwave is already running, say "Alexa, add 2 minutes to the microwave."

Cook by power level

"Alexa, microwave for X on power Y."

By default, your microwave oven will cook at Power 10 (maximum power). To cook at a specific power, say "Alexa, microwave for X on power Y," where X is the amount of time you'd like to cook for and Y is the power level.

For example, to cook at power 5 for 3 minutes, say "Alexa, microwave for 3 minutes on power 5."

You can also ask your microwave oven to cook at high, medium, or low power. For example, to cook on medium power for 5 minutes, say "Alexa, microwave for 5 minutes on medium."

4. Speedy Cooking

- (1) In waiting state, instant cooking at 100% power level can be started by select a cooking time from 1 to 6 minutes by pressing number pads 1 to 6. Press " START/+30SEC. " to increase the cooking time; The maximum cooking time is 99 minutes and 99 seconds.
- (2) In waiting state, instant cooking at 100% power level with 30 seconds' cooking time can be started by pressing " START/+30SEC. ". Each press on the same button will increase cooking time by 30 seconds. The maximum cooking time is 99 minutes and 99 seconds.
- (3) Press " COOK TIME " first and adjust cooking time, then press "START/+30SEC. " to start cooking with full microwave power.
- (4) At the end of cooking, the bee rings and returns to standby status.

Note:(1) Under microwave, time defrost and popcorn states, press " START/+30SEC. " button to increase cooking time by 30 seconds.

- (2) Under sensor menu cooking and weight defrost state, time cannot be added by pressing " START/+30SEC. " button.

5. Weight Defrost Function

- (1) Press " WEIGHT DEFROST ", LED will display "dEF1". Thawing by species indicator will be lighted.
- (2) Press numerical buttons to input weight to be defrosted.
Input the weight ranged should be between 4~70 Oz
- (3) If the weight input is not within 4~70Oz, the input will be invalid.
- (4) Press "START/+30SEC." to start defrosting and LED countdown display cooking time.
- (5) At the end of cooking, the bee rings and returns to standby status.

"Alexa, defrost X (pounds, ounces, or grams)."

To defrost a specific quantity of food, say "Alexa, defrost X pounds ." Alternatively, you can specify ounces or grams.

For example, to defrost 1 pound of food, say "Alexa, defrost 1 pound." Your microwave oven will run using the appropriate time and power setting.

6. Time Defrost Function

- (1) Press " TIME DEFROST ", LED will display "dEF2".
- (2) Press numerical buttons to input defrost time to be defrosted.
Input the time ranged is between 0:01~99:99.
- (3) Press " START/+30SEC." to start defrosting. The default microwave power is PL3.
The power cannot be adjusted.
- (4) At the end of cooking, the bee rings and returns to standby status.

“Alexa, defrost for X.”

To defrost food for a specific amount time, say “Alexa, defrost for X ”, where X is the amount of time you’d like to cook for.

For example, to defrost for 10 minutes and 30 seconds, say “Alexa, defrost for 10 minutes and 30 seconds.” Your microwave oven will start defrosting for 10 minutes and 30 seconds.

7.POPCORN

(1) Press " POPCORN " repeatedly until the weight you needed appears in the display, "  " and "Oz" light.

For example, press " POPCORN " twice, "3.2" displays.

(2) Press " START/+30SEC. " to cook, "Oz" disappears, "  " are flashing.

(3) At the end of cooking, the bee rings and returns to standby status.

Times(Press "POPCORN")	Weight	Display
Once	2.75 Oz	2.75
Twice	3.2 Oz	3.2

Popcorn

“Alexa, microwave 1.5 ounces of popcorn.”

To microwave popcorn, say “Alexa, microwave X ounces of popcorn”.Your microwave oven will determine the time to cook your popcorn appropriately.

For example, to microwave oven 2.2 ounces of popcorn, say “Alexa, microwave 2.2 ounces of popcorn .”

8 .POTATO

- (1) Press " POTATO " repeatedly until the Quantity you needed appears in the display , " 1 " , " 2 " , " 3 " , " 4 " , ("2 "means 2 potatoes),When the weight of the LED display is the same as the weight of the food to be cooked, stop pressing the button.
- (2) Press "START/+30SEC" LED countdown display cooking time , "  " are flashing.
- (3) At the end of cooking, the bee rings and returns to standby status.

Times(Press "POTATO ")	Quantity	Display
Once	1	1
Twice	2	2
three times	3	3
four times	4	4

Things to try

"Alexa, microwave the potato"



Alexa: how many do you want to cook?

User: one/two/three/four (potatoes).

Alexa: ok,starting now. / starting potato.

Alexa, microwave 1/2/3/4 potato.

9. Reheat

- (1) Press " Reheat " LED will display "SC-1 " , "  " are light. display, "  " and "Oz" light.
- (2) Press " START/+30SEC. " to cook, LED flashing display "SC-1", humidity sensing menu logo "  " flashing display, waiting for sensing, countdown display remaining cooking time.
- (3) At the end of cooking, the beeping and returns to standby status.

Times(Press "Reheat")	Weight	Display
Once	8.0~16.0 Oz	SC-1

10. Multi-section cooking

At most 2 sections can be set for cooking. In multi-section cooking, if one section is defrosting, then defrosting shall be placed in the first section. When the first stage finish, the buzzer will sound twice and the next stage will begin cooking.

Example: if you want to cook with 80% microwave power for 5 minutes + 60% microwave power for 10 minutes. The cooking steps are as following.

- (1) Press "COOK TIME " once, then press "5","0","0" to set 5 minutes.
- (2) Press "POWER LEVEL " once.
- (3) Press number button "8" to set 80% microwave power.
- (4) Press "COOK TIME " once, then press "1","0","0","0" to set 10 minutes.
- (5) Press "POWER LEVEL " once.
- (6) Then press press number button "6" to set 60% microwave power.
- (7) Press "START/+30SEC." to start cooking.



Note:

- 1) Auto menu and reheat menu cannot be set as one of the multi-section.
- 2). When microwave cooking is the second part of multiple cooking, you must press the cooking clock.

11. INQUIRING FUNCTION

- (1) In cooking state, press " CLOCK ", the clock will displays for three seconds. After that, the oven will turn back to the clock state.
- (2) In the microwave cooking state, press " POWER LEVEL " to inquire microwave power level the current microwave power will be displayed.(No microwave fire can be queried during cooking or thawing of the automatic menu, humidity induction menu). After three seconds, the oven will turn back to the previous state.

12. Lock Function for Children

- (1) Lock: In waiting state, press “ **STOP/Cancel** ” 3 seconds, buzzer will ring once, the oven will enter tee children-lock state, LED will display “  ”, and “  ”light.
- (2) In children-lock state, press “ **STOP/Cancel** ” 3 seconds, buzzer will ring once and the oven will quits the children-lock state.

13. ECO function

- (1) Dump screen: In standby state, press cancel key, buzzer, screen extinguished, enter ECO mode.
- (2) Awakening: In ECO mode, opening the furnace door or pressing any key can awaken the display and enter the standby state; In ECO mode, the first button press is to wake up the display.

14. Mute Function

Press the number key “0” for 3 seconds, there will be a “beep”, the oven will open or close the quitly function.

Note:

In the sound shutdown state, all keys have no sound response. Including the end of the cooking note.

ALEXA: THINGS TO TRY

Bacon	Alexa, microwave 1/2/3/4/5/6 bacon.
Coffee	Alexa, reheat 1/2/3 cup of coffee.
Butter	Alexa, microwave 8/16/24 ounce of butter.
Chocolate	Alexa, microwave 4/8 ounce of chocolate.
Marshmallow	Alexa, microwave 5/10 ounce of marshmallow.
Fish	Alexa, defrost 4~32 ounce of fish.
Meat	Alexa, defrost 4~70 ounce of meat.
Chicken	Alexa, defrost 4~70 ounce of chicken.
Bread	Alexa, defrost 4~24 ounce of fish.
Vegetable	Alexa, defrost 4~32 ounce of vegetables.
Sensor-Reheat (SG1)	Alexa, reheat dinner plate.
Baked Beans (SG2)	Alexa, reheat baked beans.
Scrambled Eggs (SG3)	Alexa, reheat scrambled eggs.
Oatmeal (SG4)	Alexa, reheat oatmeal.
Pizza Reheat (SG5)	Alexa, reheat pizza.
Fish (SG6)	Alexa, reheat fish.
meat (SG7)	Alexa, reheat meat.
Fresh Vegetable (SG8)	Alexa, reheat the fresh vegetable.
Frozen Vegetable (SG9)	Alexa, reheat frozen vegetable.
Frozen Entree (SGA)	Alexa, reheat frozen entree.
Pasta (no cover) (SGb)	Alexa, reheat pasta.

MAINTENANCE

Troubleshooting

Check your problem by using the chart below and try the solutions for each problem. If the microwave oven still does not work properly, contact the nearest authorized service center.

TROUBLE	POSSIBLE CAUSE	POSSIBLE REMEDY
Oven will not start	<ul style="list-style-type: none"> a. Electrical cord for oven is not plugged in. b. Door is open. c. Wrong operation is set. 	<ul style="list-style-type: none"> a. Plug into the outlet. b. Close the door and try again. c. Check instructions.
Arcing or sparking	<ul style="list-style-type: none"> a. Materials to be avoided in microwave oven were used. b. The oven is operated when empty. c. Spilled food remains in the cavity. 	<ul style="list-style-type: none"> a. Use microwave-safe cookware only. b. Do not operate with oven empty. c. Clean cavity with wet towel.
Unevenly cooked foods	<ul style="list-style-type: none"> a. Materials to be avoided in microwave oven were used. b. Food is not defrosted completely. c. Cooking time, power level is not suitable. d. Food is not turned or stirred. 	<ul style="list-style-type: none"> a. Use microwave-safe cookware only. b. Completely defrost food. c. Use correct cooking time, power level. d. Turn or stir food.
Overcooked foods	<ul style="list-style-type: none"> Cooking time, power level is not suitable. 	<ul style="list-style-type: none"> Use correct cooking time, power level.
Undercooked foods	<ul style="list-style-type: none"> a. Materials to be avoided in microwave oven were used. b. Food is not defrosted completely. c. Oven ventilation ports are restricted. d. Cooking time, power level is not suitable. 	<ul style="list-style-type: none"> a. Use microwave-safe cookware only. b. Completely defrost food. c. Check to see that oven ventilation ports are not restricted. d. Use correct cooking time, power level.
Improper defrosting	<ul style="list-style-type: none"> a. Materials to be avoided in microwave oven were used. b. Cooking time, power level is not suitable. c. Food is not turned or stirred. 	<ul style="list-style-type: none"> a. Use microwave-safe cookware only. b. Use correct cooking time, power level. c. Turn or stir food.

ONE YEAR LIMITED WARRANTY

This product carries a warranty stating that it will be free from defects in material and workmanship for a period of one year from the date of purchase. This warranty is valid for the original retail purchaser from the date of initial retail purchase and is not transferable. Keep your original sales receipt.

IMPORTANT:

1. This warranty does not cover damages resulting from accident, misuse or abuse, lack of reasonable care, the affixing of any attachments not provided with the product, loss of parts, or subjecting the appliance to any but the specified voltage. (Read directions carefully.)
2. This warranty is void if this product is ever used for other than private household purposes.
3. This warranty is void if this product is ever used outside of United States.

If service is required during the warranty period, properly pack your unit. We recommend using the original carton and packing materials.

If additional assistance is needed, please contact customer assistance at:

customercare@us.toshiba-lifestyle.com
855-204-5313
Midea America Corp
5 Sylvan Way,
Parsippany, NJ 07054

Midea America Corp. expressly disclaims all responsibility for consequential damages or incidental losses caused by use of the appliance. Some states do not allow this exclusion or limitation of incidental or consequential losses so the foregoing disclaimer may not apply to you. This warranty gives you specific legal rights, and you may also have other rights which may vary from state to state.

The serial number can be found on the back cabinet. We suggest that you record the serial number of your unit in the space below for future reference

Model Number: _____

Serial Number: _____

SAVE THIS FOR YOUR RECORDS

Made in China

TOSHIBA

Customer Assistance: 855-204-5313
Midea America Corp
5 Sylvan Way, Parsippany, NJ 07054