

Test report

311425-2TRFWL

Date of issue: May 5, 2017

Applicant:

Siemens Canada Ltd.

Product:

Multiprotocol Intelligent Node with LTE and Wi-Fi

Model:

RX1400

FCC ID:

VG5RX1400

IC Registration number:

4997A-VG5RX1400

Specifications:

- ◆ **FCC 47 CFR Part 15 Subpart C, §15.247**
Operation in the 902–928 MHz, 2400–2483.5 MHz, and 5725–5850 MHz
- ◆ **RSS-247, Issue 1, May 2015, Section 5**
Digital Transmission Systems (DTSs), Frequency Hopping Systems (FHSs)
and Licence-Exempt Local Area Network (LE-LAN) Devices

Test location

Company name	Nemko Canada Inc.
Address	303 River Road
City	Ottawa
Province	Ontario
Postal code	K1V 1H2
Country	Canada
Telephone	+1 613 737 9680
Facsimile	+1 613 737 9691
Toll free	+1 800 563 6336
Website	www.nemko.com
Site number	FCC: 176392; IC: 2040A-4 (3 m semi anechoic chamber)

Tested by	Andrey Adelberg, Senior Wireless/EMC Specialist
Reviewed by	Kevin Rose, Wireless/EMC Specialist
Review date	May 5, 2017
Reviewer signature	

Limits of responsibility

Note that the results contained in this report relate only to the items tested and were obtained in the period between the date of initial receipt of samples and the date of issue of the report.

This test report has been completed in accordance with the requirements of ISO/IEC 17025. All results contain in this report are within Nemko Canada's ISO/IEC 17025 accreditation.

Copyright notification

Nemko Canada Inc. authorizes the applicant to reproduce this report provided it is reproduced in its entirety and for use by the company's employees only. Any use which a third party makes of this report, or any reliance on or decisions to be made based on it, are the responsibility of such third parties. Nemko Canada Inc. accepts no responsibility for damages, if any, suffered by any third party as a result of decisions made or actions based on this report.
© Nemko Canada Inc.

Table of contents

Table of contents	3
Section 1. Report summary	4
1.1 Applicant and manufacturer	4
1.2 Test specifications	4
1.3 Test methods	4
1.4 Statement of compliance	4
1.5 Exclusions	4
1.6 Test report revision history	4
Section 2. Summary of test results	5
2.1 FCC Part 15 Subpart C, general requirements test results	5
2.2 FCC Part 15 Subpart C, intentional radiators test results	5
2.3 IC RSS-GEN, Issue 4, test results	5
2.4 IC RSS-247, Issue 1, test results	6
Section 3. Equipment under test (EUT) details	7
3.1 Sample information	7
3.2 EUT information	7
3.3 Technical information	7
3.4 Product description and theory of operation	8
3.5 EUT exercise details	8
3.6 EUT setup diagram	9
Section 4. Engineering considerations	10
4.1 Modifications incorporated in the EUT	10
4.2 Technical judgment	10
4.3 Deviations from laboratory tests procedures	10
Section 5. Test conditions	11
5.1 Atmospheric conditions	11
5.2 Power supply range	11
Section 6. Measurement uncertainty	12
6.1 Uncertainty of measurement	12
Section 7. Test equipment	13
7.1 Test equipment list	13
Section 8. Testing data	14
8.1 FCC 15.207(a) and RSS-Gen 8.8 AC power line conducted emissions limits	14
8.2 FCC 15.247(a)(2) and RSS-247 5.2(1) Minimum 6 dB bandwidth for systems using digital modulation techniques	24
8.3 FCC 15.247(b) and RSS-247 5.4 (4) Transmitter output power and e.i.r.p. requirements	26
8.4 FCC 15.247(d) and RSS-247 5.5 Spurious (out-of-band) emissions	29
8.5 FCC 15.247(e) and RSS-247 5.2(2) Power spectral density for digitally modulated devices	41
Section 9. Block diagrams of test set-ups	44
9.1 Radiated emissions set-up for frequencies below 1 GHz	44
9.2 Radiated emissions set-up for frequencies above 1 GHz	45
9.3 Conducted emissions set-up	45

Section 1. Report summary

1.1 Applicant and manufacturer

Company name	Siemens Canada Ltd.
Address	300 Applewood Cres
City	Concord
Province/State	Ontario
Postal/Zip code	L4K 5C7
Country	Canada

1.2 Test specifications

FCC 47 CFR Part 15, Subpart C, Clause 15.247	Operation in the 902–928 MHz, 2400–2483.5 MHz, and 5725–585 MHz
RSS-247, Issue 1, May 2015, Section 5	Digital Transmission Systems (DTSs), Frequency Hopping Systems (FHSs) and Licence-Exempt Local Area Network (LE-LAN) Devices

1.3 Test methods

558074 D01 DTS Meas Guidance v03r05 (April 8, 2016)	Guidance for Performing Compliance Measurements on Digital Transmission Systems (DTS) Operating Under §15.247
662911 D01 Multiple Transmitter Output v02r01 (October 31, 2013)	Emissions Testing of Transmitters with Multiple Outputs in the Same Band
ANSI C63.10 v2013	American National Standard of Procedures for Compliance Testing of Unlicensed Wireless Devices

1.4 Statement of compliance

In the configuration tested, the EUT was found compliant.

Testing was completed against all relevant requirements of the test standard. Results obtained indicate that the product under test complies in full with the requirements tested. The test results relate only to the items tested.

See “Summary of test results” for full details.

1.5 Exclusions

None

1.6 Test report revision history

Revision #	Details of changes made to test report
TRF	Original report issued

Section 2. Summary of test results

2.1 FCC Part 15 Subpart C, general requirements test results

Part	Test description	Verdict
§15.207(a)	Conducted limits	Pass
§15.31(e)	Variation of power source	Pass ¹
§15.203	Antenna requirement	Pass ²

Notes: ¹ Measurements of the variation of the input power or the radiated signal level of the fundamental frequency component of the emission, as appropriate, was performed with the supply voltage varied between 85 % and 115 % of the nominal rated supply voltage. No noticeable output power variation was observed

² EUT has a unique antenna connector and it is professionally installed

2.2 FCC Part 15 Subpart C, intentional radiators test results

Part	Test description	Verdict
§15.247(a)(1)(i)	Frequency hopping systems operating in the 902–928 MHz band	Not applicable
§15.247(a)(1)(ii)	Frequency hopping systems operating in the 5725–5850 MHz band	Not applicable
§15.247(a)(1)(iii)	Frequency hopping systems operating in the 2400–2483.5 MHz band	Not applicable
§15.247(a)(2)	Minimum 6 dB bandwidth for systems using digital modulation techniques	Pass
§15.247(b)(1)	Maximum peak output power of frequency hopping systems operating in the 2400–2483.5 MHz band and 5725–5850 MHz band	Not applicable
§15.247(b)(2)	Maximum peak output power of Frequency hopping systems operating in the 902–928 MHz band	Not applicable
§15.247(b)(3)	Maximum peak output power of systems using digital modulation in the 902–928 MHz, 2400–2483.5 MHz, and 5725–5850 MHz bands	Pass
§15.247(c)(1)	Fixed point-to-point operation with directional antenna gains greater than 6 dBi	Not applicable
§15.247(c)(2)	Transmitters operating in the 2400–2483.5 MHz band that emit multiple directional beams	Not applicable
§15.247(d)	Spurious emissions	Pass
§15.247(e)	Power spectral density for digitally modulated devices	Pass
§15.247(f)	Time of occupancy for hybrid systems	Not applicable

2.3 IC RSS-GEN, Issue 4, test results

Part	Test description	Verdict
7.1.2	Receiver radiated emission limits	Not applicable
7.1.3	Receiver conducted emission limits	Not applicable
8.8	Power Line Conducted Emissions Limits for Licence-Exempt Radio Apparatus	Pass

Notes: ¹ According to sections 5.2 and 5.3 of RSS-Gen, Issue 4 the EUT does not have a stand-alone receiver neither scanner receiver, therefore exempt from receiver requirements.

2.4 IC RSS-247, Issue 1, test results

Part	Test description	Verdict
5.1	Frequency Hopping Systems (FHSs)	
5.1 (1)	Bandwidth of a frequency hopping channel	Not applicable
5.1 (2)	Minimum channel spacing for frequency hopping systems	Not applicable
5.1 (3)	Frequency hopping systems operating in the 902–928 MHz band	Not applicable
5.1 (4)	Frequency hopping systems operating in the 2400–2483.5 MHz band	Not applicable
5.1 (5)	Frequency hopping systems operating in the 5725–5850 MHz band	Not applicable
5.2	Digital Transmission Systems (DTSs)	
5.2 (1)	Minimum 6 dB bandwidth	Pass
5.2 (2)	Maximum power spectral density	Pass
5.3	Hybrid Systems	
5.3 (1)	Digital modulation turned off	Not applicable
5.3 (2)	Frequency hopping turned off	Not applicable
5.4	Transmitter output power and e.i.r.p. requirements	
5.4 (1)	Frequency hopping systems operating in the 902–928 MHz band	Not applicable
5.4 (2)	Frequency hopping systems operating in the 2400–2483.5 MHz band	Not applicable
5.4 (3)	Frequency hopping systems operating in the 5725–5850 MHz	Not applicable
5.4 (4)	Systems employing digital modulation techniques	Pass
5.4 (5)	Point-to-point systems in 2400–2483.5 MHz and 5725–5850 MHz band	Not applicable
5.4 (6)	Transmitters which operate in the 2400–2483.5 MHz band with multiple directional beams	Not applicable
5.5	Out-of-band emissions	Pass

Notes: None

Section 3. Equipment under test (EUT) details

3.1 Sample information

Receipt date	August 1, 2016
Nemko sample ID number	1 (48 V _{DC}), 2 (24 V _{DC}) and 3 (120 V _{AC})

3.2 EUT information

Product name	Multiprotocol Intelligent Node with LTE and Wi-Fi
Model	RX1400
Part number	6GK60140AM220AA0-ZA02+C00+D00+E00+F00+G02+V00 (48 V _{DC})
Part number variants	6GK60140AM210AA0-ZA02+C00+D00+E00+F00+G02+V00 (24 V _{DC}) 6GK60140AM230AA0-ZA02+C00+D00+E00+F00+G02+V00 (120 V _{AC})
Serial number	RUM/H805061787 (48 V _{DC}), RUM/H805061785 (24V _{DC}), RUM/H805061788 (120 V _{AC}),

3.3 Technical information

Applicant IC company number	4997A
IC UPN number	VG5RX1400
All used IC test site(s) Reg. number	2040A-4
RSS number and issue number	RSS-247 Issue 1, May 2015
Frequency band	2400–2483.5 MHz
Frequency Min (MHz)	2412 (20 MHz channel) and 2422 (40 MHz channel)
Frequency Max (MHz)	2462 (20 MHz channel) and 2452 (40 MHz channel)
RF power Max (W), Conducted	0.149 (21.75 dBm)
Field strength, Units @ distance	N/A
Measured BW (kHz) (6 dB)	35000 (maximum)
Calculated BW (kHz), as per TRC-43	N/A
Type of modulation	802.11b, 802.11g, 802.11n HT20 and 802.11n HT40
Emission classification (F1D, G1D, D1D)	W7D
Transmitter spurious, Units @ distance	52.98 dB μ V/m at 2390 MHz @ 3 m
Power requirements	120 V _{AC} or 24 V _{DC} PS or 48 V _{DC} PS

Table 3.3-1: Antenna¹ information

Model number	Directivity	Gain, dBi
ANT792-8DN	Directional	14
ANT795-6DC	Directional	9
ANT792-6MN	Omni-directional	6
ANT795-6MN	Directional	6
ANT795-6MT	Directional	5
ANT792-4DN	Omni-directional	4
ANT795-4MA	Omni-directional	3
ANT795-4MC	Omni-directional	3
ANT795-4MD	Omni-directional	3
ANT795-4MX	Omni-directional	2

Notes: ¹The EUT is professionally installed

3.4 Product description and theory of operation

The RUGGEDCOM RX1400 is a multi-protocol intelligent node that combines Ethernet switch, routing and firewall functionality with various wide area connectivity options. The RX1400 switch, with its rugged metal housing, is designed for DIN rail, panel or rack mounting. The device has IP40 degree protection, does not use internal fans for cooling and supports a -40 to 85 °C (-40 to 185 °F) extended temperature range.

Wireless Interfaces

WWAN module (Contains FCC ID: N7NMC7355 / IC: 2417C-MC7355):

- LTE: 700- B13, B17, 800/900/1800/2100/2600 MHz
- UMTS/HSPA+: 850/900/1900/2100 MHz
- Quad-Band EDGE/GPRS/GSM

GNSS

WLAN Access Point and Client: WLAN Direct® (multi-channel, multi-role) dual band transceiver support of IEEE 802.11a/b/g/n for 2.4 GHz 2x2 MIMO and 5 GHz SISO, 20 MHz and 40 MHz channels

Ethernet Interfaces

- 4 × 10/100Base-T RJ45 ports Serial Interfaces with Isolation

Optical SFP Pluggable Transceivers

- 2 × 1000 Mbit/s ports

Serial Interface with isolation

- 2 × RS232/422/485 ports

Other Interfaces

- Isolated built-in power input
- RS232 console port for local management/ diagnostics on the device
- SMA connectors for RF interfaces

Power Supply

- 12 to 24 VDC
- ±12 to 24 VDC
- ±48 VDC
- HI VAC/VDC

3.5 EUT exercise details

EUT was controlled from laptop using web GUI and CLI commands.

3.6 EUT setup diagram

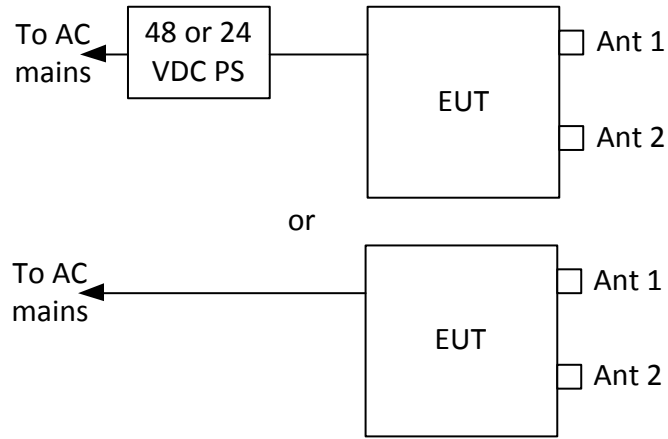

Figure 3.6-1: Setup diagram

Note: 48 V_{DC} power supply: Artesyn ADNB008-48-1PM-C, SN: U65107088
24 V_{DC} power supply: XPpower DNR60US24, SN: 131245-9601041401253

Section 4. Engineering considerations

4.1 Modifications incorporated in the EUT

There were no modifications performed to the EUT during this assessment.

4.2 Technical judgment

None

4.3 Deviations from laboratory tests procedures

No deviations were made from laboratory procedures.

Section 5. Test conditions

5.1 Atmospheric conditions

Temperature	15–30 °C
Relative humidity	20–75 %
Air pressure	860–1060 mbar

When it is impracticable to carry out tests under these conditions, a note to this effect stating the ambient temperature and relative humidity during the tests shall be recorded and stated.

5.2 Power supply range

The normal test voltage for equipment to be connected to the mains shall be the nominal mains voltage. For the purpose of the present document, the nominal voltage shall be the declared voltage, or any of the declared voltages $\pm 5\%$, for which the equipment was designed.

Section 6. Measurement uncertainty

6.1 Uncertainty of measurement

UKAS Lab 34 and TIA-603-B have been used as guidance for measurement uncertainty reasonable estimations with regards to previous experience and validation of data. Nemko Canada, Inc. follows these test methods in order to satisfy ISO/IEC 17025 requirements for estimation of uncertainty of measurement for wireless products.

Measurement uncertainty budgets for the tests are detailed below. Measurement uncertainty calculations assume a coverage factor of $K = 2$ with 95% certainty.

Test name	Measurement uncertainty, dB
All antenna port measurements	0.55
Conducted spurious emissions	1.13
Radiated spurious emissions	3.78
AC power line conducted emissions	3.55

Section 7. Test equipment

7.1 Test equipment list

Table 7.1-1: Equipment list

Equipment	Manufacturer	Model no.	Asset no.	Cal cycle	Next cal.
3 m EMI test chamber	TDK	SAC-3	FA002047	1 year	Dec. 01/17
Flush mount turntable	Sunol	FM2022	FA002082	—	NCR
Controller	Sunol	SC104V	FA002060	—	NCR
Antenna mast	Sunol	TLT2	FA002061	—	NCR
AC Power source	Chenwa	2700M-10k	FA002716	—	VOU
Receiver/spectrum analyzer	Rohde & Schwarz	ESU 26	FA002043	1 year	Jan. 07/17
Spectrum analyzer	Rohde & Schwarz	FSU	FA001877	1 year	Apr. 15/17
Bilog antenna (20–3000 MHz)	Sunol	JB3	FA002108	1 year	Apr. 28/17
Horn antenna (1–18 GHz)	EMCO	3115	FA000825	1 year	Apr. 26/17
Horn antenna 18–40 GHz	EMCO	3116	FA001847	1 year	Apr.15/17
Pre-amplifier (1–18 GHz)	JCA	JCA118-503	FA002091	1 year	April 26/17
Pre-amplifier (18–26 GHz)	Narda	BBS-1826N612	FA001550	—	VOU
LISN	Rohde & Schwarz	ENV216	FA002023	1 year	Mar. 08/17

Note: NCR - no calibration required, VOU - verify on use

Section 8. Testing data

8.1 FCC 15.207(a) and RSS-Gen 8.8 AC power line conducted emissions limits

8.1.1 Definitions and limits

FCC:
 Except as shown in paragraphs (b) and (c) of this section, for an intentional radiator that is designed to be connected to the public utility (AC) power line, the radio frequency voltage that is conducted back onto the AC power line on any frequency or frequencies, within the band 150 kHz to 30 MHz, shall not exceed the limits in the following table, as measured using a 50 μ H/50 Ω line impedance stabilization network (LISN). Compliance with the provisions of this paragraph shall be based on the measurement of the radio frequency voltage between each power line and ground at the power terminal. The lower limit applies at the boundary between the frequency ranges.

IC:
 A radio apparatus that is designed to be connected to the public utility (AC) power line shall ensure that the radio frequency voltage, which is conducted back onto the AC power line on any frequency or frequencies within the band 150 kHz to 30 MHz, shall not exceed the limits in table below.

Unless the requirements applicable to a given device state otherwise, for any radio apparatus equipped to operate from the public utility AC power supply either directly or indirectly (such as with a battery charger), the radio frequency voltage of emissions conducted back onto the AC power lines in the frequency range of 0.15 MHz to 30 MHz shall not exceed the limits shown in table below. The more stringent limit applies at the frequency range boundaries.

Table 8.1-1: Conducted emissions limit

Frequency of emission, MHz	Conducted limit, dB μ V	
	Quasi-peak	Average**
0.15–0.5	66 to 56*	56 to 46*
0.5–5	56	46
5–30	60	50

Note: * - The level decreases linearly with the logarithm of the frequency.
 ** - A linear average detector is required.

8.1.2 Test summary

Test date	January 11, 2017	Temperature	22 °C
Test engineer	Andrey Adelberg	Air pressure	1010 mbar
Verdict	Pass	Relative humidity	33 %

8.1.1 Observations, settings and special notes

The EUT was set up as tabletop configuration.

The spectral scan has been corrected with transducer factors (i.e. cable loss, LISN factors, and attenuators) for determination of compliance.

A preview measurement was generated with the receiver in continuous scan mode. Emissions detected within 6 dB or above limit were re-measured with the appropriate detector against the correlating limit and recorded as the final measurement.

Receiver settings for preview measurements:

Resolution bandwidth	9 kHz
Video bandwidth	30 kHz
Detector mode	Peak and Average
Trace mode	Max Hold
Measurement time	100 ms

Receiver settings for final measurements:

Resolution bandwidth	9 kHz
Video bandwidth	30 kHz
Detector mode	Quasi-Peak and Average
Trace mode	Max Hold
Measurement time	100 ms

8.1.2 Test data

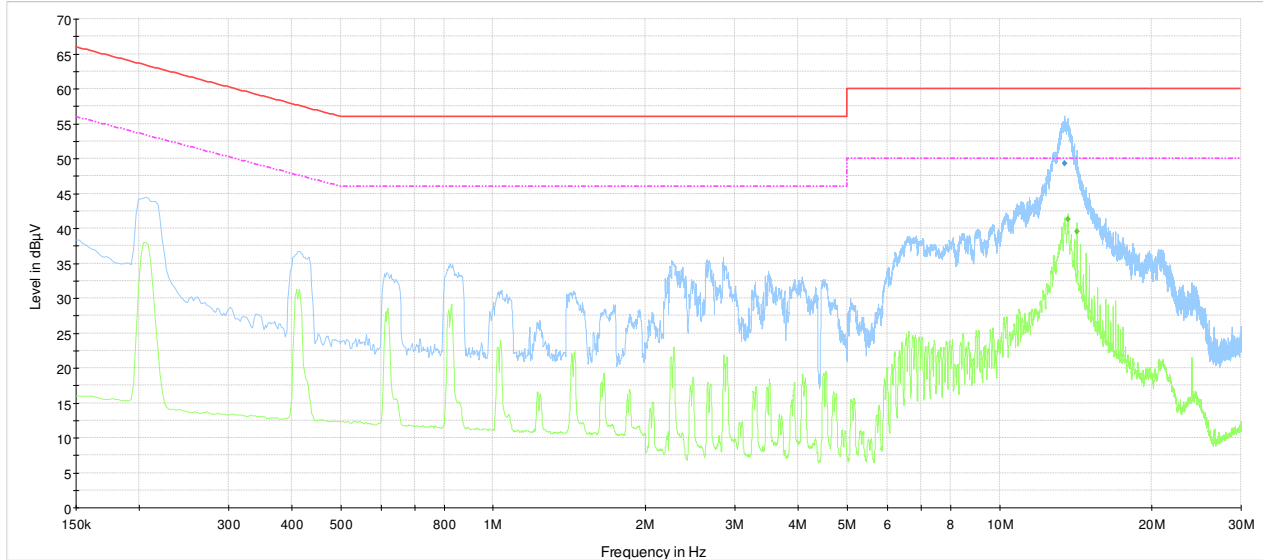

Conducted emissions on phase line
 Preview Result 2-AVG
 Preview Result 1-PK+
 CISPR 22 Mains Q-Peak Class B Limit
 CISPR 22 Mains Average Class B Limit
 Final_Result QPK
 Final_Result CAV

Plot 8.1-1: Conducted emissions on phase line, 24 V_{DC} PS

Table 8.1-2: Quasi-Peak conducted emissions results on phase line

Frequency, MHz	Q-Peak result, dBµV	Limit, dBµV	Margin, dB	Meas. Time, ms	Bandwidth, kHz	Filter	Correction, dB
13.458250	49.26	60.00	10.74	100	9	ON	10.3

Note: 43.5 dBµV = 23.2 dBµV (receiver reading) + 10.1 dB (LISN factor IL) + 0.2 dB (cable loss) + 10 dB (attenuator)

Table 8.1-3: Average conducted emissions results on phase line

Frequency, MHz	CAverage result, dBµV	Limit, dBµV	Margin, dB	Meas. Time, ms	Bandwidth, kHz	Filter	Correction, dB
13.654000	41.35	50.00	8.65	100	9	ON	10.3
14.239000	39.58	50.00	10.42	100	9	ON	10.3

Sample calculation:

Correction factor (dB) = LISN factor IL (dB) + cable loss (dB) + attenuator (dB)
 Result (dBµV) = XX dBµV (reading from receiver) + XX dB (Correction factor)

Example:

43.5 dBµV = 23.2 dBµV (receiver reading) + 10.1 dB (LISN factor IL) + 0.2 dB (cable loss) + 10 dB (attenuator)

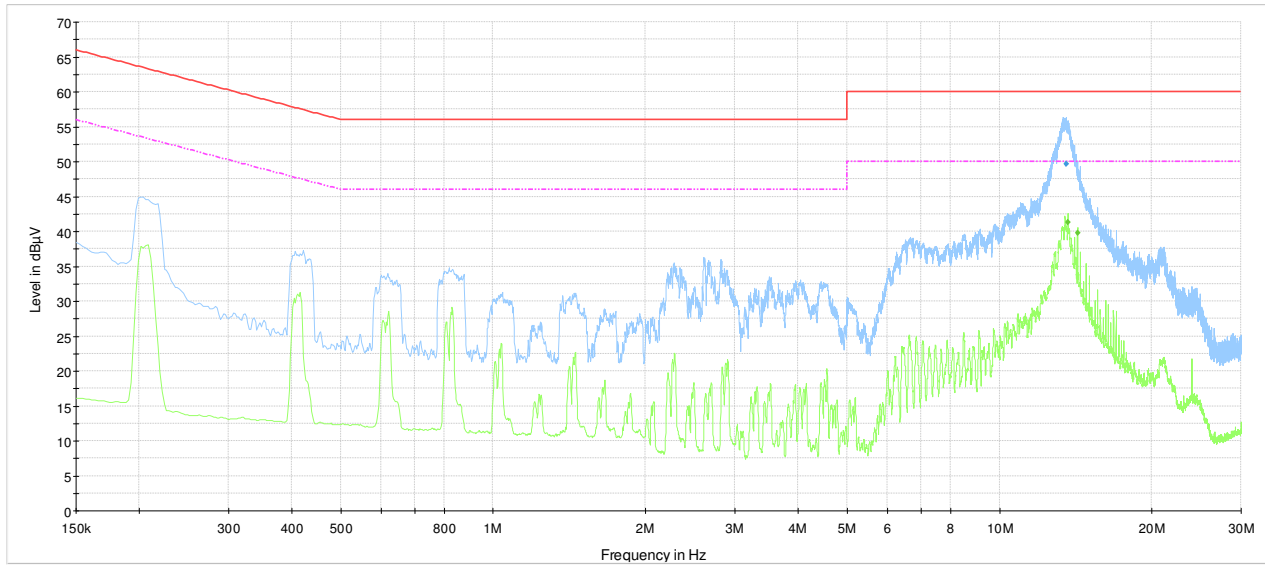

Conducted emissions on neutral line

- Preview Result 2-AVG
- Preview Result 1-PK+
- CISPR 22 Mains Q-Peak Class B Limit
- CISPR 22 Mains Average Class B Limit
- Final_Result QPK
- Final_Result CAV

Plot 8.1-2: Conducted emissions on neutral line, 24 V_{DC} PS

Table 8.1-4: Quasi-Peak conducted emissions results on neutral line

Frequency, MHz	Q-Peak result, dBµV	Limit, dBµV	Margin, dB	Meas. Time, ms	Bandwidth, kHz	Filter	Correction, dB
13.528000	49.68	60.00	10.32	100	9	ON	10.4

Note: 43.5 dBµV = 23.2 dBµV (receiver reading) + 10.1 dB (LISN factor IL) + 0.2 dB (cable loss) + 10 dB (attenuator)

Table 8.1-5: Average conducted emissions results on neutral line

Frequency, MHz	CAverage result, dBµV	Limit, dBµV	Margin, dB	Meas. Time, ms	Bandwidth, kHz	Filter	Correction, dB
13.667500	41.27	50.00	8.73	100	9	ON	10.3
14.252500	39.72	50.00	10.28	100	9	ON	10.3

Sample calculation:

Correction factor (dB) = LISN factor IL (dB) + cable loss (dB) + attenuator (dB)

Result (dBµV) = XX dBµV (reading from receiver) + XX dB (Correction factor)

Example:

43.5 dBµV = 23.2 dBµV (receiver reading) + 10.1 dB (LISN factor IL) + 0.2 dB (cable loss) + 10 dB (attenuator)

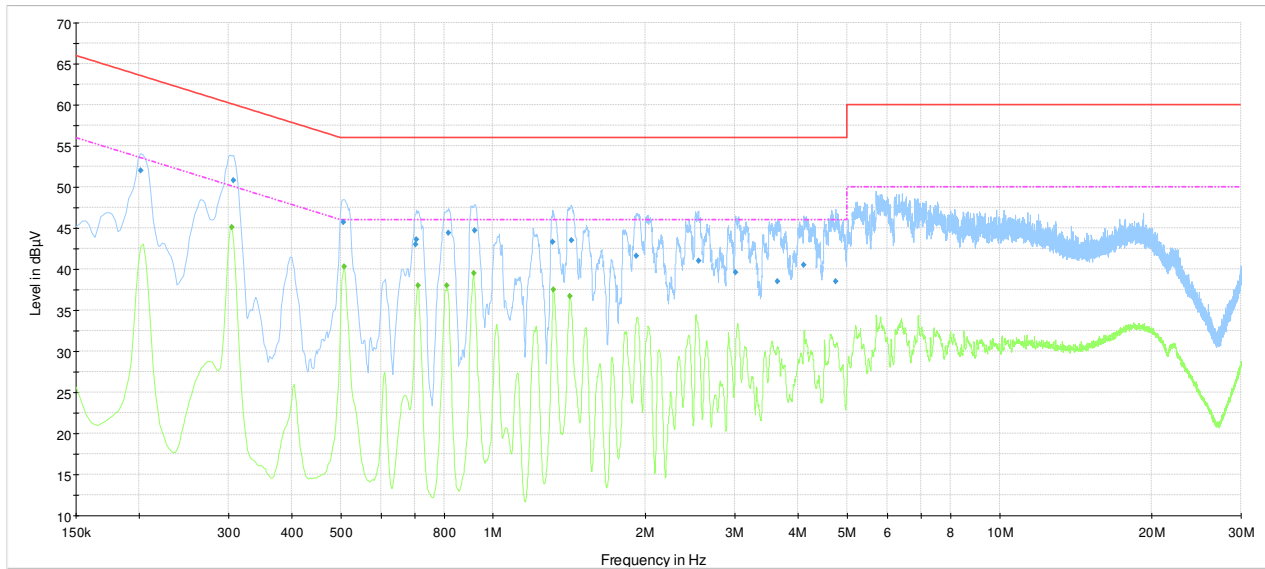

- Conducted emissions on phase line
- Preview Result 2-AVG
- Preview Result 1-PK+
- CISPR 22 Mains Q-Peak Class B Limit
- CISPR 22 Mains Average Class B Limit
- Final_Result QPK
- Final_Result CAV

Plot 8.1-3: Conducted emissions on phase line, 48 V_{DC} PS

Table 8.1-6: Quasi-Peak conducted emissions results on phase line

Frequency, MHz	Q-Peak result, dBµV	Limit, dBµV	Margin, dB	Meas. Time, ms	Bandwidth, kHz	Filter	Correction, dB
0.201750	52.03	63.54	11.51	100	9	ON	9.9
0.307500	50.77	60.04	9.27	100	9	ON	9.8
0.505500	45.71	56.00	10.29	100	9	ON	10.0
0.703500	42.99	56.00	13.01	100	9	ON	9.9
0.705750	43.60	56.00	12.40	100	9	ON	9.9
0.816000	44.38	56.00	11.62	100	9	ON	9.9
0.919500	44.71	56.00	11.29	100	9	ON	9.9
1.313250	43.30	56.00	12.70	100	9	ON	9.9
1.428000	43.47	56.00	12.53	100	9	ON	9.9
1.920750	41.60	56.00	14.40	100	9	ON	9.9
2.544000	41.01	56.00	14.99	100	9	ON	9.9
3.009750	39.59	56.00	16.41	100	9	ON	9.9
3.646500	38.48	56.00	17.52	100	9	ON	9.9
4.110000	40.53	56.00	15.47	100	9	ON	9.9
4.749000	38.54	56.00	17.46	100	9	ON	10.0

Note: 43.5 dBµV = 23.2 dBµV (receiver reading) + 10.1 dB (LISN factor IL) + 0.2 dB (cable loss) + 10 dB (attenuator)

Table 8.1-7: Average conducted emissions results on phase line

Frequency, MHz	CAverage result, dBµV	Limit, dBµV	Margin, dB	Meas. Time, ms	Bandwidth, kHz	Filter	Correction, dB
0.305250	45.13	50.10	4.97	100	9	ON	9.8
0.507750	40.35	46.00	5.65	100	9	ON	10.0
0.710250	38.00	46.00	8.00	100	9	ON	9.9
0.811500	38.03	46.00	7.97	100	9	ON	9.9
0.915000	39.54	46.00	6.46	100	9	ON	9.9
1.315500	37.54	46.00	8.46	100	9	ON	9.9
1.419000	36.72	46.00	9.28	100	9	ON	9.9

Sample calculation:

Correction factor (dB) = LISN factor IL (dB) + cable loss (dB) + attenuator (dB)

Result (dBµV) = XX dBµV (reading from receiver) + XX dB (Correction factor)

Example:

43.5 dBµV = 23.2 dBµV (receiver reading) + 10.1 dB (LISN factor IL) + 0.2 dB (cable loss) + 10 dB (attenuator)

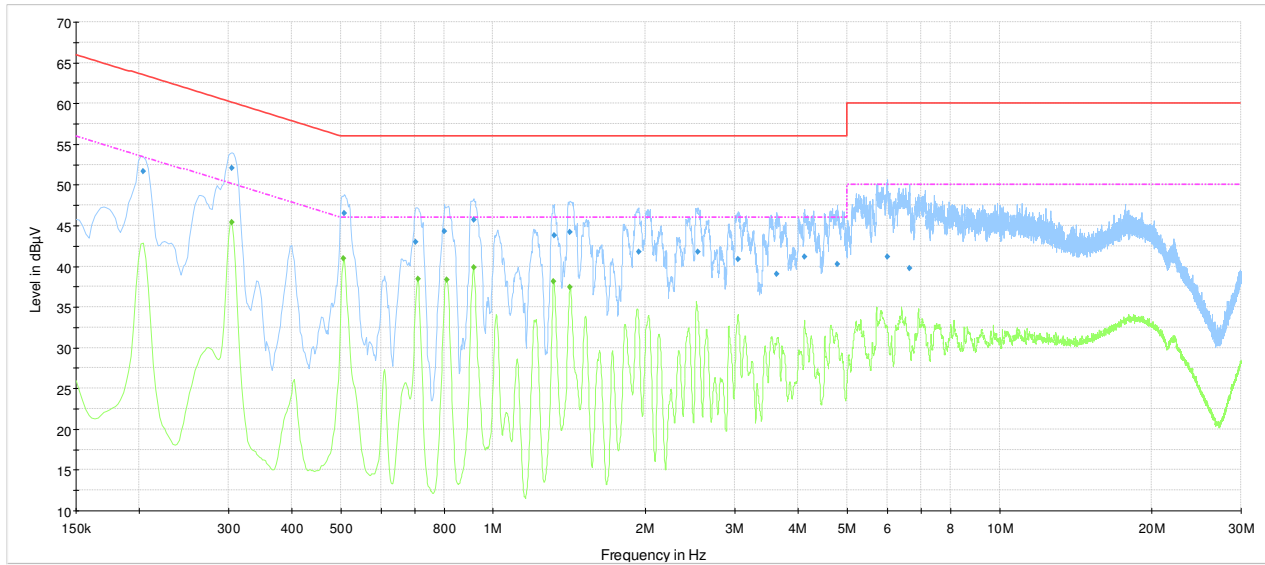

- Conducted emissions on neutral line
- Preview Result 2-AVG
 - Preview Result 1-PK+
 - CISPR 22 Mains Q-Peak Class B Limit
 - CISPR 22 Mains Average Class B Limit
 - Final Result QPK
 - Final Result CAV

Plot 8.1-4: Conducted emissions on neutral line, 48 V_{DC} PS

Table 8.1-8: Quasi-Peak conducted emissions results on neutral line

Frequency, MHz	Q-Peak result, dBµV	Limit, dBµV	Margin, dB	Meas. Time, ms	Bandwidth, kHz	Filter	Correction, dB
0.204000	51.65	63.45	11.80	100	9	ON	9.9
0.305250	52.07	60.10	8.03	100	9	ON	9.8
0.507750	46.47	56.00	9.53	100	9	ON	10.0
0.703500	42.97	56.00	13.03	100	9	ON	9.9
0.802500	44.32	56.00	11.68	100	9	ON	9.9
0.915000	45.66	56.00	10.34	100	9	ON	9.9
1.320000	43.80	56.00	12.20	100	9	ON	9.9
1.416750	44.20	56.00	11.80	100	9	ON	9.9
1.936500	41.75	56.00	14.25	100	9	ON	9.9
2.537250	41.74	56.00	14.26	100	9	ON	9.9
3.043500	40.88	56.00	15.12	100	9	ON	9.9
3.633000	39.03	56.00	16.97	100	9	ON	9.9
4.121250	41.12	56.00	14.88	100	9	ON	9.9
4.778250	40.22	56.00	15.78	100	9	ON	10.0
6.004500	41.20	60.00	18.80	100	9	ON	10.1
6.634500	39.71	60.00	20.29	100	9	ON	10.1

Note: 43.5 dBµV = 23.2 dBµV (receiver reading) + 10.1 dB (LISN factor IL) + 0.2 dB (cable loss) + 10 dB (attenuator)

Table 8.1-9: Average conducted emissions results on neutral line

Frequency, MHz	CAverage result, dBµV	Limit, dBµV	Margin, dB	Meas. Time, ms	Bandwidth, kHz	Filter	Correction, dB
0.305250	45.42	50.10	4.68	100	9	ON	9.8
0.505500	40.92	46.00	5.08	100	9	ON	10.0
0.710250	38.45	46.00	7.55	100	9	ON	9.9
0.811500	38.35	46.00	7.65	100	9	ON	9.9
0.915000	39.82	46.00	6.18	100	9	ON	9.9
1.317750	38.14	46.00	7.86	100	9	ON	9.9
1.419000	37.38	46.00	8.62	100	9	ON	9.9

Sample calculation:

Correction factor (dB) = LISN factor IL (dB) + cable loss (dB) + attenuator (dB)

Result (dBµV) = XX dBµV (reading from receiver) + XX dB (Correction factor)

Example:

43.5 dBµV = 23.2 dBµV (receiver reading) + 10.1 dB (LISN factor IL) + 0.2 dB (cable loss) + 10 dB (attenuator)

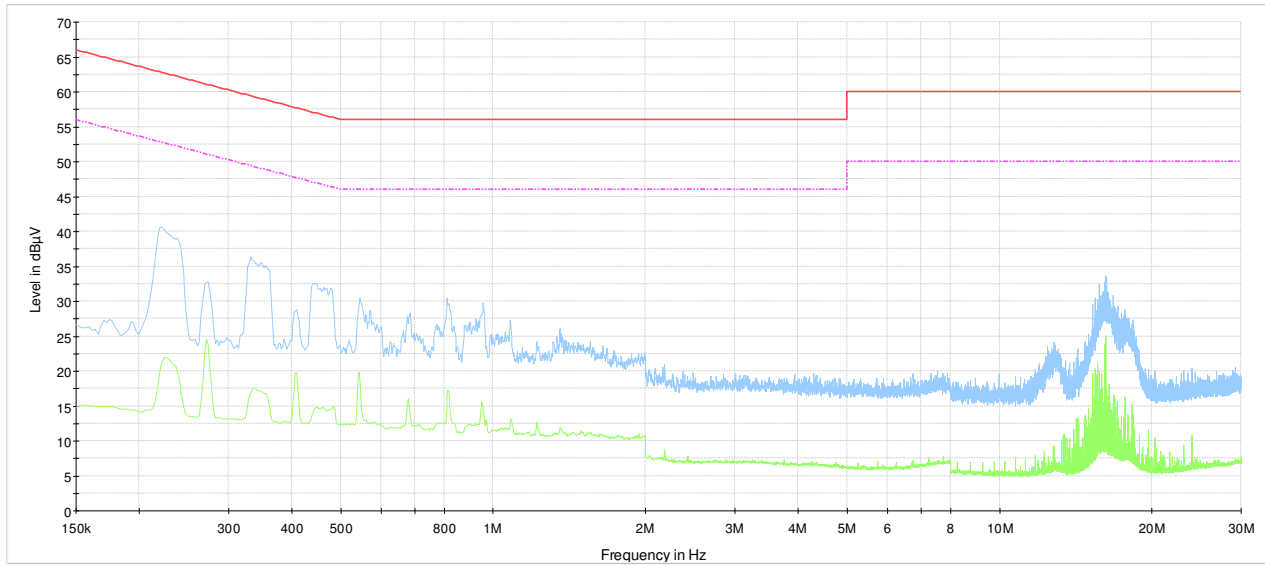

- Conducted emissions on phase line
- Preview Result 2-AVG
 - Preview Result 1-PK+
 - CISPR 22 Mains Q-Peak Class B Limit
 - CISPR 22 Mains Average Class B Limit
 - Final_Result QPK
 - Final_Result CAV

Plot 8.1-5: Conducted emissions on phase line, AC PS

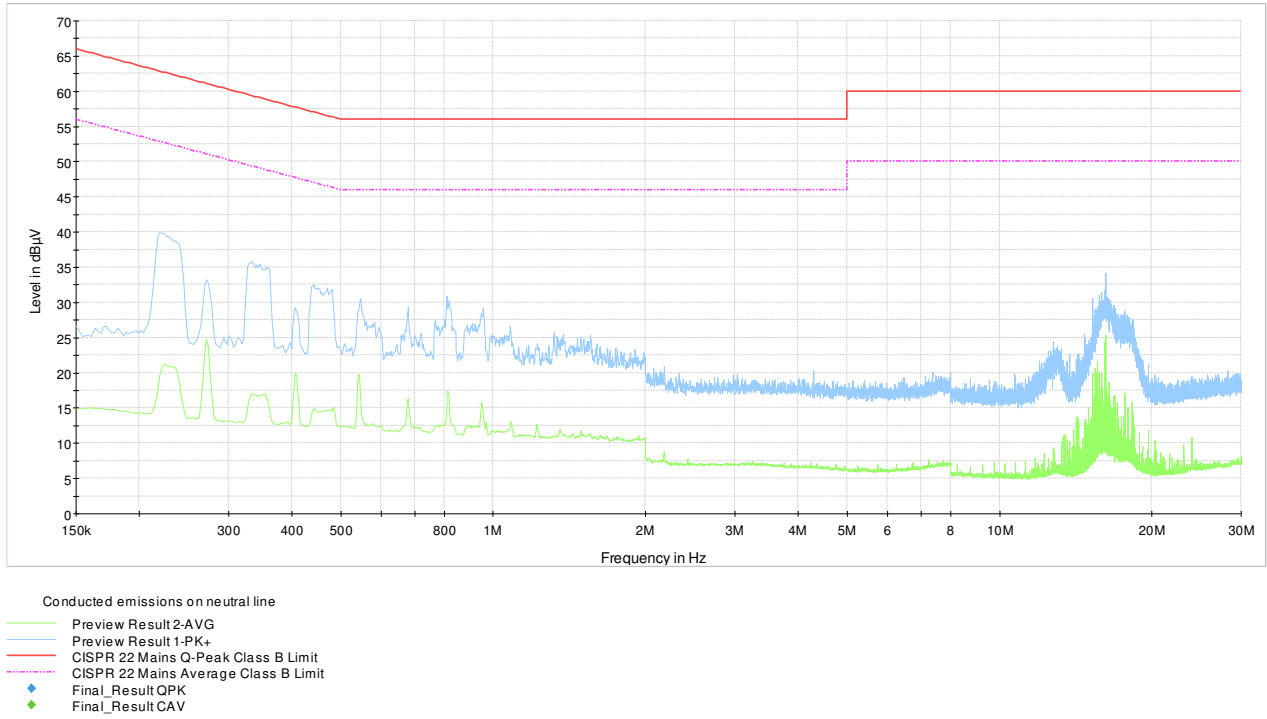

Plot 8.1-6: Conducted emissions on neutral line, AC PS

8.2 FCC 15.247(a)(2) and RSS-247 5.2(1) Minimum 6 dB bandwidth for systems using digital modulation techniques

8.2.1 Definitions and limits

FCC and IC:

- (a) Operation under the provisions of this Section is limited to frequency hopping and digitally modulated intentional radiators that comply with the following provisions:
- (2) Systems using digital modulation techniques may operate in the 902–928 MHz, 2400–2483.5 MHz and 5725–5850 MHz bands. The minimum 6 dB bandwidth shall be at least 500 kHz.

8.2.2 Test summary

Test date	August 30, 2016	Temperature	23 °C
Test engineer	Andrey Adelberg	Air pressure	1007 mbar
Verdict	Pass	Relative humidity	35 %

8.2.3 Observations, settings and special notes

Spectrum analyser settings:

Resolution bandwidth	100 kHz
Video bandwidth	$\geq 3 \times$ RBW
Frequency span	20 MHz for 20 MHz channel; 60 MHz for 40 MHz channel
Detector mode	Peak
Trace mode	Max Hold

8.2.4 Test data

Table 8.2-1: 6 dB bandwidth results

Modulation	Frequency, MHz	6 dB bandwidth, MHz	Minimum limit, MHz	Margin, MHz
802.11b	2412	10.141	0.500	9.641
	2437	10.071	0.500	9.571
	2462	10.128	0.500	9.628
802.11g	2412	15.089	0.500	14.589
	2437	15.135	0.500	14.635
	2462	15.135	0.500	14.635
802.11n HT20	2412	15.378	0.500	14.878
	2437	15.487	0.500	14.987
	2462	15.135	0.500	14.635
802.11n HT40	2422	26.231	0.500	25.731
	2437	32.520	0.500	32.020
	2452	35.000	0.500	34.500

Section 8

Testing data

Test name

FCC 15.247(a)(2) and RSS-247 5.2(1) Minimum 6 dB bandwidth for systems using digital modulation techniques

Specification

FCC Part 15 Subpart C and RSS-247, Issue 1

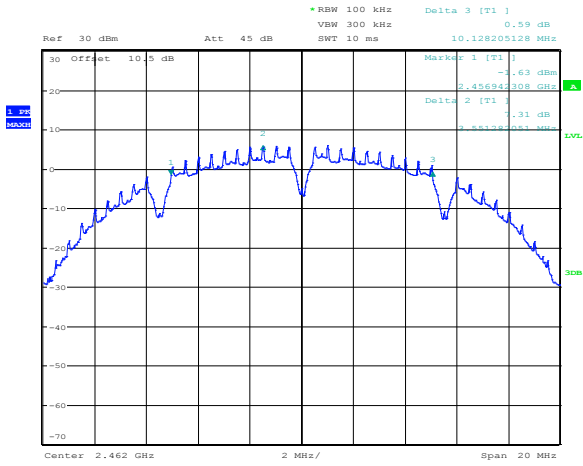

Date: 30.AUG.2016 14:29:08

Figure 8.2-1: 6 dB bandwidth on 802.11b, sample plot

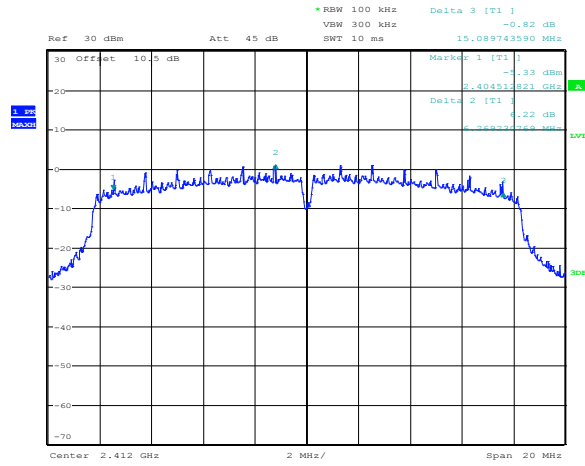

Date: 30.AUG.2016 14:32:33

Figure 8.2-2: 6 dB bandwidth on 802.11g, sample plot

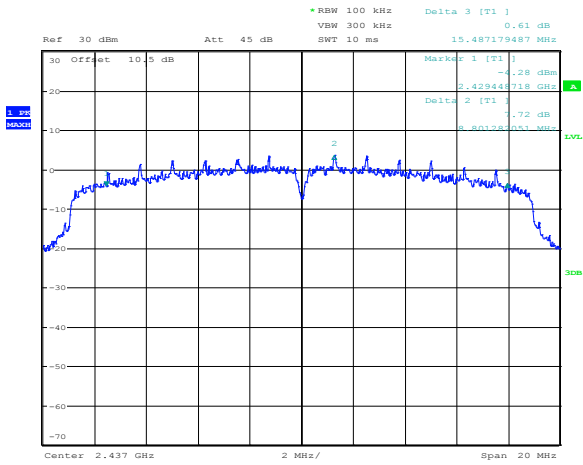

Date: 30.AUG.2016 14:36:51

Figure 8.2-3: 6 dB bandwidth on 802.11n HT20, sample plot

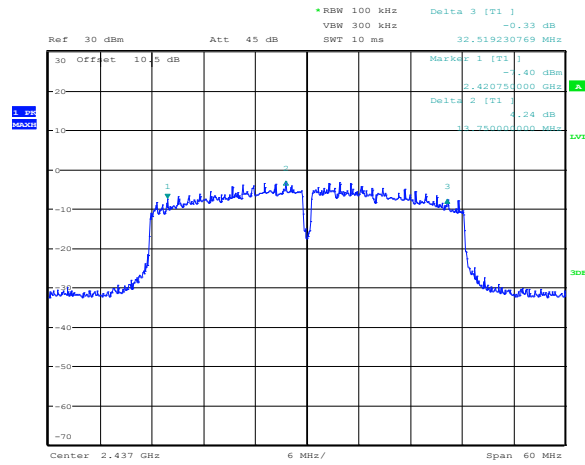

Date: 30.AUG.2016 14:21:00

Figure 8.2-4: 6 dB bandwidth on 802.11n HT40, sample plot

8.3 FCC 15.247(b) and RSS-247 5.4 (4) Transmitter output power and e.i.r.p. requirements

8.3.1 Definitions and limits

FCC:

- (b) The maximum peak conducted output power of the intentional radiator shall not exceed the following:
- (3) For systems using digital modulation in the 902–928 MHz, 2400–2483.5 MHz, and 5725–5850 MHz bands: 1 W (30 dBm). As an alternative to a peak power measurement, compliance with the one Watt limit can be based on a measurement of the maximum conducted output power. Maximum Conducted Output Power is defined as the total transmit power delivered to all antennas and antenna elements averaged across all symbols in the signaling alphabet when the transmitter is operating at its maximum power control level. Power must be summed across all antennas and antenna elements. The average must not include any time intervals during which the transmitter is off or is transmitting at a reduced power level. If multiple modes of operation are possible (e.g., alternative modulation methods), the maximum conducted output power is the highest total transmit power occurring in any mode.
 - (4) The conducted output power limit specified in paragraph (b) of this section is based on the use of antennas with directional gains that do not exceed 6 dBi. Except as shown in paragraph (c) of this section, if transmitting antennas of directional gain greater than 6 dBi are used, the conducted output power from the intentional radiator shall be reduced below the stated values in paragraphs (b)(1), (b)(2), and (b)(3) of this section, as appropriate, by the amount in dB that the directional gain of the antenna exceeds 6 dBi.
 - (i) Systems operating in the 2400–2483.5 MHz band that are used exclusively for fixed, point-to-point operations may employ transmitting antennas with directional gain greater than 6 dBi provided the maximum peak output power of the intentional radiator is reduced by 1 dB for every 3 dB that the directional gain of the antenna exceeds 6 dBi.

Fixed, point-to-point operation, as used in paragraphs (b)(3)(i) and (b)(3)(ii) of this section, excludes the use of point-to-multipoint systems, omnidirectional applications, and multiple co-located intentional radiators transmitting the same information. The operator of the spread spectrum intentional radiator or, if the equipment is professionally installed, the installer is responsible for ensuring that the system is used exclusively for fixed, point-to-point operations. The instruction manual furnished with the intentional radiator shall contain language in the installation instructions informing the operator and the installer of this responsibility.

- (c) Operation with directional antenna gains greater than 6 dBi.
- (2) In addition to the provisions in paragraphs (b)(1), (b)(3), (b)(4) and (c)(1)(i) of this section, transmitters operating in the 2400–2483.5 MHz band that emit multiple directional beams, simultaneously or sequentially, for the purpose of directing signals to individual receivers or to groups of receivers provided the emissions comply with the following:
 - (i) Different information must be transmitted to each receiver.
 - (ii) If the transmitter employs an antenna system that emits multiple directional beams but does not do emit multiple directional beams simultaneously, the total output power conducted to the array or arrays that comprise the device, i.e., the sum of the power supplied to all antennas, antenna elements, staves, etc. and summed across all carriers or frequency channels, shall not exceed the limit specified in paragraph (b)(1) or (b)(3) of this section, as applicable. However, the total conducted output power shall be reduced by 1 dB below the specified limits for each 3 dB that the directional gain of the antenna/antenna array exceeds 6 dBi. The directional antenna gain shall be computed as follows:
 - (A) The directional gain shall be calculated as the sum of 10 log (number of array elements or staves) plus the directional gain of the element or stave having the highest gain.

IC:
 For DTSs employing digital modulation techniques operating in the bands 902–928 MHz and 2400–2483.5 MHz, the maximum peak conducted output power shall not exceed 1W. Except as provided in Section 5.4(5), the e.i.r.p. shall not exceed 4 W.

Fixed point-to-point systems in the bands 2400–2483.5 MHz and 5725–5850 MHz are permitted to have an e.i.r.p. higher than 4 W provided that the higher e.i.r.p. is achieved by employing higher gain directional antennas and not higher transmitter output powers. Point-to-multipoint systems, omnidirectional applications and multiple co-located transmitters transmitting the same information are prohibited from exceeding an e.i.r.p. of 4 W.

8.3.2 Test summary

Test date	August 30, 2016	Temperature	23 °C
Test engineer	Andrey Adelberg	Air pressure	1007 mbar
Verdict	Pass	Relative humidity	35 %

8.3.3 Observations, settings and special notes

The test was performed according to DTS guidelines section 9.2.2.1: Measurement using a spectrum analyzer Peak method.

Output power limit for 14 dBi antenna was calculated as follows: $30 - (14 - 6) = 22$ dBm

Output power settings were set to the maximum. The table below shows only 14 dBi antenna. All other antennas have lesser gain, therefore total EIRP will be lower than those shown in the table.

Combined average output power for MIMO 2 × 2 application was calculated as follows: $P_{combined} = 10 \times \log_{10} \left((10^{P_{ch0}/10}) + (10^{P_{ch1}/10}) \right)$

8.3.4 Test data

Table 8.3-1: Output power measurements results

Modulation	Frequency, MHz	Conducted output power, dBm		Margin, dB	Antenna gain, dBi	EIRP, dBm	EIRP limit, dBm	EIRP margin, dB
		Measured	Limit					
802.11b	2412	21.53	22.00	0.47	14.00	35.53	36.00	0.47
	2437	21.20	22.00	0.80	14.00	35.20	36.00	0.80
	2462	21.64	22.00	0.36	14.00	35.64	36.00	0.36
802.11g	2412	20.09	22.00	1.91	14.00	34.09	36.00	1.91
	2437	21.75	22.00	0.25	14.00	35.75	36.00	0.25
	2462	20.25	22.00	1.75	14.00	34.25	36.00	1.75
802.11n HT20	2412	19.62	22.00	2.38	14.00	33.62	36.00	2.38
	2437	20.02	22.00	1.98	14.00	34.02	36.00	1.98
	2462	19.33	22.00	2.67	14.00	33.33	36.00	2.67
802.11n HT40	2422	17.02	22.00	4.98	14.00	31.02	36.00	4.98
	2437	19.03	22.00	2.97	14.00	33.03	36.00	2.97
	2452	17.01	22.00	4.99	14.00	31.01	36.00	4.99

Table 8.3-2: Output power measurements results for MIMO 2 × 2 application

Modulation	Frequency, MHz	Conducted output power, dBm			Margin, dB	Antenna gain, dBi	EIRP, dBm	EIRP limit, dBm	EIRP margin, dB	
		on ch0	on ch1	Combined						
802.11n HT20	2412	18.19	16.47	20.42	22.00	1.58	14.00	34.42	36.00	1.58
	2437	19.65	17.31	21.65	22.00	0.35	14.00	35.65	36.00	0.35
	2462	19.05	16.54	20.98	22.00	1.02	14.00	34.98	36.00	1.02

Section 8
Test name
Specification

Testing data
 FCC 15.247(b) and RSS-247 5.4 (4) Transmitter output power and e.i.r.p. requirements
 FCC Part 15 Subpart C and RSS-247, Issue 1

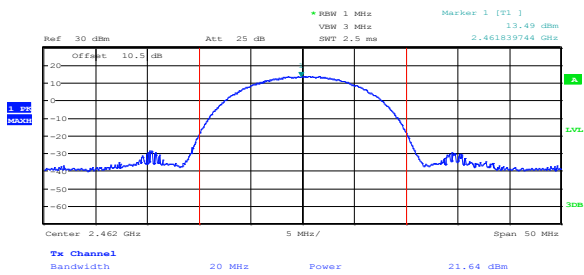

Date: 30.AUG.2016 11:25:38

Figure 8.3-1: Output power for 802.11b, sample plot

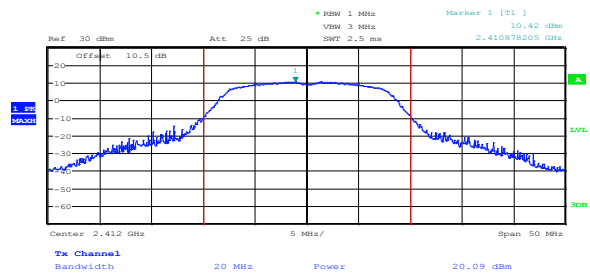

Date: 30.AUG.2016 11:33:07

Figure 8.3-2: Output power for 802.11g, sample plot

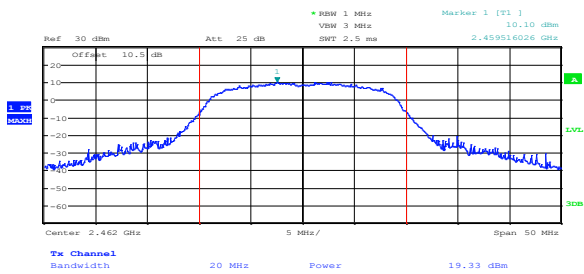

Date: 30.AUG.2016 11:38:05

Figure 8.3-3: Output power for 802.11n HT20, sample plot

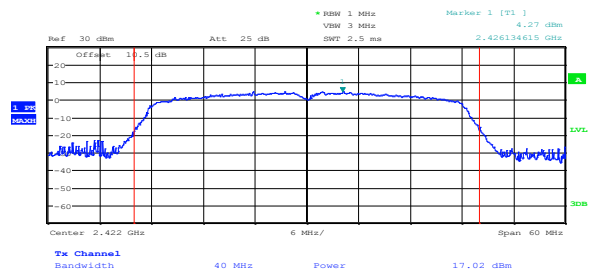

Date: 30.AUG.2016 14:13:00

Figure 8.3-4: Output power for 802.11n HT40, sample plot

8.4 FCC 15.247(d) and RSS-247 5.5 Spurious (out-of-band) emissions

8.4.1 Definitions and limits

FCC:

In any 100 kHz bandwidth outside the frequency band in which the spread spectrum or digitally modulated intentional radiator is operating, the radio frequency power that is produced by the intentional radiator shall be at least 20 dB below that in the 100 kHz bandwidth within the band that contains the highest level of the desired power, based on either an RF conducted or a radiated measurement, provided the transmitter demonstrates compliance with the peak conducted power limits. If the transmitter complies with the conducted power limits based on the use of RMS averaging over a time interval, as permitted under paragraph (b)(3) of this section, the attenuation required under this paragraph shall be 30 dB instead of 20 dB. Attenuation below the general limits specified in §15.209(a) is not required. In addition, radiated emissions which fall in the restricted bands, as defined in §15.205(a), must also comply with the radiated emission limits specified in §15.209(a) (see §15.205(c)).

IC:

In any 100 kHz bandwidth outside the frequency band in which the spread spectrum or digitally modulated device is operating, the RF power that is produced shall be at least 20 dB below that in the 100 kHz bandwidth within the band that contains the highest level of the desired power, based on either an RF conducted or a radiated measurement, provided that the transmitter demonstrates compliance with the peak conducted power limits. If the transmitter complies with the conducted power limits based on the use of root-mean-square averaging over a time interval, as permitted under Section 5.4(4), the attenuation required shall be 30 dB instead of 20 dB. Attenuation below the general field strength limits specified in RSS-Gen is not required.

Table 8.4-1: FCC §15.209 and RSS-Gen – Radiated emission limits

Frequency, MHz	Field strength of emissions		Measurement distance, m
	µV/m	dBµV/m	
0.009–0.490	2400/F	67.6 – 20 × log ₁₀ (F)	300
0.490–1.705	24000/F	87.6 – 20 × log ₁₀ (F)	30
1.705–30.0	30	29.5	30
30–88	100	40.0	3
88–216	150	43.5	3
216–960	200	46.0	3
above 960	500	54.0	3

Notes: In the emission table above, the tighter limit applies at the band edges.

For frequencies above 1 GHz the limit on peak RF emissions is 20 dB above the maximum permitted average emission limit applicable to the equipment under test

Table 8.4-2: IC restricted frequency bands

MHz	MHz	MHz	GHz
0.090–0.110	12.51975–12.52025	399.9–410	5.35–5.46
2.1735–2.1905	12.57675–12.57725	608–614	7.25–7.75
3.020–3.026	13.36–13.41	960–1427	8.025–8.5
4.125–4.128	16.42–16.423	1435–1626.5	9.0–9.2
4.17725–4.17775	16.69475–16.69525	1645.5–1646.5	9.3–9.5
4.20725–4.20775	16.80425–16.80475	1660–1710	10.6–12.7
5.677–5.683	25.5–25.67	1718.8–1722.2	13.25–13.4
6.215–6.218	37.5–38.25	2200–2300	14.47–14.5
6.26775–6.26825	73–74.6	2310–2390	15.35–16.2
6.31175–6.31225	74.8–75.2	2655–2900	17.7–21.4
8.291–8.294	108–138	3260–3267	22.01–23.12
8.362–8.366	156.52475–156.52525	3332–3339	23.6–24.0
8.37625–8.38675	156.7–156.9	3345.8–3358	31.2–31.8
8.41425–8.41475	240–285	3500–4400	36.43–36.5
12.29–12.293	322–335.4	4500–5150	Above 38.6

Note: Certain frequency bands listed in Table 8.4-2 and above 38.6 GHz are designated for low-power licence-exempt applications. These frequency bands and the requirements that apply to the devices are set out in this Standard

Table 8.4-3: FCC restricted frequency bands

MHz	MHz	MHz	GHz
0.090–0.110	16.42–16.423	399.9–410	4.5–5.15
0.495–0.505	16.69475–16.69525	608–614	5.35–5.46
2.1735–2.1905	16.80425–16.80475	960–1240	7.25–7.75
4.125–4.128	25.5–25.67	1300–1427	8.025–8.5
4.17725–4.17775	37.5–38.25	1435–1626.5	9.0–9.2
4.20725–4.20775	73–74.6	1645.5–1646.5	9.3–9.5
6.215–6.218	74.8–75.2	1660–1710	10.6–12.7
6.26775–6.26825	108–121.94	1718.8–1722.2	13.25–13.4
6.31175–6.31225	123–138	2200–2300	14.47–14.5
8.291–8.294	149.9–150.05	2310–2390	15.35–16.2
8.362–8.366	156.52475–156.52525	2483.5–2500	17.7–21.4
8.37625–8.38675	156.7–156.9	2690–2900	22.01–23.12
8.41425–8.41475	162.0125–167.17	3260–3267	23.6–24.0
12.29–12.293	167.72–173.2	3332–3339	31.2–31.8
12.51975–12.52025	240–285	3345.8–3358	36.43–36.5
12.57675–12.57725	322–335.4	3600–4400	Above 38.6
13.36–13.41			

8.4.2 Test summary

Test date	August 30, 2016	Temperature	23 °C
Test engineer	Andrey Adelberg	Air pressure	1007 mbar
Verdict	Pass	Relative humidity	35 %

8.4.3 Observations, settings and special notes

The spectrum was searched from 30 MHz to the 10th harmonic.

EUT was set to transmit with 100 % duty cycle.

Radiated measurements were performed at a distance of 3 m, the EUT was transmitting on both MIMO chains simultaneously.

Since fundamental power was tested using peak method, the spurious emissions limit is –20 dBc/100 kHz

Spectrum analyser settings for radiated measurements within restricted bands below 1 GHz:

Resolution bandwidth:	100 kHz
Video bandwidth:	300 kHz
Detector mode:	Peak
Trace mode:	Max Hold

Spectrum analyser settings for peak radiated measurements within restricted bands above 1 GHz:

Resolution bandwidth:	1 MHz
Video bandwidth:	3 MHz
Detector mode:	Peak
Trace mode:	Max Hold

Spectrum analyser settings for average radiated measurements within restricted bands above 1 GHz:

Resolution bandwidth:	1 MHz
Video bandwidth:	10 Hz
Detector mode:	Peak
Trace mode:	Max Hold

Spectrum analyser settings for conducted spurious emissions measurements:

Resolution bandwidth:	100 kHz
Video bandwidth:	300 kHz
Detector mode:	Peak
Trace mode:	Max Hold

8.4.4 Test data

Table 8.4-4: Radiated field strength measurement results for 802.11b

Channel	Frequency, MHz	Peak Field strength, dB μ V/m		Margin, dB	Average Field strength, dB μ V/m		Margin, dB
		Measured	Limit		Measured	Limit	
Low	2390	57.88	74.00	16.12	49.52	54.00	4.48
High	2483.5	61.75	74.00	12.25	51.12	54.00	2.88

Notes: Field strength includes correction factor of antenna, cable loss, amplifier, and attenuators where applicable.

Table 8.4-5: Radiated field strength measurement results for 802.11g

Channel	Frequency, MHz	Peak Field strength, dB μ V/m		Margin, dB	Average Field strength, dB μ V/m		Margin, dB
		Measured	Limit		Measured	Limit	
Low	2390	68.36	74.00	5.64	50.66	54.00	3.34
High	2483.5	70.12	74.00	3.88	50.27	54.00	3.73

Notes: Field strength includes correction factor of antenna, cable loss, amplifier, and attenuators where applicable.

Table 8.4-6: Radiated field strength measurement results for 802.11n HT20

Channel	Frequency, MHz	Peak Field strength, dB μ V/m		Margin, dB	Average Field strength, dB μ V/m		Margin, dB
		Measured	Limit		Measured	Limit	
Low	2390	66.22	74.00	7.78	49.39	54.00	4.61
High	2483.5	71.78	74.00	2.22	51.61	54.00	2.39

Notes: Field strength includes correction factor of antenna, cable loss, amplifier, and attenuators where applicable.

Table 8.4-7: Radiated field strength measurement results for 802.11n HT40

Channel	Frequency, MHz	Peak Field strength, dB μ V/m		Margin, dB	Average Field strength, dB μ V/m		Margin, dB
		Measured	Limit		Measured	Limit	
Low	2390	68.27	74.00	5.73	49.89	54.00	4.11
High	2483.5	68.13	74.00	5.87	49.20	54.00	4.80

Notes: Field strength includes correction factor of antenna, cable loss, amplifier, and attenuators where applicable.

Table 8.4-8: Radiated field strength measurement results for MIMO 802.11n HT20

Channel	Frequency, MHz	Peak Field strength, dB μ V/m		Margin, dB	Average Field strength, dB μ V/m		Margin, dB
		Measured	Limit		Measured	Limit	
Low	2390	72.35	74.00	1.65	52.98	54.00	1.02
High	2483.5	72.84	74.00	1.16	52.50	54.00	1.50

Notes: Field strength includes correction factor of antenna, cable loss, amplifier, and attenuators where applicable.

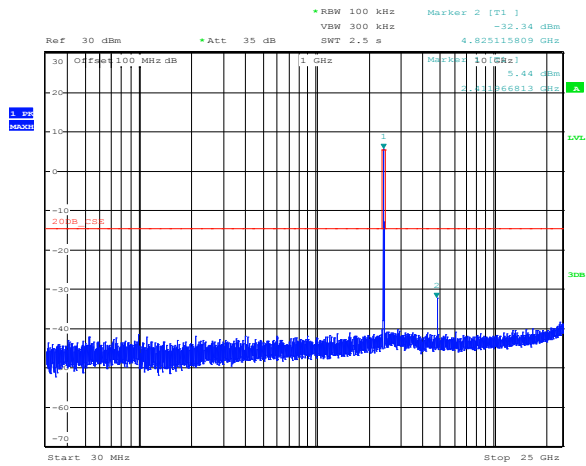

Date: 1.SEP.2016 14:47:45

Figure 8.4-1: Conducted spurious emissions for 802.11b, low channel

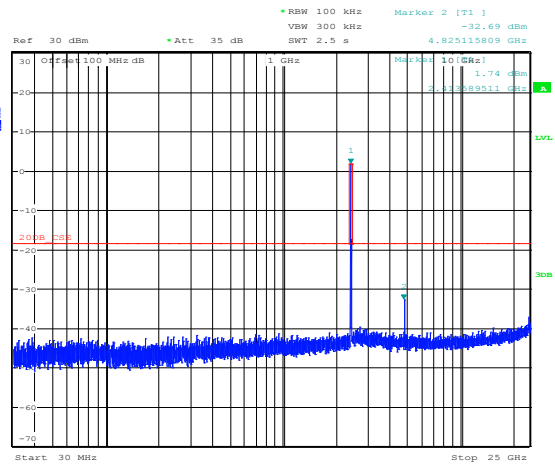

Date: 1.SEP.2016 14:53:38

Figure 8.4-2: Conducted spurious emissions for 802.11g, low channel

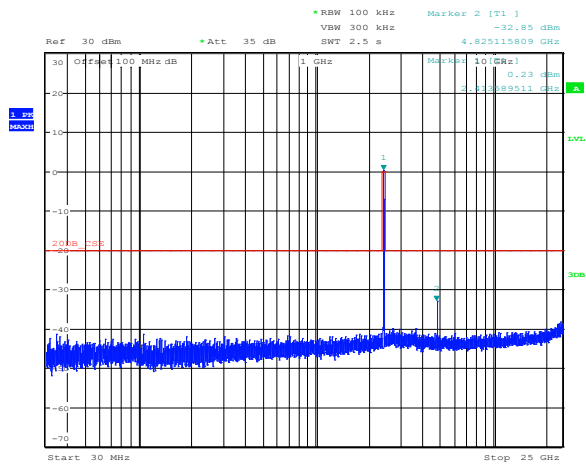

Date: 1.SEP.2016 15:59:46

Figure 8.4-3: Conducted spurious emissions for 802.11n HT20, low channel

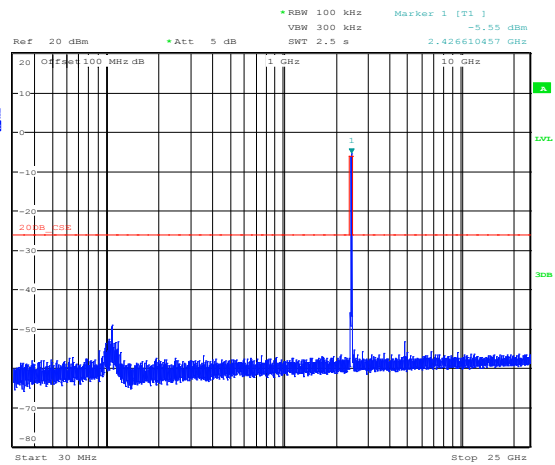

Date: 30.AUG.2016 16:50:42

Figure 8.4-4: Conducted spurious emissions for 802.11n HT40, low channel

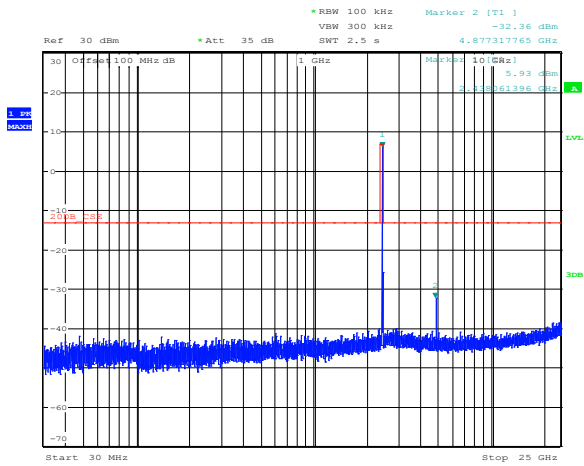

Date: 1.SEP.2016 14:46:05

Figure 8.4-5: Conducted spurious emissions for 802.11b, mid channel

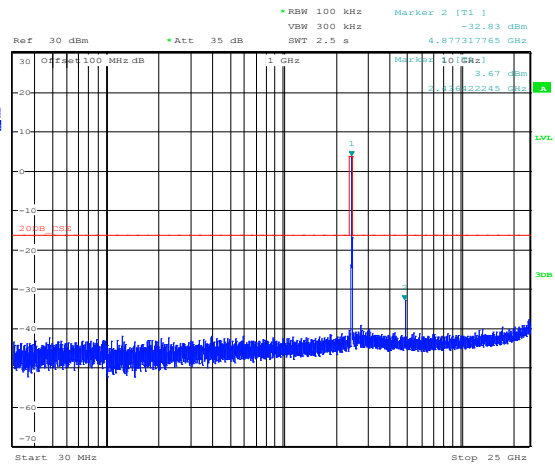

Date: 1.SEP.2016 14:55:29

Figure 8.4-6: Conducted spurious emissions for 802.11g, mid channel

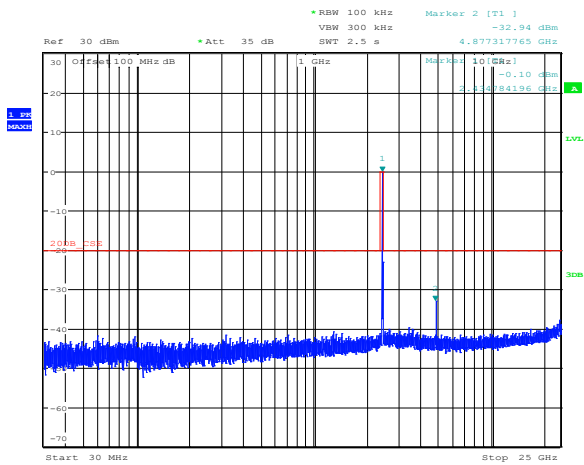

Date: 1.SEP.2016 16:00:40

Figure 8.4-7: Conducted spurious emissions for 802.11n HT20, mid channel

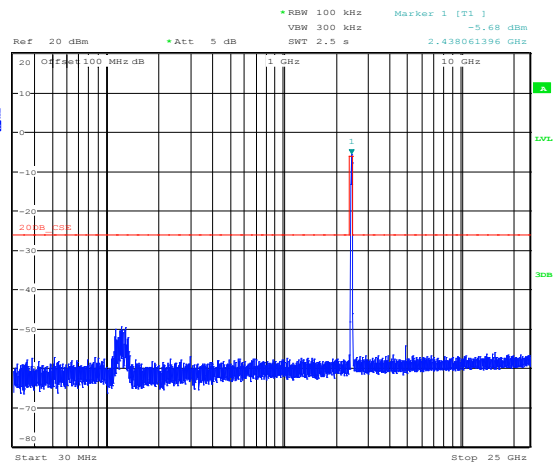

Date: 30.AUG.2016 16:49:03

Figure 8.4-8: Conducted spurious emissions for 802.11n HT40, mid channel

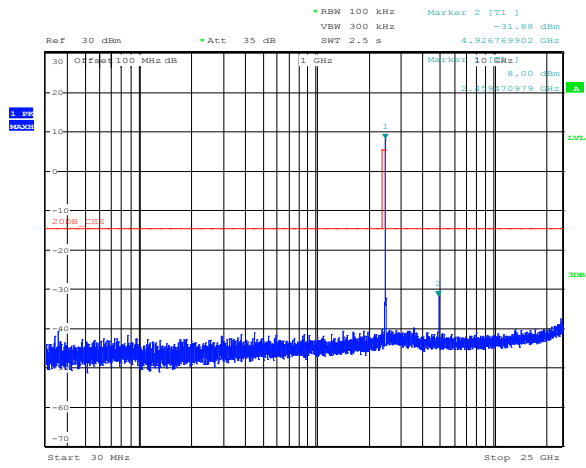

Date: 1.SEP.2016 14:48:50

Figure 8.4-9: Conducted spurious emissions for 802.11b, high channel

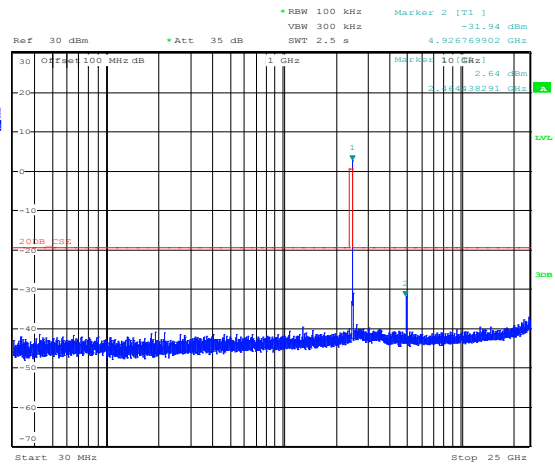

Date: 1.SEP.2016 14:59:25

Figure 8.4-10: Conducted spurious emissions for 802.11g, high channel

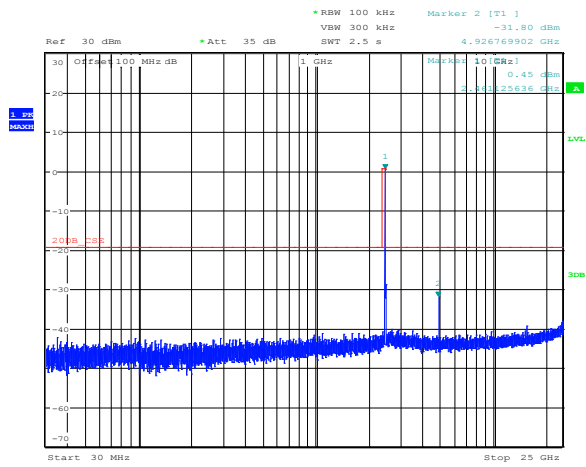

Date: 1.SEP.2016 16:23:22

Figure 8.4-11: Conducted spurious emissions for 802.11n HT20, high channel

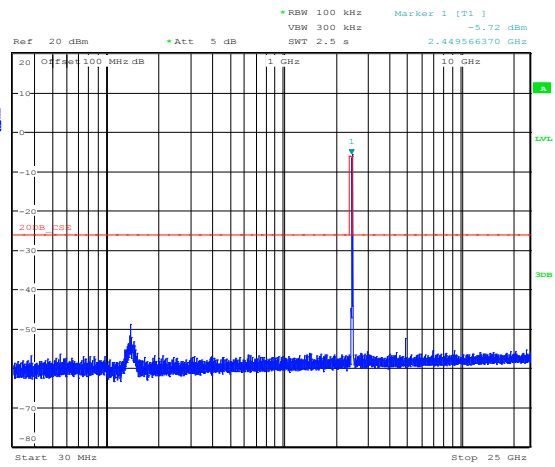

Date: 30.AUG.2016 16:47:50

Figure 8.4-12: Conducted spurious emissions for 802.11n HT40, high channel

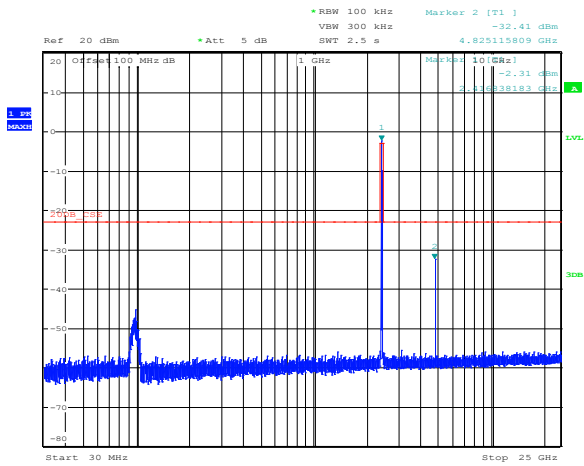

Date: 1.SEP.2016 14:09:31

Figure 8.4-13: Conducted spurious emissions for MIMO, low channel, cho

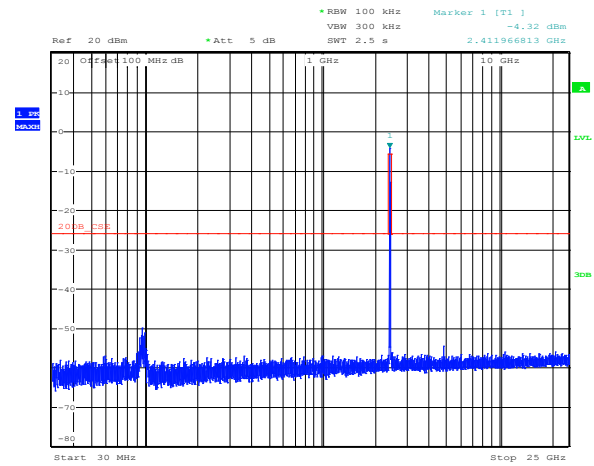

Date: 31.AUG.2016 16:59:15

Figure 8.4-14: Conducted spurious emissions for MIMO, low channel, ch1

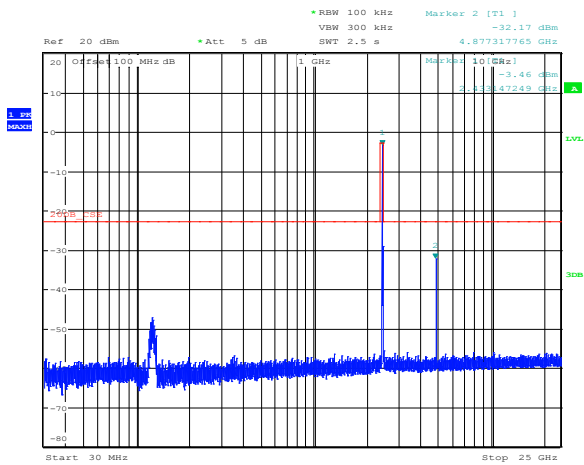

Date: 1.SEP.2016 14:14:22

Figure 8.4-15: Conducted spurious emissions for MIMO, mid channel, cho

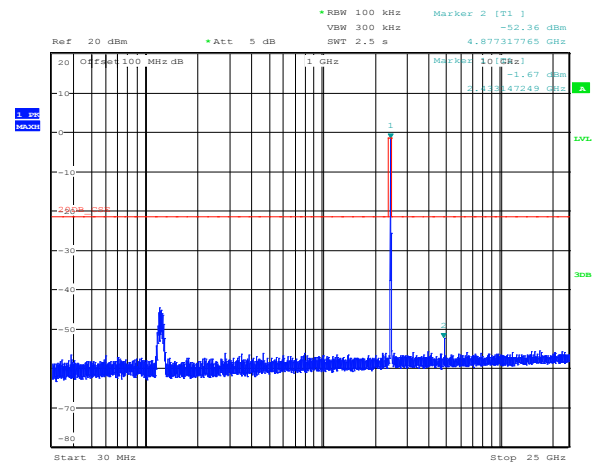

Date: 31.AUG.2016 16:54:25

Figure 8.4-16: Conducted spurious emissions for MIMO, mid channel, ch1

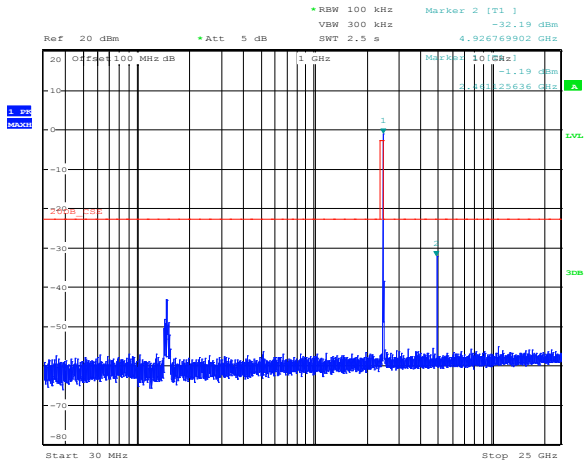

Date: 1.SEP.2016 14:15:42

Figure 8.4-17: Conducted spurious emissions for MIMO, high channel, cho

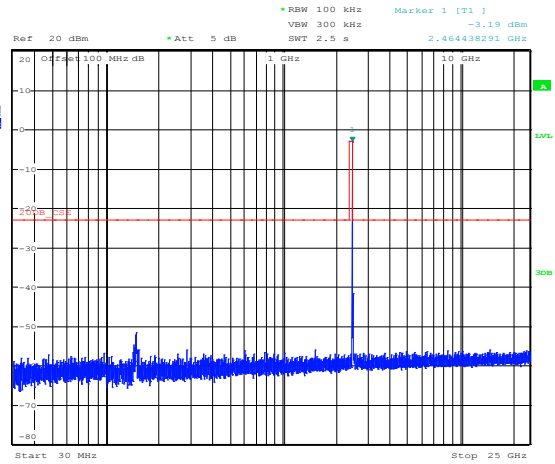

Date: 31.AUG.2016 17:01:47

Figure 8.4-18: Conducted spurious emissions for MIMO, high channel, ch1

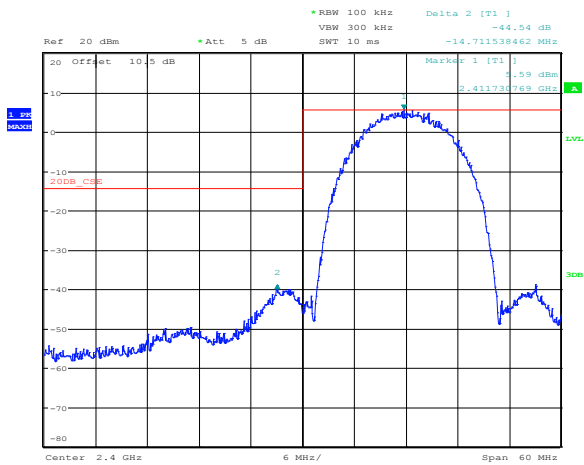

Date: 30.AUG.2016 16:35:52

Figure 8.4-19: Conducted lower band edge emissions for 802.11b

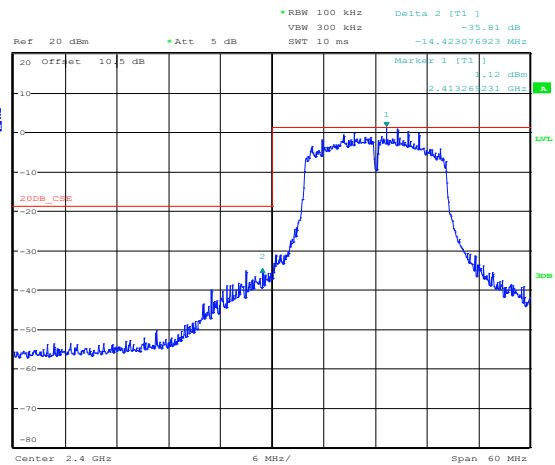

Date: 30.AUG.2016 16:35:07

Figure 8.4-20: Conducted lower band edge emissions for 802.11g

Section 8
Test name
Specification

Testing data
 FCC 15.247(d) and RSS-247 5.5 Spurious (out-of-band) emissions
 FCC Part 15 Subpart C and RSS-247, Issue 1

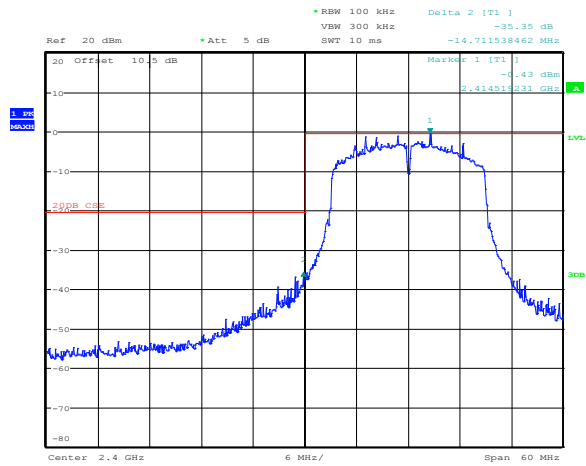

Date: 30.AUG.2016 16:33:59

Figure 8.4-21: Conducted lower band edge emissions for 802.11n HT40

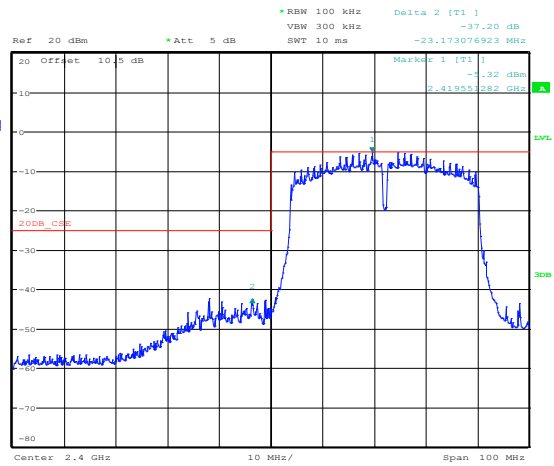

Date: 30.AUG.2016 16:39:42

Figure 8.4-22: Conducted lower band edge emissions for 802.11n HT40

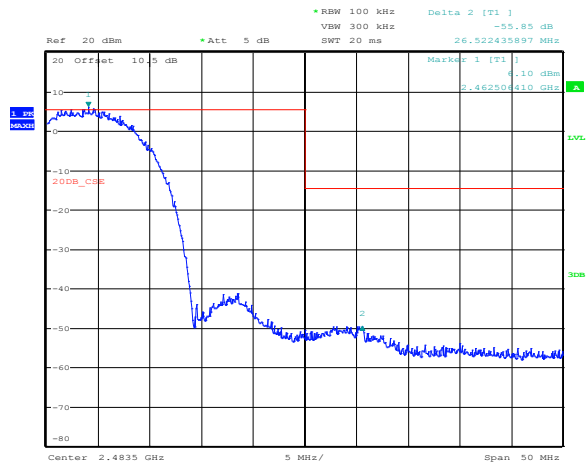

Date: 30.AUG.2016 16:29:33

Figure 8.4-23: Conducted upper band edge emissions for 802.11b

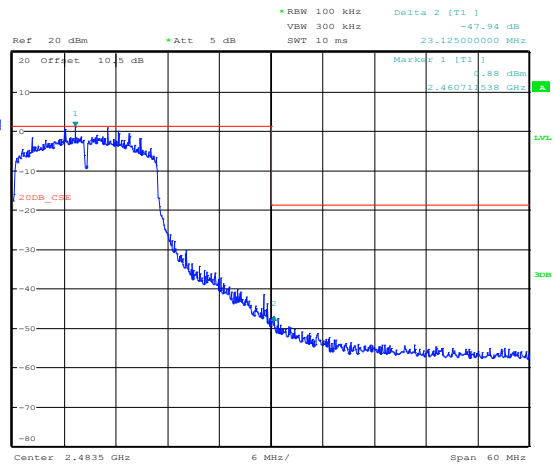

Date: 30.AUG.2016 16:30:36

Figure 8.4-24: Conducted upper band edge emissions for 802.11g

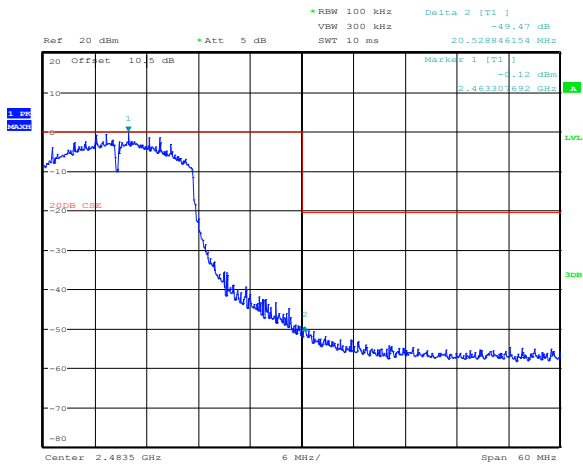

Date: 30.AUG.2016 16:31:54

Figure 8.4-25: Conducted upper band edge emissions for 802.11n HT20

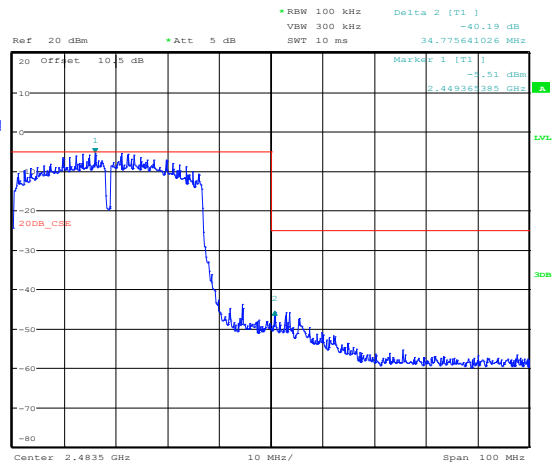

Date: 30.AUG.2016 16:43:18

Figure 8.4-26: Conducted upper band edge emissions for 802.11n HT40

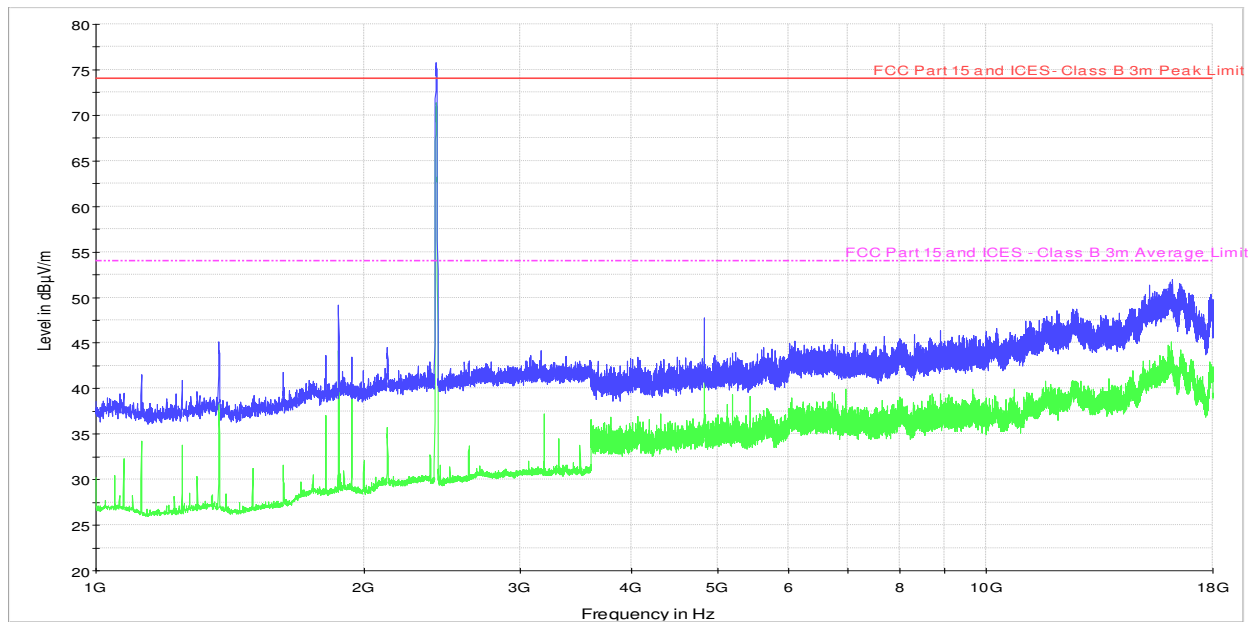

Figure 8.4-27: Radiated spurious emissions for 802.11b, sample plot

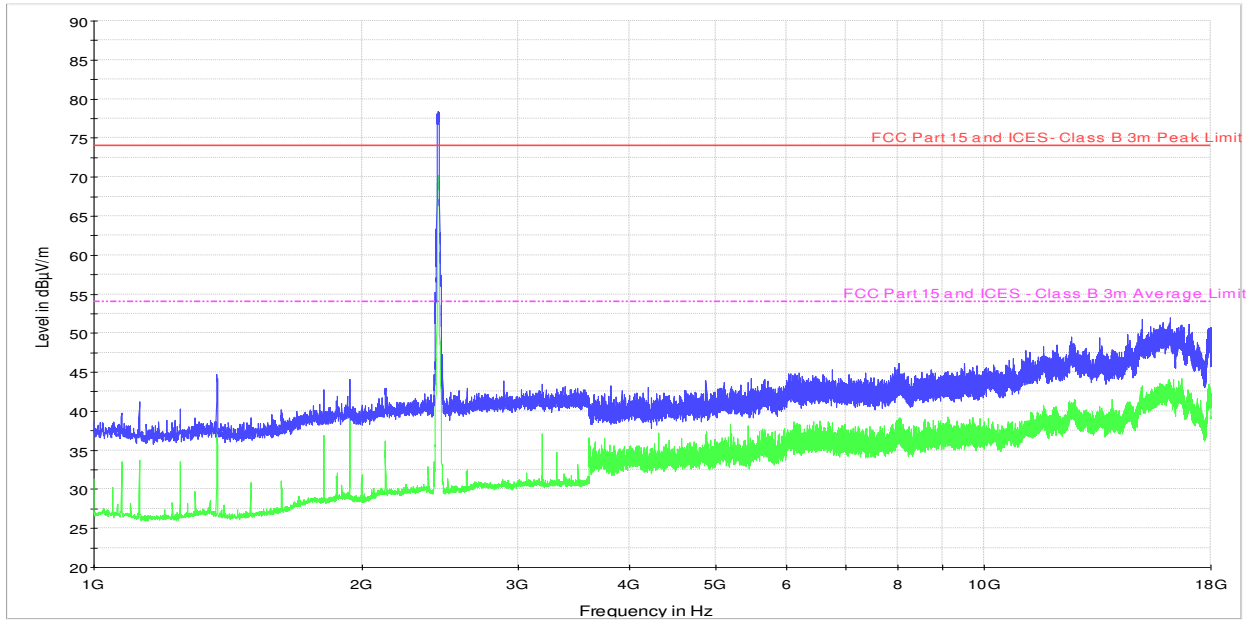

Figure 8.4-28: Radiated spurious emissions for 802.11g, sample plot

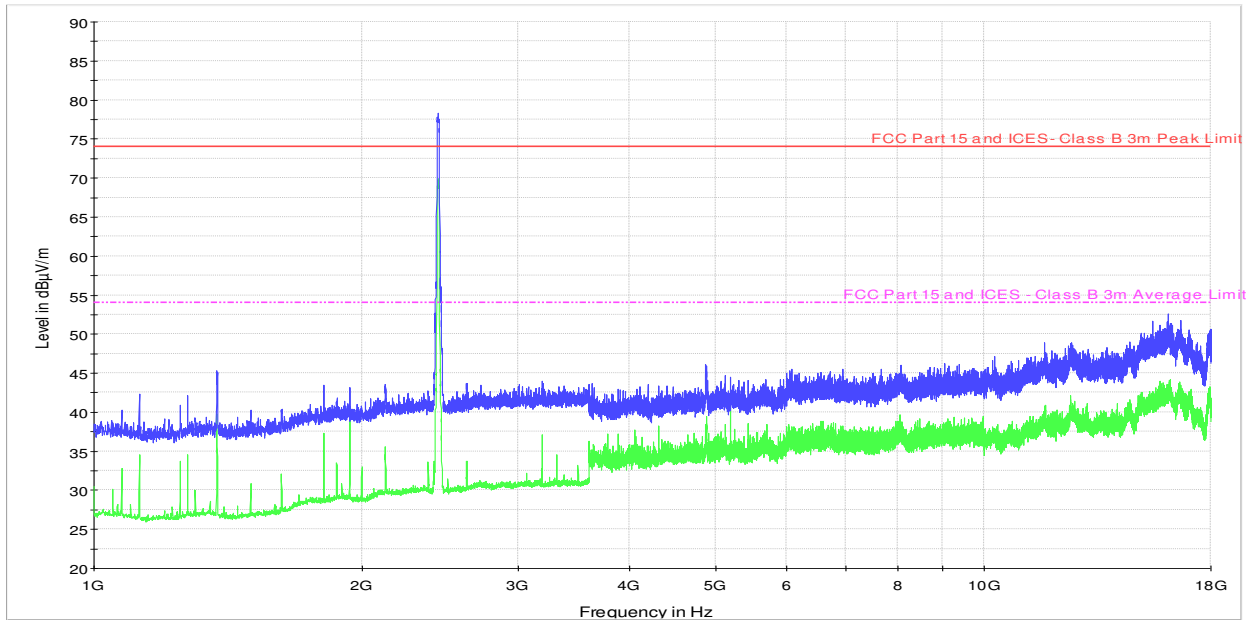

Figure 8.4-29: Radiated spurious emissions for 802.11n HT20, sample plot

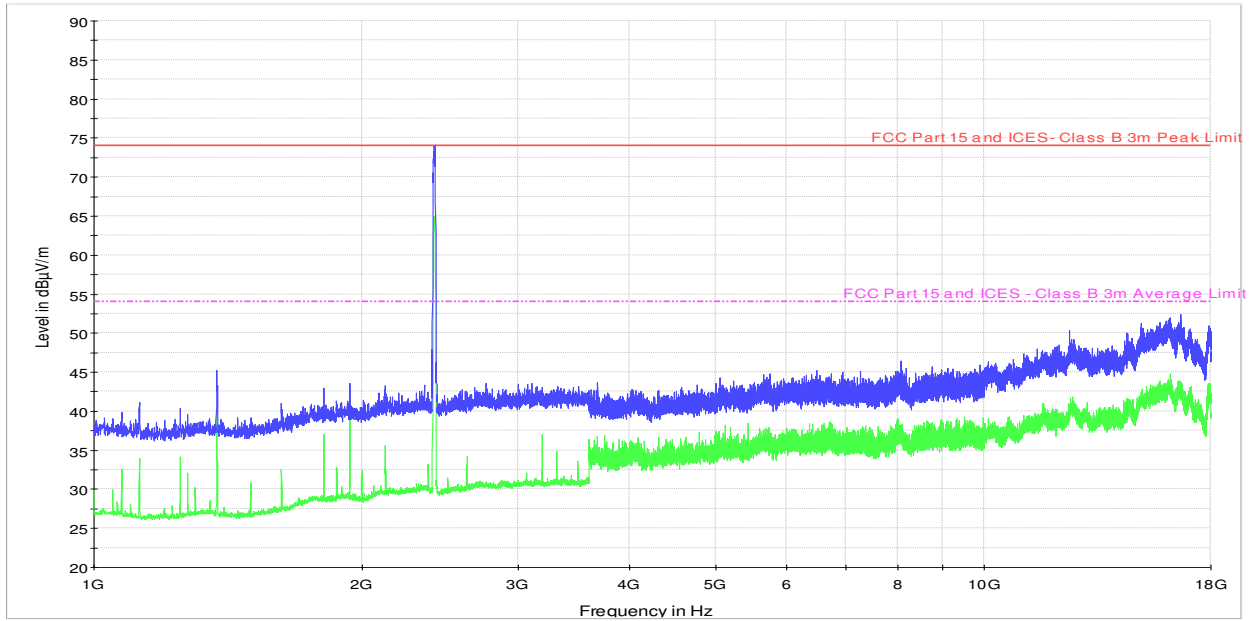

Figure 8.4-30: Radiated spurious emissions for 802.11n HT40, sample plot

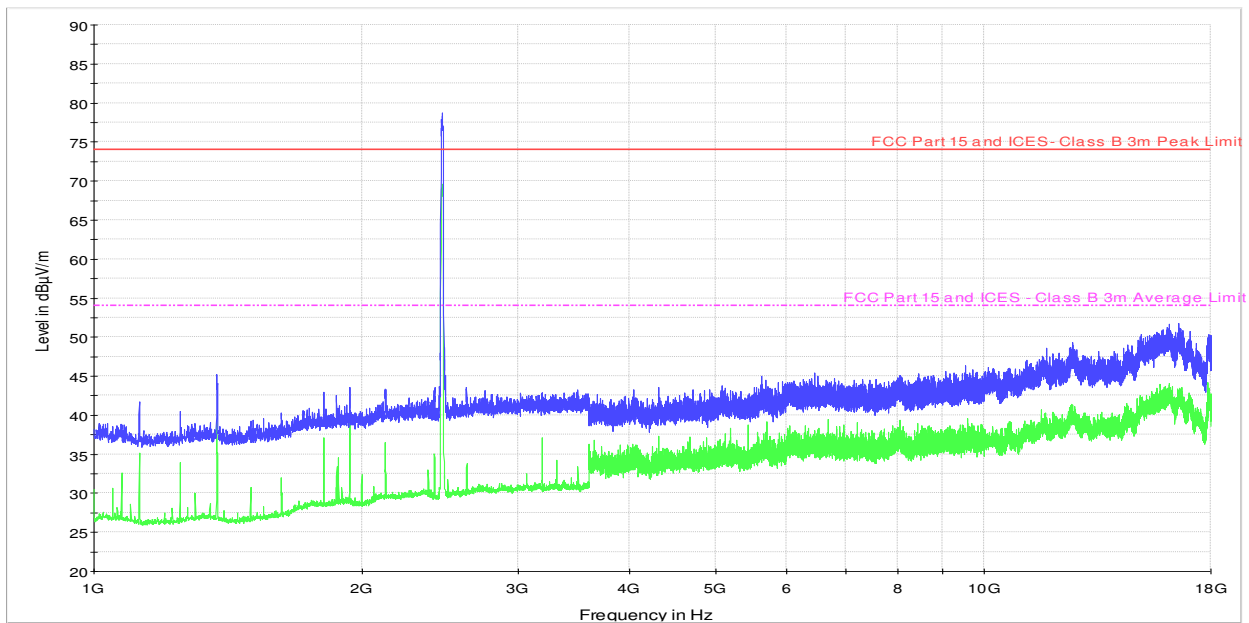

Figure 8.4-31: Radiated spurious emissions for MIMO 802.11n HT20, sample plot

8.5 FCC 15.247(e) and RSS-247 5.2(2) Power spectral density for digitally modulated devices

8.5.1 Definitions and limits

FCC:

For digitally modulated systems, the power spectral density conducted from the intentional radiator to the antenna shall not be greater than 8 dBm in any 3 kHz band during any time interval of continuous transmission. This power spectral density shall be determined in accordance with the provisions of paragraph (b) of this section. The same method of determining the conducted output power shall be used to determine the power spectral density.

IC:

The transmitter power spectral density conducted from the transmitter to the antenna shall not be greater than 8 dBm in any 3 kHz band during any time interval of continuous transmission. This power spectral density shall be determined in accordance with the provisions of Section 5.4(4), (i.e. the power spectral density shall be determined using the same method as is used to determine the conducted output power).

8.5.2 Test summary

Test date	August 30, 2016	Temperature	23 °C
Test engineer	Andrey Adelberg	Air pressure	1007 mbar
Verdict	Pass	Relative humidity	35 %

8.5.3 Observations, settings and special notes

The test was performed using method described in section 10.2 Method PKPSD. Spectrum analyser settings:

Resolution bandwidth:	3 kHz
Video bandwidth:	10 kHz
Frequency span:	30 MHz (802.11b, 802.11g and 802.11n HT20) and to 55 MHz (for 802.11n HT40)
Detector mode:	Peak
Trace mode:	Max-hold

8.5.4 Test data

Table 8.5-1: PSD measurements results for SISO 1 × 1 application

Modulation	Frequency, MHz	PSD, dBm/3 kHz	PSD limit, dBm/3 kHz	Margin, dB
802.11b	2412	-8.70	8.00	16.70
	2437	-5.53	8.00	13.53
	2462	-8.70	8.00	16.70
802.11g	2412	-12.57	8.00	20.57
	2437	-10.78	8.00	18.78
	2462	-11.87	8.00	19.87
802.11n HT20	2412	-13.77	8.00	21.77
	2437	-11.60	8.00	19.60
	2462	-14.23	8.00	22.23
802.11n HT40	2422	-17.47	8.00	25.47
	2437	-17.29	8.00	25.29
	2452	-19.23	8.00	27.23

Table 8.5-2: PSD measurements results for MIMO 2 × 2 application

Modulation	Frequency, MHz	Measured peak spectral density, dBm/3 kHz			PSD limit, dBm/3 kHz	Margin, dB
		On ch0,	On ch1,	Combined		
802.11n HT20	2412	-14.67	-14.24	-11.44	8.00	19.44
	2437	-12.12	-11.65	-8.87	8.00	16.87
	2462	-14.34	-14.50	-11.41	8.00	19.41

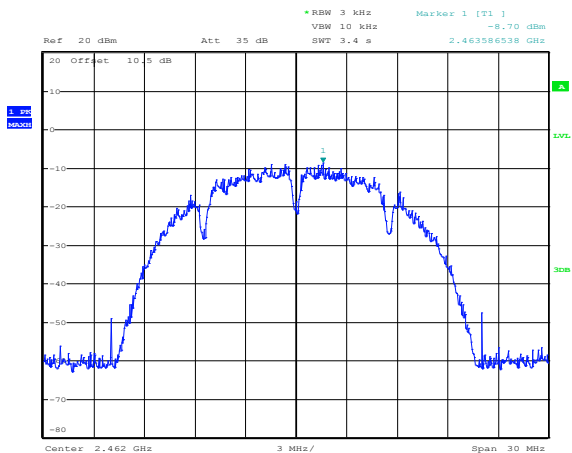

Date: 30.AUG.2016 16:26:09

Figure 8.5-1: PSD sample plot on 802.11b

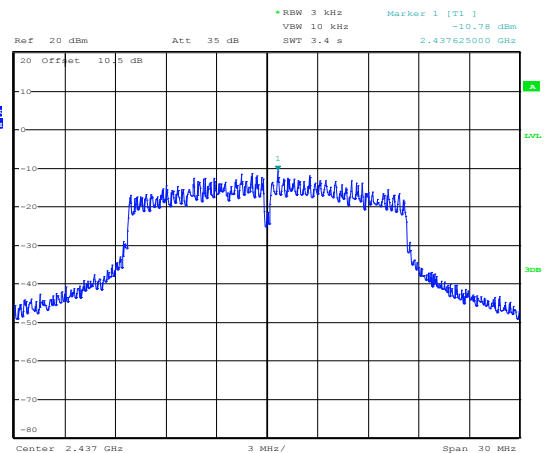

Date: 30.AUG.2016 14:56:17

Figure 8.5-2: PSD sample plot on 802.11g

Section 9. Block diagrams of test set-ups

9.1 Radiated emissions set-up for frequencies below 1 GHz

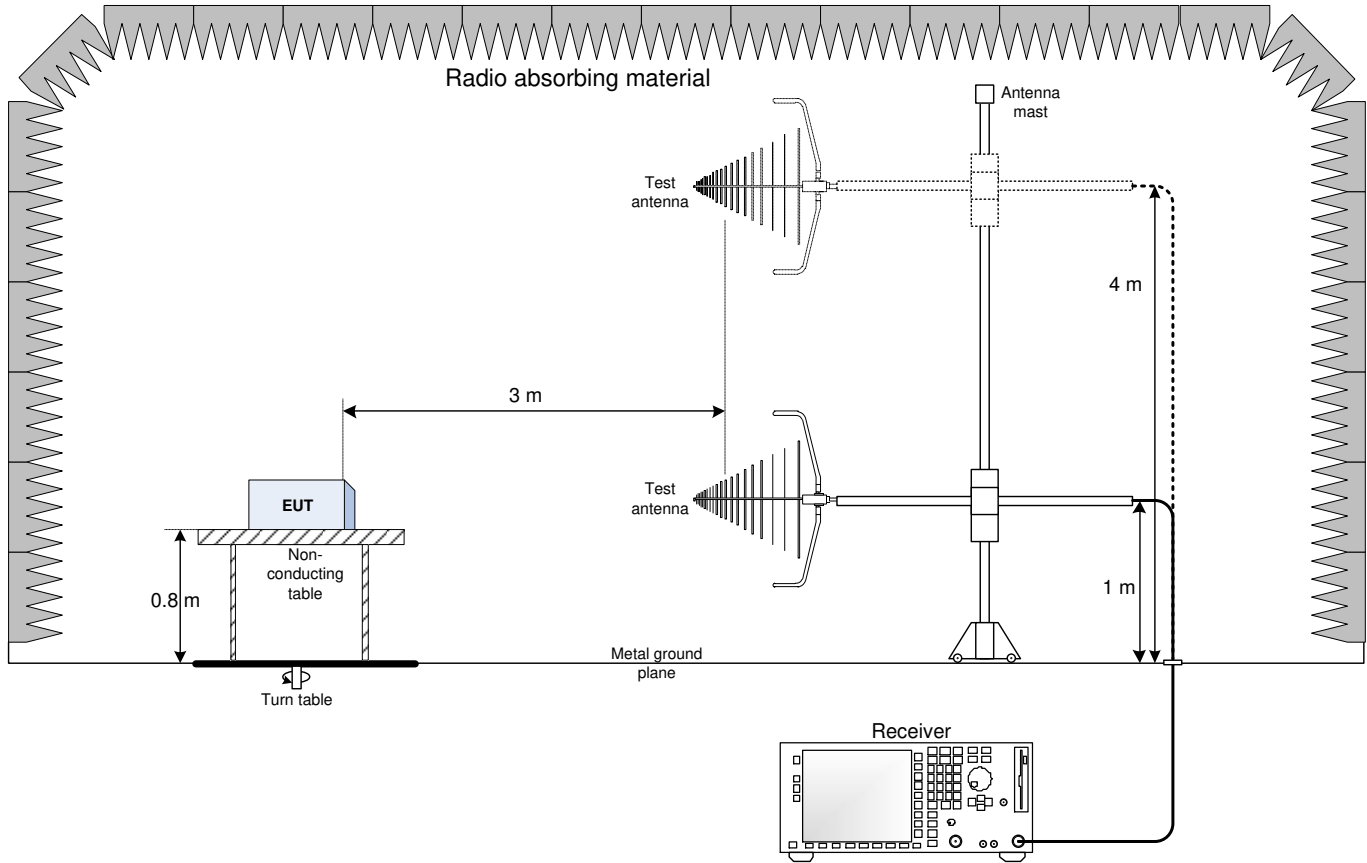

9.2 Radiated emissions set-up for frequencies above 1 GHz

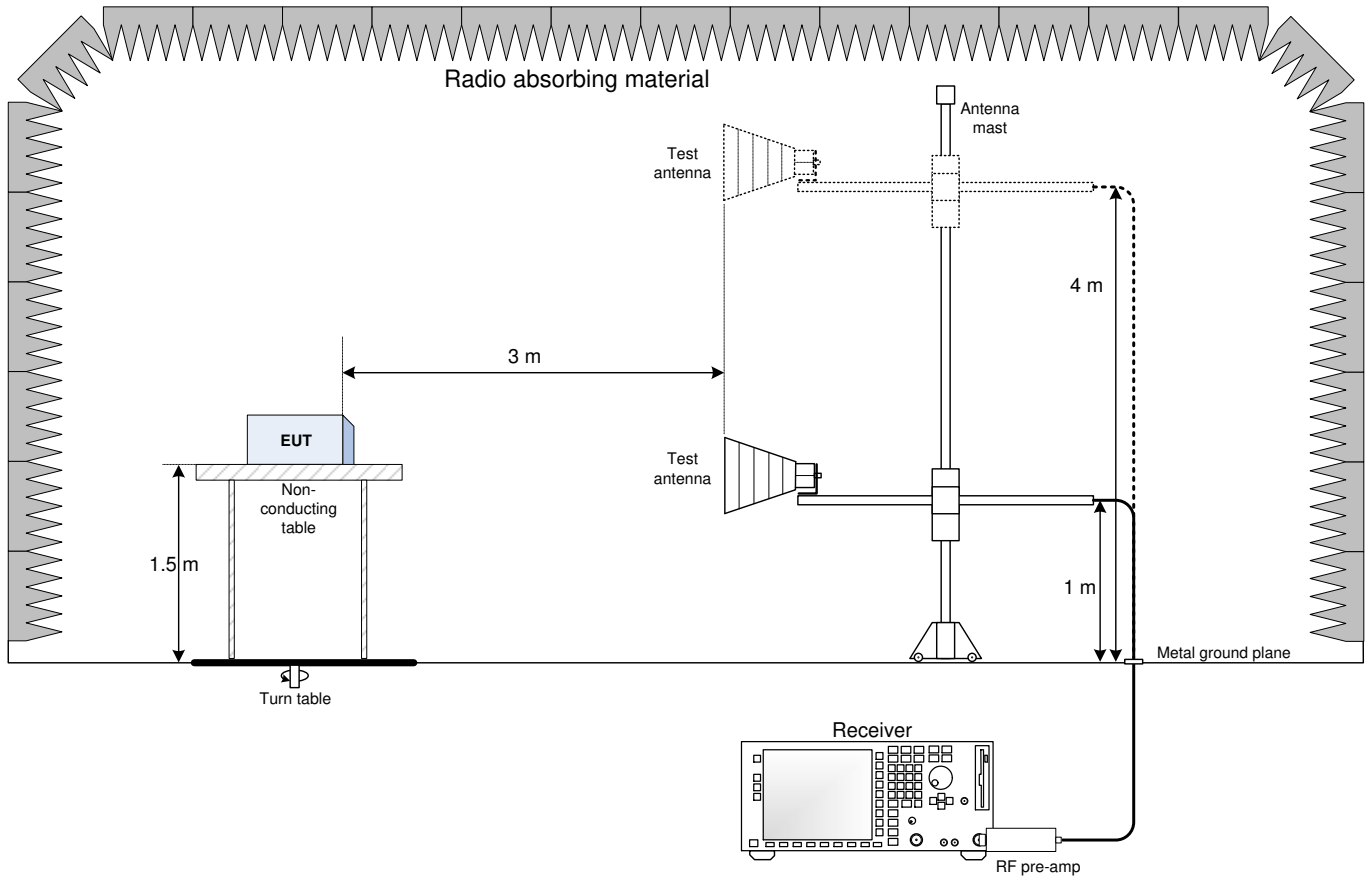

9.3 Conducted emissions set-up

