



Via C. Marx, 138 41012 Carpi (Mo)
Tel. +39 059 6232111
Fax. +39 059 6323298
P. I.V.A. 00172950362

Rider Recognition System Manual

MOD07XX06

Project number:

P1364

Compiler:

Alessandro Serafini

Date:

29/11/2016

Rider Recognition System

User Manual



Via C. Marx, 138 41012 Carpi (Mo)
 Tel. +39 059 6232111
 Fax. +39 059 6323298
 P. I.V.A. 00172950362

Rider Recognition System Manual

MOD07XX06

INDEX

1	DESCRIPTION	4
1.1	KEY ON	5
1.2	KEY OFF	5
1.3	STEERING LOCK	5
1.4	REPLACING THE BATTERY IN THE ACTIVE KEY.....	6
2	INSTALLATION NOTES	8
3	TECHNICAL SPECIFICATION	9
3.1	RRS MAIN UNIT	9
3.1.1	<i>Electrical features</i>	9
3.1.2	<i>Mechanical features</i>	9
3.2	ACTIVE KEY – REMOTE CONTROL	9
3.2.1	<i>Electrical features</i>	9
3.2.2	<i>Mechanical features</i>	9
4	CERTIFICATIONS	10
4.1	USA CERTIFICATION	10
4.2	WARNINGS	10

1 Description

The Rider Recognition System (RRS) is a mechatronic system which fully integrated "Automatic Main Switch and Steering Lock" for motorbikes.

The system is composed by:

- the **main unit** (1), which provides the following function:
 - o user recognizer, by means of an **active key** (2) or a **passive key** (3);
 - o the Lock and Unlock of the steering, by moving the **bolt** (7);
 - o the enable and disable of the ignition of the bike;
- the **active key** (2);
- the **passive key**, an RFID transponder (3).

The RRS combines the transponder functionality (LF, *Low Frequency*) and the radio controller transmission (HF, *High Frequency*) to recognize the right user of the motorbike.

The RRS can manage the **Fuel Tank Cap** (4) opening.

The system is integrated on CAN bus for all data transfer with the other electronic units on the motorbike.

The Keyless E-lock is customized in the connectors used on the wiring and in the strategy of function by the motorbike manufacture.

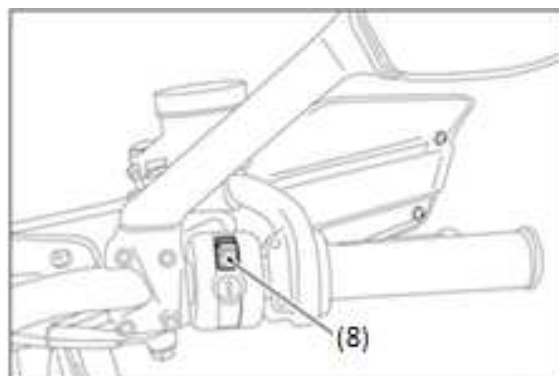
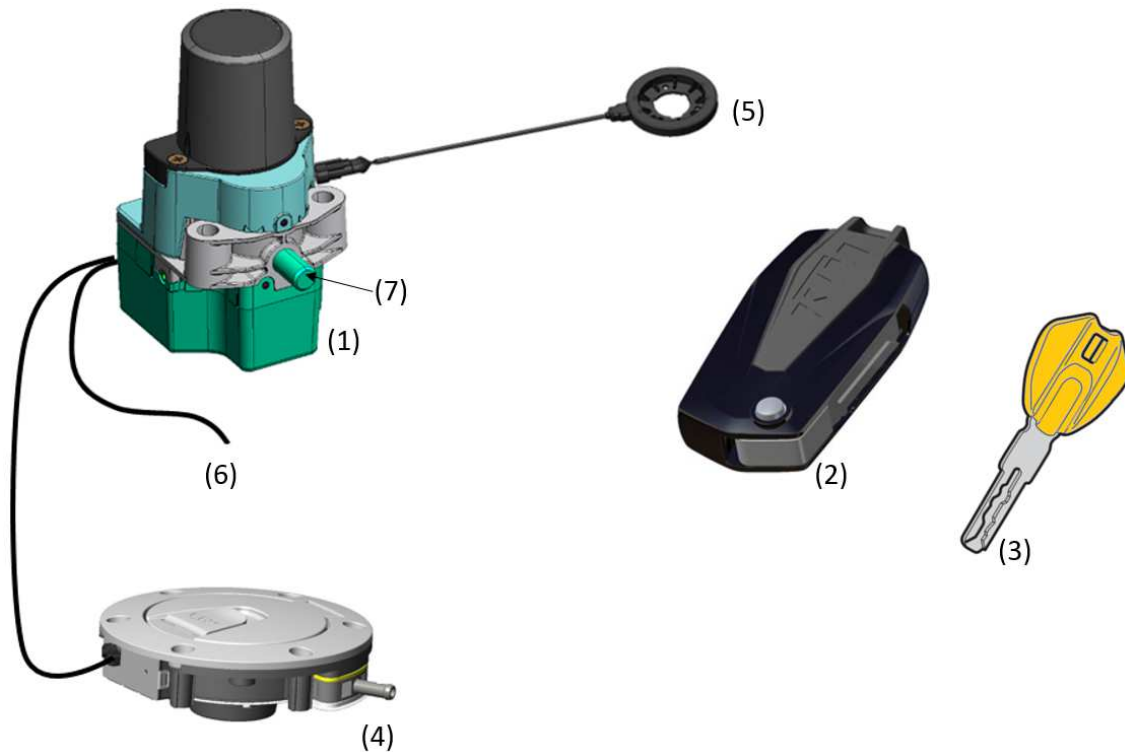

1.1 Key ON

The user recognizing with the active key (2) is performed as described below:

- press the Lock/Unlock button (8) on the handlebar of the motorbike for less than 1 second;
- the main unit (1) requires a radio frequency identification to the key (2 or 3) with an LF signal transmitted by the LF antenna (5);
- if the active key (2) is within a range of approx. 1.5 m and the battery is charged, replies to the main unit (1) by transmitting its ID via an HF signal;
- the main unit (2) receives the information through the HF antenna (6);
- if the main unit (2) recognizes the active key (2): sets T15 ON, starts the transmission of a periodical message on CAN bus and unlocks the motorbike steering by retracting the bolt (7).

Note: when the battery is discharged, the active key (2) acts like a passive key (3), see the below.

The user recognizing with the passive key (3) is performed as described below:

- press the Lock/Unlock button (8) on the handlebar of the motorbike;
- the main unit (1) requires a radio frequency identification to the key (2 or 3) with an LF signal transmitted by the LF antenna (5);
- if the passive key (3) is within a range of approx. 5 cm near the LF antenna (5), replies to the main unit (1) by transmitting its ID via an LF signal;
- the main unit (2) receives the information through the LF antenna (5);
- if the main unit (2) recognizes the passive key (3): sets T15 ON, starts the transmission of a periodical message on CAN bus and unlocks the motorbike steering by retracting the bolt (7).

1.2 Key OFF

Key-Off occurs when motorcycle speed is equal to zero, by pressing button (6) on the handlebar. Neither active key (2) nor passive key (3) are required.

1.3 Steering lock

To engage the steering lock:

- Stop the motorcycle, then put it on the side stand and fully steer handlebar to the left or to the right;
- press the Lock/Unlock button (8) and hold it depressed for more than 2 second with steering turned completely to the left or to the right: steering lock will be engaged after this time (the bolt of the system (7) goes out).

Note: In case of failed engagement of steering lock, the signal LED will blink 4 times.

1.4 Replacing the battery in the active key

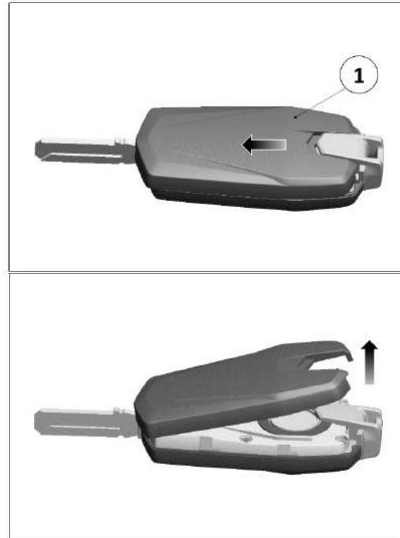

Remove the rear plastic shell (1) of the active key by pushing it forward and lifting it as shown into the images above.

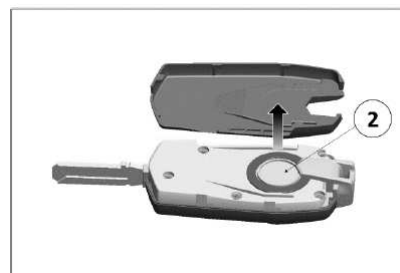

Once removed the plastic shell, pull out the battery protection cap (2).

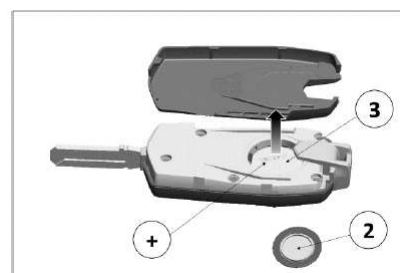

Remove the battery (3) and install a new one.

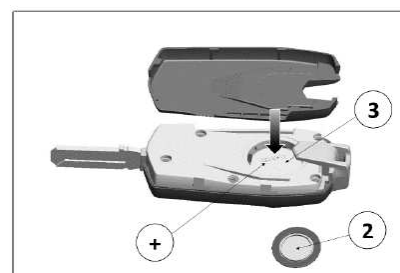

Install the battery into the properly housing and pay attention to the polarity:



positive pole (+) must be facing up.

Important: only use the required type of battery, i.e. CR2032 3.0 Volts.

CAUTION
RISK OF EXPLOSION IF BATTERY IS REPLACED
BY AN INCORRECT TYPE.
DISPOSE OF USED BATTERIES ACCORDING
TO THE INSTRUCTIONS

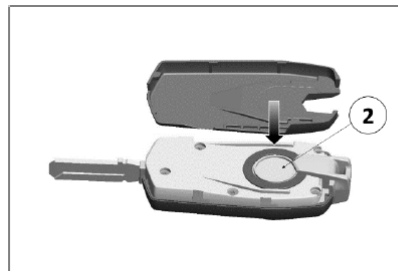

Refit protection cap (2) on the battery.

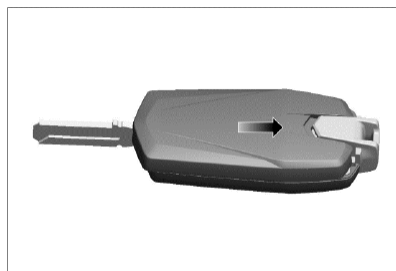

Reinstall the rear plastic shell (1) and push slightly as shown in the figures.

Make sure to close/assembly the shell properly to align the upper and lower shells.



Via C. Marx, 138 41012 Carpi (Mo)
Tel. +39 059 6232111
Fax. +39 059 6323298
P. I.V.A. 00172950362

2 Installation notes

1. Zadi reserves of approve the installation activities on the vehicles.
2. The bolt, in rest position, must allow the overall/complete movements of the steering.
3. Installation Antenna LF: the item must be put in air, far from metallic parts. Every single installation must be agreed and approved by/with Zadi.
4. It is strictly forbidden modify, tamper the harness, antenna and any other device annex to the kit.
5. Harness installation: the harness must be put in place far from the metallic parts and every single installation must be agreed and approved by Zadi.
6. Every single device damaged, MUST be replaced.
7. Active key: it is strictly forbidden have access to the inner electrical component of the active key, except for the battery compartment (to replace the battery exhausted).

3 Technical Specification

3.1 RRS Main Unit

3.1.1 Electrical features

Nominal voltage	13.5V
Operating voltage	7.5-16V
Operating temperature	-25°C @ +85°C
Storage temperature	-45°C @ +90°C
Operating Current consumption	≥ 100mA at 12V
Stand-by Current consumption	≤ 30uA at 12V
Key supply output (+15)	0.05A to 5A max at 25°C
Key supply output (+15)	0.05A to 3A max in temp. range
2 nd Output supply	0.05A to 2A max at 25°C
2 nd Output supply	0.05A to 2A max in temp. range
Operating Frequency LF	134.5 KHz
Operating Frequency HF	868.35 MHz

3.1.2 Mechanical features

Dimensions (without external steering sensing leverages)	69 x 70 x 129 mm
Dimensions (with external steering sensing leverages)	113 x 70 x 129 mm
Weight	590 gr
Bolt PUSH / PULL load	≥ 50 N
External Housing	Aluminium
Protection grade	IP45 (upper part)
Vibration resistance	20 g

3.2 Active Key – Remote control

3.2.1 Electrical features

Battery type	CR2032
Nominal voltage	3V
Operating voltage	2.5-3.16V
Operating temperature	-20°C @ +60°C
Storage temperature	-30°C @ +60°C
Battery life	24 to 30 months
Operating distance for Key-Card	10-150 cm (on air)
Operating distance for passive key	1-5 cm (on air)
Operating Frequency LF	134.5 KHz
Operating Frequency HF	868.35 MHz

3.2.2 Mechanical features

Dimensions (Key closed and without pushbutton)	37.2 x 78.2 x 17.4 mm
Weight	56 g
External Housing	Plastic
Protection grade	IP55



Via C. Marx, 138 41012 Carpi (Mo)
Tel. +39 059 6232111
Fax. +39 059 6323298
P. I.V.A. 00172950362

4 Certifications

4.1 USA Certification

Product name: RRS Main Unit
FCC ID: VFZKLGZADI01

Product name: RRS Active key
FCC ID: VFZKLGKZADI01

4.2 Warnings

This device complies with part 15 of the FCC Rules. Operation is subject to the following two conditions: (1) This device may not cause harmful interference, and (2) this device must accept any interference received, including interference that may cause undesired operation.

FCC§ 15.105 Information to the user statements

This equipment has been tested and found to comply with the limits for a Class B digital device, pursuant to part 15 of the FCC Rules. These limits are designed to provide reasonable protection against harmful interference in a residential installation. This equipment generates, uses and can radiate radio frequency energy and, if not installed and used in accordance with the instructions, may cause harmful interference to radio communications. However, there is no guarantee that interference will not occur in a particular installation. If this equipment does cause harmful interference to radio or television reception, which can be determined by turning the equipment off and on, the user is encouraged to try to correct the interference by one or more of the following measures:

- Reorient or relocate the receiving antenna.
- Increase the separation between the equipment and receiver.
- Connect the equipment into an outlet on a circuit different from that to which the receiver is connected.
- Consult the dealer or an experienced radio/TV technician for help.

FCC § 15.21 -Information to user. *“Changes or modifications not expressly approved by the party responsible for compliance could void the user’s authority to operate the equipment.”*