

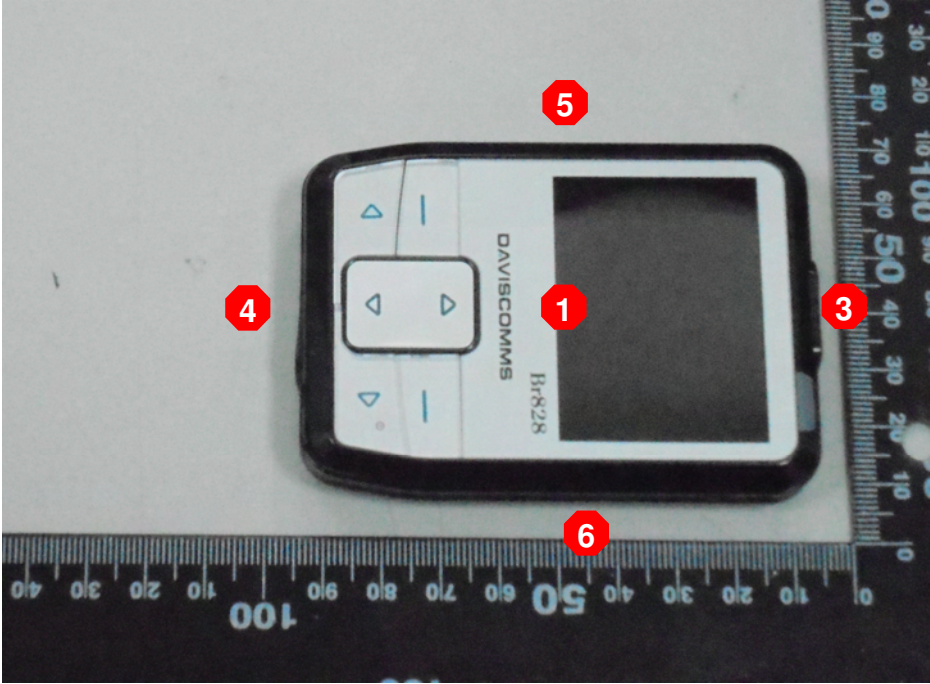

SAR Test Setup Photographs

EUT Side Definition	
Mode	Side
1	Side 1
2	Side 2
3	Side 3
4	Side 4
5	Side 5
6	Side 6





Phantom Position : Flat	EUT side : Side1
Spacing to phantom : 25 mm	Accessory : N/A

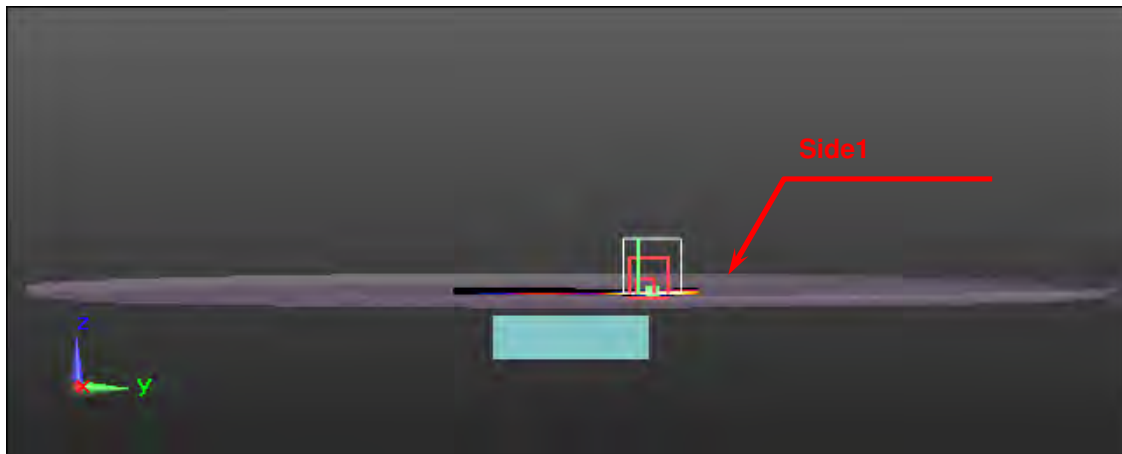
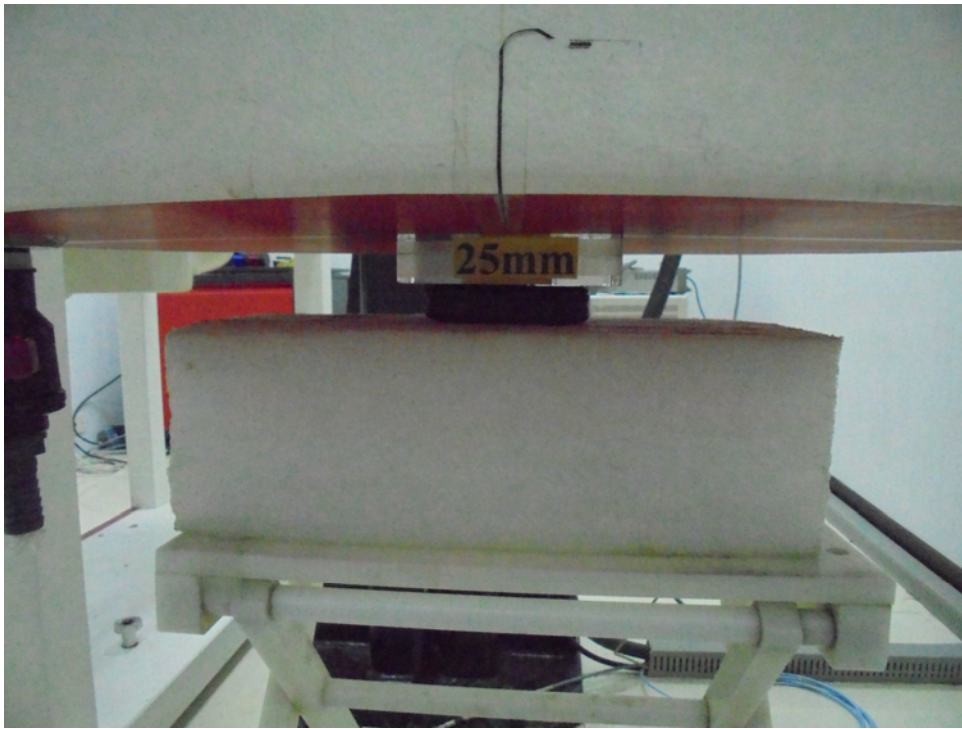

Phantom Position : Flat	EUT side : Side1
Spacing to phantom : 5 mm	Accessory : N/A

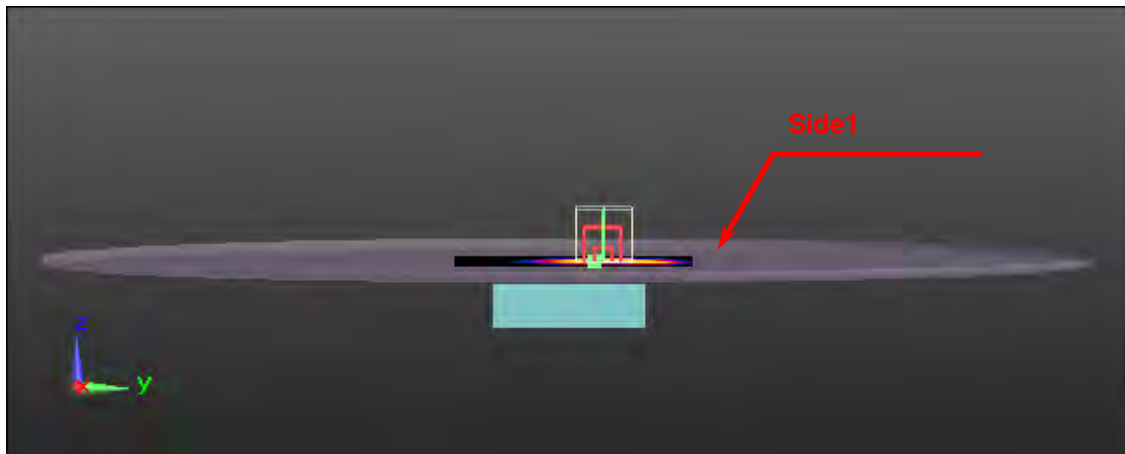
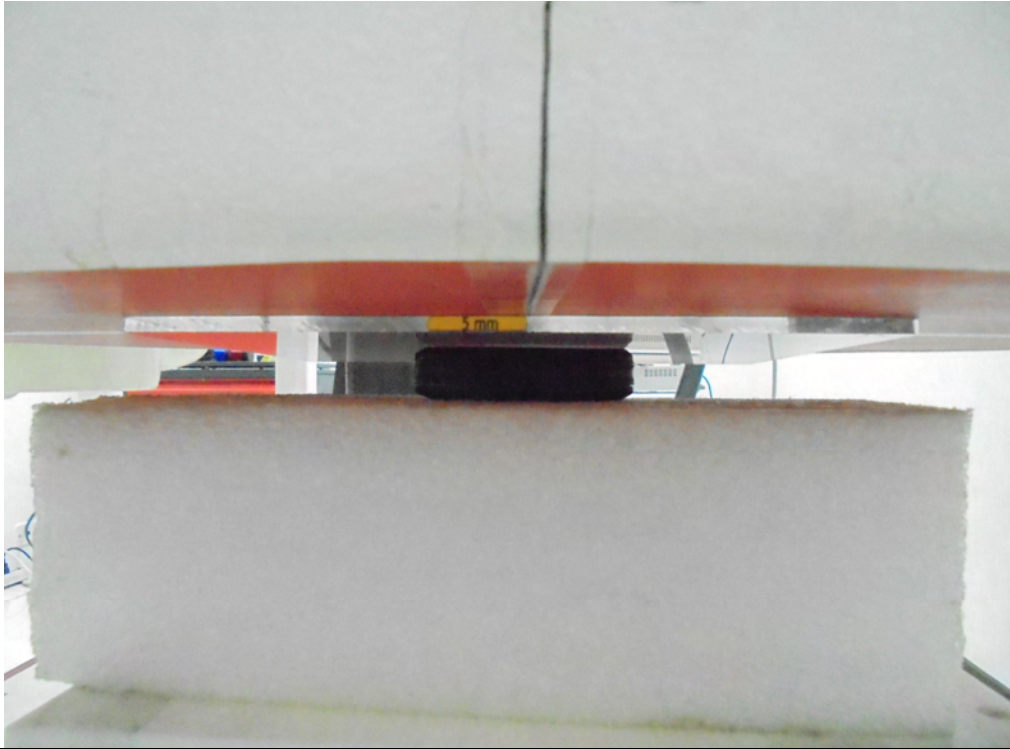

Phantom Position : Flat	EUT side : Side2
Spacing to phantom : 5 mm	Accessory : N/A

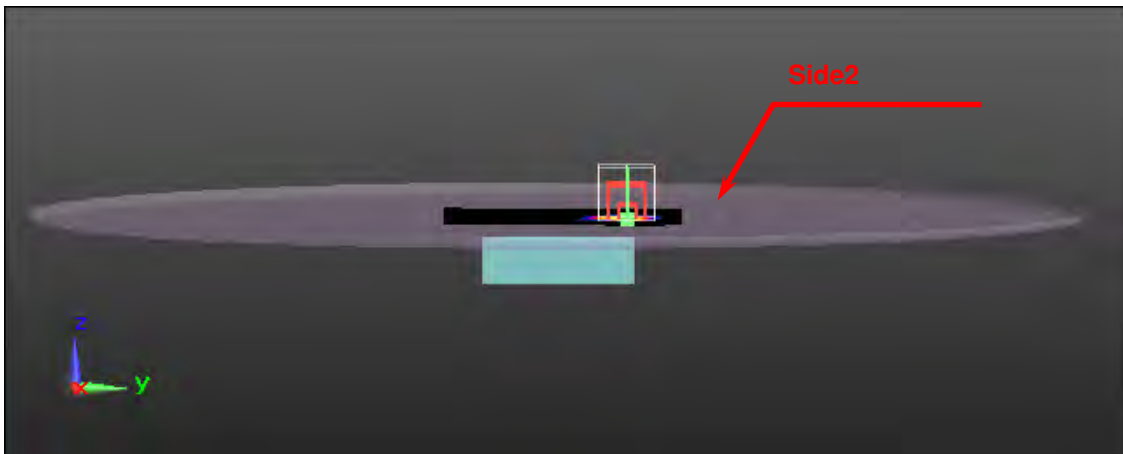
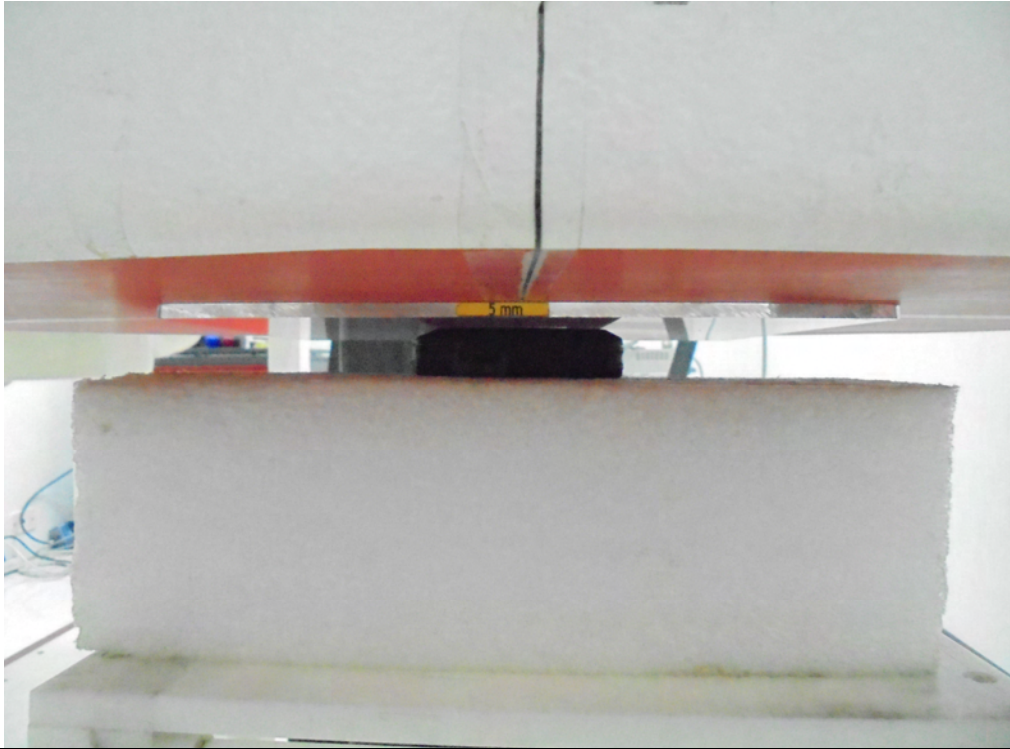

Phantom Position : Flat	EUT side : Side3
Spacing to phantom : 5 mm	Accessory : N/A

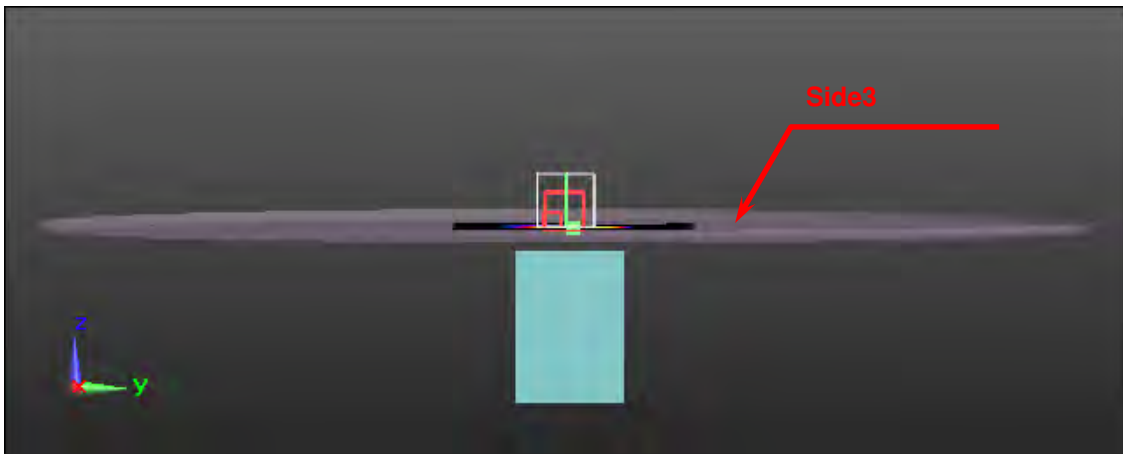
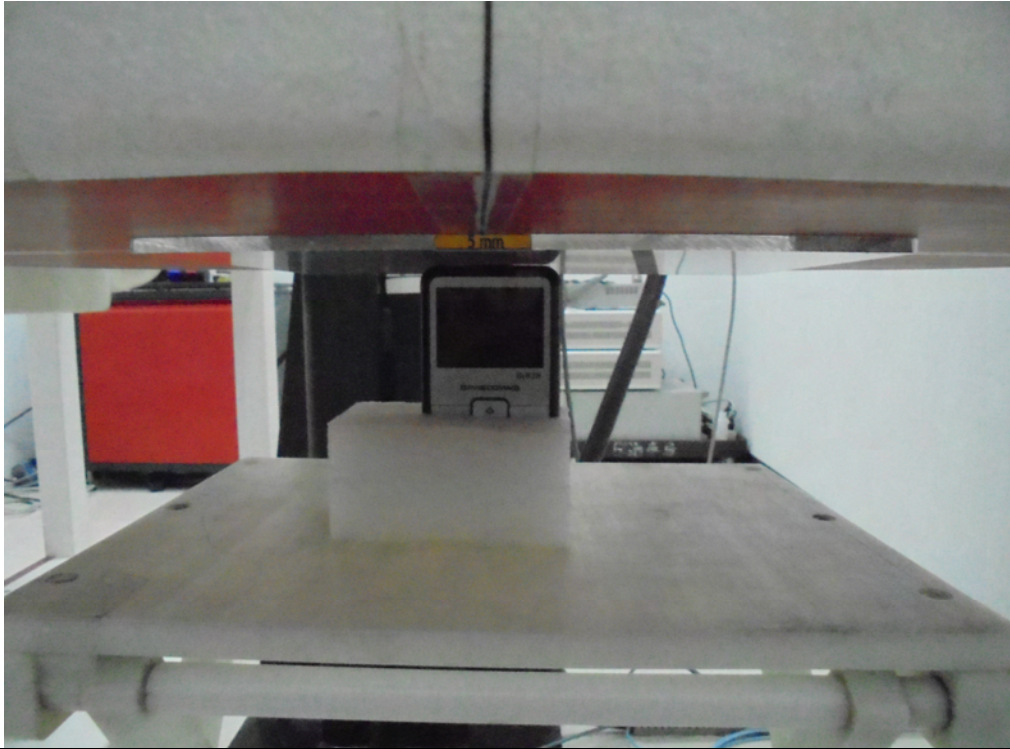

Phantom Position : Flat	EUT side : Side5
Spacing to phantom : 5 mm	Accessory : N/A

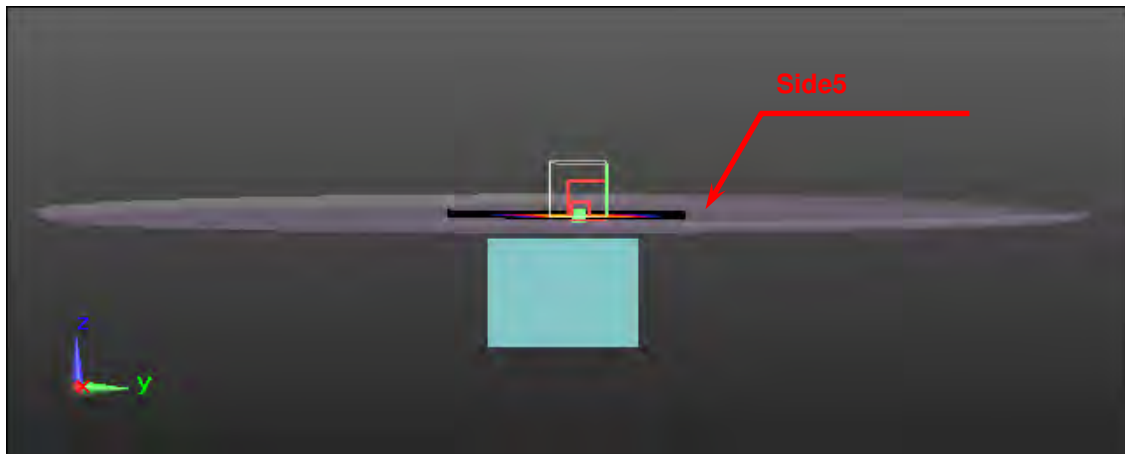
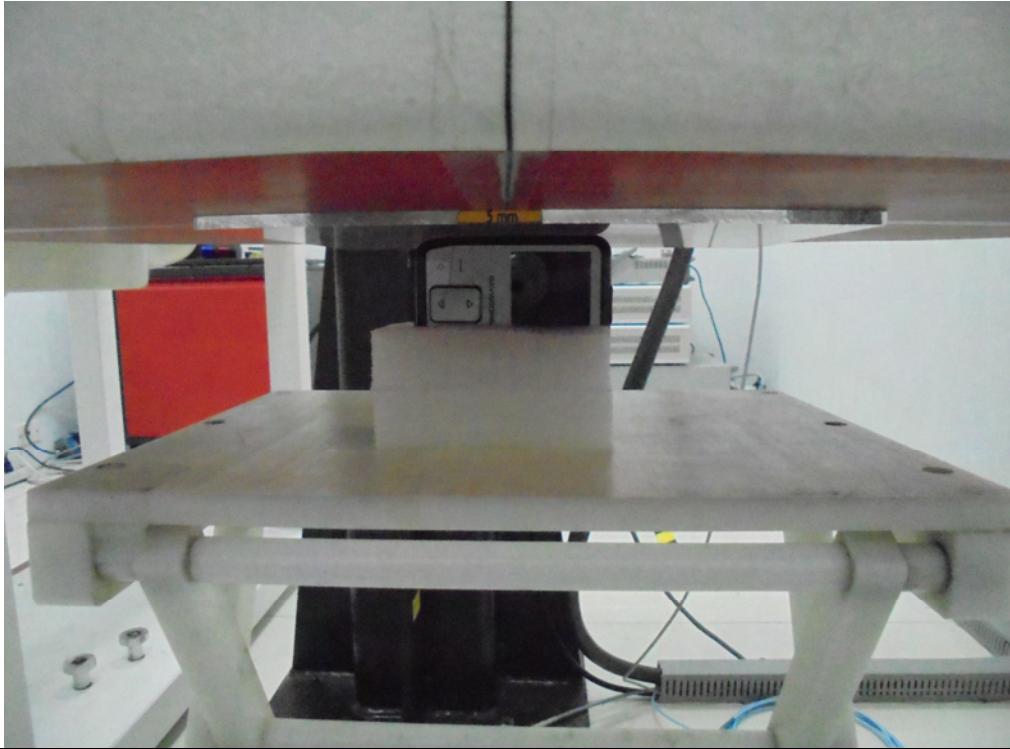

Phantom Position : Flat	EUT side : Side6
Spacing to phantom : 5 mm	Accessory : N/A

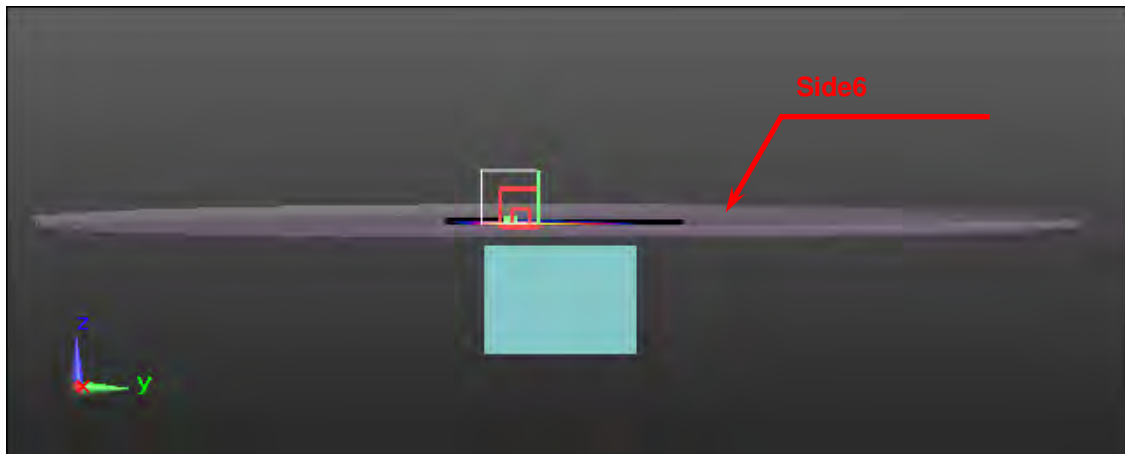
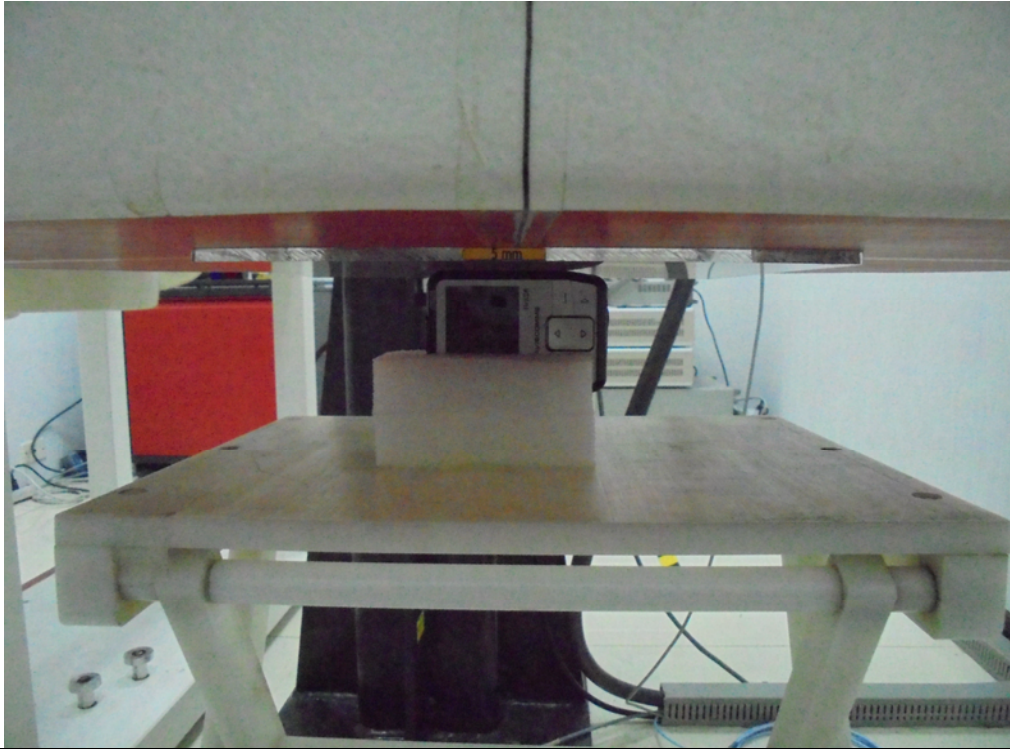

Phantom Position : Flat	EUT side : Side2
Spacing to phantom : 0 mm	Accessory : Holder

