

FCC Test Report

(PART 24)

Report No.: RF181126C15B-1

FCC ID: N7NHL78

Test Model: HL7800

Received Date: Jun. 01, 2020

Test Date: Jun. 01 ~ Jun. 12, 2020

Issued Date: Jul. 09, 2020

Applicant: Sierra Wireless Inc.

Address: 13811 Wireless Way, Richmond, BC, Canada V6V3A4

Issued By: Bureau Veritas Consumer Products Services (H.K.) Ltd., Taoyuan Branch
Lin Kou Laboratories

Lab Address: No. 47-2, 14th Ling, Chia Pau Vil., Lin Kou Dist., New Taipei City, Taiwan

Test Location: No.19, Hwa Ya 2nd Rd., Wen Hwa Vil., Kwei Shan Dist., Taoyuan City
33383, Taiwan

**FCC Registration /
Designation Number:** 788550 / TW0003



This report is for your exclusive use. Any copying or replication of this report to or for any other person or entity, or use of our name or trademark, is permitted only with our prior written permission. This report sets forth our findings solely with respect to the test samples identified herein. The results set forth in this report are not indicative or representative of the quality or characteristics of the lot from which a test sample was taken or any similar or identical product unless specifically and expressly noted. Our report includes all of the tests requested by you and the results thereof based upon the information that you provided to us. You have 60 days from date of issuance of this report to notify us of any material error or omission caused by our negligence, provided, however, that such notice shall be in writing and shall specifically address the issue you wish to raise. A failure to raise such issue within the prescribed time shall constitute your unqualified acceptance of the completeness of this report, the tests conducted and the correctness of the report contents. Unless specific mention, the uncertainty of measurement has been explicitly taken into account to declare the compliance or non-compliance to the specification. This report should not be used by the client to claim any endorsement by TAF.

Table of Contents

Release Control Record	4
1 Certificate of Conformity	5
2 Summary of Test Results	6
2.1 Measurement Uncertainty	6
2.2 Test Site and Instruments	7
3 General Information	8
3.1 General Description of EUT	8
3.2 Configuration of System under Test	10
3.2.1 Description of Support Units	10
3.3 Test Mode Applicability and Tested Channel Detail	11
3.4 EUT Operating Conditions	17
3.5 General Description of Applied Standards	17
4 Test Types and Results	18
4.1 Output Power Measurement	18
4.1.1 Limits of Output Power Measurement	18
4.1.2 Test Procedures	18
4.1.3 Test Setup	19
4.1.4 Test Results	20
4.2 Modulation Characteristics Measurement	45
4.2.1 Limits of Modulation Characteristics	45
4.2.2 Test Setup	45
4.2.3 Test Procedure	45
4.2.4 Test Results	46
4.3 Frequency Stability Measurement	48
4.3.1 Limits of Frequency Stability Measurement	48
4.3.2 Test Procedure	48
4.3.3 Test Setup	48
4.3.4 Test Results	49
4.4 Occupied Bandwidth Measurement	63
4.4.1 Test Procedure	63
4.4.2 Test Setup	63
4.4.3 Test Result	64
4.5 Band Edge Measurement	72
4.5.1 Limits of Band Edge Measurement	72
4.5.2 Test Setup	72
4.5.3 Test Procedures	72
4.5.4 Test Results	73
4.6 Peak to Average Ratio	89
4.6.1 Limits of Peak to Average Ratio Measurement	89
4.6.2 Test Setup	89
4.6.3 Test Procedures	89
4.6.4 Test Results	90
4.7 Conducted Spurious Emissions	98
4.7.1 Limits of Conducted Spurious Emissions Measurement	98
4.7.2 Test Setup	98
4.7.3 Test Procedure	98
4.7.4 Test Results	99
4.8 Radiated Emission Measurement	113
4.8.1 Limits of Radiated Emission Measurement	113
4.8.2 Test Procedure	113
4.8.3 Deviation from Test Standard	113
4.8.4 Test Setup	114
4.8.5 Test Results	115

5 Pictures of Test Arrangements.....	163
Appendix – Information of the Testing Laboratories	164

Release Control Record

Issue No.	Description	Date Issued
RF181126C15B-1	Original Release	Jul. 09, 2020

1 Certificate of Conformity

Product: Embedded Module

Brand: AirPrime

Test Model: HL7800

Sample Status: Engineering Sample

Applicant: Sierra Wireless Inc.

Test Date: Jun. 01 ~ Jun. 12, 2020

Standards: FCC Part 24, Subpart E

The above equipment has been tested by **Bureau Veritas Consumer Products Services (H.K.) Ltd., Taoyuan Branch**, and found compliance with the requirement of the above standards. The test record, data evaluation & Equipment Under Test (EUT) configurations represented herein are true and accurate accounts of the measurements of the sample's RF characteristics under the conditions specified in this report.

Prepared by : Gina Liu, **Date:** Jul. 09, 2020
Gina Liu / Specialist

Approved by : Dylan Chiou, **Date:** Jul. 09, 2020
Dylan Chiou / Senior Project Engineer

2 Summary of Test Results

Applied Standard: FCC Part 24 & Part 2			
FCC Clause	Test Item	Result	Remarks
2.1046 24.232	Effective Isotropic Radiated Power	Pass	Meet the requirement of limit.
2.1047	Modulation Characteristics	Pass	Meet the requirement.
24.232(d)	Peak to Average Ratio	Pass	Meet the requirement of limit.
2.1055 24.235	Frequency Stability	Pass	Meet the requirement of limit.
2.1049	Occupied Bandwidth	Pass	Meet the requirement of limit.
24.238	Band Edge Measurements	Pass	Meet the requirement of limit.
2.1051 24.238	Conducted Spurious Emissions	Pass	Meet the requirement of limit.
2.1053 24.238	Radiated Spurious Emissions	Pass	Meet the requirement of limit. Minimum passing margin is -10.62 dB at 7440.00 MHz.

Note: Determining compliance based on the results of the compliance measurement, not taking into account measurement instrumentation uncertainty.

2.1 Measurement Uncertainty

Where relevant, the following measurement uncertainty levels have been estimated for tests performed on the EUT as specified in CISPR 16-4-2:

Measurement	Frequency	Expanded Uncertainty (k=2) (±)
Radiated Emissions up to 1 GHz	9 kHz ~ 30 MHz	3.04 dB
	30 MHz ~ 200 MHz	2.93 dB
	200 MHz ~ 1000 MHz	2.95 dB
Radiated Emissions above 1 GHz	1 GHz ~ 18 GHz	2.26 dB
	18 GHz ~ 40 GHz	1.94 dB

2.2 Test Site and Instruments

Description & Manufacturer	Model No.	Serial No.	Date of Calibration	Due Date of Calibration
Test Receiver Agilent	N9038A	MY51210203	Mar. 18, 2020	Mar. 17, 2021
Spectrum Analyzer Agilent	N9010A	MY52220314	Dec. 12, 2019	Dec. 11, 2020
Spectrum Analyzer ROHDE & SCHWARZ	FSU43	101261	Apr. 16, 2020	Apr. 15, 2021
HORN Antenna SCHWARZBECK	BBHA 9170	9170-480	Nov. 24, 2019	Nov. 23, 2020
HORN Antenna SCHWARZBECK	BBHA 9120D	9120D-969	Nov. 24, 2019	Nov. 23, 2020
HORN Antenna EMCO	3115	5619	Nov. 24, 2019	Nov. 23, 2020
BILOG Antenna SCHWARZBECK	VULB 9168	9168-472	Nov. 08, 2019	Nov. 07, 2020
Fixed Attenuator Mini-Circuits	MDCS18N-10	MDCS18N-10-01	Apr. 14, 2020	Apr. 13, 2021
MXG Vector signal generator Agilent	N5182B	MY53050430	Oct. 25, 2019	Oct. 24, 2020
Preamplifier EMCI	EMC 184045	980116	Oct. 08, 2019	Oct. 07, 2020
Preamplifier EMCI	EMC 012645	980115	Oct. 08, 2019	Oct. 07, 2020
Preamplifier EMCI	EMC 330H	980112	Oct. 08, 2019	Oct. 07, 2020
RF Coaxial Cable HUBER+SUHNNER	EMC104-SM-SM-8000&3 000	140811+170717	Oct. 08, 2019	Oct. 07, 2020
RF Coaxial Cable HUBER+SUHNNER	SUCOFLEX 104	EMC104-SM-SM-1000(140807)	Oct. 08, 2019	Oct. 07, 2020
RF Coaxial Cable WOKEN	8D-FB	Cable-Ch10-01	Oct. 08, 2019	Oct. 07, 2020
Boresight Antenna Fixture	FBA-01	FBA-SIP01	NA	NA
Software BV ADT	E3 6.120103	NA	NA	NA
Antenna Tower MF	MFA-440H	NA	NA	NA
Turn Table MF	MFT-201SS	NA	NA	NA
Antenna Tower & Turn Table Controller MF	MF-7802	NA	NA	NA
Radio Communication Analyzer Anritsu	MT8821C	6261806803	Jan. 18, 2020	Jan. 17, 2021
Spectrum Analyzer R&S	FSW43	101582	Mar. 31, 2020	Mar. 30 2021
Temperature & Humidity Chamber	GTH-120-40-CP-AR	MAA1306-019	Sep. 10, 2019	Sep. 09, 2020
DC Power Supply Topward	33010D	807748	NA	NA
Digital Multimeter Fluke	87-III	70360742	Jun. 27, 2019 Jun. 23, 2020	Jun. 26, 2020 Jun. 22, 2021

- Note: 1. The calibration interval of the above test instruments is 12 months and the calibrations are traceable to NML/ROC and NIST/USA.
2. The test was performed in HwaYa Chamber 10.

3 General Information

3.1 General Description of EUT

Product	Embedded Module			
Brand	AirPrime			
Test Model	HL7800			
Status of EUT	Engineering Sample			
Power Supply Rating	5.0 Vdc (host equipment) 12.0 Vdc (adapter)			
Modulation Type	Cat-M1	QPSK, 16QAM		
	NB-IoT	BPSK, QPSK		
Frequency Range	Cat-M1	LTE Band 2 (Channel Bandwidth: 1.4 MHz)	1850.7 ~ 1909.3 MHz	
		LTE Band 2 (Channel Bandwidth: 3 MHz)	1851.5 ~ 1908.5 MHz	
		LTE Band 2 (Channel Bandwidth: 5 MHz)	1852.5 ~ 1907.5 MHz	
		LTE Band 2 (Channel Bandwidth: 10 MHz)	1855.0 ~ 1905.0 MHz	
		LTE Band 2 (Channel Bandwidth: 15 MHz)	1857.5 ~ 1902.5 MHz	
		LTE Band 2 (Channel Bandwidth: 20 MHz)	1860.0 ~ 1900.0 MHz	
		LTE Band 25 (Channel Bandwidth: 1.4 MHz)	1850.7 ~ 1914.3 MHz	
		LTE Band 25 (Channel Bandwidth: 3 MHz)	1851.5 ~ 1913.5 MHz	
		LTE Band 25 (Channel Bandwidth: 5 MHz)	1852.5 ~ 1912.5 MHz	
		LTE Band 25 (Channel Bandwidth: 10 MHz)	1855.0 ~ 1910.0 MHz	
		LTE Band 25 (Channel Bandwidth: 15 MHz)	1857.5 ~ 1907.5 MHz	
		LTE Band 25 (Channel Bandwidth: 20 MHz)	1860.0 ~ 1905.0 MHz	
	NB-IoT	LTE 2	1850.2 ~ 1909.8 MHz	
		LTE 25	1850.2 ~ 1914.8 MHz	
Max. EIRP Power	Cat-M1	LTE Band 2 (Channel Bandwidth: 1.4 MHz)	300.61 mW	
		LTE Band 2 (Channel Bandwidth: 3 MHz)	317.69 mW	
		LTE Band 2 (Channel Bandwidth: 5 MHz)	337.29 mW	
		LTE Band 2 (Channel Bandwidth: 10 MHz)	356.45 mW	
		LTE Band 2 (Channel Bandwidth: 15 MHz)	378.44 mW	
		LTE Band 2 (Channel Bandwidth: 20 MHz)	400.87 mW	
		LTE Band 25 (Channel Bandwidth: 1.4 MHz)	306.90 mW	
		LTE Band 25 (Channel Bandwidth: 3 MHz)	323.59 mW	
		LTE Band 25 (Channel Bandwidth: 5 MHz)	341.98 mW	
		LTE Band 25 (Channel Bandwidth: 10 MHz)	362.24 mW	
		LTE Band 25 (Channel Bandwidth: 15 MHz)	384.59 mW	
		LTE Band 25 (Channel Bandwidth: 20 MHz)	405.51 mW	
	NB-IoT	LTE 2	251.19 mW (BPSK) 315.50 mW (QPSK)	
		LTE 25	267.92 mW (BPSK) 303.39 mW (QPSK)	

Emission Designator	Cat-M1	LTE Band 2 (Channel Bandwidth: 1.4 MHz)	1M09G7D
		LTE Band 2 (Channel Bandwidth: 3 MHz)	1M09G7D
		LTE Band 2 (Channel Bandwidth: 5 MHz)	1M09D7W
		LTE Band 2 (Channel Bandwidth: 10 MHz)	1M09G7D
		LTE Band 2 (Channel Bandwidth: 15 MHz)	1M10G7D
		LTE Band 2 (Channel Bandwidth: 20 MHz)	1M09G7D
		LTE Band 25 (Channel Bandwidth: 1.4 MHz)	1M09G7D
		LTE Band 25 (Channel Bandwidth: 3 MHz)	1M10G7D
		LTE Band 25 (Channel Bandwidth: 5 MHz)	1M09G7D
		LTE Band 25 (Channel Bandwidth: 10 MHz)	1M09G7D
		LTE Band 25 (Channel Bandwidth: 15 MHz)	1M09G7D
		LTE Band 25 (Channel Bandwidth: 20 MHz)	1M09G7D
	NB-IoT	LTE 2	192KG7D
		LTE 25	194KG7D
Antenna Type	Dipole Antenna with 2 dBi gain		
Accessory Device	Refer to Note as below		
Data Cable Supplied	Refer to Note as below		

Note:

1. The above Antenna information is declared by manufacturer and for more detailed features description, please refer to the manufacturer's specifications, the laboratory shall not be held responsible.
2. The above EUT information is declared by manufacturer and for more detailed features description, please refers to the manufacturer's specifications or user's manual.

3.2 Configuration of System under Test

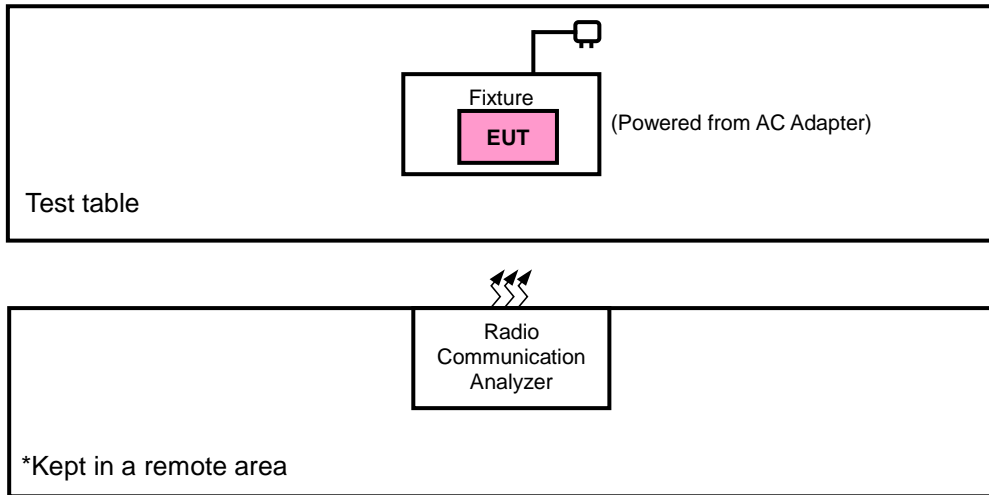

3.2.1 Description of Support Units

The EUT has been tested as an independent unit together with other necessary accessories or support units. The following support units or accessories were used to form a representative test configuration during the tests.

No.	Product	Brand	Model No.	Serial No.	FCC ID
1.	Adapter	N/A	N/A	N/A	N/A
2.	Radio Communication Analyzer	Anritsu	MT8821C	6201462755	N/A

No.	Signal Cable Description Of The Above Support Units
1.	N/A
2.	N/A

Note:

1. All power cords of the above support units are non-shielded (1.8m).
2. Item 1 was provided by client.

3.3 Test Mode Applicability and Tested Channel Detail

Pre-Scan has been conducted to determine the worst-case mode from all possible combinations between available modulations, data rates, XYZ axis, and antenna ports.

The worst case was found when positioned as the table below. Following channel(s) was (were) selected for the final test as listed below:

Band	EIRP	Radiated Emission
LTE Band 2	Z-plane (Cat-M1) X-plane (NB-IoT)	Z-axis (Cat-M1) X-axis (NB-IoT)
LTE Band 25	Z-plane (Cat-M1) X-plane (NB-IoT)	Z-axis (Cat-M1) X-axis (NB-IoT)

Cat-M1

LTE Band 2

EUT Configure Mode	Test Item	Available Channel	Tested Channel	Channel Bandwidth	Modulation	Mode
-	EIRP	18607 to 19193	18607, 18900, 19193	1.4 MHz	QPSK, 16QAM	1 RB / 0 RB Offset
		18615 to 19185	18615, 18900, 19185	3 MHz	QPSK, 16QAM	1 RB / 0 RB Offset
		18625 to 19175	18625, 18900, 19175	5 MHz	QPSK, 16QAM	1 RB / 5 RB Offset
		18650 to 19150	18650, 18900, 19150	10 MHz	QPSK, 16QAM	1 RB / 0 RB Offset
		18675 to 19125	18675, 18900, 19125	15 MHz	QPSK, 16QAM	1 RB / 0 RB Offset
		18700 to 19100	18700, 18900, 19100	20 MHz	QPSK, 16QAM	1 RB / 0 RB Offset
-	Modulation characteristics	18625 to 19175	18900	5 MHz	QPSK, 16QAM	6 RB / 0 RB Offset
-	Frequency Stability	18607 to 19193	18607, 19193	1.4 MHz	QPSK	6 RB / 0 RB Offset
		18615 to 19185	18615, 19185	3 MHz	QPSK	6 RB / 0 RB Offset
		18625 to 19175	18625, 19175	5 MHz	QPSK	6 RB / 0 RB Offset
		18650 to 19150	18650, 19150	10 MHz	QPSK	6 RB / 0 RB Offset
		18675 to 19125	18675, 19125	15 MHz	QPSK	6 RB / 0 RB Offset
		18700 to 19100	18700, 19100	20 MHz	QPSK	6 RB / 0 RB Offset
-	Occupied Bandwidth	18607 to 19193	18607, 18900, 19193	1.4 MHz	QPSK, 16QAM	6 RB / 0 RB Offset
		18615 to 19185	18615, 18900, 19185	3 MHz	QPSK, 16QAM	6 RB / 0 RB Offset
		18625 to 19175	18625, 18900, 19175	5 MHz	QPSK, 16QAM	6 RB / 0 RB Offset
		18650 to 19150	18650, 18900, 19150	10 MHz	QPSK, 16QAM	6 RB / 0 RB Offset
		18675 to 19125	18675, 18900, 19125	15 MHz	QPSK, 16QAM	6 RB / 0 RB Offset
		18700 to 19100	18700, 18900, 19100	20 MHz	QPSK, 16QAM	6 RB / 0 RB Offset
-	Peak to Average Ratio	18607 to 19193	18607, 18900, 19193	1.4 MHz	QPSK, 16QAM	1 RB / 0 RB Offset
		18615 to 19185	18615, 18900, 19185	3 MHz	QPSK, 16QAM	1 RB / 0 RB Offset
		18625 to 19175	18625, 18900, 19175	5 MHz	QPSK, 16QAM	1 RB / 5 RB Offset
		18650 to 19150	18650, 18900, 19150	10 MHz	QPSK, 16QAM	1 RB / 0 RB Offset
		18675 to 19125	18675, 18900, 19125	15 MHz	QPSK, 16QAM	1 RB / 0 RB Offset
		18700 to 19100	18700, 18900, 19100	20 MHz	QPSK, 16QAM	1 RB / 0 RB Offset

EUT Configure Mode	Test Item	Available Channel	Tested Channel	Channel Bandwidth	Modulation	Mode		
-	Band Edge	18607 to 19193	18607	1.4 MHz	QPSK	1 RB / 0 RB Offset 6 RB / 0 RB Offset		
			19193	1.4 MHz	QPSK	1 RB / 5 RB Offset 6 RB / 0 RB Offset		
		18615 to 19185	18615	3 MHz	QPSK	1 RB / 0 RB Offset 6 RB / 0 RB Offset		
			19185	3 MHz	QPSK	1 RB / 5 RB Offset 6 RB / 0 RB Offset		
		18625 to 19175	18625	5 MHz	QPSK	1 RB / 0 RB Offset 6 RB / 0 RB Offset		
			19175	5 MHz	QPSK	1 RB / 5 RB Offset 6 RB / 0 RB Offset		
		18650 to 19150	18650	10 MHz	QPSK	1 RB / 0 RB Offset 6 RB / 0 RB Offset		
			19150	10 MHz	QPSK	1 RB / 5 RB Offset 6 RB / 0 RB Offset		
		18675 to 19125	18675	15 MHz	QPSK	1 RB / 0 RB Offset 6 RB / 0 RB Offset		
			19125	15 MHz	QPSK	1 RB / 5 RB Offset 6 RB / 0 RB Offset		
		18700 to 19100	18700	20 MHz	QPSK	1 RB / 0 RB Offset 6 RB / 0 RB Offset		
			19100	20 MHz	QPSK	1 RB / 5 RB Offset 6 RB / 0 RB Offset		
		-	Conducted Emission	18607 to 19193	18607, 18900, 19193	1.4 MHz	QPSK	1 RB / 0 RB Offset
				18615 to 19185	18615, 18900, 19185	3 MHz	QPSK	1 RB / 0 RB Offset
				18625 to 19175	18625, 18900, 19175	5 MHz	QPSK	1 RB / 5 RB Offset
				18650 to 19150	18650, 18900, 19150	10 MHz	QPSK	1 RB / 0 RB Offset
18675 to 19125	18675, 18900, 19125			15 MHz	QPSK	1 RB / 0 RB Offset		
18700 to 19100	18700, 18900, 19100			20 MHz	QPSK	1 RB / 0 RB Offset		
-	Radiated Emission	18607 to 19193	18607, 18900, 19193	1.4 MHz	QPSK	1 RB / 0 RB Offset		
		18625 to 19175	18625, 18900, 19175	5 MHz	QPSK	1 RB / 5 RB Offset		
		18700 to 19100	18700, 18900, 19100	20 MHz	QPSK	1 RB / 0 RB Offset		

Note:

1. This device was tested under all bandwidths, RB configurations and modulations. The worst case was found in QPSK modulation. Therefore, only EIRP, modulation characteristics, occupied bandwidth and peak to average ratio items had been tested under QPSK, 16QAM mode, the other items were performed under QPSK mode only.
2. For radiated emission above 1 GHz, according to 3GPP 36.521 Section 6.6.3.1.4, choose the lowest, 5 MHz & highest channel bandwidth for final test.
3. For radiated emissions below 1 GHz, select the worst radiated emission channel for final testing.

LTE Band 25

EUT Configure Mode	Test Item	Available Channel	Tested Channel	Channel Bandwidth	Modulation	Mode
-	EIRP	26047 to 26683	26047, 26365, 26683	1.4 MHz	QPSK, 16QAM	1 RB / 0 RB Offset
		26055 to 26675	26055, 26365, 26675	3 MHz	QPSK, 16QAM	1 RB / 0 RB Offset
		26065 to 26665	26065, 26365, 26665	5 MHz	QPSK, 16QAM	1 RB / 0 RB Offset
		26090 to 26640	26090, 26365, 26640	10 MHz	QPSK, 16QAM	4 RB / 2 RB Offset
		26115 to 26615	26115, 26365, 26615	15 MHz	QPSK, 16QAM	1 RB / 0 RB Offset
		26140 to 26590	26140, 26365, 26590	20 MHz	QPSK, 16QAM	1 RB / 0 RB Offset
-	Modulation characteristics	26065 to 26665	26365	5 MHz	QPSK, 16QAM	6 RB / 0 RB Offset
-	Frequency Stability	26047 to 26683	26047, 26683	1.4 MHz	QPSK	6 RB / 0 RB Offset
		26055 to 26675	26055, 26675	3 MHz	QPSK	6 RB / 0 RB Offset
		26065 to 26665	26065, 26665	5 MHz	QPSK	6 RB / 0 RB Offset
		26090 to 26640	26090, 26640	10 MHz	QPSK	6 RB / 0 RB Offset
		26115 to 26615	26115, 26615	15 MHz	QPSK	6 RB / 0 RB Offset
		26140 to 26590	26140, 26590	20 MHz	QPSK	6 RB / 0 RB Offset
-	Occupied Bandwidth	26047 to 26683	26047, 26365, 26683	1.4 MHz	QPSK, 16QAM	6 RB / 0 RB Offset
		26055 to 26675	26055, 26365, 26675	3 MHz	QPSK, 16QAM	6 RB / 0 RB Offset
		26065 to 26665	26065, 26365, 26665	5 MHz	QPSK, 16QAM	6 RB / 0 RB Offset
		26090 to 26640	26090, 26365, 26640	10 MHz	QPSK, 16QAM	6 RB / 0 RB Offset
		26115 to 26615	26115, 26365, 26615	15 MHz	QPSK, 16QAM	6 RB / 0 RB Offset
		26140 to 26590	26140, 26365, 26590	20 MHz	QPSK, 16QAM	6 RB / 0 RB Offset
-	Peak to Average Ratio	26047 to 26683	26047, 26365, 26683	1.4 MHz	QPSK, 16QAM	1 RB / 0 RB Offset
		26055 to 26675	26055, 26365, 26675	3 MHz	QPSK, 16QAM	1 RB / 0 RB Offset
		26065 to 26665	26065, 26365, 26665	5 MHz	QPSK, 16QAM	1 RB / 0 RB Offset
		26090 to 26640	26090, 26365, 26640	10 MHz	QPSK, 16QAM	4 RB / 2 RB Offset
		26115 to 26615	26115, 26365, 26615	15 MHz	QPSK, 16QAM	6 RB / 0 RB Offset
		26140 to 26590	26140, 26365, 26590	20 MHz	QPSK, 16QAM	6 RB / 0 RB Offset
-	Band Edge	26047 to 26683	26047	1.4 MHz	QPSK	1 RB / 0 RB Offset
			26683	1.4 MHz	QPSK	6 RB / 0 RB Offset
		26055 to 26675	26055	3 MHz	QPSK	1 RB / 5 RB Offset
			26675	3 MHz	QPSK	6 RB / 0 RB Offset
		26065 to 26665	26065	5 MHz	QPSK	1 RB / 0 RB Offset
			26665	5 MHz	QPSK	6 RB / 0 RB Offset
		26090 to 26640	26090	10 MHz	QPSK	1 RB / 5 RB Offset
			26640	10 MHz	QPSK	6 RB / 0 RB Offset
		26115 to 26615	26115	15 MHz	QPSK	1 RB / 0 RB Offset
			26615	15 MHz	QPSK	6 RB / 0 RB Offset
		26140 to 26590	26140	20 MHz	QPSK	1 RB / 5 RB Offset
			26590	20 MHz	QPSK	6 RB / 0 RB Offset

EUT Configure Mode	Test Item	Available Channel	Tested Channel	Channel Bandwidth	Modulation	Mode
-	Conducted Emission	26047 to 26683	26047, 26365, 26683	1.4 MHz	QPSK	1 RB / 0 RB Offset
		26055 to 26675	26055, 26365, 26675	3 MHz	QPSK	1 RB / 0 RB Offset
		26065 to 26665	26065, 26365, 26665	5 MHz	QPSK	1 RB / 0 RB Offset
		26090 to 26640	26090, 26365, 26640	10 MHz	QPSK	4 RB / 2 RB Offset
		26115 to 26615	26115, 26365, 26615	15 MHz	QPSK	1 RB / 0 RB Offset
		26140 to 26590	26140, 26365, 26590	20 MHz	QPSK	1 RB / 0 RB Offset
-	Radiated Emission	18607 to 19193	18607, 18900, 19193	1.4 MHz	QPSK	1 RB / 0 RB Offset
		18625 to 19175	18625, 18900, 19175	5 MHz	QPSK	1 RB / 0 RB Offset
		18700 to 19100	18700, 18900, 19100	20 MHz	QPSK	1 RB / 0 RB Offset

Note:

1. This device was tested under all bandwidths, RB configurations and modulations. The worst case was found in QPSK modulation. Therefore, only EIRP, modulation characteristics, occupied bandwidth and peak to average ratio items had been tested under QPSK, 16QAM mode, the other items were performed under QPSK mode only.
2. For radiated emission above 1 GHz, according to 3GPP 36.521 Section 6.6.3.1.4, choose the lowest, 5 MHz & highest channel bandwidth for final test.
3. For radiated emissions below 1 GHz, select the worst radiated emission channel for final testing.

NB-IoT
LTE Band 2

EUT Configure Mode	Test Item	Available Channel	Tested Channel	Sub-carrier Bandwidth	Modulation	N _{tones}
-	EIRP	18602 to 19198	18602, 18900, 19198	3.75 kHz	BPSK	1@47
				15 kHz	QPSK	3@3
-	Modulation Characteristics	18602 to 19198	18900	3.75 kHz	BPSK	1@0
				15 kHz	QPSK	12@0
-	Frequency Stability	18602 to 19198	18602, 19198	15 kHz	QPSK	3@3
-	Occupied Bandwidth	18602 to 19198	18602	3.75 kHz	BPSK	1@0
				15 kHz	QPSK	1@0
				3@3		
				12@0		
			18900	3.75 kHz	BPSK	1@0
				15 kHz	QPSK	1@0
				3@3		
				12@0		
			19198	3.75 kHz	BPSK	1@47
				15 kHz	QPSK	1@11
				3@3		
				12@0		
-	Peak to Average Ratio	18602 to 19198	18900	3.75 kHz	BPSK	1@0
				15 kHz	QPSK	1@0
				3@3		
-	Band Edge	18602 to 19198	18602	3.75 kHz	BPSK	1@0
				15 kHz	QPSK	1@0
				3@3		
				12@0		
			19198	3.75 kHz	BPSK	1@47
				15 kHz	QPSK	1@11
				3@3		
				12@0		
-	Conducted Emission	18602 to 19198	18602, 18900, 19198	15 kHz	QPSK	3@3
-	Radiated Emission	18602 to 19198	18602, 18900, 19198	15 kHz	QPSK	3@3

Note:

1. Selection is tested with Stand-alone, In-band and Guard-band, the worst case was found in Stand-alone.
2. For radiated emission and conducted emission test, pre-tested BPSK, QPSK modulation type and found QPSK was the worst, therefore chosen for the final test.
3. The emission measurement was based on the worst maximum conducted power.

LTE Band 25

EUT Configure Mode	Test Item	Available Channel	Tested Channel	Sub-carrier Bandwidth	Modulation	N _{tones}
-	EIRP	26042 to 26688	26042, 26365, 26688	3.75 kHz	BPSK	1@47
				15 kHz	QPSK	3@3
-	Modulation Characteristics	26042 to 26688	26365	3.75 kHz	BPSK	1@0
				15 kHz	QPSK	12@0
-	Frequency Stability	26042 to 26688	26042, 26688	15 kHz	QPSK	3@3
-	Occupied Bandwidth	26042 to 26688	26042	3.75 kHz	BPSK	1@0
				15 kHz	QPSK	1@0
						3@3
						12@0
			26365	3.75 kHz	BPSK	1@0
				15 kHz	QPSK	1@0
						3@3
						12@0
			26688	3.75 kHz	BPSK	1@47
				15 kHz	QPSK	1@11
						3@3
						12@0
-	Peak to Average Ratio	26042 to 26688	26365	3.75 kHz	BPSK	1@0
				15 kHz	QPSK	1@0
						3@3
-	Band Edge	26042 to 26688	26042	3.75 kHz	BPSK	1@0
				15 kHz	QPSK	1@0
						3@3
						12@0
			26688	3.75 kHz	BPSK	1@47
				15 kHz	QPSK	1@11
						3@3
						12@0
-	Conducted Emission	26042 to 26688	26042, 26365, 26688	15 kHz	QPSK	1@0
-	Radiated Emission	26042 to 26688	26042, 26365, 26688	15 kHz	QPSK	1@0

Note:

1. Selection is tested with Stand-alone, In-band and Guard-band, the worst case was found in Stand-alone.
2. For radiated emission and conducted emission test, pre-tested BPSK, QPSK modulation type and found QPSK was the worst, therefore chosen for the final test.
3. The emission measurement was based on the worst maximum conducted power.

Test Condition:

Test Item	Environmental Conditions	Input Power	Tested By
EIRP	26 deg. C, 58 % RH	12 Vdc	Jisyong Wang
Modulation Characteristics	26 deg. C, 58 % RH	12 Vdc	Getaz Yang
Frequency Stability	26 deg. C, 58 % RH	12 Vdc	Getaz Yang
Occupied Bandwidth	26 deg. C, 58 % RH	12 Vdc	Getaz Yang
Band Edge	26 deg. C, 58 % RH	12 Vdc	Getaz Yang
Peak to Average Ratio	26 deg. C, 58 % RH	12 Vdc	Getaz Yang
Conducted Emission	26 deg. C, 58 % RH	12 Vdc	Getaz Yang
Radiated Emission	25 deg. C, 65 % RH	12 Vdc	Jisyong Wang

3.4 EUT Operating Conditions

The EUT makes a call to the communication simulator. The communication simulator station system controlled a EUT to export maximum output power under transmission mode and specific channel frequency

3.5 General Description of Applied Standards

The EUT is a RF Product. According to the specifications of the manufacturer, it must comply with the requirements of the following standards and references:

Test Standard:

FCC 47 CFR Part 2

FCC 47 CFR Part 24

ANSI 63.26-2015

NOTE: All test items have been performed and recorded as per the above standards.

References Test Guidance:

KDB 971168 D01 Power Meas License Digital Systems v03r01

ANSI/TIA/EIA-603-E 2016

NOTE: All test items have been performed as a reference to the above KDB test guidance.

4 Test Types and Results

4.1 Output Power Measurement

4.1.1 Limits of Output Power Measurement

Mobile / Portable station are limited to 2 watts e.i.r.p.

4.1.2 Test Procedures

EIRP / ERP Measurement:

- a. All measurements were done at low, middle and high operational frequency range. RBW is 10 MHz \cdot 20 MHz for LTE mode, and VBW \geq 3 x RBW.
- b. Substitution method is used for E.I.R.P measurement. In the semi-anechoic chamber, EUT placed on the 0.8 m (below or equal 1 GHz) and/or 1.5 m (above 1 GHz) height of Turn Table, rotated the table around 360 degrees to search the maximum radiation power and receiver antenna shall be rotated vertical and horizontal polarization and moved height from 1 m to 4 m to find the maximum polar radiated power. The "Read Value" is the spectrum reading the maximum power value.
- c. The substitution horn antenna is substituted for EUT at the same position and signals generator export the CW signal to the substitution antenna via a tx cable. Rotated the Turn Table and moved receiving antenna to find the maximum radiation power. Adjust output power level of S.G to get a Value of spectrum reading equal to "Read Value" of step b. Record the power level of S.G.
- d. $EIRP = \text{Output power level of S.G} - \text{TX cable loss} + \text{Antenna gain of substitution horn}$. E.R.P power can be calculated form E.I.R.P power by subtracting the gain of dipole, $E.R.P \text{ power} = E.I.R.P \text{ power} - 2.15 \text{ dB}$.

Conducted Power Measurement:

The EUT was set up for the maximum power with LTE link data modulation and link up with simulator. Set the EUT to transmit under low, middle and high channel and record the power level shown on simulator.

4.1.3 Test Setup

EIRP / ERP Measurement:

<Radiated Emission below or equal 1 GHz>

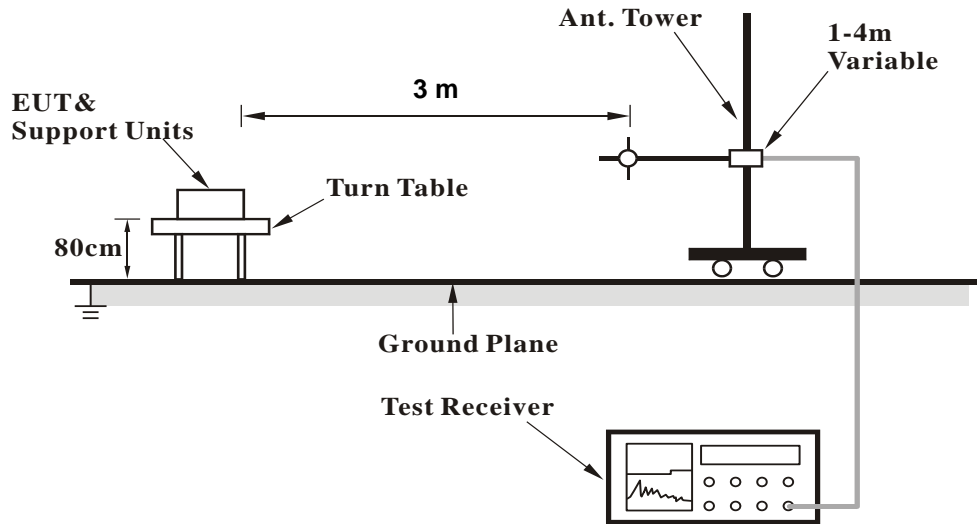

<Radiated Emission above 1 GHz>

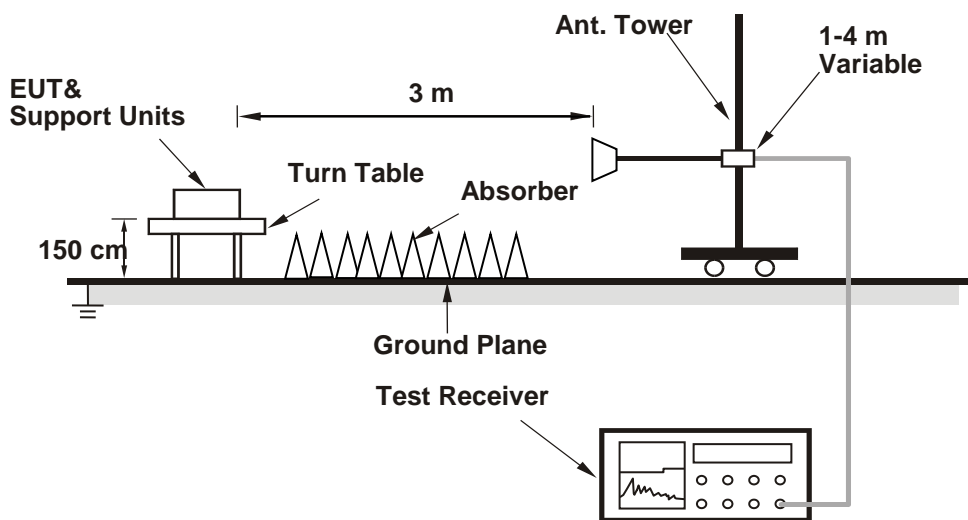

For the actual test configuration, please refer to the attached file (Test Setup Photo).

Conducted Power Measurement:



4.1.4 Test Results

Conducted Output Power (dBm)

Cat-M1

LTE Band 2								
BW (MHz): 1.4								
Test Frequency ID	N _{UL}	Frequency of Uplink (MHz)	Test Configuration Initial of Power				EUT	
			Modulation	RB Size	RB Offset	Narrowband Index	Cell Power (dBm/15 kHz)	Power (dBm)
Low Range	18607	1850.7	QPSK	1	0	0	-85	23.79
			QPSK	1	5	0	-85	23.39
			QPSK	3	3	0	-85	21.93
			QPSK	6	0	0	-85	20.97
			16QAM	1	0	0	-85	21.45
			16QAM	1	5	0	-85	21.51
			16QAM	3	0	0	-85	20.65
Mid. Range	18900	1880	16QAM	5	0	0	-85	20.40
			QPSK	1	0	0	-85	23.89
			QPSK	1	5	0	-85	23.80
			QPSK	3	3	0	-85	22.17
			QPSK	6	0	0	-85	21.35
			16QAM	1	0	0	-85	21.66
			16QAM	1	5	0	-85	21.84
High Range	19193	1909.3	16QAM	3	0	0	-85	21.01
			16QAM	5	0	0	-85	20.65
			QPSK	1	0	0	-85	23.85
			QPSK	1	5	0	-85	23.74
			QPSK	3	3	0	-85	22.10
			QPSK	6	0	0	-85	21.18
			16QAM	1	0	0	-85	21.66
			16QAM	1	5	0	-85	21.75
			16QAM	3	0	0	-85	20.91
			16QAM	5	0	0	-85	20.57

LTE Band 2								
BW (MHz): 3								
Test Frequency ID	N _{UL}	Frequency of Uplink (MHz)	Test Configuration Initial of Power				EUT	
			Modulation	RB Size	RB Offset	Narrowband Index	Cell Power (dBm/15 kHz)	Power (dBm)
Low Range	18615	1851.5	QPSK	1	0	0	-85	22.76
			QPSK	1	5	0	-85	22.78
			QPSK	1	0	1	-85	22.81
			QPSK	1	5	1	-85	22.84
			QPSK	3	3	0	-85	21.91
			QPSK	3	3	1	-85	21.94
			QPSK	6	0	0	-85	21.01
			QPSK	6	0	1	-85	21.01
			16QAM	1	0	0	-85	21.08
			16QAM	1	5	0	-85	21.04
			16QAM	1	0	1	-85	21.05
			16QAM	1	5	1	-85	21.12
			16QAM	3	0	0	-85	20.61
			16QAM	3	3	1	-85	20.88
			16QAM	5	0	0	-85	20.41
Mid. Range	18900	1880	QPSK	1	0	0	-85	23.01
			QPSK	1	5	0	-85	22.95
			QPSK	1	0	1	-85	22.88
			QPSK	1	5	1	-85	23.13
			QPSK	3	3	0	-85	22.01
			QPSK	3	3	1	-85	22.04
			QPSK	6	0	0	-85	21.18
			QPSK	6	0	1	-85	21.04
			16QAM	1	0	0	-85	21.22
			16QAM	1	5	0	-85	21.26
			16QAM	1	0	1	-85	21.60
			16QAM	1	5	1	-85	21.43
			16QAM	3	0	0	-85	20.81
			16QAM	3	3	1	-85	21.20
			16QAM	5	0	0	-85	20.53
High Range	19185	1908.5	QPSK	1	0	0	-85	22.86
			QPSK	1	5	0	-85	22.79
			QPSK	1	0	1	-85	22.72
			QPSK	1	5	1	-85	22.81
			QPSK	3	3	0	-85	21.93
			QPSK	3	3	1	-85	22.03
			QPSK	6	0	0	-85	21.10
			QPSK	6	0	1	-85	20.89
			16QAM	1	0	0	-85	21.85
			16QAM	1	5	0	-85	21.46
			16QAM	1	0	1	-85	21.90
			16QAM	1	5	1	-85	21.40
			16QAM	3	0	0	-85	21.03
			16QAM	3	3	1	-85	20.94
			16QAM	5	0	0	-85	20.95
16QAM	5	0	1	-85	20.92			

LTE Band 2								
BW (MHz): 5								
Test Frequency ID	N _{UL}	Frequency of Uplink (MHz)	Test Configuration Initial of Power				EUT	
			Modulation	RB Size	RB Offset	Narrowband Index	Cell Power (dBm/15 kHz)	Power (dBm)
Low Range	18625	1852.5	QPSK	1	0	0	-85	22.59
			QPSK	1	5	0	-85	22.63
			QPSK	1	0	1	-85	22.67
			QPSK	1	5	1	-85	22.74
			QPSK	1	0	3	-85	22.70
			QPSK	1	5	3	-85	22.74
			QPSK	3	0	0	-85	21.88
			QPSK	3	3	3	-85	21.82
			QPSK	6	0	0	-85	21.93
			QPSK	6	0	1	-85	21.97
			QPSK	6	0	3	-85	22.01
			16QAM	1	0	0	-85	22.04
			16QAM	1	5	0	-85	22.04
			16QAM	1	0	1	-85	22.04
			16QAM	1	5	1	-85	22.06
			16QAM	1	0	3	-85	22.04
			16QAM	1	5	3	-85	22.06
			16QAM	3	0	0	-85	21.55
16QAM	3	3	3	-85	21.80			
16QAM	5	0	0	-85	20.39			
16QAM	5	0	1	-85	20.38			
16QAM	5	0	3	-85	20.50			
Mid. Range	18900	1880	QPSK	1	0	0	-85	22.85
			QPSK	1	5	0	-85	22.85
			QPSK	1	0	1	-85	22.82
			QPSK	1	5	1	-85	22.88
			QPSK	1	0	3	-85	22.91
			QPSK	1	5	3	-85	22.94
			QPSK	3	0	0	-85	22.05
			QPSK	3	3	3	-85	22.01
			QPSK	6	0	0	-85	22.08
			QPSK	6	0	1	-85	22.04
			QPSK	6	0	3	-85	22.22
			16QAM	1	0	0	-85	22.23
			16QAM	1	5	0	-85	22.19
			16QAM	1	0	1	-85	22.29
			16QAM	1	5	1	-85	22.20
			16QAM	1	0	3	-85	22.23
			16QAM	1	5	3	-85	22.29
			16QAM	3	0	0	-85	21.69
			16QAM	3	3	3	-85	21.88
			16QAM	5	0	0	-85	20.56
16QAM	5	0	1	-85	20.45			
16QAM	5	0	3	-85	20.70			

LTE Band 2								
BW (MHz): 5								
Test Frequency ID	N _{UL}	Frequency of Uplink (MHz)	Test Configuration Initial of Power				EUT	
			Modulation	RB Size	RB Offset	Narrowband Index	Cell Power (dBm/15 kHz)	Power (dBm)
High Range	19175	1907.5	QPSK	1	0	0	-85	22.76
			QPSK	1	5	0	-85	22.78
			QPSK	1	0	1	-85	22.92
			QPSK	1	5	1	-85	22.97
			QPSK	1	0	3	-85	22.80
			QPSK	3	0	0	-85	22.06
			QPSK	3	3	3	-85	22.86
			QPSK	6	0	0	-85	22.03
			QPSK	6	0	1	-85	22.09
			QPSK	6	0	3	-85	22.05
			16QAM	1	0	0	-85	22.08
			16QAM	1	5	0	-85	22.10
			16QAM	1	0	1	-85	22.14
			16QAM	1	5	1	-85	22.10
			16QAM	1	0	3	-85	22.14
			16QAM	1	5	3	-85	22.12
			16QAM	3	0	0	-85	21.61
			16QAM	3	3	3	-85	21.65
			16QAM	5	0	0	-85	20.48
			16QAM	5	0	1	-85	20.65
16QAM	5	0	3	-85	20.49			

LTE Band 2								
BW (MHz): 10								
Test Frequency ID	N _{UL}	Frequency of Uplink (MHz)	Test Configuration Initial of Power				EUT	
			Modulation	RB Size	RB Offset	Narrowband Index	Cell Power (dBm/15 kHz)	Power (dBm)
Low Range	18650	1855	QPSK	1	0	0	-85	22.74
			QPSK	1	5	0	-85	22.62
			QPSK	1	0	3	-85	22.96
			QPSK	1	5	3	-85	22.84
			QPSK	1	0	7	-85	22.86
			QPSK	1	5	7	-85	22.88
			QPSK	4	0	0	-85	22.75
			QPSK	4	2	7	-85	22.97
			QPSK	6	0	0	-85	21.84
			QPSK	6	0	7	-85	21.98
			16QAM	1	0	0	-85	22.11
			16QAM	1	5	0	-85	22.63
			16QAM	1	0	3	-85	22.76
			16QAM	1	5	3	-85	22.80
			16QAM	1	0	7	-85	23.01
			16QAM	1	5	7	-85	22.20
			16QAM	4	2	0	-85	22.06
			16QAM	4	2	7	-85	22.05
16QAM	5	0	0	-85	21.67			
16QAM	5	0	7	-85	21.72			
Mid. Range	18900	1880	QPSK	1	0	0	-85	22.79
			QPSK	1	5	0	-85	22.79
			QPSK	1	0	3	-85	22.82
			QPSK	1	5	3	-85	22.76
			QPSK	1	0	7	-85	22.82
			QPSK	1	5	7	-85	22.79
			QPSK	4	0	0	-85	22.89
			QPSK	4	2	7	-85	23.01
			QPSK	6	0	0	-85	21.93
			QPSK	6	0	7	-85	21.97
			16QAM	1	0	0	-85	23.08
			16QAM	1	5	0	-85	22.21
			16QAM	1	0	3	-85	22.08
			16QAM	1	5	3	-85	21.94
			16QAM	1	0	7	-85	22.52
			16QAM	1	5	7	-85	22.72
			16QAM	4	2	0	-85	22.06
			16QAM	4	2	7	-85	22.07
16QAM	5	0	0	-85	21.71			
16QAM	5	0	7	-85	21.94			
High Range	19150	1905	QPSK	1	0	0	-85	23.11
			QPSK	1	5	0	-85	23.02
			QPSK	1	5	7	-85	22.71
			QPSK	1	0	3	-85	23.05
			QPSK	1	5	3	-85	23.01
			QPSK	1	0	7	-85	22.95
			QPSK	4	0	0	-85	23.08
			QPSK	4	2	7	-85	23.03
			QPSK	6	0	0	-85	22.09
			QPSK	6	0	7	-85	21.97
			16QAM	1	0	0	-85	23.18
			16QAM	1	5	0	-85	23.05
			16QAM	1	0	3	-85	22.98
			16QAM	1	5	3	-85	23.05
			16QAM	1	0	7	-85	22.84
			16QAM	1	5	7	-85	22.62
			16QAM	4	2	0	-85	22.12
			16QAM	4	2	7	-85	22.29
16QAM	5	0	0	-85	21.85			
16QAM	5	0	7	-85	21.86			

LTE Band 2								
BW (MHz): 15								
Test Frequency ID	N _{UL}	Frequency of Uplink (MHz)	Test Configuration Initial of Power				EUT	
			Modulation	RB Size	RB Offset	Narrowband Index	Cell Power (dBm/15 kHz)	Power (dBm)
Low Range	18675	1857.5	QPSK	1	0	0	-85	22.75
			QPSK	1	5	0	-85	22.80
			QPSK	1	0	5	-85	22.74
			QPSK	1	5	5	-85	22.83
			QPSK	1	0	11	-85	22.89
			QPSK	1	5	11	-85	22.94
			QPSK	3	0	0	-85	22.97
			QPSK	3	3	11	-85	23.01
			QPSK	6	0	0	-85	22.80
			QPSK	6	0	11	-85	22.96
			16QAM	1	0	0	-85	23.04
			16QAM	1	5	0	-85	22.80
			16QAM	1	0	5	-85	22.96
			16QAM	1	5	5	-85	22.49
			16QAM	1	0	11	-85	22.90
			16QAM	1	5	11	-85	22.77
			16QAM	3	0	0	-85	22.76
			16QAM	3	3	11	-85	23.09
16QAM	5	0	0	-85	22.75			
16QAM	5	0	11	-85	22.82			
Mid. Range	18900	1880	QPSK	1	0	0	-85	22.99
			QPSK	1	5	0	-85	22.94
			QPSK	1	0	5	-85	22.85
			QPSK	1	5	5	-85	22.97
			QPSK	1	0	11	-85	22.84
			QPSK	1	5	11	-85	22.91
			QPSK	3	0	0	-85	22.97
			QPSK	3	3	11	-85	23.09
			QPSK	6	0	0	-85	23.01
			QPSK	6	0	11	-85	23.00
			16QAM	1	0	0	-85	23.16
			16QAM	1	5	0	-85	23.12
			16QAM	1	0	5	-85	22.70
			16QAM	1	5	5	-85	22.83
			16QAM	1	0	11	-85	22.93
			16QAM	1	5	11	-85	22.75
			16QAM	3	0	0	-85	22.92
			16QAM	3	3	11	-85	22.85
16QAM	5	0	0	-85	22.74			
16QAM	5	0	11	-85	23.01			
High Range	19125	1902.5	QPSK	1	0	0	-85	23.07
			QPSK	1	5	11	-85	22.95
			QPSK	1	0	5	-85	23.09
			QPSK	1	5	5	-85	22.95
			QPSK	1	0	11	-85	23.00
			QPSK	1	5	11	-85	22.96
			QPSK	3	0	0	-85	22.94
			QPSK	3	3	11	-85	23.10
			QPSK	6	0	0	-85	23.12
			QPSK	6	0	11	-85	23.09
			16QAM	1	0	0	-85	23.27
			16QAM	1	5	0	-85	22.72
			16QAM	1	0	5	-85	23.10
			16QAM	1	5	5	-85	22.95
			16QAM	1	0	11	-85	22.17
			16QAM	1	5	11	-85	22.68
			16QAM	3	0	0	-85	23.05
			16QAM	3	3	11	-85	22.70
16QAM	5	0	0	-85	23.02			
16QAM	5	0	11	-85	22.94			

LTE Band 2								
BW (MHz): 20								
Test Frequency ID	N _{UL}	Frequency of Uplink (MHz)	Test Configuration Initial of Power				EUT	
			Modulation	RB Size	RB Offset	Narrowband Index	Cell Power (dBm/15 kHz)	Power (dBm)
Low Range	18700	1860	QPSK	1	0	0	-85	24.03
			QPSK	1	5	0	-85	22.90
			QPSK	1	0	7	-85	22.59
			QPSK	1	5	7	-85	22.70
			QPSK	1	0	15	-85	22.94
			QPSK	1	5	15	-85	23.01
			QPSK	3	0	0	-85	22.74
			QPSK	3	3	15	-85	22.82
			QPSK	6	0	0	-85	22.83
			QPSK	6	0	15	-85	22.97
			16QAM	1	0	0	-85	22.56
			16QAM	1	5	0	-85	22.55
			16QAM	1	0	7	-85	22.62
			16QAM	1	5	7	-85	22.91
			16QAM	1	0	15	-85	22.48
			16QAM	1	5	15	-85	22.53
			16QAM	3	0	0	-85	22.90
			16QAM	3	3	15	-85	22.93
16QAM	5	0	0	-85	22.71			
16QAM	5	0	15	-85	22.88			
Mid. Range	18900	1880	QPSK	1	0	0	-85	24.10
			QPSK	1	5	0	-85	22.93
			QPSK	1	0	7	-85	22.97
			QPSK	1	5	7	-85	22.94
			QPSK	1	0	15	-85	22.82
			QPSK	1	5	15	-85	23.10
			QPSK	3	0	0	-85	23.00
			QPSK	3	3	15	-85	23.05
			QPSK	6	0	0	-85	22.94
			QPSK	6	0	15	-85	23.08
			16QAM	1	0	0	-85	23.05
			16QAM	1	5	0	-85	22.83
			16QAM	1	0	7	-85	22.63
			16QAM	1	5	7	-85	22.94
			16QAM	1	0	15	-85	22.82
			16QAM	1	5	15	-85	22.93
			16QAM	3	0	0	-85	22.94
			16QAM	3	3	15	-85	22.81
16QAM	5	0	0	-85	22.84			
16QAM	5	0	15	-85	22.99			
High Range	19100	1900	QPSK	1	0	0	-85	24.01
			QPSK	1	5	0	-85	23.05
			QPSK	1	0	7	-85	23.08
			QPSK	1	5	7	-85	23.07
			QPSK	1	0	15	-85	23.04
			QPSK	1	5	15	-85	23.05
			QPSK	3	0	0	-85	22.97
			QPSK	3	3	15	-85	23.05
			QPSK	6	0	0	-85	23.11
			QPSK	6	0	15	-85	23.09
			16QAM	1	0	0	-85	23.22
			16QAM	1	5	0	-85	23.07
			16QAM	1	0	7	-85	23.05
			16QAM	1	5	7	-85	23.05
			16QAM	1	0	15	-85	22.77
			16QAM	1	5	15	-85	22.78
			16QAM	3	0	0	-85	23.07
			16QAM	3	3	15	-85	23.03
16QAM	5	0	0	-85	22.97			
16QAM	5	0	15	-85	23.04			

LTE Band 25								
BW (MHz): 1.4								
Test Frequency ID	N _{UL}	Frequency of Uplink (MHz)	Test Configuration Initial of Power				EUT	
			Modulation	RB Size	RB Offset	Narrowband Index	Cell Power (dBm/15 kHz)	Power (dBm)
Low Range	26047	1850.7	QPSK	1	0	0	-85	23.92
			QPSK	1	5	0	-85	23.87
			QPSK	3	3	0	-85	22.32
			QPSK	6	0	0	-85	21.43
			16QAM	1	0	0	-85	21.80
			16QAM	1	5	0	-85	21.93
			16QAM	3	0	0	-85	21.10
Mid. Range	26365	1882.5	16QAM	5	0	0	-85	20.69
			QPSK	1	0	0	-85	24.03
			QPSK	1	5	0	-85	23.99
			QPSK	3	3	0	-85	22.49
			QPSK	6	0	0	-85	21.66
			16QAM	1	0	0	-85	22.04
			16QAM	1	5	0	-85	22.12
High Range	26683	1914.3	16QAM	3	0	0	-85	21.30
			16QAM	5	0	0	-85	20.96
			QPSK	1	0	0	-85	23.98
			QPSK	1	5	0	-85	23.78
			QPSK	3	3	0	-85	22.33
			QPSK	6	0	0	-85	21.50
			16QAM	1	0	0	-85	21.86
High Range	26683	1914.3	16QAM	1	5	0	-85	21.95
			16QAM	3	0	0	-85	21.12
			16QAM	5	0	0	-85	20.69
			16QAM	5	0	0	-85	20.69

LTE Band 25								
BW (MHz): 3								
Test Frequency ID	N _{UL}	Frequency of Uplink (MHz)	Test Configuration Initial of Power				EUT	
			Modulation	RB Size	RB Offset	Narrowband Index	Cell Power (dBm/15 kHz)	Power (dBm)
Low Range	26055	1851.5	QPSK	1	0	0	-85	23.13
			QPSK	1	5	0	-85	23.12
			QPSK	1	0	1	-85	23.02
			QPSK	1	5	1	-85	23.08
			QPSK	3	3	0	-85	22.27
			QPSK	3	3	1	-85	22.18
			QPSK	6	0	0	-85	21.30
			QPSK	6	0	1	-85	21.32
			16QAM	1	0	0	-85	21.41
			16QAM	1	5	0	-85	21.45
			16QAM	1	0	1	-85	21.44
			16QAM	1	5	1	-85	21.38
			16QAM	3	0	0	-85	21.05
			16QAM	3	3	1	-85	21.13
			16QAM	5	0	0	-85	20.85
16QAM	5	0	1	-85	20.74			
Mid. Range	26365	1882.5	QPSK	1	0	0	-85	23.35
			QPSK	1	5	0	-85	23.34
			QPSK	1	0	1	-85	23.06
			QPSK	1	5	1	-85	23.09
			QPSK	3	3	0	-85	22.45
			QPSK	3	3	1	-85	22.21
			QPSK	6	0	0	-85	21.56
			QPSK	6	0	1	-85	21.30
			16QAM	1	0	0	-85	21.62
			16QAM	1	5	0	-85	21.60
			16QAM	1	0	1	-85	21.41
			16QAM	1	5	1	-85	21.37
			16QAM	3	0	0	-85	21.15
			16QAM	3	3	1	-85	21.13
			16QAM	5	0	0	-85	20.90
16QAM	5	0	1	-85	20.70			
High Range	26675	1913.5	QPSK	1	0	0	-85	23.19
			QPSK	1	5	0	-85	23.21
			QPSK	1	0	1	-85	23.20
			QPSK	1	5	1	-85	23.15
			QPSK	3	3	0	-85	22.32
			QPSK	3	3	1	-85	22.27
			QPSK	6	0	0	-85	21.46
			QPSK	6	0	1	-85	21.48
			16QAM	1	0	0	-85	21.45
			16QAM	1	5	0	-85	21.51
			16QAM	1	0	1	-85	21.41
			16QAM	1	5	1	-85	21.33
			16QAM	3	0	0	-85	20.95
			16QAM	3	3	1	-85	21.02
			16QAM	5	0	0	-85	20.71
16QAM	5	0	1	-85	20.62			

LTE Band 25								
BW (MHz): 5								
Test Frequency ID	N _{UL}	Frequency of Uplink (MHz)	Test Configuration Initial of Power				EUT	
			Modulation	RB Size	RB Offset	Narrowband Index	Cell Power (dBm/15 kHz)	Power (dBm)
Low Range	26065	1852.5	QPSK	1	0	0	-85	23.10
			QPSK	1	5	0	-85	23.15
			QPSK	1	0	1	-85	23.17
			QPSK	1	5	1	-85	23.19
			QPSK	1	0	3	-85	23.19
			QPSK	1	5	3	-85	23.19
			QPSK	3	0	0	-85	22.10
			QPSK	3	3	3	-85	22.32
			QPSK	6	0	0	-85	22.21
			QPSK	6	0	1	-85	22.35
			QPSK	6	0	3	-85	22.40
			16QAM	1	0	0	-85	23.25
			16QAM	1	5	0	-85	23.25
			16QAM	1	0	1	-85	22.83
			16QAM	1	5	1	-85	23.15
			16QAM	1	0	3	-85	22.91
			16QAM	1	5	3	-85	22.80
			16QAM	3	0	0	-85	22.21
16QAM	3	3	3	-85	22.27			
16QAM	5	0	0	-85	20.97			
16QAM	5	0	1	-85	21.14			
16QAM	5	0	3	-85	21.04			
Mid. Range	26365	1882.5	QPSK	1	0	0	-85	23.27
			QPSK	1	5	0	-85	23.22
			QPSK	1	0	1	-85	23.19
			QPSK	1	5	1	-85	23.21
			QPSK	1	0	3	-85	23.24
			QPSK	1	5	3	-85	23.18
			QPSK	3	0	0	-85	23.08
			QPSK	3	3	3	-85	22.36
			QPSK	6	0	0	-85	22.55
			QPSK	6	0	1	-85	22.31
			QPSK	6	0	3	-85	22.45
			16QAM	1	0	0	-85	23.15
			16QAM	1	5	0	-85	23.15
			16QAM	1	0	1	-85	22.83
			16QAM	1	5	1	-85	22.89
			16QAM	1	0	3	-85	22.95
			16QAM	1	5	3	-85	22.86
			16QAM	3	0	0	-85	22.30
16QAM	3	3	3	-85	22.27			
16QAM	6	0	0	-85	21.34			
16QAM	6	0	1	-85	21.14			
16QAM	6	0	3	-85	21.06			

LTE Band 25								
BW (MHz): 5								
Test Frequency ID	N _{UL}	Frequency of Uplink (MHz)	Test Configuration Initial of Power				EUT	
			Modulation	RB Size	RB Offset	Narrowband Index	Cell Power (dBm/15 kHz)	Power (dBm)
High Range	26665	1912.5	QPSK	1	0	0	-85	23.10
			QPSK	1	5	0	-85	23.13
			QPSK	1	0	1	-85	23.11
			QPSK	1	5	1	-85	23.16
			QPSK	1	0	3	-85	23.17
			QPSK	1	5	3	-85	23.14
			QPSK	3	0	0	-85	22.14
			QPSK	3	3	3	-85	22.28
			QPSK	6	0	0	-85	22.24
			QPSK	6	0	1	-85	22.40
			QPSK	6	0	3	-85	22.26
			16QAM	1	0	0	-85	22.90
			16QAM	1	5	0	-85	23.03
			16QAM	1	0	1	-85	22.73
			16QAM	1	5	1	-85	22.87
			16QAM	1	0	3	-85	22.90
			16QAM	1	5	3	-85	22.75
			16QAM	3	0	0	-85	22.22
			16QAM	3	3	3	-85	22.23
			16QAM	5	0	0	-85	21.05
16QAM	5	0	1	-85	21.03			
16QAM	5	0	3	-85	21.00			

LTE Band 25								
BW (MHz): 10								
Test Frequency ID	N _{UL}	Frequency of Uplink (MHz)	Test Configuration Initial of Power				EUT	
			Modulation	RB Size	RB Offset	Narrowband Index	Cell Power (dBm/15 kHz)	Power (dBm)
Low Range	26090	1855	QPSK	1	0	0	-85	23.23
			QPSK	1	5	0	-85	23.16
			QPSK	1	0	3	-85	23.24
			QPSK	1	5	3	-85	23.28
			QPSK	1	0	7	-85	23.23
			QPSK	1	5	7	-85	23.08
			QPSK	4	0	0	-85	23.11
			QPSK	4	2	7	-85	23.38
			QPSK	6	0	0	-85	22.32
			QPSK	6	0	7	-85	22.48
			16QAM	1	0	0	-85	23.18
			16QAM	1	5	0	-85	23.35
			16QAM	1	0	3	-85	23.00
			16QAM	1	5	3	-85	23.00
			16QAM	1	0	7	-85	23.04
			16QAM	1	5	7	-85	23.04
			16QAM	4	2	0	-85	22.26
			16QAM	4	2	7	-85	22.81
			16QAM	5	0	0	-85	21.94
			16QAM	5	0	7	-85	22.08
Mid. Range	26365	1882.5	QPSK	1	0	0	-85	23.38
			QPSK	1	5	0	-85	23.20
			QPSK	1	0	3	-85	23.19
			QPSK	1	5	3	-85	23.29
			QPSK	1	0	7	-85	23.25
			QPSK	1	5	7	-85	23.17
			QPSK	4	0	0	-85	23.34
			QPSK	4	2	7	-85	23.47
			QPSK	6	0	0	-85	22.31
			QPSK	6	0	7	-85	22.51
			16QAM	1	0	0	-85	23.26
			16QAM	1	5	0	-85	23.15
			16QAM	1	0	3	-85	22.98
			16QAM	1	5	3	-85	22.96
			16QAM	1	0	7	-85	22.96
			16QAM	1	5	7	-85	22.97
			16QAM	4	2	0	-85	22.66
			16QAM	4	2	7	-85	22.74
			16QAM	5	0	0	-85	22.21
			16QAM	5	0	7	-85	22.08
High Range	26640	1910	QPSK	1	0	0	-85	23.28
			QPSK	1	5	0	-85	23.42
			QPSK	1	5	7	-85	23.30
			QPSK	1	0	3	-85	23.16
			QPSK	1	5	3	-85	23.30
			QPSK	1	0	7	-85	23.31
			QPSK	4	0	0	-85	23.22
			QPSK	4	2	7	-85	23.42
			QPSK	6	0	0	-85	22.60
			QPSK	6	0	7	-85	22.49
			16QAM	1	0	0	-85	23.13
			16QAM	1	5	0	-85	23.22
			16QAM	1	0	3	-85	23.06
			16QAM	1	5	3	-85	22.96
			16QAM	1	0	7	-85	22.93
			16QAM	1	5	7	-85	23.01
			16QAM	4	2	0	-85	23.06
			16QAM	4	2	7	-85	22.73
			16QAM	6	0	0	-85	22.26
			16QAM	6	0	7	-85	22.03

LTE Band 25										
BW (MHz): 15		Test Configuration Initial of Power							EUT	
Test Frequency ID	N _{UL}	Frequency of Uplink (MHz)	Modulation	RB Size	RB Offset	Narrowband Index	Cell Power (dBm/15 kHz)	Power (dBm)		
Low Range	26115	1857.5	QPSK	1	0	0	-85	22.89		
			QPSK	1	5	0	-85	23.06		
			QPSK	1	0	5	-85	23.00		
			QPSK	1	5	5	-85	22.99		
			QPSK	1	0	11	-85	23.04		
			QPSK	1	5	11	-85	23.00		
			QPSK	3	0	0	-85	23.12		
			QPSK	3	3	11	-85	22.85		
			QPSK	6	0	0	-85	23.04		
			QPSK	6	0	11	-85	22.92		
			16QAM	1	0	0	-85	23.10		
			16QAM	1	5	0	-85	23.10		
			16QAM	1	0	5	-85	23.10		
			16QAM	1	5	5	-85	23.11		
			16QAM	1	0	11	-85	23.07		
			16QAM	1	5	11	-85	23.09		
			16QAM	3	0	0	-85	23.04		
			16QAM	3	3	11	-85	22.93		
16QAM	5	0	0	-85	22.93					
16QAM	5	0	11	-85	22.69					
Mid. Range	26365	1882.5	QPSK	1	0	0	-85	23.10		
			QPSK	1	5	0	-85	23.11		
			QPSK	1	0	5	-85	23.13		
			QPSK	1	5	5	-85	23.13		
			QPSK	1	0	11	-85	23.19		
			QPSK	1	5	11	-85	23.15		
			QPSK	3	0	0	-85	23.25		
			QPSK	3	3	11	-85	23.10		
			QPSK	6	0	0	-85	23.13		
			QPSK	6	0	11	-85	23.14		
			16QAM	1	0	0	-85	23.07		
			16QAM	1	5	0	-85	23.14		
			16QAM	1	0	5	-85	23.23		
			16QAM	1	5	5	-85	23.22		
			16QAM	1	0	11	-85	23.10		
			16QAM	1	5	11	-85	23.11		
			16QAM	3	0	0	-85	23.18		
			16QAM	3	3	11	-85	23.09		
16QAM	5	0	0	-85	23.13					
16QAM	5	0	11	-85	22.97					
High Range	26615	1907.5	QPSK	1	0	0	-85	23.26		
			QPSK	1	5	11	-85	23.04		
			QPSK	1	0	5	-85	23.19		
			QPSK	1	5	5	-85	23.11		
			QPSK	1	0	11	-85	23.07		
			QPSK	3	0	0	-85	23.24		
			QPSK	3	3	11	-85	23.03		
			QPSK	6	0	0	-85	23.14		
			QPSK	6	0	11	-85	23.34		
			16QAM	1	0	0	-85	23.18		
			16QAM	1	5	0	-85	23.25		
			16QAM	1	0	5	-85	23.14		
			16QAM	1	5	5	-85	23.25		
			16QAM	1	0	11	-85	23.16		
			16QAM	1	5	11	-85	23.12		
			16QAM	3	0	0	-85	23.21		
			16QAM	3	3	11	-85	23.08		
			16QAM	5	0	0	-85	23.13		
16QAM	5	0	11	-85	23.08					

LTE Band 25								
BW (MHz): 20								
Test Frequency ID	N _{UL}	Frequency of Uplink (MHz)	Test Configuration Initial of Power				EUT	
			Modulation	RB Size	RB Offset	Narrowband Index	Cell Power (dBm/15 kHz)	Power (dBm)
Low Range	26140	1860	QPSK	1	0	0	-85	24.05
			QPSK	1	5	0	-85	23.79
			QPSK	1	0	7	-85	23.70
			QPSK	1	5	7	-85	23.71
			QPSK	1	0	15	-85	23.94
			QPSK	1	5	15	-85	23.77
			QPSK	3	0	0	-85	23.91
			QPSK	3	3	15	-85	23.78
			QPSK	6	0	0	-85	23.86
			QPSK	6	0	15	-85	23.73
			16QAM	1	0	0	-85	23.86
			16QAM	1	5	0	-85	23.89
			16QAM	1	0	7	-85	23.83
			16QAM	1	5	7	-85	23.84
			16QAM	1	0	15	-85	23.70
			16QAM	1	5	15	-85	23.67
			16QAM	3	0	0	-85	23.81
			16QAM	3	3	15	-85	23.61
16QAM	5	0	0	-85	23.64			
16QAM	5	0	15	-85	23.72			
Mid. Range	26365	1882.5	QPSK	1	0	0	-85	24.16
			QPSK	1	5	0	-85	23.81
			QPSK	1	0	7	-85	23.83
			QPSK	1	5	7	-85	23.85
			QPSK	1	0	15	-85	23.79
			QPSK	1	5	15	-85	23.65
			QPSK	3	0	0	-85	23.99
			QPSK	3	3	15	-85	23.79
			QPSK	6	0	0	-85	23.87
			QPSK	6	0	15	-85	23.90
			16QAM	1	0	0	-85	23.91
			16QAM	1	5	0	-85	23.75
			16QAM	1	0	7	-85	23.98
			16QAM	1	5	7	-85	23.91
			16QAM	1	0	15	-85	23.96
			16QAM	1	5	15	-85	24.02
			16QAM	3	0	0	-85	23.66
			16QAM	3	3	15	-85	24.07
16QAM	5	0	0	-85	23.94			
16QAM	5	0	15	-85	23.75			
High Range	26590	1905	QPSK	1	0	0	-85	24.11
			QPSK	1	5	0	-85	23.92
			QPSK	1	0	7	-85	23.68
			QPSK	1	5	7	-85	23.78
			QPSK	1	0	15	-85	23.82
			QPSK	1	5	15	-85	23.73
			QPSK	3	0	0	-85	24.08
			QPSK	3	3	15	-85	23.75
			QPSK	6	0	0	-85	23.98
			QPSK	6	0	15	-85	24.01
			16QAM	1	0	0	-85	24.01
			16QAM	1	5	0	-85	23.90
			16QAM	1	0	7	-85	23.74
			16QAM	1	5	7	-85	23.72
			16QAM	1	0	15	-85	23.69
			16QAM	1	5	15	-85	23.85
			16QAM	3	0	0	-85	24.07
			16QAM	3	3	15	-85	23.73
16QAM	5	0	0	-85	23.97			
16QAM	5	0	15	-85	23.74			

NB-IoT

LTE Band 2							
Stand-alone							
N _{UL}	M _{UL}	Frequency of Uplink (MHz)	Test Configuration Initial of Power			EUT	
			Modulation	N _{tones}	Sub-carrier Spacing (kHz)	Cell Power (dBm/15 kHz)	Power (dBm)
18602	0	1850.2	BPSK	1@0	3.75	-110	21.34
			BPSK	1@0	15	-110	21.45
			QPSK	1@0	3.75	-110	21.42
			QPSK	1@0	15	-110	21.49
			QPSK	3@3	15	-110	21.95
			QPSK	12@0	15	-110	20.33
18900	0	1880	BPSK	1@0	3.75	-110	22.16
			BPSK	1@0	15	-110	22.18
			BPSK	1@47	3.75	-110	22.41
			QPSK	1@0	3.75	-110	22.84
			QPSK	1@0	15	-110	22.87
			QPSK	1@11	15	-110	22.91
			QPSK	3@3	15	-110	23.17
19198	0	1909.8	QPSK	12@0	15	-110	22.77
			BPSK	1@47	3.75	-110	21.64
			BPSK	1@47	15	-110	21.66
			QPSK	1@11	3.75	-110	21.53
			QPSK	1@11	15	-110	21.55
			QPSK	3@3	15	-110	21.84
QPSK	12@0	15	-110	21.11			

LTE Band 2							
In-Band	BW (MHz): 3						
N _{UL}	M _{UL}	Frequency of Uplink (MHz)	Test Configuration Initial of Power			EUT	
			Modulation	N _{tones}	Sub-carrier Spacing (kHz)	Cell Power (dBm/15 kHz)	Power (dBm)
18607	0	1850.7	BPSK	1@0	3.75	-110	21.69
			QPSK	1@0	15	-110	22.22
			QPSK	3@3	15	-110	22.42
			QPSK	12@0	15	-110	22.25
18891	0	1879.1	BPSK	1@0	3.75	-110	22.01
			BPSK	1@47	3.75	-110	22.16
			QPSK	1@0	15	-110	22.47
			QPSK	1@11	15	-110	22.73
			QPSK	3@3	15	-110	22.88
			QPSK	12@0	15	-110	22.67
19193	0	1909.3	BPSK	1@47	3.75	-110	22.44
			QPSK	1@11	15	-110	22.77
			QPSK	3@3	15	-110	22.87
			QPSK	12@0	15	-110	22.68

LTE Band 2							
In-Band	BW (MHz): 10	NB-IoT PRB: 30					
N _{UL}	M _{UL}	Frequency of Uplink (MHz)	Test Configuration Initial of Power			EUT	
			Modulation	N _{tones}	Sub-carrier Spacing (kHz)	Cell Power (dBm/15 kHz)	Power (dBm)
18661	-2	1856.09	BPSK	1@0	3.75	-110	21.53
			QPSK	1@0	15	-110	22.09
			QPSK	3@3	15	-110	22.31
			QPSK	12@0	15	-110	22.16
18910	-2	1880.99	BPSK	1@0	3.75	-110	21.87
			BPSK	1@47	3.75	-110	22.02
			QPSK	1@0	15	-110	22.32
			QPSK	1@11	15	-110	22.60
			QPSK	3@3	15	-110	22.78
			QPSK	12@0	15	-110	22.53
19159	-2	1905.89	BPSK	1@47	3.75	-110	22.33
			QPSK	1@11	15	-110	22.64
			QPSK	3@3	15	-110	22.71
			QPSK	12@0	15	-110	22.58

LTE Band 2							
In-Band	BW (MHz): 10	NB-IoT PRB: 35	Test Configuration Initial of Power			EUT	
N _{UL}	M _{UL}	Frequency of Uplink (MHz)	Modulation	N _{tones}	Sub-carrier Spacing (kHz)	Cell Power (dBm/15 kHz)	Power (dBm)
18670	-2	1856.99	BPSK	1@0	3.75	-110	21.39
			QPSK	1@0	15	-110	21.95
			QPSK	3@3	15	-110	22.17
			QPSK	12@0	15	-110	21.99
18919	-2	1881.89	BPSK	1@0	3.75	-110	21.76
			BPSK	1@47	3.75	-110	21.93
			QPSK	1@0	15	-110	22.16
			QPSK	1@11	15	-110	22.47
			QPSK	3@3	15	-110	22.59
19168	-2	1906.79	QPSK	12@0	15	-110	22.42
			BPSK	1@47	3.75	-110	22.16
			QPSK	1@11	15	-110	22.57
			QPSK	3@3	15	-110	22.64
			QPSK	12@0	15	-110	22.42

LTE Band 2							
Guard-Band	BW (MHz): 5	Test Configuration Initial of Power			EUT		
N _{UL}	M _{UL}	Frequency of Uplink (MHz)	Modulation	N _{tones}	Sub-carrier Spacing (kHz)	Cell Power (dBm/15 kHz)	Power (dBm)
18602	0	1850.2	BPSK	1@0	3.75	-110	21.22
			QPSK	1@0	15	-110	21.39
			QPSK	3@3	15	-110	21.86
			QPSK	12@0	15	-110	21.17
18876	0	1877.6	BPSK	1@0	3.75	-110	22.06
			BPSK	1@47	3.75	-110	22.32
			QPSK	1@0	15	-110	22.74
			QPSK	1@11	15	-110	22.76
			QPSK	3@3	15	-110	23.05
19198	0	1909.8	QPSK	12@0	15	-110	22.64
			BPSK	1@47	3.75	-110	21.49
			QPSK	1@11	15	-110	21.41
			QPSK	3@3	15	-110	21.69
			QPSK	12@0	15	-110	20.99

LTE Band 25							
Stand-alone							
N _{UL}	M _{UL}	Frequency of Uplink (MHz)	Test Configuration Initial of Power			EUT	
			Modulation	N _{tones}	Sub-carrier Spacing (kHz)	Cell Power (dBm/15 kHz)	Power (dBm)
26042	0	1850.2	BPSK	1@0	3.75	-110	21.67
			BPSK	1@0	15	-110	21.68
			QPSK	1@0	3.75	-110	21.72
			QPSK	1@0	15	-110	21.73
			QPSK	3@3	15	-110	21.96
26365	0	1882.5	QPSK	12@0	15	-110	21.59
			BPSK	1@0	3.75	-110	22.36
			BPSK	1@0	15	-110	22.38
			BPSK	1@47	3.75	-110	22.37
			QPSK	1@0	3.75	-110	22.85
			QPSK	1@0	15	-110	22.86
			QPSK	1@11	15	-110	22.83
26688	0	1914.8	QPSK	3@3	15	-110	23.17
			QPSK	12@0	15	-110	22.33
			BPSK	1@47	3.75	-110	21.87
			BPSK	1@47	15	-110	21.89
			QPSK	1@11	3.75	-110	21.9
			QPSK	1@11	15	-110	21.92
			QPSK	3@3	15	-110	22.03
			QPSK	12@0	15	-110	21.66

LTE Band 25							
In-Band	BW (MHz): 5						
N _{UL}	M _{UL}	Frequency of Uplink (MHz)	Test Configuration Initial of Power			EUT	
			Modulation	N _{tones}	Sub-carrier Spacing (kHz)	Cell Power (dBm/15 kHz)	Power (dBm)
26048	0	1850.8	BPSK	1@0	3.75	-110	21.55
			QPSK	1@0	15	-110	21.58
			QPSK	3@3	15	-110	21.83
			QPSK	12@0	15	-110	21.49
26356	0	1881.6	BPSK	1@0	3.75	-110	22.21
			BPSK	1@47	3.75	-110	22.21
			QPSK	1@0	15	-110	22.76
			QPSK	1@11	15	-110	22.69
			QPSK	3@3	15	-110	23.04
			QPSK	12@0	15	-110	22.20
26682	0	1914.2	BPSK	1@47	3.75	-110	21.71
			QPSK	1@11	15	-110	21.81
			QPSK	3@3	15	-110	21.88
			QPSK	12@0	15	-110	21.56

LTE Band 25							
In-Band	BW (MHz): 10	NB-IoT PRB: 30					
N _{UL}	M _{UL}	Frequency of Uplink (MHz)	Test Configuration Initial of Power			EUT	
			Modulation	N _{tones}	Sub-carrier Spacing (kHz)	Cell Power (dBm/15 kHz)	Power (dBm)
26101	-2	1856.09	BPSK	1@0	3.75	-110	21.51
			QPSK	1@0	15	-110	21.57
			QPSK	3@3	15	-110	21.85
			QPSK	12@0	15	-110	21.47
26375	-2	1883.49	BPSK	1@0	3.75	-110	22.20
			BPSK	1@47	3.75	-110	22.27
			QPSK	1@0	15	-110	22.76
			QPSK	1@11	15	-110	22.72
			QPSK	3@3	15	-110	23.04
			QPSK	12@0	15	-110	22.18
26649	-2	1910.89	BPSK	1@47	3.75	-110	21.76
			QPSK	1@11	15	-110	21.77
			QPSK	3@3	15	-110	21.90
			QPSK	12@0	15	-110	21.50

LTE Band 25							
In-Band	BW (MHz): 10	NB-IoT PRB: 35	Test Configuration Initial of Power			EUT	
N _{UL}	M _{UL}	Frequency of Uplink (MHz)	Modulation	N _{tones}	Sub-carrier Spacing (kHz)	Cell Power (dBm/15 kHz)	Power (dBm)
26110	-2	1856.99	BPSK	1@0	3.75	-110	21.52
			QPSK	1@0	15	-110	21.62
			QPSK	3@3	15	-110	21.87
			QPSK	12@0	15	-110	21.48
26384	-2	1884.39	BPSK	1@0	3.75	-110	22.27
			BPSK	1@47	3.75	-110	22.27
			QPSK	1@0	15	-110	22.71
			QPSK	1@11	15	-110	22.73
			QPSK	3@3	15	-110	23.08
			QPSK	12@0	15	-110	22.20
26658	-2	1911.79	BPSK	1@47	3.75	-110	21.72
			QPSK	1@11	15	-110	21.83
			QPSK	3@3	15	-110	21.88
			QPSK	12@0	15	-110	21.56

LTE Band 25							
Guard-Band	BW (MHz): 5	Test Configuration Initial of Power			EUT		
N _{UL}	M _{UL}	Frequency of Uplink (MHz)	Modulation	N _{tones}	Sub-carrier Spacing (kHz)	Cell Power (dBm/15 kHz)	Power (dBm)
26042	0	1850.2	BPSK	1@0	3.75	-110	21.55
			QPSK	1@0	15	-110	21.61
			QPSK	3@3	15	-110	21.80
			QPSK	12@0	15	-110	21.46
26341	0	1880.1	BPSK	1@0	3.75	-110	22.21
			BPSK	1@47	3.75	-110	22.22
			QPSK	1@0	15	-110	22.71
			QPSK	1@11	15	-110	22.70
			QPSK	3@3	15	-110	23.07
			QPSK	12@0	15	-110	22.20
26688	0	1914.8	BPSK	1@47	3.75	-110	21.75
			QPSK	1@11	15	-110	21.78
			QPSK	3@3	15	-110	21.88
			QPSK	12@0	15	-110	21.54

EIRP Power (dBm)

Cat-M1

LTE Band 2							
Channel Bandwidth: 1.4 MHz / QPSK							
Plane	Channel	Frequency (MHz)	Reading (dBm)	Correction Factor (dB)	EIRP (dBm)	EIRP (mW)	Polarization (H/V)
Z	18607	1850.7	-19.33	36.57	17.24	52.97	H
	18900	1880.0	-19.83	37.22	17.39	54.83	
	19193	1909.3	-20.14	37.18	17.04	50.58	
	18607	1850.7	-12.99	37.65	24.66	292.42	V
	18900	1880.0	-12.80	37.58	24.78	300.61	
	19193	1909.3	-12.88	37.48	24.60	288.40	
Channel Bandwidth: 1.4 MHz / 16QAM							
Z	18607	1850.7	-20.56	36.57	16.01	39.90	H
	18900	1880.0	-21.06	37.22	16.16	41.30	
	19193	1909.3	-21.37	37.18	15.81	38.11	
	18607	1850.7	-14.22	37.65	23.43	220.29	V
	18900	1880.0	-14.03	37.58	23.55	226.46	
	19193	1909.3	-14.11	37.48	23.37	217.27	

Note: EIRP (dBm) = Reading (dBm) + Correction Factor (dB)

LTE Band 2							
Channel Bandwidth: 3 MHz / QPSK							
Plane	Channel	Frequency (MHz)	Reading (dBm)	Correction Factor (dB)	EIRP (dBm)	EIRP (mW)	Polarization (H/V)
Z	18615	1851.5	-19.09	36.57	17.48	55.98	H
	18900	1880.0	-19.59	37.22	17.63	57.94	
	19185	1908.5	-19.90	37.18	17.28	53.46	
	18615	1851.5	-12.75	37.65	24.90	309.03	V
	18900	1880.0	-12.56	37.58	25.02	317.69	
	19185	1908.5	-12.64	37.48	24.84	304.79	
Channel Bandwidth: 3 MHz / 16QAM							
Z	18615	1851.5	-20.28	36.57	16.29	42.56	H
	18900	1880.0	-20.78	37.22	16.44	44.06	
	19185	1908.5	-21.09	37.18	16.09	40.64	
	18615	1851.5	-13.94	37.65	23.71	234.96	V
	18900	1880.0	-13.75	37.58	23.83	241.55	
	19185	1908.5	-13.83	37.48	23.65	231.74	

Note: EIRP (dBm) = Reading (dBm) + Correction Factor (dB)

LTE Band 2							
Channel Bandwidth: 5 MHz / QPSK							
Plane	Channel	Frequency (MHz)	Reading (dBm)	Correction Factor (dB)	EIRP (dBm)	EIRP (mW)	Polarization (H/V)
Z	18625	1852.5	-18.83	36.57	17.74	59.43	H
	18900	1880.0	-19.33	37.22	17.89	61.52	
	19175	1907.5	-19.64	37.18	17.54	56.75	
	18625	1852.5	-12.49	37.65	25.16	328.10	V
	18900	1880.0	-12.30	37.58	25.28	337.29	
	19175	1907.5	-12.38	37.48	25.10	323.59	
Channel Bandwidth: 5 MHz / 16QAM							
Z	18625	1852.5	-19.97	36.57	16.60	45.71	H
	18900	1880.0	-20.47	37.22	16.75	47.32	
	19175	1907.5	-20.78	37.18	16.40	43.65	
	18625	1852.5	-13.63	37.65	24.02	252.35	V
	18900	1880.0	-13.44	37.58	24.14	259.42	
	19175	1907.5	-13.52	37.48	23.96	248.89	

Note: EIRP (dBm) = Reading (dBm) + Correction Factor (dB)

LTE Band 2							
Channel Bandwidth: 10 MHz / QPSK							
Plane	Channel	Frequency (MHz)	Reading (dBm)	Correction Factor (dB)	EIRP (dBm)	EIRP (mW)	Polarization (H/V)
Z	18650	1855.0	-18.59	36.57	17.98	62.81	H
	18900	1880.0	-19.09	37.22	18.13	65.01	
	19150	1905.0	-19.40	37.18	17.78	59.98	
	18650	1855.0	-12.25	37.65	25.40	346.74	V
	18900	1880.0	-12.06	37.58	25.52	356.45	
	19150	1905.0	-12.14	37.48	25.34	341.98	
Channel Bandwidth: 10 MHz / 16QAM							
Z	18650	1855.0	-19.69	36.57	16.88	48.75	H
	18900	1880.0	-20.19	37.22	17.03	50.47	
	19150	1905.0	-20.50	37.18	16.68	46.56	
	18650	1855.0	-13.35	37.65	24.30	269.15	V
	18900	1880.0	-13.16	37.58	24.42	276.69	
	19150	1905.0	-13.24	37.48	24.24	265.46	

Note: EIRP (dBm) = Reading (dBm) + Correction Factor (dB)

LTE Band 2							
Channel Bandwidth: 15 MHz / QPSK							
Plane	Channel	Frequency (MHz)	Reading (dBm)	Correction Factor (dB)	EIRP (dBm)	EIRP (mW)	Polarization (H/V)
Z	18675	1857.5	-18.33	36.57	18.24	66.68	H
	18900	1880.0	-18.83	37.22	18.39	69.02	
	19125	1902.5	-19.14	37.18	18.04	63.68	
	18675	1857.5	-11.99	37.65	25.66	368.13	V
	18900	1880.0	-11.80	37.58	25.78	378.44	
	19125	1902.5	-11.88	37.48	25.60	363.08	
Channel Bandwidth: 15 MHz / 16QAM							
Z	18675	1857.5	-19.40	36.57	17.17	52.12	H
	18900	1880.0	-19.90	37.22	17.32	53.95	
	19125	1902.5	-20.21	37.18	16.97	49.77	
	18675	1857.5	-13.06	37.65	24.59	287.74	V
	18900	1880.0	-12.87	37.58	24.71	295.80	
	19125	1902.5	-12.95	37.48	24.53	283.79	

Note: EIRP (dBm) = Reading (dBm) + Correction Factor (dB)

LTE Band 2							
Channel Bandwidth: 20 MHz / QPSK							
Plane	Channel	Frequency (MHz)	Reading (dBm)	Correction Factor (dB)	EIRP (dBm)	EIRP (mW)	Polarization (H/V)
Z	18700	1860.0	-18.08	36.57	18.49	70.63	H
	18900	1880.0	-18.58	37.22	18.64	73.11	
	19100	1900.0	-18.89	37.18	18.29	67.45	
	18700	1860.0	-11.74	37.65	25.91	389.94	V
	18900	1880.0	-11.55	37.58	26.03	400.87	
	19100	1900.0	-11.63	37.48	25.85	384.59	
Channel Bandwidth: 20 MHz / 16QAM							
Z	18700	1860.0	-19.09	36.57	17.48	55.98	H
	18900	1880.0	-19.59	37.22	17.63	57.94	
	19100	1900.0	-19.90	37.18	17.28	53.46	
	18700	1860.0	-12.75	37.65	24.90	309.03	V
	18900	1880.0	-12.56	37.58	25.02	317.69	
	19100	1900.0	-12.64	37.48	24.84	304.79	

Note: EIRP (dBm) = Reading (dBm) + Correction Factor (dB)

LTE Band 25							
Channel Bandwidth: 1.4 MHz / QPSK							
Plane	Channel	Frequency (MHz)	Reading (dBm)	Correction Factor (dB)	EIRP (dBm)	EIRP (mW)	Polarization (H/V)
Z	26047	1850.7	-20.09	36.57	16.48	44.46	H
	26365	1882.5	-20.31	37.22	16.91	49.09	
	26683	1914.3	-22.45	39.09	16.64	46.13	
	26047	1850.7	-12.89	37.65	24.76	299.23	V
	26365	1882.5	-12.71	37.58	24.87	306.90	
	26683	1914.3	-13.10	37.92	24.82	303.39	
Channel Bandwidth: 1.4 MHz / 16QAM							
Z	26047	1850.7	-21.15	36.57	15.42	34.83	H
	26365	1882.5	-21.37	37.22	15.85	38.46	
	26683	1914.3	-23.51	39.09	15.58	36.14	
	26047	1850.7	-13.95	37.65	23.70	234.42	V
	26365	1882.5	-13.77	37.58	23.81	240.44	
	26683	1914.3	-14.16	37.92	23.76	237.68	

Note: EIRP (dBm) = Reading (dBm) + Correction Factor (dB)

LTE Band 25							
Channel Bandwidth: 3 MHz / QPSK							
Plane	Channel	Frequency (MHz)	Reading (dBm)	Correction Factor (dB)	EIRP (dBm)	EIRP (mW)	Polarization (H/V)
Z	26055	1851.5	-19.86	36.57	16.71	46.88	H
	26365	1882.5	-20.08	37.22	17.14	51.76	
	26675	1913.5	-22.24	39.11	16.87	48.64	
	26055	1851.5	-12.66	37.65	24.99	315.50	V
	26365	1882.5	-12.48	37.58	25.10	323.59	
	26675	1913.5	-12.88	37.93	25.05	319.89	
Channel Bandwidth: 3 MHz / 16QAM							
Z	26055	1851.5	-20.89	36.57	15.68	36.98	H
	26365	1882.5	-21.11	37.22	16.11	40.83	
	26675	1913.5	-23.27	39.11	15.84	38.37	
	26055	1851.5	-13.69	37.65	23.96	248.89	V
	26365	1882.5	-13.51	37.58	24.07	255.27	
	26675	1913.5	-13.91	37.93	24.02	252.35	

Note: EIRP (dBm) = Reading (dBm) + Correction Factor (dB)

LTE Band 25							
Channel Bandwidth: 5 MHz / QPSK							
Plane	Channel	Frequency (MHz)	Reading (dBm)	Correction Factor (dB)	EIRP (dBm)	EIRP (mW)	Polarization (H/V)
Z	26065	1852.5	-19.62	36.57	16.95	49.55	H
	26365	1882.5	-19.84	37.22	17.38	54.70	
	26665	1912.5	-21.00	38.11	17.11	51.40	
	26065	1852.5	-12.42	37.65	25.23	333.43	V
	26365	1882.5	-12.24	37.58	25.34	341.98	
	26665	1912.5	-12.67	37.96	25.29	338.06	
Channel Bandwidth: 5 MHz / 16QAM							
Z	26065	1852.5	-20.63	36.57	15.94	39.26	H
	26365	1882.5	-20.85	37.22	16.37	43.35	
	26665	1912.5	-22.01	38.11	16.10	40.74	
	26065	1852.5	-13.43	37.65	24.22	264.24	V
	26365	1882.5	-13.25	37.58	24.33	271.02	
	26665	1912.5	-13.68	37.96	24.28	267.92	

Note: EIRP (dBm) = Reading (dBm) + Correction Factor (dB)

LTE Band 25							
Channel Bandwidth: 10 MHz / QPSK							
Plane	Channel	Frequency (MHz)	Reading (dBm)	Correction Factor (dB)	EIRP (dBm)	EIRP (mW)	Polarization (H/V)
Z	26090	1855.0	-19.37	36.57	17.20	52.48	H
	26365	1882.5	-19.59	37.22	17.63	57.94	
	26640	1910.0	-20.83	38.19	17.36	54.45	
	26090	1855.0	-12.17	37.65	25.48	353.18	V
	26365	1882.5	-11.99	37.58	25.59	362.24	
	26640	1910.0	-12.61	38.15	25.54	358.10	
Channel Bandwidth: 10 MHz / 16QAM							
Z	26090	1855.0	-20.36	36.57	16.21	41.78	H
	26365	1882.5	-20.58	37.22	16.64	46.13	
	26640	1910.0	-21.82	38.19	16.37	43.35	
	26090	1855.0	-13.16	37.65	24.49	281.19	V
	26365	1882.5	-12.98	37.58	24.60	288.40	
	26640	1910.0	-13.60	38.15	24.55	285.10	

Note: EIRP (dBm) = Reading (dBm) + Correction Factor (dB)

LTE Band 25							
Channel Bandwidth: 15 MHz / QPSK							
Plane	Channel	Frequency (MHz)	Reading (dBm)	Correction Factor (dB)	EIRP (dBm)	EIRP (mW)	Polarization (H/V)
Z	26115	1857.5	-19.11	36.57	17.46	55.72	H
	26365	1882.5	-19.33	37.22	17.89	61.52	
	26615	1907.5	-20.61	38.23	17.62	57.81	
	26115	1857.5	-11.91	37.65	25.74	374.97	V
	26365	1882.5	-11.73	37.58	25.85	384.59	
	26615	1907.5	-12.42	38.22	25.80	380.19	
Channel Bandwidth: 15 MHz / 16QAM							
Z	26115	1857.5	-20.11	36.57	16.46	44.26	H
	26365	1882.5	-20.33	37.22	16.89	48.87	
	26615	1907.5	-21.61	38.23	16.62	45.92	
	26115	1857.5	-12.91	37.65	24.74	297.85	V
	26365	1882.5	-12.73	37.58	24.85	305.49	
	26615	1907.5	-13.42	38.22	24.80	302.00	

Note: EIRP (dBm) = Reading (dBm) + Correction Factor (dB)

LTE Band 25							
Channel Bandwidth: 20 MHz / QPSK							
Plane	Channel	Frequency (MHz)	Reading (dBm)	Correction Factor (dB)	EIRP (dBm)	EIRP (mW)	Polarization (H/V)
Z	26140	1860.0	-18.88	36.57	17.69	58.75	H
	26365	1882.5	-19.10	37.22	18.12	64.86	
	26590	1905.0	-20.87	38.72	17.85	60.95	
	26140	1860.0	-11.68	37.65	25.97	395.37	V
	26365	1882.5	-11.50	37.58	26.08	405.51	
	26590	1905.0	-11.53	37.56	26.03	400.87	
Channel Bandwidth: 20 MHz / 16QAM							
Z	26140	1860.0	-19.85	36.57	16.72	46.99	H
	26365	1882.5	-20.07	37.22	17.15	51.88	
	26590	1905.0	-21.84	38.72	16.88	48.75	
	26140	1860.0	-12.65	37.65	25.00	316.23	V
	26365	1882.5	-12.47	37.58	25.11	324.34	
	26590	1905.0	-12.50	37.56	25.06	320.63	

Note: EIRP (dBm) = Reading (dBm) + Correction Factor (dB)

NB-IoT

LTE Band 2							
BPSK							
Plane	Channel	Frequency (MHz)	Reading (dBm)	Correction Factor (dB)	EIRP (dBm)	EIRP (mW)	Polarization (H/V)
X	18602	1850.2	-13.65	36.57	22.92	195.88	H
	18900	1880.0	-13.22	37.22	24.00	251.19	
	19198	1909.8	-14.37	37.18	22.81	190.99	
	18602	1850.2	-21.02	37.65	16.63	46.03	V
	18900	1880.0	-20.11	37.58	17.47	55.85	
	19198	1909.8	-20.98	37.48	16.50	44.67	
QPSK							
X	18602	1850.2	-12.66	36.57	23.91	246.04	H
	18900	1880.0	-12.23	37.22	24.99	315.50	
	19198	1909.8	-13.38	37.18	23.80	239.88	
	18602	1850.2	-20.03	37.65	17.62	57.81	V
	18900	1880.0	-19.12	37.58	18.46	70.15	
	19198	1909.8	-19.99	37.48	17.49	56.10	

Note: EIRP (dBm) = Reading (dBm) + Correction Factor (dB)

LTE Band 25							
BPSK							
Plane	Channel	Frequency (MHz)	Reading (dBm)	Correction Factor (dB)	EIRP (dBm)	EIRP (mW)	Polarization (H/V)
X	26042	1850.2	-12.98	36.57	23.59	228.56	H
	26365	1882.5	-12.94	37.22	24.28	267.92	
	26688	1914.8	-15.11	38.72	23.61	229.61	
	26042	1850.2	-20.23	37.65	17.42	55.21	V
	26365	1882.5	-19.74	37.58	17.84	60.81	
	26688	1914.8	-20.05	37.56	17.51	56.36	
QPSK							
X	26042	1850.2	-12.66	36.57	23.91	246.04	H
	26365	1882.5	-12.40	37.22	24.82	303.39	
	26688	1914.8	-14.74	38.72	23.98	250.03	
	26042	1850.2	-19.94	37.65	17.71	59.02	V
	26365	1882.5	-19.42	37.58	18.16	65.46	
	26688	1914.8	-19.71	37.56	17.85	60.95	

Note: EIRP (dBm) = Reading (dBm) + Correction Factor (dB)

4.2 Modulation Characteristics Measurement

4.2.1 Limits of Modulation Characteristics

N/A

4.2.2 Test Setup



4.2.3 Test Procedure

Connect the EUT to Communication Simulator via the antenna connector. The frequency band is set as EUT supported Modulation and Channels, the EUT output is matched with 50 ohm load, the waveform quality and constellation of the EUT was tested.

4.2.4 Test Results

Cat-M1

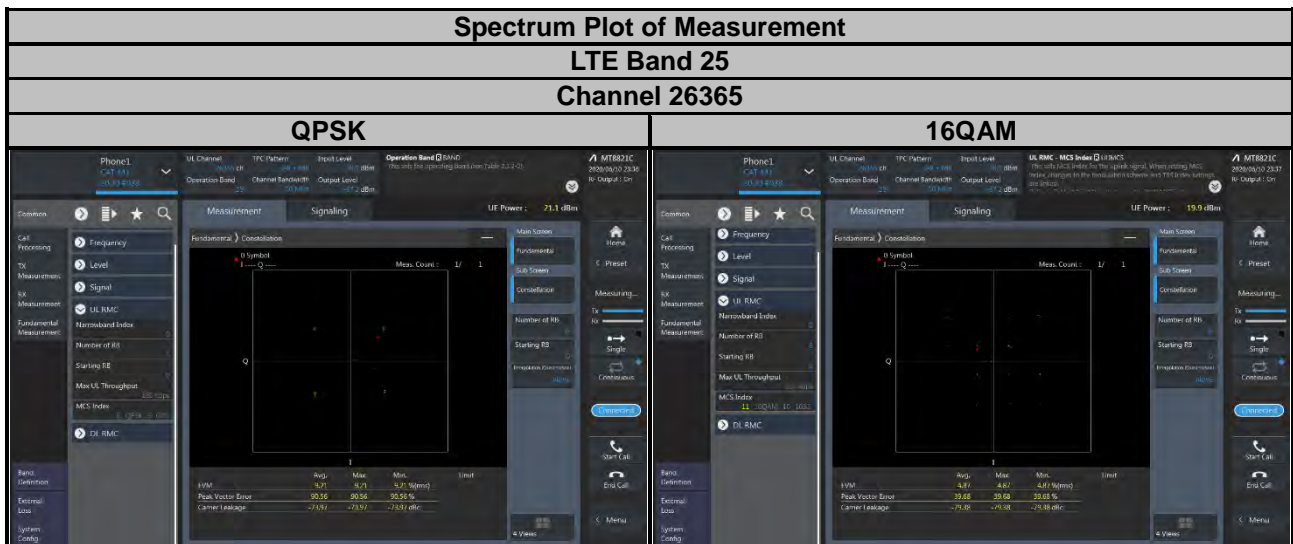
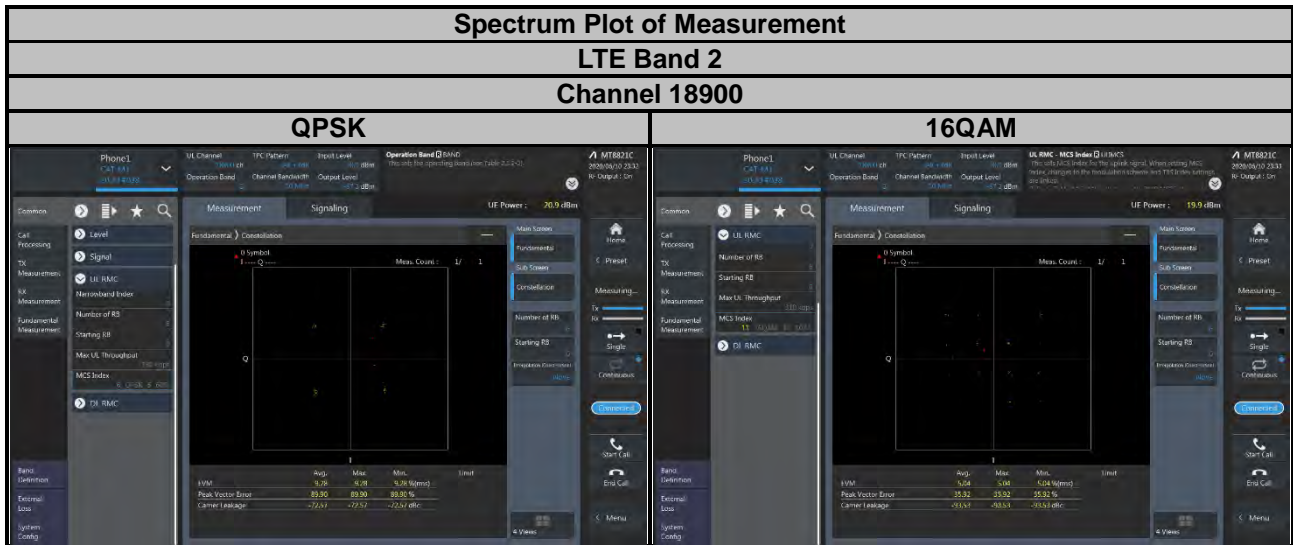

NB-IoT

Spectrum Plot of Measurement
LTE Band 2
Channel 18900

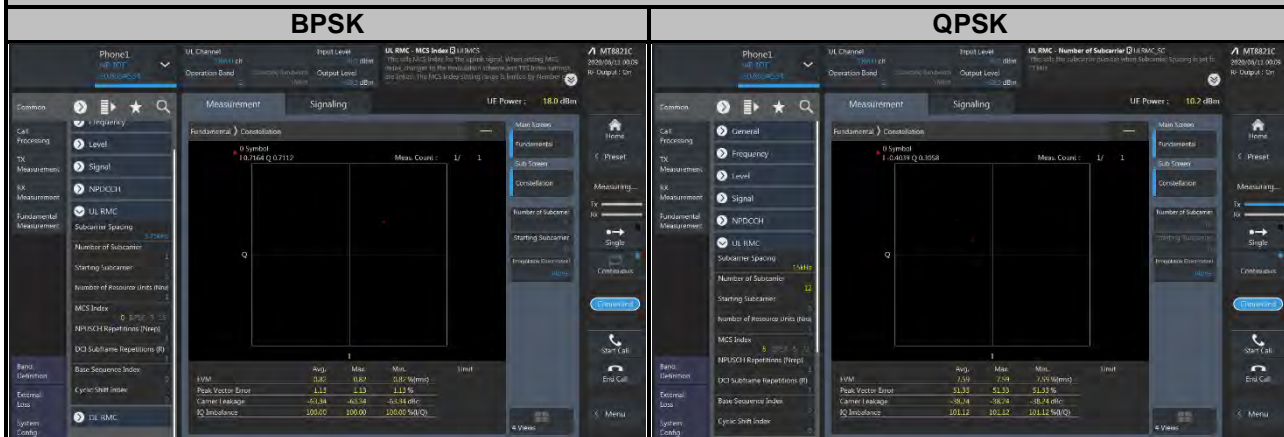

Spectrum Plot of Measurement
LTE Band 25
Channel 26365

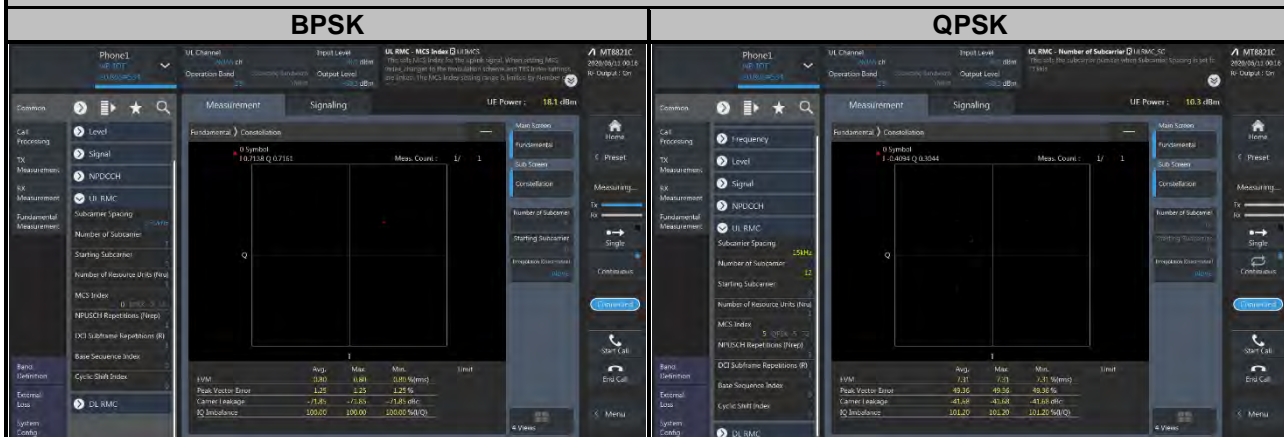

4.3 Frequency Stability Measurement

4.3.1 Limits of Frequency Stability Measurement

The frequency stability shall be sufficient to ensure that the fundamental emission stays within the authorized frequency block.

4.3.2 Test Procedure

- a. Device is placed at the oven room. The oven room could control the temperatures and humidity. Power warm up is at least 15 min and power applied should perform before recording frequency error.
- b. EUT is connected the external power supply to control the DC input power. The test voltage range is from minimum to maximum working voltage. Each step shall be record the frequency error rate.
- c. The temperature range step is 10 degrees in this test items. All temperature levels shall be hold the ± 0.5 °C during the measurement testing. The each temperature step shall be at least 0.5 hours, consider the EUT could be test under the stability condition.

NOTE: The frequency error was recorded frequency error from the communication simulator.

4.3.3 Test Setup

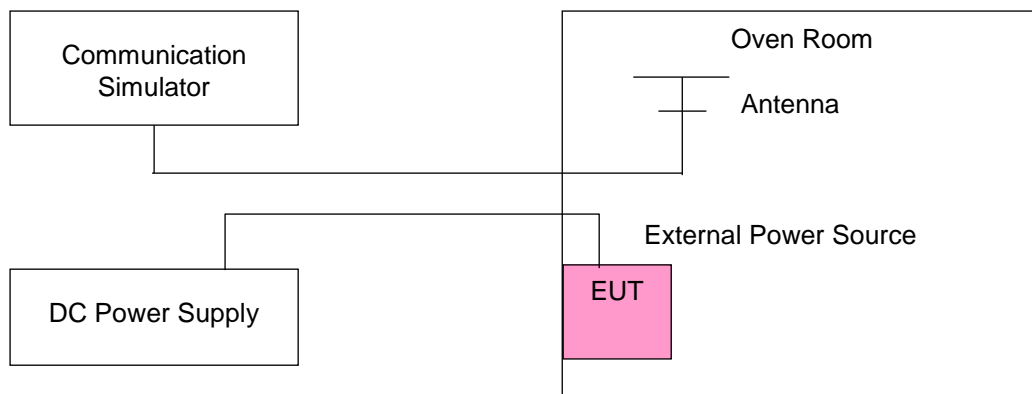

4.3.4 Test Results

Cat-M1

Frequency Error vs. Voltage

Voltage (Volts)	LTE Band 2			
	Channel Bandwidth: 1.4 MHz			
	Low Channel		High Channel	
	Frequency (MHz)	Frequency Error (ppm)	Frequency (MHz)	Frequency Error (ppm)
10.2	1850.700003	0.002	1909.300000	0.001
12	1850.700004	0.002	1909.300001	0.001
13.8	1850.700002	0.001	1909.300002	0.001

Note: The fixture defined the normal working voltage of the adapter is from 10.2 Vdc to 13.8 Vdc.

Frequency Error vs. Temperature

Temp. (°C)	LTE Band 2			
	Channel Bandwidth: 1.4 MHz			
	Low Channel		High Channel	
	Frequency (MHz)	Frequency Error (ppm)	Frequency (MHz)	Frequency Error (ppm)
-30	1850.700004	0.002	1909.300002	0.001
-20	1850.700004	0.002	1909.300003	0.002
-10	1850.700002	0.001	1909.300004	0.002
0	1850.700002	0.001	1909.300002	0.001
10	1850.700002	0.001	1909.300003	0.002
20	1850.699998	-0.001	1909.299998	-0.001
30	1850.699997	-0.002	1909.299996	-0.002
40	1850.699998	-0.001	1909.299997	-0.002
50	1850.699998	-0.001	1909.299997	-0.001
60	1850.699998	-0.001	1909.299998	-0.001
70	1850.699997	-0.002	1909.299998	-0.001
80	1850.699997	-0.002	1909.299997	-0.002
85	1850.699997	-0.001	1909.299997	-0.002

Frequency Error vs. Voltage

Voltage (Volts)	LTE Band 2			
	Channel Bandwidth: 3 MHz			
	Low Channel		High Channel	
	Frequency (MHz)	Frequency Error (ppm)	Frequency (MHz)	Frequency Error (ppm)
10.2	1851.500002	0.001	1907.500002	0.001
12	1851.500002	0.001	1907.500002	0.001
13.8	1851.500004	0.002	1907.500001	0.001

Note: The fixture defined the normal working voltage of the adapter is from 10.2 Vdc to 13.8 Vdc.

Frequency Error vs. Temperature

Temp. (°C)	LTE Band 2			
	Channel Bandwidth: 3 MHz			
	Low Channel		High Channel	
	Frequency (MHz)	Frequency Error (ppm)	Frequency (MHz)	Frequency Error (ppm)
-30	1851.500001	0.001	1907.500004	0.002
-20	1851.500001	0.001	1907.500002	0.001
-10	1851.500001	0.001	1907.500003	0.001
0	1851.500001	0.001	1907.500004	0.002
10	1851.500001	0.001	1907.500001	0.001
20	1851.499996	-0.002	1907.499999	-0.001
30	1851.499997	-0.002	1907.499997	-0.001
40	1851.499996	-0.002	1907.499997	-0.001
50	1851.499998	-0.001	1907.499998	-0.001
60	1851.499998	-0.001	1907.499999	-0.001
70	1851.499996	-0.002	1907.499999	-0.001
50	1851.499996	-0.002	1907.499997	-0.002
85	1851.499998	-0.001	1907.499998	-0.001

Frequency Error vs. Voltage

Voltage (Volts)	LTE Band 2			
	Channel Bandwidth: 5 MHz			
	Low Channel		High Channel	
	Frequency (MHz)	Frequency Error (ppm)	Frequency (MHz)	Frequency Error (ppm)
10.2	1852.500002	0.001	1907.500004	0.002
12	1852.500004	0.002	1907.500004	0.002
13.8	1852.500001	0.001	1907.500003	0.001

Note: The fixture defined the normal working voltage of the adapter is from 10.2 Vdc to 13.8 Vdc.

Frequency Error vs. Temperature

Temp. (°C)	LTE Band 2			
	Channel Bandwidth: 5 MHz			
	Low Channel		High Channel	
	Frequency (MHz)	Frequency Error (ppm)	Frequency (MHz)	Frequency Error (ppm)
-30	1852.500002	0.001	1907.500003	0.001
-20	1852.500003	0.002	1907.500003	0.001
-10	1852.500001	0.001	1907.500002	0.001
0	1852.500004	0.002	1907.500002	0.001
10	1852.500003	0.002	1907.500003	0.002
20	1852.499998	-0.001	1907.499997	-0.001
30	1852.499999	-0.001	1907.499999	-0.001
40	1852.499999	-0.001	1907.499999	-0.001
50	1852.499996	-0.002	1907.499997	-0.002
60	1852.499997	-0.002	1907.499999	-0.001
70	1852.499996	-0.002	1907.499998	-0.001
50	1852.499998	-0.001	1907.499996	-0.002
85	1852.499996	-0.002	1907.499999	-0.001

Frequency Error vs. Voltage

Voltage (Volts)	LTE Band 2			
	Channel Bandwidth: 10 MHz			
	Low Channel		High Channel	
	Frequency (MHz)	Frequency Error (ppm)	Frequency (MHz)	Frequency Error (ppm)
10.2	1855.000002	0.001	1905.000003	0.002
12	1855.000001	0.001	1905.000003	0.001
13.8	1855.000002	0.001	1905.000003	0.002

Note: The fixture defined the normal working voltage of the adapter is from 10.2 Vdc to 13.8 Vdc.

Frequency Error vs. Temperature

Temp. (°C)	LTE Band 2			
	Channel Bandwidth: 10 MHz			
	Low Channel		High Channel	
	Frequency (MHz)	Frequency Error (ppm)	Frequency (MHz)	Frequency Error (ppm)
-30	1855.000001	0.001	1905.000003	0.001
-20	1855.000004	0.002	1905.000003	0.002
-10	1855.000004	0.002	1905.000004	0.002
0	1855.000003	0.002	1905.000002	0.001
10	1855.000003	0.001	1905.000003	0.001
20	1854.999997	-0.002	1904.999998	-0.001
30	1854.999996	-0.002	1904.999998	-0.001
40	1854.999997	-0.002	1904.999997	-0.002
50	1854.999999	-0.001	1904.999996	-0.002
60	1854.999997	-0.002	1904.999998	-0.001
70	1854.999998	-0.001	1904.999999	-0.001
50	1854.999996	-0.002	1904.999997	-0.001
85	1854.999997	-0.002	1904.999996	-0.002

Frequency Error vs. Voltage

Voltage (Volts)	LTE Band 2			
	Channel Bandwidth: 15 MHz			
	Low Channel		High Channel	
	Frequency (MHz)	Frequency Error (ppm)	Frequency (MHz)	Frequency Error (ppm)
10.2	1857.500002	0.001	1902.500003	0.001
12	1857.500002	0.001	1902.500002	0.001
13.8	1857.500003	0.002	1902.500002	0.001

Note: The fixture defined the normal working voltage of the adapter is from 10.2 Vdc to 13.8 Vdc.

Frequency Error vs. Temperature

Temp. (°C)	LTE Band 2			
	Channel Bandwidth: 15 MHz			
	Low Channel		High Channel	
	Frequency (MHz)	Frequency Error (ppm)	Frequency (MHz)	Frequency Error (ppm)
-30	1857.500003	0.002	1902.500002	0.001
-20	1857.500002	0.001	1902.500001	0.001
-10	1857.500003	0.002	1902.500002	0.001
0	1857.500001	0.001	1902.500003	0.002
10	1857.500003	0.001	1902.500001	0.001
20	1857.499997	-0.002	1902.499999	-0.001
30	1857.499999	-0.001	1902.499998	-0.001
40	1857.499997	-0.002	1902.499998	-0.001
50	1857.499998	-0.001	1902.499997	-0.002
60	1857.499997	-0.002	1902.499999	-0.001
70	1857.499996	-0.002	1902.499998	-0.001
50	1857.499999	-0.001	1902.499998	-0.001
85	1857.499998	-0.001	1902.499998	-0.001

Frequency Error vs. Voltage

Voltage (Volts)	LTE Band 2			
	Channel Bandwidth: 20 MHz			
	Low Channel		High Channel	
	Frequency (MHz)	Frequency Error (ppm)	Frequency (MHz)	Frequency Error (ppm)
10.2	1860.000002	0.001	1900.000002	0.001
12	1860.000002	0.001	1900.000004	0.002
13.8	1860.000001	0.001	1900.000002	0.001

Note: The fixture defined the normal working voltage of the adapter is from 10.2 Vdc to 13.8 Vdc.

Frequency Error vs. Temperature

Temp. (°C)	LTE Band 2			
	Channel Bandwidth: 20 MHz			
	Low Channel		High Channel	
	Frequency (MHz)	Frequency Error (ppm)	Frequency (MHz)	Frequency Error (ppm)
-30	1860.000003	0.002	1900.000001	0.001
-20	1860.000004	0.002	1900.000003	0.001
-10	1860.000001	0.001	1900.000003	0.002
0	1860.000001	0.001	1900.000004	0.002
10	1860.000002	0.001	1900.000003	0.001
20	1859.999996	-0.002	1899.999999	-0.001
30	1859.999997	-0.001	1899.999997	-0.002
40	1859.999996	-0.002	1899.999996	-0.002
50	1859.999997	-0.002	1899.999999	-0.001
60	1859.999998	-0.001	1899.999997	-0.002
70	1859.999997	-0.001	1899.999999	-0.001
50	1859.999998	-0.001	1899.999997	-0.002
85	1859.999998	-0.001	1899.999998	-0.001

Frequency Error vs. Voltage

Voltage (Volts)	LTE Band 25			
	Channel Bandwidth: 1.4 MHz			
	Low Channel		High Channel	
	Frequency (MHz)	Frequency Error (ppm)	Frequency (MHz)	Frequency Error (ppm)
10.2	1850.700003	0.002	1914.300002	0.001
12	1850.700003	0.002	1914.300003	0.001
13.8	1850.700003	0.002	1914.300004	0.002

Note: The fixture defined the normal working voltage of the adapter is from 10.2 Vdc to 13.8 Vdc.

Frequency Error vs. Temperature

Temp. (°C)	LTE Band 25			
	Channel Bandwidth: 1.4 MHz			
	Low Channel		High Channel	
	Frequency (MHz)	Frequency Error (ppm)	Frequency (MHz)	Frequency Error (ppm)
-30	1850.700002	0.001	1914.300002	0.001
-20	1850.700004	0.002	1914.300001	0.001
-10	1850.700002	0.001	1914.300003	0.002
0	1850.700004	0.002	1914.300002	0.001
10	1850.700003	0.001	1914.300003	0.002
20	1850.699996	-0.002	1914.299998	-0.001
30	1850.699998	-0.001	1914.299999	-0.001
40	1850.699997	-0.002	1914.299998	-0.001
50	1850.699997	-0.002	1914.299997	-0.002
60	1850.699997	-0.002	1914.299998	-0.001
70	1850.699998	-0.001	1914.299997	-0.002
80	1850.699998	-0.001	1914.299999	-0.001
85	1850.699999	-0.001	1914.299996	-0.002

Frequency Error vs. Voltage

Voltage (Volts)	LTE Band 25			
	Channel Bandwidth: 3 MHz			
	Low Channel		High Channel	
	Frequency (MHz)	Frequency Error (ppm)	Frequency (MHz)	Frequency Error (ppm)
10.2	1851.500004	0.002	1913.500004	0.002
12	1851.500003	0.002	1913.500002	0.001
13.8	1851.500003	0.002	1913.500004	0.002

Note: The fixture defined the normal working voltage of the adapter is from 10.2 Vdc to 13.8 Vdc.

Frequency Error vs. Temperature

Temp. (°C)	LTE Band 25			
	Channel Bandwidth: 3 MHz			
	Low Channel		High Channel	
	Frequency (MHz)	Frequency Error (ppm)	Frequency (MHz)	Frequency Error (ppm)
-30	1851.500002	0.001	1913.500004	0.002
-20	1851.500003	0.001	1913.500001	0.001
-10	1851.500002	0.001	1913.500003	0.002
0	1851.500004	0.002	1913.500001	0.001
10	1851.500001	0.001	1913.500003	0.002
20	1851.499999	-0.001	1913.499998	-0.001
30	1851.499997	-0.002	1913.499998	-0.001
40	1851.499997	-0.001	1913.499997	-0.002
50	1851.499997	-0.002	1913.499998	-0.001
60	1851.499997	-0.002	1913.499997	-0.002
70	1851.499999	-0.001	1913.499996	-0.002
50	1851.499996	-0.002	1913.499997	-0.002
85	1851.499997	-0.002	1913.499997	-0.002

Frequency Error vs. Voltage

Voltage (Volts)	LTE Band 25			
	Channel Bandwidth: 5 MHz			
	Low Channel		High Channel	
	Frequency (MHz)	Frequency Error (ppm)	Frequency (MHz)	Frequency Error (ppm)
10.2	1852.500002	0.001	1912.500002	0.001
12	1852.500004	0.002	1912.500001	0.001
13.8	1852.500001	0.001	1912.500001	0.001

Note: The fixture defined the normal working voltage of the adapter is from 10.2 Vdc to 13.8 Vdc.

Frequency Error vs. Temperature

Temp. (°C)	LTE Band 25			
	Channel Bandwidth: 5 MHz			
	Low Channel		High Channel	
	Frequency (MHz)	Frequency Error (ppm)	Frequency (MHz)	Frequency Error (ppm)
-30	1852.500003	0.002	1912.500004	0.002
-20	1852.500003	0.002	1912.500004	0.002
-10	1852.500002	0.001	1912.500003	0.001
0	1852.500002	0.001	1912.500002	0.001
10	1852.500002	0.001	1912.500002	0.001
20	1852.499997	-0.002	1912.499997	-0.001
30	1852.499999	-0.001	1912.499997	-0.002
40	1852.499997	-0.002	1912.499999	-0.001
50	1852.499998	-0.001	1912.499999	-0.001
60	1852.499996	-0.002	1912.499997	-0.002
70	1852.499997	-0.002	1912.499998	-0.001
50	1852.499996	-0.002	1912.499998	-0.001
85	1852.499997	-0.002	1912.499998	-0.001

Frequency Error vs. Voltage

Voltage (Volts)	LTE Band 25			
	Channel Bandwidth: 10 MHz			
	Low Channel		High Channel	
	Frequency (MHz)	Frequency Error (ppm)	Frequency (MHz)	Frequency Error (ppm)
10.2	1855.000003	0.002	1910.000003	0.002
12	1855.000002	0.001	1910.000003	0.002
13.8	1855.000002	0.001	1910.000002	0.001

Note: The fixture defined the normal working voltage of the adapter is from 10.2 Vdc to 13.8 Vdc.

Frequency Error vs. Temperature

Temp. (°C)	LTE Band 25			
	Channel Bandwidth: 10 MHz			
	Low Channel		High Channel	
	Frequency (MHz)	Frequency Error (ppm)	Frequency (MHz)	Frequency Error (ppm)
-30	1855.000003	0.001	1910.000001	0.001
-20	1855.000003	0.001	1910.000002	0.001
-10	1855.000003	0.002	1910.000002	0.001
0	1855.000003	0.002	1910.000002	0.001
10	1855.000004	0.002	1910.000003	0.002
20	1854.999999	-0.001	1909.999998	-0.001
30	1854.999998	-0.001	1909.999998	-0.001
40	1854.999998	-0.001	1909.999999	-0.001
50	1854.999999	-0.001	1909.999999	-0.001
60	1854.999999	-0.001	1909.999997	-0.002
70	1854.999999	-0.001	1909.999997	-0.001
50	1854.999998	-0.001	1909.999997	-0.002
85	1854.999999	-0.001	1909.999998	-0.001

Frequency Error vs. Voltage

Voltage (Volts)	LTE Band 25			
	Channel Bandwidth: 15 MHz			
	Low Channel		High Channel	
	Frequency (MHz)	Frequency Error (ppm)	Frequency (MHz)	Frequency Error (ppm)
10.2	1857.500003	0.002	1907.500001	0.001
12	1857.500004	0.002	1907.500001	0.001
13.8	1857.500003	0.001	1907.500001	0.001

Note: The fixture defined the normal working voltage of the adapter is from 10.2 Vdc to 13.8 Vdc.

Frequency Error vs. Temperature

Temp. (°C)	LTE Band 25			
	Channel Bandwidth: 15 MHz			
	Low Channel		High Channel	
	Frequency (MHz)	Frequency Error (ppm)	Frequency (MHz)	Frequency Error (ppm)
-30	1857.500004	0.002	1907.500003	0.001
-20	1857.500002	0.001	1907.500004	0.002
-10	1857.500002	0.001	1907.500004	0.002
0	1857.500003	0.001	1907.500001	0.001
10	1857.500003	0.002	1907.500003	0.001
20	1857.499997	-0.001	1907.499996	-0.002
30	1857.499996	-0.002	1907.499999	-0.001
40	1857.499999	-0.001	1907.499998	-0.001
50	1857.499999	-0.001	1907.499997	-0.002
60	1857.499999	-0.001	1907.499996	-0.002
70	1857.499997	-0.002	1907.499998	-0.001
50	1857.499996	-0.002	1907.499997	-0.001
85	1857.499997	-0.002	1907.499998	-0.001

Frequency Error vs. Voltage

Voltage (Volts)	LTE Band 25			
	Channel Bandwidth: 20 MHz			
	Low Channel		High Channel	
	Frequency (MHz)	Frequency Error (ppm)	Frequency (MHz)	Frequency Error (ppm)
10.2	1860.000002	0.001	1905.000003	0.002
12	1860.000002	0.001	1905.000002	0.001
13.8	1860.000003	0.001	1905.000004	0.002

Note: The fixture defined the normal working voltage of the adapter is from 10.2 Vdc to 13.8 Vdc.

Frequency Error vs. Temperature

Temp. (°C)	LTE Band 25			
	Channel Bandwidth: 20 MHz			
	Low Channel		High Channel	
	Frequency (MHz)	Frequency Error (ppm)	Frequency (MHz)	Frequency Error (ppm)
-30	1860.000004	0.002	1905.000003	0.002
-20	1860.000002	0.001	1905.000003	0.002
-10	1860.000003	0.002	1905.000003	0.001
0	1860.000003	0.002	1905.000001	0.001
10	1860.000003	0.002	1905.000004	0.002
20	1859.999997	-0.002	1904.999998	-0.001
30	1859.999998	-0.001	1904.999998	-0.001
40	1859.999997	-0.002	1904.999999	-0.001
50	1859.999996	-0.002	1904.999998	-0.001
60	1859.999998	-0.001	1904.999997	-0.002
70	1859.999998	-0.001	1904.999998	-0.001
50	1859.999999	-0.001	1904.999999	-0.001
85	1859.999998	-0.001	1904.999998	-0.001

NB-IoT

Frequency Error vs. Voltage

Voltage (Volts)	LTE Band 2			
	Low Channel		High Channel	
	Frequency (MHz)	Frequency Error (ppm)	Frequency (MHz)	Frequency Error (ppm)
10.2	1850.200003	0.002	1909.800002	0.001
12	1850.200002	0.001	1909.800003	0.002
13.8	1850.200003	0.001	1909.800003	0.001

Note: The fixture defined the normal working voltage of the adapter is from 10.2 Vdc to 13.8 Vdc.

Frequency Error vs. Temperature

Temp. (°C)	LTE Band 2			
	Low Channel		High Channel	
	Frequency (MHz)	Frequency Error (ppm)	Frequency (MHz)	Frequency Error (ppm)
-30	1850.200002	0.001	1909.800004	0.002
-20	1850.200004	0.002	1909.800002	0.001
-10	1850.200002	0.001	1909.800003	0.001
0	1850.200003	0.002	1909.800003	0.002
10	1850.200004	0.002	1909.800003	0.002
20	1850.199998	-0.001	1909.799998	-0.001
30	1850.199999	-0.001	1909.799998	-0.001
40	1850.199998	-0.001	1909.799998	-0.001
50	1850.199998	-0.001	1909.799996	-0.002
60	1850.199997	-0.002	1909.799998	-0.001
70	1850.199999	-0.001	1909.799996	-0.002
80	1850.199996	-0.002	1909.799998	-0.001
85	1850.199996	-0.002	1909.799999	-0.001

Frequency Error vs. Voltage

Voltage (Volts)	LTE Band 25			
	Low Channel		High Channel	
	Frequency (MHz)	Frequency Error (ppm)	Frequency (MHz)	Frequency Error (ppm)
10.2	1850.200003	0.001	1914.800002	0.001
12	1850.200003	0.001	1914.800002	0.001
13.8	1850.200003	0.002	1914.800004	0.002

Note: The fixture defined the normal working voltage of the adapter is from 10.2 Vdc to 13.8 Vdc.

Frequency Error vs. Temperature

Temp. (°C)	LTE Band 25			
	Low Channel		High Channel	
	Frequency (MHz)	Frequency Error (ppm)	Frequency (MHz)	Frequency Error (ppm)
-30	1850.200002	0.001	1914.800004	0.002
-20	1850.200003	0.001	1914.800002	0.001
-10	1850.200003	0.001	1914.800003	0.001
0	1850.200002	0.001	1914.800002	0.001
10	1850.200003	0.001	1914.800003	0.002
20	1850.199998	-0.001	1914.799996	-0.002
30	1850.199998	-0.001	1914.799997	-0.002
40	1850.199999	-0.001	1914.799999	-0.001
50	1850.199997	-0.001	1914.799998	-0.001
60	1850.199997	-0.002	1914.799997	-0.002
70	1850.199997	-0.002	1914.799998	-0.001
80	1850.199997	-0.002	1914.799998	-0.001
85	1850.199996	-0.002	1914.799999	-0.001

4.4 Occupied Bandwidth Measurement

4.4.1 Test Procedure

The EUT makes a call to the communication simulator. All measurements were done at low, middle and high operational frequency range. The communication simulator station system controlled a EUT to export maximum output power under transmission mode and specific channel frequency. Use OBW measurement function of Spectrum analyzer to measure 99 % occupied bandwidth.

4.4.2 Test Setup

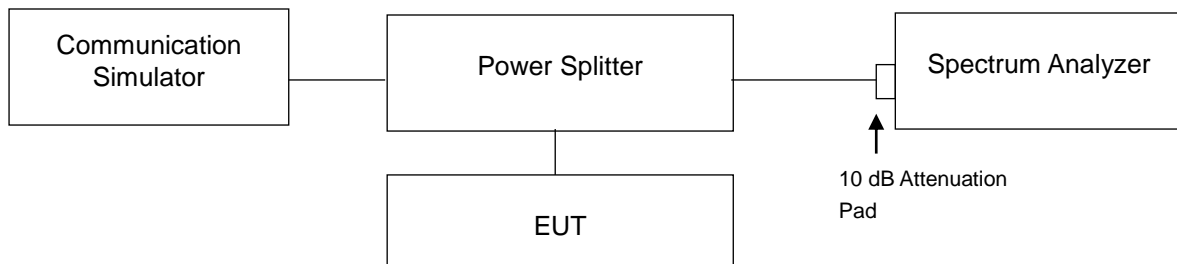

4.4.3 Test Result

Cat-M1

LTE Band 2					
Channel Bandwidth: 1.4 MHz					
Channel	Frequency (MHz)	99 % Occupied Bandwidth (MHz)		26 dB Bandwidth (MHz)	
		QPSK	16QAM	QPSK	16QAM
18607	1850.7	1.0900	1.0857	1.274	1.274
18900	1880.0	1.0875	1.0860	1.274	1.270
19193	1909.3	1.0912	1.0896	1.277	1.261
Channel Bandwidth: 3 MHz					
Channel	Frequency (MHz)	99 % Occupied Bandwidth (MHz)		26 dB Bandwidth (MHz)	
		QPSK	16QAM	QPSK	16QAM
18615	1851.5	1.0835	1.0768	1.266	1.269
18900	1880.0	1.0910	1.0792	1.279	1.275
19185	1908.5	1.0858	1.0773	1.261	1.260

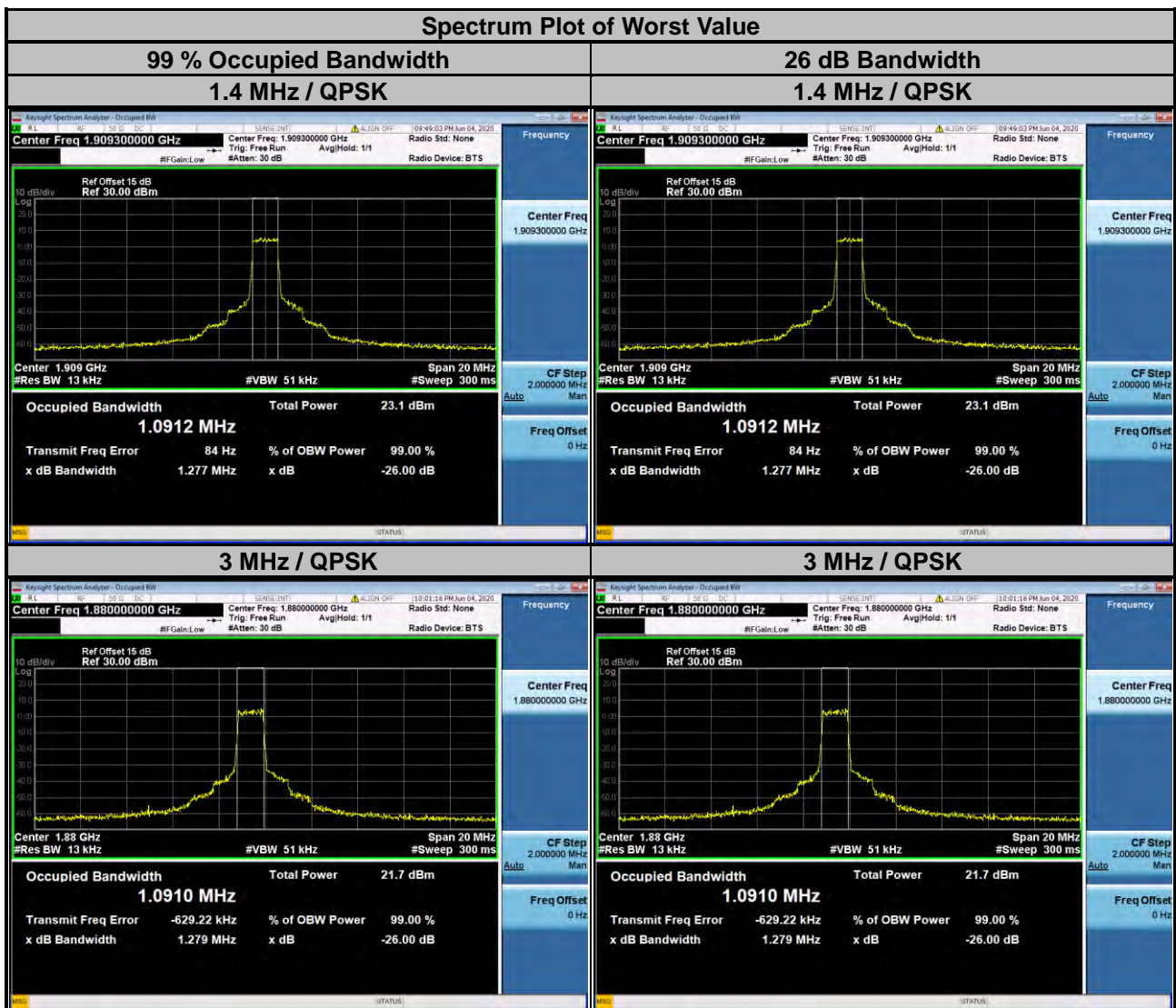

LTE Band 2

Channel Bandwidth: 5 MHz

Channel	Frequency (MHz)	99 % Occupied Bandwidth (MHz)		26 dB Bandwidth (MHz)	
		QPSK	16QAM	QPSK	16QAM
18625	1852.5	1.0855	1.0827	1.273	1.269
18900	1880.0	1.0769	1.0851	1.247	1.287
19175	1907.5	1.0778	1.0869	1.258	1.280

Channel Bandwidth: 10 MHz

Channel	Frequency (MHz)	99 % Occupied Bandwidth (MHz)		26 dB Bandwidth (MHz)	
		QPSK	16QAM	QPSK	16QAM
18650	1855.0	1.0846	1.0893	1.261	1.289
18900	1880.0	1.0910	1.0859	1.273	1.295
19150	1905.0	1.0902	1.0862	1.278	1.287

Spectrum Plot of Worst Value

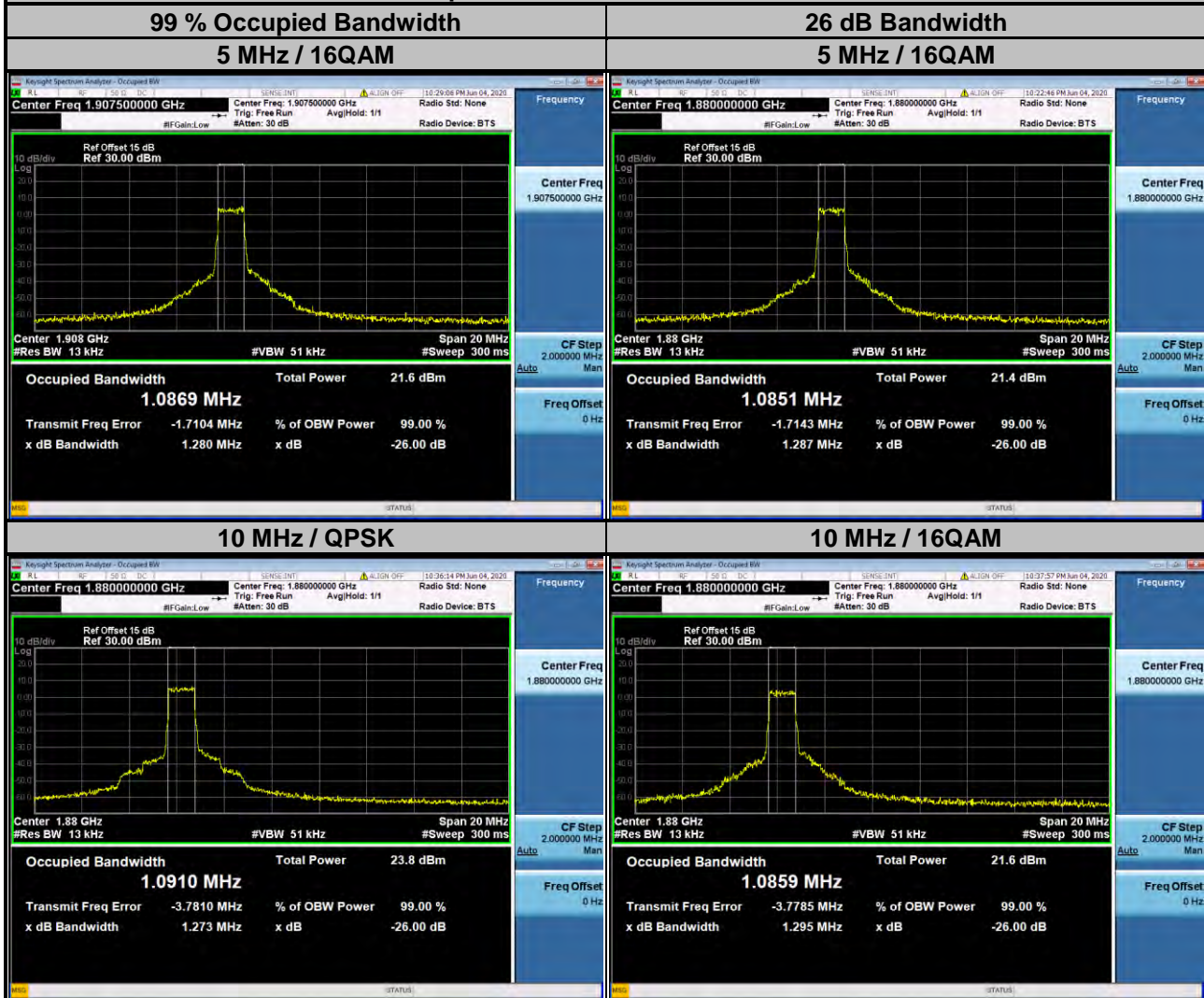

LTE Band 2

Channel Bandwidth: 15 MHz

Channel	Frequency (MHz)	99 % Occupied Bandwidth (MHz)		26 dB Bandwidth (MHz)	
		QPSK	16QAM	QPSK	16QAM
18675	1857.5	1.0862	1.0840	1.261	1.272
18900	1880.0	1.0938	1.0774	1.262	1.256
19125	1902.5	1.0945	1.0827	1.275	1.276

Channel Bandwidth: 20 MHz

Channel	Frequency (MHz)	99 % Occupied Bandwidth (MHz)		26 dB Bandwidth (MHz)	
		QPSK	16QAM	QPSK	16QAM
18700	1860.0	1.0851	1.0878	1.267	1.258
18900	1880.0	1.0924	1.0896	1.267	1.270
19100	1900.0	1.0904	1.0895	1.270	1.302

Spectrum Plot of Worst Value

99 % Occupied Bandwidth 15 MHz / QPSK



26 dB Bandwidth 15 MHz / 16QAM



20 MHz / QPSK



20 MHz / 16QAM



LTE Band 25					
Channel Bandwidth: 1.4 MHz					
Channel	Frequency (MHz)	99 % Occupied Bandwidth (MHz)		26 dB Bandwidth (MHz)	
		QPSK	16QAM	QPSK	16QAM
26047	1850.7	1.0898	1.0869	1.272	1.257
26365	1882.5	1.0925	1.0869	1.277	1.273
26683	1914.3	1.0888	1.0871	1.278	1.272

Channel Bandwidth: 3 MHz					
Channel	Frequency (MHz)	99 % Occupied Bandwidth (MHz)		26 dB Bandwidth (MHz)	
		QPSK	16QAM	QPSK	16QAM
26055	1851.5	1.0955	1.0791	1.278	1.271
26365	1882.5	1.0836	1.0767	1.273	1.265
26675	1913.5	1.0941	1.0778	1.273	1.273

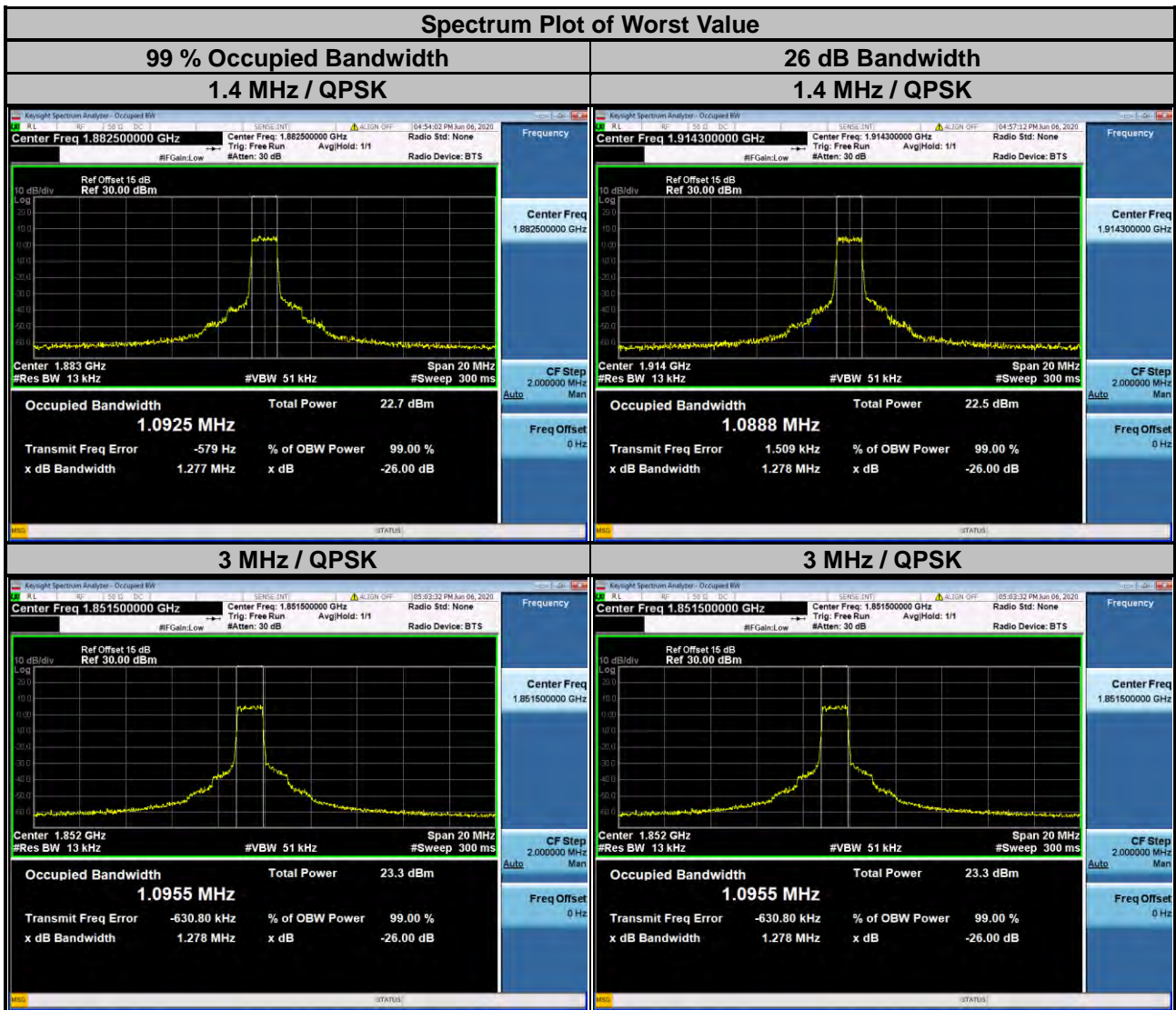

LTE Band 25					
Channel Bandwidth: 5 MHz					
Channel	Frequency (MHz)	99 % Occupied Bandwidth (MHz)		26 dB Bandwidth (MHz)	
		QPSK	16QAM	QPSK	16QAM
26065	1852.5	1.0888	1.0851	1.254	1.285
26365	1882.5	1.0782	1.0813	1.275	1.277
26665	1912.5	1.0804	1.0819	1.271	1.284

Channel Bandwidth: 10 MHz					
Channel	Frequency (MHz)	99 % Occupied Bandwidth (MHz)		26 dB Bandwidth (MHz)	
		QPSK	16QAM	QPSK	16QAM
26090	1855.0	1.0911	1.0893	1.264	1.277
26365	1882.5	1.0891	1.0884	1.273	1.292
26640	1910.0	1.0909	1.0891	1.263	1.281

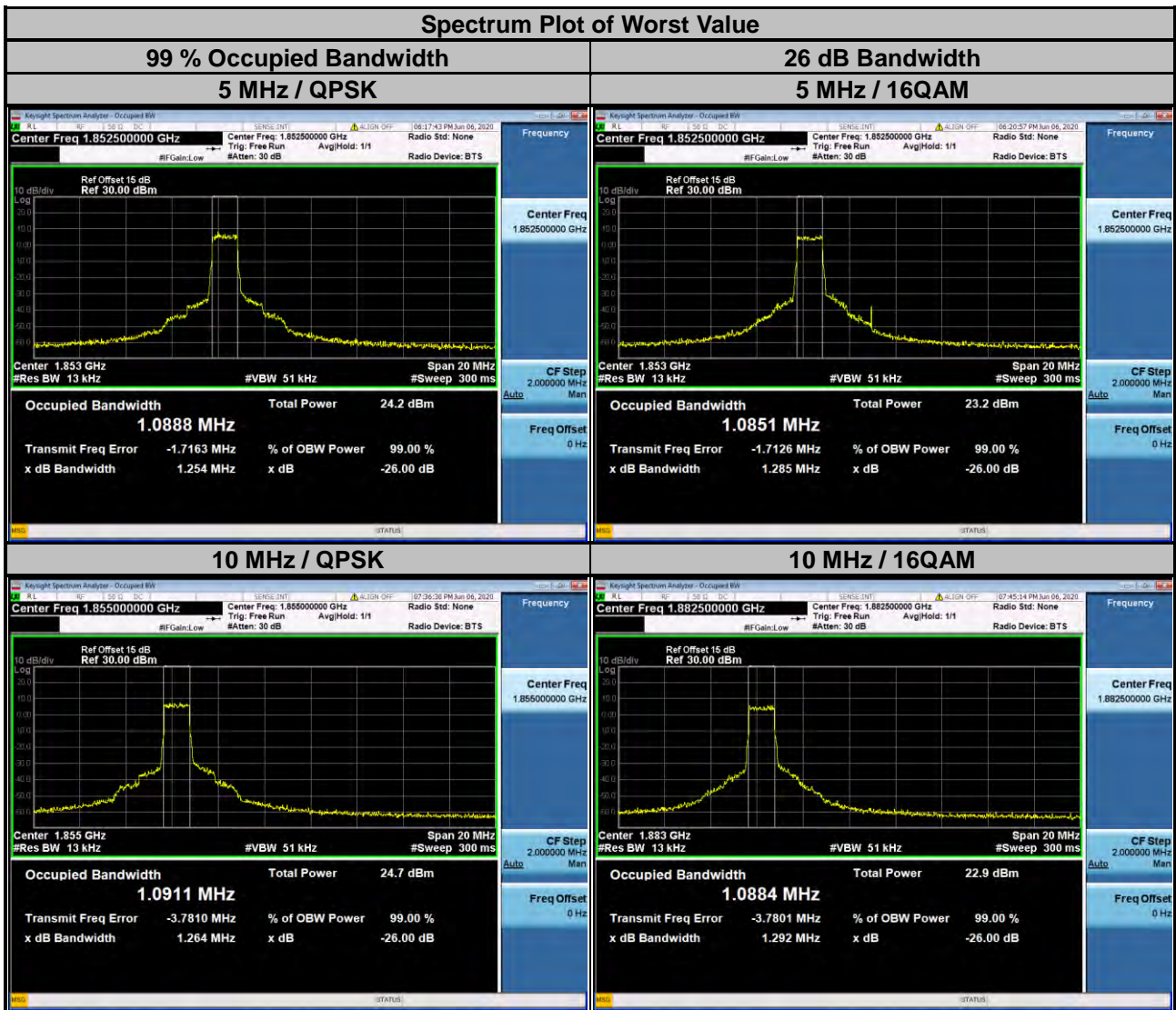

LTE Band 25

Channel Bandwidth: 15 MHz

Channel	Frequency (MHz)	99 % Occupied Bandwidth (MHz)		26 dB Bandwidth (MHz)	
		QPSK	16QAM	QPSK	16QAM
26115	1857.5	1.0846	1.0841	1.274	1.281
26365	1882.5	1.0913	1.0826	1.274	1.285
26615	1907.5	1.0875	1.0861	1.280	1.288

Channel Bandwidth: 20 MHz

Channel	Frequency (MHz)	99 % Occupied Bandwidth (MHz)		26 dB Bandwidth (MHz)	
		QPSK	16QAM	QPSK	16QAM
26140	1860.0	1.0910	1.0916	1.278	1.304
26365	1882.5	1.0887	1.0895	1.275	1.301
26590	1905.0	1.0917	1.0909	1.269	1.302

Spectrum Plot of Worst Value

99 % Occupied Bandwidth 15 MHz / QPSK



26 dB Bandwidth 15 MHz / 16QAM

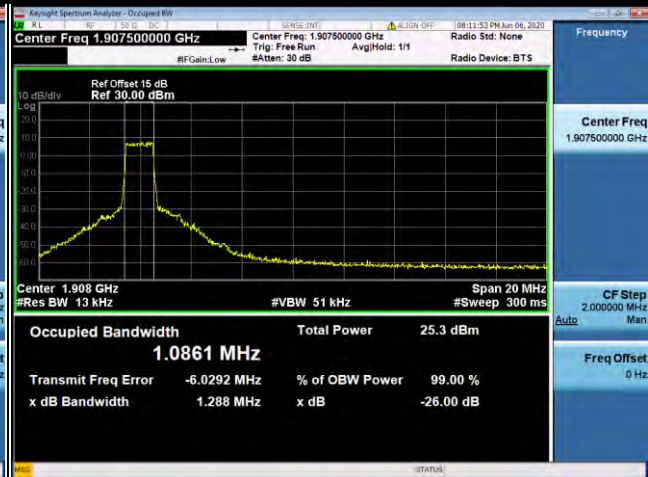

20 MHz / QPSK



20 MHz / 16QAM



NB-IoT

LTE Band 2						
Channel	Frequency (MHz)	Modulation	N _{tones}	Sub-carrier Spacing (kHz)	99 % Occupied Bandwidth (kHz)	26 dB Bandwidth (kHz)
18602	1850.2	BPSK	1@0	3.75	37.91	27.47
		BPSK	1@0	15	96.072	111.3
		QPSK	1@0	3.75	34.276	28.30
		QPSK	1@0	15	97.998	126.3
		QPSK	12@0	15	184.78	258.60
18900	1880	BPSK	1@0	3.75	59.83	39.60
		BPSK	1@0	15	99.900	123.7
		QPSK	1@0	3.75	62.197	46.51
		QPSK	1@0	15	103.59	139.2
		QPSK	12@0	15	192.10	275.60
19198	1909.8	BPSK	1@47	3.75	45.03	28.36
		BPSK	1@0	15	102.20	137.3
		QPSK	1@0	3.75	54.809	40.94
		QPSK	1@0	15	97.472	123.0
		QPSK	12@0	15	191.18	274.40

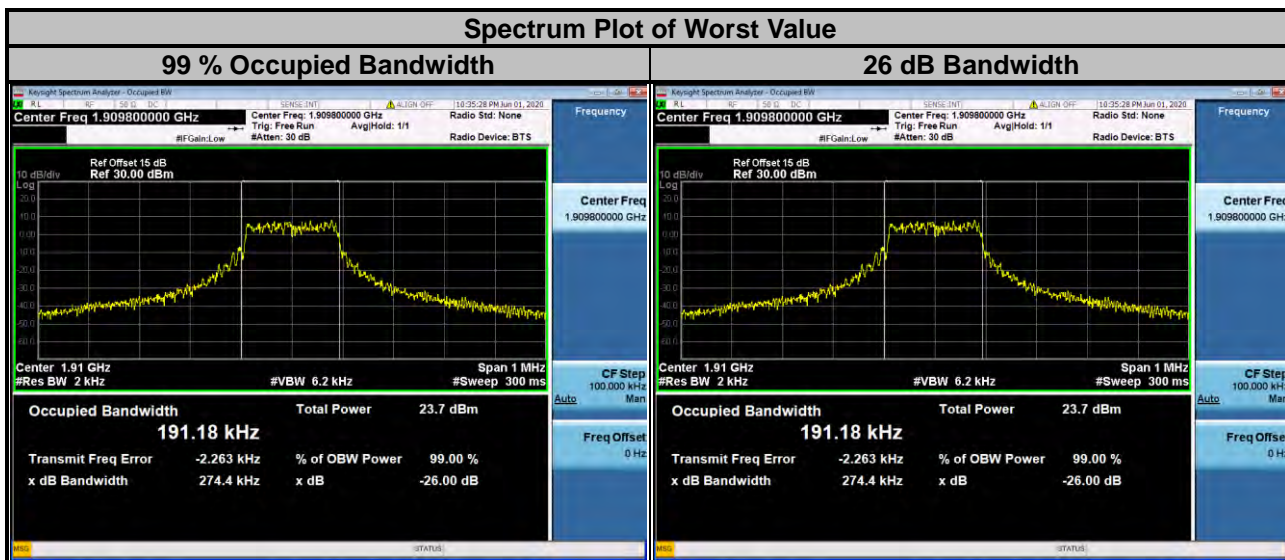

LTE Band 25						
Channel	Frequency (MHz)	Modulation	N _{tones}	Sub-carrier Spacing (kHz)	99 % Occupied Bandwidth (kHz)	26 dB Bandwidth (kHz)
26042	1850.2	BPSK	1@0	3.75	42.60	28.20
		BPSK	1@0	15	99.625	110.9
		QPSK	1@0	3.75	36.110	28.90
		QPSK	1@0	15	94.953	113.6
		QPSK	12@0	15	185.67	273.70
26365	1882.5	BPSK	1@0	3.75	59.99	38.63
		BPSK	1@0	15	107.16	123.2
		QPSK	1@0	3.75	53.523	41.23
		QPSK	1@0	15	99.728	112.1
		QPSK	12@0	15	193.51	266.70
26688	1914.8	BPSK	1@47	3.75	39.28	26.88
		BPSK	1@0	15	99.007	138.1
		QPSK	1@0	3.75	55.974	37.76
		QPSK	1@0	15	102.68	126.0
		QPSK	12@0	15	191.97	274.00

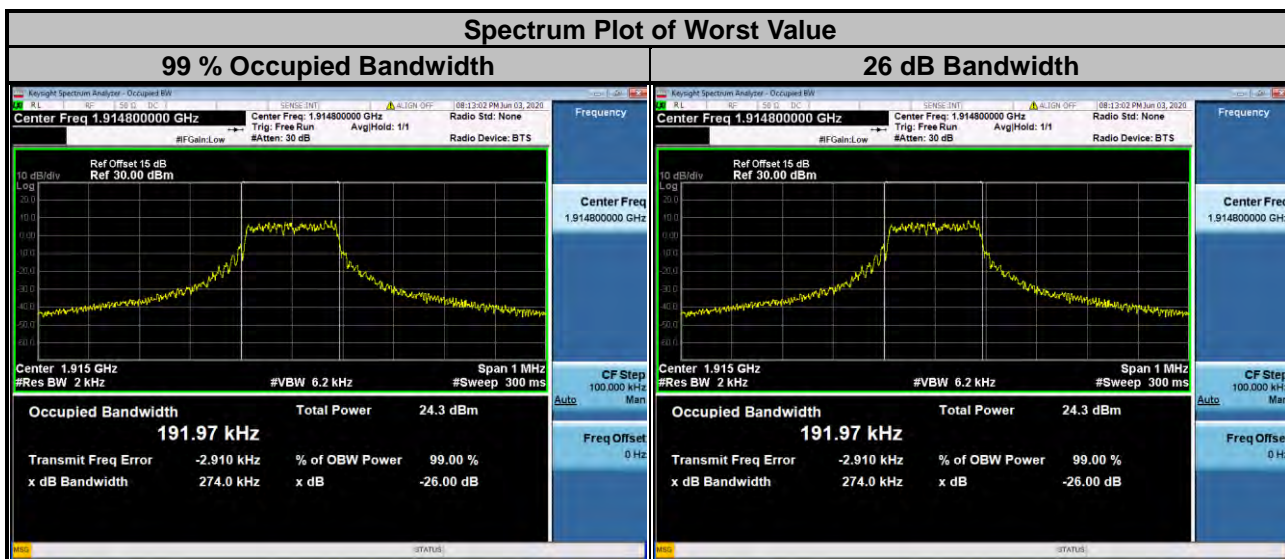

4.5 Band Edge Measurement

4.5.1 Limits of Band Edge Measurement

Power of any emission outside of the authorized operating frequency ranges must be attenuated below the transmitting power (P) by a factor of at least $43 + 10 \log(P)$ dB. In the 1 MHz bands immediately outside and adjacent to the frequency block a resolution bandwidth of at least one percent of the emission bandwidth of the fundamental emission of the transmitter may be employed.

4.5.2 Test Setup

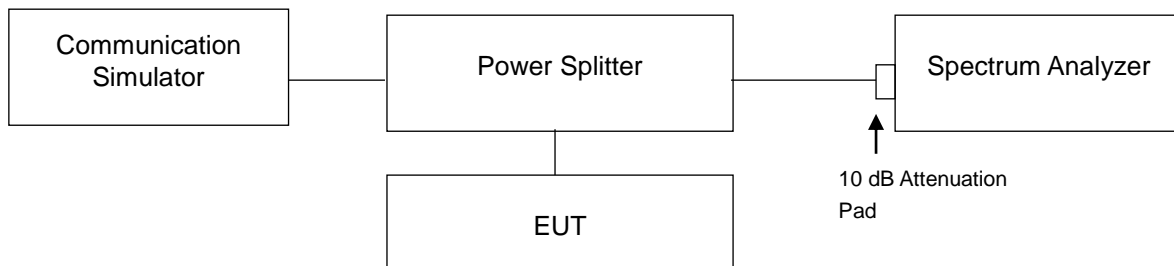

4.5.3 Test Procedures

- All measurements were done at low and high operational frequency range.
- The center frequency of spectrum is the band edge frequency and span is 5 MHz. RB of the spectrum is 30 kHz and VB of the spectrum is 91 kHz for Cat-M1.
- The center frequency of spectrum is the band edge frequency and span is 1 MHz. RB of the spectrum is 4.3 kHz and VB of the spectrum is 12 kHz for NB-IoT.
- Record the max trace plot into the test report.

4.5.4 Test Results

Cat-M1

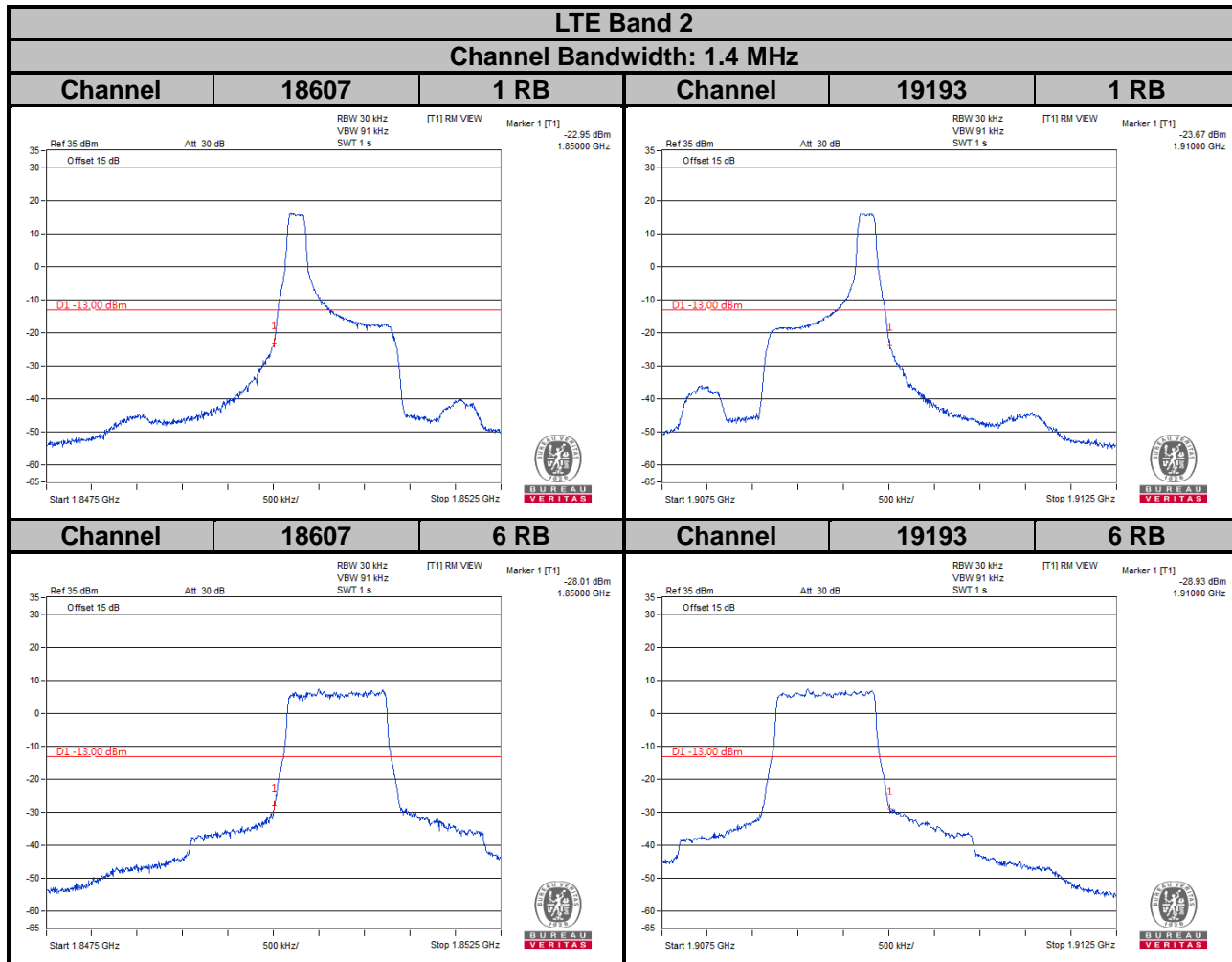

LTE Band 2

Channel Bandwidth: 3 MHz

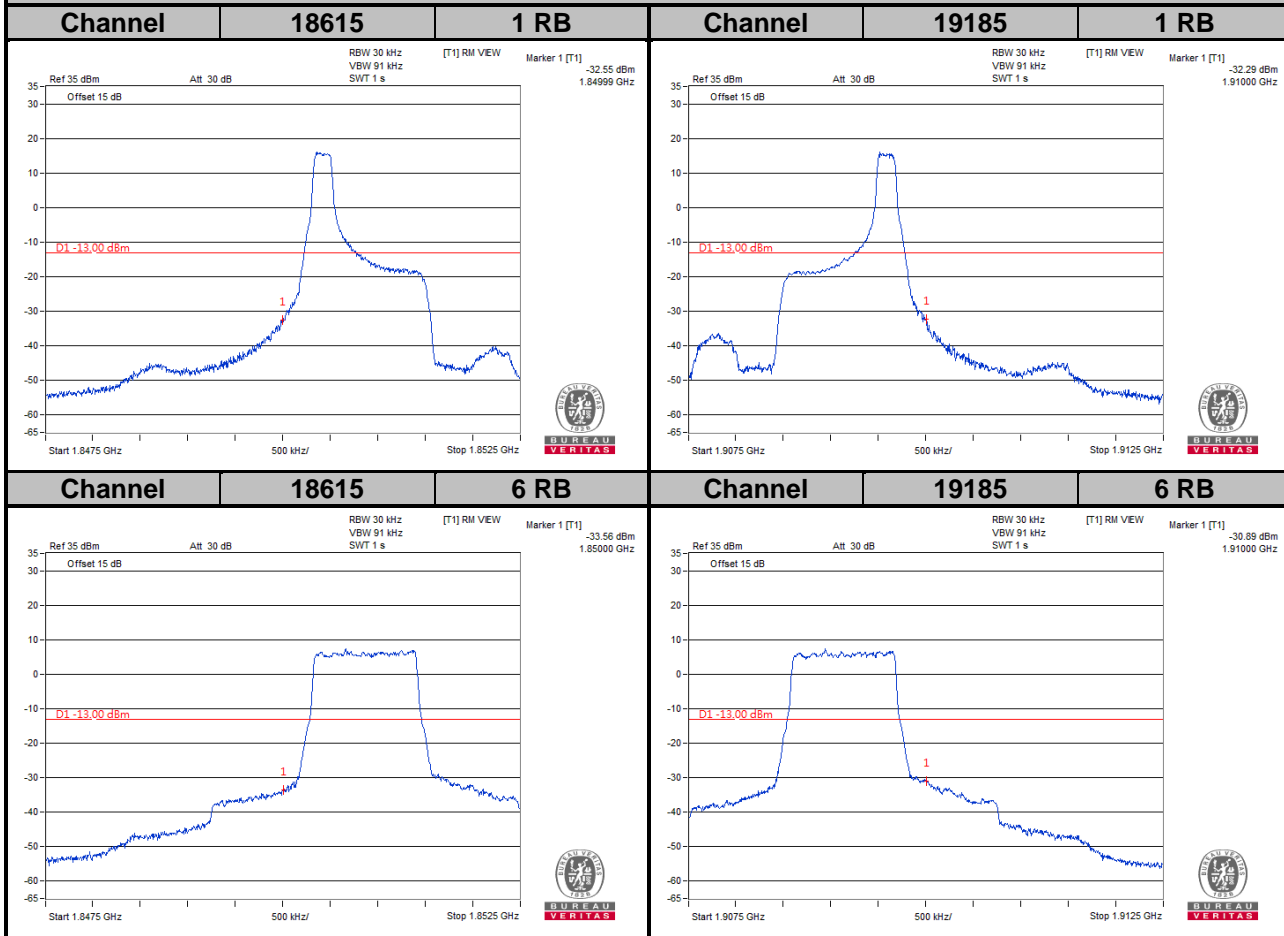

LTE Band 2
Channel Bandwidth: 5 MHz

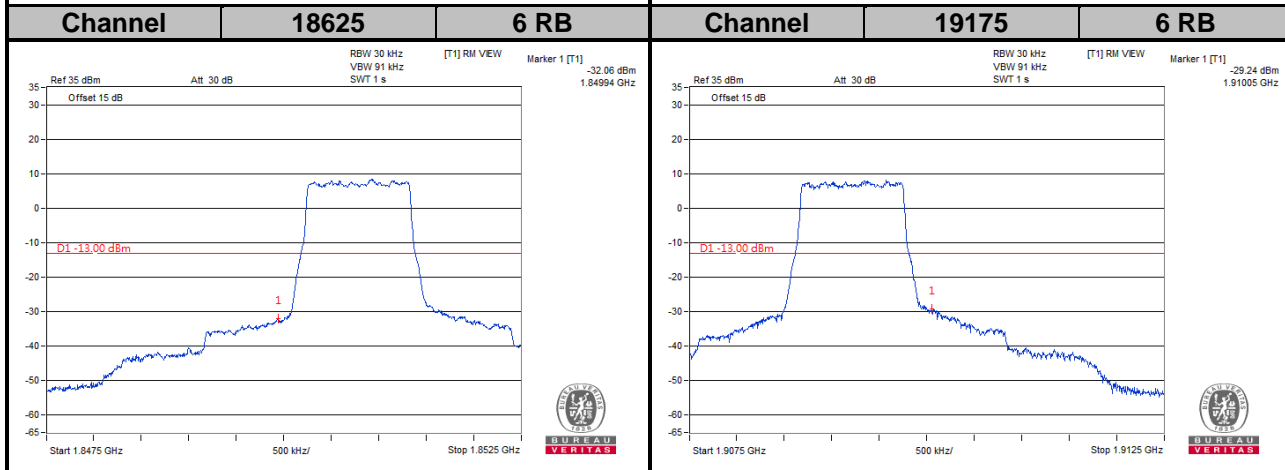
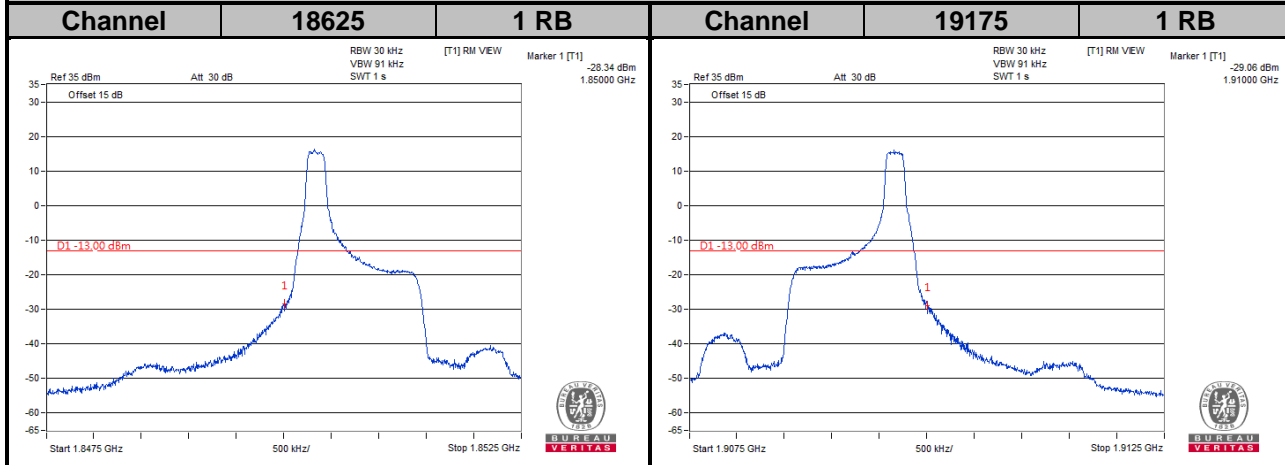

LTE Band 2
Channel Bandwidth: 10 MHz

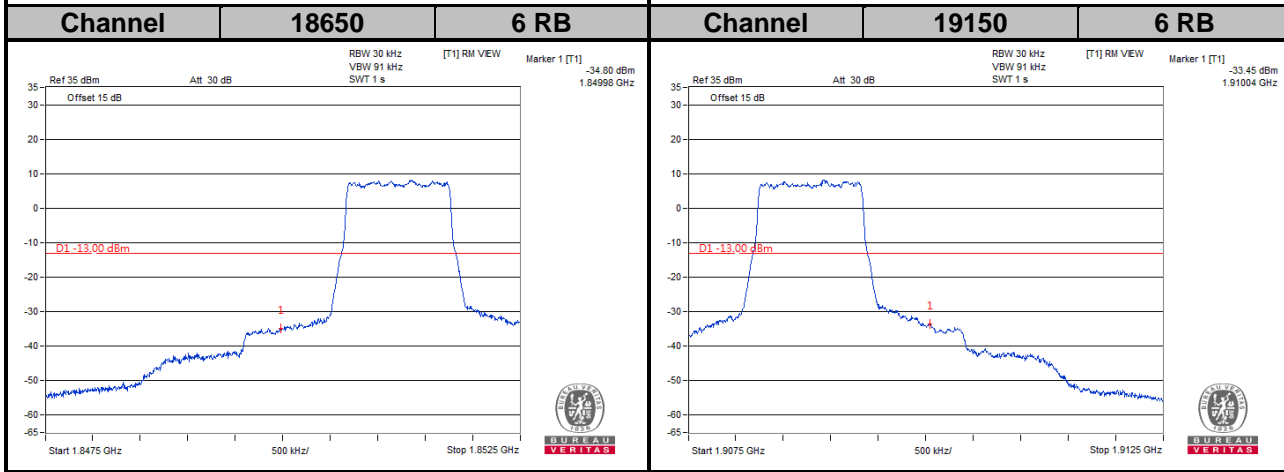
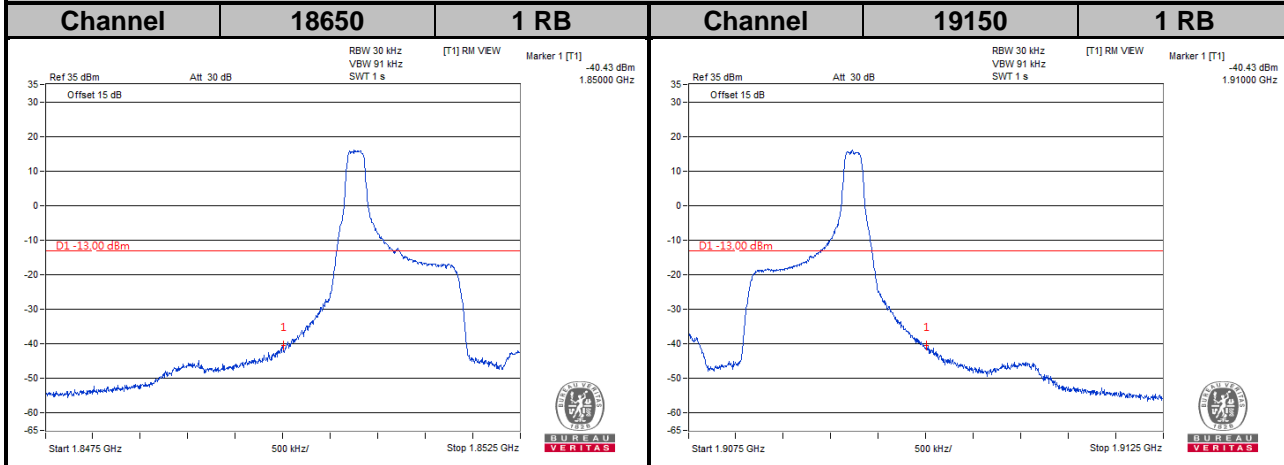

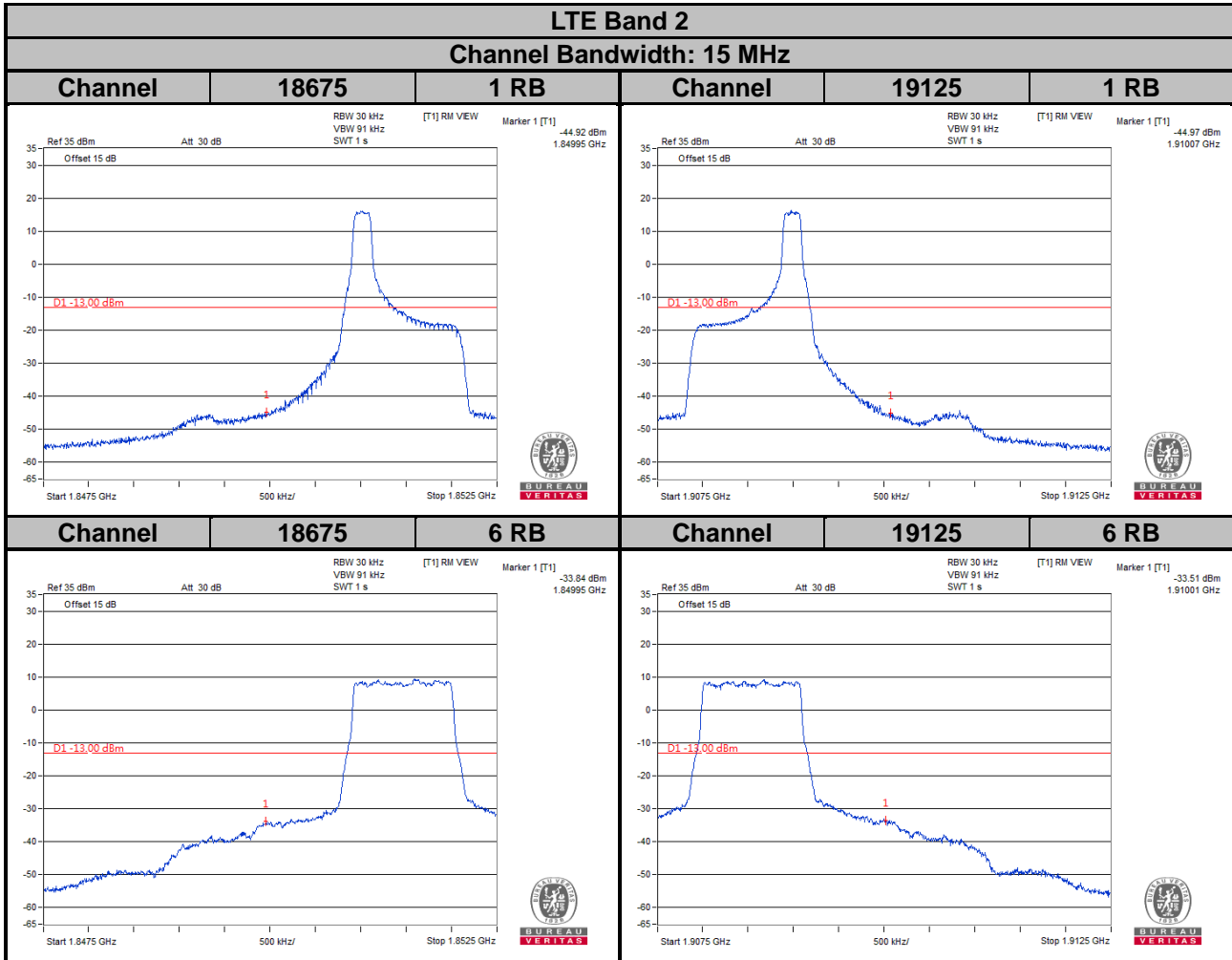

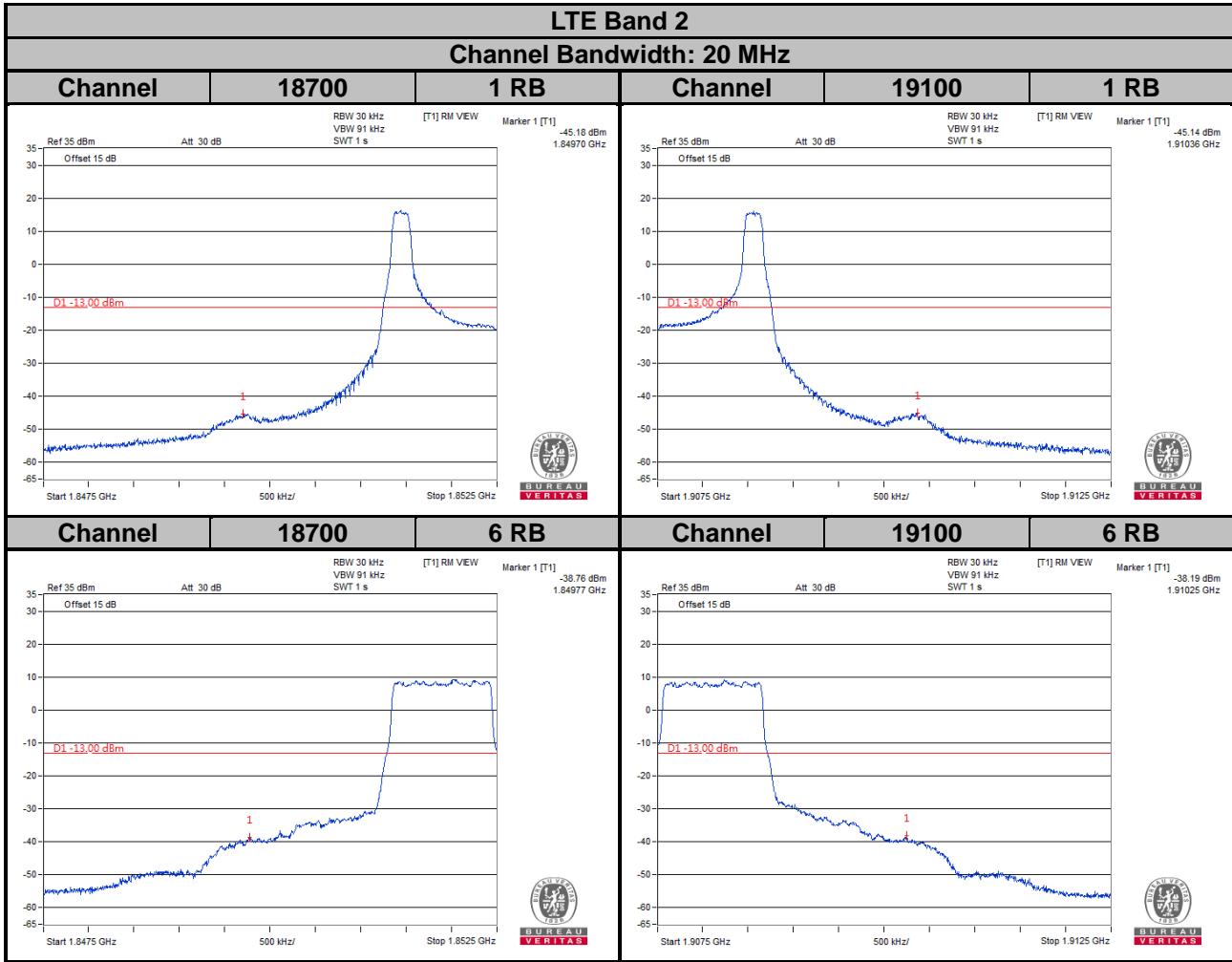

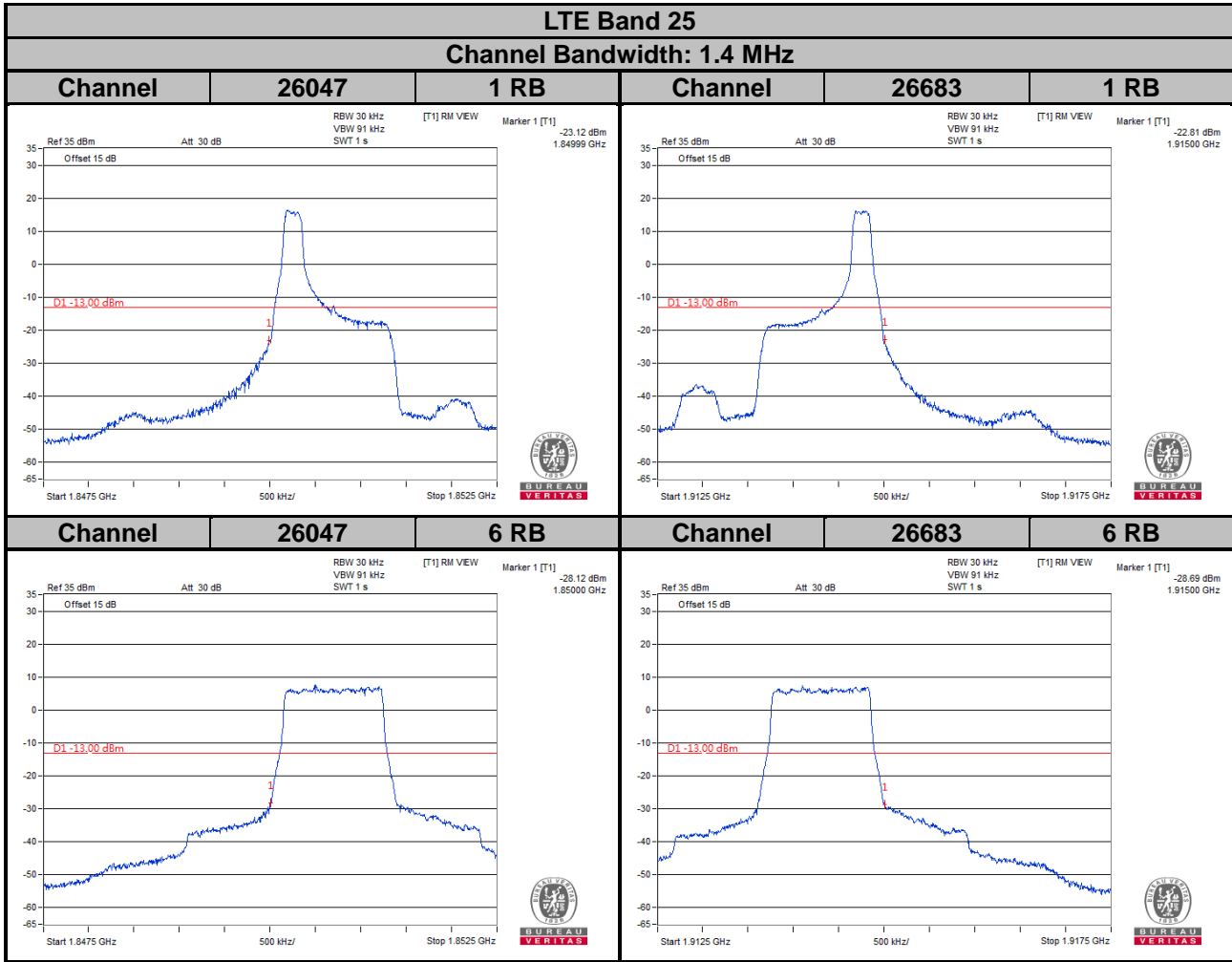

LTE Band 25

Channel Bandwidth: 3 MHz

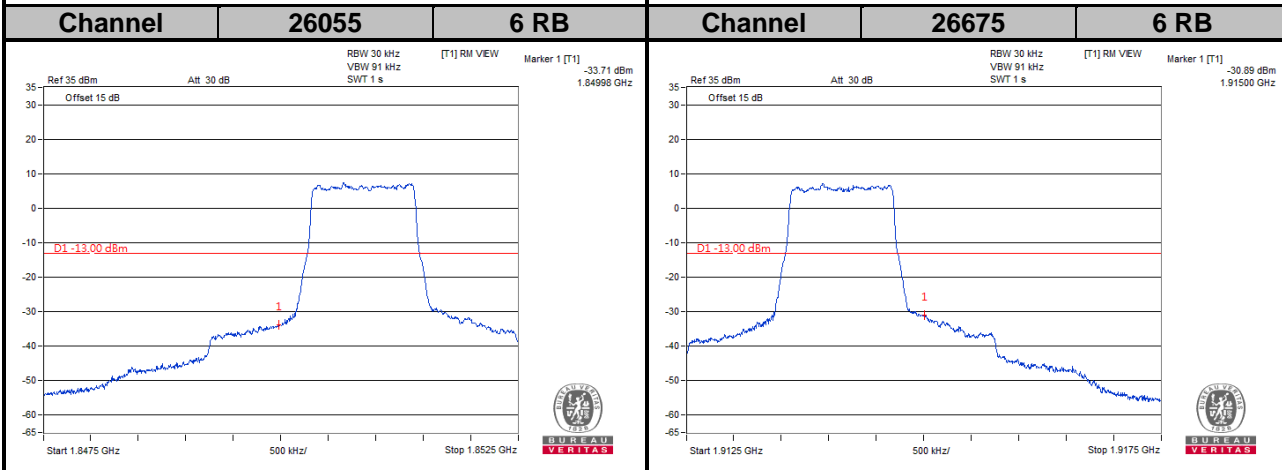
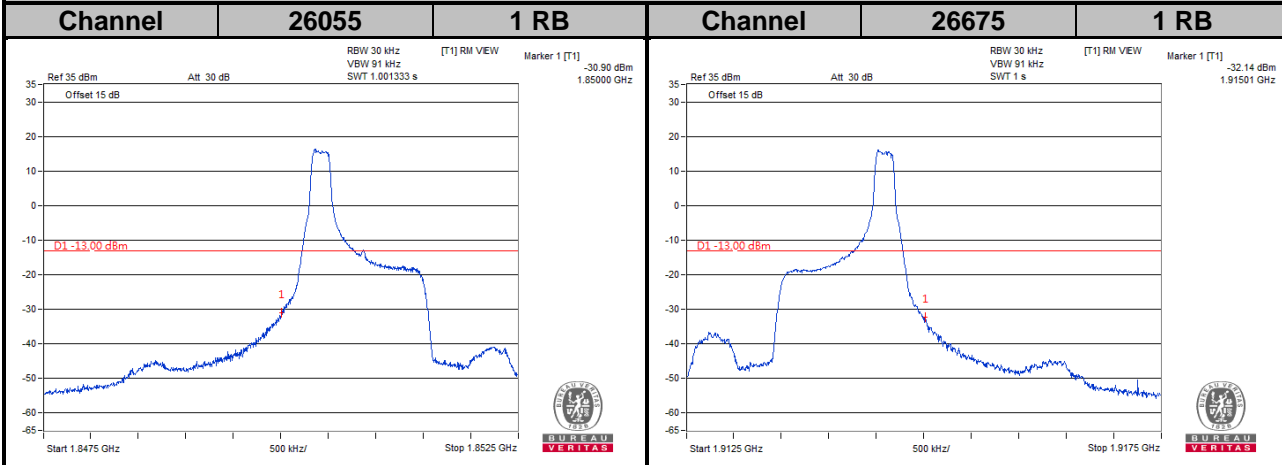

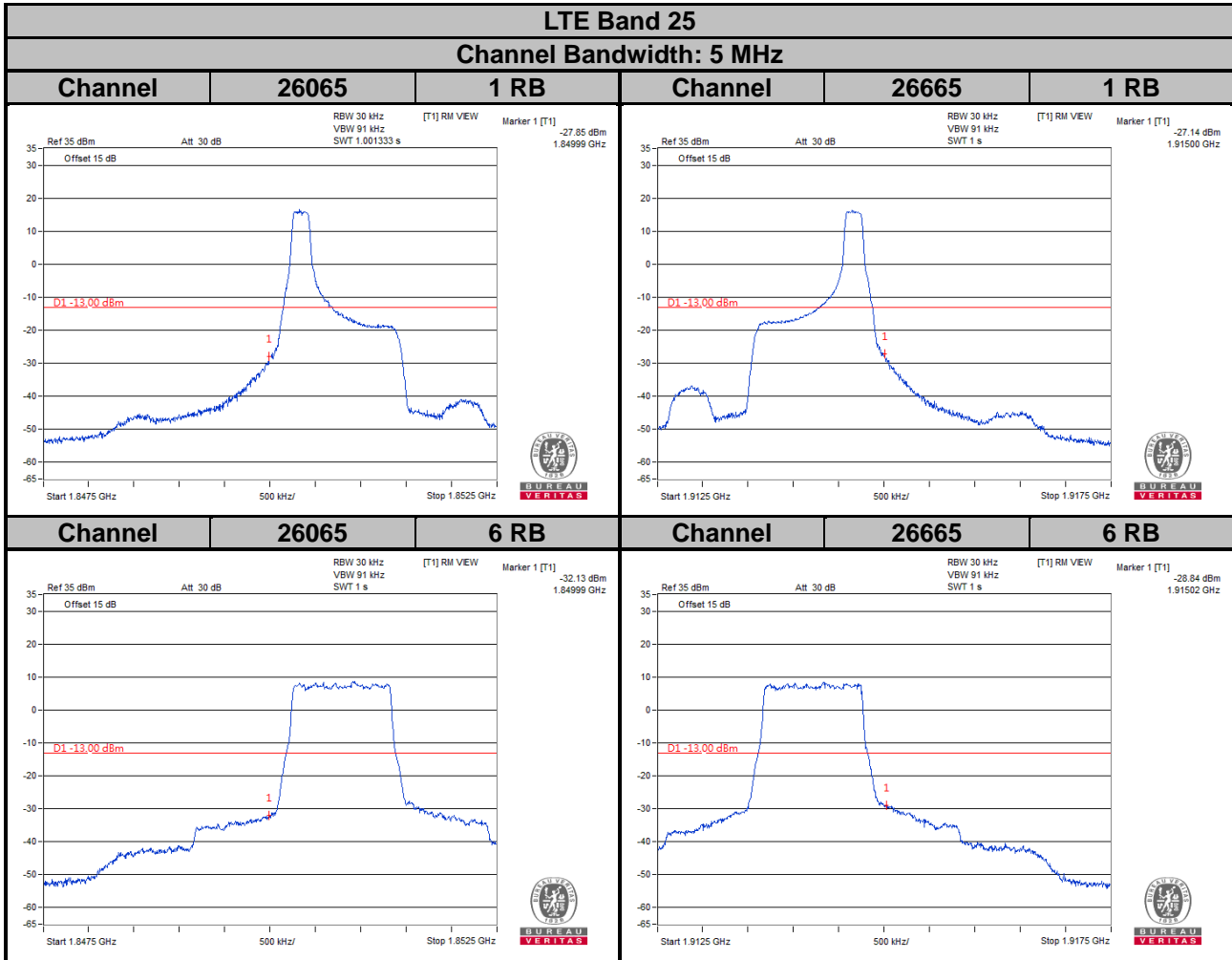

LTE Band 25

Channel Bandwidth: 10 MHz

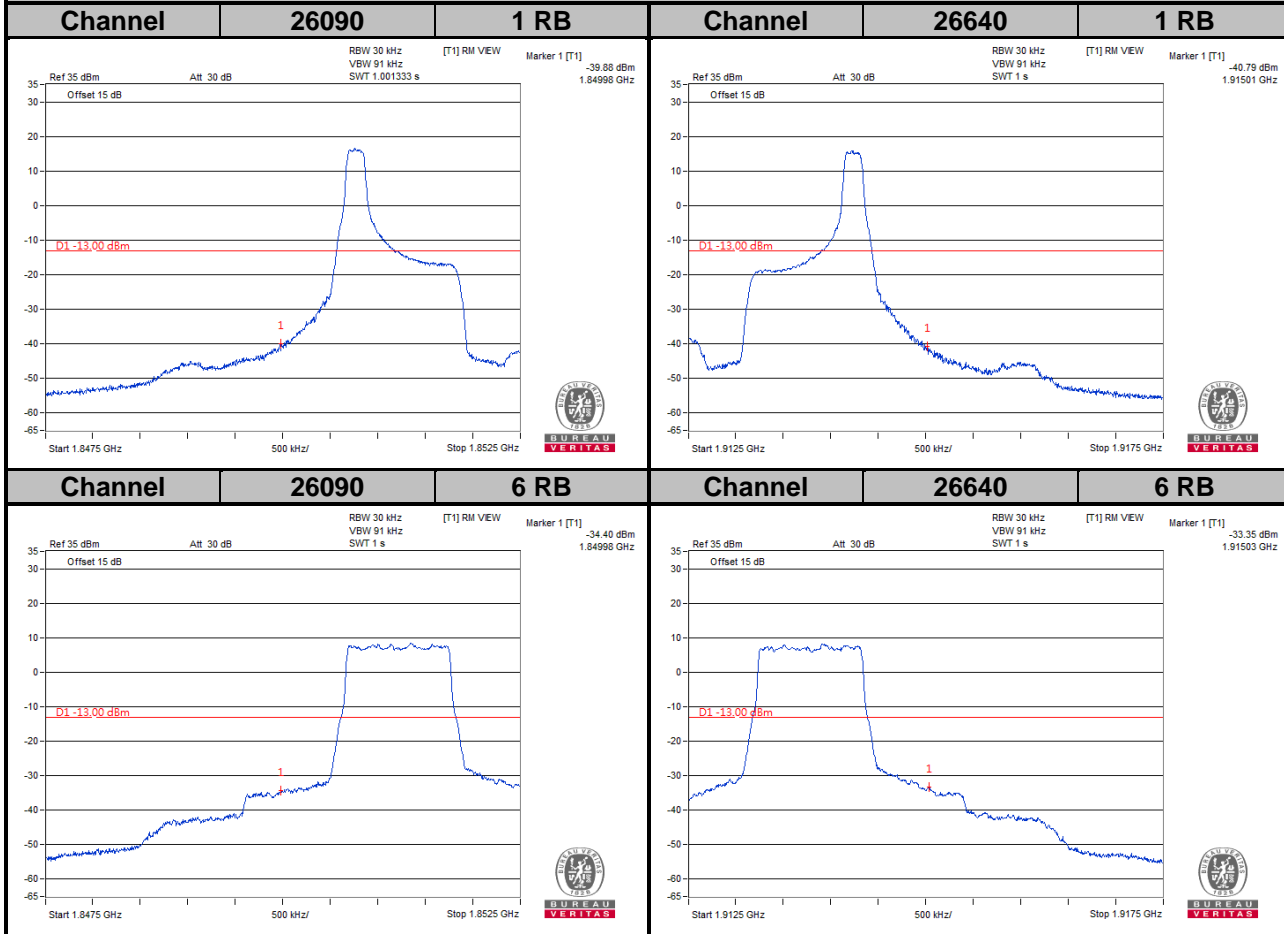

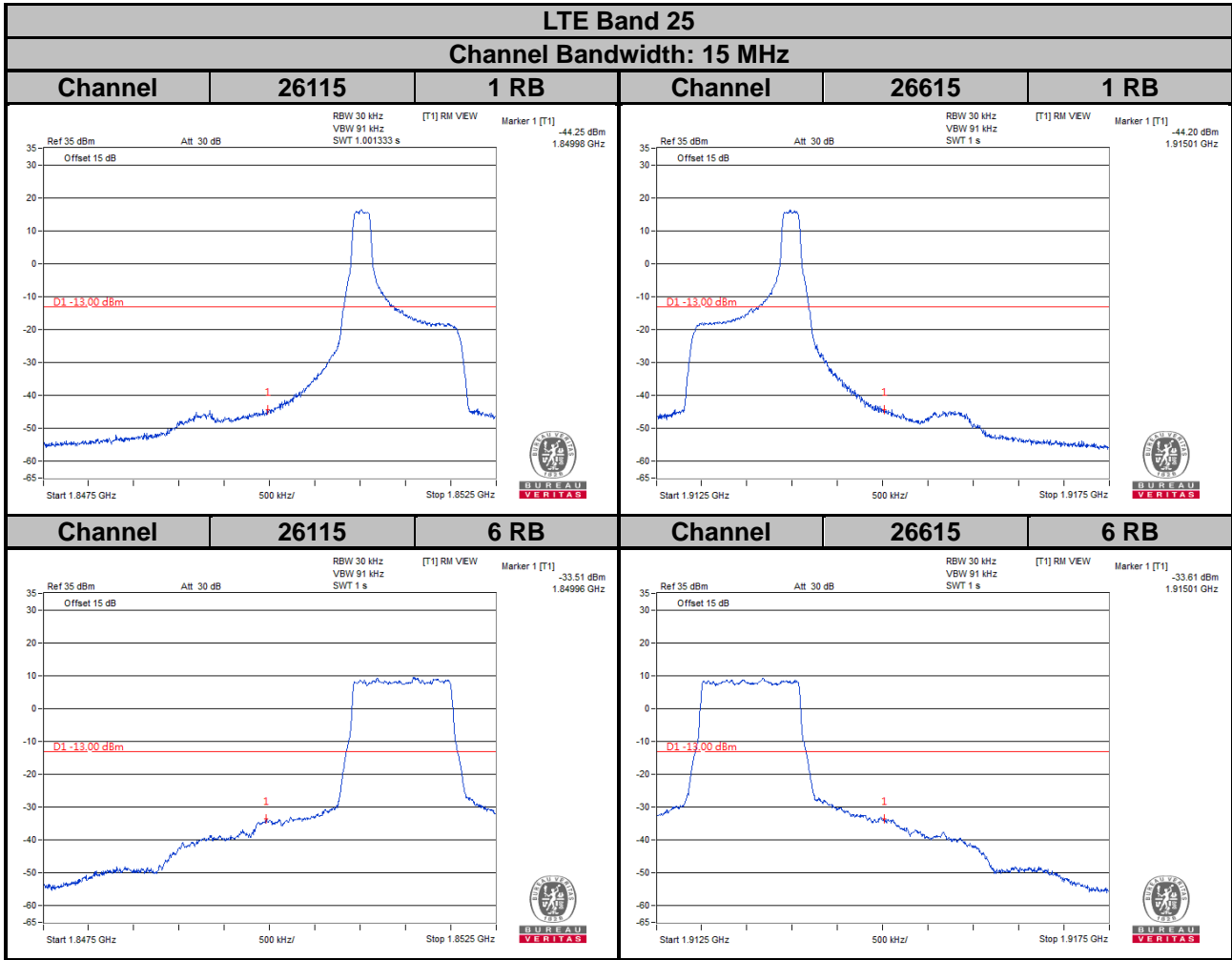

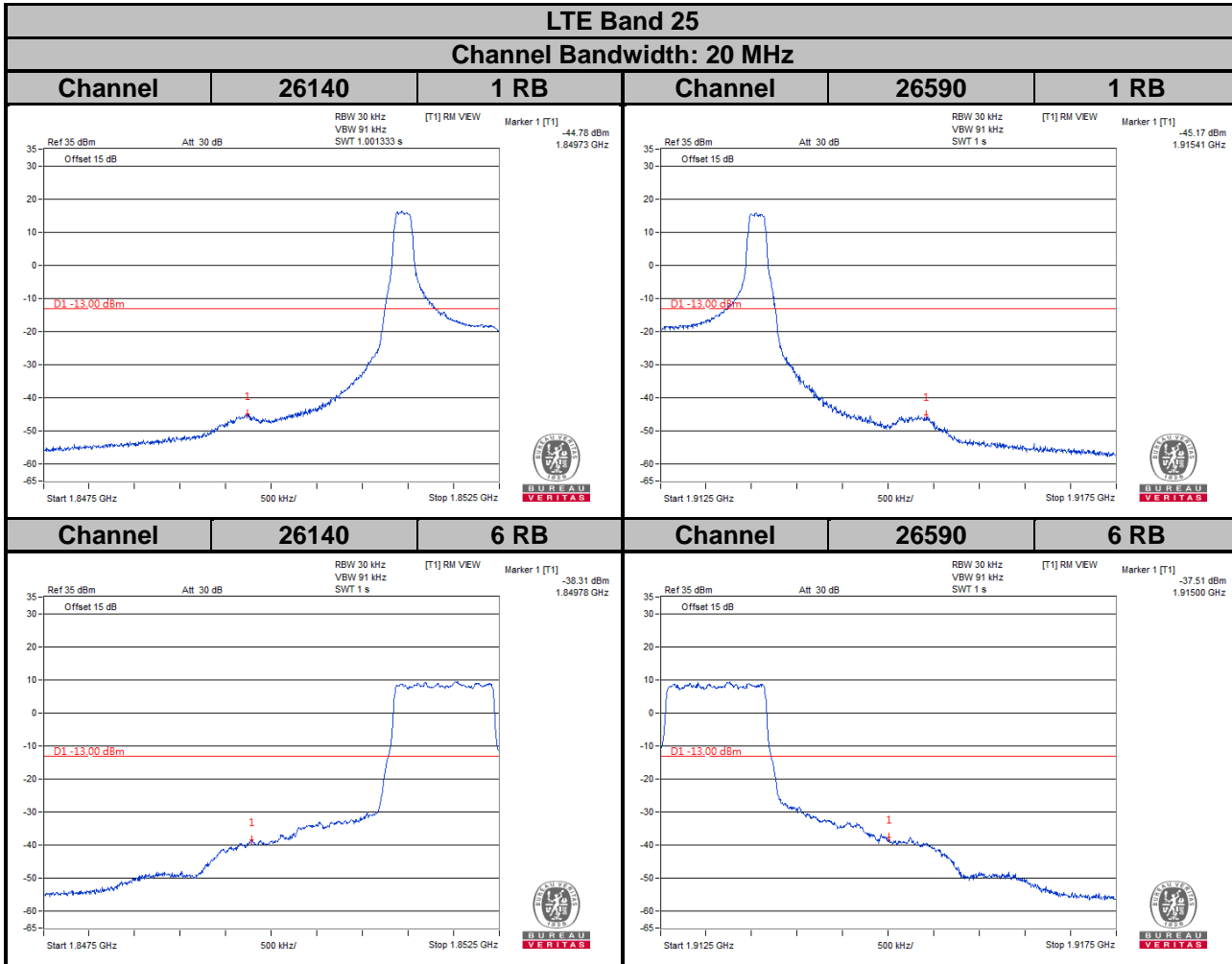

NB-IoT

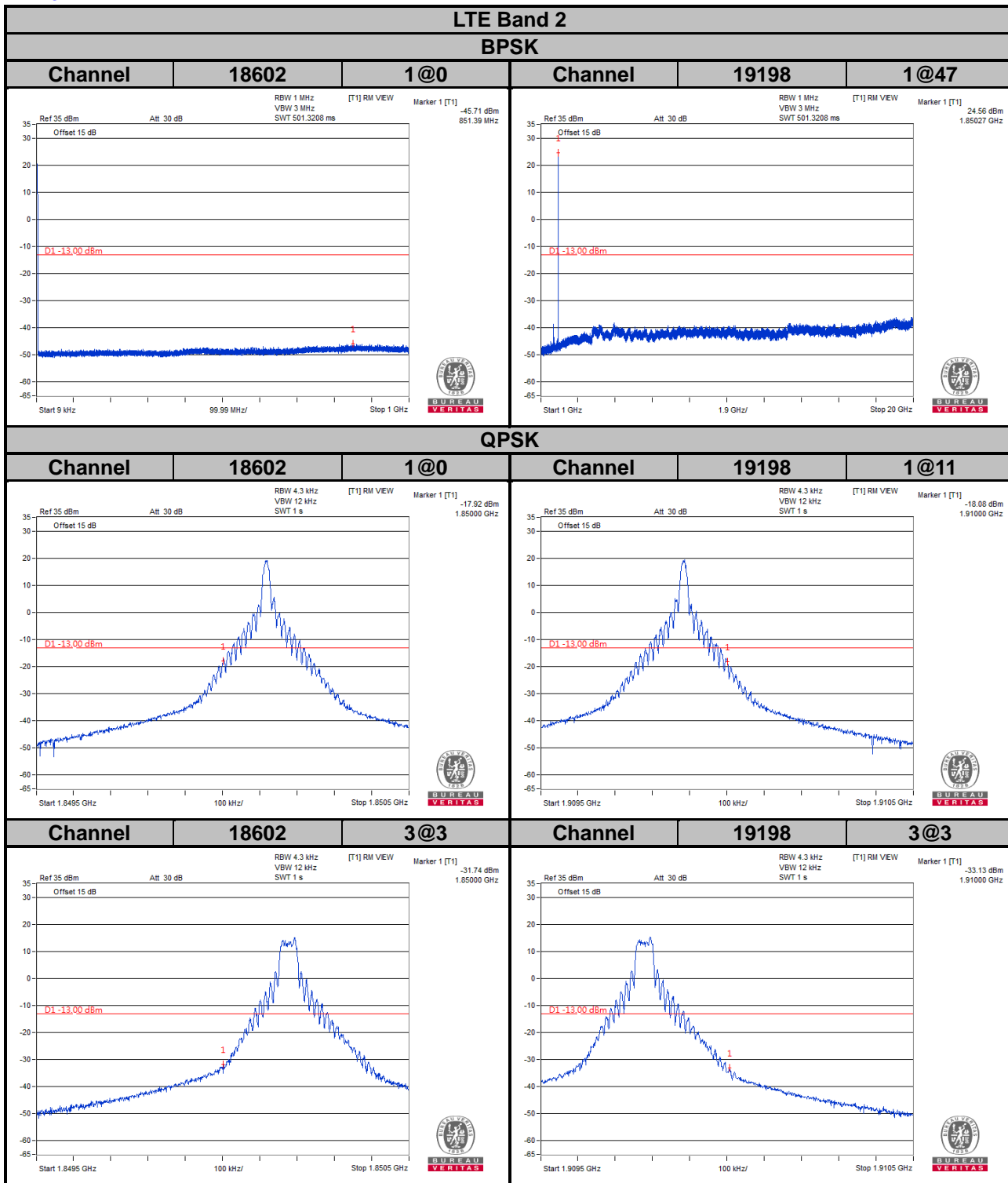

LTE Band 2

QPSK

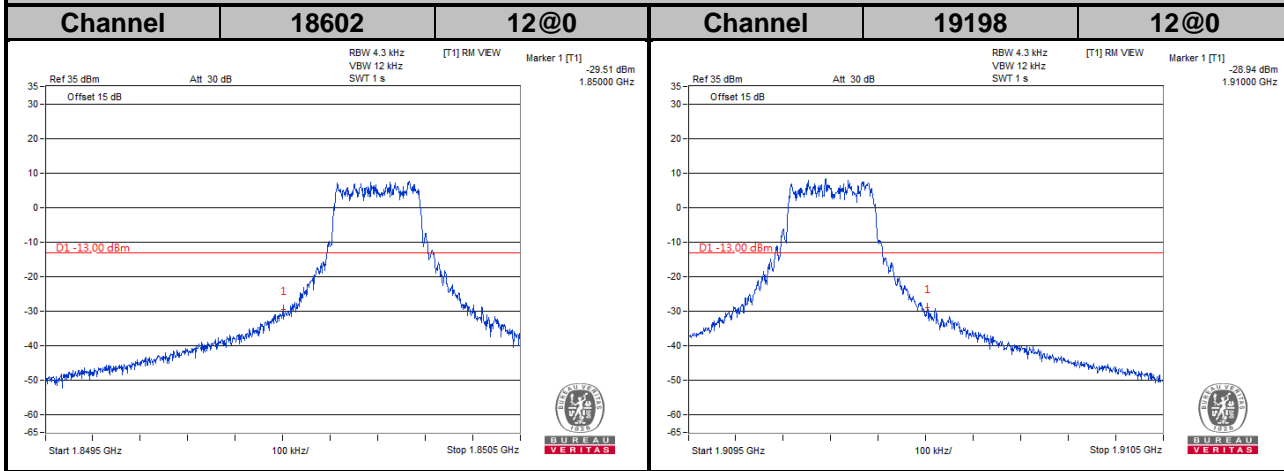

LTE Band 25 BPSK

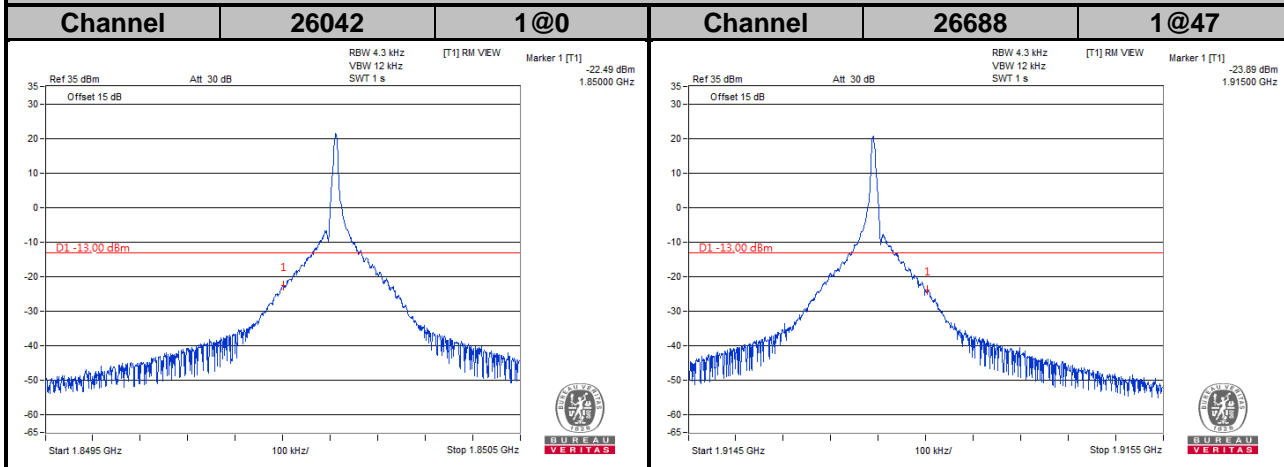

QPSK

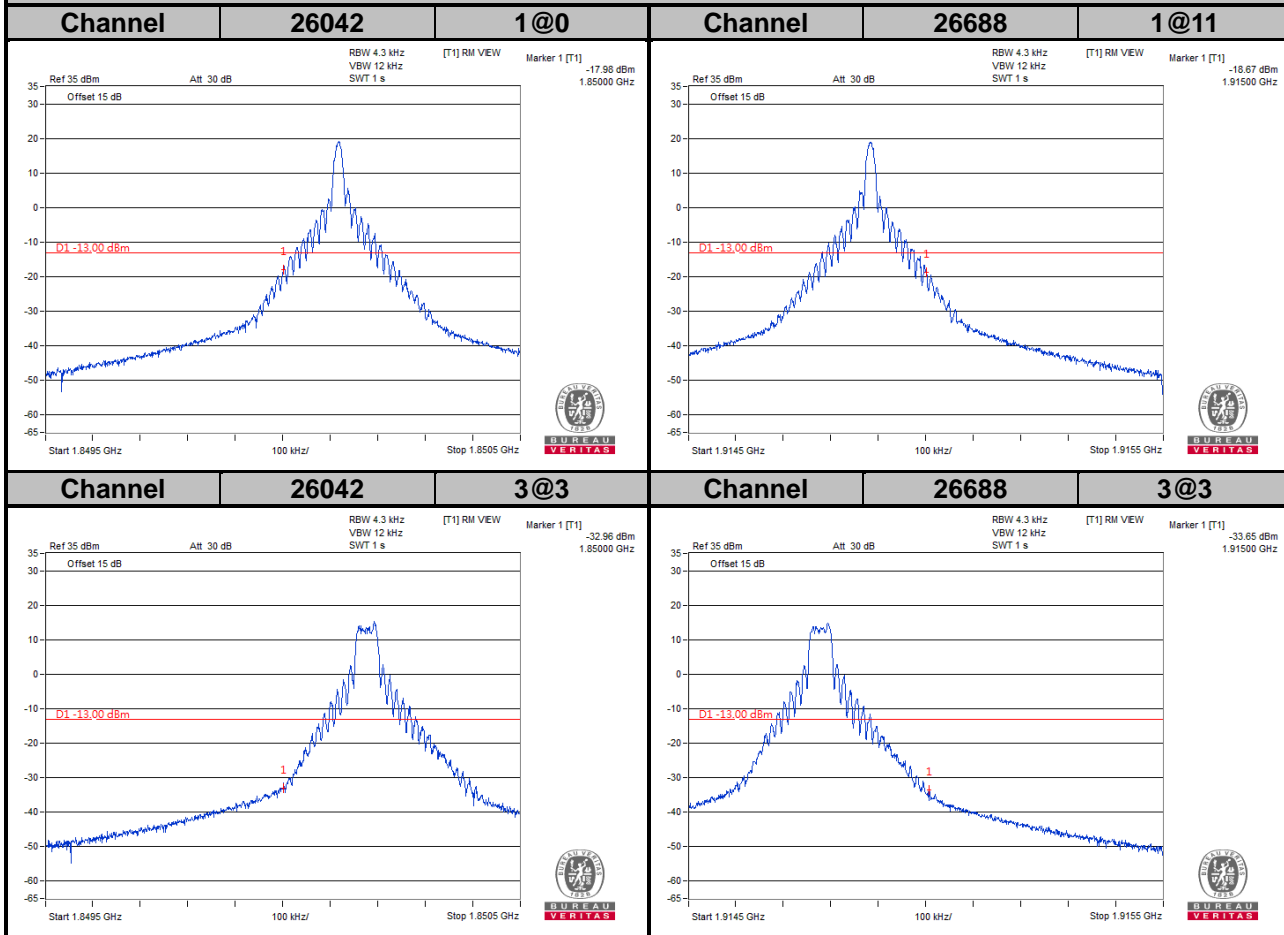

LTE Band 26

QPSK

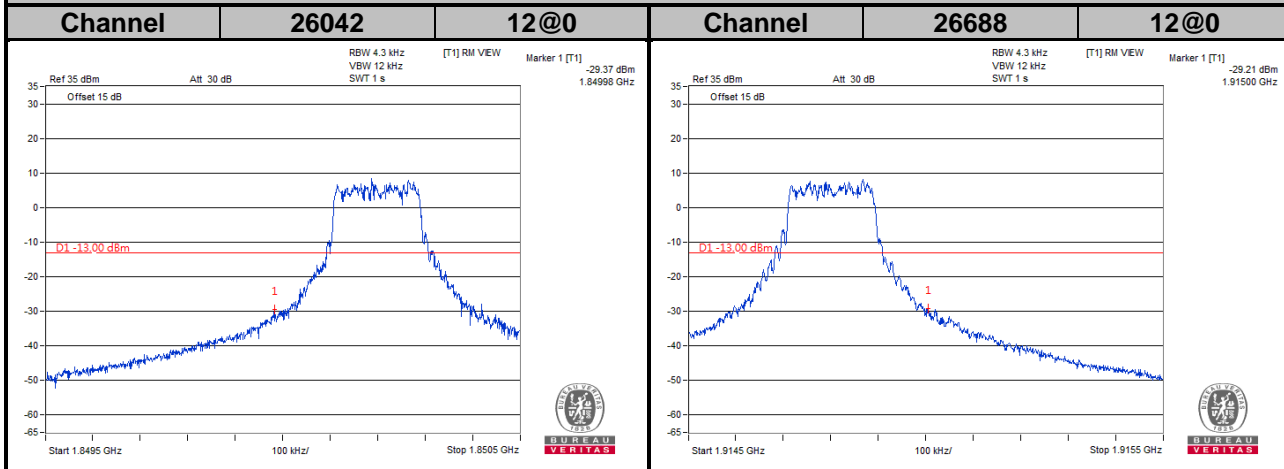

4.6 Peak to Average Ratio

4.6.1 Limits of Peak to Average Ratio Measurement

In measuring transmissions in this band using an average power technique, the peak to-average ratio (PAR) of the transmission may not exceed 13 dB.

4.6.2 Test Setup

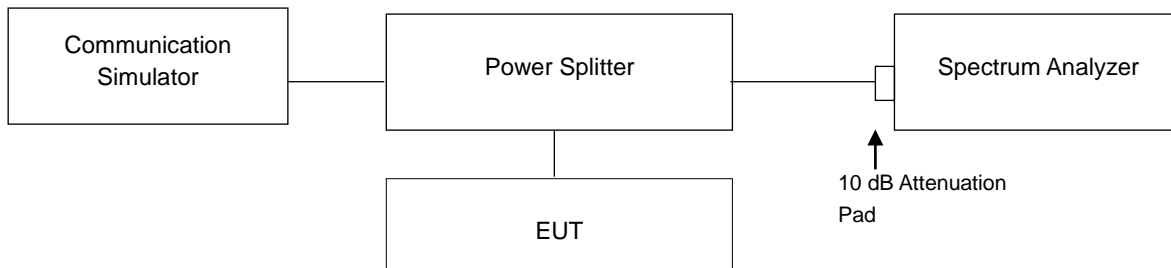

4.6.3 Test Procedures

1. Set resolution/measurement bandwidth \geq signal's occupied bandwidth;
2. Set the number of counts to a value that stabilizes the measured CCDF curve;
3. Record the maximum PAPR level associated with a probability of 0.1 %.

4.6.4 Test Results

Cat-M1

LTE Band 2							
Channel Bandwidth: 1.4 MHz				Channel Bandwidth: 3 MHz			
Channel	Frequency (MHz)	Peak to Average Ratio (dB)		Channel	Frequency (MHz)	Peak to Average Ratio (dB)	
		QPSK	16QAM			QPSK	16QAM
18607	1850.7	4.93	6.53	18615	1851.5	4.96	6.84
18900	1880.0	4.97	6.30	18900	1880.0	5.00	6.33
19193	1909.3	5.44	6.42	19185	1908.5	5.08	6.55

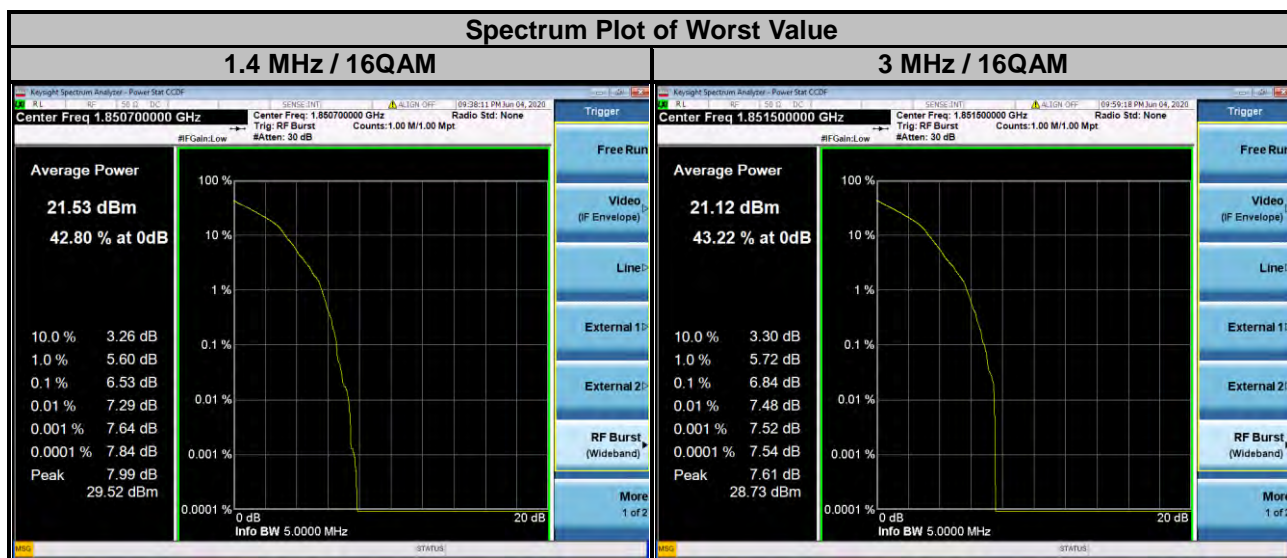

LTE Band 2

Channel Bandwidth: 5 MHz				Channel Bandwidth: 10 MHz			
Channel	Frequency (MHz)	Peak to Average Ratio (dB)		Channel	Frequency (MHz)	Peak to Average Ratio (dB)	
		QPSK	16QAM			QPSK	16QAM
18625	1852.5	5.56	5.84	18650	1855.0	5.61	5.81
18900	1880.0	5.58	5.88	18900	1880.0	6.89	5.86
19175	1907.5	5.69	6.03	19150	1905.0	5.80	5.99

Spectrum Plot of Worst Value

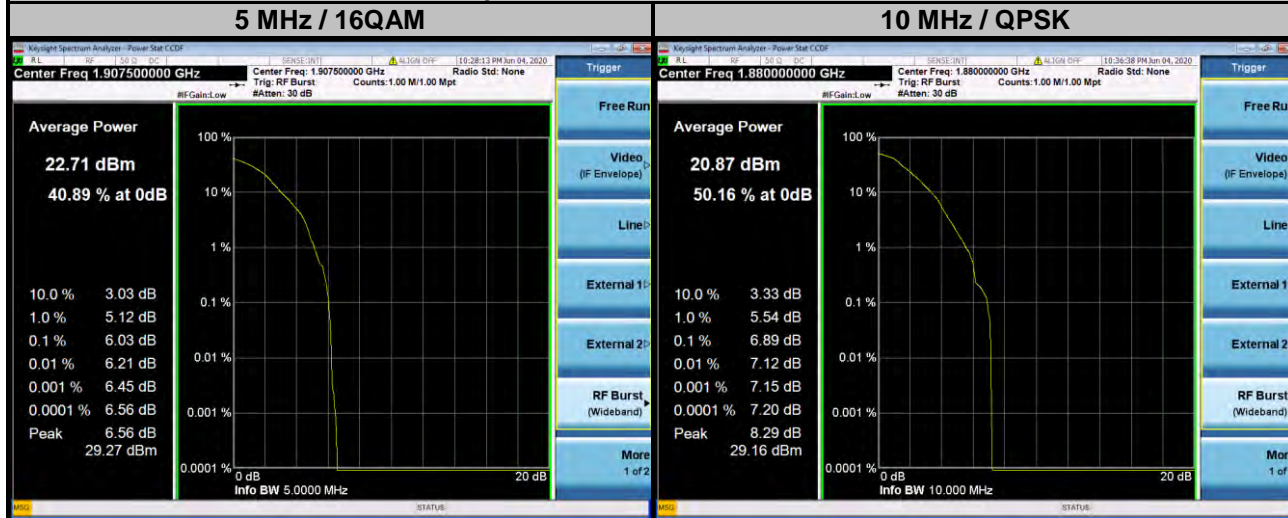

LTE Band 2							
Channel Bandwidth: 15 MHz				Channel Bandwidth: 20 MHz			
Channel	Frequency (MHz)	Peak to Average Ratio (dB)		Channel	Frequency (MHz)	Peak to Average Ratio (dB)	
		QPSK	16QAM			QPSK	16QAM
18675	1857.5	5.55	5.81	18700	1860.0	5.64	5.82
18900	1880.0	5.59	5.84	18900	1880.0	5.71	5.87
19125	1902.5	5.93	5.91	19100	1900.0	5.67	5.90

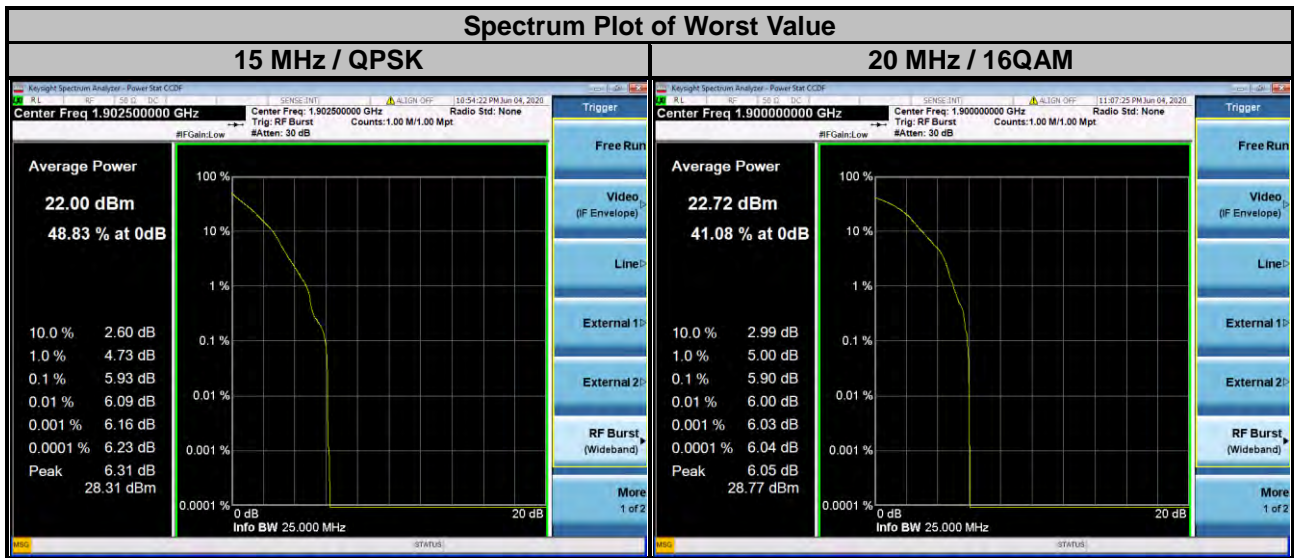

LTE Band 25

Channel Bandwidth: 1.4 MHz				Channel Bandwidth: 3 MHz			
Channel	Frequency (MHz)	Peak to Average Ratio (dB)		Channel	Frequency (MHz)	Peak to Average Ratio (dB)	
		QPSK	16QAM			QPSK	16QAM
26047	1850.7	4.93	6.47	26055	1851.5	4.94	6.22
26365	1882.5	4.90	6.16	26365	1882.5	4.94	6.26
26683	1914.3	5.04	6.68	26675	1913.5	5.07	6.35

Spectrum Plot of Worst Value

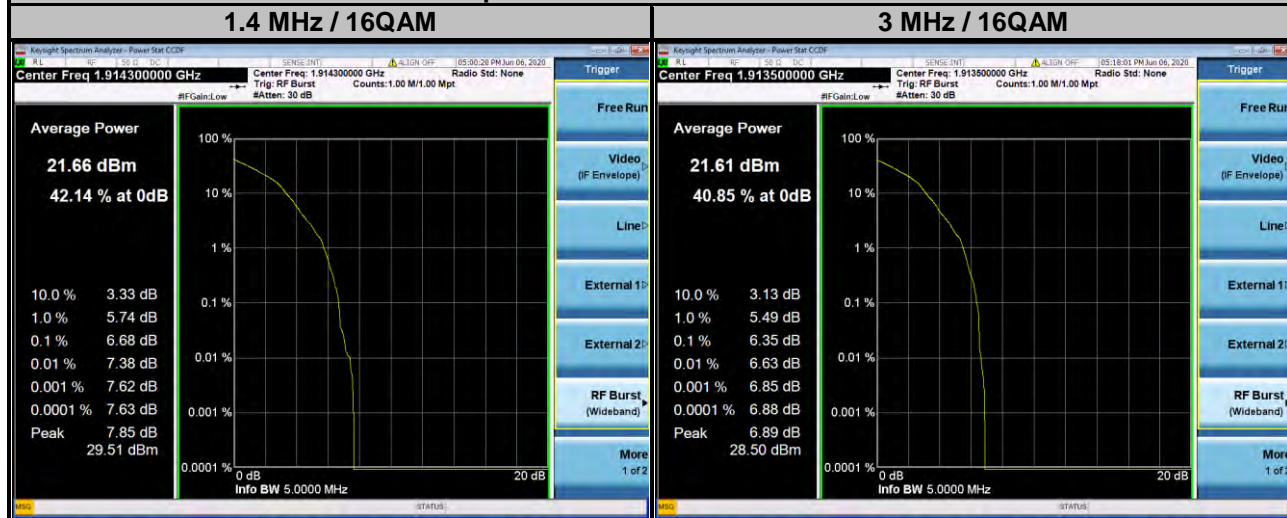

LTE Band 25

Channel Bandwidth: 5 MHz				Channel Bandwidth: 10 MHz			
Channel	Frequency (MHz)	Peak to Average Ratio (dB)		Channel	Frequency (MHz)	Peak to Average Ratio (dB)	
		QPSK	16QAM			QPSK	16QAM
26065	1852.5	5.55	5.80	26090	1855.0	5.53	5.91
26365	1882.5	5.55	5.85	26365	1882.5	5.50	5.83
26665	1912.5	5.62	5.99	26640	1910.0	5.74	5.91

Spectrum Plot of Worst Value

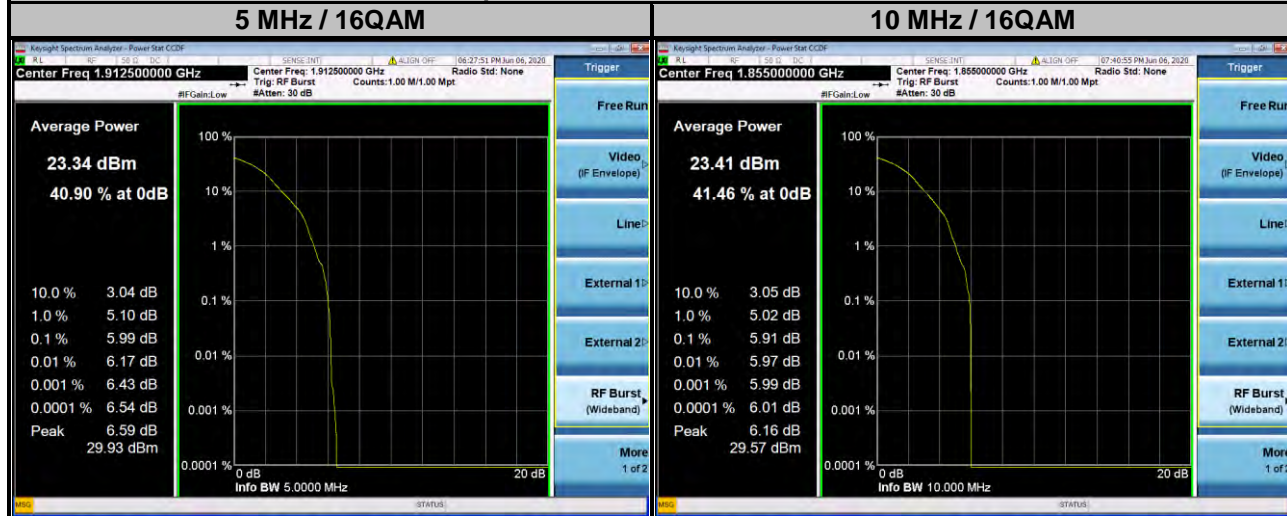

LTE Band 25

Channel Bandwidth: 15 MHz				Channel Bandwidth: 20 MHz			
Channel	Frequency (MHz)	Peak to Average Ratio (dB)		Channel	Frequency (MHz)	Peak to Average Ratio (dB)	
		QPSK	16QAM			QPSK	16QAM
26115	1857.5	6.07	5.93	26140	1860.0	5.65	5.77
26365	1882.5	5.53	5.78	26365	1882.5	5.57	5.79
26615	1907.5	6.31	5.88	26590	1905.0	5.63	5.86

Spectrum Plot of Worst Value

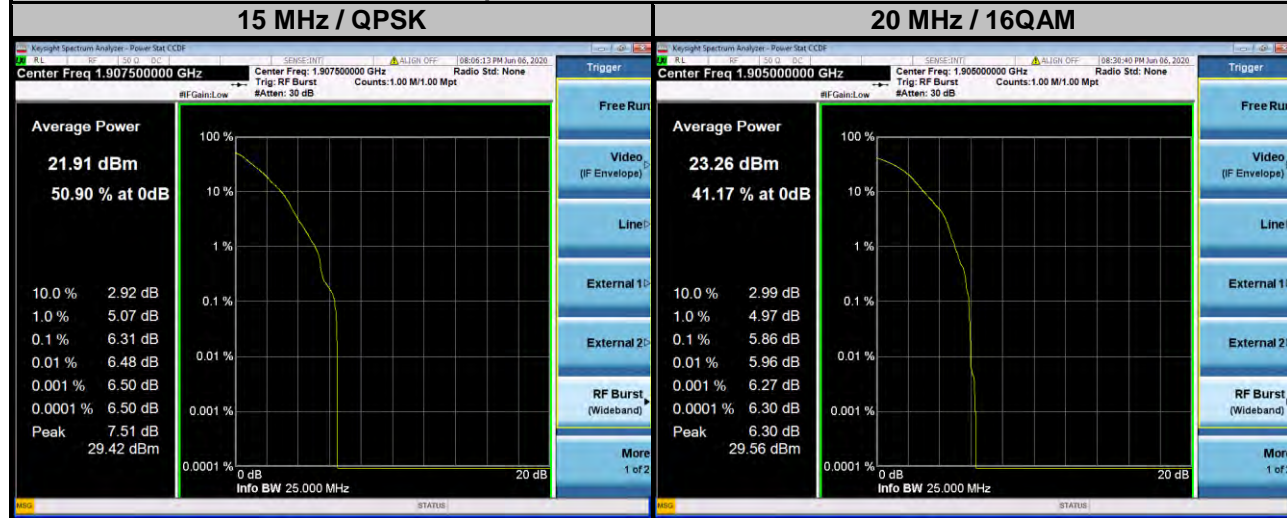

NB-IoT

LTE Band 2					
Channel	Frequency (MHz)	Modulation	N _{tones}	Sub-carrier Spacing (kHz)	PAPR (dB)
18900	1880	BPSK	1@0	3.75	2.44
18900	1880	QPSK	1@0	15	5.16
18900	1880	QPSK	3@3	15	6.89

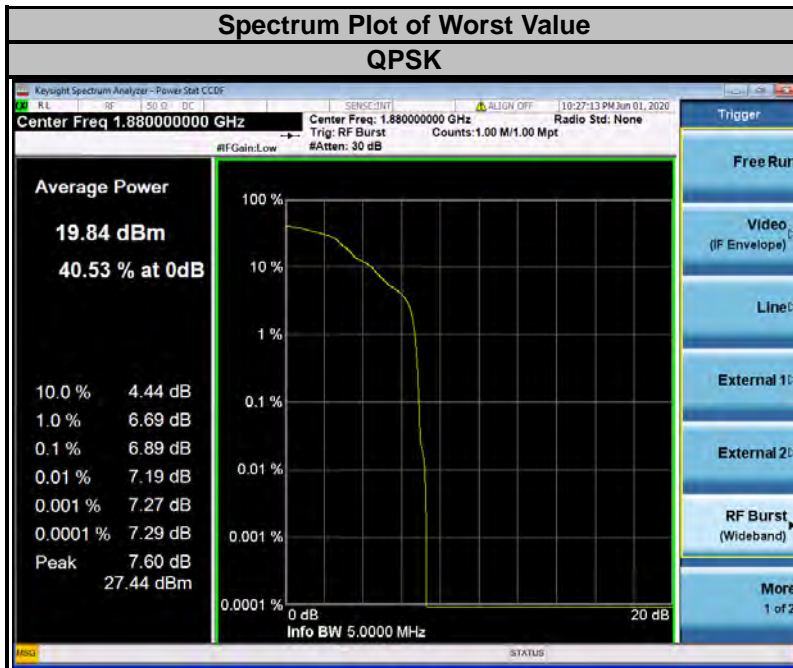

LTE Band 25					
Channel	Frequency (MHz)	Modulation	N _{tones}	Sub-carrier Spacing (kHz)	PAPR (dB)
26365	1882.5	BPSK	1@0	3.75	2.34
26365	1882.5	QPSK	1@0	15	5.15
26365	1882.5	QPSK	3@3	15	6.88

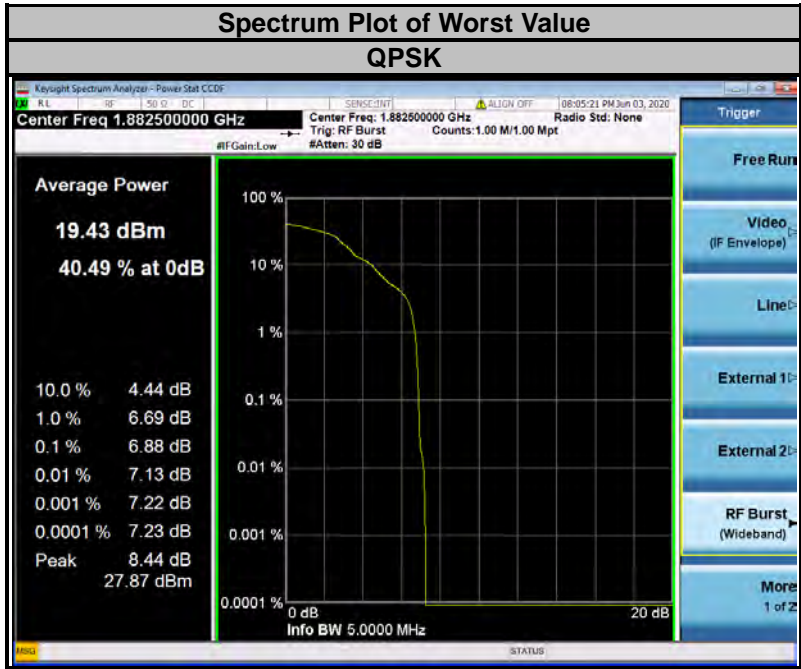

4.7 Conducted Spurious Emissions

4.7.1 Limits of Conducted Spurious Emissions Measurement

The power of any emission outside of the authorized operating frequency ranges must be attenuated below the transmitting power (P) by a factor of at least $43 + 10 \log(P)$ dB. The emission limit equal to -13 dBm.

4.7.2 Test Setup

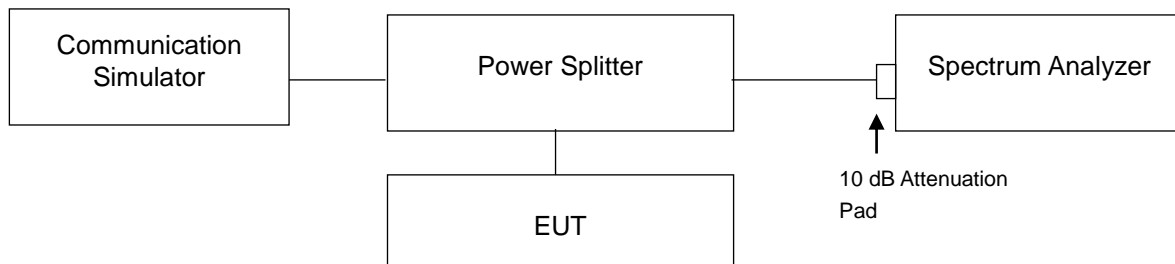

4.7.3 Test Procedure

- The EUT makes a phone call to the communication simulator. All measurements were done at low, middle and high operational frequency range.
- Measuring frequency range is from 9 kHz to 1 GHz. 10 dB attenuation pad is connected with spectrum. RBW = 1 MHz and VBW = 3 MHz is used for conducted emission measurement.
- Measuring frequency range is from 1 GHz to 20 GHz. 10 dB attenuation pad is connected with spectrum. RBW = 1 MHz and VBW = 3 MHz is used for conducted emission measurement.

4.7.4 Test Results

Cat-M1

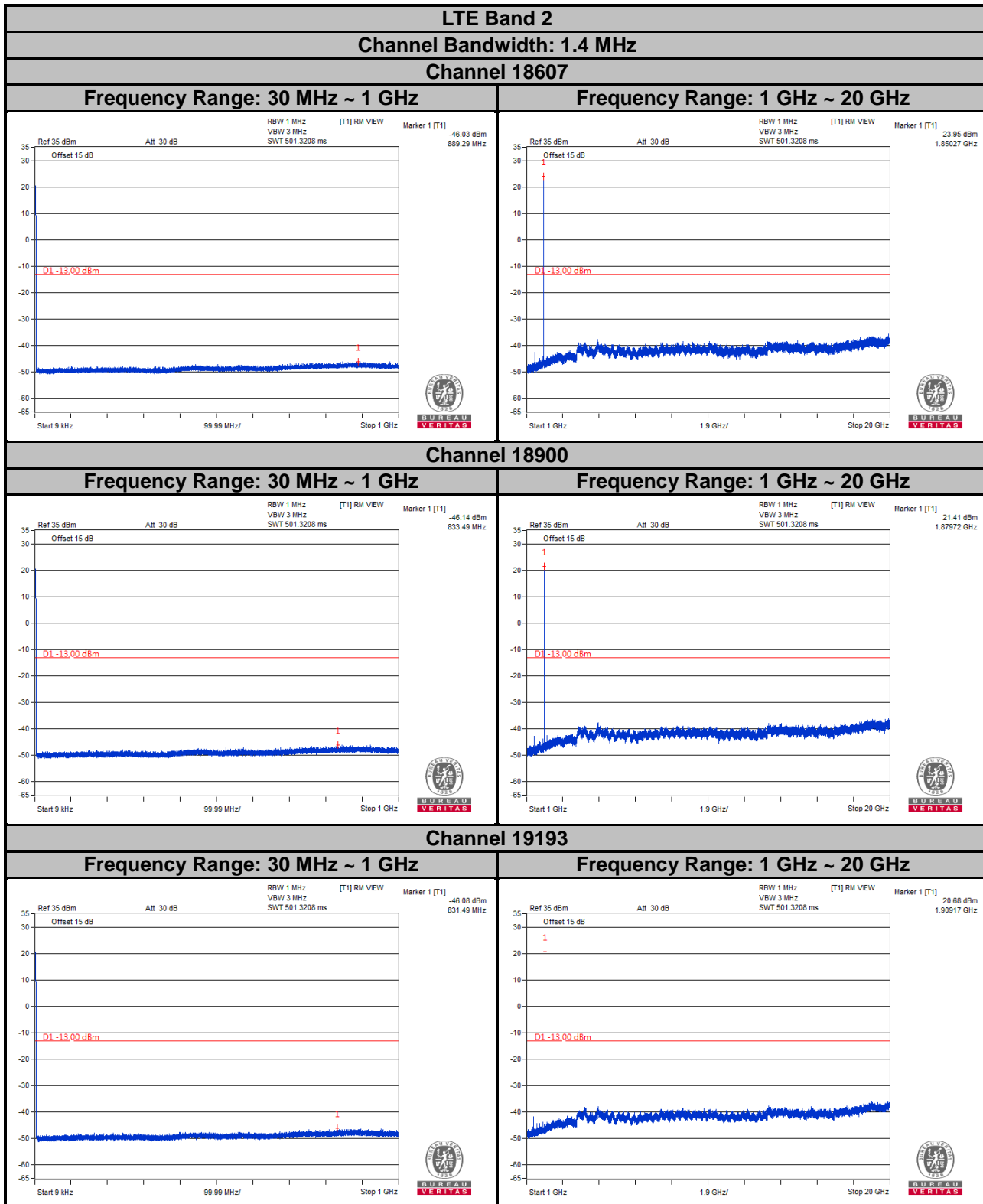

Note: The signal over the limit in 9 kHz is from spectrum analyzer.

LTE Band 2
Channel Bandwidth: 3 MHz
Channel 18615

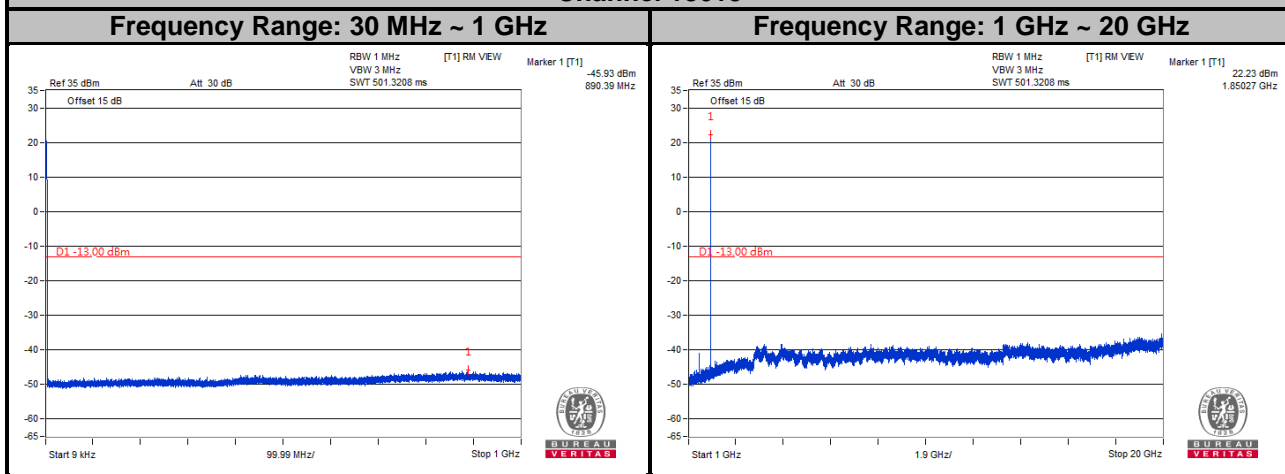

Channel 18900

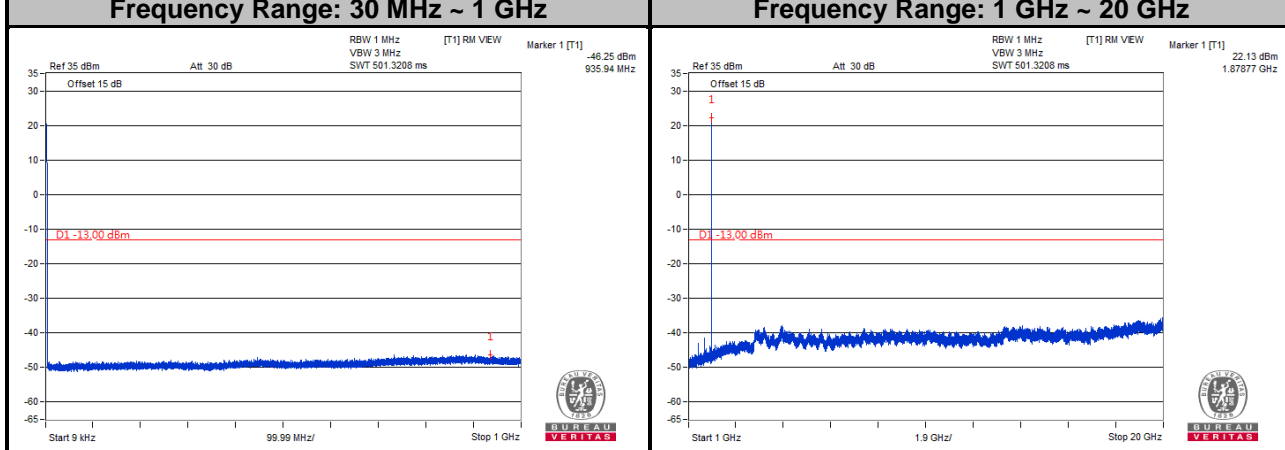

Channel 19185

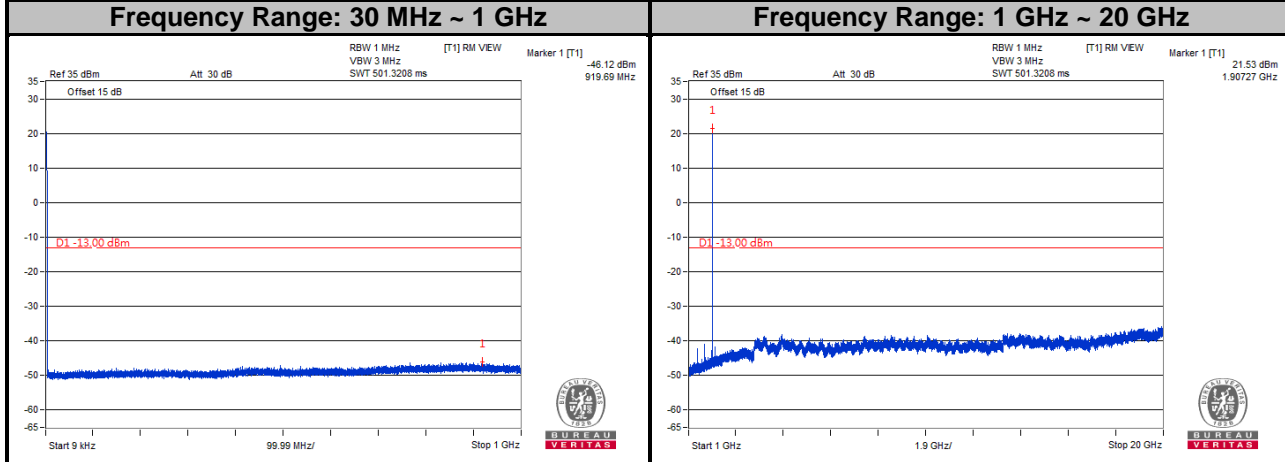

Note: The signal over the limit in 9 kHz is from spectrum analyzer.

LTE Band 2
Channel Bandwidth: 5 MHz
Channel 18625

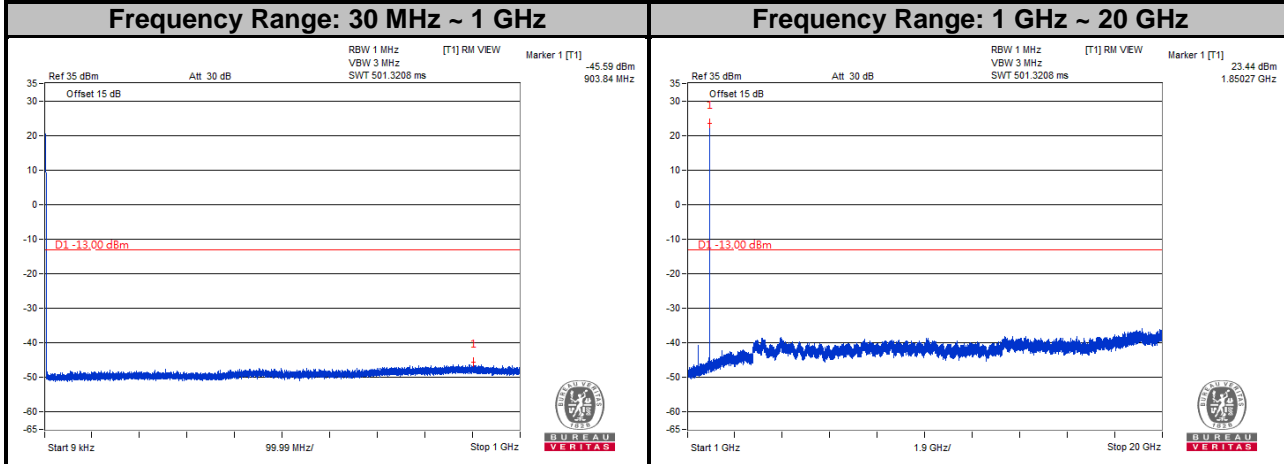

Channel 18900

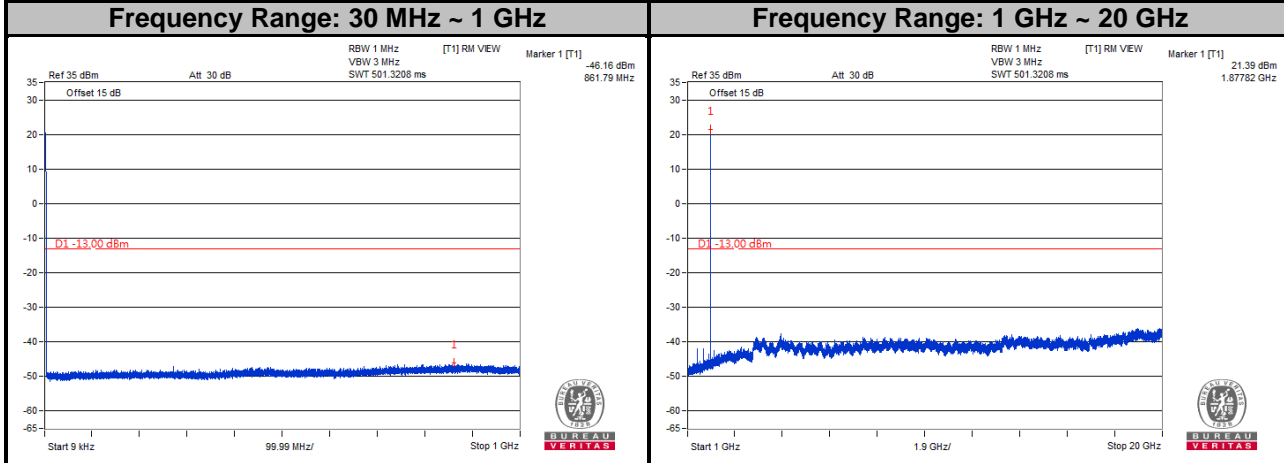

Channel 19175

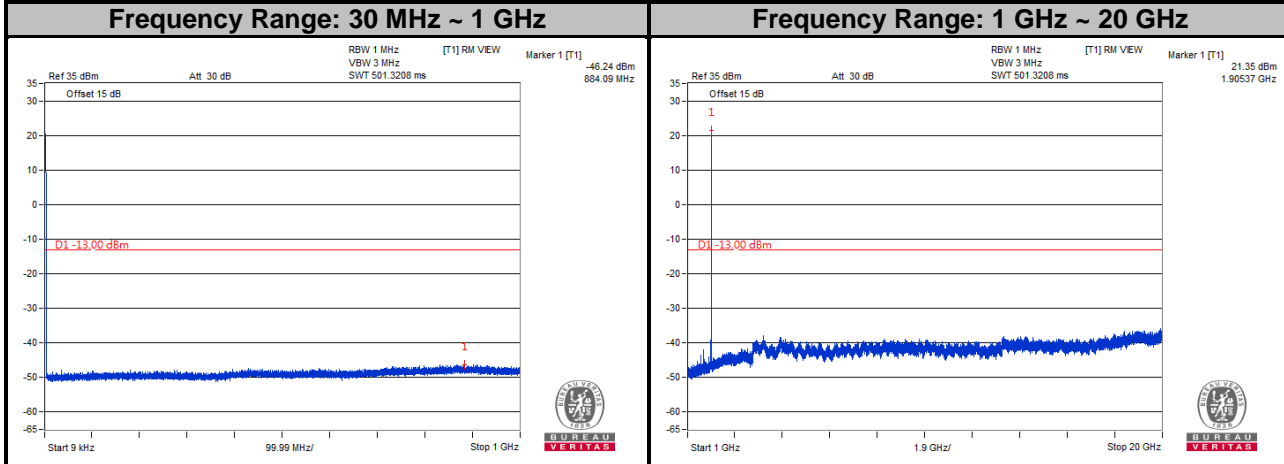

Note: The signal over the limit in 9 kHz is from spectrum analyzer.

LTE Band 2
Channel Bandwidth: 10 MHz
Channel 18650

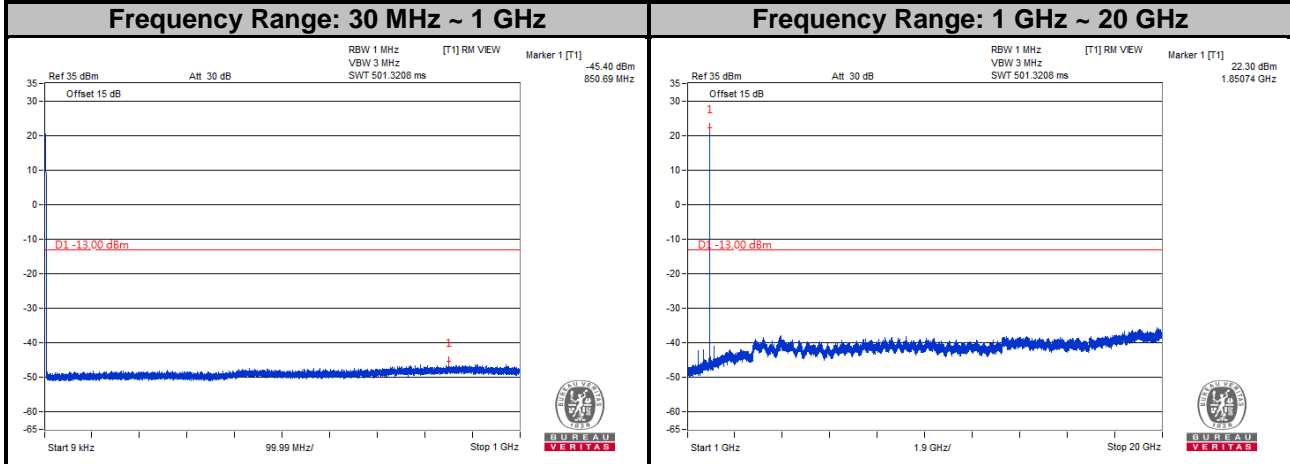

Channel 18900

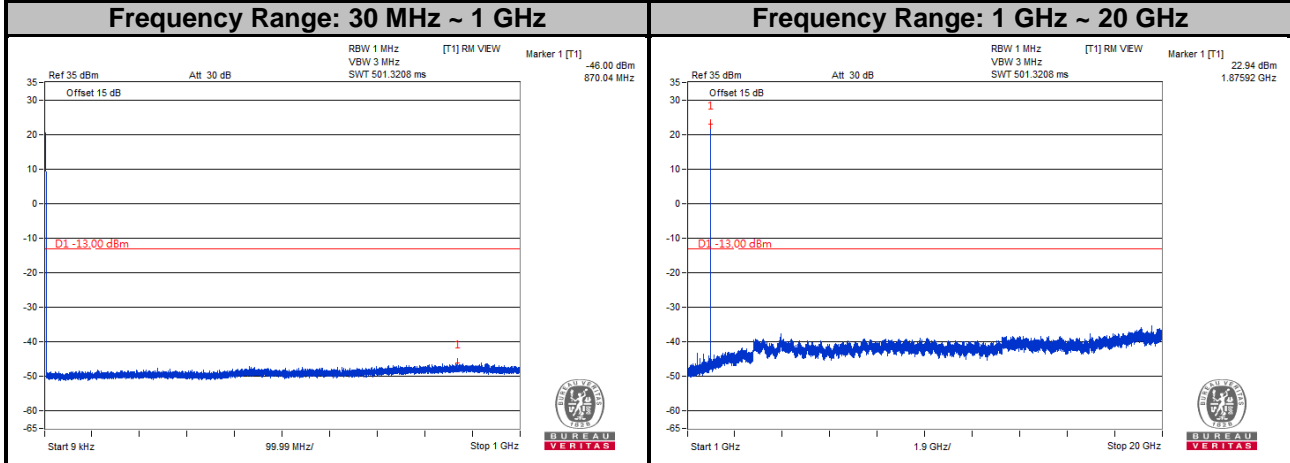

Channel 19150

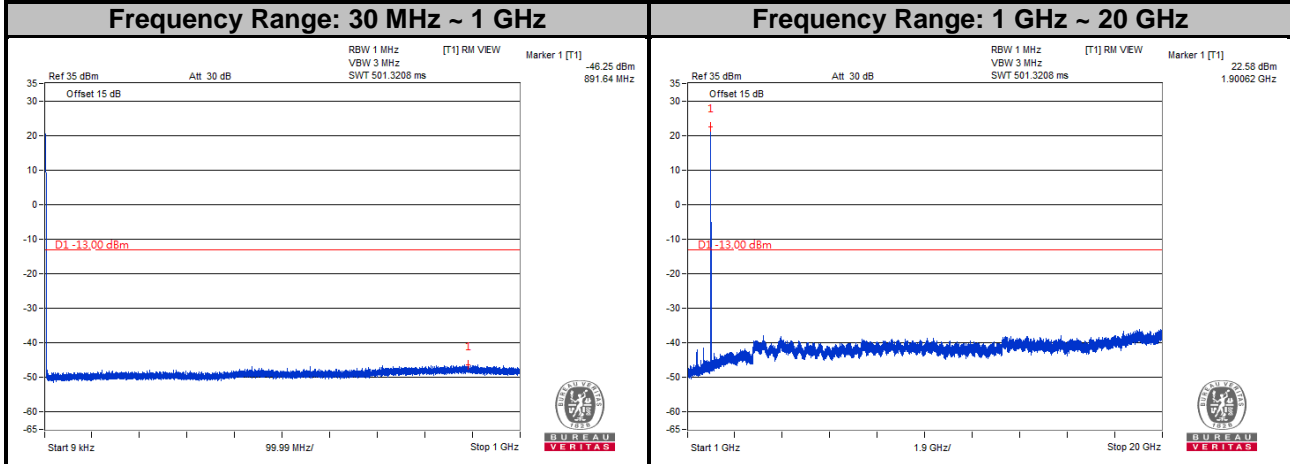

Note: The signal over the limit in 9 kHz is from spectrum analyzer.

LTE Band 2
Channel Bandwidth: 15 MHz
Channel 18675

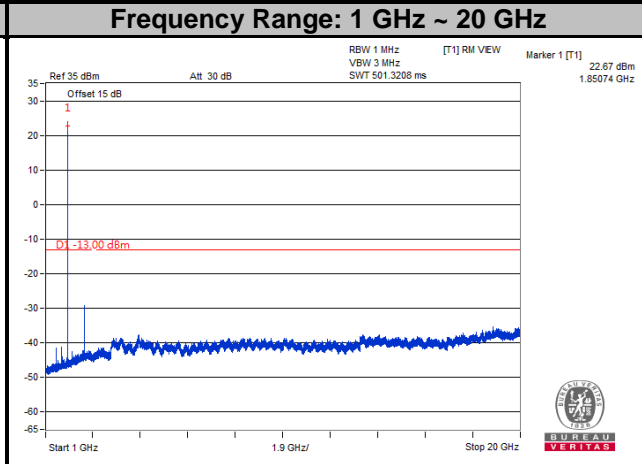
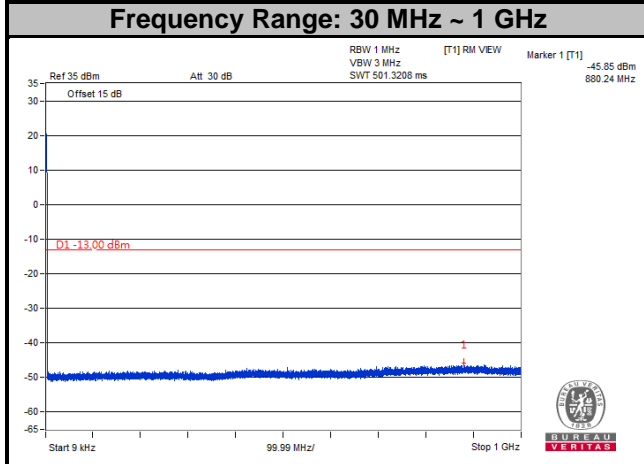

Channel 18900

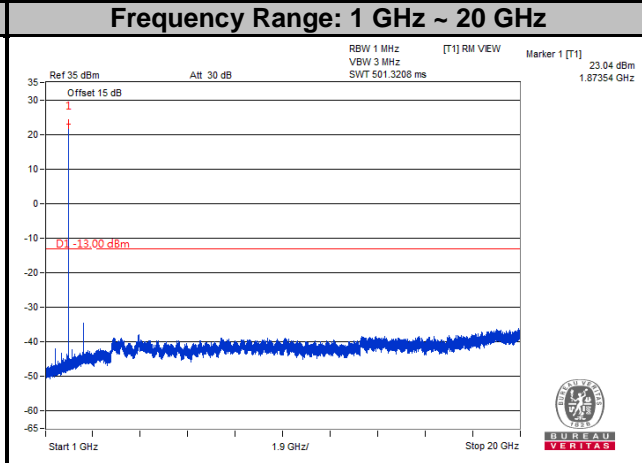
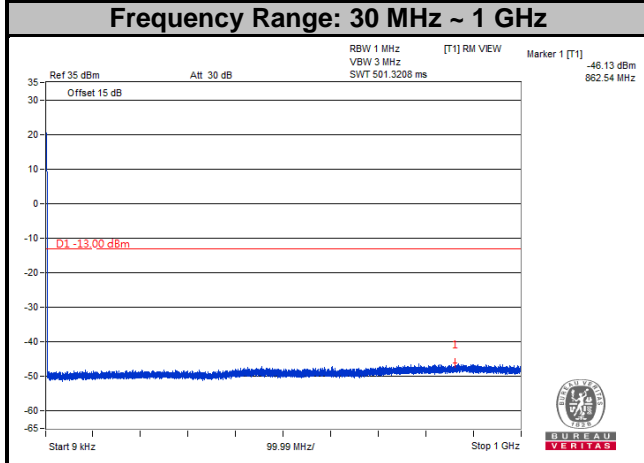

Channel 19125

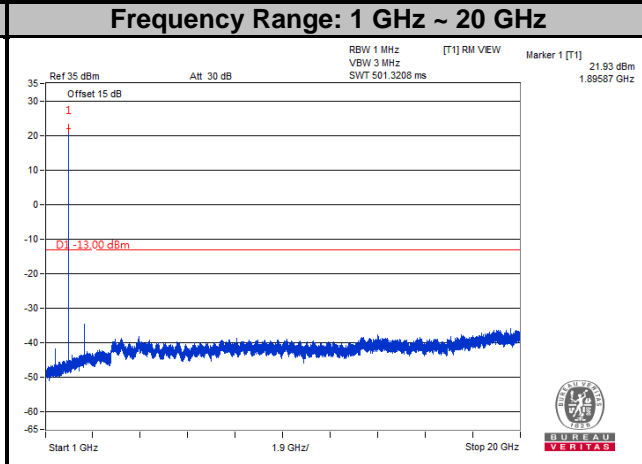
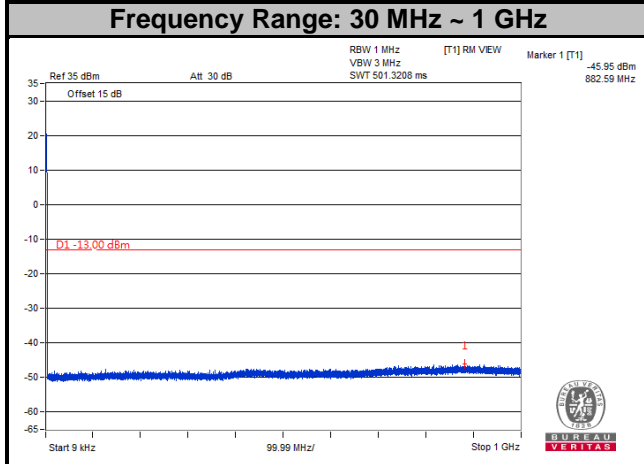

Note: The signal over the limit in 9 kHz is from spectrum analyzer.

LTE Band 2
Channel Bandwidth: 20 MHz
Channel 18700

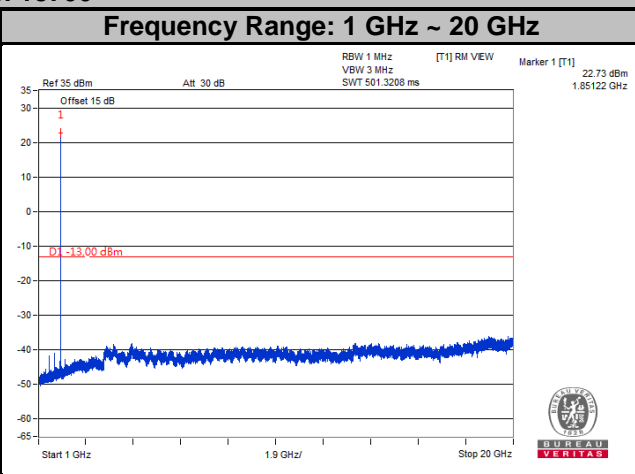
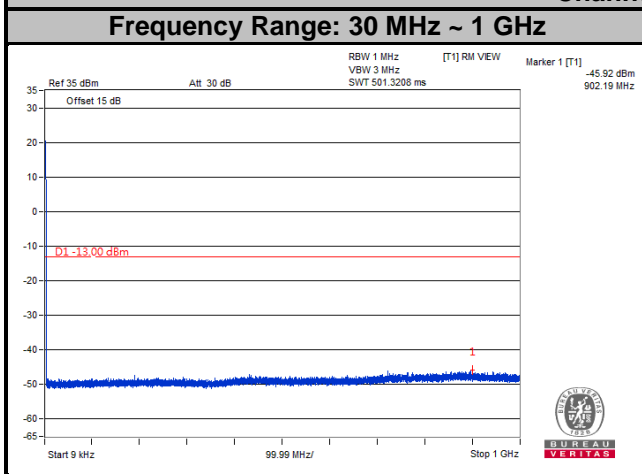

Channel 18900

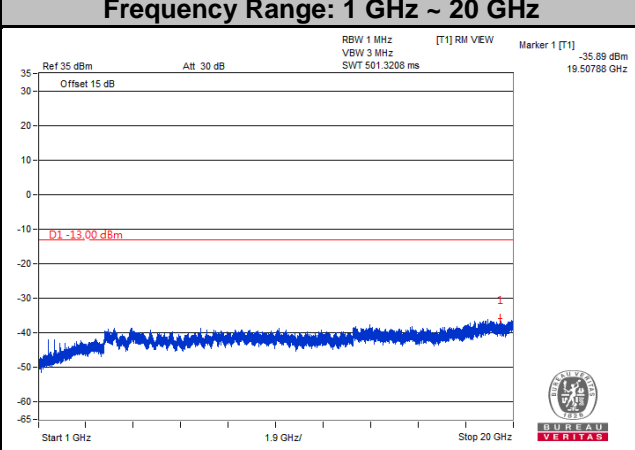
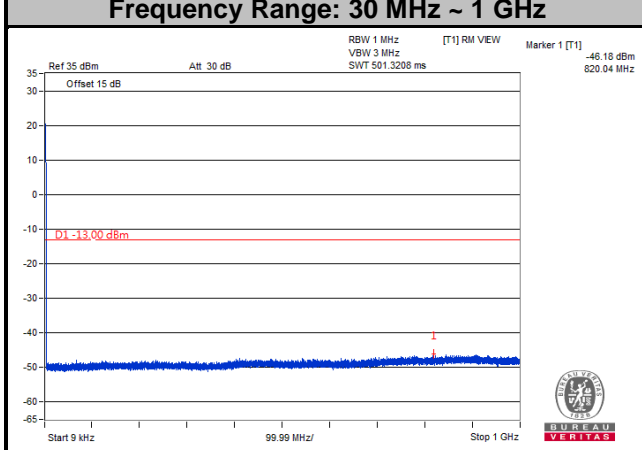

Channel 19100

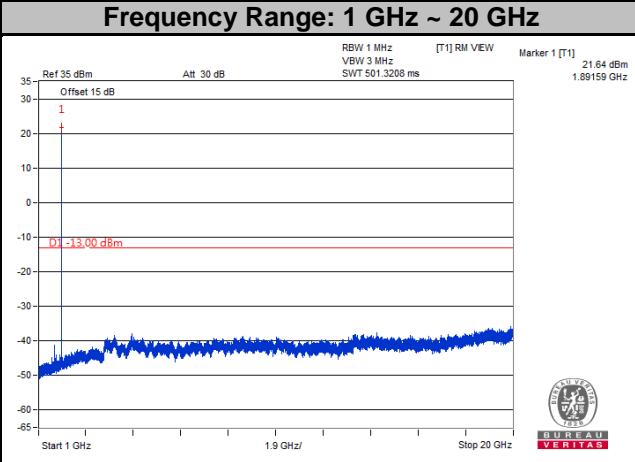
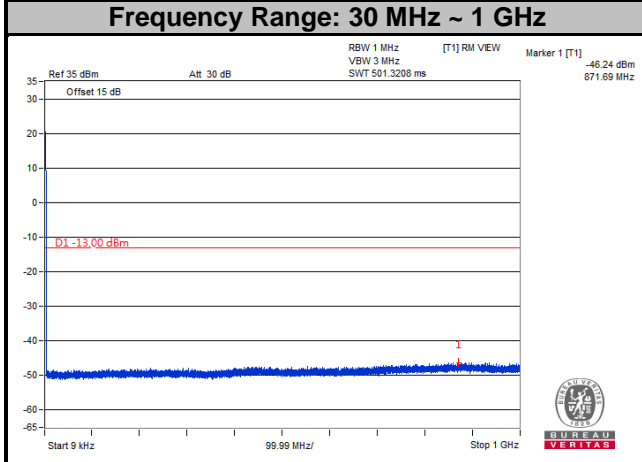

Note: The signal over the limit in 9 kHz is from spectrum analyzer.

LTE Band 25
Channel Bandwidth: 1.4 MHz
Channel 26047

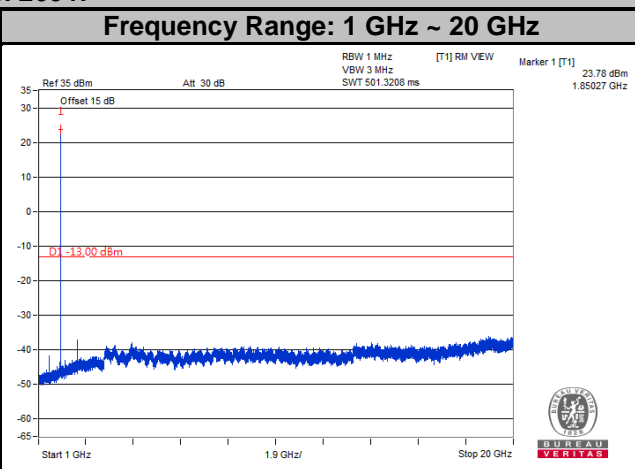
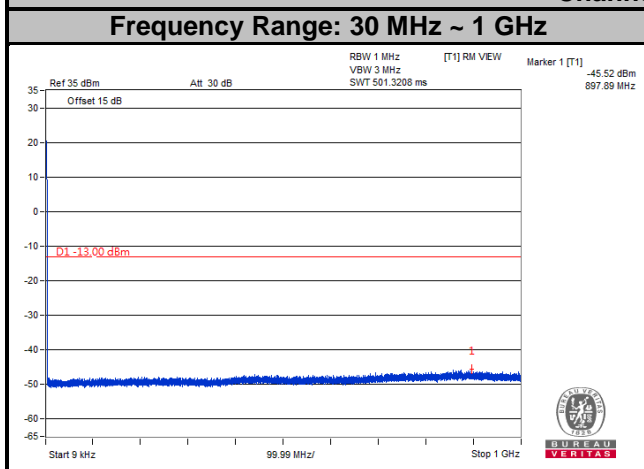

Channel 26365

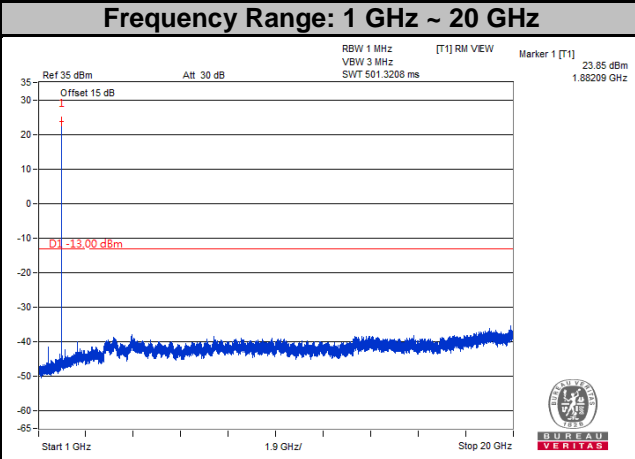
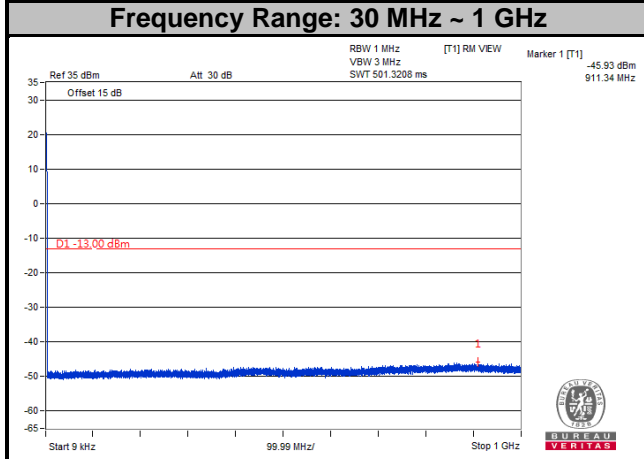

Channel 26683

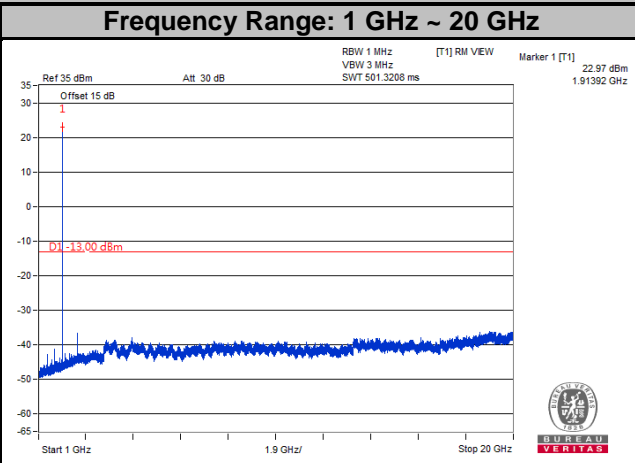
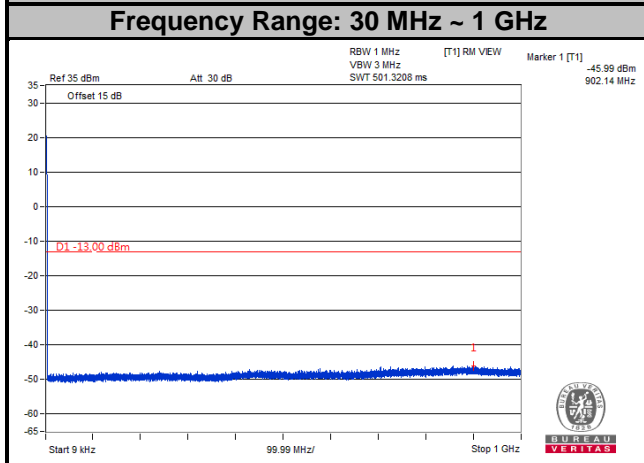

Note: The signal over the limit in 9 kHz is from spectrum analyzer.

LTE Band 25
Channel Bandwidth: 3 MHz
Channel 26055

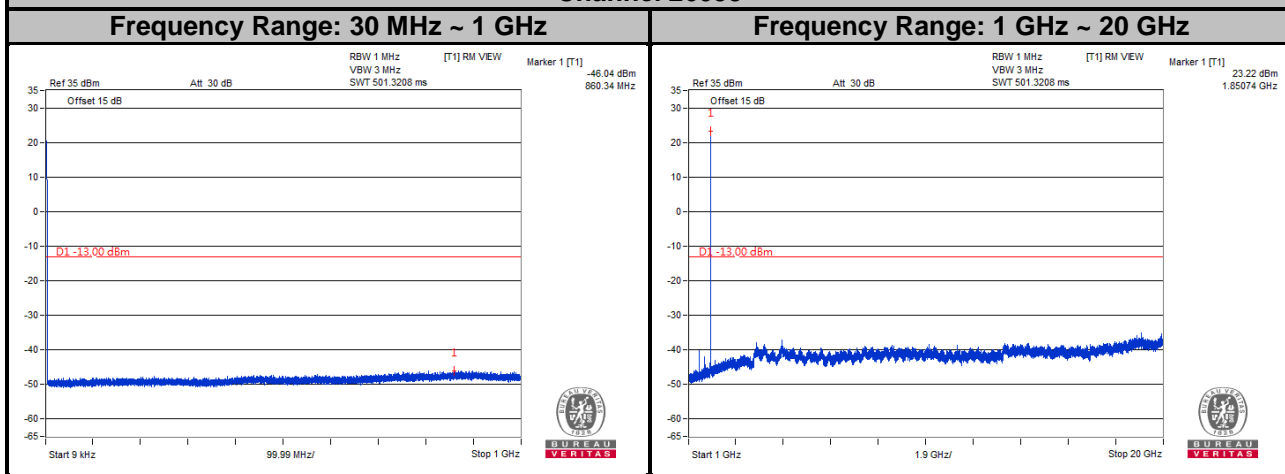

Channel 26365

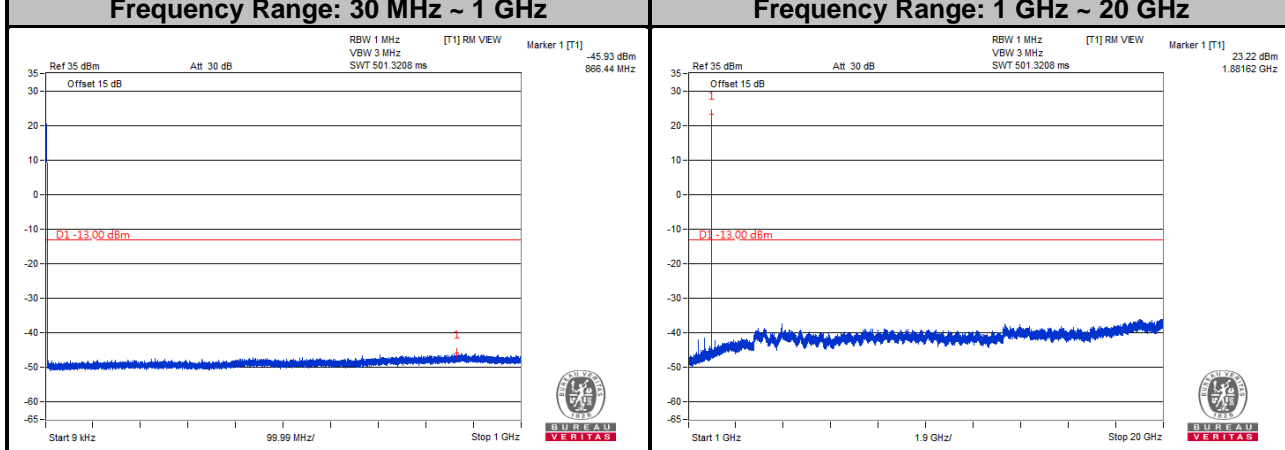

Channel 26675

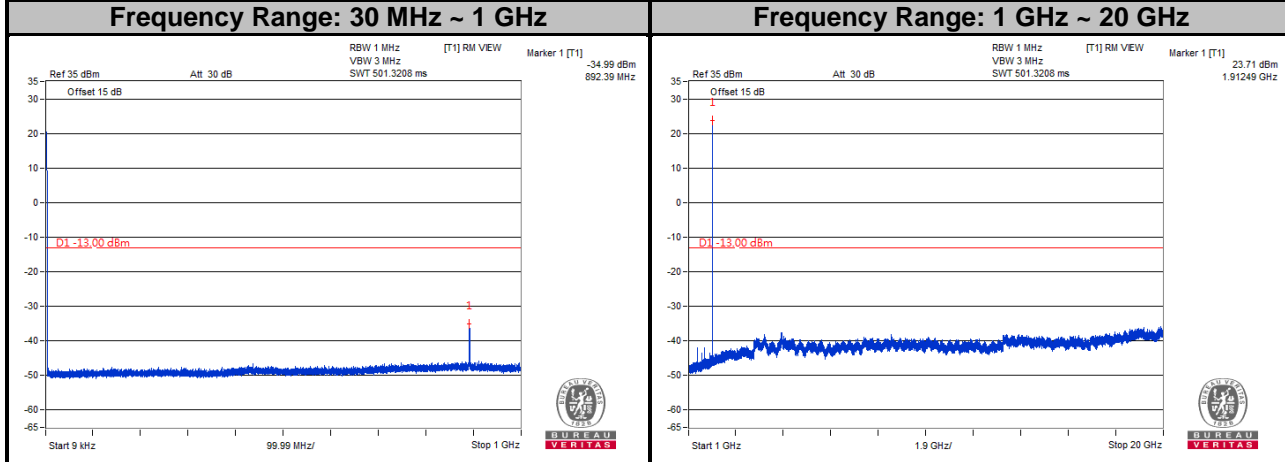

Note: The signal over the limit in 9 kHz is from spectrum analyzer.

LTE Band 25
Channel Bandwidth: 5 MHz
Channel 26065

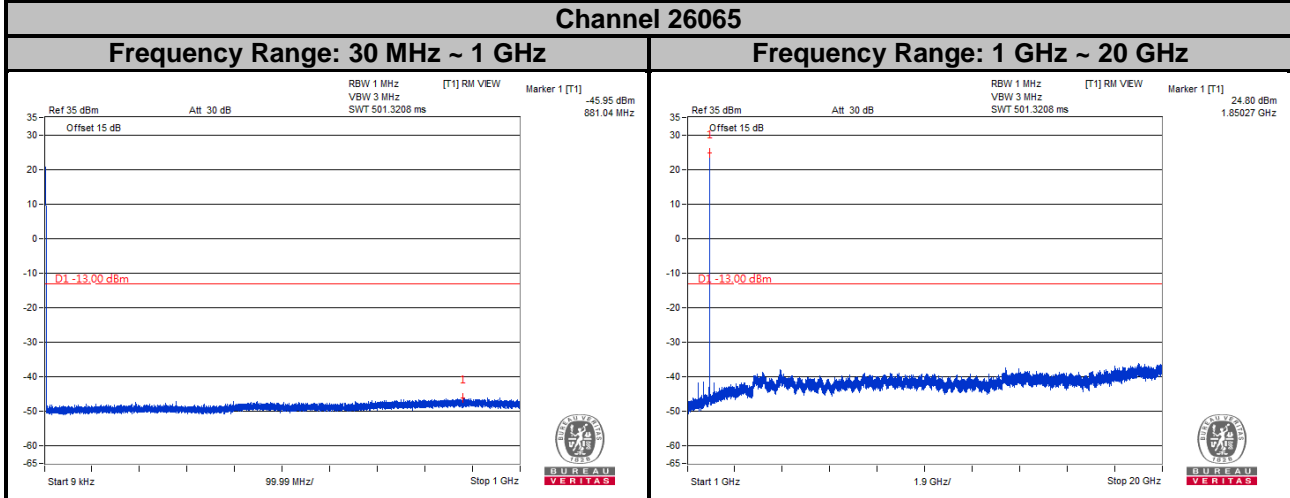

Channel 26365

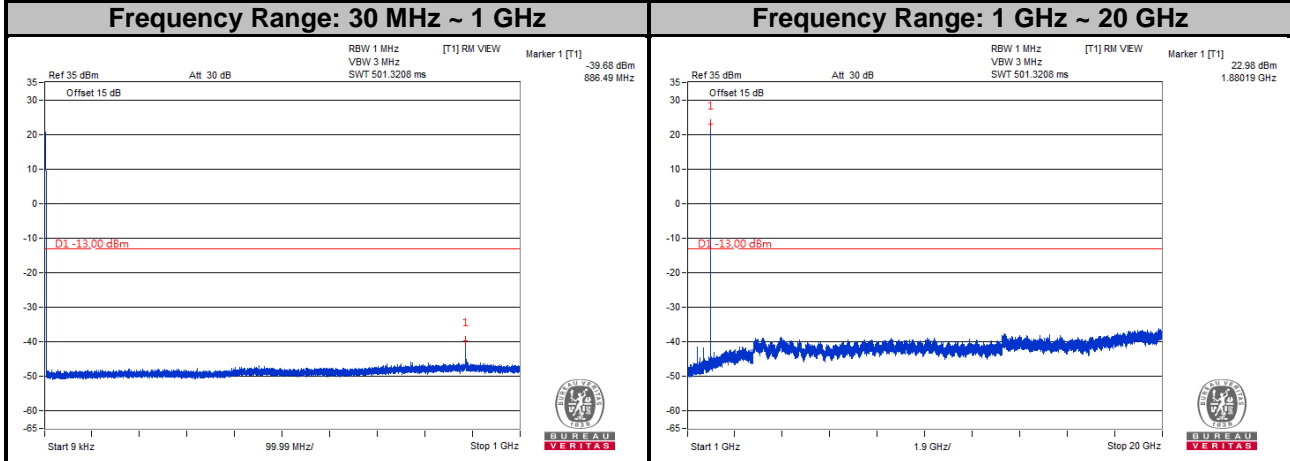

Channel 26665

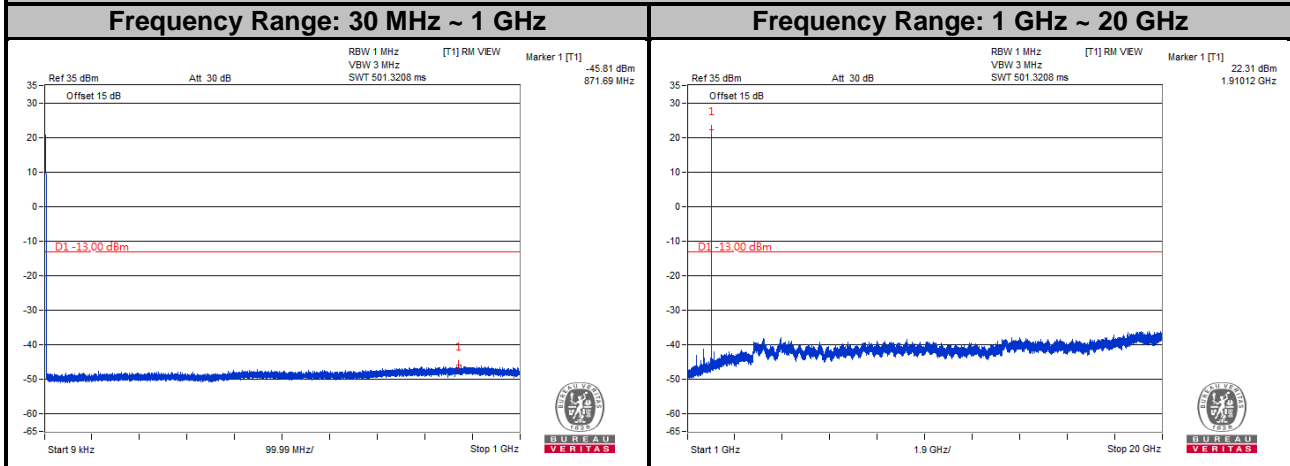

Note: The signal over the limit in 9 kHz is from spectrum analyzer.

LTE Band 25
Channel Bandwidth: 10 MHz
Channel 26090

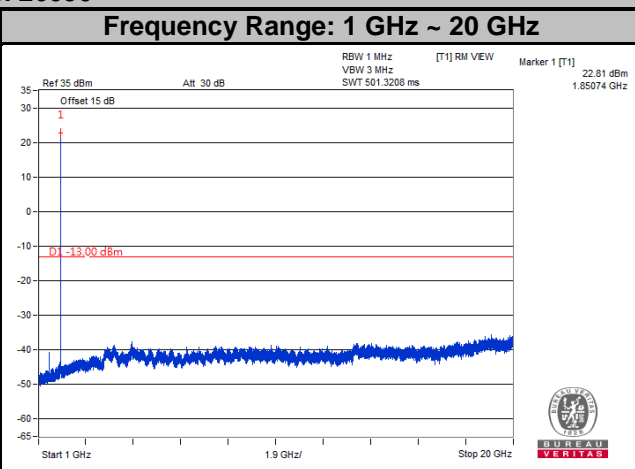
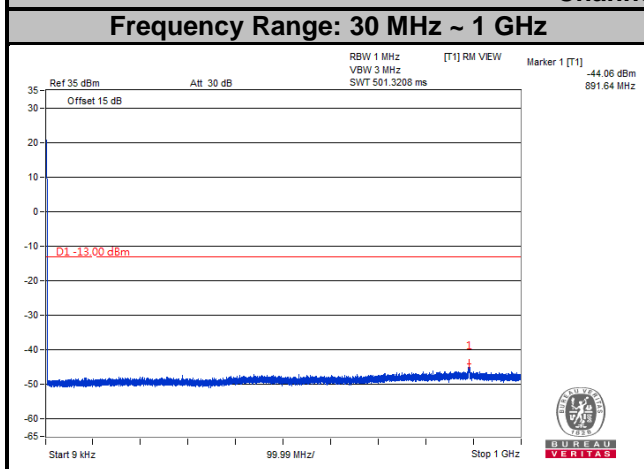

Channel 26365

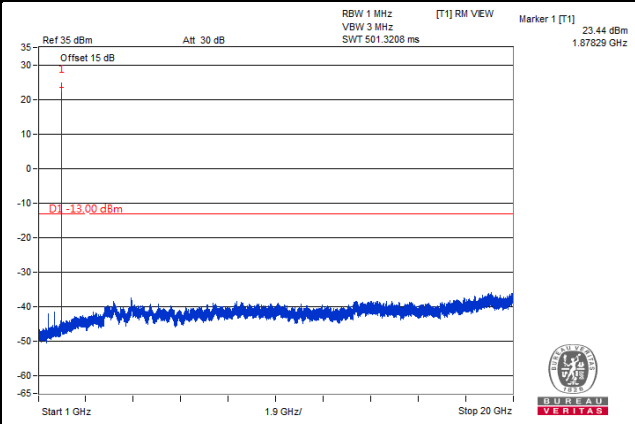
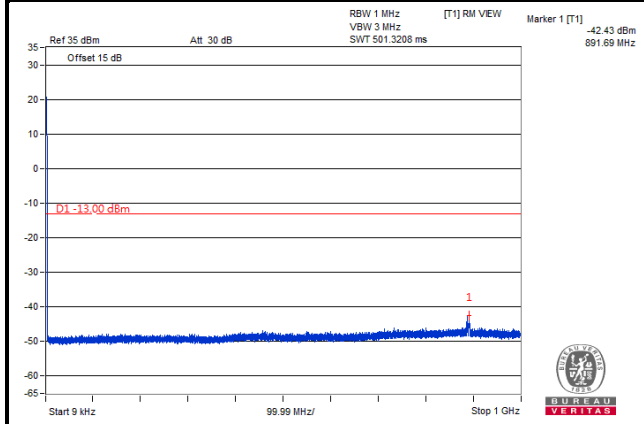

Channel 26640

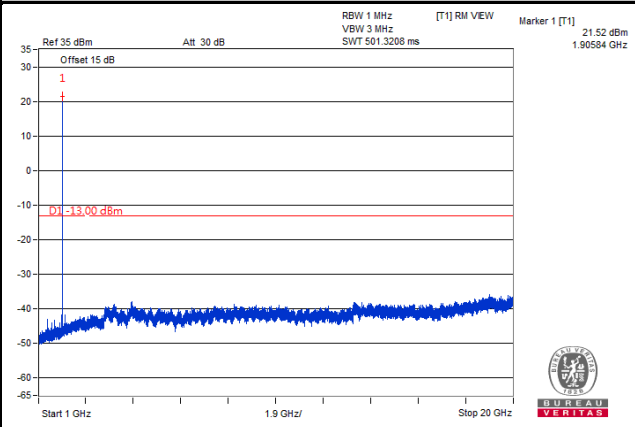
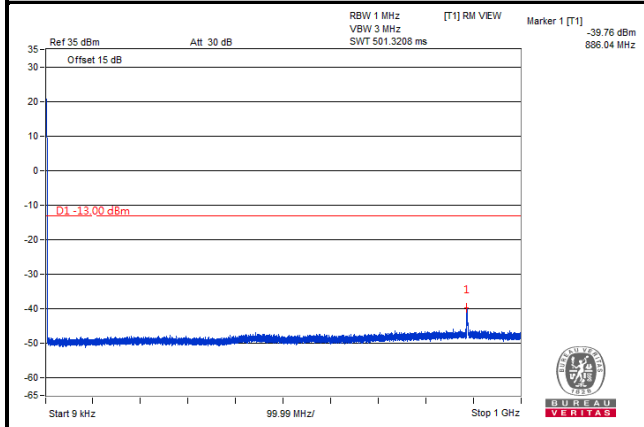

Note: The signal over the limit in 9 kHz is from spectrum analyzer.

LTE Band 25
Channel Bandwidth: 15 MHz
Channel 26115

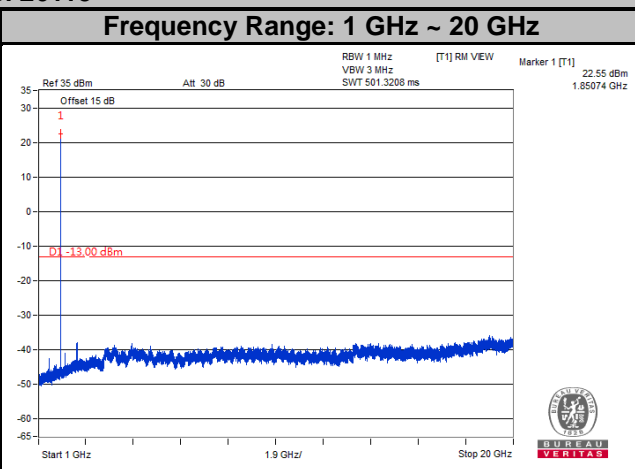
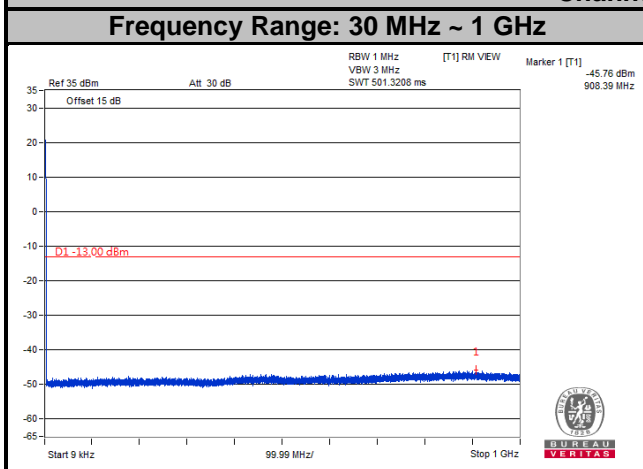

Channel 26365

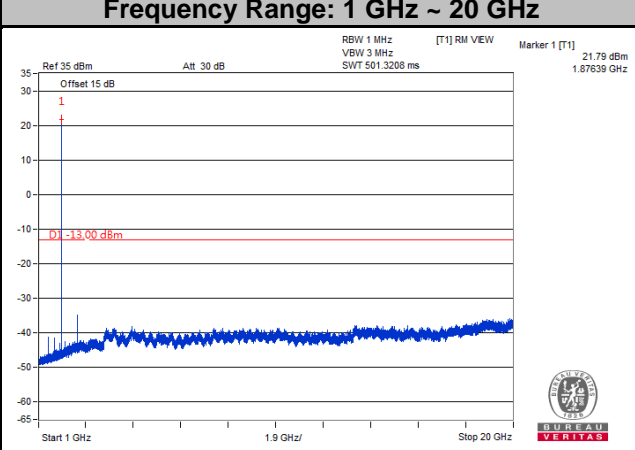
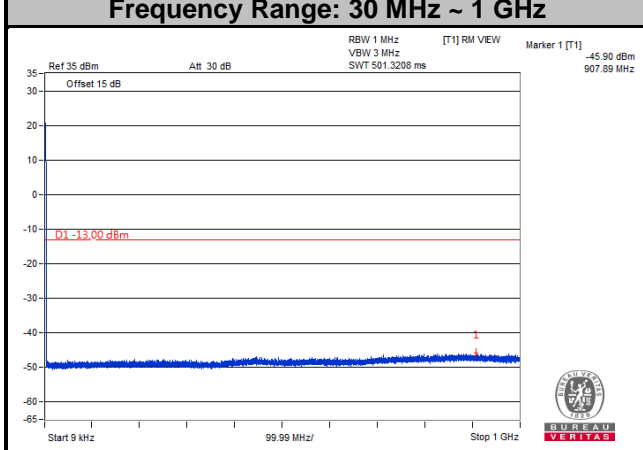

Channel 26615

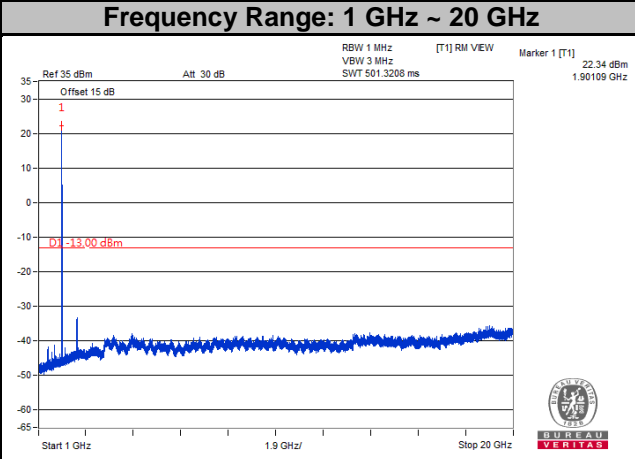
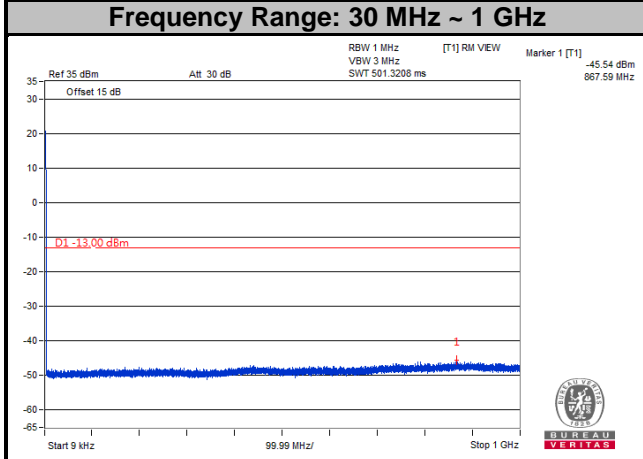

Note: The signal over the limit in 9 kHz is from spectrum analyzer.

LTE Band 25
Channel Bandwidth: 20 MHz
Channel 26140

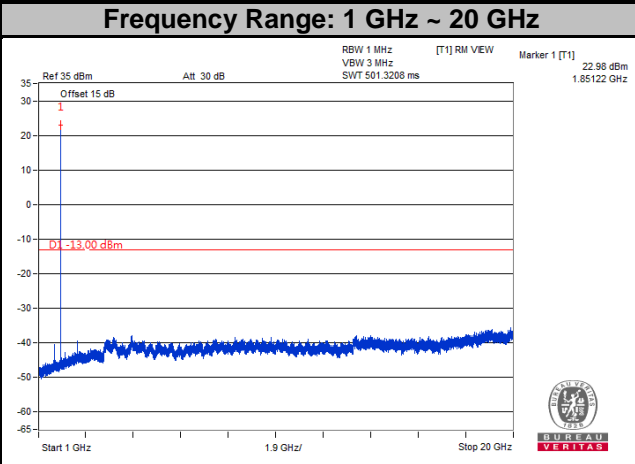
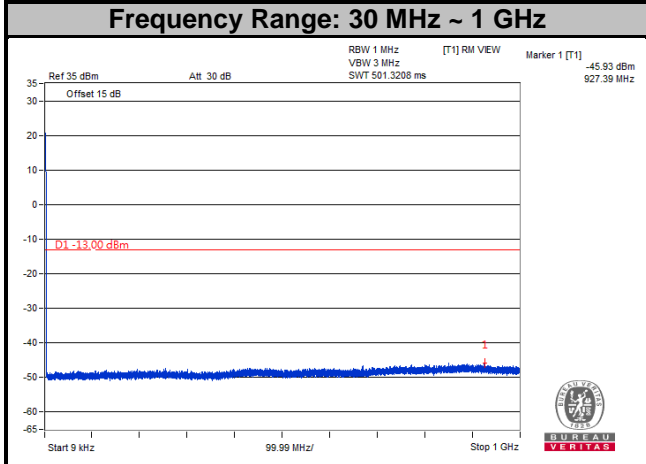

Channel 26365

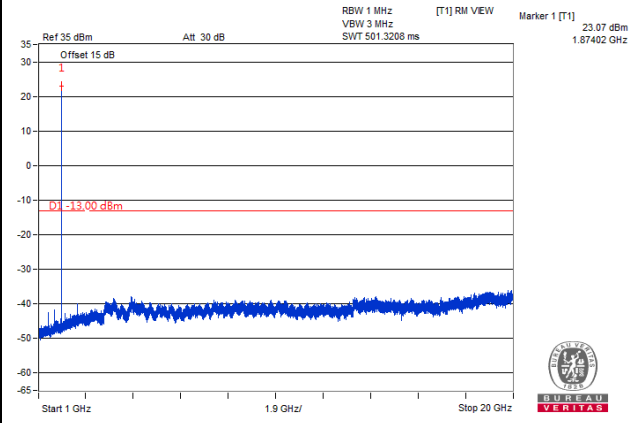
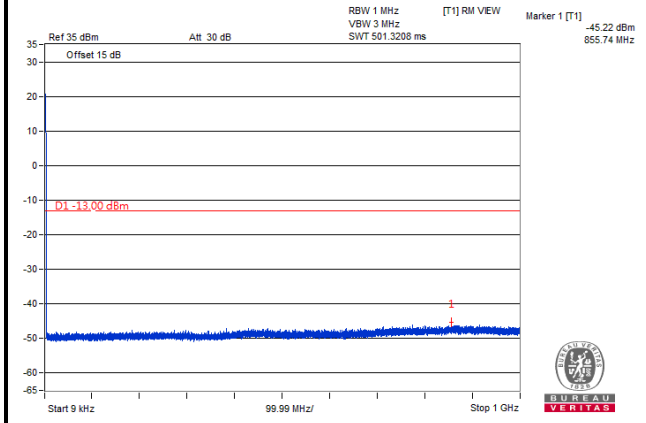

Channel 26590

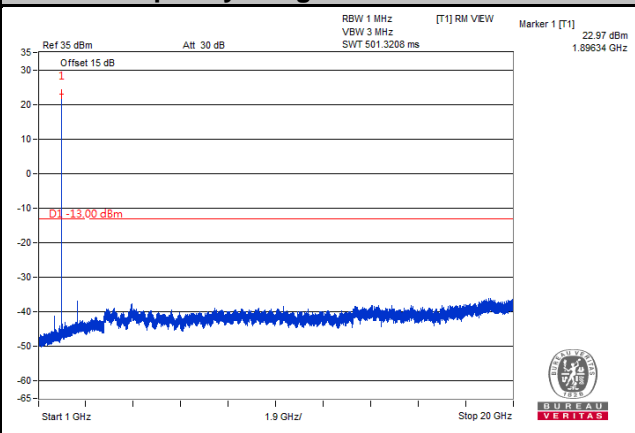
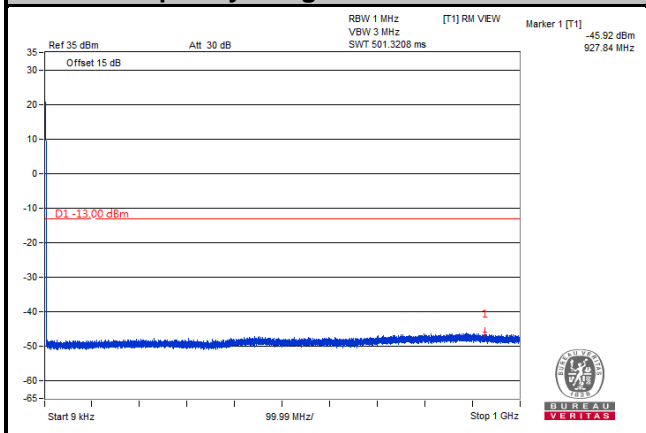

Note: The signal over the limit in 9 kHz is from spectrum analyzer.

NB-IoT

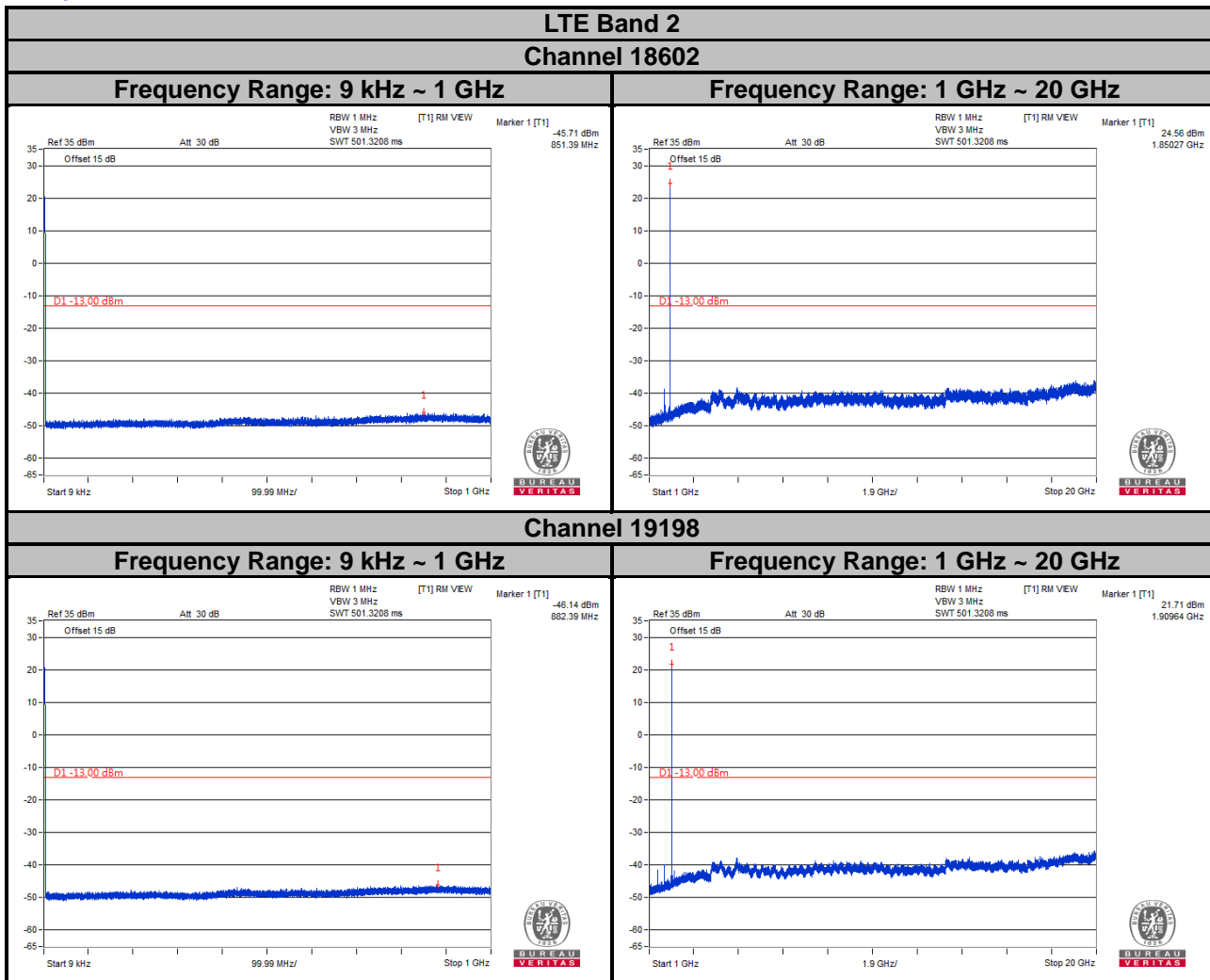

Note: The signal over the limit in 9 kHz is from spectrum analyzer.

**LTE Band 25
Channel 26042**

Frequency Range: 9 kHz ~ 1 GHz

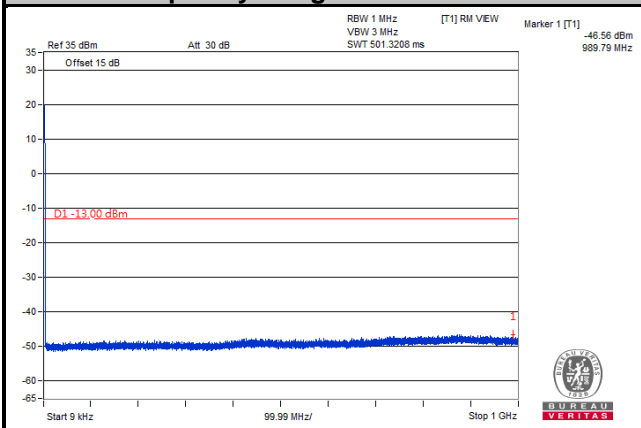

Frequency Range: 1 GHz ~ 20 GHz

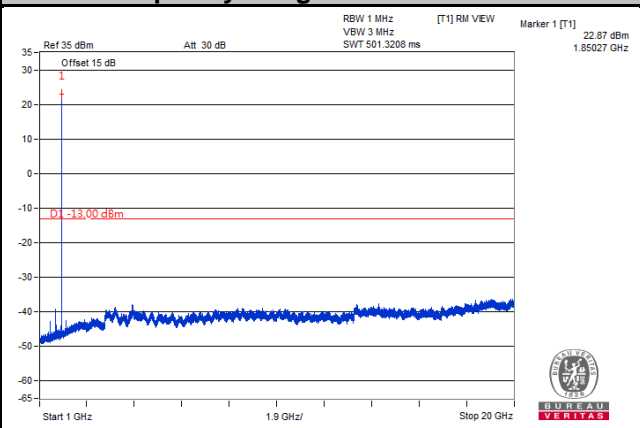

Channel 26365

Frequency Range: 9 kHz ~ 1 GHz

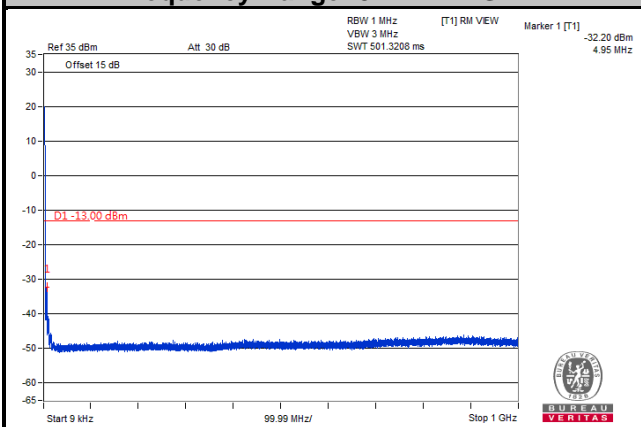

Frequency Range: 1 GHz ~ 20 GHz

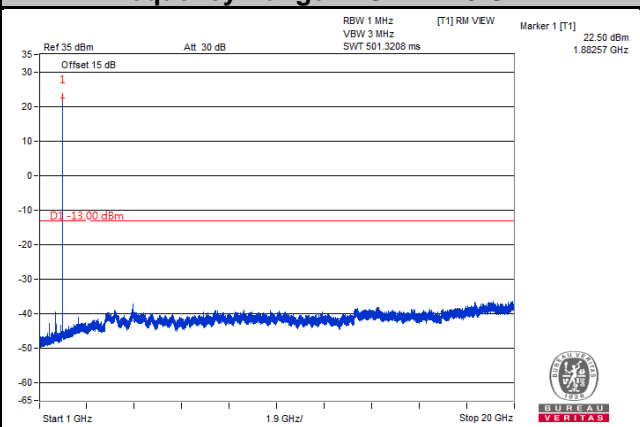

Channel 26688

Frequency Range: 9 kHz ~ 1 GHz

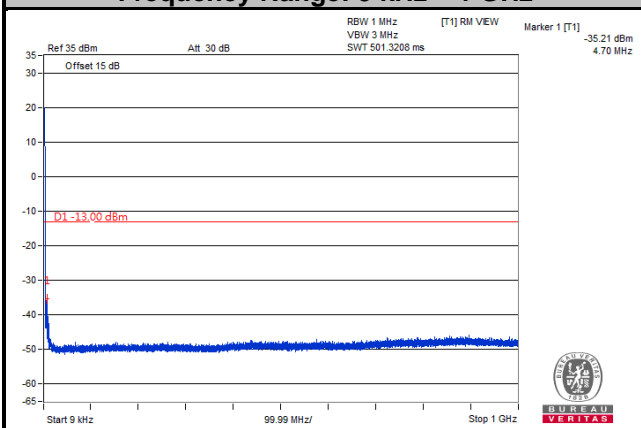

Frequency Range: 1 GHz ~ 20 GHz

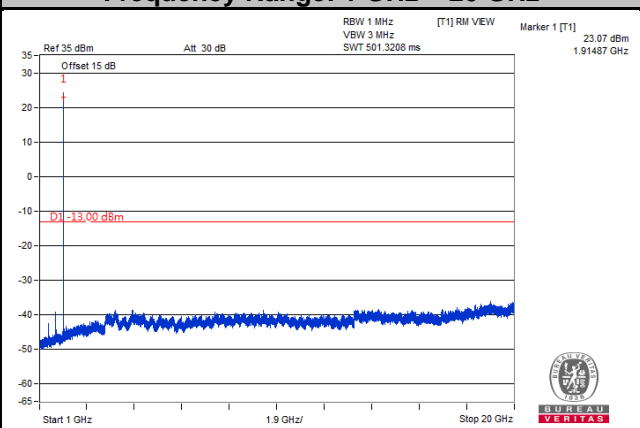

Note: The signal over the limit in 9 kHz is from spectrum analyzer.

4.8 Radiated Emission Measurement

4.8.1 Limits of Radiated Emission Measurement

The power of any emission outside of the authorized operating frequency ranges must be attenuated below the transmitting power (P) by a factor of at least $43 + 10 \log(P)$ dB. The emission limit is equal to -13 dBm.

4.8.2 Test Procedure

- a. Substitution method is used for E.I.R.P measurement. In the semi-anechoic chamber, EUT placed on the 0.8 m (below or equal 1 GHz) and/or 1.5 m (above 1 GHz) height of Turn Table, rotated the table around 360 degrees to search the maximum radiation power and receiver antenna shall be rotated vertical and horizontal polarization and moved height from 1 m to 4 m to find the maximum polar radiated power. The "Read Value" is the spectrum reading the maximum power value.
- b. The substitution horn antenna is substituted for EUT at the same position and signals generator export the CW signal to the substitution antenna via a TX cable. Rotated the Turn Table and moved receiving antenna to find the maximum radiation power. Adjust output power level of S.G to get a Value of spectrum reading equal to "Read Value" of step a. Record the power level of S.G.
- c. EIRP = Output power level of S.G – TX cable loss + Antenna gain of substitution horn.
- d. E.R.P power can be calculated form E.I.R.P power by subtracting the gain of dipole, E.R.P power = E.I.R.P power - 2.15 dB.

NOTE: The resolution bandwidth and video bandwidth of test receiver/spectrum analyzer is 1 MHz/3 MHz.

4.8.3 Deviation from Test Standard

No deviation.

4.8.4 Test Setup

<Radiated Emission below or equal 1 GHz>

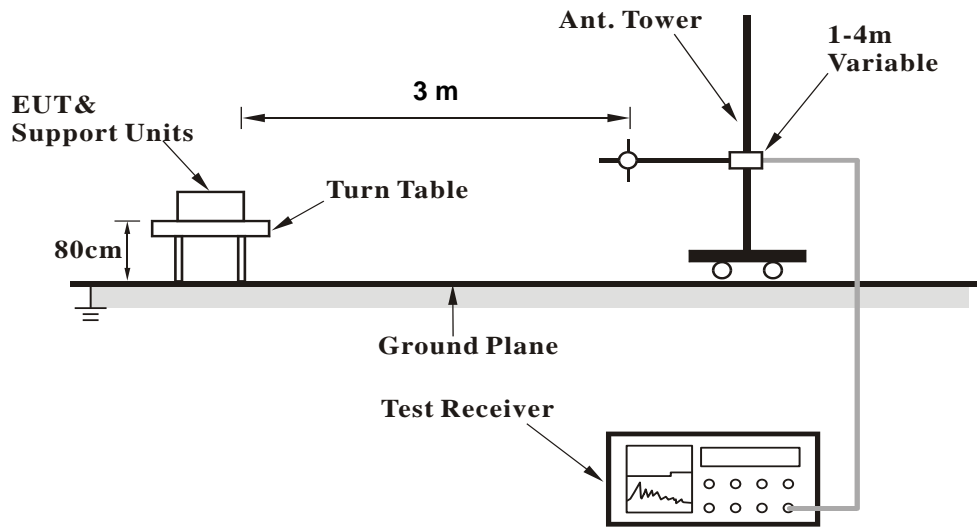

<Radiated Emission above 1 GHz>

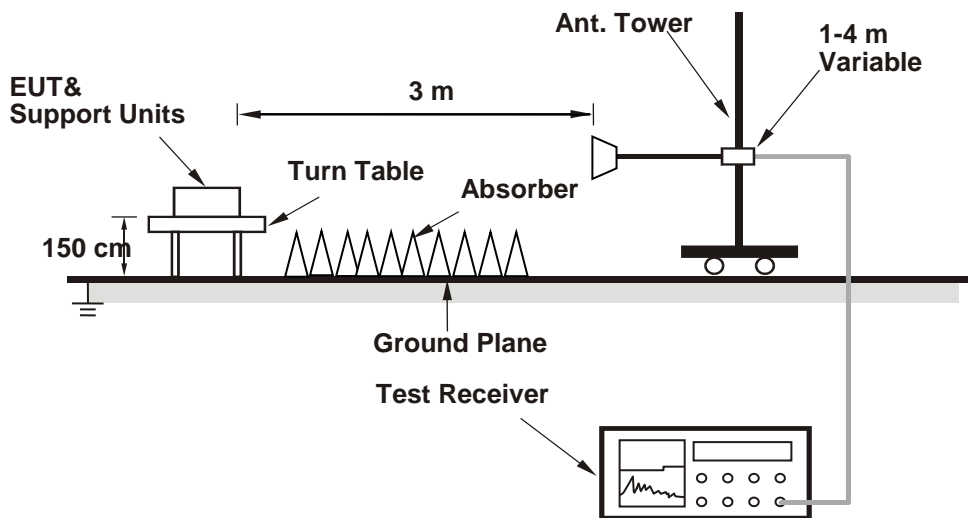

For the actual test configuration, please refer to the attached file (Test Setup Photo).

4.8.5 Test Results

Cat-M1

LTE Band 2

Channel Bandwidth: 1.4 MHz / QPSK

Low Channel



Bureau Veritas Consumer Products Services Ltd., Taoyuan Branch

A D T

Data: 3

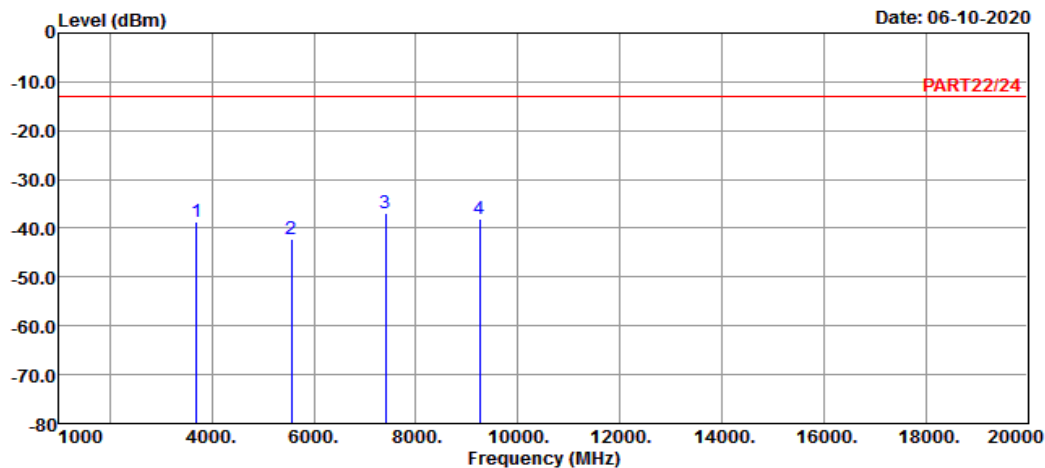

Site : 966 Chamber 5
 Condition: PART22/24 HORIZONTAL
 Remak : Cat-M1 Band 2 QPSK_1.4M Link_L-CH
 Tested by: Jisyong Wang

	Freq	Level	Read Level	Limit	Line Factor	Over Limit	Remark
	MHz	dBm	dBm	dBm	dB	dB	
1	3701.40	-38.65	-31.72	-13.00	-6.93	-25.65	Peak
2	5552.10	-42.11	-40.21	-13.00	-1.90	-29.11	Peak
3 pp	7402.80	-36.95	-41.06	-13.00	4.11	-23.95	Peak
4	9253.50	-38.03	-42.93	-13.00	4.90	-25.03	Peak



Bureau Veritas Consumer Products Services Ltd., Taoyuan Branch

A D T

Data: 4

Date: 06-10-2020

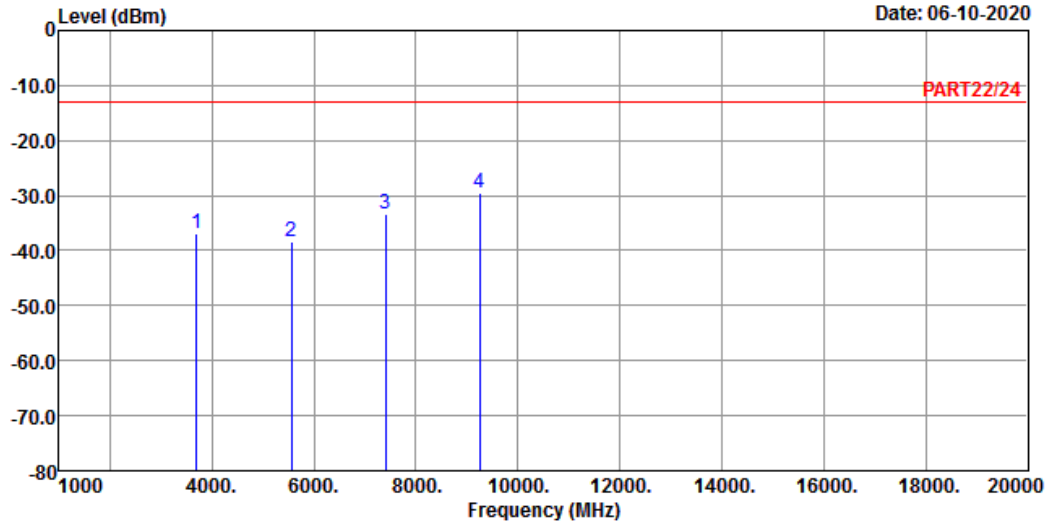

Site : 966 Chamber 5
 Condition: PART22/24 VERTICAL
 Remak : Cat-M1 Band 2 QPSK_1.4M Link_L-CH
 Tested by: Jisyoung Wang

	Freq	Level	Read Level	Limit Line	Over Factor	Limit	Remark
	MHz	dBm	dBm	dBm	dB	dB	
1	3701.40	-36.89	-29.96	-13.00	-6.93	-23.89	Peak
2	5552.10	-38.26	-36.36	-13.00	-1.90	-25.26	Peak
3	7402.80	-33.26	-37.37	-13.00	4.11	-20.26	Peak
4 pp	9253.50	-29.52	-34.42	-13.00	4.90	-16.52	Peak

Middle Channel



Bureau Veritas Consumer Products Services Ltd., Taoyuan Branch

A D T

Data: 3

Date: 06-10-2020

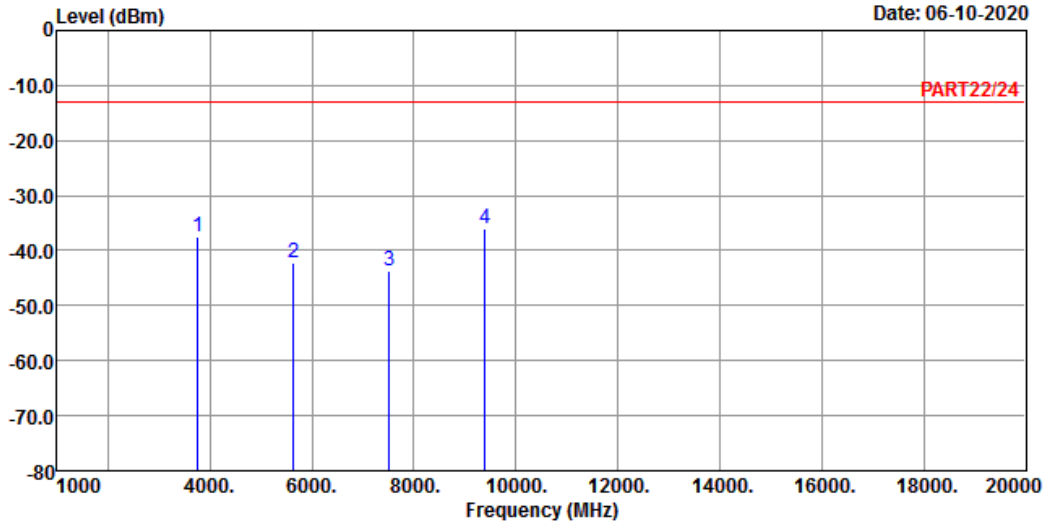

Site : 966 Chamber 5
 Condition: PART22/24 HORIZONTAL
 Remak : Cat-M1 Band 2 QPSK_1.4M Link_M-CH
 Tested by: Jisyong Wang

	Freq	Level	Read Level	Limit	Line Factor	Over Limit	Remark
	MHz	dBm	dBm	dBm	dB	dB	
1	3760.00	-37.46	-30.81	-13.00	-6.65	-24.46	Peak
2	5640.00	-42.23	-40.37	-13.00	-1.86	-29.23	Peak
3	7520.00	-43.62	-47.83	-13.00	4.21	-30.62	Peak
4 pp	9400.00	-36.11	-41.18	-13.00	5.07	-23.11	Peak



Bureau Veritas Consumer Products Services Ltd., Taoyuan Branch

A D T

Data: 4

Date: 06-10-2020

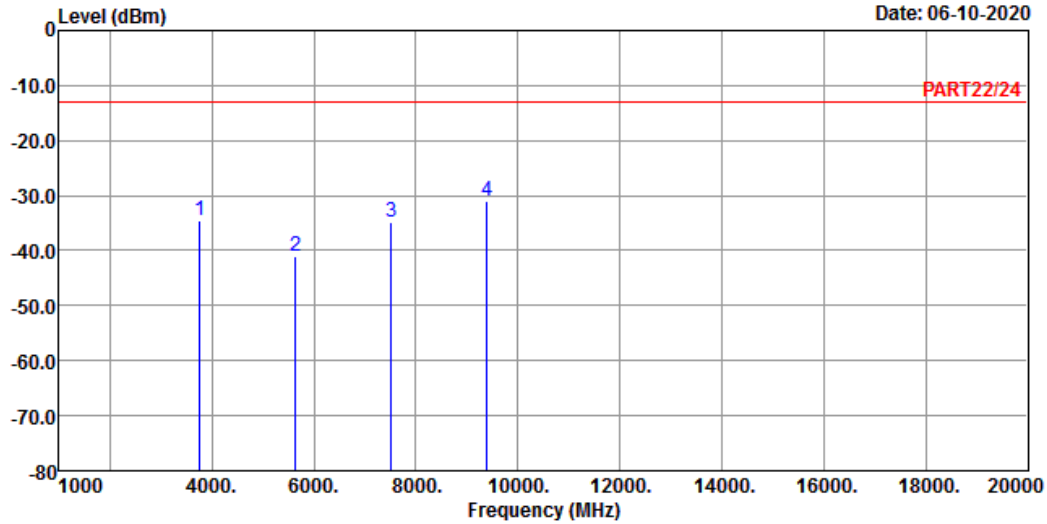

Site : 966 Chamber 5
 Condition: PART22/24 VERTICAL
 Remak : Cat-M1 Band 2 QPSK_1.4M Link_M-CH
 Tested by: Jisyong Wang

	Freq	Level	Read Level	Limit	Line	Factor	Over Limit	Remark
	MHz	dBm	dBm	dBm		dB	dB	
1	3760.00	-34.65	-28.00	-13.00		-6.65	-21.65	Peak
2	5640.00	-41.11	-39.25	-13.00		-1.86	-28.11	Peak
3	7520.00	-34.85	-39.06	-13.00		4.21	-21.85	Peak
4 pp	9400.00	-31.11	-36.18	-13.00		5.07	-18.11	Peak

High Channel



Bureau Veritas Consumer Products Services Ltd., Taoyuan Branch

A D T

Data: 3

Date: 06-10-2020

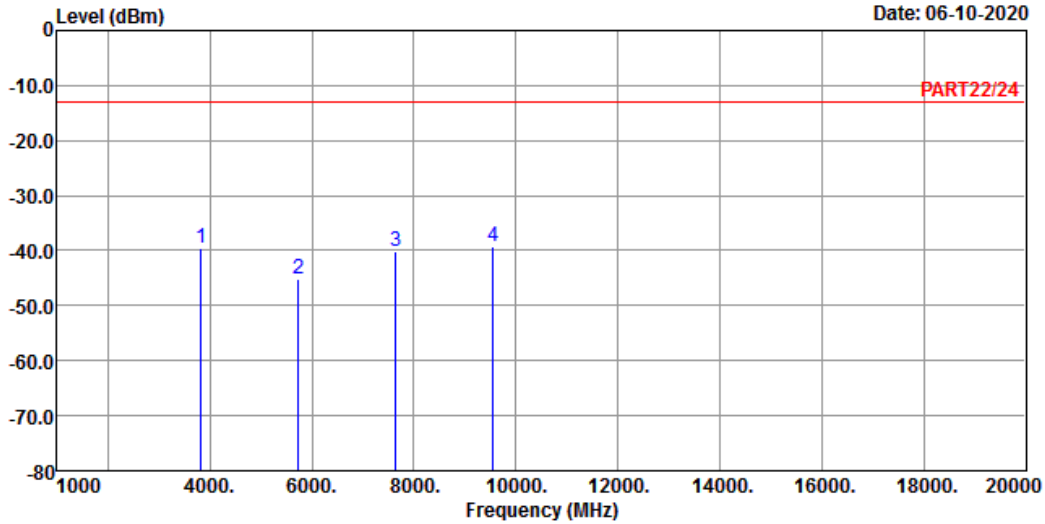

Site : 966 Chamber 5
 Condition: PART22/24 HORIZONTAL
 Remak : Cat-M1 Band 2 QPSK_1.4M Link_H-CH
 Tested by: Jisyong Wang

	Freq	Level	Read Level	Limit	Line Factor	Over Limit	Remark
	MHz	dBm	dBm	dBm	dB	dB	
1	3818.60	-39.52	-33.12	-13.00	-6.40	-26.52	Peak
2	5727.90	-45.16	-43.51	-13.00	-1.65	-32.16	Peak
3	7637.20	-40.13	-44.68	-13.00	4.55	-27.13	Peak
4 pp	9546.50	-39.12	-44.51	-13.00	5.39	-26.12	Peak



Bureau Veritas Consumer Products Services Ltd., Taoyuan Branch

A D T

Data: 4

Date: 06-10-2020

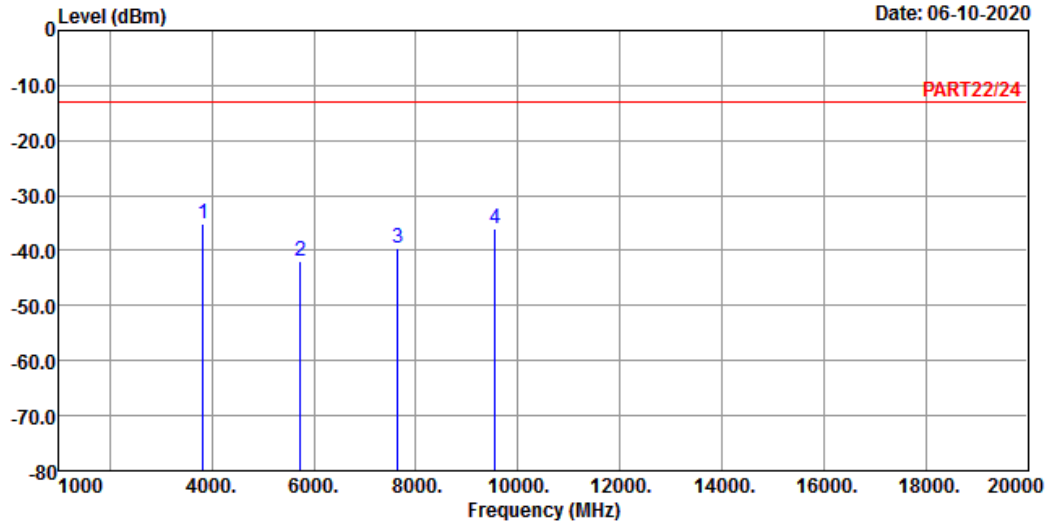

Site : 966 Chamber 5
 Condition: PART22/24 VERTICAL
 Remak : Cat-M1 Band 2 QPSK_1.4M Link_H-CH
 Tested by: Jisyong Wang

	Freq	Level	Read Level	Limit	Line Factor	Over Limit	Remark
	MHz	dBm	dBm	dBm	dB	dB	
1 pp	3816.60	-35.26	-28.86	-13.00	-6.40	-22.26	Peak
2	5727.90	-42.02	-40.37	-13.00	-1.65	-29.02	Peak
3	7637.20	-39.56	-44.11	-13.00	4.55	-26.56	Peak
4	9546.50	-36.11	-41.50	-13.00	5.39	-23.11	Peak

Channel Bandwidth: 5 MHz / QPSK
Low Channel



Bureau Veritas Consumer Products Services Ltd., Taoyuan Branch

A D T

Data: 3

Date: 06-10-2020

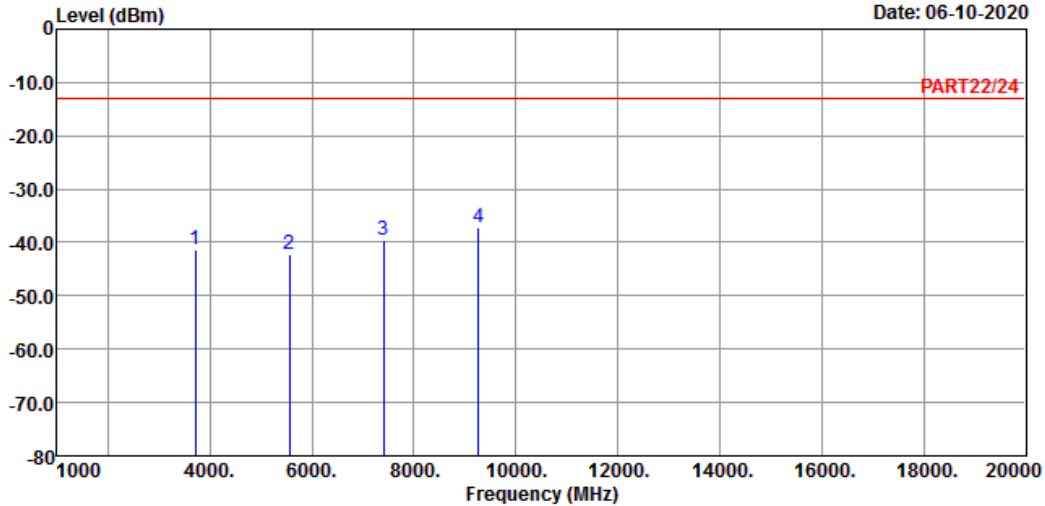

Site : 966 Chamber 5
Condition: PART22/24 HORIZONTAL
Remak : Cat-M1 Band 2 QPSK_5M Link_L-CH
Tested by: Jisyong Wang

	Freq	Level	Read Level	Limit	Line	Factor	Over Limit	Remark
	MHz	dBm	dBm	dBm		dB	dB	
1	3705.00	-41.31	-34.38	-13.00		-6.93	-28.31	Peak
2	5557.50	-42.26	-40.35	-13.00		-1.91	-29.26	Peak
3	7410.00	-39.52	-43.65	-13.00		4.13	-26.52	Peak
4 pp	9262.50	-37.11	-42.01	-13.00		4.90	-24.11	Peak



Bureau Veritas Consumer Products Services Ltd., Taoyuan Branch

A D T

Data: 4

Date: 06-10-2020

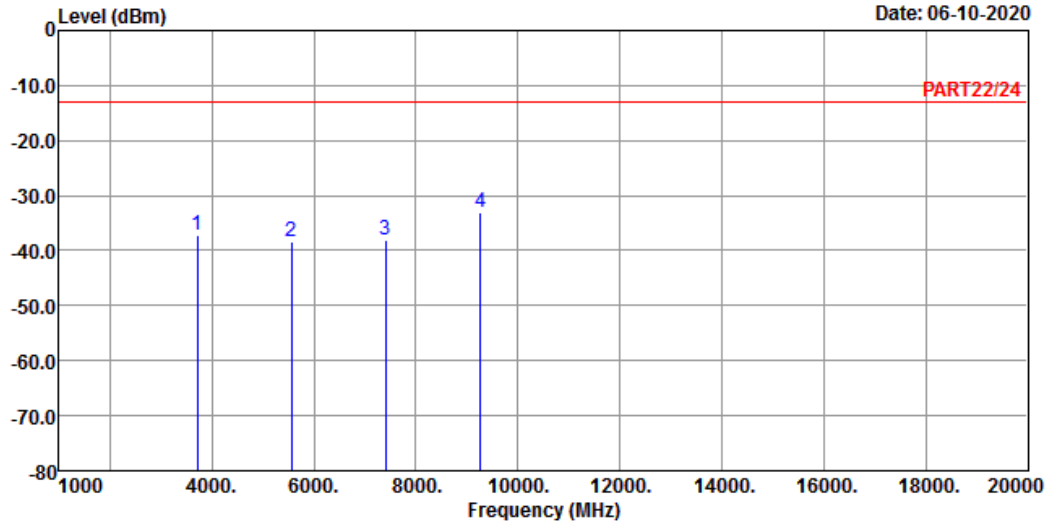

Site : 966 Chamber 5
 Condition: PART22/24 VERTICAL
 Remak : Cat-M1 Band 2 QPSK_5M Link_L-CH
 Tested by: Jisyoung Wang

	Freq	Level	Read Level	Limit	Line	Factor	Over Limit	Remark
	MHz	dBm	dBm	dBm		dB	dB	
1	3705.00	-37.11	-30.18	-13.00		-6.93	-24.11	Peak
2	5557.50	-38.26	-36.35	-13.00		-1.91	-25.26	Peak
3	7410.00	-38.11	-42.24	-13.00		4.13	-25.11	Peak
4 pp	9262.50	-33.11	-38.01	-13.00		4.90	-20.11	Peak

Middle Channel



Bureau Veritas Consumer Products Services Ltd., Taoyuan Branch

A D T

Data: 3

Date: 2020-06-10

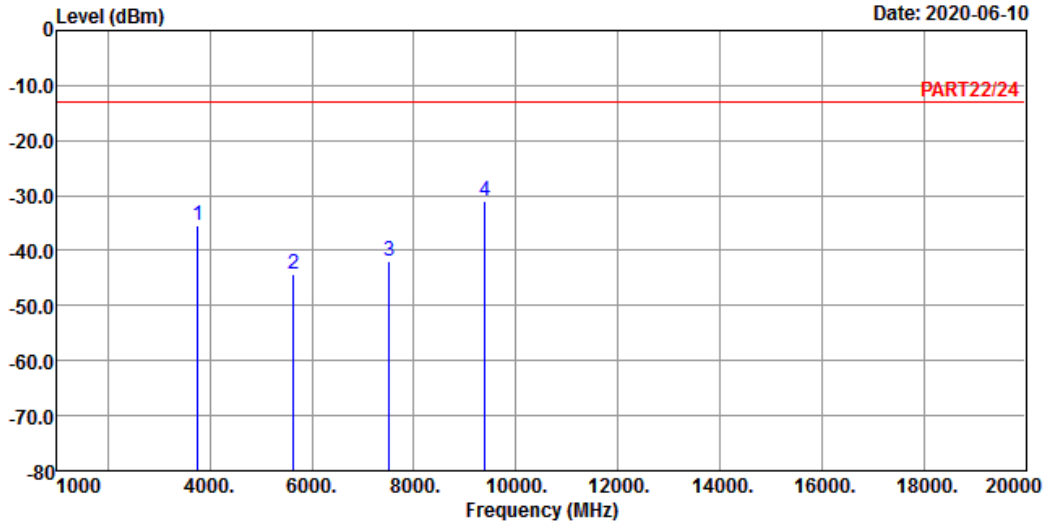

Site : 966 Chamber 5
 Condition: PART22/24 HORIZONTAL
 Remak : Cat-M1 Band 2 QPSK_5M Link_M-CH
 Tested by: Jisyong Wang

	Freq	Level	Read Level	Limit	Line Factor	Over Limit	Remark
	MHz	dBm	dBm	dBm	dB	dB	
1	3760.00	-35.56	-28.91	-13.00	-6.65	-22.56	Peak
2	5640.00	-44.23	-42.37	-13.00	-1.86	-31.23	Peak
3	7520.00	-41.99	-46.20	-13.00	4.21	-28.99	Peak
4 pp	9400.00	-31.11	-36.18	-13.00	5.07	-18.11	Peak



Bureau Veritas Consumer Products Services Ltd., Taoyuan Branch

A D T

Data: 4

Date: 2020-06-10

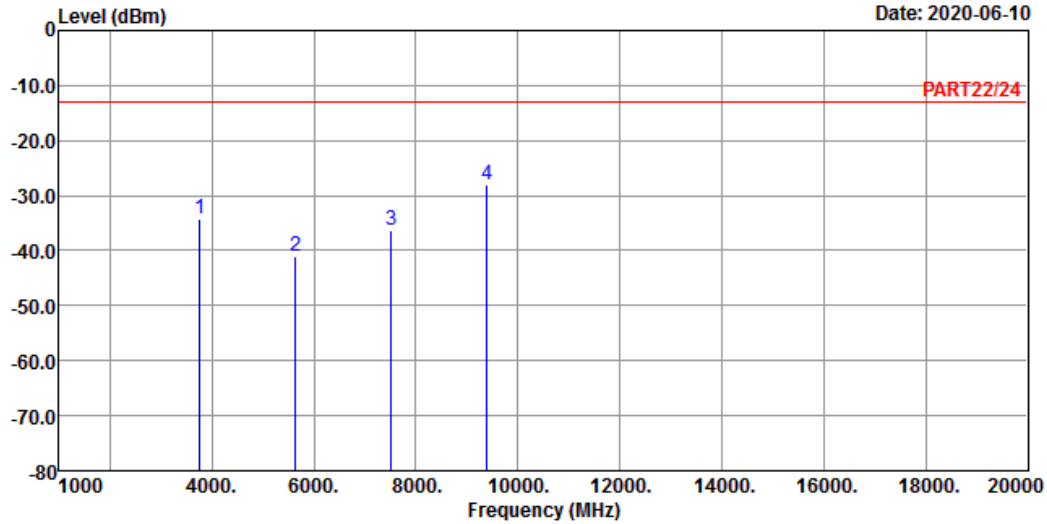

Site : 966 Chamber 5
 Condition: PART22/24 VERTICAL
 Remak : Cat-M1 Band 2 QPSK_5M Link_M-CH
 Tested by: Jisyoung Wang

	Freq	Level	Read Level	Limit	Line	Factor	Over Limit	Remark
	MHz	dBm	dBm	dBm		dB	dB	
1	3760.00	-34.26	-27.61	-13.00	-6.65	-21.26	Peak	
2	5640.00	-41.11	-39.25	-13.00	-1.86	-28.11	Peak	
3	7520.00	-36.29	-40.50	-13.00	4.21	-23.29	Peak	
4 pp	9400.00	-28.16	-33.23	-13.00	5.07	-15.16	Peak	

High Channel



Bureau Veritas Consumer Products Services Ltd., Taoyuan Branch

A D T

Data: 3

Date: 06-10-2020

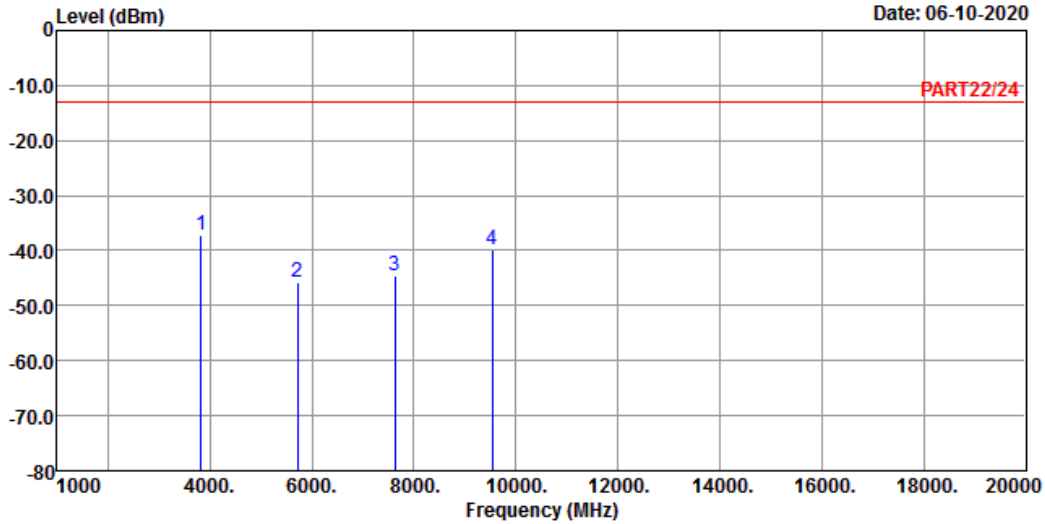

Site : 966 Chamber 5
 Condition: PART22/24 HORIZONTAL
 Remak : Cat-M1 Band 2 QPSK_5M Link_H-CH
 Tested by: Jisyong Wang

	Freq	Level	Read Level	Limit	Line Factor	Over Limit	Remark
	MHz	dBm	dBm	dBm	dB	dB	
1 pp	3815.00	-37.26	-30.86	-13.00	-6.40	-24.26	Peak
2	5722.50	-45.62	-43.93	-13.00	-1.69	-32.62	Peak
3	7630.00	-44.65	-49.16	-13.00	4.51	-31.65	Peak
4	9537.50	-39.85	-45.24	-13.00	5.39	-26.85	Peak



Bureau Veritas Consumer Products Services Ltd., Taoyuan Branch

A D T

Data: 4

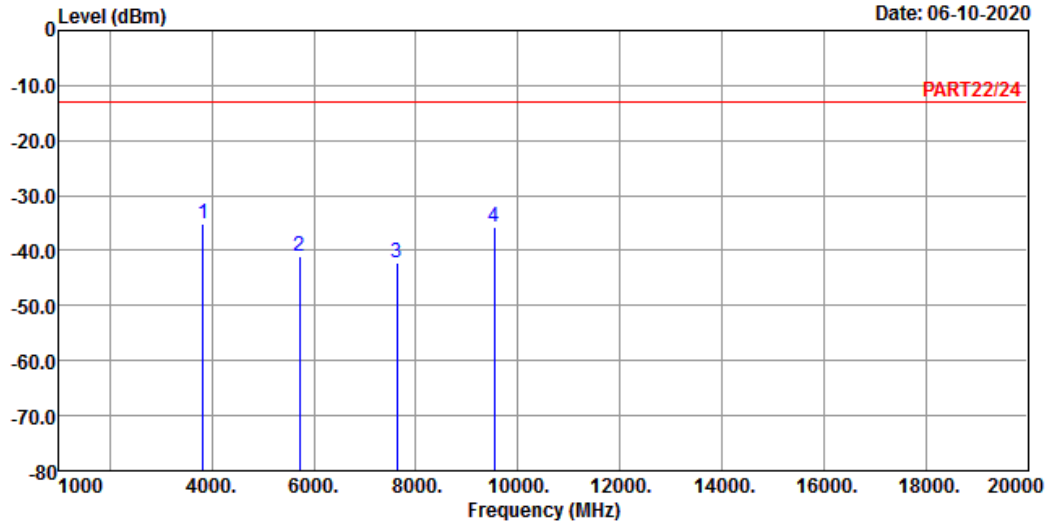

Site : 966 Chamber 5
 Condition: PART22/24 VERTICAL
 Remak : Cat-M1 Band 2 QPSK_5M Link_H-CH
 Tested by: Jisyoung Wang

	Freq	Level	Read Level	Limit Line	Over Factor	Over Limit	Remark
	MHz	dBm	dBm	dBm	dB	dB	
1 pp	3815.00	-35.12	-28.72	-13.00	-6.40	-22.12	Peak
2	5722.50	-41.11	-39.42	-13.00	-1.69	-28.11	Peak
3	7630.00	-42.16	-46.67	-13.00	4.51	-29.16	Peak
4	9537.50	-35.62	-41.01	-13.00	5.39	-22.62	Peak

Channel Bandwidth: 20 MHz / QPSK
Low Channel



Bureau Veritas Consumer Products Services Ltd., Taoyuan Branch

A D T

Data: 7

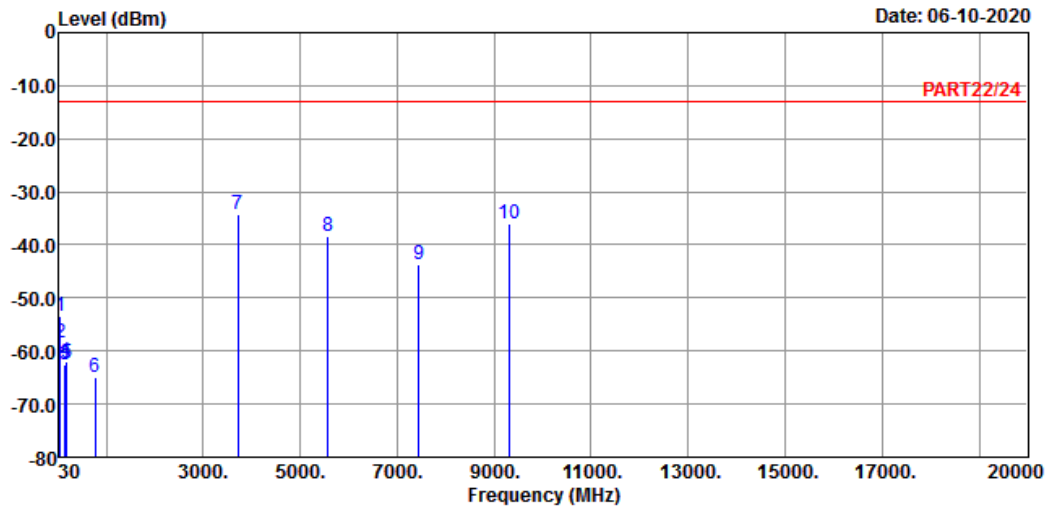

Site : 966 Chamber 5
Condition: PART22/24 HORIZONTAL
Remak : Cat-M1 Band 2 QPSK_20M Link_L-CH
Tested by: Jisyong Wang

	Freq	Level	Read Level	Limit	Line Factor	Over Limit	Remark
	MHz	dBm	dBm	dBm	dB	dB	
1	44.85	-53.31	-51.32	-13.00	-1.99	-40.31	Peak
2	53.76	-58.37	-52.56	-13.00	-5.81	-45.37	Peak
3	153.39	-62.61	-55.85	-13.00	-6.76	-49.61	Peak
4	169.86	-62.10	-56.57	-13.00	-5.53	-49.10	Peak
5	191.19	-62.23	-55.05	-13.00	-7.18	-49.23	Peak
6	779.50	-64.98	-65.77	-13.00	0.79	-51.98	Peak
7 pp	3720.00	-34.16	-27.34	-13.00	-6.82	-21.16	Peak
8	5580.00	-38.26	-36.34	-13.00	-1.92	-25.26	Peak
9	7440.00	-43.62	-47.77	-13.00	4.15	-30.62	Peak
10	9300.00	-36.14	-41.08	-13.00	4.94	-23.14	Peak



Bureau Veritas Consumer Products Services Ltd., Taoyuan Branch

A D T

Data: 8

Date: 06-10-2020

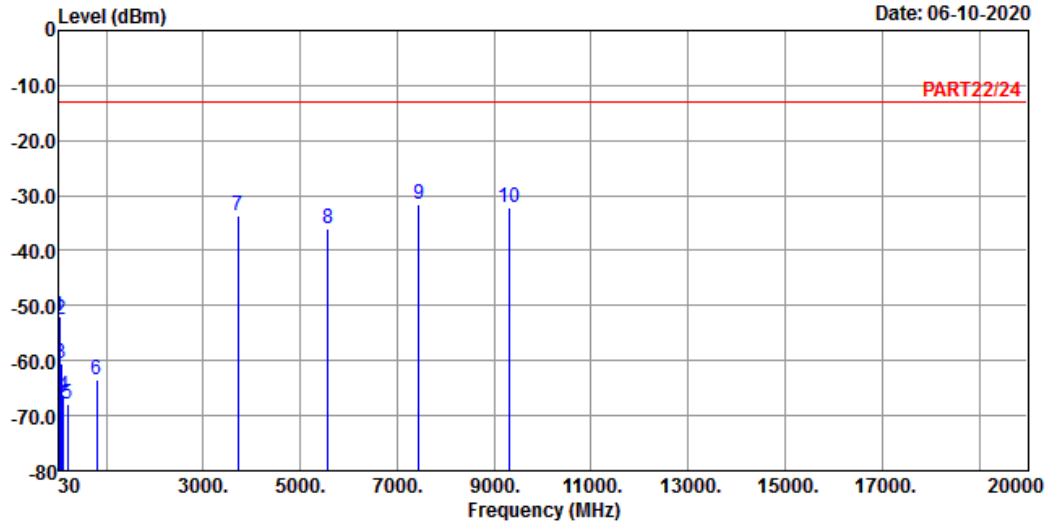

Site : 966 Chamber 5
 Condition: PART22/24 VERTICAL
 Remak : Cat-M1 Band 2 QPSK_20M Link_L-CH
 Tested by: Jisyong Wang

	Freq	Level	Read Level	Limit Line	Over Factor	Over Limit	Remark
	MHz	dBm	dBm	dBm	dB	dB	
1	31.62	-51.97	-51.37	-13.00	-0.60	-38.97	Peak
2	43.50	-52.50	-51.03	-13.00	-1.47	-39.50	Peak
3	68.34	-60.41	-52.09	-13.00	-8.32	-47.41	Peak
4	112.08	-66.32	-56.12	-13.00	-10.20	-53.32	Peak
5	209.28	-67.75	-60.12	-13.00	-7.63	-54.75	Peak
6	801.90	-63.34	-64.06	-13.00	0.72	-50.34	Peak
7	3720.00	-33.62	-26.80	-13.00	-6.82	-20.62	Peak
8	5580.00	-36.15	-34.23	-13.00	-1.92	-23.15	Peak
9 pp	7440.00	-31.47	-35.62	-13.00	4.15	-18.47	Peak
10	9300.00	-32.26	-37.20	-13.00	4.94	-19.26	Peak

Middle Channel



Bureau Veritas Consumer Products Services Ltd., Taoyuan Branch

A D T

Data: 3

Date: 06-10-2020

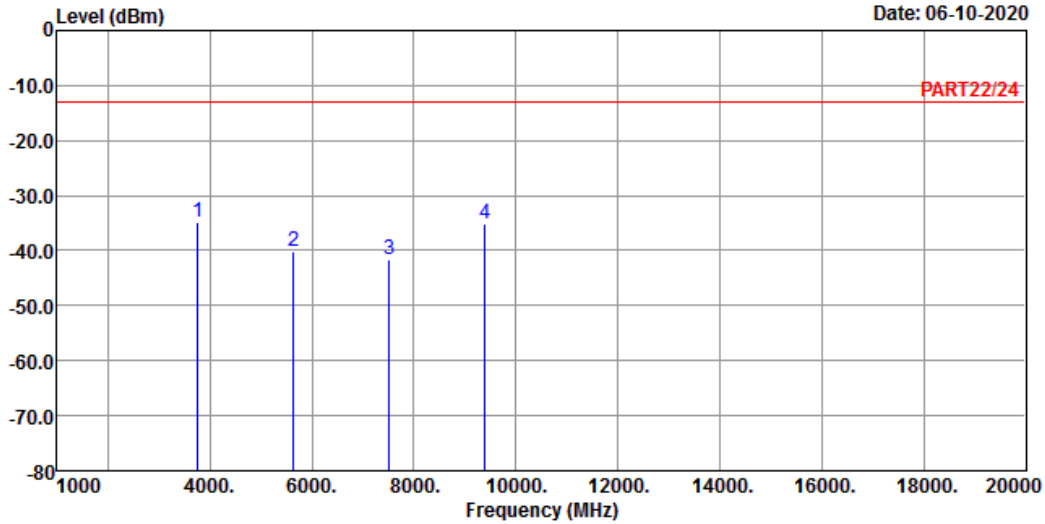

Site : 966 Chamber 5
 Condition: PART22/24 HORIZONTAL
 Remak : Cat-M1 Band 2 QPSK_20M Link_M-CH
 Tested by: Jisyong Wang

	Freq	Level	Read Level	Limit	Line	Factor	Over	Limit	Remark
	MHz	dBm	dBm	dBm		dB	dB	dB	
1 pp	3760.00	-34.85	-28.20	-13.00		-6.65	-21.85	Peak	
2	5640.00	-40.13	-38.27	-13.00		-1.86	-27.13	Peak	
3	7520.00	-41.52	-45.73	-13.00		4.21	-28.52	Peak	
4	9400.00	-35.16	-40.23	-13.00		5.07	-22.16	Peak	



Bureau Veritas Consumer Products Services Ltd., Taoyuan Branch

A D T

Data: 4

Date: 06-10-2020

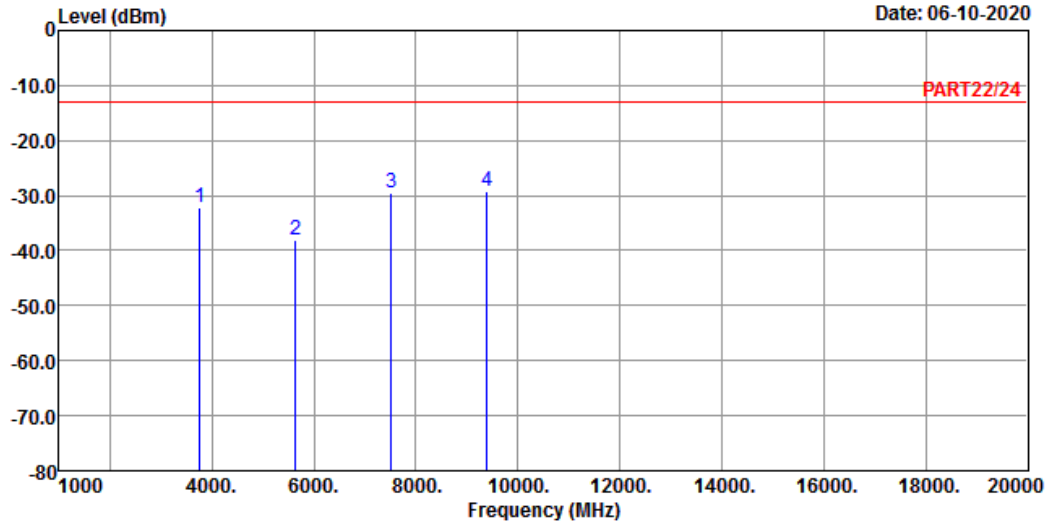

Site : 966 Chamber 5
 Condition: PART22/24 VERTICAL
 Remak : Cat-M1 Band 2 QPSK_20M Link_M-CH
 Tested by: Jisyoung Wang

	Freq	Level	Read Level	Limit Line	Over Factor	Limit	Remark
	MHz	dBm	dBm	dBm	dB	dB	
1	3760.00	-32.26	-25.61	-13.00	-6.65	-19.26	Peak
2	5640.00	-38.11	-36.25	-13.00	-1.86	-25.11	Peak
3	7520.00	-29.52	-33.73	-13.00	4.21	-16.52	Peak
4 pp	9400.00	-29.11	-34.18	-13.00	5.07	-16.11	Peak

High Channel



Bureau Veritas Consumer Products Services Ltd., Taoyuan Branch

A D T

Data: 3

Date: 2020-06-10

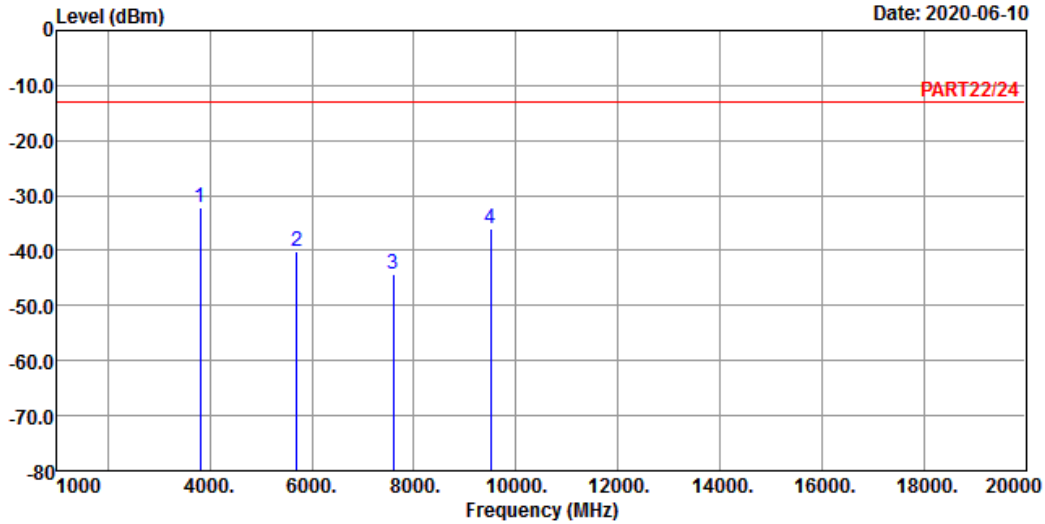

Site : 966 Chamber 5
 Condition: PART22/24 HORIZONTAL
 Remak : Cat-M1 Band 2 QPSK_20M Link_H-CH
 Tested by: Jisyong Wang

	Freq	Level	Read Level	Limit	Line Factor	Over Limit	Remark
	MHz	dBm	dBm	dBm	dB	dB	
1 pp	3800.00	-32.11	-25.68	-13.00	-6.43	-19.11	Peak
2	5700.00	-40.13	-38.40	-13.00	-1.73	-27.13	Peak
3	7600.00	-44.25	-48.72	-13.00	4.47	-31.25	Peak
4	9500.00	-36.01	-41.32	-13.00	5.31	-23.01	Peak



Bureau Veritas Consumer Products Services Ltd., Taoyuan Branch

A D T

Data: 4

Date: 2020-06-10

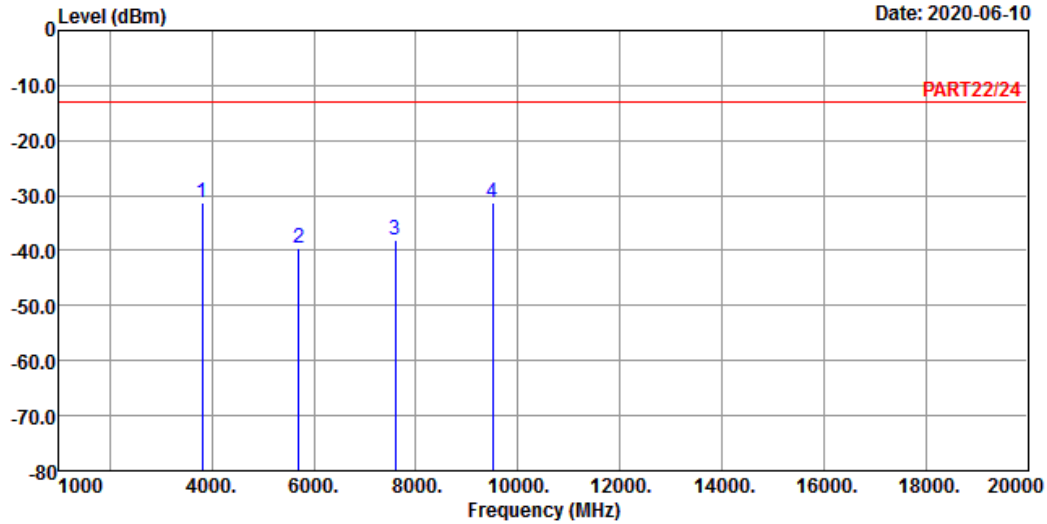

Site : 966 Chamber 5
 Condition: PART22/24 VERTICAL
 Remak : Cat-M1 Band 2 QPSK_20M Link_H-CH
 Tested by: Jisyoung Wang

	Freq	Level	Read Level	Limit	Line	Factor	Over Limit	Remark
	MHz	dBm	dBm	dBm	dB	dB	dB	
1	3800.00	-31.23	-24.80	-13.00	-6.43	-18.23	Peak	
2	5700.00	-39.52	-37.79	-13.00	-1.73	-26.52	Peak	
3	7600.00	-38.02	-42.49	-13.00	4.47	-25.02	Peak	
4 pp	9500.00	-31.15	-36.46	-13.00	5.31	-18.15	Peak	

LTE Band 25
 Channel Bandwidth: 1.4 MHz / QPSK
 Low Channel



Bureau Veritas Consumer Products Services Ltd., Taoyuan Branch

A D T

Data: 3

Date: 06-10-2020

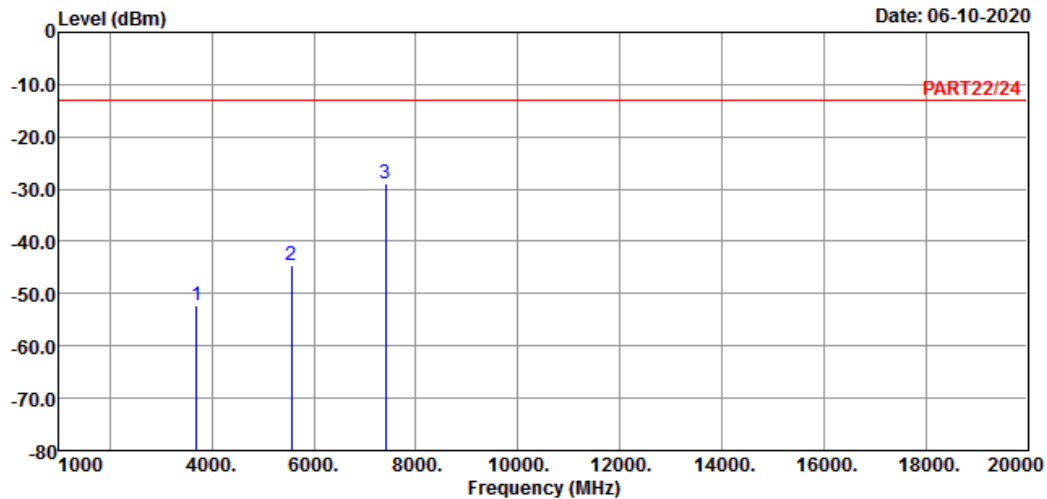

Site : 966 Chamber 5
 Condition: PART22/24 HORIZONTAL
 Remak : Cat-M1 Band 25 QPSK_1.4M Link_L-CH
 Tested by: Jisyong Wang

	Freq	Level	Read Level	Limit	Line Factor	Over Limit	Remark
	MHz	dBm	dBm	dBm	dB	dB	
1	3701.40	-52.26	-45.33	-13.00	-6.93	-39.26	Peak
2	5552.10	-44.62	-42.72	-13.00	-1.90	-31.62	Peak
3 pp	7402.80	-28.95	-33.06	-13.00	4.11	-15.95	Peak



Bureau Veritas Consumer Products Services Ltd., Taoyuan Branch

A D T

Data: 4

Date: 06-10-2020

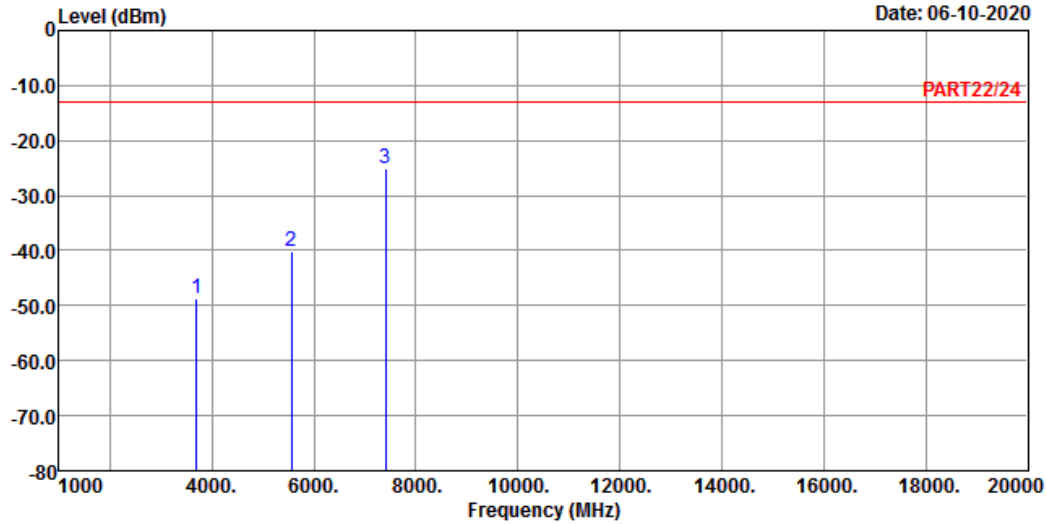

Site : 966 Chamber 5
 Condition: PART22/24 VERTICAL
 Remak : Cat-M1 Band 25 QPSK_1.4M Link_L-CH
 Tested by: Jisyong Wang

	Freq	Level	Read Level	Limit	Line Factor	Over Limit	Remark
	MHz	dBm	dBm	dBm	dB	dB	
1	3701.40	-48.62	-41.69	-13.00	-6.93	-35.62	Peak
2	5552.10	-40.13	-38.23	-13.00	-1.90	-27.13	Peak
3 pp	7402.80	-25.13	-29.24	-13.00	4.11	-12.13	Peak

Middle Channel



Bureau Veritas Consumer Products Services Ltd., Taoyuan Branch

A D T

Data: 3

Date: 06-10-2020

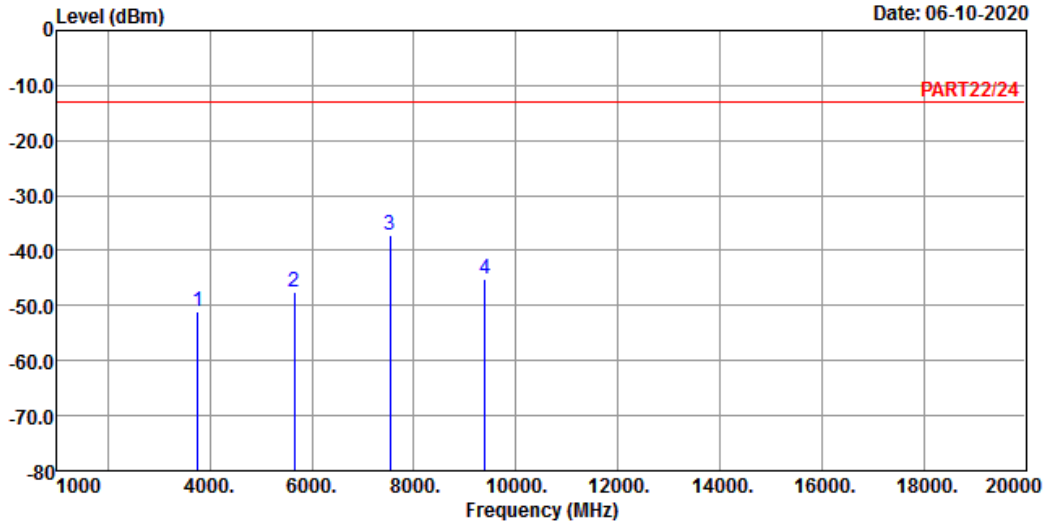

Site : 966 Chamber 5
 Condition: PART22/24 HORIZONTAL
 Remak : Cat-M1 Band 25 QPSK_1.4M Link_M-CH
 Tested by: Jisyong Wang

	Freq	Level	Read Level	Limit	Line Factor	Over Limit	Remark
	MHz	dBm	dBm	dBm	dB	dB	
1	3765.00	-51.12	-44.52	-13.00	-6.60	-38.12	Peak
2	5647.50	-47.62	-45.79	-13.00	-1.83	-34.62	Peak
3 pp	7530.00	-37.26	-41.54	-13.00	4.28	-24.26	Peak
4	9400.00	-45.13	-50.20	-13.00	5.07	-32.13	Peak



Bureau Veritas Consumer Products Services Ltd., Taoyuan Branch

A D T

Data: 4

Date: 06-10-2020

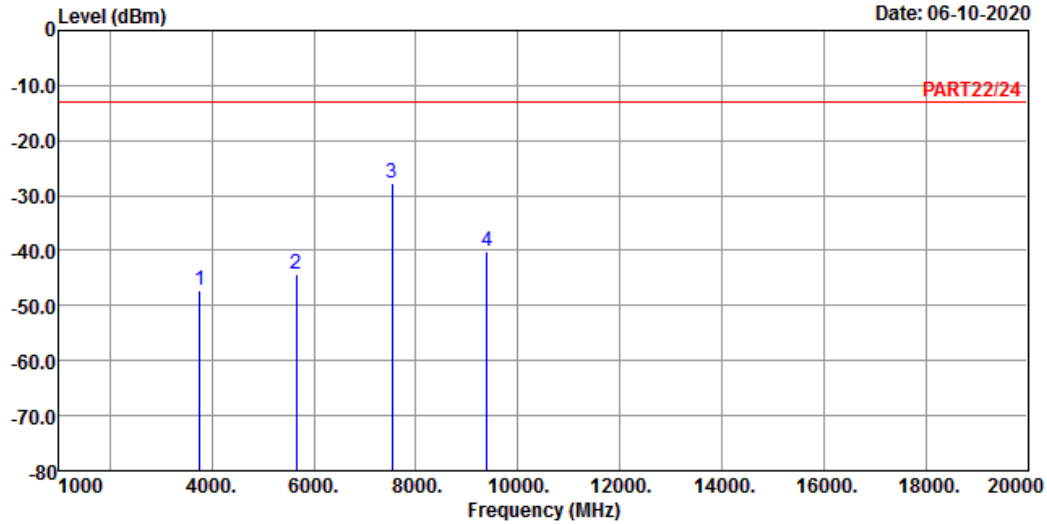

Site : 966 Chamber 5
 Condition: PART22/24 VERTICAL
 Remak : Cat-M1 Band 25 QPSK_1.4M Link_M-CH
 Tested by: Jisyong Wang

	Freq	Level	Read Level	Limit	Line	Factor	Over Limit	Remark
	MHz	dBm	dBm	dBm		dB	dB	
1	3765.00	-47.11	-40.51	-13.00		-6.60	-34.11	Peak
2	5647.50	-44.26	-42.43	-13.00		-1.83	-31.26	Peak
3 pp	7530.00	-27.62	-31.90	-13.00		4.28	-14.62	Peak
4	9400.00	-40.12	-45.19	-13.00		5.07	-27.12	Peak

High Channel



Bureau Veritas Consumer Products Services Ltd., Taoyuan Branch

A D T

Data: 3

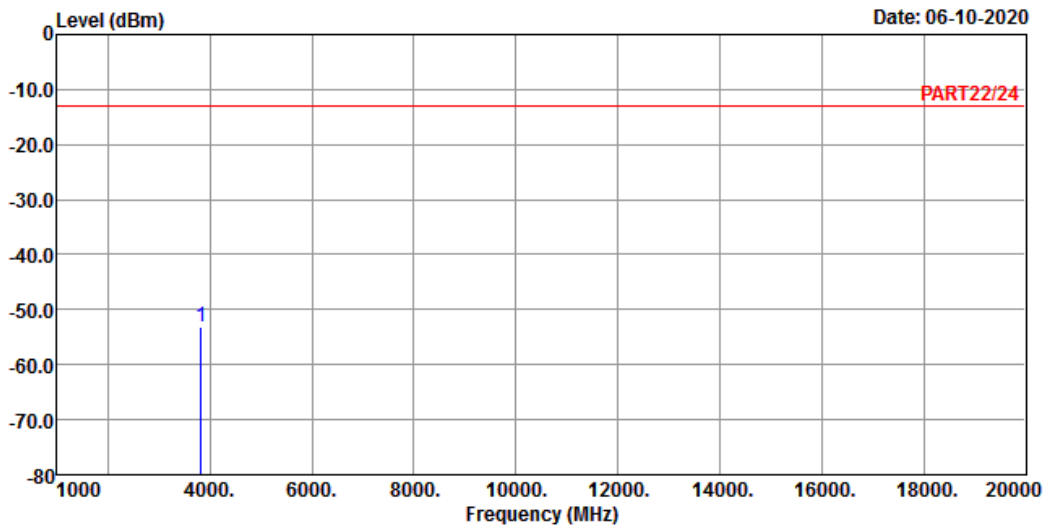

Site : 966 Chamber 5
 Condition: PART22/24 HORIZONTAL
 Remak : Cat-M1 Band 25 QPSK_1.4M Link_H-CH
 Tested by: Jisyong Wang

Freq	Level	Read Level	Limit	Line Factor	Over Limit	Remark
MHz	dBm	dBm	dBm	dB	dB	

1 pp 3828.60 -53.13 -46.76 -13.00 -6.37 -40.13 Peak



Bureau Veritas Consumer Products Services Ltd., Taoyuan Branch

A D T

Data: 4

Date: 06-10-2020

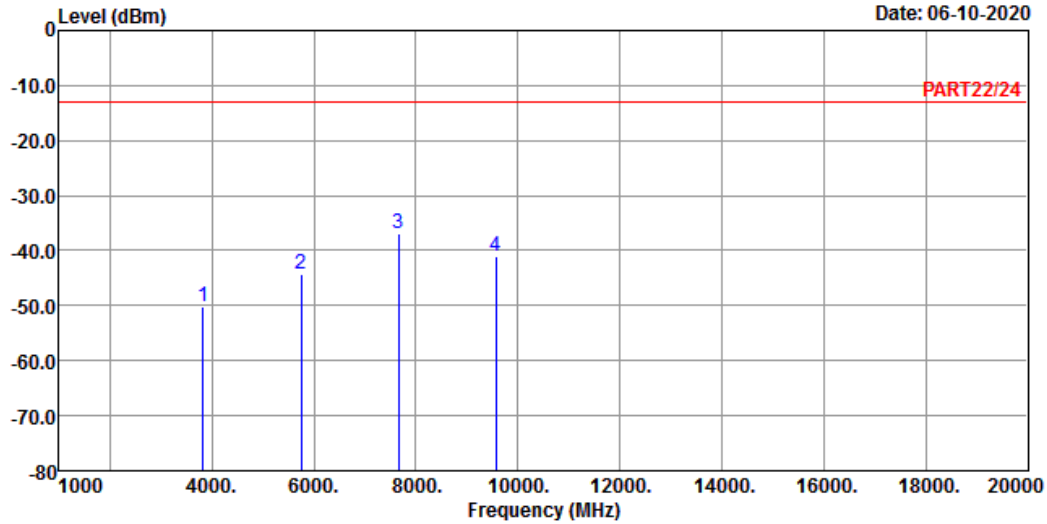

Site : 966 Chamber 5
 Condition: PART22/24 VERTICAL
 Remak : Cat-M1 Band 25 QPSK_1.4M Link_H-CH
 Tested by: Jisyong Wang

	Freq	Level	Read Level	Limit	Line	Factor	Over Limit	Remark
	MHz	dBm	dBm	dBm		dB	dB	
1	3828.60	-50.13	-43.76	-13.00	-6.37	-37.13	Peak	
2	5742.90	-44.26	-42.61	-13.00	-1.65	-31.26	Peak	
3 pp	7657.20	-36.95	-41.53	-13.00	4.58	-23.95	Peak	
4	9571.50	-41.11	-46.53	-13.00	5.42	-28.11	Peak	

Channel Bandwidth: 5 MHz / QPSK
Low Channel



Bureau Veritas Consumer Products Services Ltd., Taoyuan Branch

A D T

Data: 3

Date: 06-10-2020

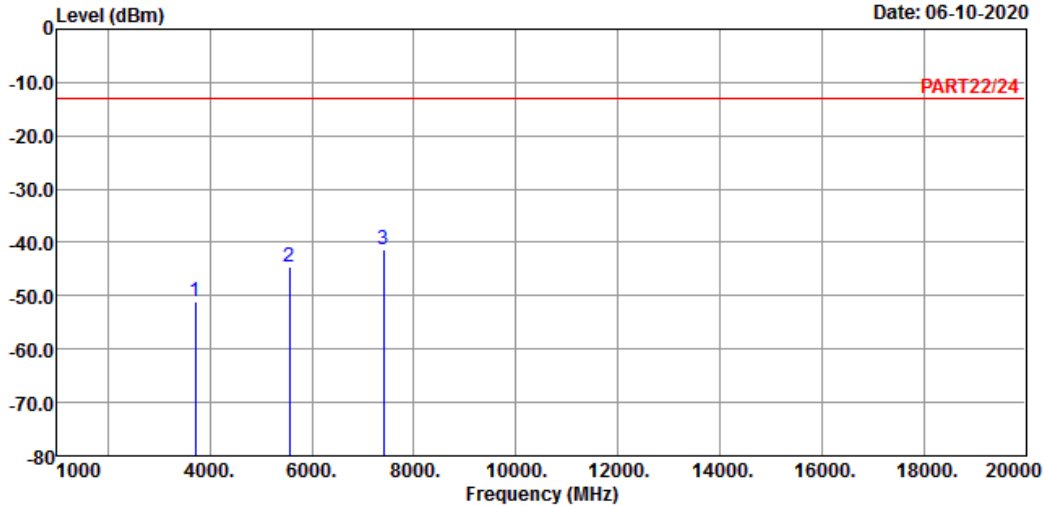

Site : 966 Chamber 5
Condition: PART22/24 HORIZONTAL
Remak : Cat-M1 Band 25 QPSK_5M Link_L-CH
Tested by: Jisyong Wang

	Freq	Level	Read Level	Limit	Line Factor	Over Limit	Remark
	MHz	dBm	dBm	dBm	dB	dB	
1	3705.00	-51.13	-44.20	-13.00	-6.93	-38.13	Peak
2	5557.50	-44.52	-42.61	-13.00	-1.91	-31.52	Peak
3 pp	7410.00	-41.26	-45.39	-13.00	4.13	-28.26	Peak



Bureau Veritas Consumer Products Services Ltd., Taoyuan Branch

A D T

Data: 4

Date: 06-10-2020

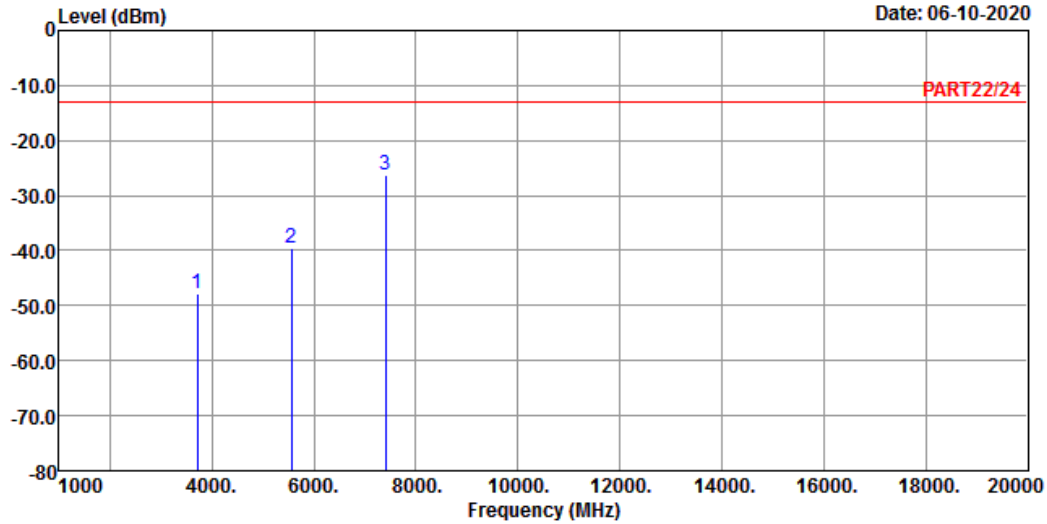

Site : 966 Chamber 5
 Condition: PART22/24 VERTICAL
 Remak : Cat-M1 Band 25 QPSK_5M Link_L-CH
 Tested by: Jisyong Wang

	Freq	Level	Read Level	Limit	Line Factor	Over Limit	Remark
	MHz	dBm	dBm	dBm	dB	dB	
1	3705.00	-47.68	-40.75	-13.00	-6.93	-34.68	Peak
2	5557.50	-39.52	-37.61	-13.00	-1.91	-26.52	Peak
3 pp	7410.00	-26.13	-30.26	-13.00	4.13	-13.13	Peak

Middle Channel



Bureau Veritas Consumer Products Services Ltd., Taoyuan Branch

A D T

Data: 3

Date: 06-10-2020

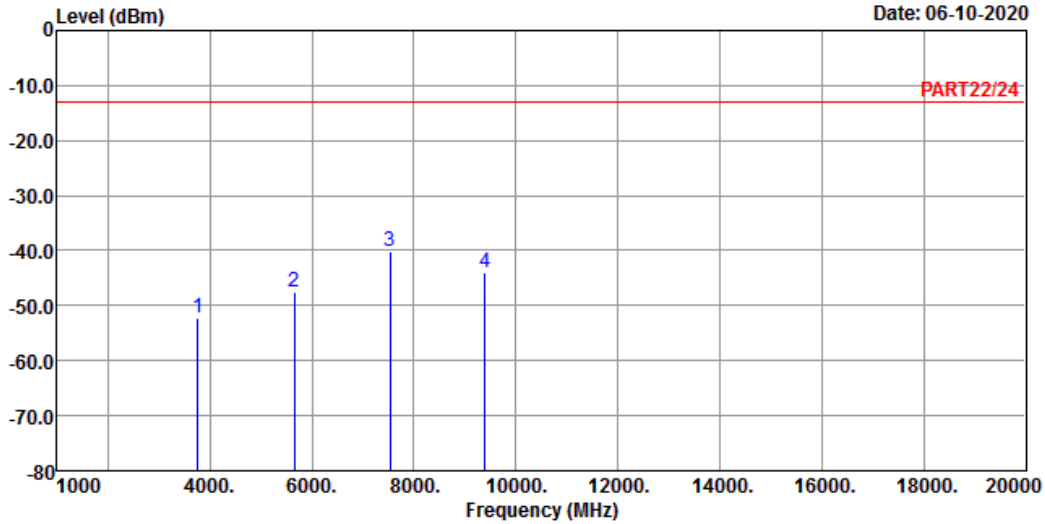

Site : 966 Chamber 5
 Condition: PART22/24 HORIZONTAL
 Remak : Cat-M1 Band 25 QPSK_5M Link_M-CH
 Tested by: Jisyong Wang

	Freq	Level	Read Level	Limit	Line Factor	Over Limit	Remark
	MHz	dBm	dBm	dBm	dB	dB	
1	3765.00	-52.11	-45.51	-13.00	-6.60	-39.11	Peak
2	5647.50	-47.62	-45.79	-13.00	-1.83	-34.62	Peak
3 pp	7530.00	-40.26	-44.54	-13.00	4.28	-27.26	Peak
4	9400.00	-44.13	-49.20	-13.00	5.07	-31.13	Peak



Bureau Veritas Consumer Products Services Ltd., Taoyuan Branch

A D T

Data: 4

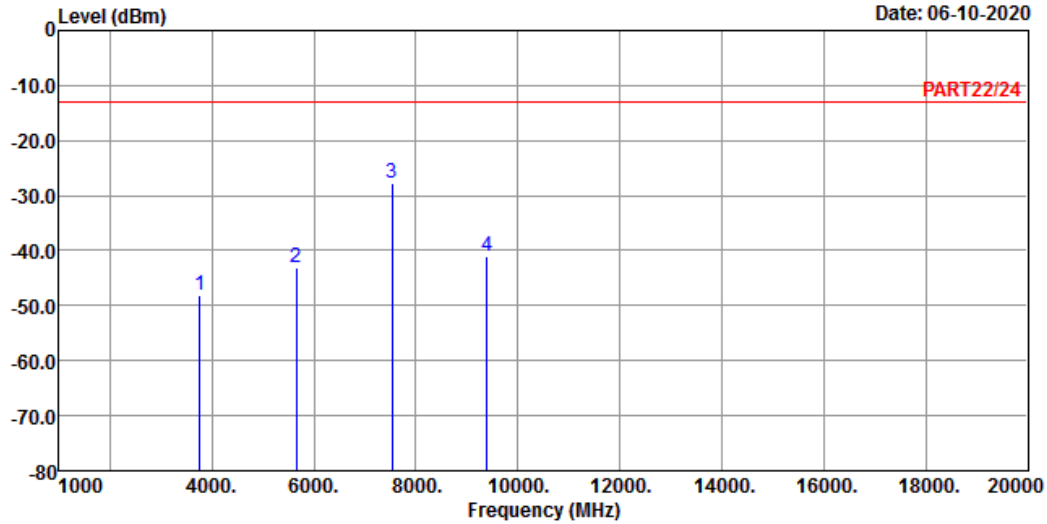

Site : 966 Chamber 5
 Condition: PART22/24 VERTICAL
 Remak : Cat-M1 Band 25 QPSK_5M Link_M-CH
 Tested by: Jisyong Wang

	Freq	Level	Read Level	Limit Line	Over Factor	Over Limit	Remark
	MHz	dBm	dBm	dBm	dB	dB	
1	3765.00	-48.13	-41.53	-13.00	-6.60	-35.13	Peak
2	5647.50	-43.02	-41.19	-13.00	-1.83	-30.02	Peak
3 pp	7530.00	-27.85	-32.13	-13.00	4.28	-14.85	Peak
4	9400.00	-41.13	-46.20	-13.00	5.07	-28.13	Peak

High Channel



Bureau Veritas Consumer Products Services Ltd., Taoyuan Branch

A D T

Data: 3

Date: 2020-06-10

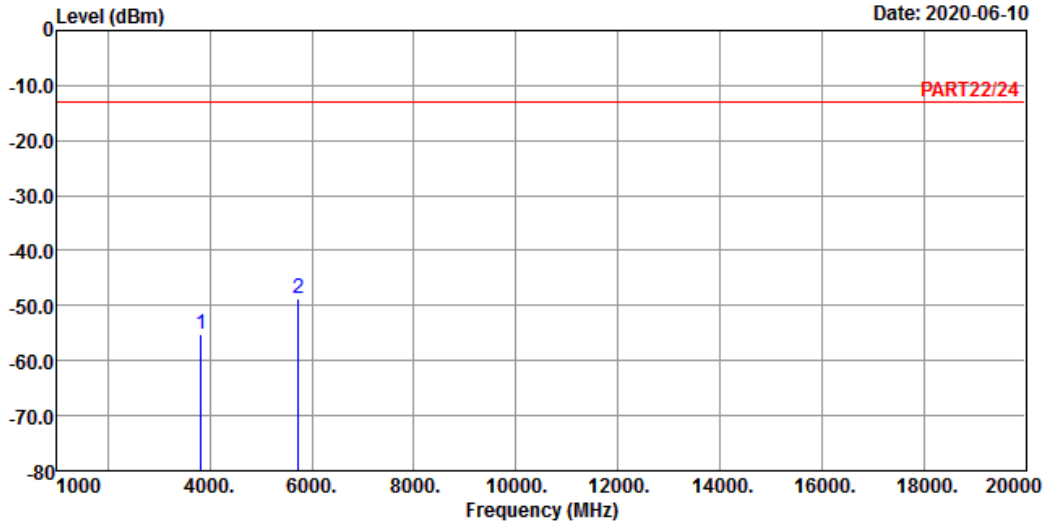

Site : 966 Chamber 5
 Condition: PART22/24 HORIZONTAL
 Remak : Cat-M1 Band 25 QPSK_5M Link_H-CH
 Tested by: Jisyong Wang

	Read	Limit	Over			
Freq	Level	Level	Line	Factor	Limit	Remark
MHz	dBm	dBm	dBm	dB	dB	
1	3825.00	-55.12	-48.75	-13.00	-6.37	-42.12 Peak
2 pp	5737.50	-48.62	-46.97	-13.00	-1.65	-35.62 Peak



Bureau Veritas Consumer Products Services Ltd., Taoyuan Branch

A D T

Data: 4

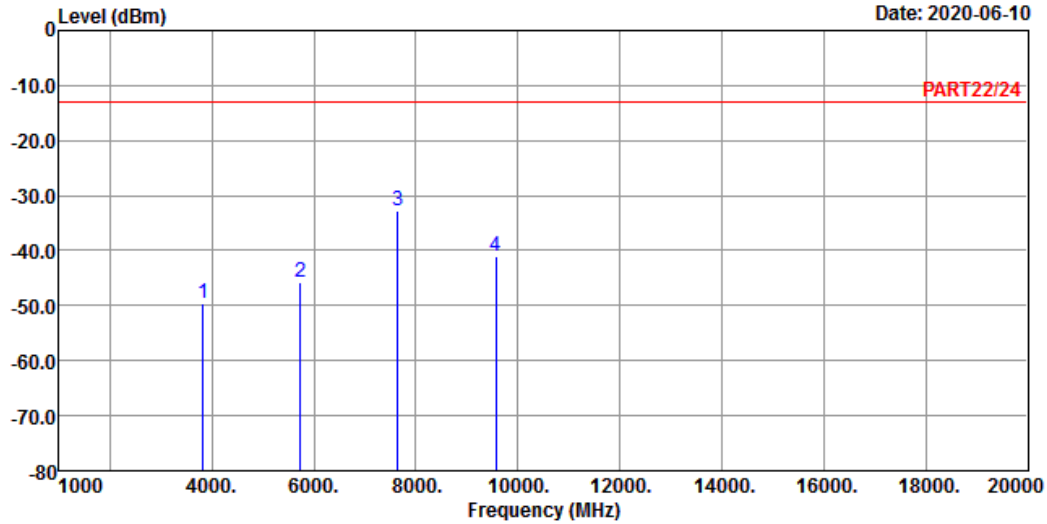

Site : 966 Chamber 5
 Condition: PART22/24 VERTICAL
 Remak : Cat-M1 Band 25 QPSK_5M Link_H-CH
 Tested by: Jisyong Wang

	Freq	Level	Read Level	Limit Line	Over Factor	Over Limit	Remark
	MHz	dBm	dBm	dBm	dB	dB	
1	3825.00	-49.62	-43.25	-13.00	-6.37	-36.62	Peak
2	5737.50	-45.68	-44.03	-13.00	-1.65	-32.68	Peak
3 pp	7650.00	-32.85	-37.40	-13.00	4.55	-19.85	Peak
4	9562.50	-41.14	-46.56	-13.00	5.42	-28.14	Peak

Channel Bandwidth: 20 MHz / QPSK
Low Channel



Bureau Veritas Consumer Products Services Ltd., Taoyuan Branch

A D T

Data: 7

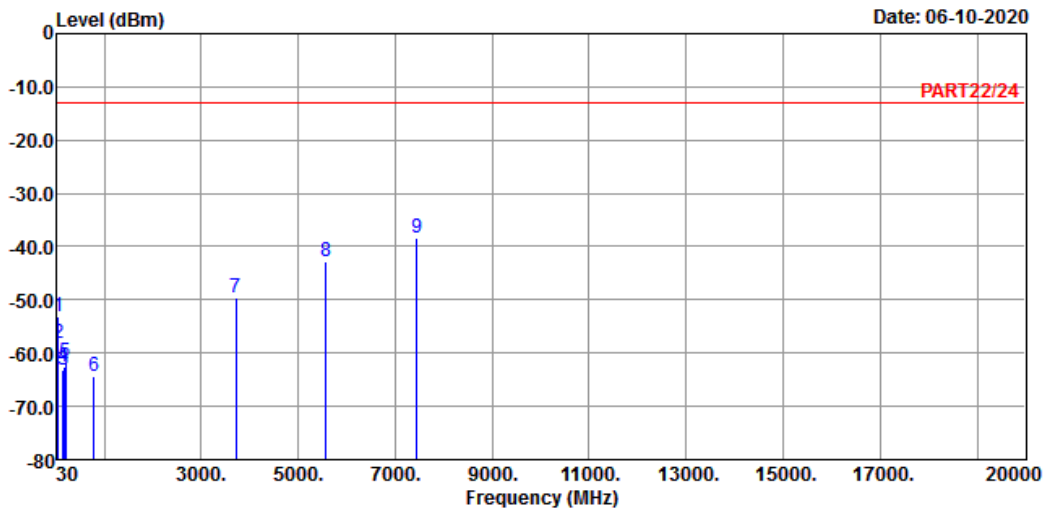

Site : 966 Chamber 5
Condition: PART22/24 HORIZONTAL
Remak : Cat-M1 Band 25 QPSK_20M Link_L-CH
Tested by: Jisyong Wang

	Freq	Level	Read Level	Limit	Line Factor	Over Limit	Remark
	MHz	dBm	dBm	dBm	dB	dB	
1	44.04	-52.99	-51.52	-13.00	-1.47	-39.99	Peak
2	54.30	-58.25	-52.18	-13.00	-6.07	-45.25	Peak
3	154.74	-63.05	-56.84	-13.00	-6.21	-50.05	Peak
4	171.21	-62.55	-56.68	-13.00	-5.87	-49.55	Peak
5	194.16	-61.83	-54.37	-13.00	-7.46	-48.83	Peak
6	785.80	-64.41	-65.19	-13.00	0.78	-51.41	Peak
7	3720.00	-49.52	-42.70	-13.00	-6.82	-36.52	Peak
8	5580.00	-42.95	-41.03	-13.00	-1.92	-29.95	Peak
9 pp	7440.00	-38.45	-42.60	-13.00	4.15	-25.45	Peak



Bureau Veritas Consumer Products Services Ltd., Taoyuan Branch

A D T

Data: 8

Date: 06-10-2020

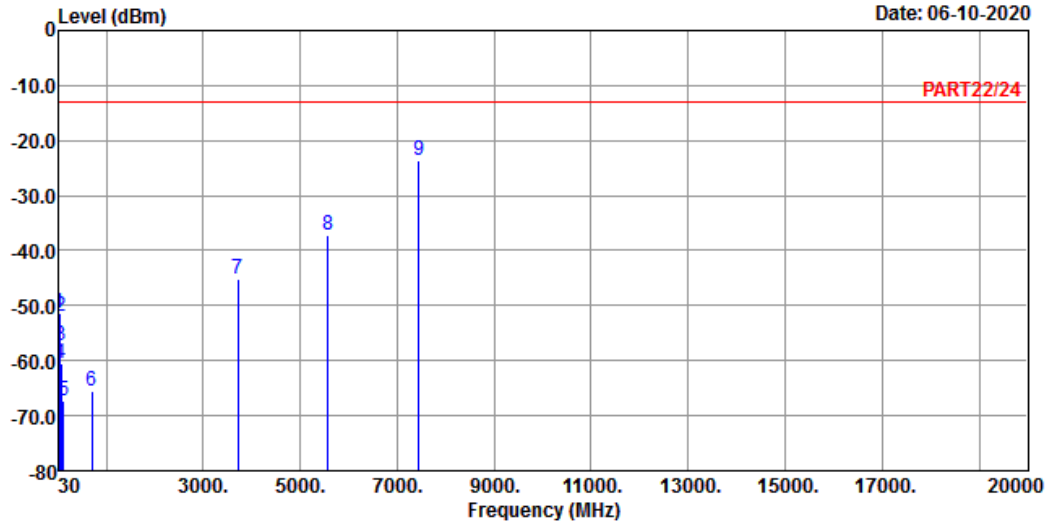

Site : 966 Chamber 5
 Condition: PART22/24 VERTICAL
 Remak : Cat-M1 Band 25 QPSK_20M Link_L-CH
 Tested by: Jisyoung Wang

	Freq	Level	Read Level	Limit Line	Over Factor	Over Limit	Remark
	MHz	dBm	dBm	dBm	dB	dB	
1	30.81	-51.24	-51.13	-13.00	-0.11	-38.24	Peak
2	43.77	-51.85	-50.38	-13.00	-1.47	-38.85	Peak
3	54.03	-57.18	-51.11	-13.00	-6.07	-44.18	Peak
4	68.61	-60.46	-52.14	-13.00	-8.32	-47.46	Peak
5	111.27	-67.40	-57.16	-13.00	-10.24	-54.40	Peak
6	706.00	-65.56	-65.58	-13.00	0.02	-52.56	Peak
7	3720.00	-45.12	-38.30	-13.00	-6.82	-32.12	Peak
8	5580.00	-37.31	-35.39	-13.00	-1.92	-24.31	Peak
9 pp	7440.00	-23.62	-27.77	-13.00	4.15	-10.62	Peak

Middle Channel



Bureau Veritas Consumer Products Services Ltd., Taoyuan Branch

A D T

Data: 3

Date: 06-10-2020

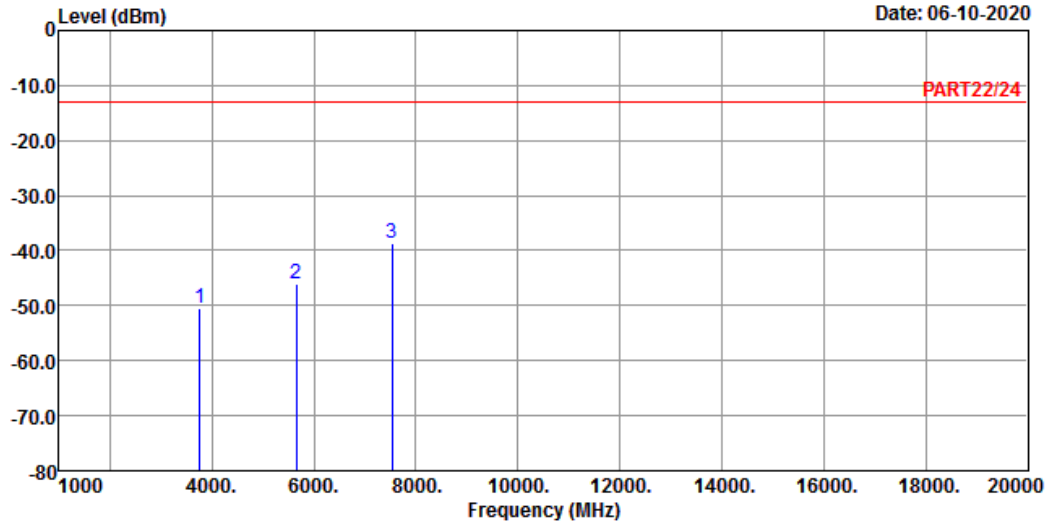

Site : 966 Chamber 5
 Condition: PART22/24 HORIZONTAL
 Remak : Cat-M1 Band 25 QPSK_20M Link_M-CH
 Tested by: Jisyong Wang

	Freq	Level	Read Level	Limit	Line Factor	Over Limit	Remark
	MHz	dBm	dBm	dBm	dB	dB	
1	3765.00	-50.52	-43.92	-13.00	-6.60	-37.52	Peak
2	5647.50	-45.95	-44.12	-13.00	-1.83	-32.95	Peak
3 pp	7530.00	-38.62	-42.90	-13.00	4.28	-25.62	Peak



Bureau Veritas Consumer Products Services Ltd., Taoyuan Branch

A D T

Data: 4

Date: 06-10-2020

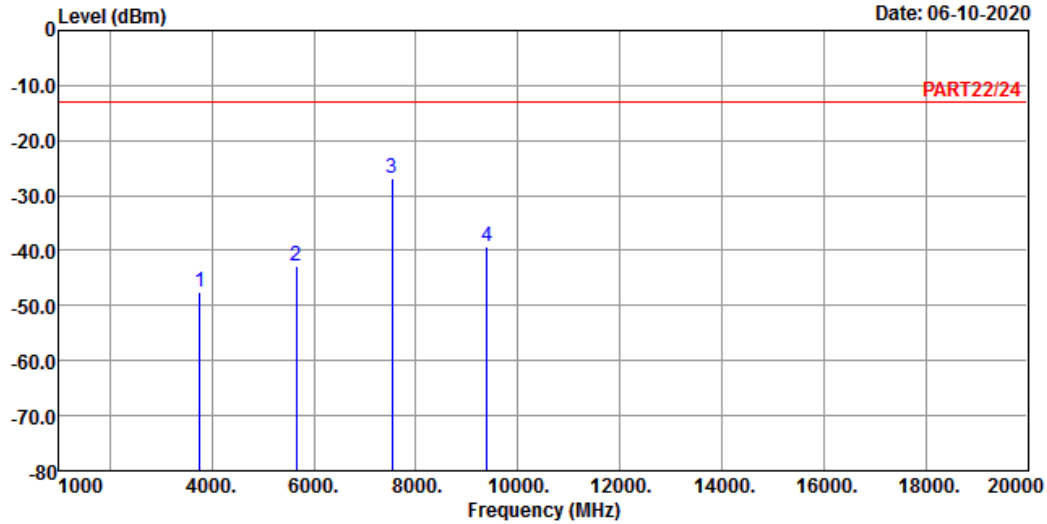

Site : 966 Chamber 5
 Condition: PART22/24 VERTICAL
 Remak : Cat-M1 Band 25 QPSK_20M Link_M-CH
 Tested by: Jisyong Wang

	Freq	Level	Read Level	Limit	Line	Factor	Over	Limit	Remark
	MHz	dBm	dBm	dBm		dB	dB	dB	
1	3765.00	-47.65	-41.05	-13.00		-6.60	-34.65		Peak
2	5647.50	-42.82	-40.99	-13.00		-1.83	-29.82		Peak
3 pp	7530.00	-26.99	-31.27	-13.00		4.28	-13.99		Peak
4	9400.00	-39.15	-44.22	-13.00		5.07	-26.15		Peak

High Channel



Bureau Veritas Consumer Products Services Ltd., Taoyuan Branch

A D T

Data: 3

Date: 06-10-2020

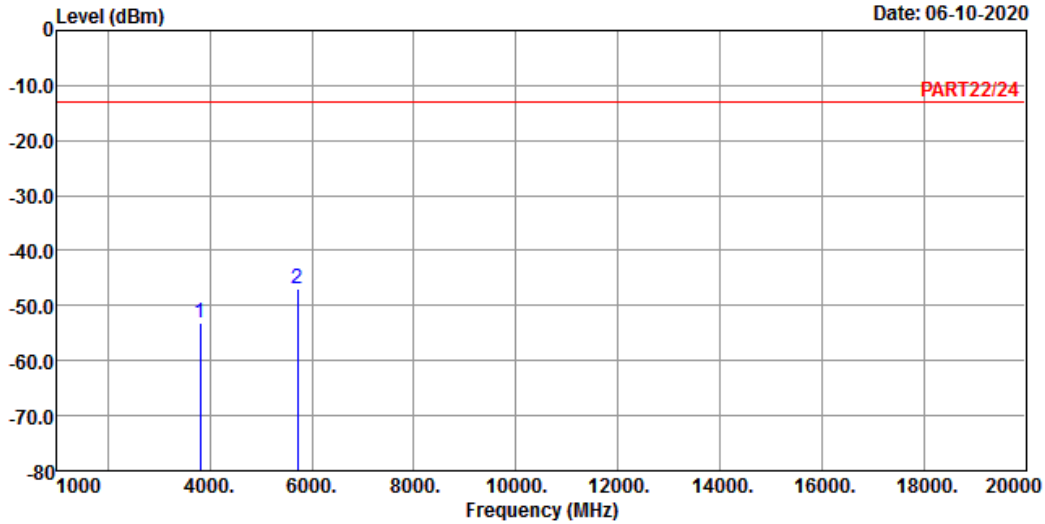

Site : 966 Chamber 5
 Condition: PART22/24 HORIZONTAL
 Remak : Cat-M1 Band 25 QPSK_20M Link_H-CH
 Tested by: Jisyong Wang

	Freq	Level	Read Level	Limit	Line Factor	Over Limit	Remark
	MHz	dBm	dBm	dBm	dB	dB	
1	3810.00	-53.25	-46.85	-13.00	-6.40	-40.25	Peak
2 pp	5715.00	-46.85	-45.16	-13.00	-1.69	-33.85	Peak



Bureau Veritas Consumer Products Services Ltd., Taoyuan Branch

A D T

Data: 4

Date: 06-10-2020

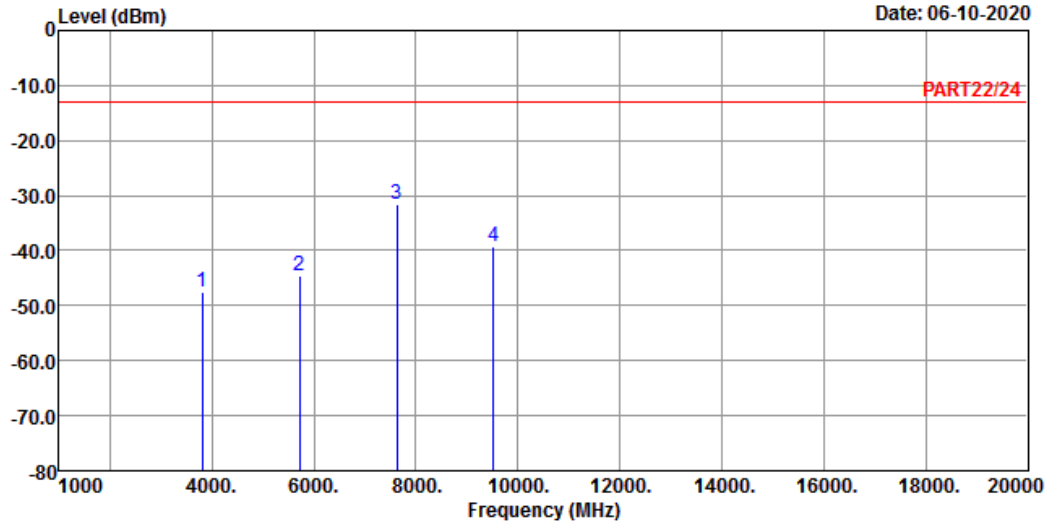

Site : 966 Chamber 5
 Condition: PART22/24 VERTICAL
 Remak : Cat-M1 Band 25 QPSK_20M Link_H-CH
 Tested by: Jisyong Wang

	Freq	Level	Read Level	Limit	Over	Limit	Remark
	MHz	dBm	dBm	dBm	dB	dB	
1	3810.00	-47.65	-41.25	-13.00	-6.40	-34.65	Peak
2	5715.00	-44.62	-42.93	-13.00	-1.69	-31.62	Peak
3 pp	7620.00	-31.52	-36.03	-13.00	4.51	-18.52	Peak
4	9525.00	-39.25	-44.60	-13.00	5.35	-26.25	Peak

NB-IoT
 LTE Band 2
 Low Channel



Bureau Veritas Consumer Products Services Ltd., Taoyuan Branch

A D T

Data: 3

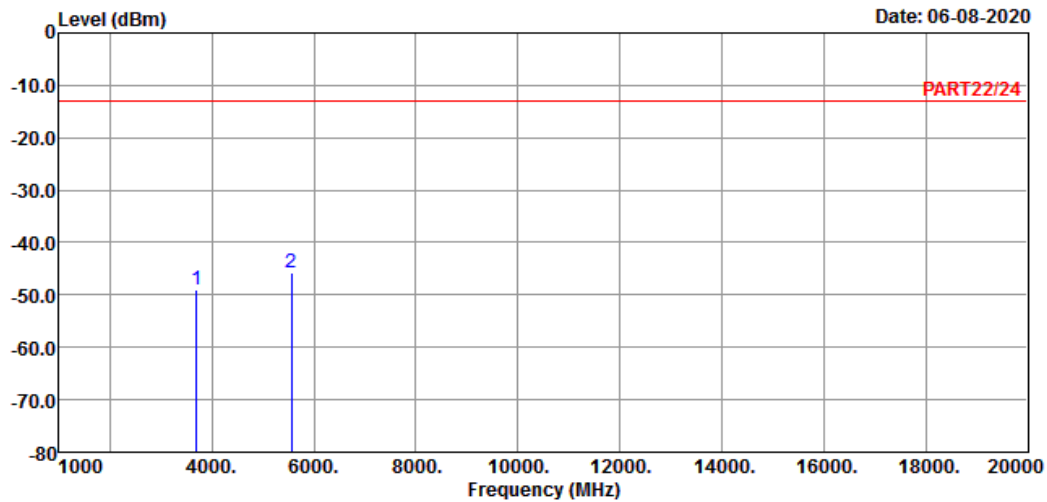

Site : 966 Chamber 5
 Condition: PART22/24 HORIZONTAL
 Remak : NB-IOT Band 2 Stand-alone_Link_L-Ch
 Tested by: Jisyong Wang

	Freq	Level	Read Level	Limit	Line Factor	Over Limit	Remark
	MHz	dBm	dBm	dBm	dB	dB	
1	3700.40	-48.99	-42.06	-13.00	-6.93	-35.99	Peak
2 pp	5550.60	-45.89	-43.99	-13.00	-1.90	-32.89	Peak



Bureau Veritas Consumer Products Services Ltd., Taoyuan Branch

A D T

Data: 4

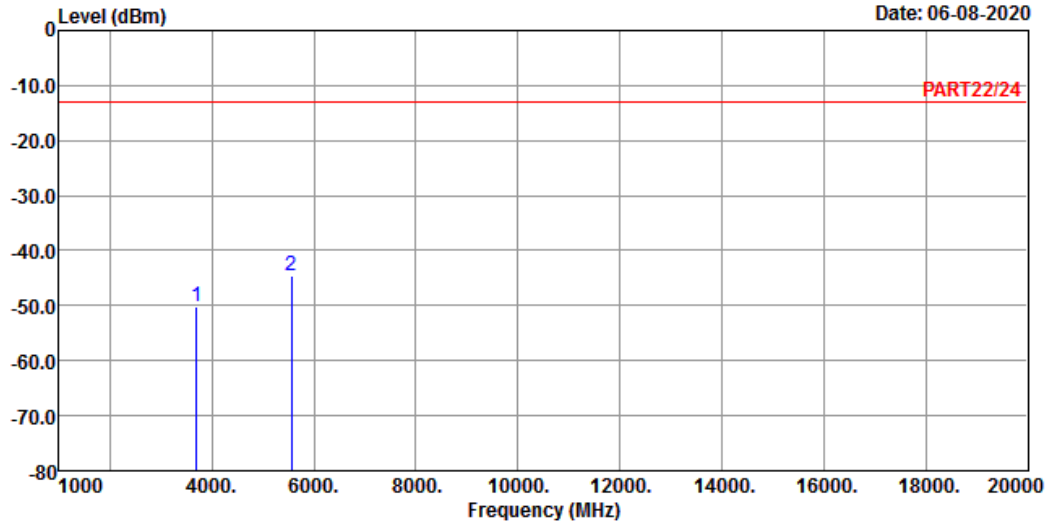

Site : 966 Chamber 5
 Condition: PART22/24 VERTICAL
 Remak : NB-IOT Band 2 Stand-alone_Link_L-Ch
 Tested by: Jisyong Wang

	Freq	Level	Read Level	Limit	Line Factor	Over Limit	Remark
	MHz	dBm	dBm	dBm	dB	dB	
1	3700.40	-50.12	-43.19	-13.00	-6.93	-37.12	Peak
2	5550.60	-44.56	-42.66	-13.00	-1.90	-31.56	Peak

Middle Channel



Bureau Veritas Consumer Products Services Ltd., Taoyuan Branch

A D T

Data: 5

Date: 06-08-2020

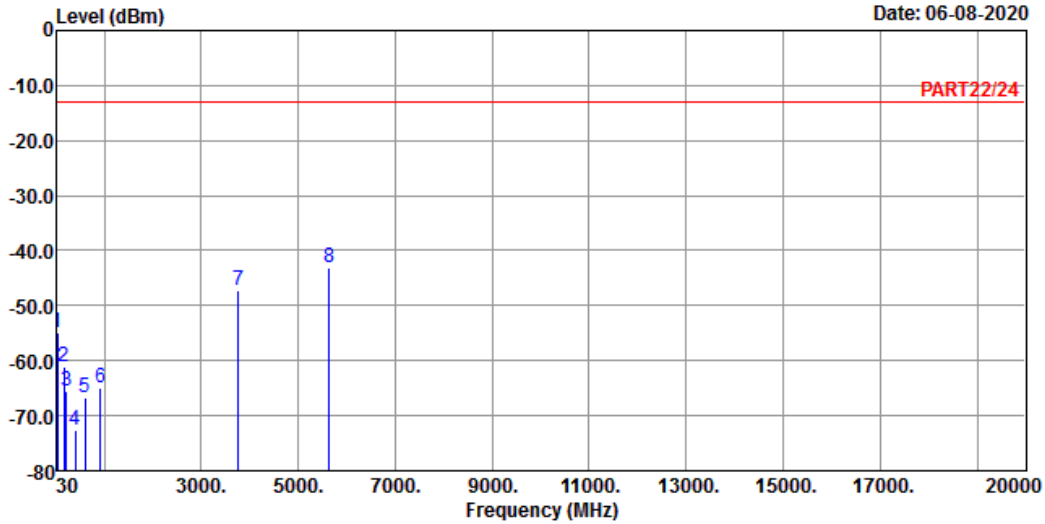

Site : 966 Chamber 5
 Condition: PART22/24 HORIZONTAL
 Remak : NB-IOT Band 2 Stand-alone_Link_M-Ch
 Tested by: Jisyong Wang

	Freq	Level	Read Level	Limit	Line Factor	Over Limit	Remark
	MHz	dBm	dBm	dBm	dB	dB	
1	42.61	-54.86	-53.92	-13.00	-0.94	-41.86	Peak
2	169.68	-61.10	-55.57	-13.00	-5.53	-48.10	Peak
3	211.39	-65.67	-58.12	-13.00	-7.55	-52.67	Peak
4	405.39	-72.62	-66.72	-13.00	-5.90	-59.62	Peak
5	601.33	-66.59	-65.83	-13.00	-0.76	-53.59	Peak
6	927.25	-65.00	-66.25	-13.00	1.25	-52.00	Peak
7	3760.00	-47.11	-40.46	-13.00	-6.65	-34.11	Peak
8 pp	5640.00	-43.01	-41.15	-13.00	-1.86	-30.01	Peak



Bureau Veritas Consumer Products Services Ltd., Taoyuan Branch

A D T

Data: 6

Date: 06-08-2020

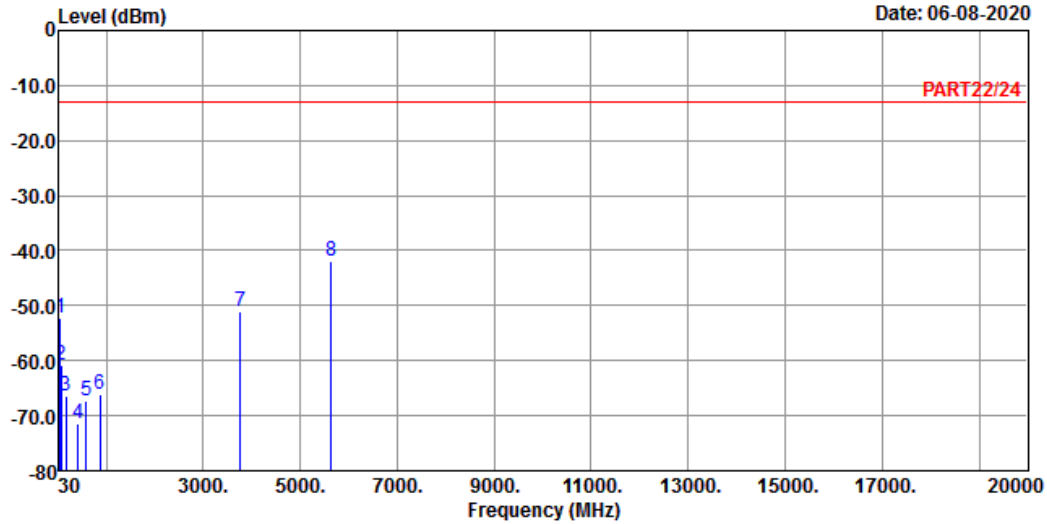

Site : 966 Chamber 5
 Condition: PART22/24 VERTICAL
 Remak : NB-IOT Band 2 Stand-alone_Link_M-Ch
 Tested by: Jisyong Wang

	Read	Limit	Over			
Freq	Level	Level	Line	Factor	Limit	Remark
MHz	dBm	dBm	dBm	dB	dB	
1	43.58	-52.25	-50.78	-13.00	-1.47	-39.25 Peak
2	68.80	-60.96	-52.64	-13.00	-8.32	-47.96 Peak
3	160.95	-66.43	-61.52	-13.00	-4.91	-53.43 Peak
4	427.70	-71.33	-65.60	-13.00	-5.73	-58.33 Peak
5	592.60	-67.22	-66.14	-13.00	-1.08	-54.22 Peak
6	868.08	-65.98	-66.37	-13.00	0.39	-52.98 Peak
7	3760.00	-51.01	-44.36	-13.00	-6.65	-38.01 Peak
8 pp	5640.00	-42.01	-40.15	-13.00	-1.86	-29.01 Peak

High Channel



Bureau Veritas Consumer Products Services Ltd., Taoyuan Branch

A D T

Data: 3

Date: 2020-06-07

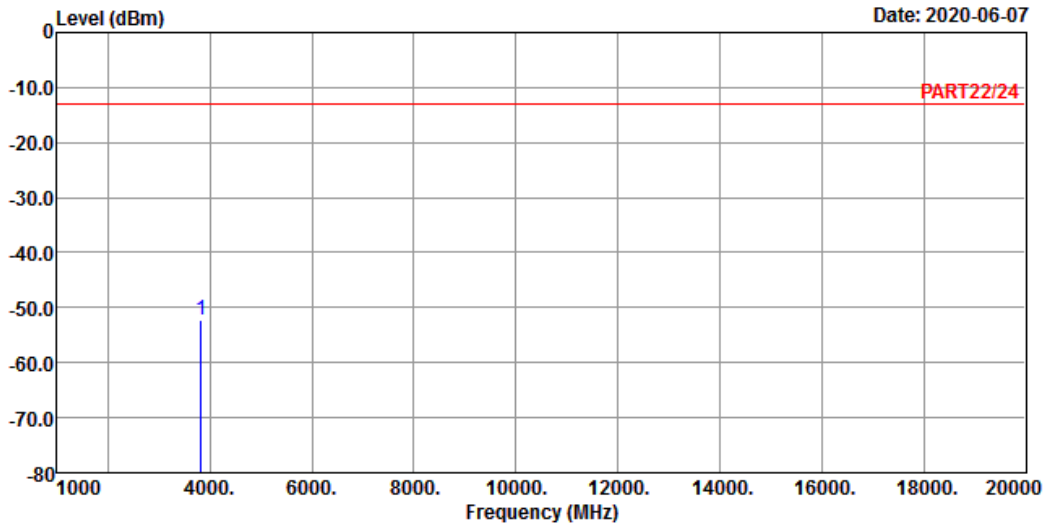

Site : 966 Chamber 5
 Condition: PART22/24 HORIZONTAL
 Remak : NB-IOT Band 2 Stand-alone_Link_H-Ch
 Tested by: Jisyong Wang

Freq	Level	Read Level	Limit	Line Factor	Over Limit	Remark
MHz	dBm	dBm	dBm	dB	dB	

1 pp 3819.60 -52.12 -45.72 -13.00 -6.40 -39.12 Peak



Bureau Veritas Consumer Products Services Ltd., Taoyuan Branch

A D T

Data: 4

Date: 2020-06-07

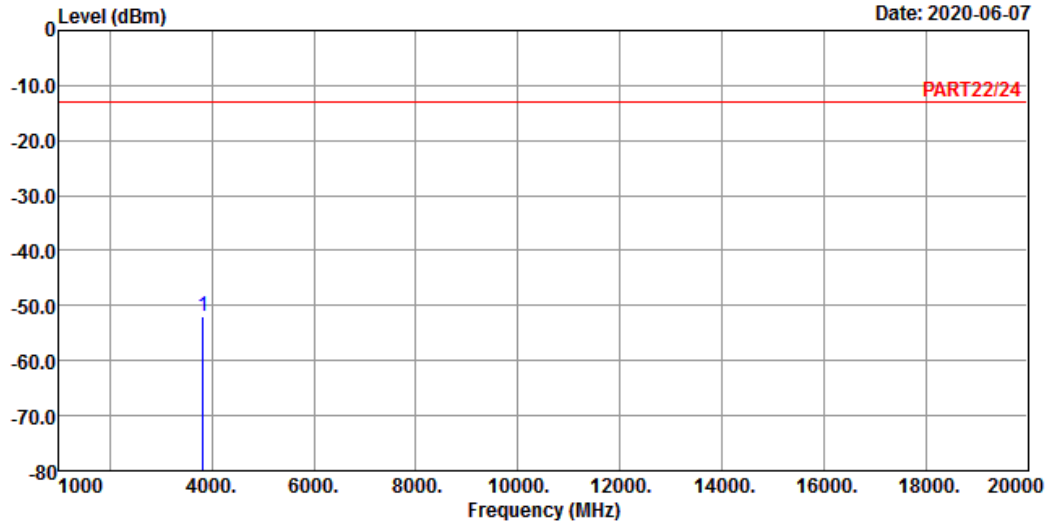

Site : 966 Chamber 5
 Condition: PART22/24 VERTICAL
 Remak : NB-IOT Band 2 Stand-alone_Link_H-Ch
 Tested by: Jisyong Wang

Freq	Level	Read Level	Limit	Line Factor	Over Limit	Remark
MHz	dBm	dBm	dBm	dB	dB	
1 pp 3819.60	-51.85	-45.45	-13.00	-6.40	-38.85	Peak

LTE Band 25
Low Channel



Bureau Veritas Consumer Products Services Ltd., Taoyuan Branch

A D T

Data: 6

Date: 06-08-2020

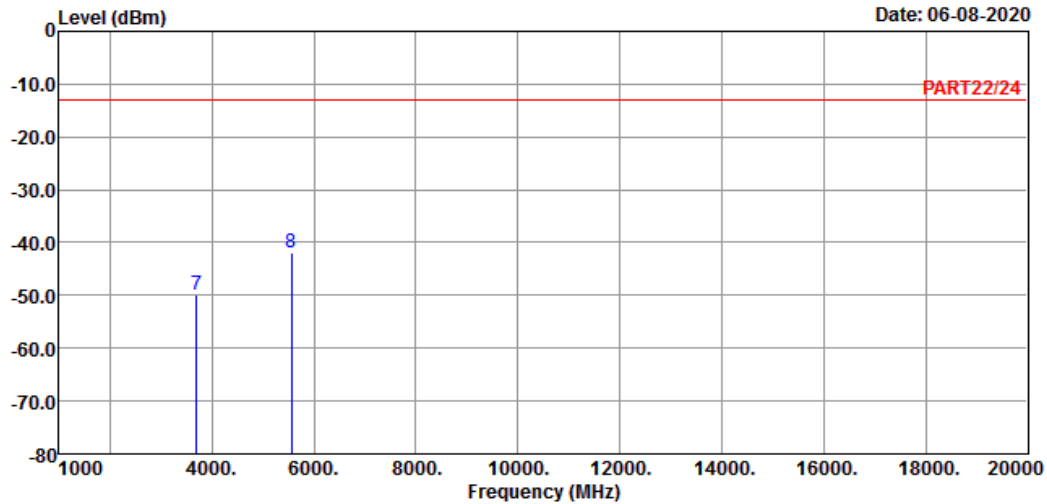

Site : 966 Chamber 5
Condition: PART22/24 VERTICAL
Remak : NB-IOT Band 25 Stand-alone_Link_L-Ch
Tested by: Jisyong Wang

	Freq	Level	Read	Limit	Over	Remark
	MHz	dBm	Level	Line	Factor	Limit
			dBm	dBm	dB	dB
1	42.61	-54.34	-53.40	-13.00	-0.94	-41.34 Peak
2	70.74	-62.03	-53.41	-13.00	-8.62	-49.03 Peak
3	298.69	-70.76	-63.77	-13.00	-6.99	-57.76 Peak
4	596.48	-67.35	-66.44	-13.00	-0.91	-54.35 Peak
5	808.91	-65.14	-65.80	-13.00	0.66	-52.14 Peak
6	900.09	-64.44	-65.01	-13.00	0.57	-51.44 Peak
7	3700.40	-50.01	-43.08	-13.00	-6.93	-37.01 Peak
8 pp	5550.60	-42.03	-40.13	-13.00	-1.90	-29.03 Peak



Bureau Veritas Consumer Products Services Ltd., Taoyuan Branch

A D T

Data: 5

Date: 06-08-2020

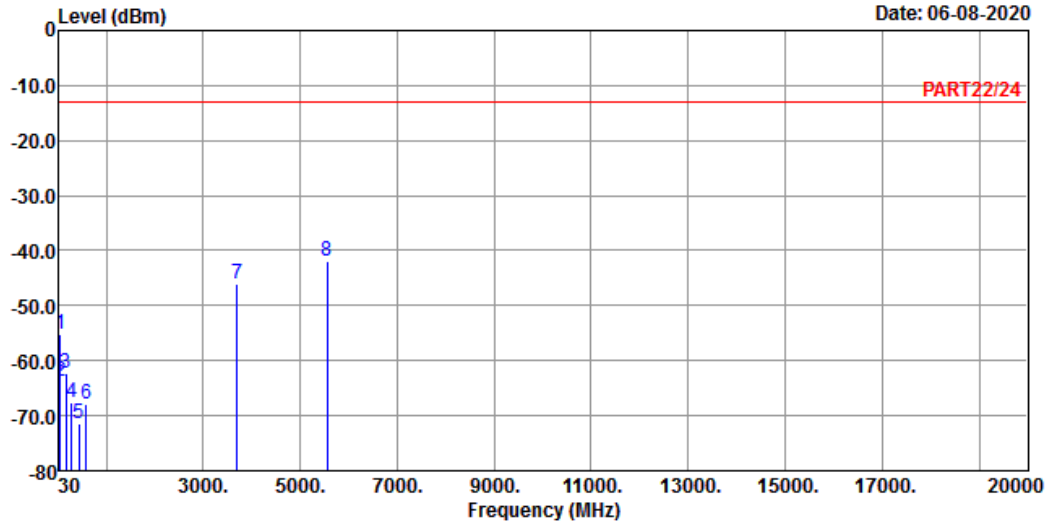

Site : 966 Chamber 5
 Condition: PART22/24 HORIZONTAL
 Remak : NB-IOT Band 25 Stand-alone_Link_L-Ch
 Tested by: Jisyoung Wang

	Freq	Level	Read Level	Limit	Line Factor	Over Limit	Remark
	MHz	dBm	dBm	dBm	dB	dB	
1	44.55	-55.25	-53.26	-13.00	-1.99	-42.25	Peak
2	55.22	-63.91	-57.57	-13.00	-6.34	-50.91	Peak
3	166.77	-62.16	-56.84	-13.00	-5.32	-49.16	Peak
4	284.14	-67.61	-60.92	-13.00	-6.69	-54.61	Peak
5	429.64	-71.45	-65.74	-13.00	-5.71	-58.45	Peak
6	584.84	-67.80	-66.40	-13.00	-1.40	-54.80	Peak
7	3700.40	-46.11	-39.18	-13.00	-6.93	-33.11	Peak
8 pp	5550.60	-42.02	-40.12	-13.00	-1.90	-29.02	Peak

Middle Channel



Bureau Veritas Consumer Products Services Ltd., Taoyuan Branch

A D T

Data: 3

Date: 06-08-2020

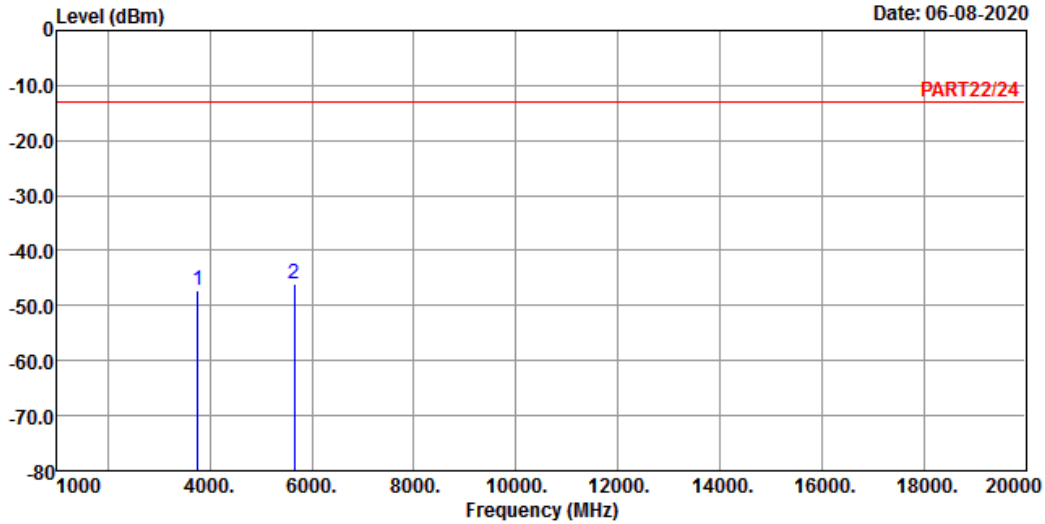

Site : 966 Chamber 5
 Condition: PART22/24 HORIZONTAL
 Remak : NB-IOT Band 25 Stand-alone_Link_M-Ch
 Tested by: Jisyong Wang

	Freq	Level	Read Level	Limit	Line Factor	Over Limit	Remark
	MHz	dBm	dBm	dBm	dB	dB	
1	3765.00	-47.11	-40.51	-13.00	-6.60	-34.11	Peak
2 pp	5647.50	-45.98	-44.15	-13.00	-1.83	-32.98	Peak



Bureau Veritas Consumer Products Services Ltd., Taoyuan Branch

A D T

Data: 4

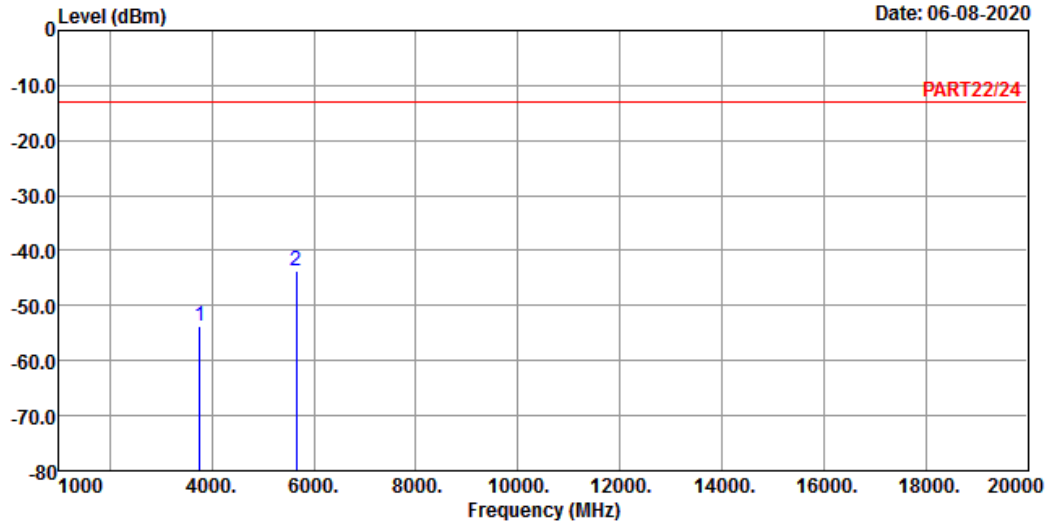

Site : 966 Chamber 5
 Condition: PART22/24 VERTICAL
 Remak : NB-IOT Band 25 Stand-alone_Link_M-Ch
 Tested by: Jisyong Wang

	Freq	Level	Read Level	Limit	Line Factor	Over Limit	Remark
	MHz	dBm	dBm	dBm	dB	dB	
1	3765.00	-53.85	-47.25	-13.00	-6.60	-40.85	Peak
2	5647.50	-43.62	-41.79	-13.00	-1.83	-30.62	Peak

High Channel



Bureau Veritas Consumer Products Services Ltd., Taoyuan Branch

A D T

Data: 3

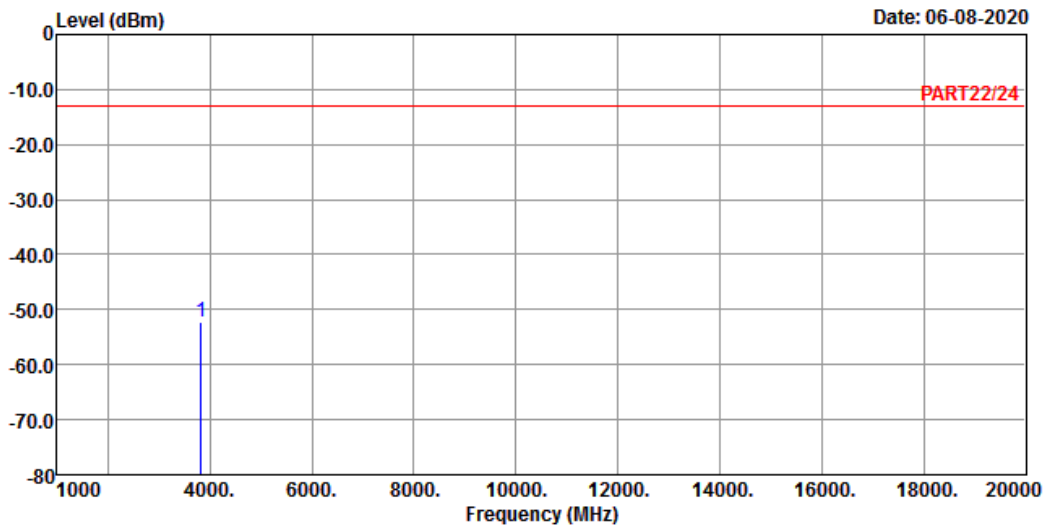

Site : 966 Chamber 5
 Condition: PART22/24 HORIZONTAL
 Remak : NB-IOT Band 25 Stand-alone_Link_H-Ch
 Tested by: Jisyong Wang

Freq	Level	Read Level	Limit	Line Factor	Over Limit	Remark
MHz	dBm	dBm	dBm	dB	dB	

1 pp 3829.60 -52.11 -45.74 -13.00 -6.37 -39.11 Peak



Bureau Veritas Consumer Products Services Ltd., Taoyuan Branch

A D T

Data: 4

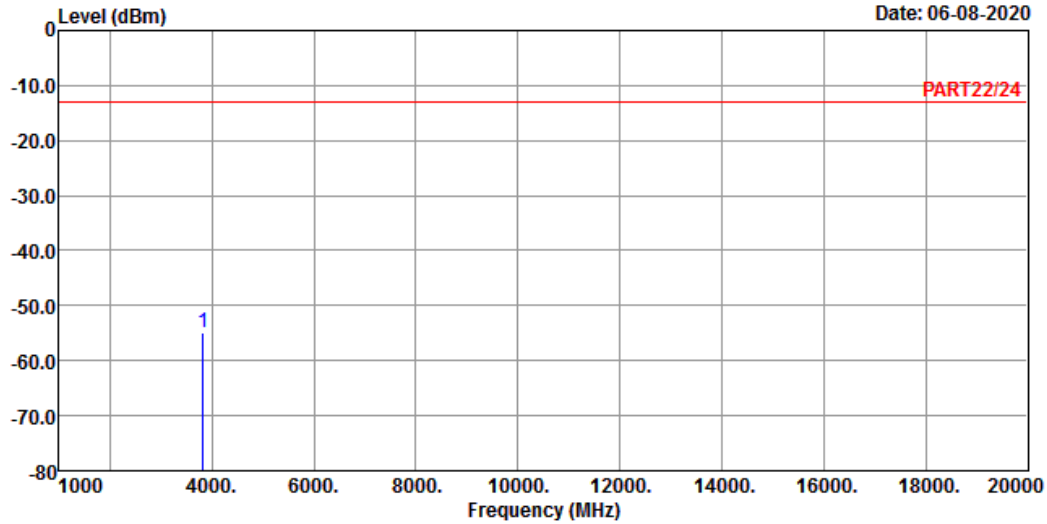

Site : 966 Chamber 5
 Condition: PART22/24 VERTICAL
 Remak : NB-IOT Band 25 Stand-alone_Link_H-Ch
 Tested by: Jisyong Wang

Freq	Level	Read Level	Limit	Line Factor	Over Limit	Remark
MHz	dBm	dBm	dBm	dB	dB	
1 pp 3829.60	-54.98	-48.61	-13.00	-6.37	-41.98	Peak

5 Pictures of Test Arrangements

Please refer to the attached file (Test Setup Photo).

Appendix – Information of the Testing Laboratories

We, Bureau Veritas Consumer Products Services (H.K.) Ltd., Taoyuan Branch, were founded in 1988 to provide our best service in EMC, Radio, Telecom and Safety consultation. Our laboratories are FCC recognized accredited test firms and accredited according to ISO/IEC 17025.

If you have any comments, please feel free to contact us at the following:

Lin Kou EMC/RF Lab

Tel: 886-2-26052180

Fax: 886-2-26051924

Hsin Chu EMC/RF/Telecom Lab

Tel: 886-3-6668565

Fax: 886-3-6668323

Hwa Ya EMC/RF/Safety Lab

Tel: 886-3-3183232

Fax: 886-3-3270892

Email: service.adt@tw.bureauveritas.com

Web Site: www.bureauveritas-adt.com

The address and road map of all our labs can be found in our web site also.

--- END ---