

FCC Test Report

FCC ID : N7NHL7588
Equipment : Wireless Module
Model No. : HL7588
Brand Name : AirPrime
Applicant : Sierra Wireless Inc.
Address : 13811 Wireless Way Richmond, BC, V6V 3A4
Canada
Standard : 47 CFR FCC Part 24 Subpart E
Received Date : Jul. 16, 2015
Tested Date : Jul. 20 ~ Jul. 30, 2015

We, International Certification Corp., would like to declare that the tested sample has been evaluated and in compliance with the requirement of the above standards. The test results contained in this report refer exclusively to the product. It may be duplicated completely for legal use with the approval of the applicant. It shall not be reproduced except in full without the written approval of our laboratory.

Approved & Reviewed by:



Gary Chang / Manager



Table of Contents

1	GENERAL DESCRIPTION	5
1.1	Information.....	5
1.2	Local Support Equipment List	8
1.3	Test Setup Chart	8
1.4	The Equipment List	9
1.5	Test Standards	10
1.6	Measurement Uncertainty	10
2	TEST CONFIGURATION.....	11
2.1	Testing Condition and Location Information.....	11
2.2	The Worst Test Modes and Channel Details	11
3	TEST RESULTS.....	13
3.1	Equivalent Isotropically Radiated Power	13
3.2	Radiated Emissions.....	22
3.3	Conducted Emissions.....	35
3.4	Band Edge.....	43
3.5	Occupied and 26 dB Bandwidth	69
3.6	Peak to Average Ratio	77
3.7	Frequency Stability	85
4	TEST LABORATORY INFORMATION	90

Release Record

Report No.	Version	Description	Issued Date
FG571601P24	Rev. 01	Initial issue	Aug. 17, 2015
FG571601P24	Rev. 02	Add temperature and humidity chamber in equipment list	Aug. 24, 2015

Summary of Test Results

FCC Rules	Test Items	Measured	Result
2.1046 / 24.232(c)	Equivalent Isotropically Radiated Power	Power[dBm]: WCDMA: 27.50 LTE: 25.95	Pass
2.1053 / 24.238(a)	Radiated Emissions	Meet the requirement of limit	Pass
2.1051 / 24.238(a)	Conducted Emissions	Meet the requirement of limit	Pass
2.1051 / 24.238(a)	Band Edge	Meet the requirement of limit	Pass
2.1049 / 24.238(b)	Occupied Bandwidth	Meet the requirement of limit	Pass
2.1051 / 24.232(d)	Peak to average ratio	Meet the requirement of limit	Pass
2.1055 / 24.235	Frequency Stability	Meet the requirement of limit	Pass

1 General Description

1.1 Information

1.1.1 Specification of the Equipment under Test (EUT)

Operating Band (MHz)	WCDMA BAND 2: 1852.4~1907.6 LTE Band 2: Channel Bandwidth: 1.4MHz: 1850.7~1909.3 Channel Bandwidth: 3MHz: 1851.5~1908.5 Channel Bandwidth: 5MHz: 1852.5~1907.5 Channel Bandwidth: 10MHz: 1855~1905 Channel Bandwidth: 15MHz: 1857.5~1902.5 Channel Bandwidth: 20MHz: 1860~1900
Modulation	WCDMA: QPSK (Uplink) LTE: QPSK, 16QAM (Uplink)
Release Version	WCDMA: R5 / R6 / R7 / R8 LTE: 8
Duplex Mode	FDD
UE Category	4
H/W Version	1.0
S/W Version	HL75xx.V.3.1

1.1.2 Maximum EIRP and Emission Designator

Mode	Modulation	Maximum EIRP (W)	Emission Designator
WCDMA 1900	QPSK	0.562	4M14F9W
LTE Band 2, CB: 1.4MHz	QPSK	0.373	1M09G7D
LTE Band 2, CB: 1.4MHz	16QAM	0.325	1M09W7D
LTE Band 2, CB: 3MHz	QPSK	0.362	2M69G7D
LTE Band 2, CB: 3MHz	16QAM	0.315	2M70W7D
LTE Band 2, CB: 5MHz	QPSK	0.379	4M50G7D
LTE Band 2, CB: 5MHz	16QAM	0.330	4M50W7D
LTE Band 2, CB: 10MHz	QPSK	0.385	9M03G7D
LTE Band 2, CB: 10MHz	16QAM	0.352	9M01W7D
LTE Band 2, CB: 15MHz	QPSK	0.394	13M46G7D
LTE Band 2, CB: 15MHz	16QAM	0.371	13M49W7D
LTE Band 2, CB: 20MHz	QPSK	0.392	18M02G7D
LTE Band 2, CB: 20MHz	16QAM	0.361	18M02W7D

1.1.3 Antenna Details

Ant. No.	Type	Gain (dBi)	Connector	Remark
1	Dipole	2	R-SMA	---

Note: The antenna is for testing use only.

1.1.4 EUT Operational Condition

Supply Voltage	3.7 Vdc from host		
Operational Voltage	<input checked="" type="checkbox"/> Vnom (3.7 V)	<input checked="" type="checkbox"/> Vmax (4.5 V)	<input checked="" type="checkbox"/> Vmin (3.2 V)
Operational Climatic	<input checked="" type="checkbox"/> Tnom (20°C)	<input checked="" type="checkbox"/> Tmax (55°C)	<input checked="" type="checkbox"/> Tmin (-20°C)

1.1.5 Operating Channel List

WCDMA Band 2		
Channel Location	Channel	Frequency (MHz)
Low	9262	1852.4
Middle	9400	1880.0
High	9538	1907.6

LTE Band 2		
Channel Bandwidth (MHz)	Channel	Frequency (MHz)
1.4	18607	1850.7
1.4	18900	1880.0
1.4	19193	1909.3
3	18615	1851.5
3	18900	1880.0
3	19185	1908.5
5	18625	1852.5
5	18900	1880.0
5	19175	1907.5
10	18650	1855.0
10	18900	1880.0
10	19150	1905.0
15	18675	1857.5
15	18900	1880.0
15	19125	1902.5
20	18700	1860.0
20	18900	1880.0
20	19100	1900.0

1.2 Local Support Equipment List

Support Equipment List						
No.	Equipment	Brand	Model	S/N	FCC ID	Signal cable / Length (m)
1	Power Supply	GWINSTEK	GPC-60300	EM884797	---	---

1.3 Test Setup Chart

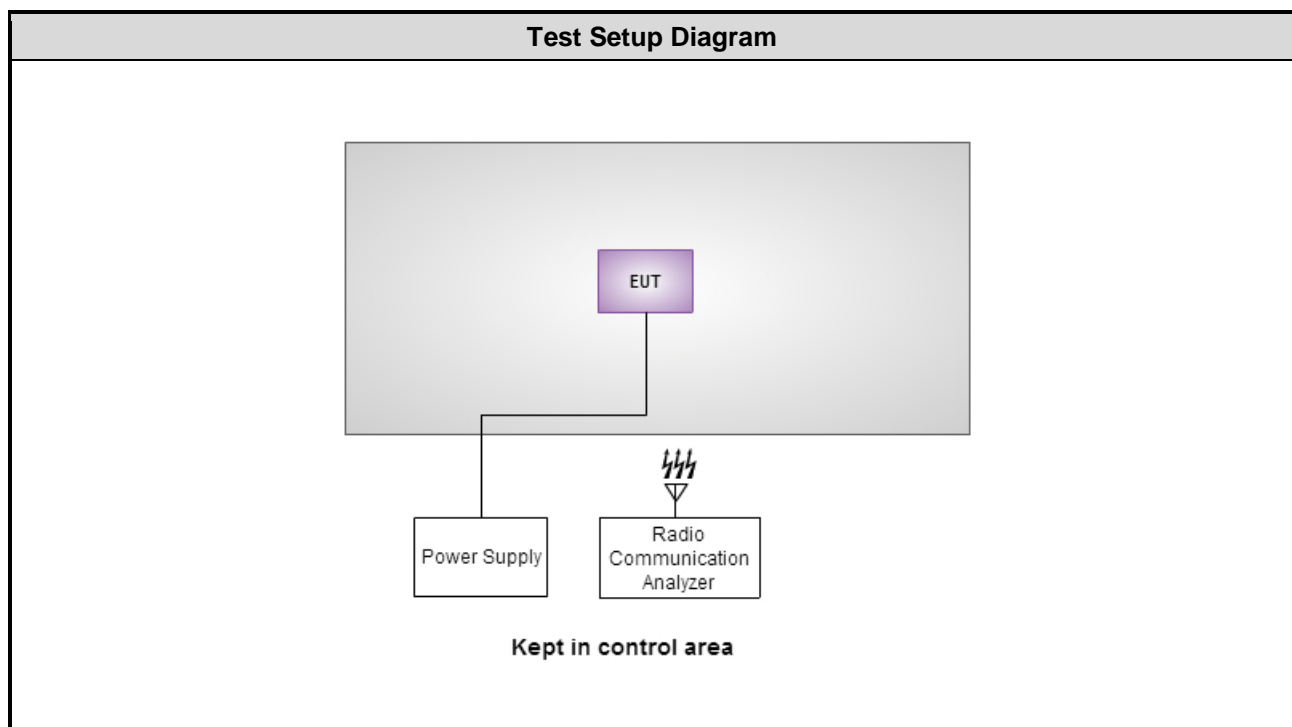

1.4 The Equipment List

Test Item	RF Conducted				
Test Site	(TH01-WS)				
Instrument	Manufacturer	Model No.	Serial No.	Calibration Date	Calibration Until
Spectrum Analyzer	R&S	FSV40	101063	Feb. 03, 2015	Feb. 02, 2016
TEMP&HUMIDITY CHAMBER	GIANT FORCE	GCT-225-40-SP-SD	MAF1212-002	Dec. 03, 2014	Dec. 02, 2015
Power Meter	Anritsu	ML2495A	1241002	Sep. 29, 2014	Sep. 28, 2015
Power Sensor	Anritsu	MA2411B	1207366	Sep. 29, 2014	Sep. 28, 2015
Radio Communication Analyzer	Anritsu	MT8820C	6201240341	Mar. 19, 2015	Mar. 17, 2016
Measurement Software	Sporton	Sporton_1	1.3.30	NA	NA

Note: Calibration Interval of instruments listed above is one year.

Test Item	Radiated Emission				
Test Site	966 chamber 2 / (03CH02-WS)				
Instrument	Manufacturer	Model No.	Serial No.	Calibration Date	Calibration Until
Spectrum Analyzer	R&S	FSV40	101499	Dec. 31, 2014	Dec. 30, 2015
Receiver	R&S	ESR3	101657	Jan. 15, 2015	Jan. 14, 2016
Bilog Antenna	SCHWARZBECK	VULB9168	VULB9168-524	Oct. 16, 2014	Oct. 15, 2015
Horn Antenna 1G-18G	SCHWARZBECK	BBHA 9120 D	BBHA 9120 D 1095	Oct. 14, 2014	Oct. 13, 2015
Horn Antenna 18G-40G	SCHWARZBECK	BBHA 9170	BBHA 9170517	Nov. 10, 2014	Nov. 09, 2015
Loop Antenna	R&S	HFH2-Z2	11900	Nov. 10, 2014	Nov. 09, 2015
Preamplifier	Burgeon	BPA-530	100218	Nov. 10, 2014	Nov. 09, 2015
Preamplifier	Agilent	83017A	MY39501309	Sep. 29, 2014	Sep. 28, 2015
Preamplifier	EMC	EMC184045B	980192	Aug. 26, 2014	Aug. 25, 2015
RF Cable	HUBER+SUHNER	SUCOFLEX104	MY16140/4	Dec. 16, 2014	Dec. 15, 2015
RF Cable	HUBER+SUHNER	SUCOFLEX104	MY16018/4	Dec. 16, 2014	Dec. 15, 2015
RF Cable	HUBER+SUHNER	SUCOFLEX104	MY16015/4	Dec. 16, 2014	Dec. 15, 2015
LF cable 3M	Woken	CFD400NL-LW	CFD400NL-003	Dec. 16, 2014	Dec. 15, 2015
LF cable 10M	Woken	CFD400NL-LW	CFD400NL-004	Dec. 16, 2014	Dec. 15, 2015
Measurement Software	AUDIX	e3	6.120210g	NA	NA

Note: Calibration Interval of instruments listed above is one year.

1.5 Test Standards

According to the specification of EUT, the EUT must comply with following standards.

47 CFR FCC Part 24 Subpart E

ANSI C63.4-2003

ANSI / TIA / EIA-603-D -2010

FCC KDB 971168 D01 Power Meas License Digital Systems v02r02

FCC KDB 412172 D01 Determining ERP and EIRP v01r01

1.6 Measurement Uncertainty

ISO/IEC 17025 requires that an estimate of the measurement uncertainties associated with the emissions test results be included in the report. The measurement uncertainties given below are based on a 95% confidence level (based on a coverage factor (k=2))

Measurement Uncertainty	
Parameters	Uncertainty
Bandwidth	±34.134 Hz
Conducted power	±0.808 dB
Frequency error	±34.134 Hz
Temperature	±0.6 °C
Conducted emission	±2.670 dB
AC conducted emission	±2.92 dB
Radiated emission ≤ 1GHz	±3.62 dB
Radiated emission > 1GHz	±5.60 dB

2 Test Configuration

2.1 Testing Condition and Location Information

Test Item	Test Site	Ambient Condition	Tested By
RF conducted	TH01-WS	23°C / 64%	Felix Sung
Radiated Emissions	03CH02-WS	22°C / 64%	Anderson Hung

FCC site registration No.: 657002

IC site registration No.: 10807A-2

2.2 The Worst Test Modes and Channel Details

WCDMA

Test item	Mode	Test channel
E.I.R.P	WCDMA BAND 2	9262, 9400, 9538
Radiated Emission \leq 1GHz	WCDMA BAND 2	9538
Radiated Emission $>$ 1GHz	WCDMA BAND 2	9262, 9400, 9538
Conducted Emissions	WCDMA BAND 2	9262, 9400, 9538
Band Edge	WCDMA BAND 2	9262, 9538
Occupied Bandwidth	WCDMA BAND 2	9262, 9400, 9538
Peak to average ratio	WCDMA BAND 2	9262, 9400, 9538
Frequency Stability	WCDMA BAND 2	9400

Note:

- The EUT was pretested with 3 orientations placed on the table for the radiated emission measurement – X, Y, and Z-plane. The **Y-plane** results were found as the worst case and were shown in this report.

LTE

Test item	Channel Bandwidth	Modulation	Test channel
E.I.R.P	1.4 MHz	QPSK / 16QAM	18607 / 18900 / 19193
Conducted Emissions	3 MHz	QPSK / 16QAM	18615 / 18900 / 19185
Occupied Bandwidth	5 MHz	QPSK / 16QAM	18625 / 18900 / 19175
Peak to Average Ratio	10 MHz	QPSK / 16QAM	18650 / 18900 / 19150
	15 MHz	QPSK / 16QAM	18675 / 18900 / 19125
	20 MHz	QPSK / 16QAM	18700 / 18900 / 19100
Radiated Emission ≤ 1GHz	1.4 MHz	QPSK	18900
	3 MHz	QPSK	19185
	5 MHz	QPSK	19175
	10 MHz	QPSK	19150
	15 MHz	QPSK	19125
	20 MHz	QPSK	19100
Radiated Emission > 1GHz	1.4 MHz	QPSK	18607 / 18900 / 19193
	3 MHz	QPSK	18615 / 18900 / 19185
	5 MHz	QPSK	18625 / 18900 / 19175
	10 MHz	QPSK	18650 / 18900 / 19150
	15 MHz	QPSK	18675 / 18900 / 19125
	20 MHz	QPSK	18700 / 18900 / 19100
Band Edge	1.4 MHz	QPSK / 16QAM	18607 / 19193
	3 MHz	QPSK / 16QAM	18615 / 19185
	5 MHz	QPSK / 16QAM	18625 / 19175
	10 MHz	QPSK / 16QAM	18650 / 19150
	15 MHz	QPSK / 16QAM	18675 / 19125
	20 MHz	QPSK / 16QAM	18700 / 19100
Frequency Stability	1.4 MHz	QPSK	18900
	3 MHz	QPSK	18900
	5 MHz	QPSK	18900
	10 MHz	QPSK	18900
	15 MHz	QPSK	18900
	20 MHz	QPSK	18900
Note:			
1. The EUT was pretested with 3 orientations placed on the table for the radiated emission measurement – X, Y, and Z-plane. The Y-plane results were found as the worst case and were shown in this report.			

3 Test Results

3.1 Equivalent Isotropically Radiated Power

3.1.1 Limit of Equivalent Isotropically Radiated Power

Mobile and portable stations are limited to 2 watts EIRP.

3.1.2 Test Procedures

For Conducted power measurement:

1. The EUT links up with simulator and is set to maximum output power level at low / middle / high channel.
2. Measure the output power of low / middle / high channel of the EUT.

For EIRP measurement:

EIPR can be calculated by below formula from KDB 412172 D01.

1. $EIRP = P_T + G_T - L_C$

P_T = transmitter output power, in dBm.

G_T = gain of the transmitting antenna, in dBi (EIRP).

L_C = signal attenuation in the connecting cable between the transmitter and antenna, in dB.

3.1.3 Test Setup

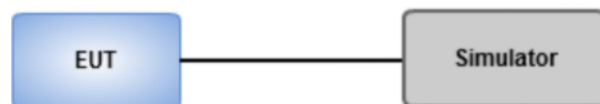

3.1.4 Test Result of Conducted power (dBm)

Band	WCDMA BAND 2		
Channel	9262	9400	9538
Frequency (MHz)	1852.4	1880.0	1907.6
RMC 12.2K	25.45	25.41	25.50
HSDPA Subtest-1	25.16	25.12	25.18
HSDPA Subtest-2	25.25	25.23	25.29
HSDPA Subtest-3	25.06	25.01	25.12
HSDPA Subtest-4	25.07	25.03	25.16
DC-HSDPA Subtest-1	25.12	25.13	25.12
DC-HSDPA Subtest-2	25.18	25.11	25.23
DC-HSDPA Subtest-3	24.89	24.92	25.07
DC-HSDPA Subtest-4	24.96	24.97	25.11
HSUPA Subtest-1	24.83	24.81	24.85
HSUPA Subtest-2	22.84	22.83	22.89
HSUPA Subtest-3	23.89	23.86	23.92
HSUPA Subtest-4	23.06	23.02	23.09
HSUPA Subtest-5	25.29	25.30	25.33

Band / Channel Bandwidth			LTE Band 2 / CB: 1.4MHz		
Channel			18607	18900	19193
Frequency (MHz)			1850.7	1880.0	1909.3
Mode	RB	RB Offset	Maximum AV Power (dBm)		
QPSK	1	0	23.71	23.72	23.70
	1	2	23.63	23.66	23.68
	1	5	23.61	23.65	23.66
	3	0	23.52	23.51	23.49
	3	1	23.55	23.54	23.65
	3	2	23.51	23.55	23.59
	6	0	22.83	22.76	22.83
16QAM	1	0	23.11	23.02	23.12
	1	2	22.93	22.89	22.93
	1	5	22.89	22.85	22.89
	3	0	22.85	22.81	22.83
	3	1	22.83	22.80	22.85
	3	2	22.81	22.83	22.86
	6	0	21.88	21.96	22.03

Band / Channel Bandwidth			LTE Band 2 / CB: 3MHz		
Channel			18615	18900	19185
Frequency (MHz)			1851.5	1880.0	1908.5
Mode	RB	RB Offset	Maximum AV Power (dBm)		
QPSK	1	0	23.43	23.55	23.59
	1	7	23.40	23.51	23.46
	1	14	23.42	23.52	23.46
	8	0	22.73	22.79	22.73
	8	4	22.71	22.77	22.71
	8	7	22.73	22.76	22.73
	15	0	22.77	22.75	22.72
16QAM	1	0	22.89	22.98	22.89
	1	7	22.86	22.92	22.88
	1	14	22.88	22.92	22.95
	8	0	21.83	21.88	21.83
	8	4	21.81	21.82	21.76
	8	7	21.86	21.85	21.77
	15	0	21.80	21.82	21.83

Band / Channel Bandwidth			LTE Band 2 / CB: 5MHz		
Channel			18625	18900	19175
Frequency (MHz)			1852.5	1880.0	1907.5
Mode	RB	RB Offset	Maximum AV Power (dBm)		
QPSK	1	0	23.45	23.45	23.79
	1	12	23.38	23.36	23.63
	1	24	23.33	23.31	23.48
	12	0	22.66	22.60	22.96
	12	6	22.56	22.53	22.86
	12	11	23.48	22.53	22.73
	25	0	22.53	22.53	22.85
16QAM	1	0	22.95	22.90	23.18
	1	12	22.89	22.81	23.03
	1	24	22.77	22.71	22.89
	12	0	21.82	21.78	22.01
	12	6	21.72	21.69	21.92
	12	11	21.72	21.66	21.91
	25	0	21.73	21.65	21.94

Band / Channel Bandwidth			LTE Band 2 / CB: 10MHz		
Channel			18650	18900	19150
Frequency (MHz)			1855.0	1880.0	1905.0
Mode	RB	RB Offset	Maximum AV Power (dBm)		
QPSK	1	0	23.48	23.36	23.86
	1	24	23.17	23.30	23.39
	1	49	23.47	23.20	23.23
	25	0	22.64	22.65	23.05
	25	12	22.51	22.53	22.91
	25	24	22.44	22.44	22.77
	50	0	22.47	22.57	22.93
16QAM	1	0	23.43	22.85	23.46
	1	24	22.75	22.58	23.32
	1	49	22.61	22.88	23.08
	25	0	21.83	21.83	22.10
	25	12	21.64	21.68	21.89
	25	24	21.68	21.65	21.85
	50	0	21.70	21.77	22.01

Band / Channel Bandwidth			LTE Band 2 / CB: 15MHz		
Channel			18675	18900	19125
Frequency (MHz)			1857.5	1880.0	1902.5
Mode	RB	RB Offset	Maximum AV Power (dBm)		
QPSK	1	0	23.73	23.65	23.95
	1	37	23.37	23.17	23.46
	1	74	23.38	23.00	23.08
	36	0	22.77	22.64	23.24
	36	18	22.61	22.58	23.01
	36	37	22.51	22.56	22.77
	75	0	22.59	22.64	22.98
16QAM	1	0	23.11	23.17	23.69
	1	37	23.02	22.74	23.24
	1	74	22.54	22.61	22.96
	36	0	22.00	21.84	22.33
	36	18	21.74	21.66	22.01
	36	37	21.53	21.69	21.85
	75	0	21.73	21.76	22.01

Band / Channel Bandwidth			LTE Band 2 / CB: 20MHz		
Channel			18700	18900	19100
Frequency (MHz)			1860.0	1880.0	1900.0
Mode	RB	RB Offset	Maximum AV Power (dBm)		
QPSK	1	0	23.79	23.88	23.93
	1	49	23.07	23.09	23.54
	1	99	22.96	23.15	23.03
	50	0	22.90	22.80	23.07
	50	24	22.56	22.54	22.95
	50	49	22.49	22.57	22.66
	100	0	22.71	22.67	22.89
16QAM	1	0	23.08	23.28	23.58
	1	49	22.77	22.28	23.27
	1	99	22.59	22.61	22.73
	50	0	21.93	22.05	22.29
	50	24	21.69	21.61	21.89
	50	49	21.62	21.58	21.85
	100	0	21.78	21.87	21.97

3.1.5 Test Result of Equivalent Isotropically Radiated Power (dBm)

Mode	WCDMA BAND 2, RMC 12.2K					
Channel	Frequency (MHz)	Conducted Output Power (dBm)	Max Antenna Gain (dBi)	EIRP (dBm)	EIRP (W)	Limit (W)
9262	1852.4	25.45	2	27.45	0.556	2
9400	1880.0	25.41	2	27.41	0.551	2
9538	1907.6	25.50	2	27.50	0.562	2

Mode	LTE CB: 1.4MHz, QPSK					
Channel	Frequency (MHz)	Conducted Output Power (dBm)	Max Antenna Gain (dBi)	EIRP (dBm)	EIRP (W)	Limit (W)
18607	1850.7	23.71	2	25.71	0.372	2
18900	1880.0	23.72	2	25.72	0.373	2
19193	1909.3	23.70	2	25.70	0.372	2

Mode	LTE CB: 1.4MHz, 16QAM					
Channel	Frequency (MHz)	Conducted Output Power (dBm)	Max Antenna Gain (dBi)	EIRP (dBm)	EIRP (W)	Limit (W)
18607	1850.7	23.11	2	25.11	0.324	2
18900	1880.0	23.02	2	25.02	0.318	2
19193	1909.3	23.12	2	25.12	0.325	2

Mode	LTE CB: 3MHz, QPSK					
Channel	Frequency (MHz)	Conducted Output Power (dBm)	Max Antenna Gain (dBi)	EIRP (dBm)	EIRP (W)	Limit (W)
18615	1851.5	23.43	2	25.43	0.349	2
18900	1880.0	23.55	2	25.55	0.359	2
19185	1908.5	23.59	2	25.59	0.362	2

Mode	LTE CB: 3MHz, 16QAM					
Channel	Frequency (MHz)	Conducted Output Power (dBm)	Max Antenna Gain (dBi)	EIRP (dBm)	EIRP (W)	Limit (W)
18615	1851.5	22.89	2	24.89	0.308	2
18900	1880.0	22.98	2	24.98	0.315	2
19185	1908.5	22.95	2	24.95	0.313	2

Mode	LTE CB: 5MHz, QPSK					
Channel	Frequency (MHz)	Conducted Output Power (dBm)	Max Antenna Gain (dBi)	EIRP (dBm)	EIRP (W)	Limit (W)
18625	1852.5	23.45	2	25.45	0.351	2
18900	1880.0	23.45	2	25.45	0.351	2
19175	1907.5	23.79	2	25.79	0.379	2

Mode	LTE CB: 5MHz, 16QAM					
Channel	Frequency (MHz)	Conducted Output Power (dBm)	Max Antenna Gain (dBi)	EIRP (dBm)	EIRP (W)	Limit (W)
18625	1852.5	22.95	2	24.95	0.313	2
18900	1880.0	22.90	2	24.90	0.309	2
19175	1907.5	23.18	2	25.18	0.330	2

Mode	LTE CB: 10MHz, QPSK					
Channel	Frequency (MHz)	Conducted Output Power (dBm)	Max Antenna Gain (dBi)	EIRP (dBm)	EIRP (W)	Limit (W)
18650	1855.0	23.48	2	25.48	0.353	2
18900	1880.0	23.36	2	25.36	0.344	2
19150	1905.0	23.86	2	25.86	0.385	2

Mode	LTE CB: 10MHz, 16QAM					
Channel	Frequency (MHz)	Conducted Output Power (dBm)	Max Antenna Gain (dBi)	EIRP (dBm)	EIRP (W)	Limit (W)
18650	1855.0	23.43	2	25.43	0.349	2
18900	1880.0	22.88	2	24.88	0.308	2
19150	1905.0	23.46	2	25.46	0.352	2

Mode	LTE CB: 15MHz, QPSK					
Channel	Frequency (MHz)	Conducted Output Power (dBm)	Max Antenna Gain (dBi)	EIRP (dBm)	EIRP (W)	Limit (W)
18675	1857.5	23.73	2	25.73	0.374	2
18900	1880.0	23.65	2	25.65	0.367	2
19125	1902.5	23.95	2	25.95	0.394	2

Mode	LTE CB: 15MHz, 16QAM					
Channel	Frequency (MHz)	Conducted Output Power (dBm)	Max Antenna Gain (dBi)	EIRP (dBm)	EIRP (W)	Limit (W)
18675	1857.5	23.11	2	25.11	0.324	2
18900	1880.0	23.17	2	25.17	0.329	2
19125	1902.5	23.69	2	25.69	0.371	2

Mode	LTE CB: 20MHz, QPSK					
Channel	Frequency (MHz)	Conducted Output Power (dBm)	Max Antenna Gain (dBi)	EIRP (dBm)	EIRP (W)	Limit (W)
18700	1860.0	23.79	2	25.79	0.379	2
18900	1880.0	23.88	2	25.88	0.387	2
19100	1900.0	23.93	2	25.93	0.392	2

Mode	LTE CB: 20MHz, 16QAM					
Channel	Frequency (MHz)	Conducted Output Power (dBm)	Max Antenna Gain (dBi)	EIRP (dBm)	EIRP (W)	Limit (W)
18700	1860.0	23.08	2	25.08	0.322	2
18900	1880.0	23.28	2	25.28	0.337	2
19100	1900.0	23.58	2	25.58	0.361	2

3.2 Radiated Emissions

3.2.1 Limit of Radiated Emissions

The power of any emission outside of the authorized operating frequency ranges must be attenuated below the transmitting power (P) by a factor of at least $43 + 10 \log(P)$ dB equal to -13dBm.

3.2.2 Test Procedures

1. Measurement is made at a semi-anechoic chamber that incorporates a turntable allowing a EUT rotation of 360°. A continuously-rotating, remotely-controlled turntable is installed at the test site to support the EUT and facilitate determination of the direction of maximum radiation for each EUT emission frequency. The EUT is placed at a height of 0.8 m test table above the ground plane.
2. Measurement is made with the antenna positioned in both the horizontal and vertical planes of polarization. The measurement antenna is varied in height (1m ~ 4m) above the reference ground plane to obtain the maximum signal strength. Distance between EUT and antenna is 3 m.
3. This investigation is performed with the EUT rotated 360°, the antenna height scanned between 1 m and 4 m, and the antenna rotated to repeat the measurements for both the horizontal and vertical antenna polarizations.
4. After finding the max radiated emission, substitution method will be used for getting effective radiated power. EUT will be removed and substitution antenna will be placed at same position. Signal generator will output CW signal to substitution antenna through a RF cable. Rotate turntable and move antenna to find maximum radiated emission. Adjust output power of signal generator to let the maximum radiated emission is same as step 3. Record the output power level.
5. E.I.R.P = output power of step 4 + gain of substitution antenna – cable loss of RF cable.

3.2.3 Test Setup

Radiated Emissions below 1 GHz

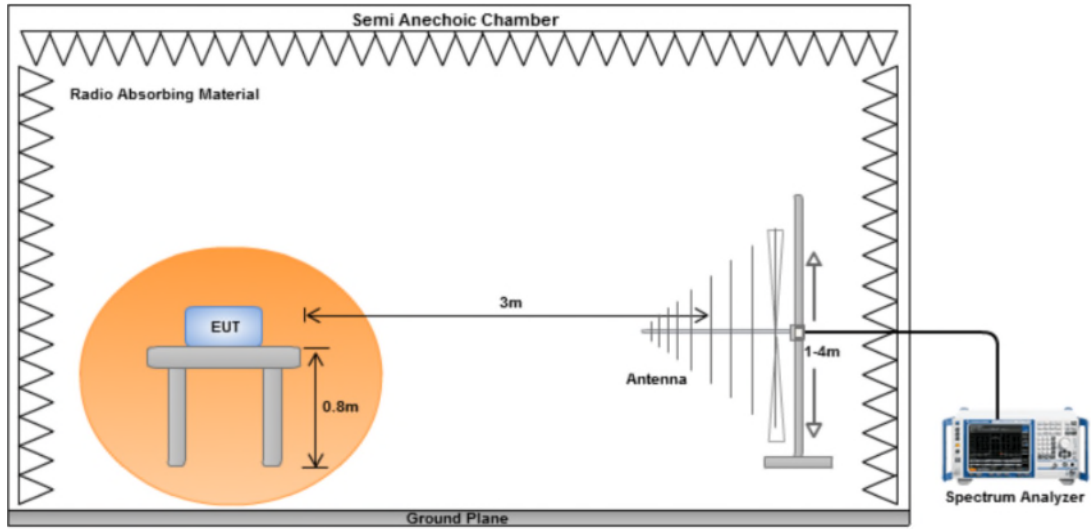

Radiated Emissions above 1 GHz

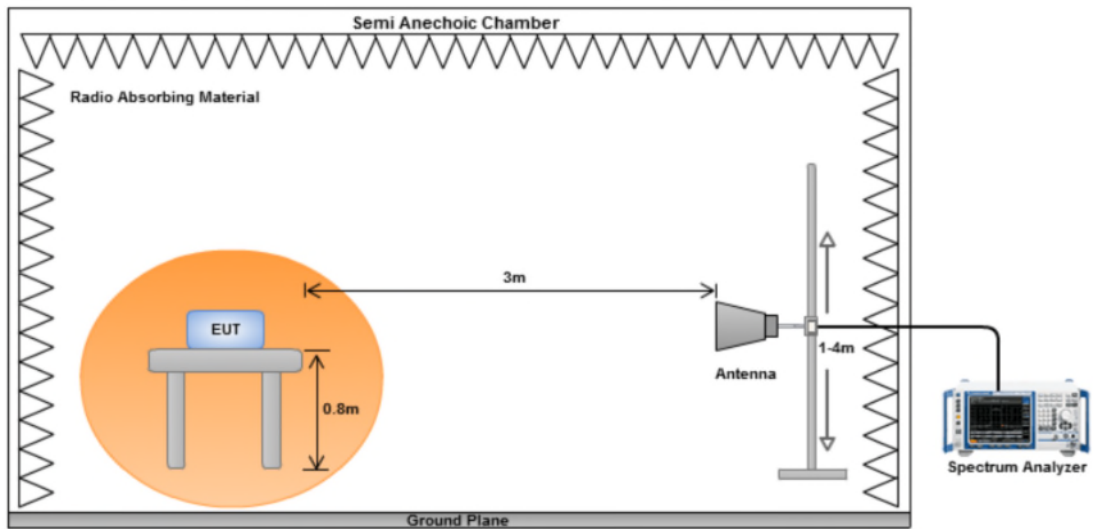

3.2.4 Test Result of Radiated Emissions below 1GHz

Mode		WCDMA Band 2 , Channel : 9538					
Frequency (MHz)	Antenna Polarity	E.I.R.P (dBm)	Limit (dBm)	Margin (dB)	S.A Reading (dBm)	S.G Power Vaule (dBm)	Correction Factor (dB)
94.02	H	-61.82	-13.00	-48.82	-54.95	-62.21	0.39
106.63	H	-61.90	-13.00	-48.90	-54.85	-61.85	-0.05
142.52	H	-62.88	-13.00	-49.88	-57.60	-61.59	-1.29
169.68	H	-62.36	-13.00	-49.36	-56.03	-62.94	0.58
283.17	H	-67.29	-13.00	-54.29	-60.52	-71.55	4.26
43.58	V	-53.96	-13.00	-40.96	-46.77	-42.18	-11.78
97.90	V	-55.64	-13.00	-42.64	-48.64	-55.95	0.31
127.00	V	-57.36	-13.00	-44.36	-53.46	-56.43	-0.93
161.92	V	-57.78	-13.00	-44.78	-54.95	-57.21	-0.57
254.07	V	-65.68	-13.00	-52.68	-62.66	-70.04	4.36
290.93	V	-63.50	-13.00	-50.50	-59.95	-67.73	4.23
94.02	H	-61.82	-13.00	-48.82	-54.95	-62.21	0.39

Note: EIRP = S.G Power value + Correction factor.

Mode	LTE Band 2, CB: 1.4MHz, 1RB, Offset 0,Channel: 18900						
Frequency (MHz)	Antenna Polarity	E.I.R.P (dBm)	Limit (dBm)	Margin (dB)	S.A Reading (dBm)	S.G Power Vaule (dBm)	Correction Factor (dB)
37.76	H	-55.57	-13.00	-42.57	-58.36	-42.96	-12.61
108.57	H	-54.95	-13.00	-41.95	-47.85	-54.80	-0.15
174.53	H	-57.44	-13.00	-44.44	-50.86	-58.74	1.30
251.16	H	-62.03	-13.00	-49.03	-54.35	-66.40	4.37
425.76	H	-61.97	-13.00	-48.97	-59.43	-66.16	4.19
747.80	H	-58.31	-13.00	-45.31	-61.57	-61.72	3.41
37.76	V	-48.28	-13.00	-35.28	-40.56	-35.67	-12.61
92.08	V	-53.84	-13.00	-40.84	-46.62	-54.26	0.42
169.68	V	-52.99	-13.00	-39.99	-49.84	-53.57	0.58
300.63	V	-56.83	-13.00	-43.83	-53.16	-61.03	4.20
386.96	V	-59.07	-13.00	-46.07	-56.32	-63.39	4.32
721.61	V	-60.05	-13.00	-47.05	-64.22	-63.66	3.61

Note: EIRP = S.G Power value + Correction factor.

Mode	LTE Band 2, CB: 3MHz, 1RB, Offset 0,Channel: 19185						
Frequency (MHz)	Antenna Polarity	E.I.R.P (dBm)	Limit (dBm)	Margin (dB)	S.A Reading (dBm)	S.G Power Vaule (dBm)	Correction Factor (dB)
36.79	H	-56.03	-13.00	-43.03	-58.78	-43.28	-12.75
107.60	H	-57.19	-13.00	-44.19	-50.12	-57.09	-0.10
171.62	H	-64.14	-13.00	-51.14	-57.71	-65.01	0.87
294.81	H	-67.30	-13.00	-54.30	-60.86	-71.52	4.22
404.42	H	-65.86	-13.00	-52.86	-62.93	-70.13	4.27
747.80	H	-59.94	-13.00	-46.94	-63.20	-63.35	3.41
37.76	V	-53.17	-13.00	-40.17	-45.45	-40.56	-12.61
90.14	V	-53.27	-13.00	-40.27	-46.00	-53.73	0.46
146.40	V	-51.73	-13.00	-38.73	-48.39	-50.54	-1.19
209.45	V	-57.43	-13.00	-44.43	-53.81	-61.82	4.39
265.71	V	-60.84	-13.00	-47.84	-57.66	-65.16	4.32
729.37	V	-57.72	-13.00	-44.72	-61.94	-61.27	3.55

Note: EIRP = S.G Power value + Correction factor.

Mode	LTE Band 2, CB: 5MHz, 1RB, Offset 0,Channel: 19175						
Frequency (MHz)	Antenna Polarity	E.I.R.P (dBm)	Limit (dBm)	Margin (dB)	S.A Reading (dBm)	S.G Power Vaule (dBm)	Correction Factor (dB)
36.79	H	-52.80	-13.00	-39.80	-55.55	-40.05	-12.75
98.87	H	-59.70	-13.00	-46.70	-52.86	-59.99	0.29
115.36	H	-61.86	-13.00	-48.86	-54.55	-61.38	-0.48
136.70	H	-54.92	-13.00	-41.92	-49.36	-53.68	-1.24
187.14	H	-58.91	-13.00	-45.91	-51.04	-61.84	2.93
354.95	H	-68.93	-13.00	-55.93	-65.84	-73.34	4.41
35.82	V	-52.57	-13.00	-39.57	-44.64	-39.68	-12.89
96.93	V	-52.92	-13.00	-39.92	-45.87	-53.25	0.33
144.46	V	-53.85	-13.00	-40.85	-50.42	-52.61	-1.24
168.71	V	-56.00	-13.00	-43.00	-52.89	-56.44	0.44
201.69	V	-60.85	-13.00	-47.85	-57.10	-65.24	4.39
275.41	V	-59.74	-13.00	-46.74	-56.41	-64.02	4.28

Note: EIRP = S.G Power value + Correction factor.

Mode	LTE Band 2, CB: 10MHz, 1RB, Offset 0,Channel: 19150						
Frequency (MHz)	Antenna Polarity	E.I.R.P (dBm)	Limit (dBm)	Margin (dB)	S.A Reading (dBm)	S.G Power Vaule (dBm)	Correction Factor (dB)
36.79	H	-56.79	-13.00	-43.79	-59.54	-44.04	-12.75
97.90	H	-59.65	-13.00	-46.65	-52.81	-59.96	0.31
107.60	H	-57.92	-13.00	-44.92	-50.85	-57.82	-0.10
163.86	H	-60.13	-13.00	-47.13	-54.11	-59.85	-0.28
270.56	H	-66.84	-13.00	-53.84	-59.72	-71.14	4.30
333.61	H	-66.99	-13.00	-53.99	-62.85	-71.34	4.35
34.85	V	-50.76	-13.00	-37.76	-42.74	-37.72	-13.04
96.93	V	-53.22	-13.00	-40.22	-46.17	-53.55	0.33
108.57	V	-55.63	-13.00	-42.63	-49.97	-55.48	-0.15
222.06	V	-55.42	-13.00	-42.42	-52.00	-59.80	4.38
249.22	V	-61.39	-13.00	-48.39	-58.42	-65.76	4.37
395.69	V	-59.85	-13.00	-46.85	-57.20	-64.15	4.30

Note: EIRP = S.G Power value + Correction factor.

Mode	LTE Band 2, CB: 15MHz, 1RB, Offset 0,Channel: 19125						
Frequency (MHz)	Antenna Polarity	E.IR.P (dBm)	Limit (dBm)	Margin (dB)	S.A Reading (dBm)	S.G Power Vaule (dBm)	Correction Factor (dB)
30.00	H	-52.35	-13.00	-39.35	-54.48	-37.97	-14.38
38.73	H	-56.33	-13.00	-43.33	-59.16	-43.85	-12.48
97.90	H	-59.36	-13.00	-46.36	-52.52	-59.67	0.31
130.88	H	-62.55	-13.00	-49.55	-56.33	-61.49	-1.06
172.59	H	-62.99	-13.00	-49.99	-56.51	-64.01	1.02
194.90	H	-67.99	-13.00	-54.99	-59.04	-71.80	3.81
36.79	V	-48.05	-13.00	-35.05	-40.22	-35.30	-12.75
91.11	V	-53.78	-13.00	-40.78	-46.54	-54.22	0.44
119.24	V	-44.82	-13.00	-31.82	-40.66	-44.15	-0.67
204.60	V	-57.25	-13.00	-44.25	-53.55	-61.64	4.39
270.56	V	-53.02	-13.00	-40.02	-49.77	-57.32	4.30
409.27	V	-58.90	-13.00	-45.90	-56.42	-63.15	4.25

Note: EIRP = S.G Power value + Correction factor.

Mode	LTE Band 2, CB: 20MHz, 1RB, Offset 0,Channel: 19100						
Frequency (MHz)	Antenna Polarity	E.R.P (dBm)	Limit (dBm)	Margin (dB)	S.A Reading (dBm)	S.G Power Vaule (dBm)	Correction Factor (dB)
42.61	H	-59.39	-13.00	-46.39	-61.58	-47.47	-11.92
98.87	H	-57.54	-13.00	-44.54	-50.70	-57.83	0.29
107.60	H	-56.25	-13.00	-43.25	-49.18	-56.15	-0.10
138.64	H	-61.73	-13.00	-48.73	-56.39	-60.42	-1.31
167.74	H	-65.77	-13.00	-52.77	-59.54	-66.06	0.29
270.56	H	-68.84	-13.00	-55.84	-61.72	-73.14	4.30
37.76	V	-50.27	-13.00	-37.27	-42.55	-37.66	-12.61
90.14	V	-53.89	-13.00	-40.89	-46.62	-54.35	0.46
140.58	V	-46.59	-13.00	-33.59	-43.01	-45.25	-1.34
161.92	V	-56.66	-13.00	-43.66	-53.83	-56.09	-0.57
211.39	V	-59.46	-13.00	-46.46	-55.87	-63.85	4.39
790.48	V	-56.50	-13.00	-43.50	-60.50	-59.70	3.20

Note: EIRP = S.G Power value + Correction factor.

3.2.5 Test Result of Radiated Emissions above 1GHz

Mode		WCDMA Band 2 , Channel : 9262					
Frequency (MHz)	Antenna Polarity	E.I.R.P (dBm)	Limit (dBm)	Margin (dB)	S.A Reading (dBm)	S.G Power Vaule (dBm)	Correction Factor (dB)
3704.80	H	-49.50	-13.00	-36.50	-63.66	-56.08	6.58
5557.20	H	-44.50	-13.00	-31.50	-63.26	-50.38	5.88
7409.60	H	-42.59	-13.00	-29.59	-63.87	-45.47	2.88
3704.80	V	-46.76	-13.00	-33.76	-60.43	-53.34	6.58
5557.20	V	-41.48	-13.00	-28.48	-58.77	-47.36	5.88
7409.60	V	-43.74	-13.00	-30.74	-63.51	-46.62	2.88

Mode		WCDMA Band 2 , Channel : 9400					
Frequency (MHz)	Antenna Polarity	E.I.R.P (dBm)	Limit (dBm)	Margin (dB)	S.A Reading (dBm)	S.G Power Vaule (dBm)	Correction Factor (dB)
3760.00	H	-40.58	-13.00	-27.58	-55.22	-47.16	6.58
5640.00	H	-45.19	-13.00	-32.19	-64.41	-51.04	5.85
7520.00	H	-42.74	-13.00	-29.74	-63.29	-45.70	2.96
3760.00	V	-35.17	-13.00	-22.17	-49.30	-41.75	6.58
5640.00	V	-45.00	-13.00	-32.00	-62.62	-50.85	5.85
7520.00	V	-41.81	-13.00	-28.81	-61.55	-44.77	2.96

Mode		WCDMA Band 2 , Channel : 9538					
Frequency (MHz)	Antenna Polarity.	E.I.R.P (dBm)	Limit (dBm)	Margin (dB)	S.A Reading (dBm)	S.G Power Vaule (dBm)	Correction Factor (dB)
3815.20	H	-43.50	-13.00	-30.50	-58.47	-50.06	6.56
5722.80	H	-44.14	-13.00	-31.14	-63.23	-49.95	5.81
7630.40	H	-42.47	-13.00	-29.47	-62.65	-45.37	2.90
3815.20	V	-39.32	-13.00	-26.32	-53.78	-45.88	6.56
5722.80	V	-43.22	-13.00	-30.22	-61.07	-49.03	5.81
7630.40	V	-43.31	-13.00	-30.31	-63.11	-46.21	2.90

Note: EIRP = S.G Power value + Correction factor

Mode							
LTE Band 2, CB: 1.4MHz, 1RB, Offset 0,Channel: 18607							
Frequency (MHz)	Antenna Polarity	E.I.R.P (dBm)	Limit (dBm)	Margin (dB)	S.A Reading (dBm)	S.G Power Vaule (dBm)	Correction Factor (dB)
3701.50	H	-46.52	-13.00	-33.52	-60.65	-53.10	6.58
5550.70	H	-42.93	-13.00	-29.93	-61.61	-48.81	5.88
7401.60	H	-42.02	-13.00	-29.02	-63.35	-44.89	2.87
3701.50	V	-41.32	-13.00	-28.32	-54.97	-47.90	6.58
5550.70	V	-37.26	-13.00	-24.26	-54.52	-43.14	5.88
7401.60	V	-40.38	-13.00	-27.38	-60.15	-43.25	2.87

Mode							
LTE Band 2, CB: 1.4MHz, 1RB, Offset 0,Channel: 18900							
Frequency (MHz)	Antenna Polarity	E.I.R.P (dBm)	Limit (dBm)	Margin (dB)	S.A Reading (dBm)	S.G Power Vaule (dBm)	Correction Factor (dB)
3759.00	H	-40.29	-13.00	-27.29	-54.92	-46.87	6.58
5638.90	H	-45.01	-13.00	-32.01	-64.23	-50.86	5.85
7517.40	H	-41.67	-13.00	-28.67	-62.24	-44.63	2.96
3759.00	V	-33.29	-13.00	-20.29	-47.41	-39.87	6.58
5638.90	V	-45.36	-13.00	-32.36	-62.97	-51.21	5.85
7517.40	V	-43.55	-13.00	-30.55	-63.29	-46.51	2.96

Mode							
LTE Band 2, CB: 1.4MHz, 1RB, Offset 0,Channel: 19193							
Frequency (MHz)	Antenna Polarity.	E.I.R.P (dBm)	Limit (dBm)	Margin (dB)	S.A Reading (dBm)	S.G Power Vaule (dBm)	Correction Factor (dB)
3818.40	H	-35.47	-13.00	-22.47	-50.44	-42.03	6.56
5725.80	H	-44.05	-13.00	-31.05	-63.12	-49.86	5.81
7636.00	H	-42.32	-13.00	-29.32	-62.52	-45.20	2.88
3818.40	V	-32.57	-13.00	-19.57	-47.02	-39.13	6.56
5725.80	V	-43.96	-13.00	-30.96	-61.81	-49.77	5.81
7636.00	V	-42.68	-13.00	-29.68	-62.48	-45.56	2.88

Note: EIRP = S.G Power value + Correction factor.

Mode							
LTE Band 2, CB: 3MHz, 1RB, Offset 0,Channel: 18615							
Frequency (MHz)	Antenna Polarity	E.I.R.P (dBm)	Limit (dBm)	Margin (dB)	S.A Reading (dBm)	S.G Power Vaule (dBm)	Correction Factor (dB)
3701.20	H	-46.37	-13.00	-33.37	-60.50	-52.95	6.58
5550.70	H	-43.10	-13.00	-30.10	-61.78	-48.98	5.88
7400.10	H	-42.57	-13.00	-29.57	-63.91	-45.44	2.87
3701.20	V	-41.89	-13.00	-28.89	-55.53	-48.47	6.58
5550.70	V	-37.61	-13.00	-24.61	-54.87	-43.49	5.88
7400.10	V	-40.45	-13.00	-27.45	-60.22	-43.32	2.87

Mode							
LTE Band 2, CB: 3MHz, 1RB, Offset 0,Channel: 18900							
Frequency (MHz)	Antenna Polarity	E.I.R.P (dBm)	Limit (dBm)	Margin (dB)	S.A Reading (dBm)	S.G Power Vaule (dBm)	Correction Factor (dB)
3757.60	H	-40.82	-13.00	-27.82	-55.44	-47.40	6.58
5636.00	H	-45.57	-13.00	-32.57	-64.85	-51.42	5.85
7514.50	H	-41.82	-13.00	-28.82	-62.41	-44.78	2.96
3757.60	V	-33.21	-13.00	-20.21	-47.32	-39.79	6.58
5636.00	V	-45.98	-13.00	-32.98	-63.59	-51.83	5.85
7514.50	V	-44.06	-13.00	-31.06	-63.80	-47.02	2.96

Mode							
LTE Band 2, CB: 3MHz, 1RB, Offset 0,Channel: 19185							
Frequency (MHz)	Antenna Polarity.	E.I.R.P (dBm)	Limit (dBm)	Margin (dB)	S.A Reading (dBm)	S.G Power Vaule (dBm)	Correction Factor (dB)
3814.00	H	-36.26	-13.00	-23.26	-51.23	-42.82	6.56
5721.40	H	-44.45	-13.00	-31.45	-63.54	-50.26	5.81
7628.80	H	-42.76	-13.00	-29.76	-62.94	-45.67	2.91
3814.00	V	-32.57	-13.00	-19.57	-47.03	-39.13	6.56
5721.40	V	-43.77	-13.00	-30.77	-61.62	-49.58	5.81
7628.80	V	-42.69	-13.00	-29.69	-62.48	-45.60	2.91

Note: EIRP = S.G Power value + Correction factor.

Mode							
LTE Band 2, CB: 5MHz, 1RB, Offset 0,Channel: 18625							
Frequency (MHz)	Antenna Polarity	E.I.R.P (dBm)	Limit (dBm)	Margin (dB)	S.A Reading (dBm)	S.G Power Vaule (dBm)	Correction Factor (dB)
3701.20	H	-46.80	-13.00	-33.80	-60.93	-53.38	6.58
5550.70	H	-43.36	-13.00	-30.36	-62.04	-49.24	5.88
7401.60	H	-42.75	-13.00	-29.75	-64.08	-45.62	2.87
3701.20	V	-41.74	-13.00	-28.74	-55.38	-48.32	6.58
5550.70	V	-37.52	-13.00	-24.52	-54.78	-43.40	5.88
7401.60	V	-40.78	-13.00	-27.78	-60.55	-43.65	2.87

Mode							
LTE Band 2, CB: 5MHz, 1RB, Offset 0,Channel: 18900							
Frequency (MHz)	Antenna Polarity	E.I.R.P (dBm)	Limit (dBm)	Margin (dB)	S.A Reading (dBm)	S.G Power Vaule (dBm)	Correction Factor (dB)
3756.20	H	-40.45	-13.00	-27.45	-55.06	-47.03	6.58
5633.10	H	-45.27	-13.00	-32.27	-64.50	-51.12	5.85
7511.60	H	-41.39	-13.00	-28.39	-61.99	-44.34	2.95
3756.20	V	-33.64	-13.00	-20.64	-47.74	-40.22	6.58
5633.10	V	-46.12	-13.00	-33.12	-63.72	-51.97	5.85
7511.60	V	-44.21	-13.00	-31.21	-63.95	-47.16	2.95

Mode							
LTE Band 2, CB: 5MHz, 1RB, Offset 0,Channel: 19175							
Frequency (MHz)	Antenna Polarity.	E.I.R.P (dBm)	Limit (dBm)	Margin (dB)	S.A Reading (dBm)	S.G Power Vaule (dBm)	Correction Factor (dB)
3811.10	H	-36.39	-13.00	-23.39	-51.37	-42.95	6.56
5715.60	H	-44.71	-13.00	-31.71	-63.81	-50.52	5.81
7621.60	H	-42.89	-13.00	-29.89	-63.04	-45.83	2.94
3811.10	V	-32.78	-13.00	-19.78	-47.24	-39.34	6.56
5715.60	V	-43.37	-13.00	-30.37	-61.20	-49.18	5.81
7621.60	V	-42.46	-13.00	-29.46	-62.24	-45.40	2.94

Note: EIRP = S.G Power value + Correction factor.

Mode							
LTE Band 2, CB: 10MHz, 1RB, Offset 0,Channel: 18650							
Frequency (MHz)	Antenna Polarity	E.I.R.P (dBm)	Limit (dBm)	Margin (dB)	S.A Reading (dBm)	S.G Power Vaule (dBm)	Correction Factor (dB)
3701.20	H	-46.45	-13.00	-33.45	-60.58	-53.03	6.58
5552.10	H	-43.07	-13.00	-30.07	-61.76	-48.95	5.88
7403.00	H	-42.01	-13.00	-29.01	-63.33	-44.88	2.87
3701.20	V	-41.33	-13.00	-28.33	-54.97	-47.91	6.58
5552.10	V	-37.45	-13.00	-24.45	-54.71	-43.33	5.88
7403.00	V	-40.52	-13.00	-27.52	-60.29	-43.39	2.87

Mode							
LTE Band 2, CB: 10MHz, 1RB, Offset 0,Channel: 18900							
Frequency (MHz)	Antenna Polarity	E.I.R.P (dBm)	Limit (dBm)	Margin (dB)	S.A Reading (dBm)	S.G Power Vaule (dBm)	Correction Factor (dB)
3751.80	H	-40.98	-13.00	-27.98	-55.55	-47.56	6.58
5627.40	H	-45.10	-13.00	-32.10	-64.34	-50.96	5.86
7502.90	H	-41.27	-13.00	-28.27	-61.93	-44.22	2.95
3751.80	V	-33.63	-13.00	-20.63	-47.70	-40.21	6.58
5627.40	V	-45.47	-13.00	-32.47	-63.05	-51.33	5.86
7502.90	V	-43.34	-13.00	-30.34	-63.08	-46.29	2.95

Mode							
LTE Band 2, CB: 10MHz, 1RB, Offset 0,Channel: 19150							
Frequency (MHz)	Antenna Polarity.	E.I.R.P (dBm)	Limit (dBm)	Margin (dB)	S.A Reading (dBm)	S.G Power Vaule (dBm)	Correction Factor (dB)
3801.00	H	-35.96	-13.00	-22.96	-50.95	-42.53	6.57
5701.20	H	-44.46	-13.00	-31.46	-63.57	-50.28	5.82
7602.70	H	-42.98	-13.00	-29.98	-63.06	-45.99	3.01
3801.00	V	-32.56	-13.00	-19.56	-47.02	-39.13	6.57
5701.20	V	-43.78	-13.00	-30.78	-61.56	-49.60	5.82
7602.70	V	-42.26	-13.00	-29.26	-62.03	-45.27	3.01

Note: EIRP = S.G Power value + Correction factor.

Mode							
LTE Band 2, CB: 15MHz, 1RB, Offset 0,Channel: 18675							
Frequency (MHz)	Antenna Polarity	E.I.R.P (dBm)	Limit (dBm)	Margin (dB)	S.A Reading (dBm)	S.G Power Vaule (dBm)	Correction Factor (dB)
3701.50	H	-46.77	-13.00	-33.77	-60.90	-53.35	6.58
5552.50	H	-43.16	-13.00	-30.16	-61.86	-49.04	5.88
7403.30	H	-42.39	-13.00	-29.39	-63.71	-45.26	2.87
3701.50	V	-41.64	-13.00	-28.64	-55.29	-48.22	6.58
5552.50	V	-37.73	-13.00	-24.73	-55.00	-43.61	5.88
7403.30	V	-40.75	-13.00	-27.75	-60.52	-43.62	2.87

Mode							
LTE Band 2, CB: 15MHz, 1RB, Offset 0,Channel: 18900							
Frequency (MHz)	Antenna Polarity	E.I.R.P (dBm)	Limit (dBm)	Margin (dB)	S.A Reading (dBm)	S.G Power Vaule (dBm)	Correction Factor (dB)
3746.70	H	-40.66	-13.00	-27.66	-55.18	-47.24	6.58
5620.00	H	-45.32	-13.00	-32.32	-64.56	-51.18	5.86
7493.40	H	-41.58	-13.00	-28.58	-62.30	-44.52	2.94
3746.70	V	-33.70	-13.00	-20.70	-47.72	-40.28	6.58
5620.00	V	-45.83	-13.00	-32.83	-63.38	-51.69	5.86
7493.40	V	-43.81	-13.00	-30.81	-63.55	-46.75	2.94

Mode							
LTE Band 2, CB: 15MHz, 1RB, Offset 0,Channel: 19125							
Frequency (MHz)	Antenna Polarity.	E.I.R.P (dBm)	Limit (dBm)	Margin (dB)	S.A Reading (dBm)	S.G Power Vaule (dBm)	Correction Factor (dB)
3791.60	H	-35.59	-13.00	-22.59	-50.50	-42.16	6.57
5687.50	H	-44.31	-13.00	-31.31	-63.45	-50.14	5.83
7583.40	H	-42.80	-13.00	-29.80	-62.97	-45.81	3.01
3791.60	V	-32.25	-13.00	-19.25	-46.64	-38.82	6.57
5687.50	V	-43.59	-13.00	-30.59	-61.34	-49.42	5.83
7583.40	V	-42.51	-13.00	-29.51	-62.26	-45.52	3.01

Note: EIRP = S.G Power value + Correction factor.

Mode							
LTE Band 2, CB: 20MHz, 1RB, Offset 0,Channel: 18700							
Frequency (MHz)	Antenna Polarity	E.I.R.P (dBm)	Limit (dBm)	Margin (dB)	S.A Reading (dBm)	S.G Power Vaule (dBm)	Correction Factor (dB)
3702.60	H	-46.48	-13.00	-33.48	-60.62	-53.06	6.58
5553.50	H	-43.39	-13.00	-30.39	-62.10	-49.27	5.88
7404.50	H	-42.17	-13.00	-29.17	-63.48	-45.04	2.87
3702.60	V	-41.35	-13.00	-28.35	-55.00	-47.93	6.58
5553.50	V	-37.57	-13.00	-24.57	-54.84	-43.45	5.88
7404.50	V	-40.63	-13.00	-27.63	-60.39	-43.50	2.87

Mode							
LTE Band 2, CB: 20MHz, 1RB, Offset 0,Channel: 18900							
Frequency (MHz)	Antenna Polarity	E.I.R.P (dBm)	Limit (dBm)	Margin (dB)	S.A Reading (dBm)	S.G Power Vaule (dBm)	Correction Factor (dB)
3741.70	H	-40.28	-13.00	-27.28	-54.76	-46.86	6.58
5612.90	H	-45.08	-13.00	-32.08	-64.34	-50.94	5.86
7484.10	H	-41.14	-13.00	-28.14	-61.92	-44.07	2.93
3741.70	V	-33.57	-13.00	-20.57	-47.55	-40.15	6.58
5612.90	V	-45.62	-13.00	-32.62	-63.16	-51.48	5.86
7484.10	V	-43.53	-13.00	-30.53	-63.27	-46.46	2.93

Mode							
LTE Band 2, CB: 20MHz, 1RB, Offset 0,Channel: 19100							
Frequency (MHz)	Antenna Polarity.	E.I.R.P (dBm)	Limit (dBm)	Margin (dB)	S.A Reading (dBm)	S.G Power Vaule (dBm)	Correction Factor (dB)
3782.20	H	-35.84	-13.00	-22.84	-50.68	-42.41	6.57
5673.70	H	-44.05	-13.00	-31.05	-63.21	-49.88	5.83
7565.10	H	-42.47	-13.00	-29.47	-62.75	-45.46	2.99
3782.20	V	-32.02	-13.00	-19.02	-46.34	-38.59	6.57
5673.70	V	-43.36	-13.00	-30.36	-61.07	-49.19	5.83
7565.10	V	-42.66	-13.00	-29.66	-62.41	-45.65	2.99

Note: EIRP = S.G Power value + Correction factor.

3.3 Conducted Emissions

3.3.1 Limit of Conducted Emissions

The power of any emission outside of the authorized operating frequency ranges must be attenuated below the transmitting power (P) by a factor of at least $43 + 10 \log(P)$ dB equal to -13dBm.

3.3.2 Test Procedures

1. Lowest, middle and highest operating channels are tested for this item.
2. Scan frequency range is from 30 MHz ~ 19.1 GHz.
3. Set RBW = 1 MHz, VBW = 3 MHz, detector = Peak, sweep time = auto.
4. Record the max trace value and capture the test plot of each sub frequency band.

3.3.3 Test Setup

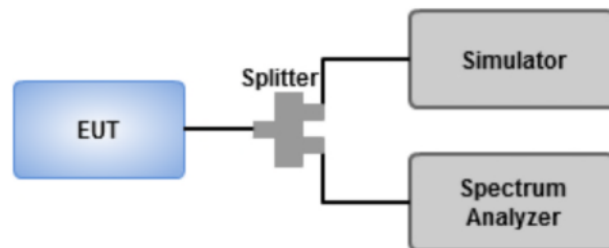

3.3.4 Test Result of Conducted Emissions

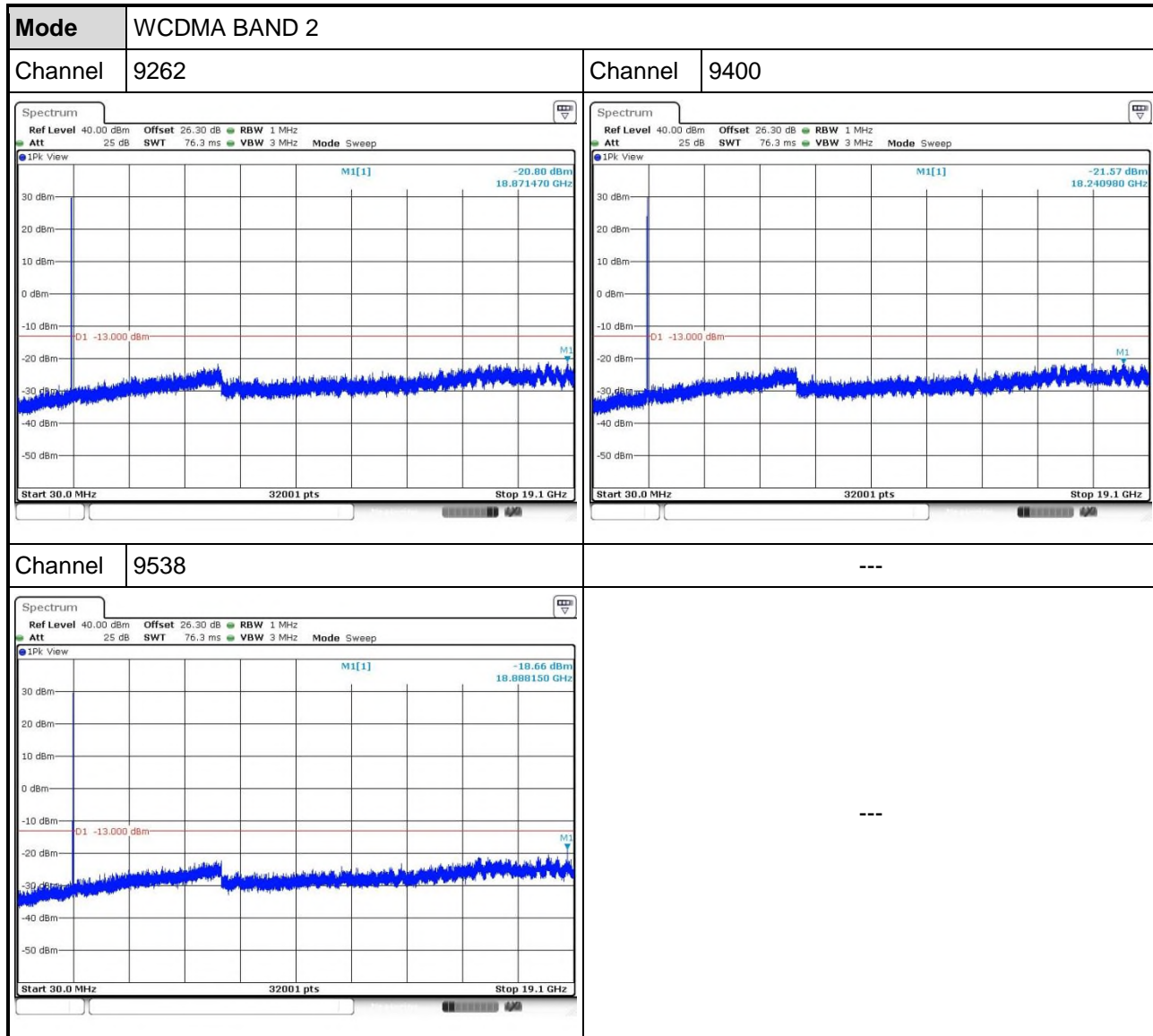

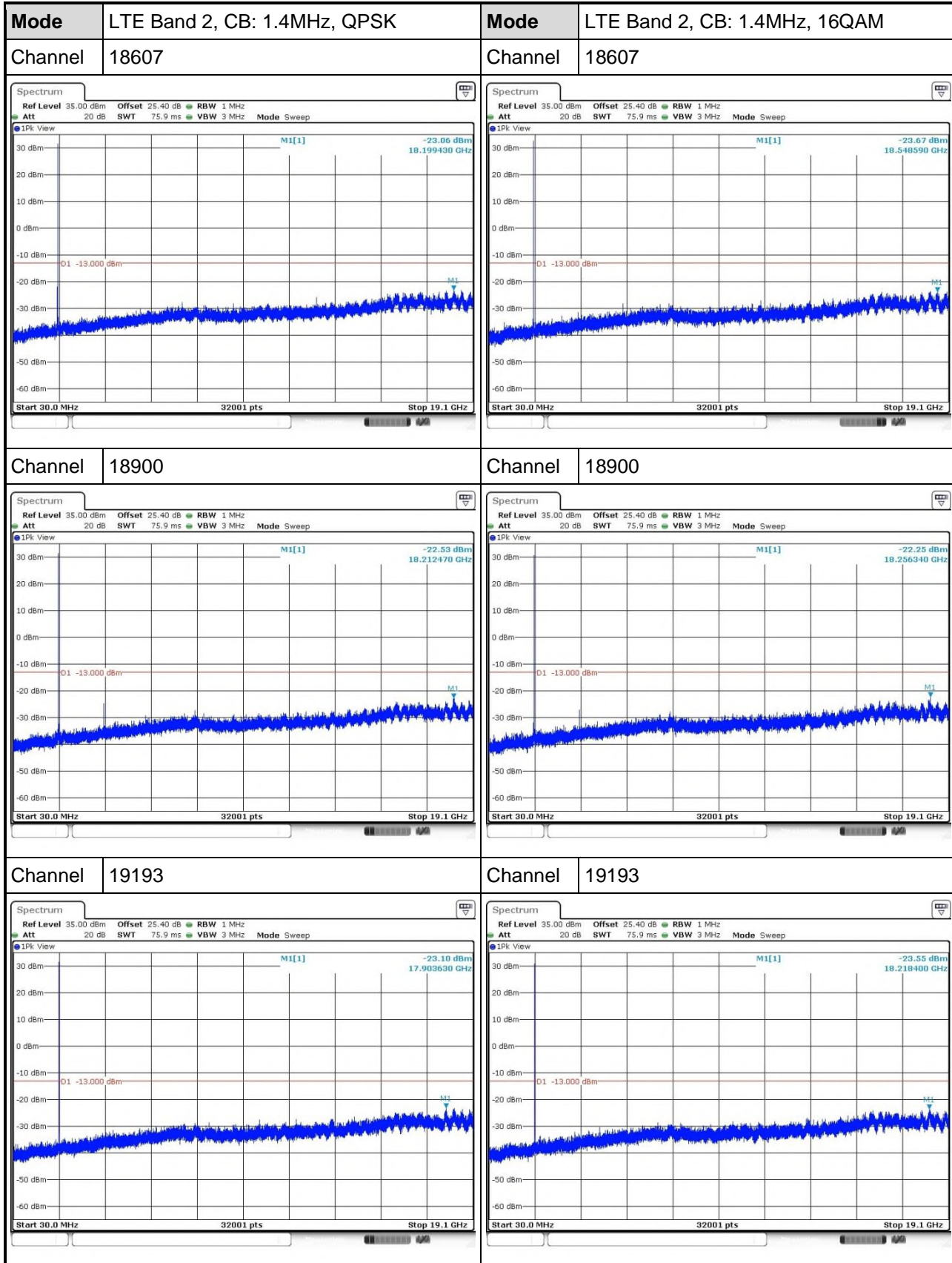

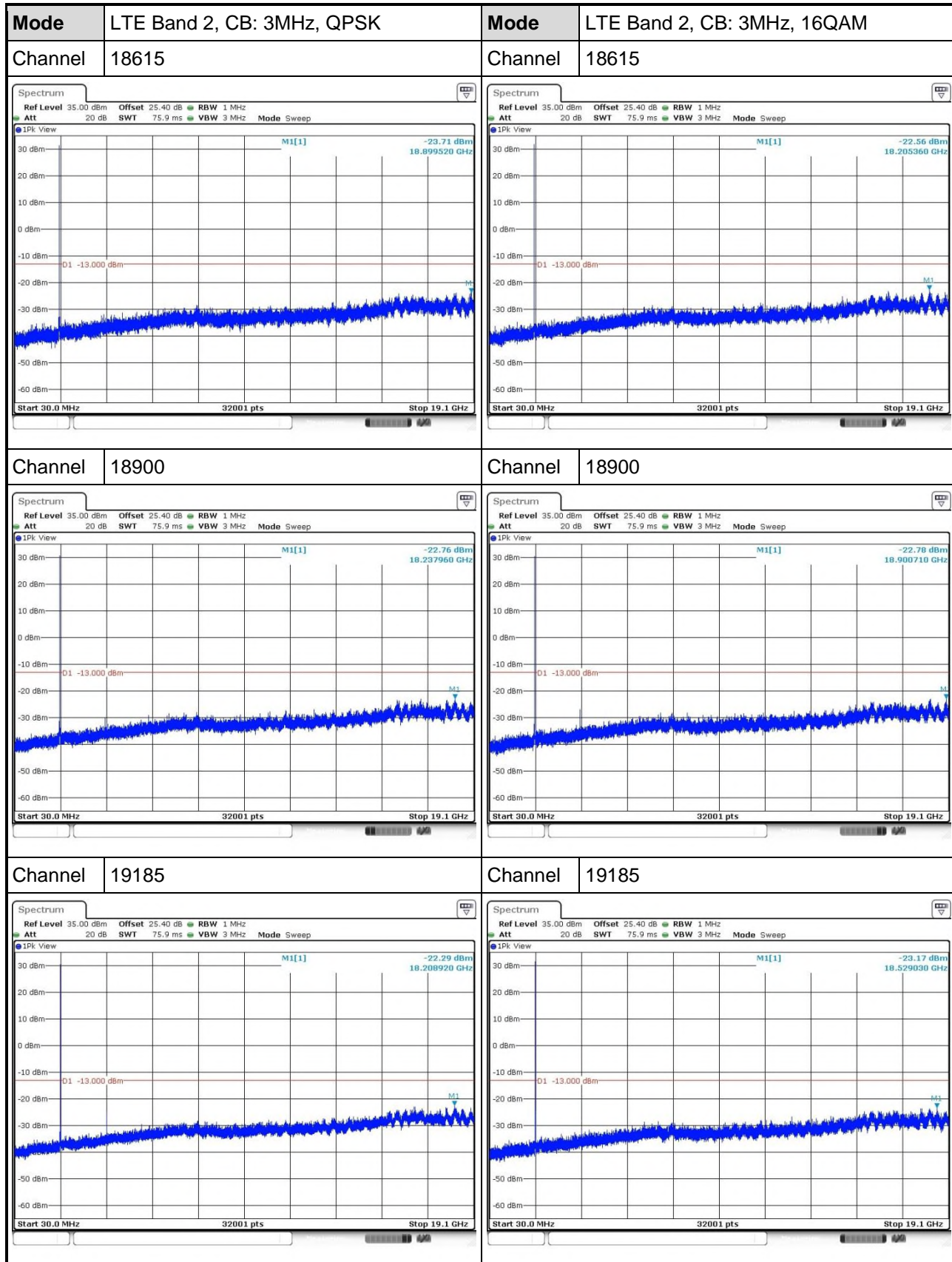

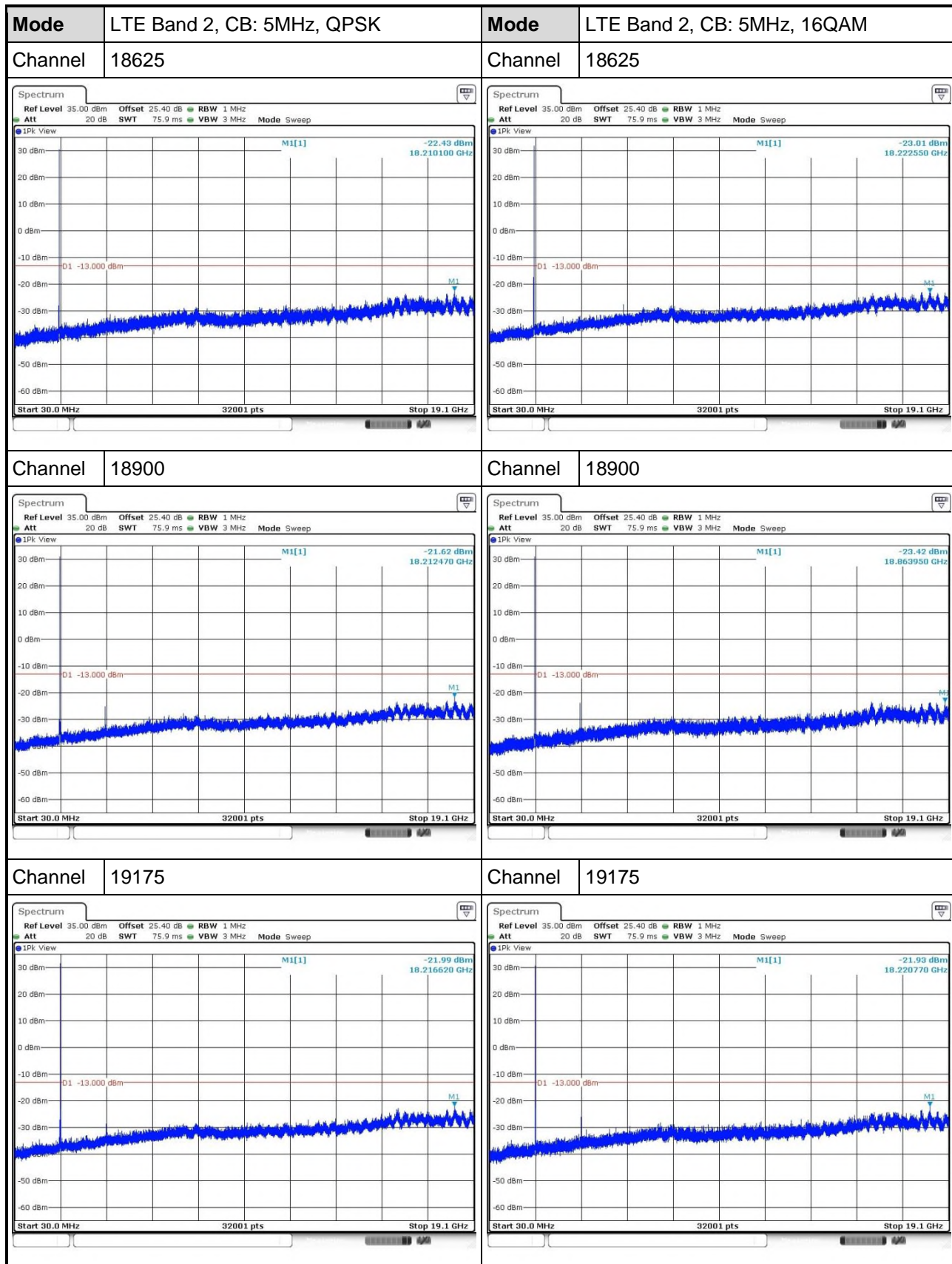

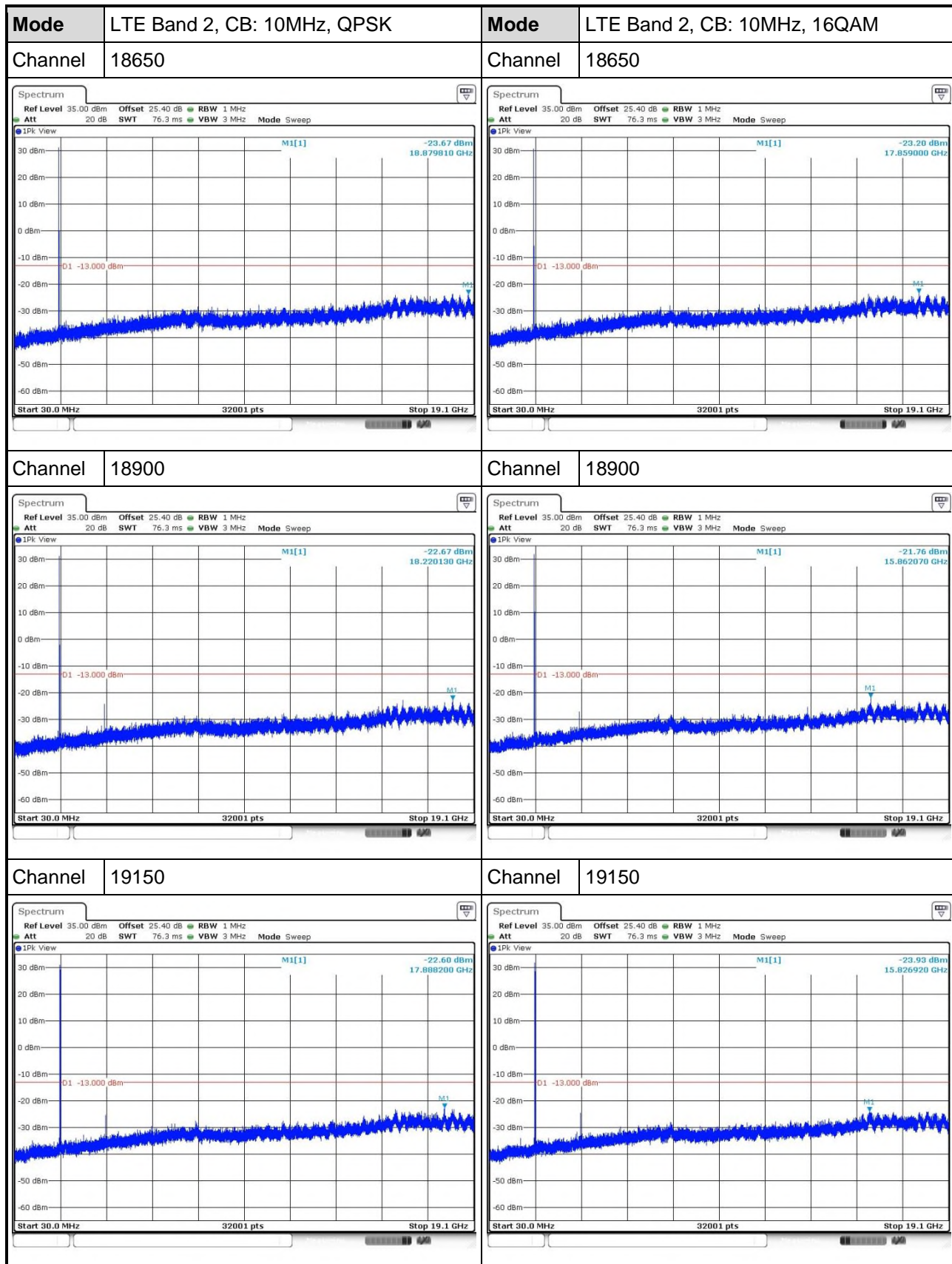

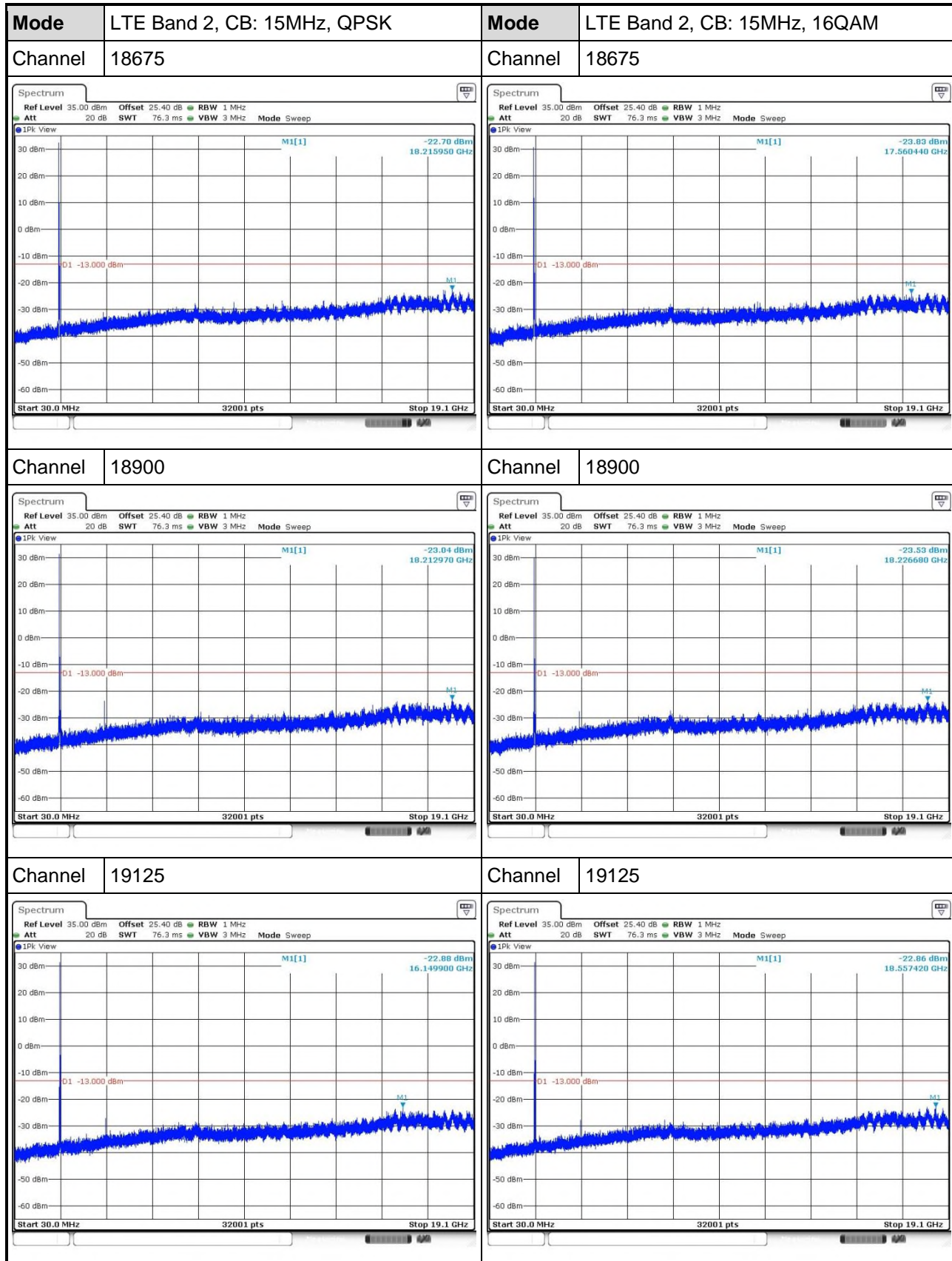

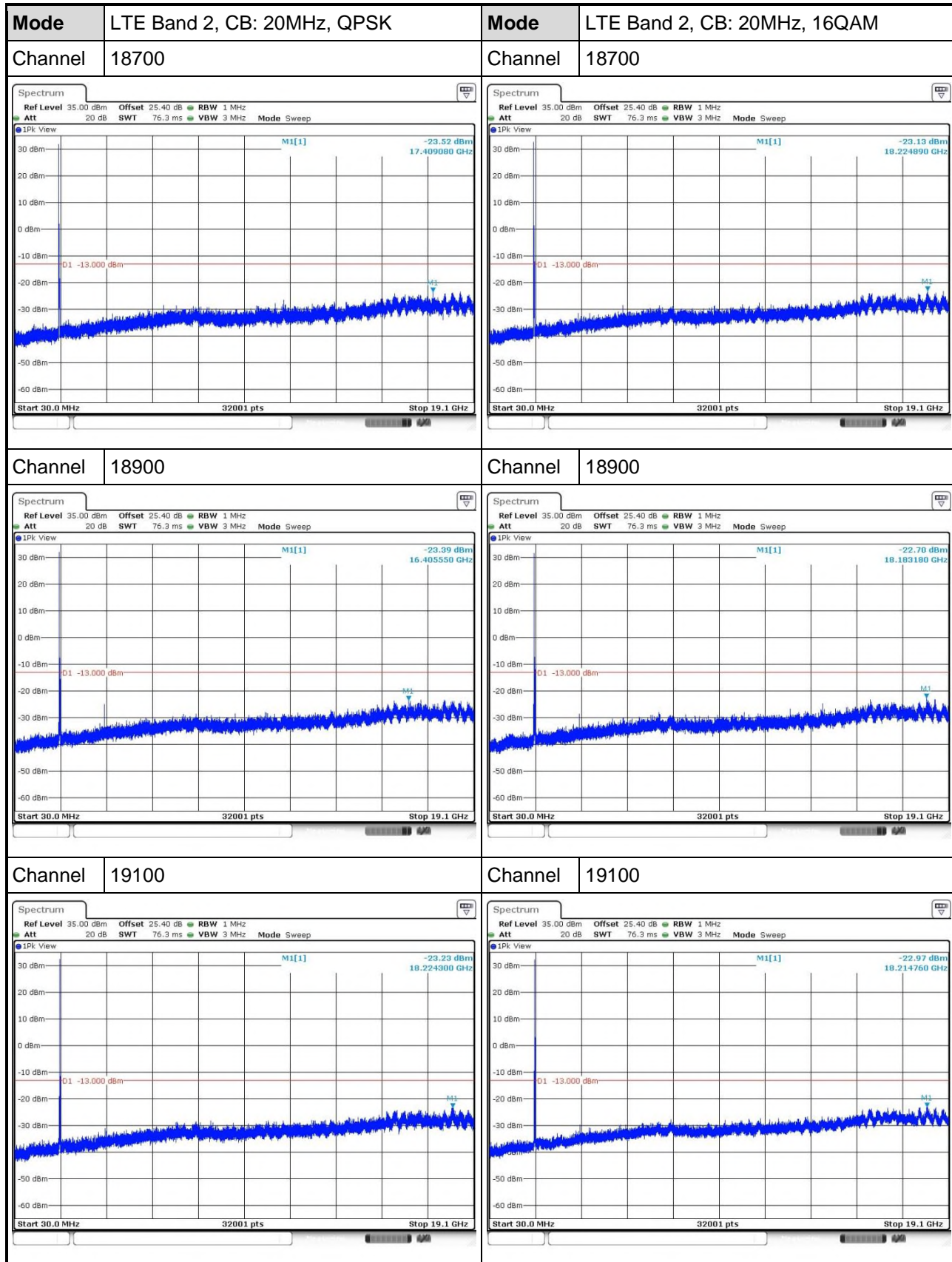

3.4 Band Edge

3.4.1 Limit of Band Edge

The power of any emission outside of the authorized operating frequency ranges must be attenuated below the transmitting power (P) by a factor of at least $43 + 10 \log(P)$ dB equal to -13dBm.

3.4.2 Test Procedures

For WCDMA

1. Lowest and highest operating channels are tested for this item.
2. The center frequency of spectrum analyzer will be set to 1850 and 1910 MHz.
3. Set RBW = 100 kHz, VBW = 300 kHz, span = 5 MHz, detector = RMS, sweep time.
4. Record the max trace value and capture the test plot.

For LTE

1. Lowest and highest operating channels are tested for this item.
2. Set RBW = 15 / 39 / 56 / 110 / 160 / 220 kHz, VBW = 62 / 120 / 180 / 330 / 510 / 680 kHz for LTE channel bandwidth 1.4 / 3 / 5 / 10 / 15 / 20 MHz, detector = RMS, sweep time = auto to measure trace.
3. Set RBW = 20 / 50 / 100 / 200 / 300 kHz, VBW = 100 / 200 / 300 / 1000 / 1000 / 1000 kHz for LTE channel bandwidth 1.4 / 3 / 5 / 10 / 15 / 20 MHz, detector = RMS and use channel power measurement function of spectrum analyzer to integrate power over 1MHz.

3.4.3 Test Setup

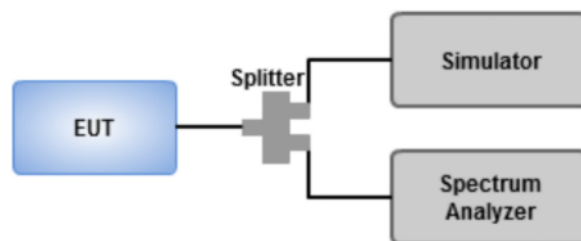

3.4.4 Test Result of Band Edge

