

FCC Test Report

FCC ID : N7NHL7588
Equipment : Wireless Module
Model No. : HL7588
Brand Name : AirPrime
Applicant : Sierra Wireless Inc.
Address : 13811 Wireless Way Richmond, BC, V6V 3A4
Canada
Standard : 47 CFR FCC Part 22 Subpart H
Received Date : Jul. 16, 2015
Tested Date : Jul. 20 ~ Jul. 30, 2015

We, International Certification Corp., would like to declare that the tested sample has been evaluated and in compliance with the requirement of the above standards. The test results contained in this report refer exclusively to the product. It may be duplicated completely for legal use with the approval of the applicant. It shall not be reproduced except in full without the written approval of our laboratory.

Approved & Reviewed by:

Gary Chang / Manager



Table of Contents

1	GENERAL DESCRIPTION	5
1.1	Information.....	5
1.2	Local Support Equipment List	7
1.3	Test Setup Chart	7
1.4	The Equipment List	8
1.5	Test Standards	9
1.6	Measurement Uncertainty	9
2	TEST CONFIGURATION.....	10
2.1	Testing Condition and Location Information.....	10
2.2	The Worst Test Modes and Channel Details	10
3	TEST RESULTS.....	12
3.1	Effective Radiated Power	12
3.2	Radiated Emissions.....	19
3.3	Conducted Emissions.....	29
3.4	Band Edge.....	35
3.5	Occupied and 26 dB Bandwidth	53
3.6	Peak to Average Ratio	59
3.7	Frequency Stability	65
4	TEST LABORATORY INFORMATION	69

Release Record

Report No.	Version	Description	Issued Date
FG571601P22	Rev. 01	Initial issue	Aug. 17, 2015
FG571601P22	Rev. 02	Add temperature and humidity chamber in equipment list	Aug. 24, 2015

Summary of Test Results

FCC Rules	Test Items	Measured	Result
2.1046 / 22.913(a)(2)	Effective Radiated Power	Power[dBm] : WCDMA: 24.59 LTE: 23.56	Pass
2.1053 / 22.917(a)	Radiated Emissions	Meet the requirement of limit	Pass
2.1051 / 22.917(a)	Conducted Emissions	Meet the requirement of limit	Pass
2.1051 / 22.917(a)	Band Edge	Meet the requirement of limit	Pass
2.1049 / 22.917(a)	Occupied Bandwidth	Meet the requirement of limit	Pass
-	Peak to average ratio	Meet the requirement of limit	Pass
2.1055 / 22.355	Frequency Stability	Meet the requirement of limit	Pass

1 General Description

1.1 Information

1.1.1 Specification of the Equipment under Test (EUT)

Operating Frequency (MHz)	WCDMA Band 5: 826.4~846.6 LTE Band 5: Channel Bandwidth: 1.4MHz: 824.7~848.3 Channel Bandwidth: 3MHz: 825.5~847.5 Channel Bandwidth: 5MHz: 826.5~846.5 Channel Bandwidth: 10MHz: 829~844
Modulation	WCDMA: QPSK (Uplink) LTE: QPSK, 16QAM (Uplink)
Release Version	WCDMA: R5 / R6 / R7 / R8 LTE: 8
Duplex Mode	FDD
UE Category	4
H/W Version	1.0
S/W Version	HL75xx.V.3.1

1.1.2 Maximum ERP and Emission Designator

Mode	Modulation	Maximum ERP(W)	Emission Designator
WCDMA 850	QPSK	0.288	4M11F9W
LTE Band 5, CB: 1.4MHz	QPSK	0.219	1M09G7D
LTE Band 5, CB: 1.4MHz	16QAM	0.198	1M09W7D
LTE Band 5, CB: 3MHz	QPSK	0.222	2M69G7D
LTE Band 5, CB: 3MHz	16QAM	0.189	2M70W7D
LTE Band 5, CB: 5MHz	QPSK	0.221	4M50G7D
LTE Band 5, CB: 5MHz	16QAM	0.198	4M50W7D
LTE Band 5, CB: 10MHz	QPSK	0.227	9M01G7D
LTE Band 5, CB: 10MHz	16QAM	0.199	9M01W7D

1.1.3 Antenna Details

Ant. No.	Type	Gain (dBi)	Connector	Remark
1	Dipole	2	R-SMA	---

Note: The antenna is for testing use only.

1.1.4 EUT Operational Condition

Supply Voltage	3.7 Vdc from host		
Operational Voltage	<input checked="" type="checkbox"/> Vnom (3.7 V)	<input checked="" type="checkbox"/> Vmax (4.5 V)	<input checked="" type="checkbox"/> Vmin (3.2 V)
Operational Climatic	<input checked="" type="checkbox"/> Tnom (20°C)	<input checked="" type="checkbox"/> Tmax (55°C)	<input checked="" type="checkbox"/> Tmin (-20°C)

1.1.5 Operating Channel List

WCDMA Band 5		
Channel Location	Channel	Frequency (MHz)
Low	4132	826.4
Middle	4182	836.4
High	4233	846.6

LTE Band 5		
Channel Bandwidths (MHz)	Channel	Frequency (MHz)
1.4	20407	824.7
1.4	20525	836.5
1.4	20643	848.3
3	20415	825.5
3	20525	836.5
3	20635	847.5
5	20425	826.5
5	20525	836.5
5	20625	846.5
10	20450	829.0
10	20525	836.5
10	20600	844.0

1.2 Local Support Equipment List

Support Equipment List						
No.	Equipment	Brand	Model	S/N	FCC ID	Signal cable / Length (m)
1	Power Supply	GWINSTEK	GPC-60300	EM884797	---	---

1.3 Test Setup Chart

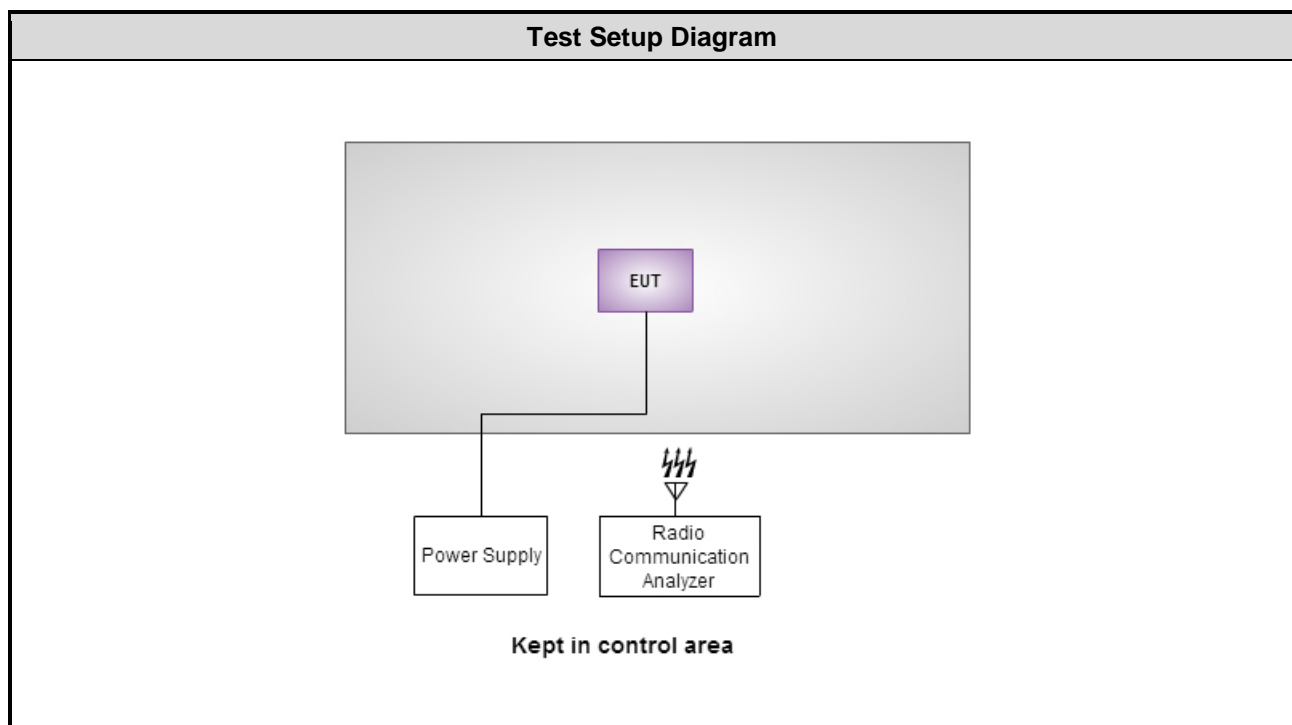

1.4 The Equipment List

Test Item	RF Conducted				
Test Site	(TH01-WS)				
Instrument	Manufacturer	Model No.	Serial No.	Calibration Date	Calibration Until
Spectrum Analyzer	R&S	FSV40	101063	Feb. 03, 2015	Feb. 02, 2016
TEMP&HUMIDITY CHAMBER	GIANT FORCE	GCT-225-40-SP-SD	MAF1212-002	Dec. 03, 2014	Dec. 02, 2015
Power Meter	Anritsu	ML2495A	1241002	Sep. 29, 2014	Sep. 28, 2015
Power Sensor	Anritsu	MA2411B	1207366	Sep. 29, 2014	Sep. 28, 2015
Radio Communication Analyzer	Anritsu	MT8820C	6201240341	Mar. 19, 2015	Mar. 17, 2016
Measurement Software	Sporton	Sporton_1	1.3.30	NA	NA

Note: Calibration Interval of instruments listed above is one year.

Test Item	Radiated Emission				
Test Site	966 chamber 2 / (03CH02-WS)				
Instrument	Manufacturer	Model No.	Serial No.	Calibration Date	Calibration Until
Spectrum Analyzer	R&S	FSV40	101499	Dec. 31, 2014	Dec. 30, 2015
Receiver	R&S	ESR3	101657	Jan. 15, 2015	Jan. 14, 2016
Bilog Antenna	SCHWARZBECK	VULB9168	VULB9168-524	Oct. 16, 2014	Oct. 15, 2015
Horn Antenna 1G-18G	SCHWARZBECK	BBHA 9120 D	BBHA 9120 D 1095	Oct. 14, 2014	Oct. 13, 2015
Horn Antenna 18G-40G	SCHWARZBECK	BBHA 9170	BBHA 9170517	Nov. 10, 2014	Nov. 09, 2015
Loop Antenna	R&S	HFH2-Z2	11900	Nov. 10, 2014	Nov. 09, 2015
Preamplifier	Burgeon	BPA-530	100218	Nov. 10, 2014	Nov. 09, 2015
Preamplifier	Agilent	83017A	MY39501309	Sep. 29, 2014	Sep. 28, 2015
Preamplifier	EMC	EMC184045B	980192	Aug. 26, 2014	Aug. 25, 2015
RF Cable	HUBER+SUHNER	SUCOFLEX104	MY16140/4	Dec. 16, 2014	Dec. 15, 2015
RF Cable	HUBER+SUHNER	SUCOFLEX104	MY16018/4	Dec. 16, 2014	Dec. 15, 2015
RF Cable	HUBER+SUHNER	SUCOFLEX104	MY16015/4	Dec. 16, 2014	Dec. 15, 2015
LF cable 3M	Woken	CFD400NL-LW	CFD400NL-003	Dec. 16, 2014	Dec. 15, 2015
LF cable 10M	Woken	CFD400NL-LW	CFD400NL-004	Dec. 16, 2014	Dec. 15, 2015
Measurement Software	AUDIX	e3	6.120210g	NA	NA

Note: Calibration Interval of instruments listed above is one year.

1.5 Test Standards

According to the specification of EUT, the EUT must comply with following standards.

47 CFR FCC Part 22 Subpart H

ANSI C63.4-2003

ANSI / TIA / EIA-603-D -2010

FCC KDB 971168 D01 Power Meas License Digital Systems v02r02

FCC KDB 412172 D01 Determining ERP and EIRP v01r01

1.6 Measurement Uncertainty

ISO/IEC 17025 requires that an estimate of the measurement uncertainties associated with the emissions test results be included in the report. The measurement uncertainties given below are based on a 95% confidence level (based on a coverage factor (k=2)).

Measurement Uncertainty	
Parameters	Uncertainty
Bandwidth	±34.134 Hz
Conducted power	±0.808 dB
Frequency error	±34.134 Hz
Temperature	±0.6 °C
Conducted emission	±2.670 dB
AC conducted emission	±2.92 dB
Radiated emission ≤ 1GHz	±3.62 dB
Radiated emission > 1GHz	±5.60 dB

2 Test Configuration

2.1 Testing Condition and Location Information

Test Item	Test Site	Ambient Condition	Tested By
RF conducted	TH01-WS	23°C / 64%	Felix Sung
Radiated Emissions	03CH02-WS	22°C / 64%	Anderson Hung

FCC site registration No.: 657002

IC site registration No.: 10807A-2

2.2 The Worst Test Modes and Channel Details

WCDMA

Test item	Mode	Test channel
Effective Radiated Power	WCDMA Band 5	4132, 4182, 4233
Radiated Emissions \leq 1GHz	WCDMA Band 5	4233
Radiated Emissions $>$ 1GHz	WCDMA Band 5	4132, 4182, 4233
Conducted Emissions	WCDMA Band 5	4132, 4182, 4233
Band Edge	WCDMA Band 5	4132, 4233
Occupied Bandwidth	WCDMA Band 5	4132, 4182, 4233
Peak to average ratio	WCDMA Band 5	4132, 4182, 4233
Frequency Stability	WCDMA Band 5	4182

Note:

- The EUT was pretested with 3 orientations placed on the table for the radiated emission measurement – X, Y, and Z-plane. The **Y-plane** results were found as the worst case and were shown in this report.

LTE

Test item	Channel Bandwidths	Modulation	Test channel
Effective Radiated Power	1.4 MHz	QPSK / 16QAM	20407 / 20525 / 20643
Conducted Emissions	3 MHz	QPSK / 16QAM	20415 / 20525 / 20635
Occupied Bandwidth	5 MHz	QPSK / 16QAM	20425 / 20525 / 20625
Peak to Average Ratio	10 MHz	QPSK / 16QAM	20450 / 20525 / 20600
Radiated Emission \leq 1GHz	1.4 MHz	QPSK	20525
	3 MHz	QPSK	20635
	5 MHz	QPSK	20425
	10 MHz	QPSK	20450
Radiated Emission $>$ 1GHz	1.4 MHz	QPSK	20407 / 20525 / 20643
	3 MHz	QPSK	20415 / 20525 / 20635
	5 MHz	QPSK	20425 / 20525 / 20625
	10 MHz	QPSK	20450 / 20525 / 20600
Band Edge	1.4 MHz	QPSK / 16QAM	20407 / 20643
	3 MHz	QPSK / 16QAM	20415 / 20635
	5 MHz	QPSK / 16QAM	20425 / 20625
	10 MHz	QPSK / 16QAM	20450 / 20600
Frequency Stability	1.4 MHz	QPSK	20525
	3 MHz	QPSK	20525
	5 MHz	QPSK	20525
	10 MHz	QPSK	20525

Note:

1. The EUT was pretested with 3 orientations placed on the table for the radiated emission measurement – X, Y, and Z-plane. The **Y-plane** results were found as the worst case and were shown in this report.

3 Test Results

3.1 Effective Radiated Power

3.1.1 Limit of Effective Radiated Power

The ERP of mobile transmitters and auxiliary test transmitters must not exceed 7 Watts.

3.1.2 Test Procedures

For Conducted power measurement:

1. The EUT links up with simulator and is set to maximum output power level at low / middle / high channel.
2. Measure the output power of low / middle / high channel of the EUT.

For ERP measurement:

EPR can be calculated by below formula from KDB 412172 D01.

1. $EIRP = P_T + G_T - L_C$
 P_T = transmitter output power, in dBm.
 G_T = gain of the transmitting antenna, in dBi (EIRP).
 L_C = signal attenuation in the connecting cable between the transmitter and antenna, in dB.
2. $ERP = EIRP - 2.15 \text{ dB}$.

3.1.3 Test Setup

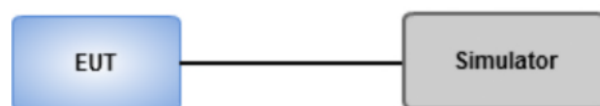

3.1.4 Test Result of Conducted Output Power (dBm)

Band	WCDMA BAND 5		
Channel	4132	4182	4233
Frequency (MHz)	826.4	836.4	846.6
RMC 12.2K	24.70	24.73	24.74
HSDPA Subtest-1	24.34	24.45	24.46
HSDPA Subtest-2	24.42	24.48	24.51
HSDPA Subtest-3	24.29	24.34	24.38
HSDPA Subtest-4	24.28	24.32	24.36
DC-HSDPA Subtest-1	24.29	24.41	24.37
DC-HSDPA Subtest-2	24.31	24.46	24.42
DC-HSDPA Subtest-3	24.10	24.22	24.20
DC-HSDPA Subtest-4	24.07	24.17	24.14
HSUPA Subtest-1	24.04	24.15	24.10
HSUPA Subtest-2	23.04	23.09	23.02
HSUPA Subtest-3	23.92	23.97	24.02
HSUPA Subtest-4	23.18	23.21	23.24
HSUPA Subtest-5	24.52	24.57	24.60

Band / Channel Bandwidth			LTE Band 5 / CB: 1.4MHz		
Channel			20407	20525	20643
Frequency (MHz)			824.7	836.5	848.3
Mode	RB	RB Offset	Maximum AV Power (dBm)		
QPSK	1	0	23.45	23.55	23.16
	1	2	23.47	23.51	23.23
	1	5	23.53	23.45	23.17
	3	0	23.45	23.51	23.10
	3	1	23.48	23.43	23.11
	3	2	23.47	23.45	23.24
	6	0	22.75	22.71	22.32
16QAM	1	0	22.96	22.86	22.56
	1	2	22.73	22.89	22.67
	1	5	23.05	23.12	22.83
	3	0	23.41	22.82	22.56
	3	1	22.77	22.69	22.29
	3	2	22.72	22.87	22.55
	6	0	21.99	21.95	21.50

Band / Channel Bandwidth			LTE Band 5 / CB: 3MHz		
Channel			20415	20525	20635
Frequency (MHz)			825.5	836.5	847.5
Mode	RB	RB Offset	Maximum AV Power (dBm)		
QPSK	1	0	23.42	23.46	23.62
	1	7	23.28	23.39	23.56
	1	14	23.36	23.41	23.54
	8	0	22.51	22.58	22.62
	8	4	22.48	22.51	22.49
	8	7	22.50	22.53	22.52
	15	0	22.49	22.52	22.51
16QAM	1	0	22.81	22.89	22.92
	1	7	22.73	22.78	22.82
	1	14	22.72	22.79	22.83
	8	0	21.51	21.56	21.63
	8	4	21.60	21.63	21.59
	8	7	21.62	21.66	21.62
	15	0	21.58	21.53	21.58

Band / Channel Bandwidth			LTE Band 5 / CB: 5MHz		
Channel			20425	20525	20625
Frequency (MHz)			826.5	836.5	846.5
Mode	RB	RB Offset	Maximum AV Power (dBm)		
QPSK	1	0	23.60	23.52	23.39
	1	12	23.45	23.47	23.32
	1	24	23.49	23.23	23.28
	12	0	22.64	22.60	22.46
	12	6	22.66	22.53	22.42
	12	11	22.66	22.45	22.47
	25	0	22.54	22.53	22.44
16QAM	1	0	22.78	22.85	23.11
	1	12	22.82	23.04	22.60
	1	24	22.96	22.40	22.72
	12	0	21.89	21.73	21.55
	12	6	21.95	21.69	21.59
	12	11	21.77	21.59	21.56
	25	0	21.87	21.68	21.52

Band / Channel Bandwidth			LTE Band 5 / CB: 10MHz		
Channel			20450	20525	20600
Frequency (MHz)			829	836.5	844
Mode	RB	RB Offset	Maximum AV Power (dBm)		
QPSK	1	0	23.71	23.51	23.59
	1	24	23.56	23.41	23.39
	1	49	23.29	23.26	23.45
	25	0	22.59	22.56	22.61
	25	12	22.58	22.48	22.39
	25	24	22.51	22.40	22.37
	50	0	22.69	22.49	22.45
16QAM	1	0	23.01	22.79	22.58
	1	24	22.88	22.76	22.62
	1	49	23.13	22.93	22.80
	25	0	21.79	21.65	21.73
	25	12	21.84	21.65	21.52
	25	24	21.84	21.70	21.51
	50	0	21.70	21.78	21.60

3.1.5 Test Result of Effective Radiated Power (dBm)

Mode	WCDMA Band 5, RMC 12.2K						
Channel	Frequency (MHz)	Conducted Output Power (dBm)	Max Antenna Gain (dBi)	EIRP (dBm)	ERP (dBm)	ERP (W)	Limit (W)
4132	826.4	24.70	2	26.70	24.55	0.285	7
4182	836.4	24.73	2	26.73	24.58	0.287	7
4233	846.6	24.74	2	26.74	24.59	0.288	7

Mode							
LTE Band 5, CB: 1.4MHz, QPSK							
Channel	Frequency (MHz)	Conducted Output Power (dBm)	Max Antenna Gain (dBi)	EIRP (dBm)	ERP (dBm)	ERP (W)	Limit (W)
20407	824.7	23.53	2	25.53	23.38	0.218	7
20525	836.5	23.55	2	25.55	23.40	0.219	7
20643	848.3	23.24	2	25.24	23.09	0.204	7

Mode							
LTE Band 5, CB: 1.4MHz, 16QAM							
Channel	Frequency (MHz)	Conducted Output Power (dBm)	Max Antenna Gain (dBi)	EIRP (dBm)	ERP (dBm)	ERP (W)	Limit (W)
20407	824.7	23.05	2	25.05	22.90	0.195	7
20525	836.5	23.12	2	25.12	22.97	0.198	7
20643	848.3	22.83	2	24.83	22.68	0.185	7

Mode							
LTE Band 5, CB: 3MHz, QPSK							
Channel	Frequency (MHz)	Conducted Output Power (dBm)	Max Antenna Gain (dBi)	EIRP (dBm)	ERP (dBm)	ERP (W)	Limit (W)
20415	825.5	23.42	2	25.42	23.27	0.212	7
20525	836.5	23.46	2	25.46	23.31	0.214	7
20635	847.5	23.62	2	25.62	23.47	0.222	7

Mode							
LTE Band 5, CB: 3MHz, 16QAM							
Channel	Frequency (MHz)	Conducted Output Power (dBm)	Max Antenna Gain (dBi)	EIRP (dBm)	ERP (dBm)	ERP (W)	Limit (W)
20415	825.5	22.81	2	24.81	22.66	0.185	7
20525	836.5	22.89	2	24.89	22.74	0.188	7
20635	847.5	22.92	2	24.92	22.77	0.189	7

Mode							
LTE Band 5, CB: 5MHz, QPSK							
Channel	Frequency (MHz)	Conducted Output Power (dBm)	Max Antenna Gain (dBi)	EIRP (dBm)	ERP (dBm)	ERP (W)	Limit (W)
20425	826.5	23.60	2	25.60	23.45	0.221	7
20525	836.5	23.52	2	25.52	23.37	0.217	7
20625	846.5	23.39	2	25.39	23.24	0.211	7

Mode							
LTE Band 5, CB: 5MHz, 16QAM							
Channel	Frequency (MHz)	Conducted Output Power (dBm)	Max Antenna Gain (dBi)	EIRP (dBm)	ERP (dBm)	ERP (W)	Limit (W)
20425	826.5	22.96	2	24.96	22.81	0.191	7
20525	836.5	22.85	2	24.85	22.70	0.186	7
20625	846.5	23.11	2	25.11	22.96	0.198	7

Mode							
LTE Band 5, CB: 10MHz, QPSK							
Channel	Frequency (MHz)	Conducted Output Power (dBm)	Max Antenna Gain (dBi)	EIRP (dBm)	ERP (dBm)	ERP (W)	Limit (W)
20450	829.0	23.71	2	25.71	23.56	0.227	7
20525	836.5	23.51	2	25.51	23.36	0.217	7
20600	844.0	23.59	2	25.59	23.44	0.221	7

Mode							
LTE Band 5, CB: 10MHz, 16QAM							
Channel	Frequency (MHz)	Conducted Output Power (dBm)	Max Antenna Gain (dBi)	EIRP (dBm)	ERP (dBm)	ERP (W)	Limit (W)
20450	829.0	23.13	2	25.13	22.98	0.199	7
20525	836.5	22.93	2	24.93	22.78	0.190	7
20600	844.0	22.80	2	24.80	22.65	0.184	7

3.2 Radiated Emissions

3.2.1 Limit of Radiated Emissions

The power of any emission outside of the authorized operating frequency ranges must be attenuated below the transmitting power (P) by a factor of at least $43 + 10 \log(P)$ dB equal to -13dBm.

3.2.2 Test Procedures

1. Measurement is made at a semi-anechoic chamber that incorporates a turntable allowing a EUT rotation of 360°. A continuously-rotating, remotely-controlled turntable is installed at the test site to support the EUT and facilitate determination of the direction of maximum radiation for each EUT emission frequency. The EUT is placed at a height of 0.8 m test table above the ground plane.
2. Measurement is made with the antenna positioned in both the horizontal and vertical planes of polarization. The measurement antenna is varied in height (1m ~ 4m) above the reference ground plane to obtain the maximum signal strength. Distance between EUT and antenna is 3 m.
3. This investigation is performed with the EUT rotated 360°, the antenna height scanned between 1 m and 4 m, and the antenna rotated to repeat the measurements for both the horizontal and vertical antenna polarizations.
4. After finding the max radiated emission, substitution method will be used for getting effective radiated power. EUT will be removed and substitution antenna will be placed at same position. Signal generator will output CW signal to substitution antenna through a RF cable. Rotate turntable and move antenna to find maximum radiated emission. Adjust output power of signal generator to let the maximum radiated emission is same as step 3. Record the output power level.
5. $E.I.R.P = \text{output power of step 4} + \text{gain of substitution antenna} - \text{cable loss of RF cable}$. ERP can be calculated by below formula:
 $E.R.P = E.I.R.P - 2.15dB$.

3.2.3 Test Setup

Radiated Emissions below 1 GHz

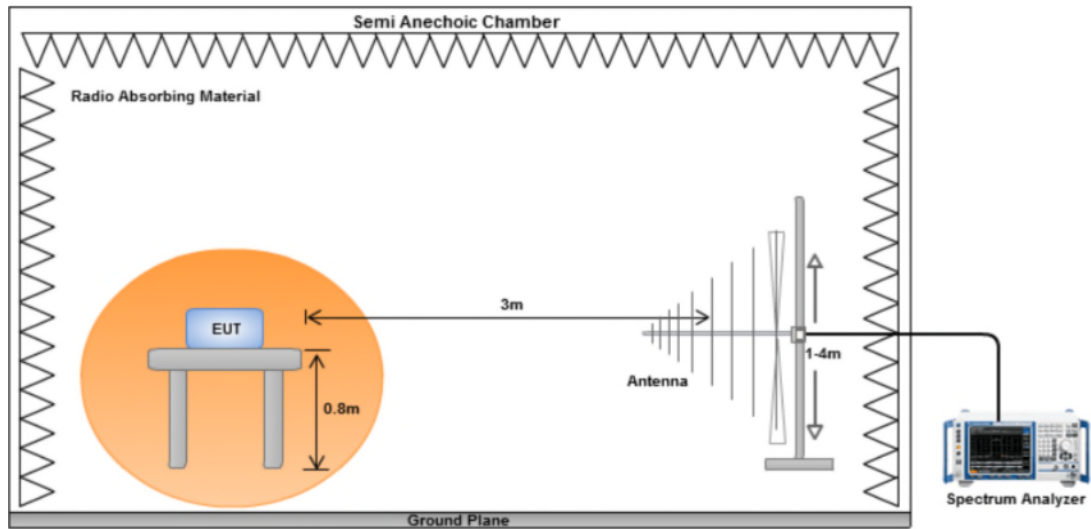

Radiated Emissions above 1 GHz

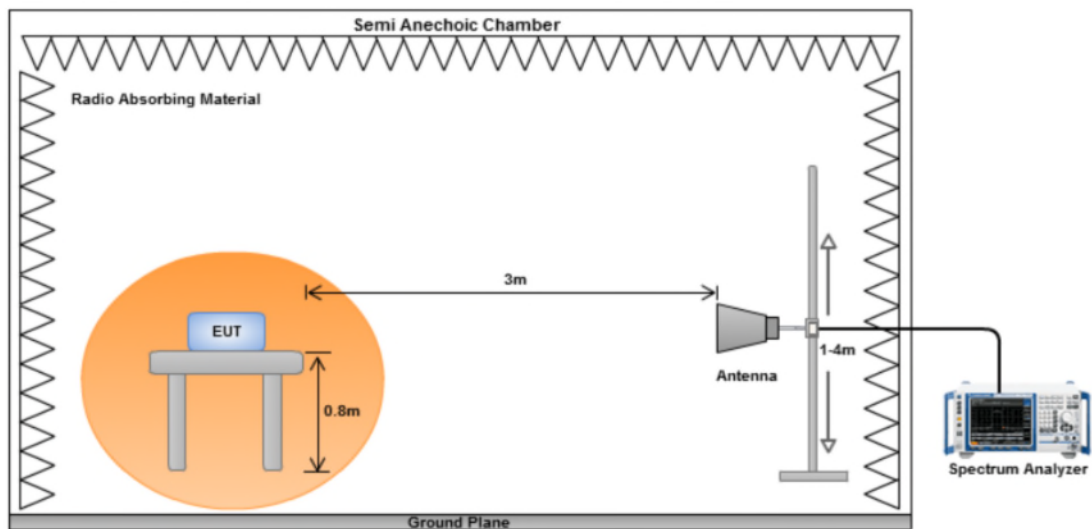

3.2.4 Test Result of Radiated Emissions below 1GHz

Mode	WCDMA Band 5, Channel: 4233						
Frequency (MHz)	Antenna Polarity	E.R.P (dBm)	Limit (dBm)	Margin (dB)	S.A Reading (dBm)	S.G Power Vaule (dBm)	Correction Factor (dB)
43.58	H	-50.72	-13.00	-37.72	-46.64	-36.79	-11.78
106.63	H	-56.68	-13.00	-43.68	-61.58	-54.48	-0.05
136.70	H	-63.51	-13.00	-50.51	-66.92	-60.12	-1.24
175.50	H	-59.50	-13.00	-46.50	-63.98	-58.80	1.45
287.05	H	-65.99	-13.00	-52.99	-70.50	-68.08	4.24
410.24	H	-68.46	-13.00	-55.46	-69.13	-70.56	4.25
38.73	V	-46.62	-13.00	-33.62	-52.09	-31.99	-12.48
98.87	V	-50.85	-13.00	-37.85	-55.65	-48.99	0.29
130.88	V	-55.99	-13.00	-42.99	-57.65	-52.78	-1.06
159.98	V	-55.56	-13.00	-42.56	-56.16	-52.55	-0.86
186.17	V	-53.07	-13.00	-40.07	-54.56	-53.74	2.82
259.89	V	-55.91	-13.00	-42.91	-56.86	-58.10	4.34

NOTE: ERP = S.G power value + correction factor - 2.15.

Mode	LTE Band 5, CB:1.4MHz, 1RB, Offset 0, Channel: 20525						
Frequency (MHz)	Antenna Polarity	E.R.P (dBm)	Limit (dBm)	Margin (dB)	S.A Reading (dBm)	S.G Power Vaule (dBm)	Correction Factor (dB)
41.64	H	-63.37	-13.00	-50.37	-63.66	-49.16	-12.06
98.87	H	-62.24	-13.00	-49.24	-53.25	-60.38	0.29
128.94	H	-65.64	-13.00	-52.64	-57.05	-62.49	-1.00
169.68	H	-64.83	-13.00	-51.83	-56.35	-63.26	0.58
184.23	H	-66.47	-13.00	-53.47	-56.85	-66.92	2.60
339.43	H	-71.19	-13.00	-58.19	-65.27	-73.41	4.37
37.76	V	-46.23	-13.00	-33.23	-36.36	-31.47	-12.61
98.87	V	-55.40	-13.00	-42.40	-46.30	-53.54	0.29
150.28	V	-61.02	-13.00	-48.02	-55.70	-57.77	-1.10
244.37	V	-63.24	-13.00	-50.24	-58.04	-65.46	4.37
427.70	V	-66.20	-13.00	-53.20	-61.85	-68.23	4.18
563.50	V	-64.50	-13.00	-51.50	-65.18	-66.40	4.05

NOTE: ERP = S.G power value + correction factor - 2.15.

Mode	LTE Band 5, CB:3MHz, 1RB, Offset 0, Channel: 20635						
Frequency (MHz)	Antenna Polarity	E.R.P (dBm)	Limit (dBm)	Margin (dB)	S.A Reading (dBm)	S.G Power Vaule (dBm)	Correction Factor (dB)
36.79	H	-61.87	-13.00	-48.87	-62.47	-46.97	-12.75
97.90	H	-61.41	-13.00	-48.41	-52.42	-59.57	0.31
164.83	H	-69.36	-13.00	-56.36	-61.14	-67.07	-0.14
260.86	H	-74.32	-13.00	-61.32	-64.77	-76.50	4.33
343.31	H	-72.16	-13.00	-59.16	-66.49	-74.40	4.39
422.85	H	-71.11	-13.00	-58.11	-66.36	-73.16	4.20
38.73	V	-51.08	-13.00	-38.08	-41.31	-36.45	-12.48
98.87	V	-56.23	-13.00	-43.23	-47.13	-54.37	0.29
138.64	V	-61.45	-13.00	-48.45	-55.66	-57.99	-1.31
173.56	V	-62.30	-13.00	-49.30	-56.84	-61.31	1.16
208.48	V	-65.78	-13.00	-52.78	-59.99	-68.02	4.39
747.80	V	-57.52	-13.00	-44.52	-59.70	-58.78	3.41

NOTE: ERP = S.G power value + correction factor - 2.15.

Mode	LTE Band 5, CB:5MHz, 1RB, Offset 0, Channel: 20425						
Frequency (MHz)	Antenna Polarity	E.R.P (dBm)	Limit (dBm)	Margin (dB)	S.A Reading (dBm)	S.G Power Vaule (dBm)	Correction Factor (dB)
43.58	H	-62.17	-13.00	-49.17	-61.95	-48.24	-11.78
97.90	H	-62.96	-13.00	-49.96	-53.97	-61.12	0.31
140.58	H	-62.86	-13.00	-49.86	-55.50	-59.37	-1.34
171.62	H	-60.64	-13.00	-47.64	-52.06	-59.36	0.87
472.32	H	-68.62	-13.00	-55.62	-64.63	-70.56	4.09
747.80	H	-61.47	-13.00	-48.47	-62.58	-62.73	3.41
38.73	V	-48.93	-13.00	-35.93	-54.40	-34.30	-12.48
97.90	V	-49.27	-13.00	-36.27	-54.12	-47.43	0.31
168.71	V	-55.86	-13.00	-42.86	-56.82	-54.15	0.44
204.60	V	-55.51	-13.00	-42.51	-57.06	-57.75	4.39
259.89	V	-57.36	-13.00	-44.36	-58.31	-59.55	4.34
739.07	V	-58.14	-13.00	-45.14	-51.71	-59.47	3.48

NOTE: ERP = S.G power value + correction factor - 2.15.

Mode	LTE Band 5, CB:10MHz, 1RB, Offset 0, Channel: 20450						
Frequency (MHz)	Antenna Polarity	E.R.P (dBm)	Limit (dBm)	Margin (dB)	S.A Reading (dBm)	S.G Power Vaule (dBm)	Correction Factor (dB)
42.61	H	-61.95	-13.00	-48.95	-61.99	-47.88	-11.92
98.87	H	-61.54	-13.00	-48.54	-52.55	-59.68	0.29
158.04	H	-61.32	-13.00	-48.32	-53.41	-58.26	-0.91
171.62	H	-61.33	-13.00	-48.33	-52.75	-60.05	0.87
225.94	H	-67.47	-13.00	-54.47	-56.67	-69.70	4.38
747.80	H	-62.81	-13.00	-49.81	-63.92	-64.07	3.41
37.76	V	-52.03	-13.00	-39.03	-42.16	-37.27	-12.61
97.90	V	-57.18	-13.00	-44.18	-48.03	-55.34	0.31
133.79	V	-54.23	-13.00	-41.23	-48.33	-50.93	-1.15
289.96	V	-66.53	-13.00	-53.53	-60.84	-68.61	4.23
360.77	V	-57.31	-13.00	-44.31	-52.13	-59.55	4.39
729.37	V	-54.51	-13.00	-41.51	-56.58	-55.91	3.55

NOTE: ERP = S.G power value + correction factor - 2.15.

3.2.5 Test Result of Radiated Emissions above 1GHz

Mode		WCDMA Band 5, Channel: 4132					
Frequency (MHz)	Antenna Polarity	E.R.P (dBm)	Limit (dBm)	Margin (dB)	S.A Reading (dBm)	S.G Power Vaule (dBm)	Correction Factor (dB)
1652.80	H	-58.68	-13.00	-45.68	-60.36	-61.57	5.04
2479.20	H	-54.75	-13.00	-41.75	-60.86	-58.67	6.07
3305.60	H	-48.99	-13.00	-35.99	-58.85	-53.25	6.41
1652.80	V	-54.88	-13.00	-41.88	-55.81	-57.77	5.04
2479.20	V	-55.50	-13.00	-42.50	-62.75	-59.42	6.07
3305.60	V	-50.79	-13.00	-37.79	-60.24	-55.05	6.41

Mode		WCDMA Band 5, Channel: 4182					
Frequency (MHz)	Antenna Polarity	E.R.P (dBm)	Limit (dBm)	Margin (dB)	S.A Reading (dBm)	S.G Power Vaule (dBm)	Correction Factor (dB)
1672.80	H	-59.02	-13.00	-46.02	-60.80	-61.98	5.11
2509.20	H	-55.05	-13.00	-42.05	-61.33	-58.96	6.06
3345.60	H	-50.46	-13.00	-37.46	-59.97	-54.77	6.46
1672.80	V	-56.97	-13.00	-43.97	-57.93	-59.93	5.11
2509.20	V	-50.64	-13.00	-37.64	-58.05	-54.55	6.06
3345.60	V	-51.32	-13.00	-38.32	-60.80	-55.63	6.46

Mode		WCDMA Band 5, Channel: 4233					
Frequency (MHz)	Antenna Polarity.	E.R.P (dBm)	Limit (dBm)	Margin (dB)	S.A Reading (dBm)	S.G Power Vaule (dBm)	Correction Factor (dB)
1693.20	H	-55.39	-13.00	-42.39	-57.28	-58.41	5.17
2539.80	H	-53.00	-13.00	-40.00	-59.45	-56.90	6.05
3386.40	H	-51.33	-13.00	-38.33	-60.49	-55.70	6.52
1693.20	V	-51.51	-13.00	-38.51	-52.50	-54.53	5.17
2539.80	V	-52.56	-13.00	-39.56	-60.13	-56.46	6.05
3386.40	V	-53.58	-13.00	-40.58	-63.08	-57.95	6.52

NOTE: ERP = S.G power value + correction factor - 2.15.

Mode							
LTE Band 5, CB: 1.4MHz, 1RB, Offset 0, Channel: 20407							
Frequency (MHz)	Antenna Polarity	E.R.P (dBm)	Limit (dBm)	Margin (dB)	S.A Reading (dBm)	S.G Power Vaule (dBm)	Correction Factor (dB)
1649.10	H	-65.17	-13.00	-52.17	-66.82	-68.05	5.03
2472.50	H	-66.34	-13.00	-53.34	-72.40	-70.27	6.08
3297.40	H	-56.43	-13.00	-43.43	-66.36	-60.68	6.40
1649.10	V	-59.49	-13.00	-46.49	-60.41	-62.37	5.03
2472.50	V	-64.27	-13.00	-51.27	-71.48	-68.20	6.08
3297.40	V	-55.50	-13.00	-42.50	-64.96	-59.75	6.40

Mode							
LTE Band 5, CB: 1.4MHz, 1RB, Offset 0, Channel: 20525							
Frequency (MHz)	Antenna Polarity	E.R.P (dBm)	Limit (dBm)	Margin (dB)	S.A Reading (dBm)	S.G Power Vaule (dBm)	Correction Factor (dB)
1672.20	H	-64.33	-13.00	-51.33	-66.11	-67.28	5.10
2508.70	H	-66.48	-13.00	-53.48	-72.76	-70.39	6.06
3343.70	H	-56.44	-13.00	-43.44	-65.97	-60.75	6.46
1672.20	V	-58.29	-13.00	-45.29	-59.25	-61.24	5.10
2508.70	V	-63.84	-13.00	-50.84	-71.25	-67.75	6.06
3343.70	V	-55.37	-13.00	-42.37	-64.85	-59.68	6.46

Mode							
LTE Band 5, CB: 1.4MHz, 1RB, Offset 0, Channel: 20643							
Frequency (MHz)	Antenna Polarity.	E.R.P (dBm)	Limit (dBm)	Margin (dB)	S.A Reading (dBm)	S.G Power Vaule (dBm)	Correction Factor (dB)
1695.40	H	-64.53	-13.00	-51.53	-66.43	-67.56	5.18
2543.40	H	-66.54	-13.00	-53.54	-73.02	-70.44	6.05
3391.50	H	-56.29	-13.00	-43.29	-65.40	-60.67	6.53
1695.40	V	-58.04	-13.00	-45.04	-59.03	-61.07	5.18
2543.40	V	-63.93	-13.00	-50.93	-71.52	-67.83	6.05
3391.50	V	-43.62	-13.00	-30.62	-53.12	-48.00	6.53

NOTE: ERP = S.G power value + correction factor - 2.15.

Mode							
LTE Band 5, CB: 3MHz, 1RB, Offset 0, Channel: 20415							
Frequency (MHz)	Antenna Polarity	E.R.P (dBm)	Limit (dBm)	Margin (dB)	S.A Reading (dBm)	S.G Power Vaule (dBm)	Correction Factor (dB)
1652.00	H	-65.23	-13.00	-52.23	-66.89	-68.12	5.04
2476.80	H	-66.40	-13.00	-53.40	-72.49	-70.33	6.08
3301.70	H	-56.29	-13.00	-43.29	-66.18	-60.54	6.40
1652.00	V	-59.54	-13.00	-46.54	-60.46	-62.43	5.04
2476.80	V	-64.95	-13.00	-51.95	-72.18	-68.88	6.08
3301.70	V	-55.57	-13.00	-42.57	-65.02	-59.82	6.40

Mode							
LTE Band 5, CB: 3MHz, 1RB, Offset 0, Channel: 20525							
Frequency (MHz)	Antenna Polarity	E.R.P (dBm)	Limit (dBm)	Margin (dB)	S.A Reading (dBm)	S.G Power Vaule (dBm)	Correction Factor (dB)
1672.20	H	-64.30	-13.00	-51.30	-66.08	-67.25	5.10
2508.70	H	-66.39	-13.00	-53.39	-72.67	-70.30	6.06
3346.60	H	-56.24	-13.00	-43.24	-65.74	-60.56	6.47
1672.20	V	-58.30	-13.00	-45.30	-59.26	-61.25	5.10
2508.70	V	-63.58	-13.00	-50.58	-70.99	-67.49	6.06
3346.60	V	-55.02	-13.00	-42.02	-64.50	-59.34	6.47

Mode							
LTE Band 5, CB: 3MHz, 1RB, Offset 0, Channel: 20635							
Frequency (MHz)	Antenna Polarity.	E.R.P (dBm)	Limit (dBm)	Margin (dB)	S.A Reading (dBm)	S.G Power Vaule (dBm)	Correction Factor (dB)
1695.40	H	-64.83	-13.00	-51.83	-66.73	-67.86	5.18
2542.00	H	-66.54	-13.00	-53.54	-73.01	-70.44	6.05
3390.00	H	-56.33	-13.00	-43.33	-65.45	-60.71	6.53
1695.40	V	-58.19	-13.00	-45.19	-59.18	-61.22	5.18
2542.00	V	-64.04	-13.00	-51.04	-71.63	-67.94	6.05
3390.00	V	-43.67	-13.00	-30.67	-53.17	-48.05	6.53

NOTE: ERP = S.G power value + correction factor - 2.15.

Mode							
LTE Band 5, CB: 5MHz, 1RB, Offset 0, Channel: 20425							
Frequency (MHz)	Antenna Polarity	E.R.P (dBm)	Limit (dBm)	Margin (dB)	S.A Reading (dBm)	S.G Power Vaule (dBm)	Correction Factor (dB)
1645.10	H	-65.74	-13.00	-52.74	-67.37	-68.61	5.02
2467.65	H	-66.94	-13.00	-53.94	-72.98	-70.87	6.08
3290.20	H	-56.38	-13.00	-43.38	-66.37	-60.62	6.39
1645.10	V	-59.35	-13.00	-46.35	-60.26	-62.22	5.02
2467.65	V	-64.73	-13.00	-51.73	-71.92	-68.66	6.08
3290.20	V	-55.98	-13.00	-42.98	-65.43	-60.22	6.39

Mode							
LTE Band 5, CB: 5MHz, 1RB, Offset 0, Channel: 20525							
Frequency (MHz)	Antenna Polarity	E.R.P (dBm)	Limit (dBm)	Margin (dB)	S.A Reading (dBm)	S.G Power Vaule (dBm)	Correction Factor (dB)
1668.70	H	-65.62	-13.00	-52.62	-67.38	-68.56	5.09
2503.05	H	-67.01	-13.00	-54.01	-73.25	-70.92	6.06
3337.40	H	-56.59	-13.00	-43.59	-66.18	-60.89	6.45
1668.70	V	-58.62	-13.00	-45.62	-59.57	-61.56	5.09
2503.05	V	-64.52	-13.00	-51.52	-71.89	-68.43	6.06
3337.40	V	-55.41	-13.00	-42.41	-64.89	-59.71	6.45

Mode							
LTE Band 5, CB: 5MHz, 1RB, Offset 0, Channel: 20625							
Frequency (MHz)	Antenna Polarity.	E.R.P (dBm)	Limit (dBm)	Margin (dB)	S.A Reading (dBm)	S.G Power Vaule (dBm)	Correction Factor (dB)
1692.30	H	-65.31	-13.00	-52.31	-67.20	-68.33	5.17
2538.45	H	-66.81	-13.00	-53.81	-73.25	-70.71	6.05
3384.60	H	-56.84	-13.00	-43.84	-66.01	-61.21	6.52
1692.30	V	-58.47	-13.00	-45.47	-59.46	-61.49	5.17
2538.45	V	-64.28	-13.00	-51.28	-71.84	-68.18	6.05
3384.60	V	-44.19	-13.00	-31.19	-53.69	-48.56	6.52

NOTE: ERP = S.G power value + correction factor - 2.15.

Mode							
LTE Band 5, CB: 10MHz, 1RB, Offset 0, Channel: 20450							
Frequency (MHz)	Antenna Polarity	E.R.P (dBm)	Limit (dBm)	Margin (dB)	S.A Reading (dBm)	S.G Power Vaule (dBm)	Correction Factor (dB)
1649.20	H	-65.44	-13.00	-52.44	-67.09	-68.32	5.03
2473.80	H	-66.58	-13.00	-53.58	-72.65	-70.51	6.08
3298.40	H	-56.66	-13.00	-43.66	-66.59	-60.91	6.40
1649.20	V	-59.28	-13.00	-46.28	-60.20	-62.16	5.03
2473.80	V	-64.58	-13.00	-51.58	-71.80	-68.51	6.08
3298.40	V	-55.81	-13.00	-42.81	-65.27	-60.06	6.40

Mode							
LTE Band 5, CB: 10MHz, 1RB, Offset 0, Channel: 20525							
Frequency (MHz)	Antenna Polarity	E.R.P (dBm)	Limit (dBm)	Margin (dB)	S.A Reading (dBm)	S.G Power Vaule (dBm)	Correction Factor (dB)
1664.20	H	-64.55	-13.00	-51.55	-66.28	-67.48	5.08
2496.30	H	-66.96	-13.00	-53.96	-51.81	-70.88	6.07
3328.40	H	-56.43	-13.00	-43.43	-41.28	-60.72	6.44
1664.20	V	-58.49	-13.00	-45.49	-59.43	-61.42	5.08
2496.30	V	-64.10	-13.00	-51.10	-71.44	-68.02	6.07
3328.40	V	-55.30	-13.00	-42.30	-64.77	-59.59	6.44

Mode							
LTE Band 5, CB: 10MHz, 1RB, Offset 0, Channel: 20600							
Frequency (MHz)	Antenna Polarity.	E.R.P (dBm)	Limit (dBm)	Margin (dB)	S.A Reading (dBm)	S.G Power Vaule (dBm)	Correction Factor (dB)
1679.20	H	-65.08	-13.00	-52.08	-66.90	-68.06	5.13
2518.80	H	-66.83	-13.00	-53.83	-73.16	-70.74	6.06
3358.40	H	-56.54	-13.00	-43.54	-65.94	-60.87	6.48
1679.20	V	-58.32	-13.00	-45.32	-59.29	-61.30	5.13
2518.80	V	-64.23	-13.00	-51.23	-71.69	-68.14	6.06
3358.40	V	-44.00	-13.00	-31.00	-53.49	-48.33	6.48

NOTE: ERP = S.G power value + correction factor - 2.15.

3.3 Conducted Emissions

3.3.1 Limit of Conducted Emissions

The power of any emission outside of the authorized operating frequency ranges must be attenuated below the transmitting power (P) by a factor of at least $43 + 10 \log(P)$ dB equal to -13dBm.

3.3.2 Test Procedures

1. Lowest, middle and highest operating channels are tested for this item.
2. Scan frequency range is from 30 MHz ~ 9 GHz.
3. Set RBW = 1MHz, VBW = 3MHz, detector = RMS, sweep time = auto.
4. Record the max trace value and capture the test plot of each sub frequency band.

3.3.3 Test Setup

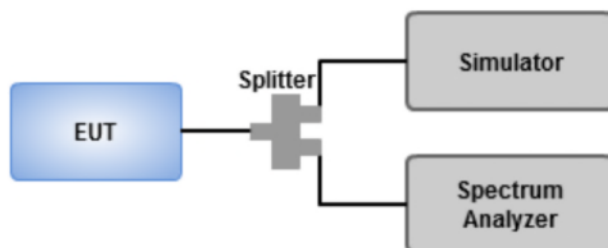

3.3.4 Test Result of Conducted Emissions

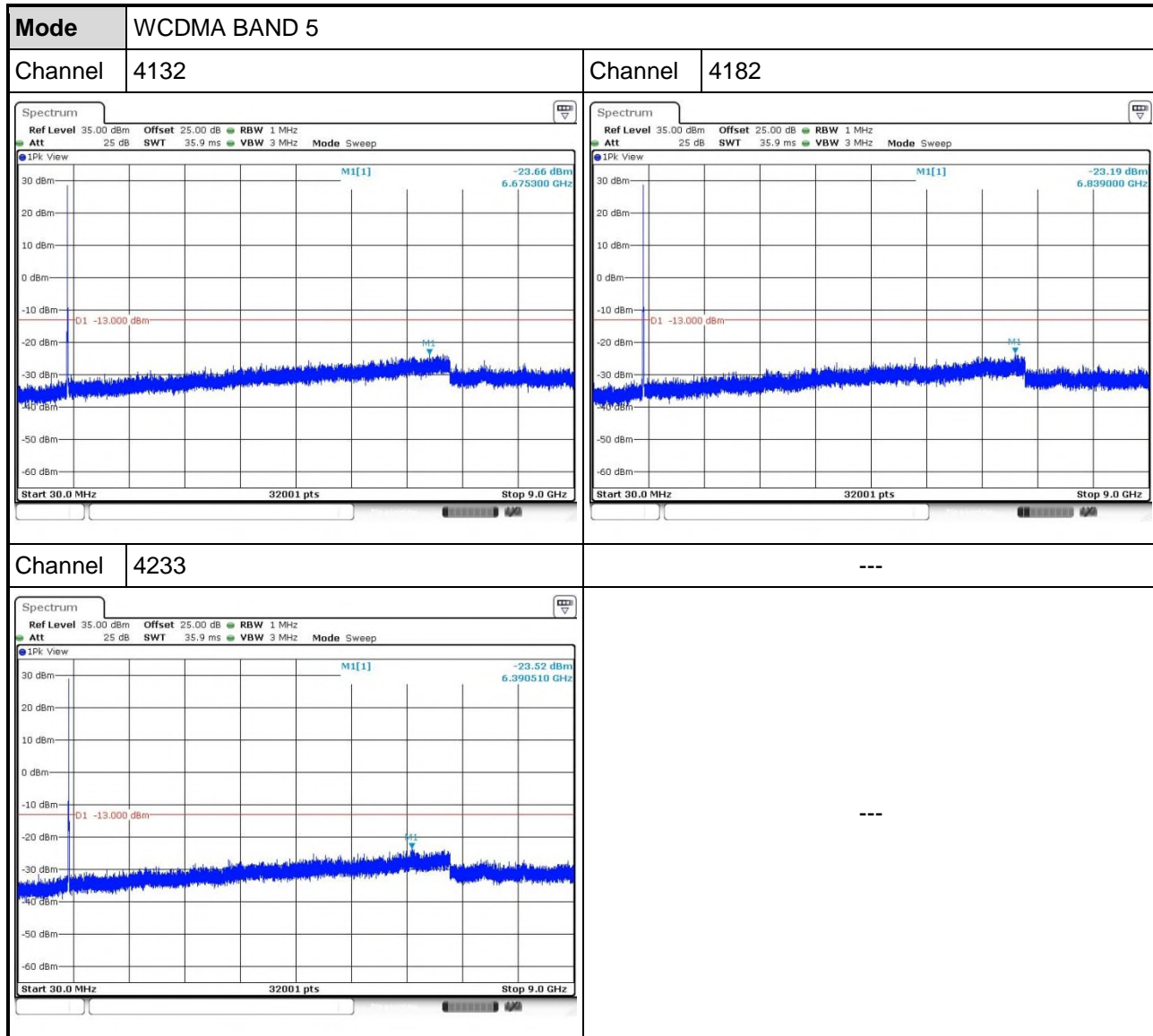

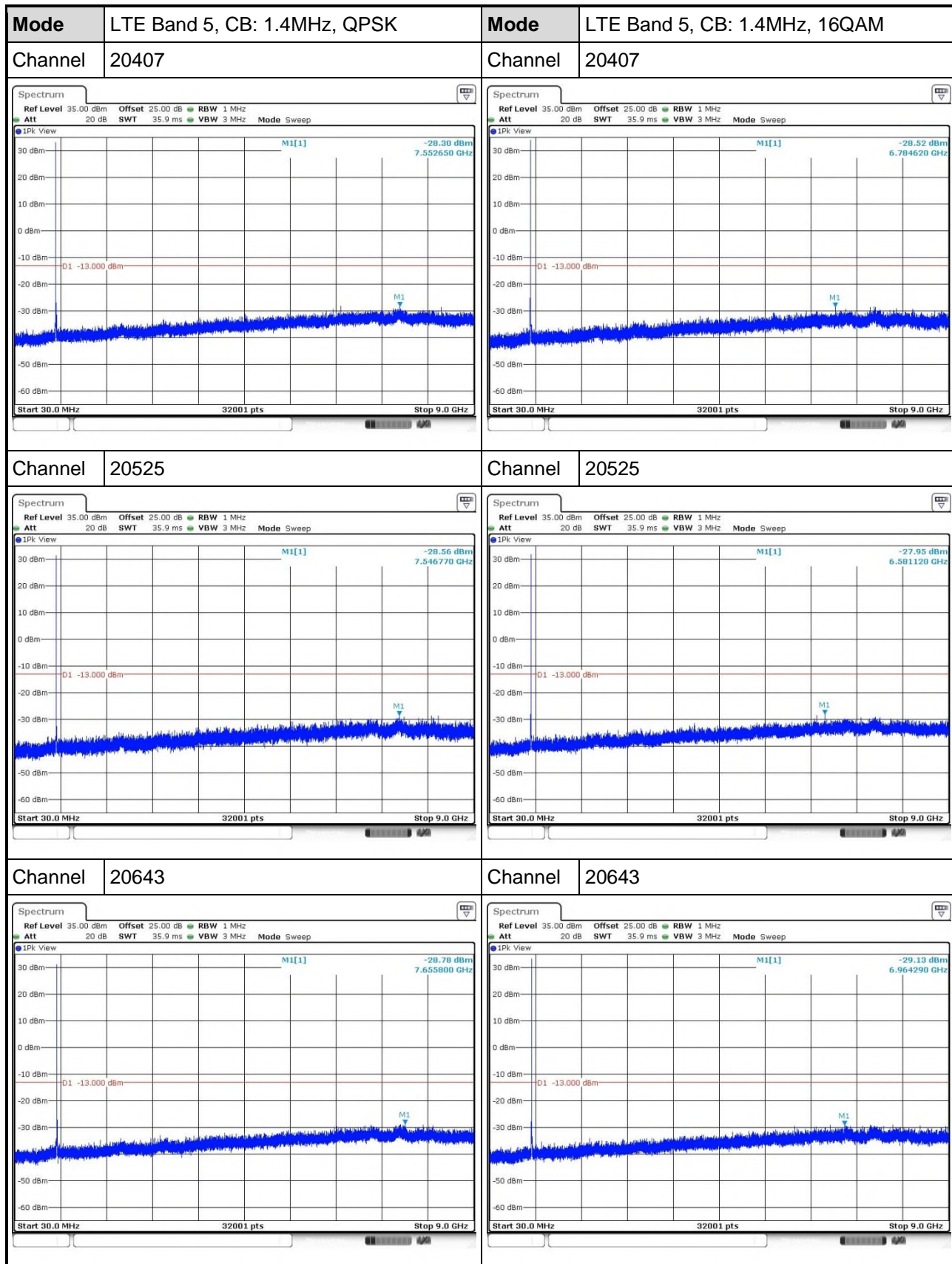

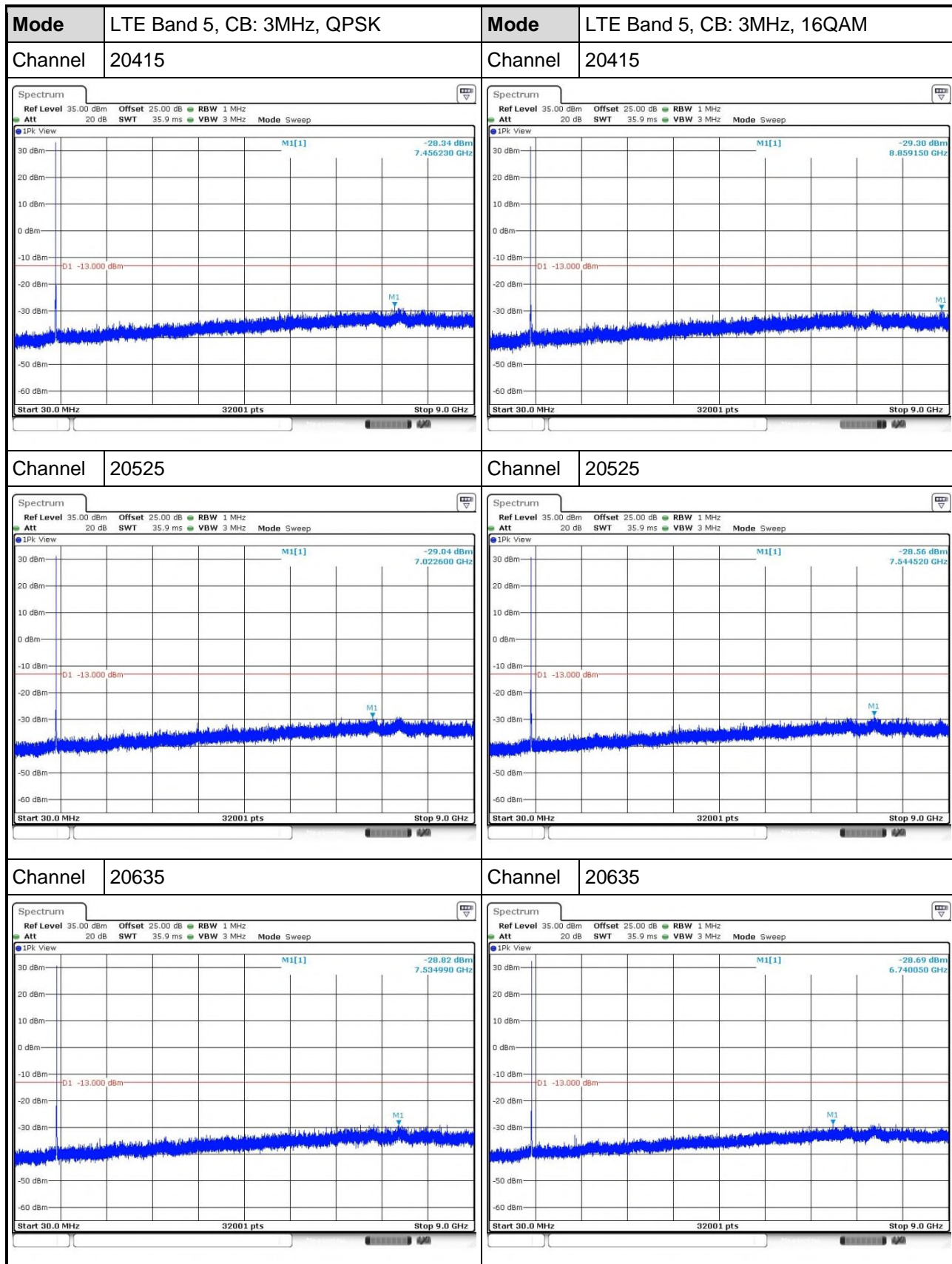

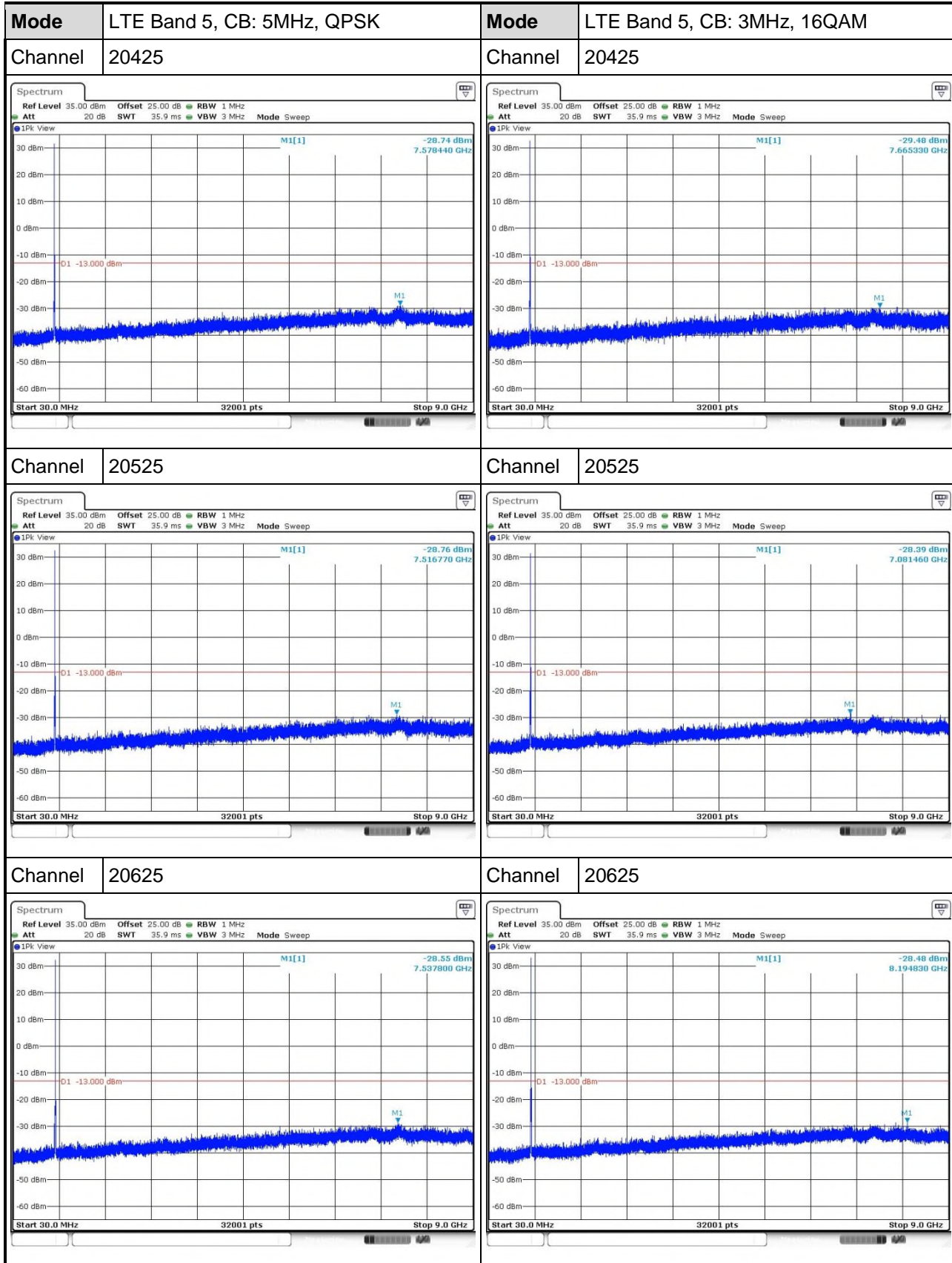

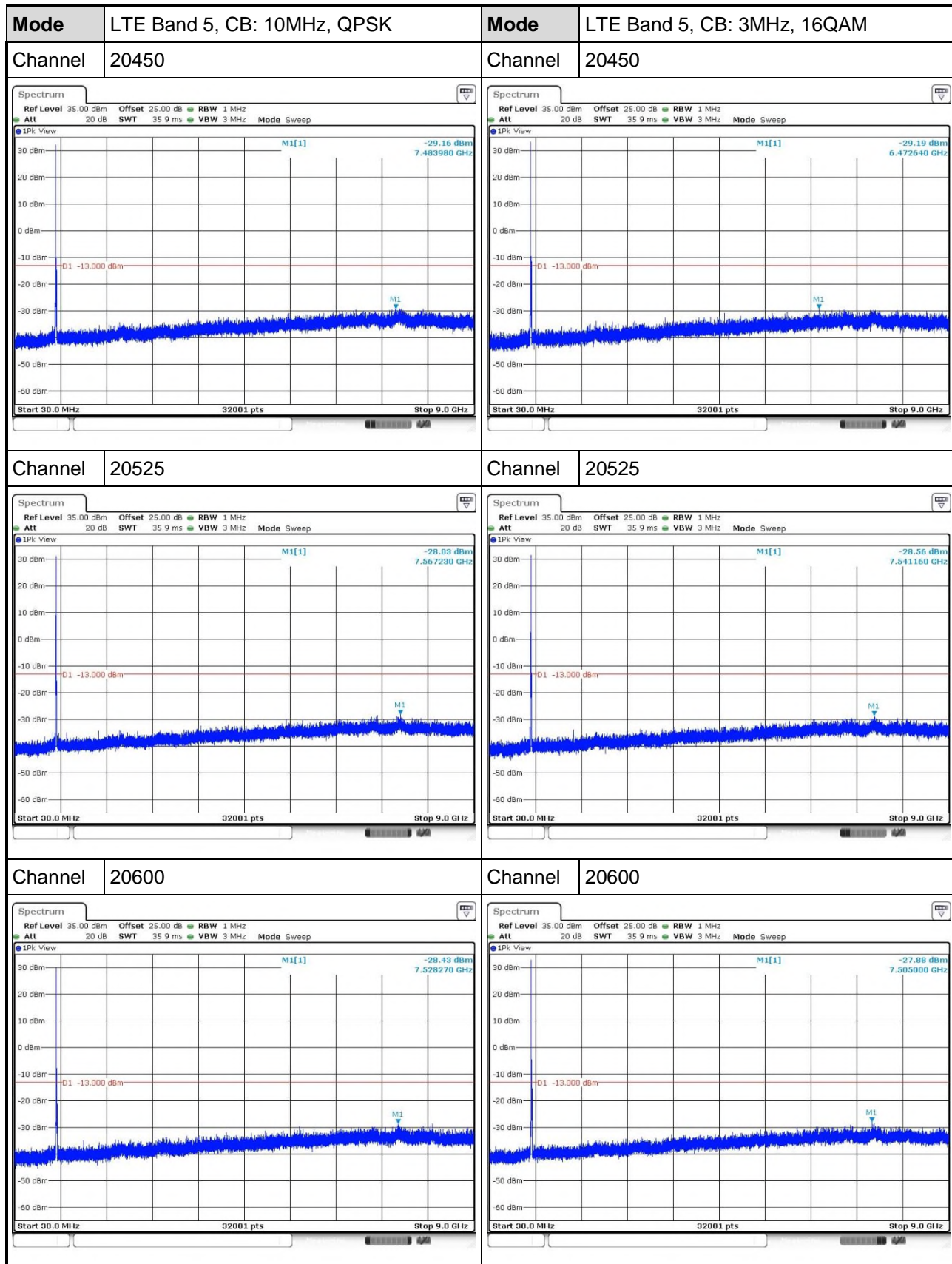

3.4 Band Edge

3.4.1 Limit of Band Edge

The power of any emission outside of the authorized operating frequency ranges must be attenuated below the transmitting power (P) by a factor of at least $43 + 10 \log(P)$ dB equal to -13dBm.

3.4.2 Test Procedures

For WCDMA

1. Lowest and highest operating channels are tested for this item.
2. The center frequency of spectrum analyzer will be set to 824 and 849 MHz.
3. Set RBW = 100 kHz, VBW = 300 kHz, span = 5 MHz, detector = RMS, sweep time = auto.
4. Record the max trace value and capture the test plot.

For LTE

1. Lowest and highest operating channels are tested for this item.
2. Set RBW = 15 / 39 / 56 / 110 kHz, VBW = 62 / 120 / 180 / 330 kHz for LTE channel bandwidth 1.4 / 3 / 5 / 10 MHz, detector = RMS, sweep time = auto to measure trace.
3. Set RBW = 20 / 50 / 100 / 100 kHz, VBW = 100 / 200 / 300 / 300 kHz for LTE channel bandwidth 1.4 / 3 / 5 / 10 MHz, detector = RMS and use channel power measurement function of spectrum analyzer to integrate power over 1MHz.

3.4.3 Test Setup

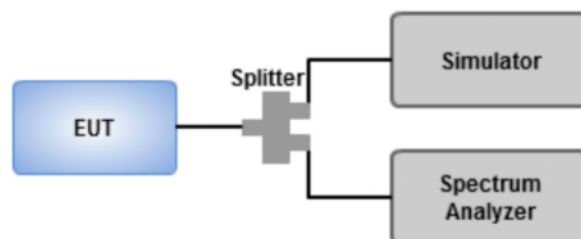

3.4.4 Test Result of Band Edge

