

AGE14+

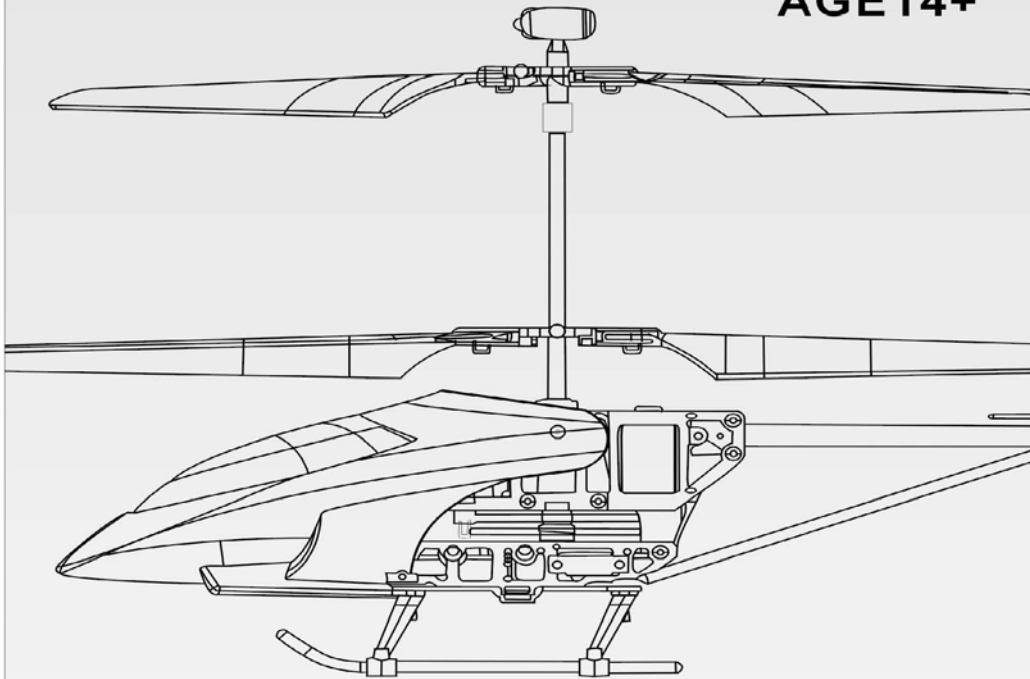

R/C HELICOPTER USING INSTRUCTION

- 1.Intelligentized R/C system.**
- 2.Full scale remote contro.**
- 3.360° exact directional.**
- 4.Smooth hang performance.**
- 5.Newly designed electricity saving function.**
- 6.Safeguard battery model to prolong the uses life.**
- 7.Built-in Gyroscope.**

Please read the instrucedions carefully before use .[Please read the Notice in details.]Please retain the instrucedions for future reference.

INCLUDED PARTS NAME:

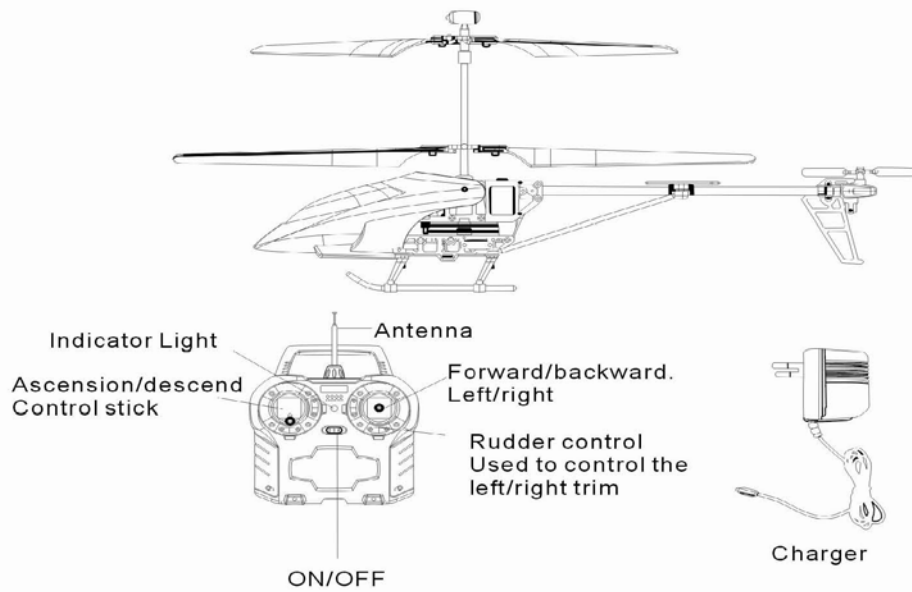

ASSEMBLY TRANSMITTER

1. Install antenna cord: remove antenna into adapter clockwise.
2. Install batteries: open the cover of battery case, insert 4 batteries (size 1.5V AA) properly followed by polar indicator. (Batteries to be purchased).



Fig. 1

NOTICE:

1. Install the battery must recognize the battery and battery box is precise.
2. Do not mix and old batteries together when in use.
3. Please don't mix different types of batteries when in use.

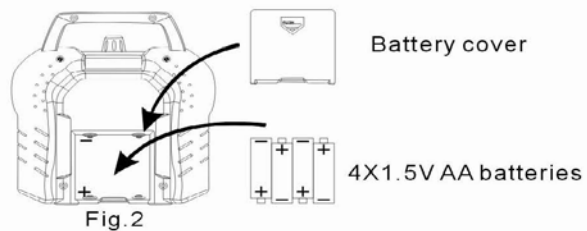
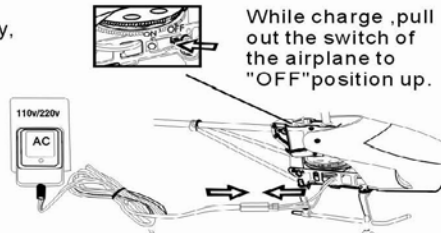

Fig. 2

Using instructions of charging power batteries

Always turn off the helicopter power, connect the charge plug of the charger to the charge slot on the helicopter, then insert the charger into the power jack. When charging the LED is off, and charge is finished the LED is on. Do not charge over the 100-110 minutes.

- Helicopter is equipped with a Li-Poly battery, please also pay attention to the following cautions for safety use.
- Do not use or leave the battery near a heat source such as fire or heater. Otherwise it can cause damage or explode.
- Do not immerse the battery in water, and keep the battery in a cool dry environment.
- When recharging, only use the battery charger specifically for that purpose.
- Do not disassemble the battery.
- Never leave the battery unattended during charging.



While charge, pull out the switch of the airplane to "OFF" position up.

NOTICE

- When you are tired of playing, please turn off the power switch on the chopper and on the controller to extend battery's usage time.
- Be sure the adapter fit your local electrical power supply.

ENVIRONMENT FOR FLIGHT:

1. Fly on a sunny day, without wind.

① Do not fly in extreme temperature.

Do not fly in temperature above 113 degrees Fahrenheit /45 degrees centigrade, or below 50 degrees Fahrenheit /10 degrees centigrade.

Flying in extreme heat and/of cold will affect performance and may damage the model.

② Do not fly in strong wind.

Windy conditions will limit, or disturb the flying control.

In very windy conditions, your helicopter may become lost and/or damaged.

2. Select a large, wide-open area for flying, and make sure is no obstructions.

Animals or people nearby.

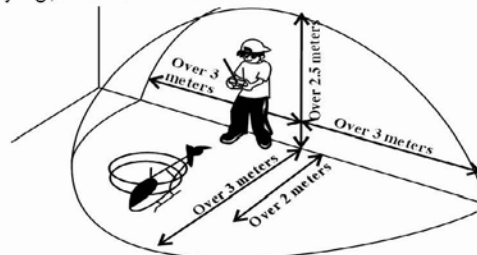

READY TO FLY

1. Lay your helicopter onto the ground, turn on the power switch, and the indicator lights.

2. Leave the helicopter at least two meters away, while the tail aimed at you.

3. Check that the helicopter be far away, from the crowd, animals and other obstructions.







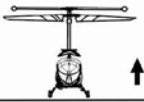

4. Pull antenna full out of remote control device, make sure the joystick at lower place.

Turn on the controller's power, and it works, then you can use it to fly the helicopter.

NOTICE

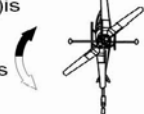
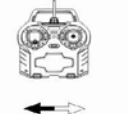
While the indicator of the controller is sparkle, which shows the controller is lack of power. And you can change some batteries for it.

CONTROL METHOD



Ascend	When you push up the left stick (throttle stick,)the spinning speed of the main rotor blade is increase and the helicopter begin to ascend.		
Descend	When you pull down the left stick (throttle stick,)the spinning speed of the main rotor blade is decrease and the helicopter begin to descend.		
Steering	1. when the right stick (rudder stick)is moving to left, the head of the helicopter turns to left. 2. whe the right stick (rudder stick)is moving to Right,the head of the helicopter turns to right.		
Forward	When you push up the right control lever(steering rudder), the nose incline to down,the helicopter is moving to forward		
Backward	When you push down the right control lever(steering rudder), the nose incline to up, the helicopter is moving to backward.		

SPECIAL PROMPT

If helicopter flies,rotating in the air without pulling control stick,then you can stop the fly,use screw driver to adjust the potentiometer on chopper circuit board lightly till it is steady. Then adjust the hard adjustment till it stop revolving.(If helicopter is revolving in the air yet you do not make action to the rudder,you can use the fine-turn-button on it to make helicopter stop revolving and back to the balance.If head of helicopter rotates clockwise,slowly touch fine-trun-button left of the rudder to keep it balance,and vice versa. But when this adjust action is useless,make helicopter landing,turn off the power on it.Then you turn on the power of helicopter and launch it,adjust the fine-turn-button again.)

NOTICE

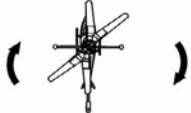
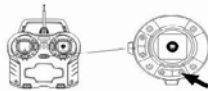
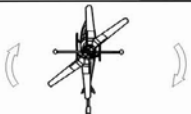
When the airpane away from theground in 30cm position the helicopter will suffer by itself blade vortex to became unstable, we call it " effect response ".when the helicopter weight lower,and the " effect response " affect will be bigger.

If head of helicopter rotates anticlockwise, Continuous slowly touch the right fine-turn-button to keep the helicopter.			Right button
If head of helicopter rotates clockwise, Continuous slowly touch the left fine-turn-button to keep the helicopter.			Left button

FLYING PRACTICE

After the enough practice, you can attempts follwing flying practice

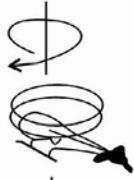

Fixed revo lves
(direction revolve)

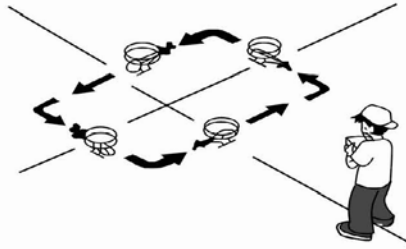

Always go forward and turn left, and exercise flight in a quadrate pattern, then repeatedly practices to gradual practice flight in a rotundity.

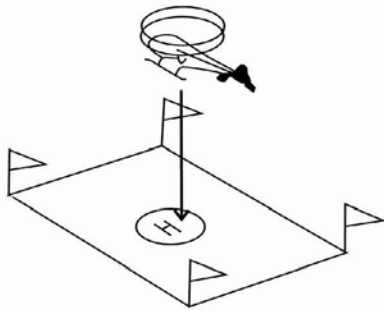

Landing at the appoint
pace(fixed landing)



(Number 8 flight)

TROUBLE SHOOT AND DEALING WITH

PROBLEM	CAUSE	CHECK THIS
Controller doesn't	1. Controller's power switch is "OFF".	1. Turn power switch "ON".
	2. Insert batteries into controller improperly.	2. Confirm batteries be inserted according to their pole.
	3. Batteries lack of power.	3. Change new batteries instead.
Can not control the helicopter	1. You haven't operated the controller.	1. Turn controller power switch "ON".
	2. Doesn't turn on controller's power switch.	2. Turn helicopter's power switch "ON".
	3. Doesn't wrest antenna into controller completely, or antenna isn't fully pulled out.	3. Wrest antenna completely and pull it out.
	4. You play the helicopter in strong winds weather.	4. Do not play the chopper in winds, which can confuse your control.
Helicopter can not rise	1. Main rotor blades rotate too slowly.	1. Pull up the throttle stick.
	2. Doesn't fully charge helicopter's battery.	2. Fully charge helicopter battery. (See instruction above)
Helicopter land too fast.	You lose the throttle stick or pull is down too fast.	Slowly pull down the throttle till the chopper landing smoothly.

CAUTION

1. The control distance will be shorter when the quantity of electricity is not full.
2. When the quantity of the electricity of the helicopter is not full, the helicopter will have difficulty or the height of fly is not enough.
3. If the helicopter becomes damaged, deformed, please repair it in time.
If the rotor becomes damaged or broken, do not fly, otherwise, it will lead to injury.
4. If you don't use the transmitter for a long time, remove all batteries out, in order to avoid the battery leakage to damage this product.
5. Don't drop the helicopter from a high position or crash it seriously, because that will damage it seriously or shorten the using time.
6. This product contains many kinds of alloy parts, please pay more attention when operating the helicopter.

Explanation of the main part of the receiving box

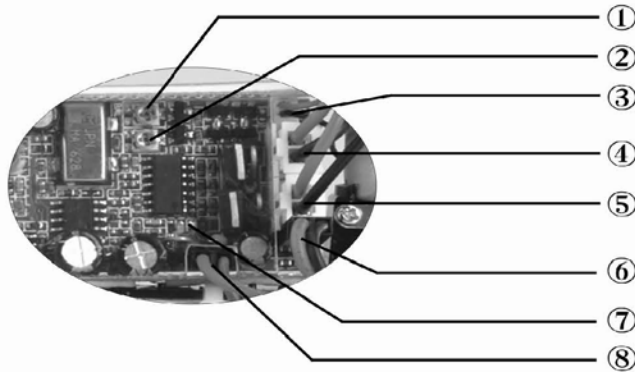

- ① Tail wing sensitivity adjustment (SENSITIVE):
Please adjust according to the flying effect of the airplane.
Clockwise adjust to increase sensitivity, anti-clockwise adjust to reduce sensitivity.
- ② Sensitivity adjusting of the gyroscope (SENSITIVE):
Please adjust according to the flying effect of the airplane.
Clockwise adjust to increase sensitivity, anti-clockwise adjust to reduce sensitivity.
- ③ Engine of tail wing: Connect engine of the tail wing.
- ④ Front engine: Connect the front engine.
- ⑤ Rear engine: Connect the rear engine.
- ⑥ Power connecting line: Connect the batteries
- ⑦ Power indicator (LED): Show the state of receiving signal, quickly glittering show that it's receiving the signal; In the state of eternal bright shows that it has already received the signal; Slowly glittering shows that it hasn't received the signal.
- ⑧ Connecting line of the switch: Connect the switch



PARTS ARE ALTERNATIVE



Part-01
Main frame

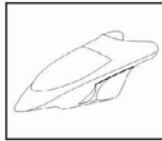

Part-02
Head Cover



Part-03
Ascend
and Descend



Part-04
main frame



Part-05
Main shaft
connection



Part-06
Main blade grip set



Part-07
Main blade A



Part-08
Main blade B



Part-09
Chopper tail unit Module

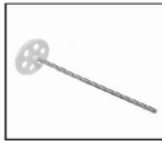

Part-10
gear set



Part-11
Gear A



Part-12
BalanceBar



Part-13
Connect buckle

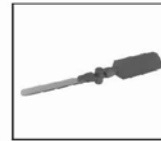

Part-14
Tail lade



Part-15
Motor protection



Part-16
Battery protection

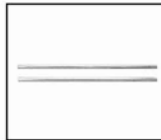

Part-17
Tail support pipe



Part-18
Tail decoration



Part-19
Motor protection



Part-20
Charger

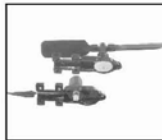

Part-21
Tail rotor rack Module



Part-22
Behind motor set



Part-23
Front motor set



Part-24
Li-poly battery

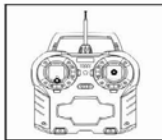

Part-25
Remote
Controller



Part-26
R/C Antenna

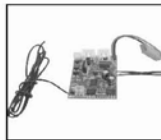

Part-27
PCB box



Part-28
ON/OFF

Warning: Changes or modifications to this unit not expressly approved by the party responsible for compliance could void the user's authority to operate the equipment.

NOTE: This equipment has been tested and found to comply with the limits for a Class B digital device, pursuant to Part 15 of the FCC Rules. These limits are designed to provide reasonable protection against harmful interference in a residential installation. This equipment generates, uses and can radiate radio frequency energy and, if not installed and used in accordance with the instructions, may cause harmful interference to radio communications.

However, there is no guarantee that interference will not occur in a particular installation. If this equipment does cause harmful interference to radio or television reception, which can be determined by turning the equipment off and on, the user is encouraged to try to correct the interference by one or more of the following measures:

- Reorient or relocate the receiving antenna.
- Increase the separation between the equipment and receiver.
- Connect the equipment into an outlet on a circuit different from that to which the receiver is connected.
- Consult the dealer or an experienced radio/TV technician for help.