

TEST REPORT

CERTIFICATE OF CONFORMITY

Standard: 47 CFR FCC Part 15, Subpart E (Section 15.407)

Report No.: RFBELJ-WTW-P22080819A-1

FCC ID: VBNNW6EAI-E

Product: Nokia DAC Wi-Fi 6E Indoor AP

Brand: Nokia

Model No.: NW6EAI-E

Received Date: 2022/9/13

Test Date: 2022/9/13 ~ 2022/10/27

Issued Date: 2023/3/21

Applicant: Nokia Solutions and Networks

Address: 3201 Olympus Blvd Dallas, Texas 75019 United States.

Issued By: Bureau Veritas Consumer Products Services (H.K.) Ltd., Taoyuan Branch
Hsin Chu Laboratory

Lab Address: E-2, No.1, Li Hsin 1st Road, Hsinchu Science Park, Hsinchu City 300, Taiwan

Test Location: E-2, No.1, Li Hsin 1st Road, Hsinchu Science Park, Hsinchu City 300, Taiwan

FCC Registration / 723255 / TW2022

Designation Number:

Approved by: _____

May Chen / Manager

Date: _____

2023/3/21

This test report consists of 128 pages in total. It may be duplicated completely for legal use with the approval of the applicant. It should not be reproduced except in full, without the written approval of our laboratory. The test results in the report only apply to the tested sample. The test results in this report are traceable to the national or international standards.

Prepared by : Luna Yu / Specialist



This report is governed by, and incorporates by reference, the Conditions of Testing as posted at the date of issuance of this report at <http://www.bureauveritas.com/home/about-us/our-business/cps/about-us/terms-conditions/> and is intended for your exclusive use. Any copying or replication of this report to or for any other person or entity, or use of our name or trademark, is permitted only with our prior written permission. This report sets forth our findings solely with respect to the test samples identified herein. The results set forth in this report are not indicative or representative of the quality or characteristics of the lot from which a test sample was taken or any similar or identical product unless specifically and expressly noted. Our report includes all of the tests requested by you and the results thereof based upon the information that you provided to us. Measurement uncertainty is only provided upon request for accredited tests. Statements of conformity are based on simple acceptance criteria without taking measurement uncertainty into account, unless otherwise requested in writing. You have 60 days from date of issuance of this report to notify us of any material error or omission caused by our negligence or if you require measurement uncertainty; provided, however, that such notice shall be in writing and shall specifically address the issue you wish to raise. A failure to raise such issue within the prescribed time shall constitute your unqualified acceptance of the completeness of this report, the tests conducted and the correctness of the report contents.

Table of Contents

| | |
|---|-----------|
| Release Control Record | 4 |
| 1 Certificate..... | 5 |
| 2 Summary of Test Results | 6 |
| 2.1 Measurement Uncertainty | 6 |
| 2.2 Supplementary Information | 6 |
| 3 General Information | 7 |
| 3.1 General Description of EUT | 7 |
| 3.2 Antenna Description of EUT | 8 |
| 3.3 Channel List..... | 9 |
| 3.4 Test Mode Applicability and Tested Channel Detail..... | 10 |
| 3.5 Duty Cycle of Test Signal..... | 12 |
| 3.6 Test Program Used and Operation Descriptions | 14 |
| 3.7 Connection Diagram of EUT and Peripheral Devices | 14 |
| 3.8 Configuration of Peripheral Devices and Cable Connections | 15 |
| 4 Test Instruments | 16 |
| 4.1 26 dB Bandwidth | 16 |
| 4.2 RF Output Power..... | 16 |
| 4.3 Power Spectral Density | 16 |
| 4.4 6 dB Bandwidth | 16 |
| 4.5 Occupied Bandwidth..... | 16 |
| 4.6 Frequency Stability | 17 |
| 4.7 AC Power Conducted Emissions | 17 |
| 4.8 Unwanted Emissions below 1 GHz | 18 |
| 4.9 Unwanted Emissions above 1 GHz..... | 19 |
| 5 Limits of Test Items..... | 20 |
| 5.1 26 dB Bandwidth | 20 |
| 5.2 RF Output Power..... | 20 |
| 5.3 Power Spectral Density | 20 |
| 5.4 6 dB Bandwidth | 20 |
| 5.5 Occupied Bandwidth..... | 20 |
| 5.6 Frequency Stability | 20 |
| 5.7 AC Power Conducted Emissions | 20 |
| 5.8 Unwanted Emissions below 1 GHz | 21 |
| 5.9 Unwanted Emissions above 1 GHz..... | 22 |
| 6 Test Arrangements..... | 23 |
| 6.1 26 dB Bandwidth | 23 |
| 6.1.1 Test Setup | 23 |
| 6.1.2 Test Procedure..... | 23 |
| 6.2 RF Output Power..... | 24 |
| 6.2.1 Test Setup | 24 |
| 6.2.2 Test Procedure..... | 24 |
| 6.3 Power Spectral Density | 25 |
| 6.3.1 Test Setup | 25 |
| 6.3.2 Test Procedure..... | 25 |
| 6.4 6 dB Bandwidth | 25 |
| 6.4.1 Test Setup | 25 |
| 6.4.2 Test Procedure..... | 25 |
| 6.5 Occupied Bandwidth..... | 26 |
| 6.5.1 Test Setup | 26 |
| 6.5.2 Test Procedure..... | 26 |
| 6.6 Frequency Stability | 27 |
| 6.6.1 Test Setup | 27 |
| 6.6.2 Test Procedure..... | 27 |
| 6.7 AC Power Conducted Emissions | 28 |



| | | |
|----------|--|------------|
| 6.7.1 | Test Setup | 28 |
| 6.7.2 | Test Procedure | 28 |
| 6.8 | Unwanted Emissions below 1 GHz | 29 |
| 6.8.1 | Test Setup | 29 |
| 6.8.2 | Test Procedure | 30 |
| 6.9 | Unwanted Emissions above 1 GHz | 31 |
| 6.9.1 | Test Setup | 31 |
| 6.9.2 | Test Procedure | 31 |
| 7 | Test Results of Test Item | 32 |
| 7.1 | 26 dB Bandwidth | 32 |
| 7.2 | RF Output Power | 36 |
| 7.3 | Power Spectral Density | 59 |
| 7.4 | 6 dB Bandwidth | 63 |
| 7.5 | Occupied Bandwidth | 65 |
| 7.6 | Frequency Stability | 67 |
| 7.7 | AC Power Conducted Emissions | 68 |
| 7.8 | Unwanted Emissions below 1 GHz | 70 |
| 7.9 | Unwanted Emissions above 1 GHz | 72 |
| 8 | Pictures of Test Arrangements | 127 |
| 9 | Information of the Testing Laboratories | 128 |



Release Control Record

| Issue No. | Description | Date Issued |
|-------------------------|-------------------|-------------|
| RFBELJ-WTW-P22080819A-1 | Original release. | 2023/3/21 |

1 Certificate

Product: Nokia DAC Wi-Fi 6E Indoor AP

Brand: Nokia

Test Model: NW6EAI-E

Sample Status: Engineering sample

Applicant: Nokia Solutions and Networks

Test Date: 2022/9/13 ~ 2022/10/27

Standard: 47 CFR FCC Part 15, Subpart E (Section 15.407)

Measurement ANSI C63.10-2013

procedure: KDB 789033 D02 General UNII Test Procedure New Rules v02r01

KDB 662911 D01 Multiple Transmitter Output v02r01

The above equipment has been tested by **Bureau Veritas Consumer Products Services (H.K.) Ltd., Taoyuan Branch**, and found compliance with the requirement of the above standards. The test record, data evaluation & Equipment Under Test (EUT) configurations represented herein are true and accurate accounts of the measurements of the sample's RF characteristics under the conditions specified in this report.

2 Summary of Test Results

| 47 CFR FCC Part 15, Subpart E (Section 15.407) | | | |
|--|--------------------------------|--------|--|
| Clause | Test Item | Result | Remark |
| 15.407(a)(2) | 26 dB Bandwidth | Pass | For U-NII-2A U-NII-2C Band output power limitation is determined based on 26dBc bandwidth. |
| 15.407(a)(1/2) | RF Output Power | Pass | Meet the requirement of limit. |
| 15.407(a)(1/2) | Power Spectral Density | Pass | Meet the requirement of limit. |
| 15.407(e) | 6 dB Bandwidth | Pass | Meet the requirement of limit. (U-NII-3 Band only) |
| --- | Occupied Bandwidth | - | Reference only. |
| 15.407(g) | Frequency Stability | Pass | Meet the requirement of limit. |
| 15.407(b)(9) | AC Power Conducted Emissions | Pass | Minimum passing margin is -6.56 dB at 0.47422 MHz |
| 15.407(b)(9) | Unwanted Emissions below 1 GHz | Pass | Minimum passing margin is -11.0 dB at 907.49 MHz |
| 15.407(b) (1/2/3/10) | Unwanted Emissions above 1 GHz | Pass | Minimum passing margin is -0.2 dB at 5350.00 MHz |
| 15.203 | Antenna Requirement | Pass | No antenna connector is used. |

Note: Determining compliance based on the results of the compliance measurement, not taking into account measurement instrumentation uncertainty.

2.1 Measurement Uncertainty

Where relevant, the following measurement uncertainty levels have been estimated for tests performed on the EUT as specified in CISPR 16-4-2:

| Parameter | Specification | Uncertainty (±) |
|--------------------------------|------------------|-----------------|
| AC Power Conducted Emissions | 150 kHz ~ 30 MHz | 1.9 dB |
| Unwanted Emissions below 1 GHz | 9 kHz ~ 30 MHz | 3.1 dB |
| | 30 MHz ~ 1 GHz | 5.5 dB |
| Unwanted Emissions above 1 GHz | 9 kHz ~ 30 MHz | 3.1 dB |
| | 1 GHz ~ 18 GHz | 5.1 dB |
| | 18 GHz ~ 40 GHz | 5.3 dB |

The other instruments specified are routine verified to remain within the calibrated levels, no measurement uncertainty is required to be calculated.

2.2 Supplementary Information

There is not any deviation from the test standards for the test method, and no modifications required for compliance.

3 General Information

3.1 General Description of EUT

| | |
|-----------------------|--|
| Product | Nokia DAC Wi-Fi 6E Indoor AP |
| Brand | Nokia |
| Test Model | NW6EAI-E |
| Status of EUT | Engineering sample |
| Power Supply Rating | 12 Vdc from AC adapter or 56 Vdc from POE adapter |
| Modulation Type | 64QAM, 16QAM, QPSK, BPSK for OFDM 256QAM for OFDM in 11ac mode 1024QAM for OFDMA in 11ax HE mode |
| Modulation Technology | OFDM, OFDMA |
| Transfer Rate | 802.11a: up to 54 Mbps 802.11n: up to 600 Mbps 802.11ac: up to 3466.7 Mbps 802.11ax: up to 4803.9 Mbps |
| Operating Frequency | 5.26 GHz ~ 5.32 GHz 5.5 GHz ~ 5.72 GHz |
| Number of Channel | 802.11a, 802.11n (HT20), 802.11ac (VHT20), 802.11ax (HE20): 16 802.11n (HT40), 802.11ac (VHT40), 802.11ax (HE40): 8 802.11ac (VHT80), 802.11ax (HE80): 4 |
| Output Power | CDD Mode: 5.26 GHz ~ 5.32 GHz: 170.169 mW (22.31 dBm) 5.5 GHz ~ 5.72 GHz: 242.702 mW (23.85 dBm) Beamforming Mode: 5.26 GHz ~ 5.32 GHz: 79.019 mW (18.98 dBm) 5.5 GHz ~ 5.72 GHz: 80.272 mW (19.05 dBm) |

Note:

- This is a supplementary report of Report No.: RFBELJ-WTW-P22080819-1. The differences between them are as below information:
 - ◆ Add DFS band <5250~5350 MHz & 5470~5725 MHz> by software.
- According to above condition, all test items need to be performed. And all data are verified to meet the requirements.
- Simultaneously transmission condition.

| Condition | Technology | | |
|-----------|-------------|-----------|-----------|
| 1 | WLAN 2.4GHz | WLAN 5GHz | WLAN 6GHz |

Note: The emission of the simultaneous operation has been evaluated and no non-compliance was found.

- The above EUT information is declared by manufacturer and for more detailed features description, please refers to the manufacturer's specifications or user's manual.

3.2 Antenna Description of EUT

1. The antenna information is listed as below.

| Antenna NO. | RF Chain NO. | Antenna Net Gain(dBi) | Frequency range (GHz) | Antenna Type | Connector Type |
|-------------|--------------|-----------------------|---------------------------|--------------|----------------|
| 1 | scan | 3.9/5.8 | 2.4 to 2.49 /5.15 to 5.85 | PIFA | ipex(MHF) |
| 2 | chain 1 | 3.1 | 2.4~2.4835 | PIFA | ipex(MHF) |
| 3 | chain 2 | 4 | 2.4~2.4835 | PIFA | ipex(MHF) |
| 4 | chain 3 | 4.1 | 2.4~2.4835 | PIFA | ipex(MHF) |
| 5 | chain 0 | 5 | 2.4~2.4835 | PIFA | ipex(MHF) |
| 6 | BLE | 4.9 | 2.4~2.4835 | PIFA | ipex(MHF) |
| 7 | chain 1 | 3.7 | 5.15~5.85 | PIFA | ipex(MHF) |
| 8 | chain 3 | 4.8 | 5.15~5.85 | PIFA | ipex(MHF) |
| 9 | chain 2 | 5.4 | 5.15~5.85 | PIFA | ipex(MHF) |
| 10 | chain 0 | 5.4 | 5.15~5.85 | PIFA | ipex(MHF) |
| 11 | chain 1 | 4.9 | 5.925~7.125 | PIFA | ipex(MHF) |
| 12 | chain 3 | 6.8 | 5.925~7.125 | PIFA | ipex(MHF) |
| 13 | chain 2 | 7.3 | 5.925~7.125 | PIFA | ipex(MHF) |
| 14 | chain 0 | 6.9 | 5.925~7.125 | PIFA | ipex(MHF) |

* Detail antenna specification please refer to antenna datasheet and/or antenna measurement report.

2. The EUT incorporates a MIMO function:

| 5 GHz Band | | |
|--------------------------|-----------------------|-----|
| Modulation Mode | TX & RX Configuration | |
| 802.11a | 4TX | 4RX |
| 802.11n (HT20) | 4TX | 4RX |
| 802.11n (HT40) | 4TX | 4RX |
| 802.11ac (VHT20) | 4TX | 4RX |
| 802.11ac (VHT40) | 4TX | 4RX |
| 802.11ac (VHT80) | 4TX | 4RX |
| 802.11ax (HE20) | 4TX | 4RX |
| 802.11ax (HE40) | 4TX | 4RX |
| 802.11ax (HE80) | 4TX | 4RX |
| 802.11ax (RU242/484/996) | 4TX | 4RX |

Note:

- All of modulation mode support beamforming function except 802.11a modulation mode.
- The EUT support Beamforming and CDD mode, therefore both mode were investigated and the worst case scenario was identified. The worst case data were presented in test report.
- The modulation and bandwidth are similar for 802.11n mode for 20 MHz (40 MHz), 802.11ac mode for 20 MHz (40 MHz, 80 MHz) and 802.11ax mode for 20 MHz (40 MHz, 80 MHz), therefore the manufacturer will control the power for 802.11n/ac mode is the same as the 802.11ax or more lower than it and investigated worst case to representative mode in test report.

3.3 Channel List

FOR 5260 ~ 5320 MHz

4 channels are provided for 802.11a, 802.11n (HT20), 802.11ac (VHT20), 802.11ax (HE20):

| Channel | Frequency | Channel | Frequency |
|---------|-----------|---------|-----------|
| 52 | 5260 MHz | 60 | 5300 MHz |
| 56 | 5280 MHz | 64 | 5320 MHz |

2 channels are provided for 802.11n (HT40), 802.11ac (VHT40), 802.11ax (HE40):

| Channel | Frequency | Channel | Frequency |
|---------|-----------|---------|-----------|
| 54 | 5270 MHz | 62 | 5310 MHz |

1 channel is provided for 802.11ac (VHT80), 802.11ax (HE80):

| Channel | Frequency |
|---------|-----------|
| 58 | 5290 MHz |

FOR 5500 ~ 5720 MHz

12 channels are provided for 802.11a, 802.11n (HT20), 802.11ac (VHT20), 802.11ax (HE20):

| Channel | Frequency | Channel | Frequency |
|---------|-----------|---------|-----------|
| 100 | 5500 MHz | 124 | 5620 MHz |
| 104 | 5520 MHz | 128 | 5640 MHz |
| 108 | 5540 MHz | 132 | 5660 MHz |
| 112 | 5560 MHz | 136 | 5680 MHz |
| 116 | 5580 MHz | 140 | 5700 MHz |
| 120 | 5600 MHz | 144 | 5720 MHz |

6 channels are provided for 802.11n (HT40), 802.11ac (VHT40), 802.11ax (HE40):

| Channel | Frequency | Channel | Frequency |
|---------|-----------|---------|-----------|
| 102 | 5510 MHz | 126 | 5630 MHz |
| 110 | 5550 MHz | 134 | 5670 MHz |
| 118 | 5590 MHz | 142 | 5710 MHz |

3 channels are provided for 802.11ac (VHT80), 802.11ax (HE80):

| Channel | Frequency | Channel | Frequency |
|---------|-----------|---------|-----------|
| 106 | 5530 MHz | 138 | 5690 MHz |
| 122 | 5610 MHz | | |

3.4 Test Mode Applicability and Tested Channel Detail

| | |
|-------------|---|
| Pre-Scan: | 1. The AC Adapter/POE Adapter has the following models: WA-30P12FU/ADP-36PR B. Pre-scan these models of AC Adapters/POE Adapter and find the worst case as a representative test condition. 2. EUT can be used in the following ways: Lying/ Wall Mount. Pre-scan these ways and find the worst case as a representative test condition. 3. Pre-Scan has been conducted to determine the worst-case mode from all possible combinations between available modulations, data rates and antenna ports (if EUT with antenna diversity architecture). |
| Worst Case: | 1. Adapter Worst Condition: POE: ADP-36PR B 2. Lying/ Wall Mount Worst Condition: Wall Mount |

Following channel(s) was (were) selected for the final test as listed below:

| Test Item | Mode | Signal Mode | Tested Channel | Modulation | Data Rate Parameter | Remark |
|-----------------|----------------------------------|-------------------|--------------------------------|------------|---------------------|---------------------------------------|
| 26 dB Bandwidth | 802.11a | CDD | 52, 60, 64, 100, 116, 140, 144 | BPSK | 6Mb/s | - |
| | 802.11ax (HE20) | CDD | 52, 60, 64, 100, 116, 140, 144 | BPSK | MCS0 | - |
| | 802.11ax (HE40) | CDD | 54, 62, 102, 110, 134, 142 | BPSK | MCS0 | - |
| | 802.11ax (HE80) | CDD | 58, 106, 122, 138 | BPSK | MCS0 | - |
| RF Output Power | 802.11a | CDD | 52, 60, 64, 100, 116, 140, 144 | BPSK | 6Mb/s | - |
| | 802.11ac (VHT20) | CDD & Beamforming | 52, 60, 64, 100, 116, 140, 144 | BPSK | MCS0 | - |
| | 802.11ac (VHT40) | CDD & Beamforming | 54, 62, 102, 110, 134, 142 | BPSK | MCS0 | - |
| | 802.11ac (VHT80) | CDD & Beamforming | 58, 106, 122, 138 | BPSK | MCS0 | - |
| | 802.11ax (HE20) | CDD & Beamforming | 52, 60, 64, 100, 116, 140, 144 | BPSK | MCS0 | - |
| | 802.11ax (HE40) | CDD & Beamforming | 54, 62, 102, 110, 134, 142 | BPSK | MCS0 | - |
| | 802.11ax (HE80) | CDD & Beamforming | 58, 106, 122, 138 | BPSK | MCS0 | - |
| | 20 MHz Preamble 802.11ax (RU242) | CDD & Beamforming | 52, 60, 64, 100, 116, 140, 144 | BPSK | MCS0 | OFDMA_HE 20_Partial RU52_52_52_52 |
| | 40 MHz Preamble 802.11ax (RU484) | CDD & Beamforming | 54, 62, 102, 110, 134, 142 | BPSK | MCS0 | OFDMA_HE 40_Partial RU(52_52_52_52)*2 |
| | 80 MHz Preamble 802.11ax (RU996) | CDD & Beamforming | 58, 106, 122, 138 | BPSK | MCS0 | OFDMA_HE 80_Partial RU(52_52_52_52)*4 |

| Test Item | Mode | Signal Mode | Tested Channel | Modulation | Data Rate Parameter | Remark |
|--------------------------------|-----------------|--------------------|--------------------------------|---------------|---------------------|--------|
| Power Spectral Density | 802.11a | CDD | 52, 60, 64, 100, 116, 140, 144 | BPSK | 6Mb/s | - |
| | 802.11ax (HE20) | CDD or Beamforming | 52, 60, 64, 100, 116, 140, 144 | BPSK | MCS0 | - |
| | 802.11ax (HE40) | CDD or Beamforming | 54, 62, 102, 110, 134, 142 | BPSK | MCS0 | - |
| | 802.11ax (HE80) | CDD or Beamforming | 58, 106, 122, 138 | BPSK | MCS0 | - |
| 6 dB Bandwidth | 802.11a | CDD | 144 | BPSK | 6Mb/s | - |
| | 802.11ax (HE20) | CDD | 144 | BPSK | MCS0 | - |
| | 802.11ax (HE40) | CDD | 142 | BPSK | MCS0 | - |
| | 802.11ax (HE80) | CDD | 138 | BPSK | MCS0 | - |
| Occupied Bandwidth | 802.11a | CDD | 52, 60, 64, 100, 116, 140, 144 | BPSK | 6Mb/s | - |
| | 802.11ax (HE20) | CDD | 52, 60, 64, 100, 116, 140, 144 | BPSK | MCS0 | - |
| | 802.11ax (HE40) | CDD | 54, 62, 102, 110, 134, 142 | BPSK | MCS0 | - |
| | 802.11ax (HE80) | CDD | 58, 106, 122, 138 | BPSK | MCS0 | - |
| Frequency Stability | 802.11a | - | - | un-modulation | - | - |
| AC Power Conducted Emissions | 802.11ax (HE20) | CDD | 144 | BPSK | MCS0 | - |
| Unwanted Emissions below 1 GHz | 802.11ax (HE20) | CDD | 144 | BPSK | MCS0 | - |
| Unwanted Emissions above 1 GHz | 802.11a | CDD | 52, 60, 64, 100, 116, 140, 144 | BPSK | 6Mb/s | - |
| | 802.11ax (HE20) | CDD | 52, 60, 64, 100, 116, 140, 144 | BPSK | MCS0 | - |
| | 802.11ax (HE40) | CDD | 54, 62, 102, 110, 134, 142 | BPSK | MCS0 | - |
| | 802.11ax (HE80) | CDD | 58, 106, 122, 138 | BPSK | MCS0 | - |

3.5 Duty Cycle of Test Signal

802.11a: Duty cycle = 5.452 ms / 5.747 ms x 100% = 94.9%, duty factor = $10 * \log (1/\text{Duty cycle}) = 0.23 \text{ dB}$

802.11ax (HE20): Duty cycle = 5.399 ms / 5.732 ms x 100% = 94.2%, duty factor = $10 * \log (1/\text{Duty cycle}) = 0.26 \text{ dB}$

802.11ax (HE40): Duty cycle = 5.452 ms / 5.719 ms x 100% = 95.3%, duty factor = $10 * \log (1/\text{Duty cycle}) = 0.21 \text{ dB}$

802.11ax (HE80): Duty cycle = 5.452 ms / 5.772 ms x 100% = 94.5%, duty factor = $10 * \log (1/\text{Duty cycle}) = 0.25 \text{ dB}$

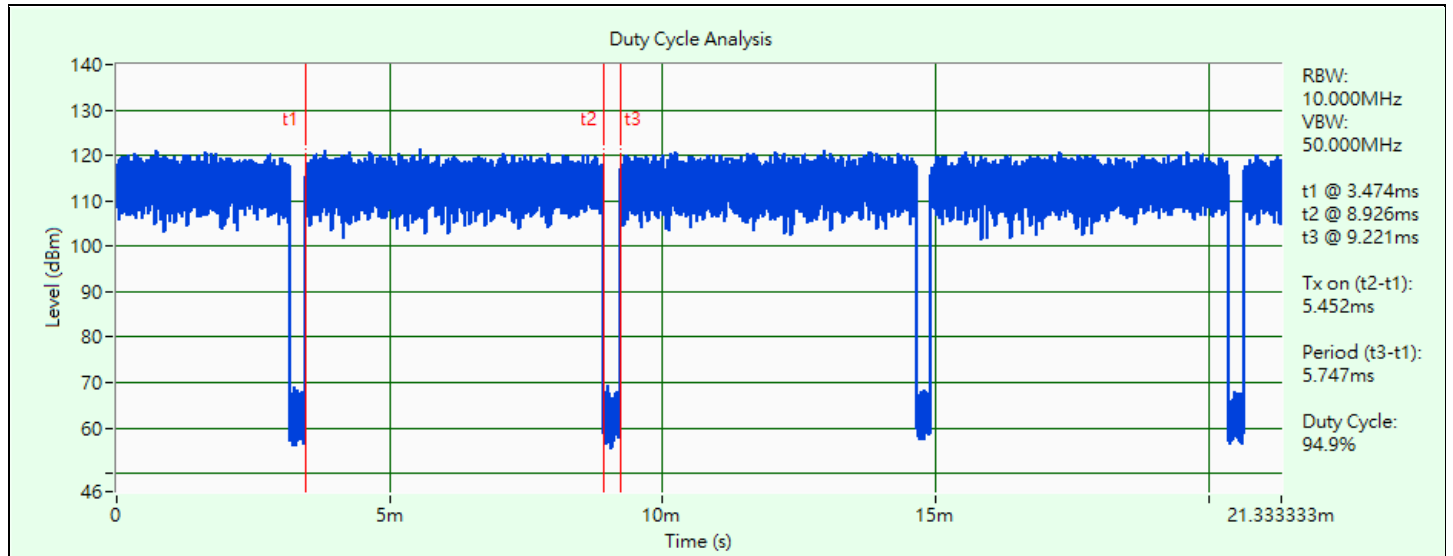

802.11a

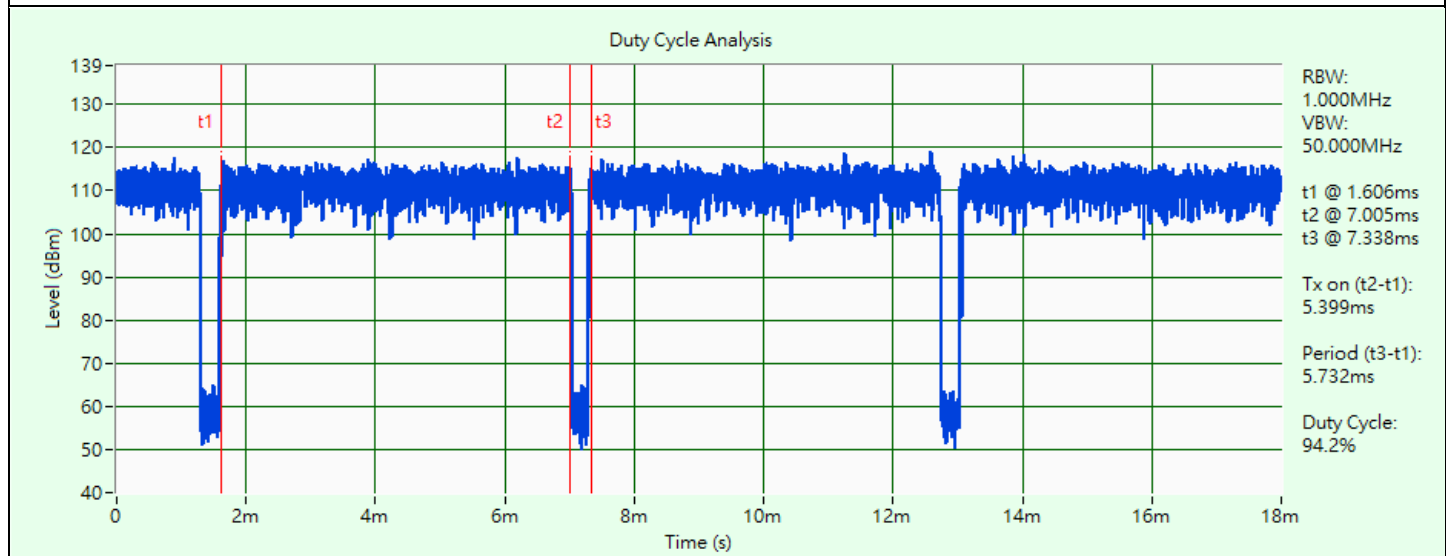

802.11ax (HE20)

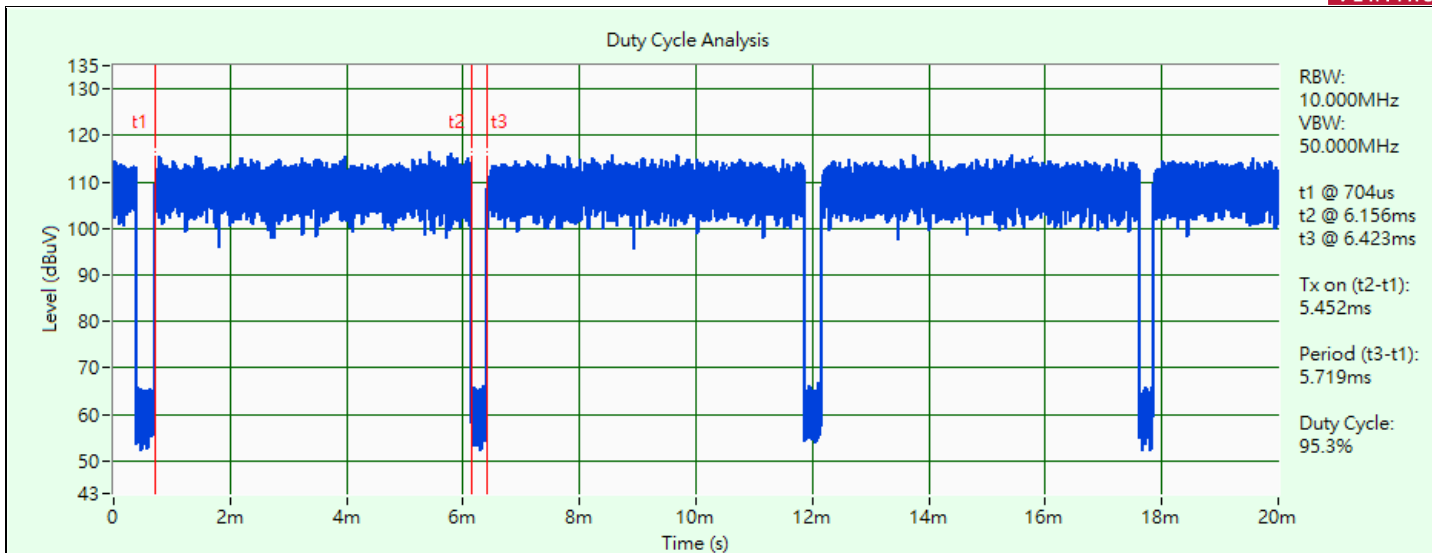

802.11ax (HE40)

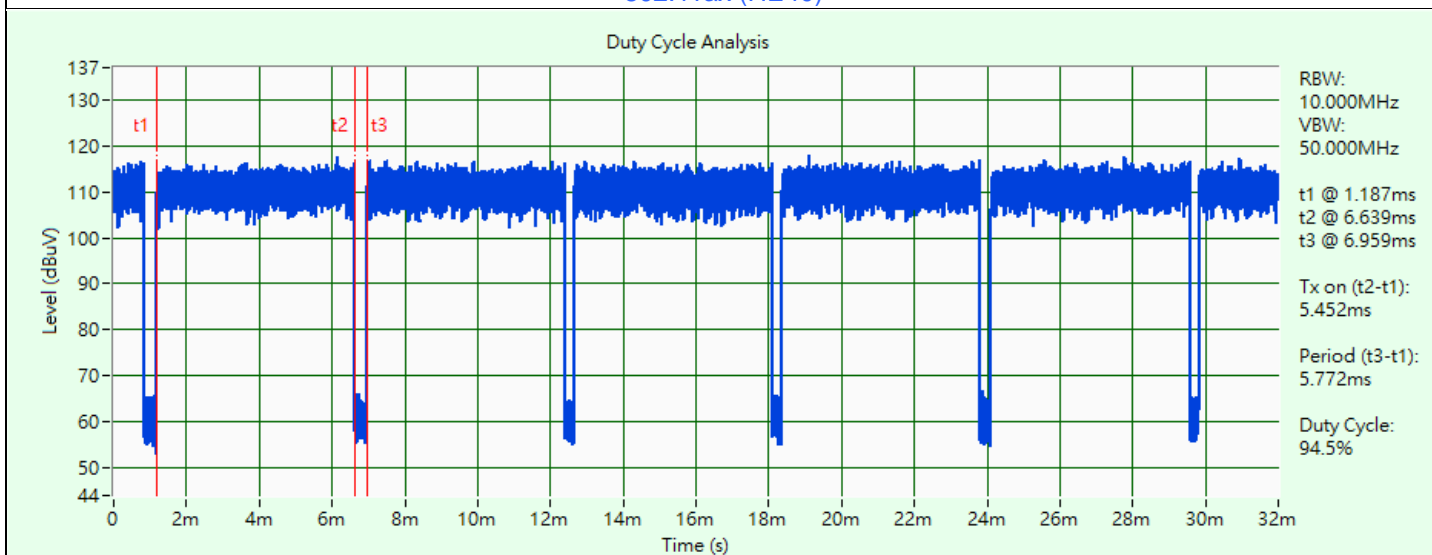

802.11ax (HE80)

3.6 Test Program Used and Operation Descriptions

Controlling software (qdart_conn.win.1.0_installer_00082.1) has been activated to set the EUT under transmission condition continuously at specific channel frequency.

3.7 Connection Diagram of EUT and Peripheral Devices

For AC Power Conducted Emission test

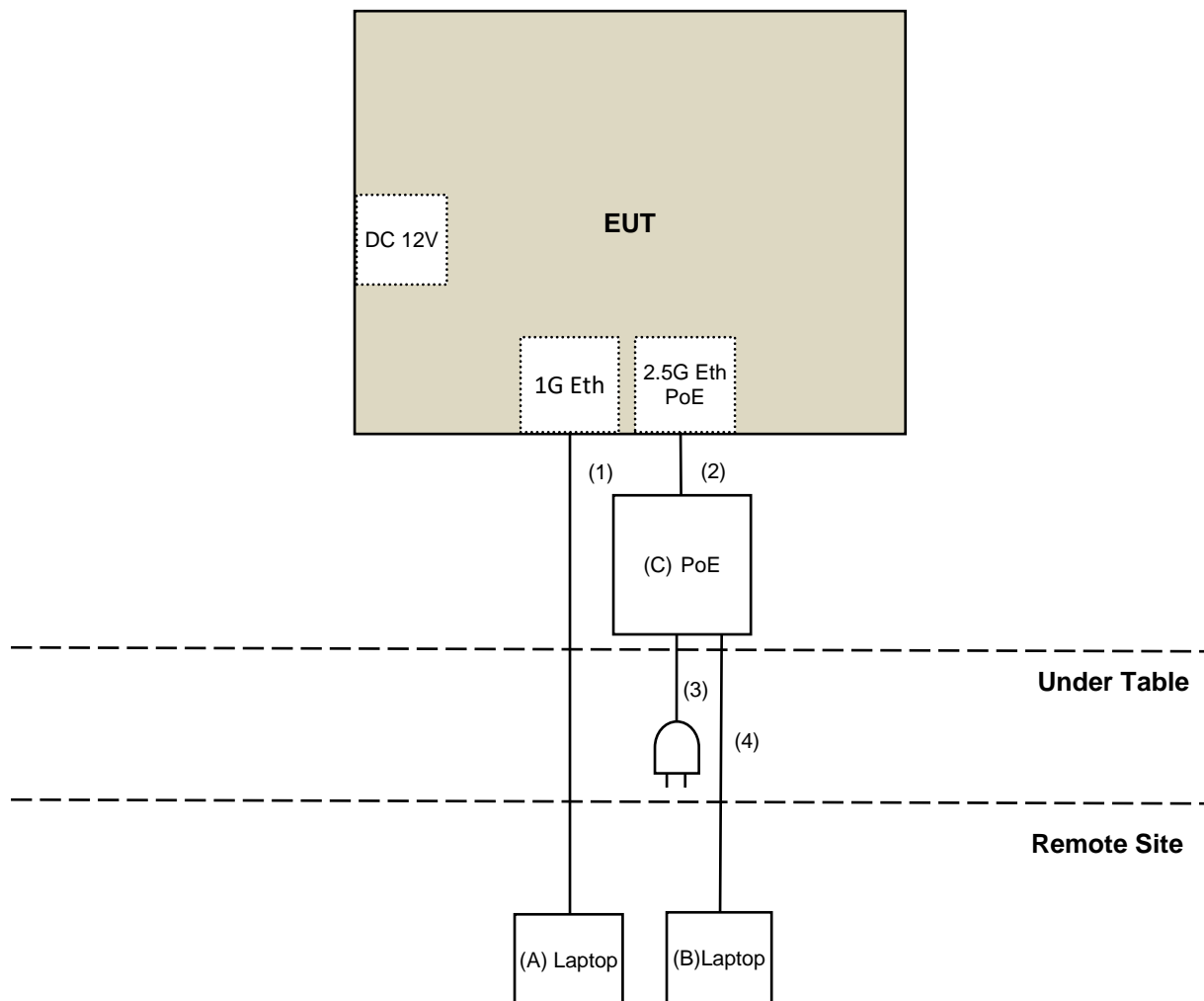

For Unwanted Emission test

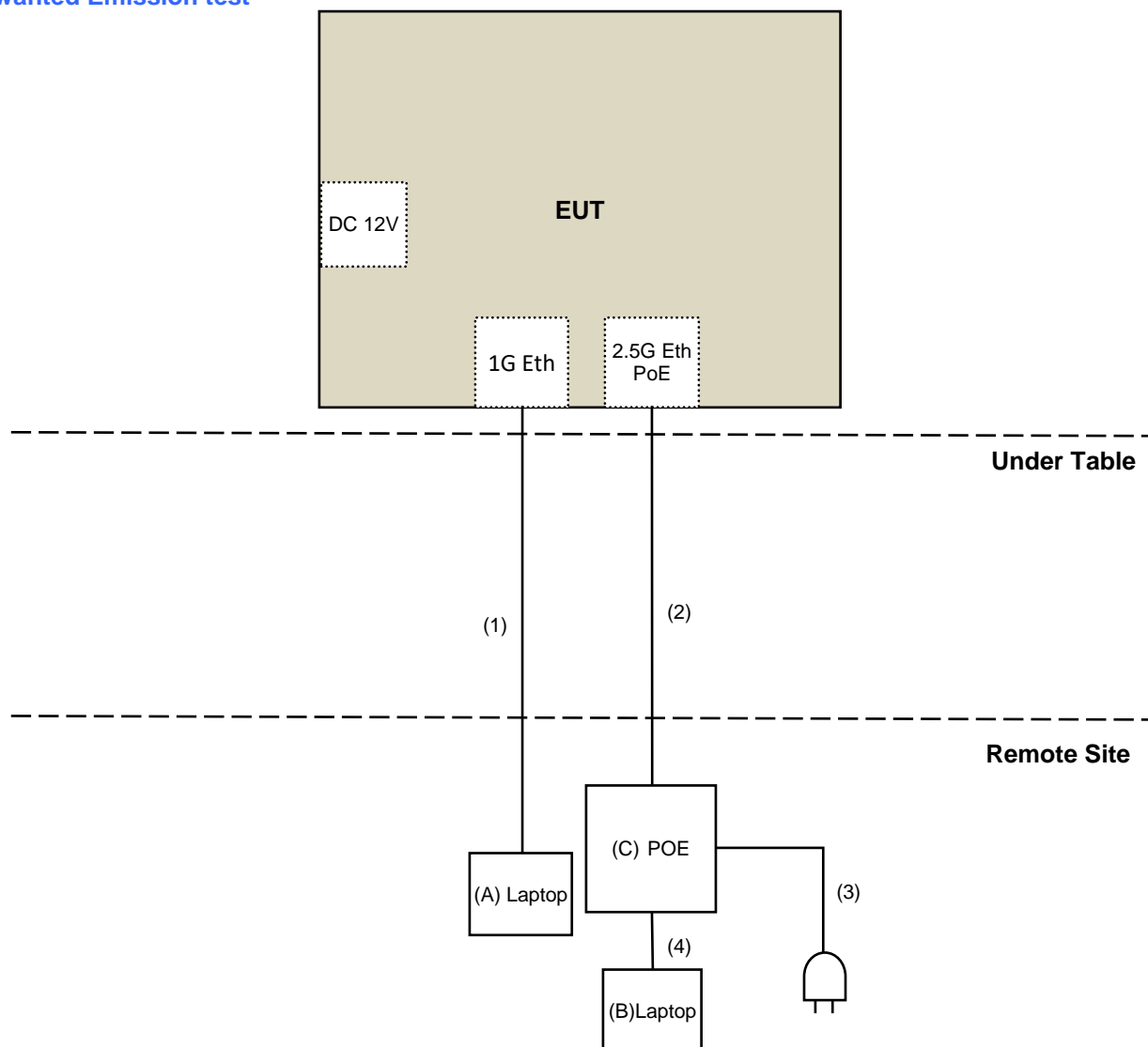

3.8 Configuration of Peripheral Devices and Cable Connections

| ID | Product | Brand | Model No. | Serial No. | FCC ID | Remarks |
|----|-------------|-------------------------|----------------|------------|--------|-----------------------|
| A | Laptop | Lenovo | 20U5S01X00 L14 | PF-28LKK7 | N/A | Supplied by applicant |
| B | Laptop | Lenovo | 20U5S01X00 L14 | PF-1ANPYA | N/A | Supplied by applicant |
| C | POE Adapter | DELTA ELECTRONICS, INC. | ADP-36PR B | N/A | N/A | Supplied by applicant |

| ID | Cable Descriptions | Qty. | Length (m) | Shielding (Yes/No) | Cores (Qty.) | Remarks |
|----|--------------------|------|------------|--------------------|--------------|-----------------|
| 1 | RJ-45 Cable | 1 | 10 | No | 0 | Provided by Lab |
| 2 | RJ-45 Cable | 1 | 1.5 | No | 0 | Provided by Lab |
| 3 | AC Cable | 1 | 1.8 | No | 0 | Provided by Lab |
| 4 | RJ-45 Cable | 1 | 10 | No | 0 | Provided by Lab |

4 Test Instruments

The calibration interval of the all test instruments are 12 months and the calibrations are traceable to NML/ROC and NIST/USA.

4.1 26 dB Bandwidth

| Description Manufacturer | Model No. | Serial No. | Calibrated Date | Calibrated Until |
|-------------------------------|----------------------------------|---------------|--------------------|---------------------|
| Attenuator WOKEN | MDCS18N-10 | MDCS18N-10-01 | 2022/4/5 | 2023/4/4 |
| Software | ADT_RF Test Software V6.6.5.4 | N/A | N/A | N/A |
| Spectrum Analyzer Keysight | N9020B | MY60112409 | 2022/3/11 | 2023/3/10 |

Notes:

1. The test was performed in Oven room 2.
2. Tested Date: 2022/10/15

4.2 RF Output Power

| Description Manufacturer | Model No. | Serial No. | Calibrated Date | Calibrated Until |
|-------------------------------|----------------------------------|---------------|--------------------|---------------------|
| Attenuator WOKEN | MDCS18N-10 | MDCS18N-10-01 | 2022/4/5 | 2023/4/4 |
| Power Meter Anritsu | ML2495A | 1529002 | 2022/6/22 | 2023/6/21 |
| Pulse Power Sensor Anritsu | MA2411B | 1726434 | 2022/6/22 | 2023/6/21 |
| Software | ADT_RF Test Software V6.6.5.4 | N/A | N/A | N/A |
| Spectrum Analyzer Keysight | N9020B | MY60112409 | 2022/3/11 | 2023/3/10 |

Notes:

1. The test was performed in Oven room 2.
2. Tested Date: 2022/10/15

4.3 Power Spectral Density

Refer to section 4.1 to get information of the instruments.

4.4 6 dB Bandwidth

Refer to section 4.1 to get information of the instruments.

4.5 Occupied Bandwidth

Refer to section 4.1 to get information of the instruments.

4.6 Frequency Stability

| Description Manufacturer | Model No. | Serial No. | Calibrated Date | Calibrated Until |
|---|----------------------------------|---------------|--------------------|---------------------|
| Attenuator WOKEN | MDCS18N-10 | MDCS18N-10-01 | 2022/4/5 | 2023/4/4 |
| DC POWER SUPPLY Topward | 6603D | 795558 | N/A | N/A |
| Software | ADT_RF Test Software V6.6.5.4 | N/A | N/A | N/A |
| Spectrum Analyzer Keysight | N9020B | MY60112409 | 2022/3/11 | 2023/3/10 |
| Temperature & Humidity Chamber Giant Force | GTH-150-40-SP-AR | MAA0812-008 | 2022/1/14 | 2023/1/13 |
| True RMS Clamp Meter Fluke | 325 | 31130711WS | 2022/6/9 | 2023/6/8 |

Notes:

1. The test was performed in Oven room 2.
2. Tested Date: 2022/10/15

4.7 AC Power Conducted Emissions

| Description Manufacturer | Model No. | Serial No. | Calibrated Date | Calibrated Until |
|-----------------------------|---------------------|------------|--------------------|---------------------|
| 50 ohm terminal resistance | N/A | EMC-01 | 2022/9/27 | 2023/9/26 |
| Fixed attenuator STI | STI02-2200-10 | 005 | 2022/8/24 | 2023/8/23 |
| LISN R&S | ESH3-Z5 | 848773/004 | 2021/10/29 | 2022/10/28 |
| RF Coaxial Cable JYEBO | 5D-FB | COCCAB-001 | 2022/8/24 | 2023/8/23 |
| Software BVADT | BVADT_Cond_V7.3.7.4 | N/A | N/A | N/A |
| TEST RECEIVER R&S | ESCS 30 | 847124/029 | 2022/10/14 | 2023/10/13 |

Notes:

1. The test was performed in Conduction 1
2. Tested Date: 2022/10/27

4.8 Unwanted Emissions below 1 GHz

| Description Manufacturer | Model No. | Serial No. | Calibrated Date | Calibrated Until |
|---|----------------------|-------------|--------------------|---------------------|
| Boresight Antenna Tower & Turn Table Max-Full | MF-7802BS | MF780208530 | N/A | N/A |
| Fixed attenuator Mini-Circuits | UNAT-5+ | PAD-ATT5-03 | 2022/1/10 | 2023/1/9 |
| LOOP ANTENNA Electro-Metrics | EM-6879 | 264 | 2022/3/18 | 2023/3/17 |
| Pre_Amplifier Agilent | 8447D | 2944A10636 | 2022/3/19 | 2023/3/18 |
| Pre_Amplifier EMCI | EMC330N | 980701 | 2022/3/8 | 2023/3/7 |
| RF Coaxial Cable COMMATE/PEWC | 8D | 966-4-1 | 2022/3/8 | 2023/3/7 |
| | | 966-4-2 | 2022/3/8 | 2023/3/7 |
| | | 966-4-3 | 2022/3/8 | 2023/3/7 |
| RF Coaxial Cable JYEBO | 5D-FB | LOOPCAB-001 | 2022/1/6 | 2023/1/5 |
| | | LOOPCAB-002 | 2022/1/6 | 2023/1/5 |
| Software | ADT_Radiated_V8.7.08 | N/A | N/A | N/A |
| Spectrum Analyzer KEYSIGHT | N9030B | MY57142938 | 2022/4/26 | 2023/4/25 |
| Trilog Broadband Antenna Schwarzbeck | VULB 9168 | 9168-406 | 2022/10/21 | 2023/10/20 |

Notes:

1. The test was performed in 966 Chamber No. 4.
2. Tested Date: 2022/10/27

4.9 Unwanted Emissions above 1 GHz

| Description Manufacturer | Model No. | Serial No. | Calibrated Date | Calibrated Until |
|---|----------------------|-------------|------------------------|------------------------|
| Boresight Antenna Tower & Turn Table Max-Full | MF-7802BS | MF780208530 | N/A | N/A |
| Horn Antenna Schwarzbeck | BBHA 9120D | 9120D-783 | 2021/11/14 | 2022/11/13 |
| | BBHA 9170 | 9170-739 | 2021/11/14 | 2022/11/13 |
| LOOP ANTENNA Electro-Metrics | EM-6879 | 264 | 2022/3/18 | 2023/3/17 |
| Pre_Amplifier Agilent | 8447D | 2944A10636 | 2022/3/19 | 2023/3/18 |
| Pre_Amplifier EMCI | EMC12630SE | 980688 | 2022/2/16 2022/10/4 | 2023/2/15 2023/10/3 |
| | EMC184045SE | 980387 | 2022/1/10 | 2023/1/9 |
| RF Cable-Frequency Range : 1- 26.5GHz EMCI | EMC104-SM-SM-1200 | 160922 | 2021/12/24 | 2022/12/23 |
| RF Cable-Frequency range: 1- 40GHz EMCI | EMC102-KM-KM-1200 | 160924 | 2022/1/10 | 2023/1/9 |
| RF Coaxial Cable EMCI | EMC-KM-KM-4000 | 200214 | 2022/3/8 | 2023/3/7 |
| | EMC104-SM-SM-2000 | 180502 | 2022/4/25 | 2023/4/24 |
| | EMC104-SM-SM-6000 | 210704 | 2021/11/9 | 2022/11/8 |
| RF Coaxial Cable JYEBO | 5D-FB | LOOPCAB-001 | 2022/1/6 | 2023/1/5 |
| | | LOOPCAB-002 | 2022/1/6 | 2023/1/5 |
| Software | ADT_Radiated_V8.7.08 | N/A | N/A | N/A |
| Spectrum Analyzer Keysight | N9020B | MY60112410 | 2022/3/13 | 2023/3/12 |
| Spectrum Analyzer KEYSIGHT | N9030B | MY57142938 | 2022/4/26 | 2023/4/25 |

Notes:

1. The test was performed in 966 Chamber No. 4.
2. Tested Date: 2022/9/13 ~ 2022/10/14

5 Limits of Test Items

5.1 26 dB Bandwidth

The results are for reference only.

5.2 RF Output Power

| Operation Band | Limit |
|----------------|------------------------------------|
| U-NII-2A | 250mW (24 dBm) or 11 dBm+10 log B* |
| U-NII-2C | 250mW (24 dBm) or 11 dBm+10 log B* |
| U-NII-3 | 1 Watt (30 dBm) |

*B is the 26 dB emission bandwidth in megahertz

Per KDB 662911 D01 Multiple Transmitter Output Method of conducted output power measurement on IEEE 802.11 devices,

Array Gain = 0 dB (i.e., no array gain) for $N_{ANT} \leq 4$;

Array Gain = 0 dB (i.e., no array gain) for channel widths ≥ 40 MHz for any N_{ANT} ;

Array Gain = $5 \log(N_{ANT}/N_{SS})$ dB or 3 dB, whichever is less, for 20-MHz channel widths with $N_{ANT} \geq 5$.

For power measurements on all other devices: Array Gain = $10 \log(N_{ANT}/N_{SS})$ dB.

5.3 Power Spectral Density

| Operation Band | Limit |
|----------------|-----------------|
| U-NII-2A | 11 dBm/ MHz |
| U-NII-2C | 11 dBm/ MHz |
| U-NII-3 | 30 dBm/ 500 kHz |

5.4 6 dB Bandwidth

Within the 5.725-5.850 GHz band, the minimum 6 dB bandwidth of U-NII devices shall be at least 500 kHz.

5.5 Occupied Bandwidth

The results are for reference only.

5.6 Frequency Stability

The frequency of the carrier signal shall be maintained within band of operation.

5.7 AC Power Conducted Emissions

| Frequency (MHz) | Conducted Limit (dBuV) | |
|-----------------|------------------------|---------|
| | Quasi-peak | Average |
| 0.15 - 0.5 | 66 - 56 | 56 - 46 |
| 0.50 - 5.0 | 56 | 46 |
| 5.0 - 30.0 | 60 | 50 |

Notes:

1. The lower limit shall apply at the transition frequencies.
2. The limit decreases in line with the logarithm of the frequency in the range of 0.15 to 0.50 MHz.

5.8 Unwanted Emissions below 1 GHz

Radiated emissions which fall in the restricted bands must comply with the radiated emission limits specified as below table.

| Frequencies (MHz) | Field Strength (microvolts/meter) | Measurement Distance (meters) |
|-------------------|-----------------------------------|-------------------------------|
| 0.009 ~ 0.490 | 2400/F(kHz) | 300 |
| 0.490 ~ 1.705 | 24000/F(kHz) | 30 |
| 1.705 ~ 30.0 | 30 | 30 |
| 30 ~ 88 | 100 | 3 |
| 88 ~ 216 | 150 | 3 |
| 216 ~ 960 | 200 | 3 |
| Above 960 | 500 | 3 |

Notes:

1. The lower limit shall apply at the transition frequencies.
2. Emission level (dBuV/m) = 20 log Emission level (uV/m).

5.9 Unwanted Emissions above 1 GHz

Radiated emissions which fall in the restricted bands must comply with the radiated emission limits specified as below table.

| Frequencies (MHz) | Field Strength (microvolts/meter) | Measurement Distance (meters) |
|-------------------|-----------------------------------|-------------------------------|
| Above 960 | 500 | 3 |

Notes:

1. The lower limit shall apply at the transition frequencies.
2. Emission level (dBuV/m) = 20 log Emission level (uV/m).
3. For frequencies above 1000 MHz, the field strength limits are based on average detector, however, the peak field strength of any emission shall not exceed the maximum permitted average limits, specified above by more than 20 dB under any condition of modulation.

Limits of unwanted emission out of the restricted bands

| Applicable To | | Limit | |
|---|-----------------|---|---|
| 789033 D02 General UNII Test Procedure New Rules v02r01 | | Field Strength at 3 m | |
| | | PK: 74 (dBµV/m) | AV: 54 (dBµV/m) |
| Frequency Band | Applicable To | EIRP Limit | Equivalent Field Strength at 3 m |
| 5150~5250 MHz | 15.407(b)(1) | PK: -27 (dBm/MHz) | PK: 68.2 (dBµV/m) |
| 5250~5350 MHz | 15.407(b)(2) | | |
| 5470~5725 MHz | 15.407(b)(3) | | |
| 5725~5850 MHz | 15.407(b)(4)(i) | PK: -27 (dBm/MHz) ^{*1} PK: 10 (dBm/MHz) ^{*2} PK: 15.6 (dBm/MHz) ^{*3} PK: 27 (dBm/MHz) ^{*4} | PK: 68.2 (dBµV/m) ^{*1} PK: 105.2 (dBµV/m) ^{*2} PK: 110.8 (dBµV/m) ^{*3} PK: 122.2 (dBµV/m) ^{*4} |
| *1 beyond 75 MHz or more above of the band edge. | | *2 below the band edge increasing linearly to 10 dBm/MHz at 25 MHz above. | |
| *3 below the band edge increasing linearly to a level of 15.6 dBm/MHz at 5 MHz above. | | *4 from 5 MHz above or below the band edge increasing linearly to a level of 27 dBm/MHz at the band edge. | |

Note: The following formula is used to convert the equipment isotropic radiated power (eirp) to field strength:

$$E = \frac{1000000\sqrt{30P}}{3} \mu\text{V/m, where } P \text{ is the eirp (Watts).}$$

6 Test Arrangements

6.1 26 dB Bandwidth

6.1.1 Test Setup

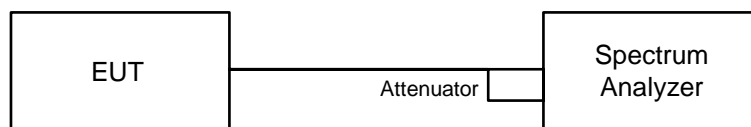

6.1.2 Test Procedure

- a. Set RBW = approximately 1% of the emission bandwidth.
- b. Set the VBW > RBW.
- c. Detector = Peak.
- d. Trace mode = max hold.
- e. Measure the maximum width of the emission that is 26 dB down from the peak of the emission. Compare this with the RBW setting of the analyzer. Readjust RBW and repeat measurement as needed until the RBW/EBW ratio is approximately 1%.

6.2 RF Output Power

6.2.1 Test Setup

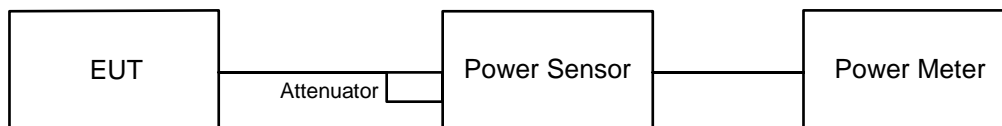

For channel straddling:

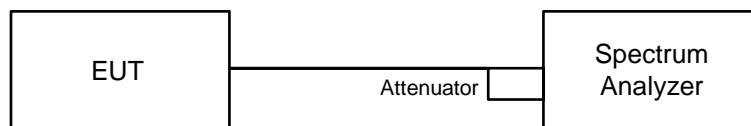

6.2.2 Test Procedure

Method PM is used to perform output power measurement, trigger and gating function of wide band power meter is enabled to measure max output power of TX on burst and set the detector to average. Duty factor is not added to measured value.

For channel straddling:

Method SA-2

- a. Set span to encompass the entire emission bandwidth (EBW) of the signal.
- b. Set RBW = 1 MHz, Set VBW \geq 3 MHz, Detector = RMS
- c. Sweep points $\geq [2 \times \text{span} / \text{RBW}]$. (This gives bin-to-bin spacing $\leq \text{RBW} / 2$, so that narrowband signals are not lost between frequency bins.) Sweep time = auto, trigger set to "free run".
- d. Trace average at least 100 traces in power averaging mode.
- e. Use the peak search function on the instrument to find the peak of the spectrum and record its value.
- f. Record the max value and add $10 \log (1/\text{duty cycle})$.

Note: When measuring straddle channel power, use compute power by integrating the spectrum across the 26 dB EBW or 99% OBW of the signal using the instrument's band power measurement function, with band limits set equal to the EBW or OBW band edges. If the instrument does not have a band power function, then sum the spectrum levels (in power units) at 1 MHz intervals extending across the 26 dB EBW or 99% OBW of the spectrum.

6.3 Power Spectral Density

6.3.1 Test Setup

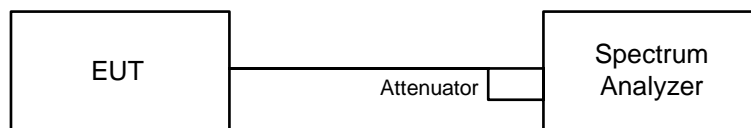

6.3.2 Test Procedure

For specified measurement bandwidth 1 MHz:

Method SA-2

- Set span to encompass the entire emission bandwidth (EBW) of the signal.
- Set RBW = 1 MHz, Set VBW \geq 3 MHz, Detector = RMS
- Sweep points \geq $[2 \times \text{span} / \text{RBW}]$. (This gives bin-to-bin spacing \leq RBW / 2, so that narrowband signals are not lost between frequency bins.)
- Sweep time = auto, trigger set to "free run".
- Trace average at least 100 traces in power averaging mode.
- Use the peak search function on the instrument to find the peak of the spectrum and record its value.
- Record the max value and add 10 log (1/duty cycle).

For specified measurement bandwidth 500 kHz:

Method SA-2

- Set span to encompass the entire emission bandwidth (EBW) of the signal.
- Set RBW = 300 kHz, Set VBW \geq 1 MHz, Detector = RMS
- Scale the observed power level to an equivalent value in 500 kHz by adjusting (increasing) the measured power by a bandwidth correction factor (BWCF) where $\text{BWCF} = 10\log(500 \text{ kHz}/300 \text{ kHz})$
- Sweep points \geq $[2 \times \text{span} / \text{RBW}]$. (This gives bin-to-bin spacing \leq RBW / 2, so that narrowband signals are not lost between frequency bins.)
- Sweep time = auto, trigger set to "free run".
- Trace average at least 100 traces in power averaging mode.
- Use the peak search function on the instrument to find the peak of the spectrum and record its value.
- Record the max value and add 10 log (1/duty cycle).

6.4 6 dB Bandwidth

6.4.1 Test Setup

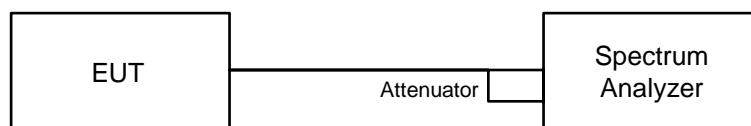

6.4.2 Test Procedure

- Set resolution bandwidth (RBW) = 100 kHz.
- Set the video bandwidth (VBW) \geq 3 x RBW, Detector = Peak.
- Trace mode = max hold.
- Sweep = auto couple.
- Measure the maximum width of the emission that is constrained by the frequencies associated with the two amplitude points (upper and lower) that are attenuated by 6 dB relative to the maximum level measured in the fundamental emission.

6.5 Occupied Bandwidth

6.5.1 Test Setup

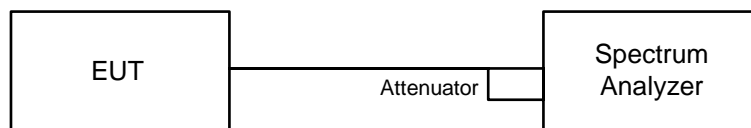

6.5.2 Test Procedure

The transmitter output was connected to the spectrum analyzer through an attenuator. The bandwidth of the fundamental frequency was measured by spectrum analyzer with resolution bandwidth in the range of 1% to 5% of the anticipated emission bandwidth, and a video bandwidth at least 3x the resolution bandwidth and set the detector to Sampling. The width of a frequency band such that, below the lower and above the upper frequency limits, the mean powers emitted are each equal to a specified percentage 0.5% of the total mean power of a given emission.

6.6 Frequency Stability

6.6.1 Test Setup

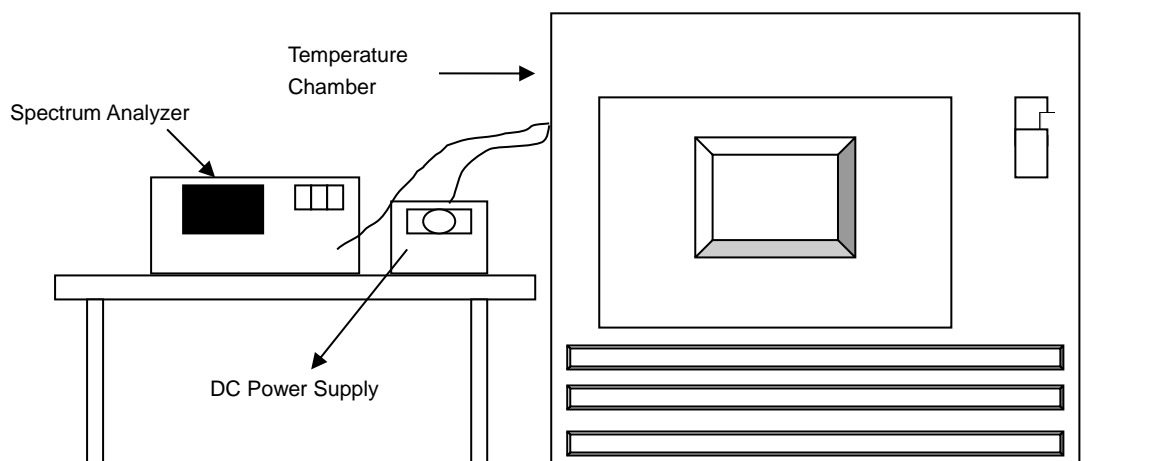
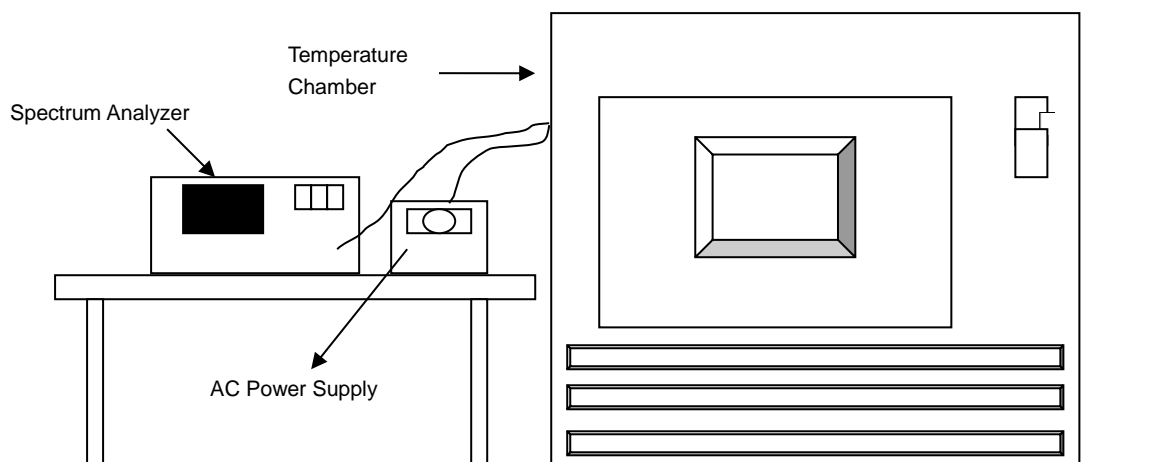

6.6.2 Test Procedure

- The EUT was placed inside the environmental test chamber and powered by nominal AC voltage.
- The EUT was placed inside the environmental test chamber and powered by nominal DC voltage.
- Turn the EUT on and couple its output to a spectrum analyzer.
- Turn the EUT off and set the chamber to the highest temperature specified.
- Allow sufficient time (approximately 30 min) for the temperature of the chamber to stabilize, turn the EUT on and measure the operating frequency after 2, 5, and 10 Minutes.
- Repeat step (d) with the temperature chamber set to the next desired temperature until measurements down to the lowest specified temperature have been completed.
- The test chamber was allowed to stabilize at +20 degree C for a minimum of 30 Minutes. The supply voltage was then adjusted on the EUT from 85% to 115% and the frequency record.

6.7 AC Power Conducted Emissions

6.7.1 Test Setup

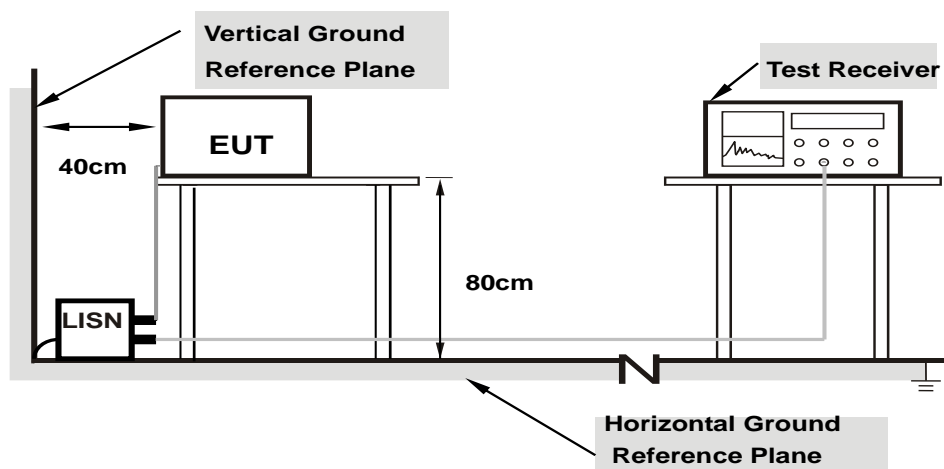

Note: 1.Support units were connected to second LISN.

For the actual test configuration, please refer to the attached file (Test Setup Photo).

6.7.2 Test Procedure

- The EUT was placed on a 0.8 meter to the top of table and placed 0.4 meters from the conducting wall of the shielded room with EUT being connected to the power mains through a line impedance stabilization network (LISN). Other support units were connected to the power mains through another LISN. The two LISNs provide 50 ohm/ 50 uH of coupling impedance for the measuring instrument.
- Both lines of the power mains connected to the EUT were checked for maximum conducted interference.
- The frequency range from 150 kHz to 30 MHz was searched. Emission levels under (Limit – 20 dB) was not recorded.

Note: The resolution bandwidth and video bandwidth of test receiver is 9 kHz for quasi-peak detection (QP) and average detection (AV) at frequency 0.15 MHz-30 MHz.

6.8 Unwanted Emissions below 1 GHz

6.8.1 Test Setup

For Radiated emission below 30 MHz

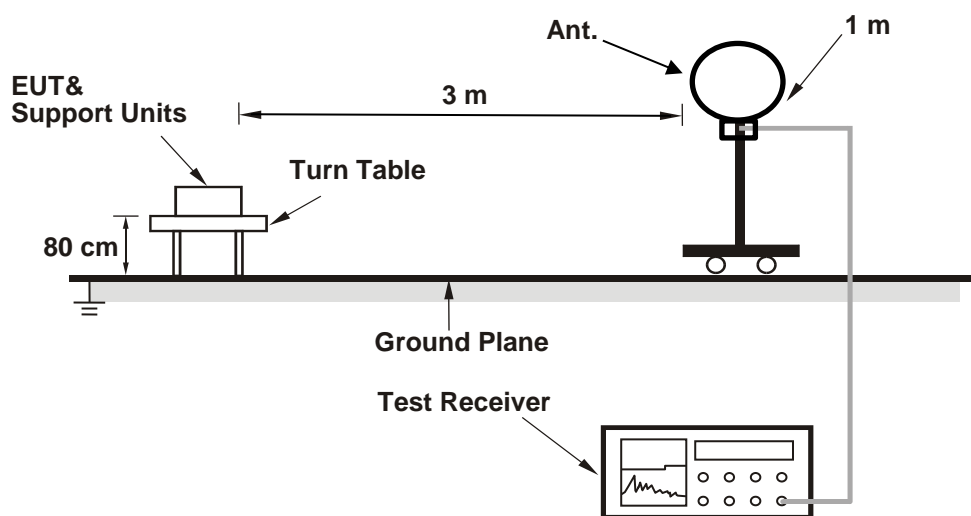

For Radiated emission above 30 MHz

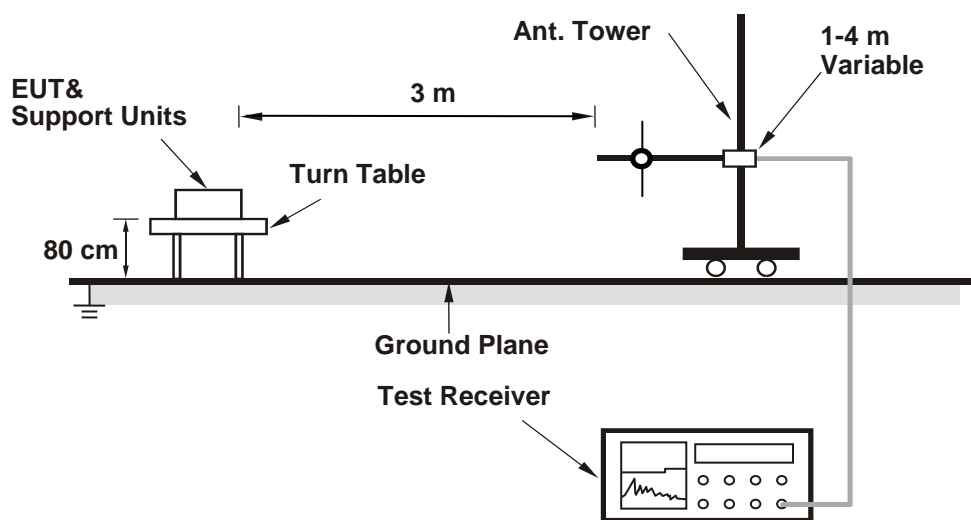

For the actual test configuration, please refer to the attached file (Test Setup Photo).

6.8.2 Test Procedure

For Radiated emission below 30 MHz

- a. The EUT was placed on the top of a rotating table 0.8 meters above the ground at 3 meter chamber room for test. The table was rotated 360 degrees to determine the position of the highest radiation.
- b. The EUT was set 3 meters away from the interference-receiving antenna, which was mounted on the top of a variable-height antenna tower.
- c. Parallel, perpendicular, and ground-parallel orientations of the antenna are set to make the measurement.
- d. For each suspected emission, the EUT was arranged to its worst case and the rotatable table was turned from 0 degrees to 360 degrees to find the maximum reading.
- e. The test-receiver system was set to Quasi-Peak Detect Function and Specified Bandwidth with Maximum Hold Mode, except for the frequency band (9 kHz to 90 kHz and 110 kHz to 490 kHz) set to average detect function and peak detect function.

Notes:

1. The resolution bandwidth and video bandwidth of test receiver/spectrum analyzer is 200 Hz at frequency below 150 kHz.
2. The resolution bandwidth and video bandwidth of test receiver/spectrum analyzer is 9 kHz or 10 kHz at frequency (150 kHz to 30 MHz).
3. All modes of operation were investigated and the worst-case emissions are reported.

For Radiated emission above 30 MHz

- a. The EUT was placed on the top of a rotating table 0.8 meters above the ground at 3 meter chamber room for test. The table was rotated 360 degrees to determine the position of the highest radiation.
- b. The EUT was set 3 meters away from the interference-receiving antenna, which was mounted on the top of a variable-height antenna tower.
- c. The height of antenna is varied from one meter to four meters above the ground to determine the maximum value of the field strength. Both horizontal and vertical polarizations of the antenna are set to make the measurement.
- d. For each suspected emission, the EUT was arranged to its worst case and then the antenna was tuned to heights from 1 meter to 4 meters and the rotatable table was turned from 0 degrees to 360 degrees to find the maximum reading.
- e. The test-receiver system was set to quasi-peak detect function and specified bandwidth with maximum hold mode when the test frequency is below 1 GHz.

Notes:

1. The resolution bandwidth and video bandwidth of test receiver/spectrum analyzer is 120 kHz for Quasi-peak detection (QP) at frequency below 1 GHz.
2. All modes of operation were investigated and the worst-case emissions are reported.

6.9 Unwanted Emissions above 1 GHz

6.9.1 Test Setup

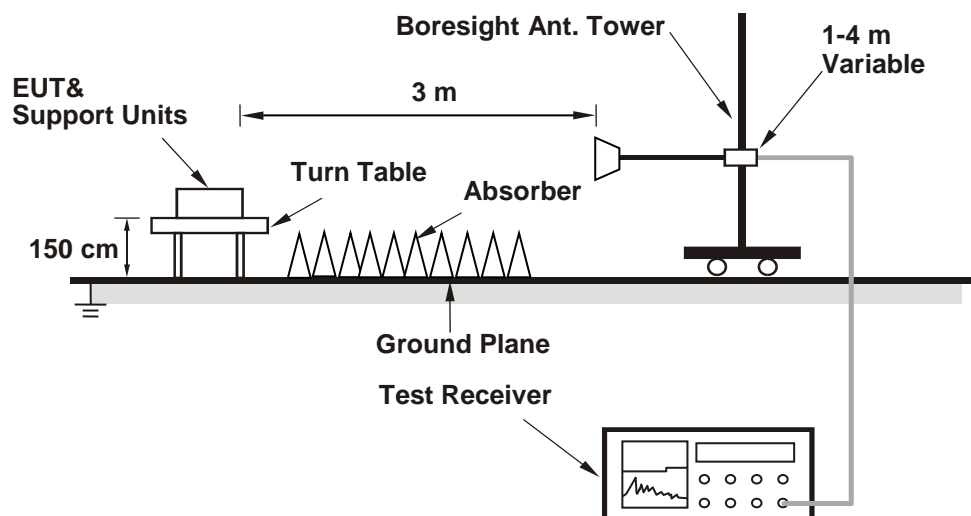

For the actual test configuration, please refer to the attached file (Test Setup Photo).

6.9.2 Test Procedure

- The EUT was placed on the top of a rotating table 1.5 meters above the ground at 3 meter chamber room for test. The table was rotated 360 degrees to determine the position of the highest radiation.
- The EUT was set 3 meters away from the interference-receiving antenna, which was mounted on the top of a variable-height antenna tower.
- The height of antenna is varied from one meter to four meters above the ground to determine the maximum value of the field strength. Both horizontal and vertical polarizations of the antenna are set to make the measurement.
- For each suspected emission, the EUT was arranged to its worst case and then the antenna was tuned to heights from 1 meter to 4 meters and the rotatable table was turned from 0 degrees to 360 degrees to find the maximum reading.
- The test-receiver system was set to peak and average detects function and specified bandwidth with maximum hold mode when the test frequency is above 1 GHz. If the peak reading value also meets average limit, measurement with the average detector is unnecessary.

Notes:

- The resolution bandwidth of test receiver/spectrum analyzer is 1 MHz and the video bandwidth is 3 MHz for Peak detection (PK) and Average detection (AV) at frequency above 1 GHz.
- For fundamental and harmonic signal measurement, the resolution bandwidth of test receiver/spectrum analyzer is 1 MHz and the video bandwidth is $\geq 1/T$ (Duty cycle < 98%) or 10 Hz (Duty cycle $\geq 98\%$) for Average detection (AV) at frequency above 1 GHz.
- All modes of operation were investigated and the worst-case emissions are reported.

7 Test Results of Test Item

7.1 26 dB Bandwidth

| | | | | | |
|--------------|--------|---------------------------|--------------|------------|-----------|
| Input Power: | 12 Vdc | Environmental Conditions: | 25°C, 60% RH | Tested By: | John Peng |
|--------------|--------|---------------------------|--------------|------------|-----------|

802.11a

| Channel | Frequency (MHz) | 26 dB Bandwidth (MHz) | | | |
|----------------|-----------------|-----------------------|---------|---------|---------|
| | | Chain 0 | Chain 1 | Chain 2 | Chain 3 |
| 52 | 5260 | 19.62 | 19.92 | 19.67 | 19.45 |
| 60 | 5300 | 19.15 | 19.81 | 18.84 | 19.15 |
| 64 | 5320 | 19.79 | 19.06 | 19.06 | 19.39 |
| 100 | 5500 | 19.45 | 19.48 | 19.72 | 19.06 |
| 116 | 5580 | 19.41 | 19.17 | 19.35 | 19.38 |
| 140 | 5700 | 18.93 | 19.00 | 19.54 | 19.28 |
| 144 (U-NII-2C) | 5720 | 14.65 | 14.43 | 14.80 | 14.84 |
| 144 (U-NII-3) | 5720 | 4.55 | 4.59 | 4.39 | 4.41 |

| Determined Output Power Limit | | | |
|-------------------------------|------------|-------------|--|
| Channel Number | Freq.(MHz) | Min. B(MHz) | Determined Conducted Power Limit (dBm) |
| 52 | 5260 | 19.45 | 23.88 < 24 |
| 60 | 5300 | 18.84 | 23.75 < 24 |
| 64 | 5320 | 19.06 | 23.8 < 24 |
| 100 | 5500 | 19.06 | 23.8 < 24 |
| 116 | 5580 | 19.17 | 23.82 < 24 |
| 140 | 5700 | 18.93 | 23.77 < 24 |
| 144 (U-NII-2C) | 5720 | 14.43 | 22.59 < 24 |

Note: For U-NII-2A, U-NII-2C Band output power limitation is determined based on 26dBc bandwidth.

802.11ax (HE20)

| Channel | Frequency (MHz) | 26 dB Bandwidth (MHz) | | | |
|----------------|-----------------|-----------------------|---------|---------|---------|
| | | Chain 0 | Chain 1 | Chain 2 | Chain 3 |
| 52 | 5260 | 21.40 | 20.92 | 21.21 | 20.63 |
| 60 | 5300 | 20.73 | 20.86 | 20.96 | 20.74 |
| 64 | 5320 | 21.31 | 20.75 | 21.37 | 20.72 |
| 100 | 5500 | 21.16 | 21.47 | 20.88 | 20.91 |
| 116 | 5580 | 20.80 | 20.94 | 21.37 | 20.82 |
| 140 | 5700 | 21.17 | 21.39 | 21.09 | 21.12 |
| 144 (U-NII-2C) | 5720 | 15.52 | 15.73 | 15.19 | 15.29 |
| 144 (U-NII-3) | 5720 | 5.39 | 5.89 | 5.36 | 5.46 |

| Determined Output Power Limit | | | |
|-------------------------------|------------|-------------|--|
| Channel Number | Freq.(MHz) | Min. B(MHz) | Determined Conducted Power Limit (dBm) |
| 52 | 5260 | 20.63 | 24.14 > 24 |
| 60 | 5300 | 20.73 | 24.16 > 24 |
| 64 | 5320 | 20.72 | 24.16 > 24 |
| 100 | 5500 | 20.88 | 24.19 > 24 |
| 116 | 5580 | 20.80 | 24.18 > 24 |
| 140 | 5700 | 21.09 | 24.24 > 24 |
| 144 (U-NII-2C) | 5720 | 15.19 | 22.81 < 24 |

Note: For U-NII-2A, U-NII-2C Band output power limitation is determined based on 26dBc bandwidth.

802.11ax (HE40)

| Channel | Frequency (MHz) | 26 dB Bandwidth (MHz) | | | |
|----------------|-----------------|-----------------------|---------|---------|---------|
| | | Chain 0 | Chain 1 | Chain 2 | Chain 3 |
| 54 | 5270 | 41.62 | 41.67 | 41.40 | 41.95 |
| 62 | 5310 | 41.35 | 41.91 | 41.73 | 41.40 |
| 102 | 5510 | 41.96 | 41.75 | 41.53 | 41.50 |
| 110 | 5550 | 42.09 | 42.12 | 41.51 | 41.53 |
| 134 | 5670 | 41.31 | 40.87 | 41.48 | 41.41 |
| 142 (U-NII-2C) | 5710 | 35.92 | 35.43 | 35.81 | 35.35 |
| 142 (U-NII-3) | 5710 | 6.01 | 5.02 | 5.47 | 5.28 |

| Determined Output Power Limit | | | |
|-------------------------------|------------|-------------|--|
| Channel Number | Freq.(MHz) | Min. B(MHz) | Determined Conducted Power Limit (dBm) |
| 54 | 5270 | 41.40 | 27.17 > 24 |
| 62 | 5310 | 41.35 | 27.16 > 24 |
| 102 | 5510 | 41.50 | 27.18 > 24 |
| 110 | 5550 | 41.51 | 27.18 > 24 |
| 134 | 5670 | 40.87 | 27.11 > 24 |
| 142 (U-NII-2C) | 5710 | 35.35 | 26.48 > 24 |

Note: For U-NII-2A, U-NII-2C Band output power limitation is determined based on 26dBc bandwidth.

802.11ax (HE80)

| Channel | Frequency (MHz) | 26 dB Bandwidth (MHz) | | | |
|----------------|-----------------|-----------------------|---------|---------|---------|
| | | Chain 0 | Chain 1 | Chain 2 | Chain 3 |
| 58 | 5290 | 82.18 | 81.97 | 82.03 | 82.14 |
| 106 | 5530 | 82.35 | 82.66 | 82.47 | 82.05 |
| 122 | 5610 | 82.01 | 81.90 | 81.70 | 82.15 |
| 138 (U-NII-2C) | 5690 | 75.40 | 75.43 | 76.00 | 75.43 |
| 138 (U-NII-3) | 5690 | 5.43 | 5.21 | 5.94 | 5.49 |

| Determined Output Power Limit | | | |
|-------------------------------|------------|-------------|--|
| Channel Number | Freq.(MHz) | Min. B(MHz) | Determined Conducted Power Limit (dBm) |
| 58 | 5290 | 81.97 | 30.13 > 24 |
| 106 | 5530 | 82.05 | 30.14 > 24 |
| 122 | 5610 | 81.70 | 30.12 > 24 |
| 138 (U-NII-2C) | 5690 | 75.40 | 29.77 > 24 |

Note: For U-NII-2A, U-NII-2C Band output power limitation is determined based on 26dBc bandwidth.

Spectrum Plot of Minimum Value

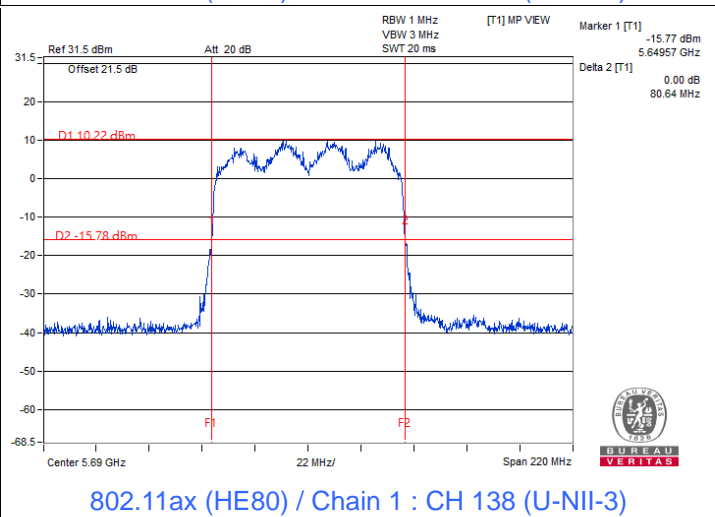
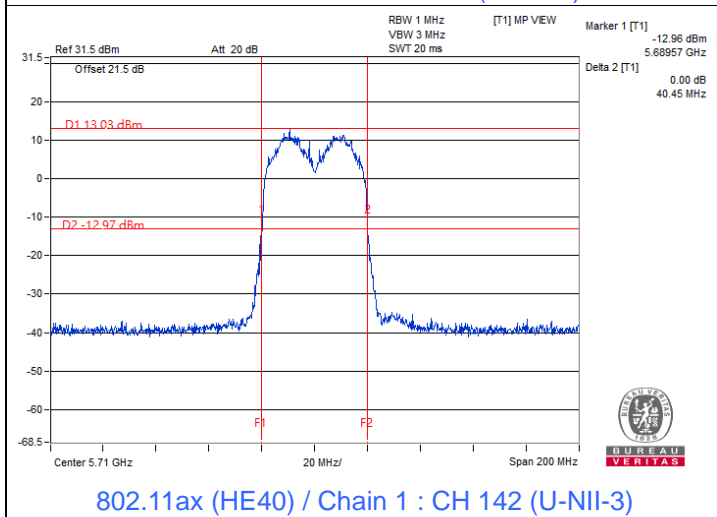
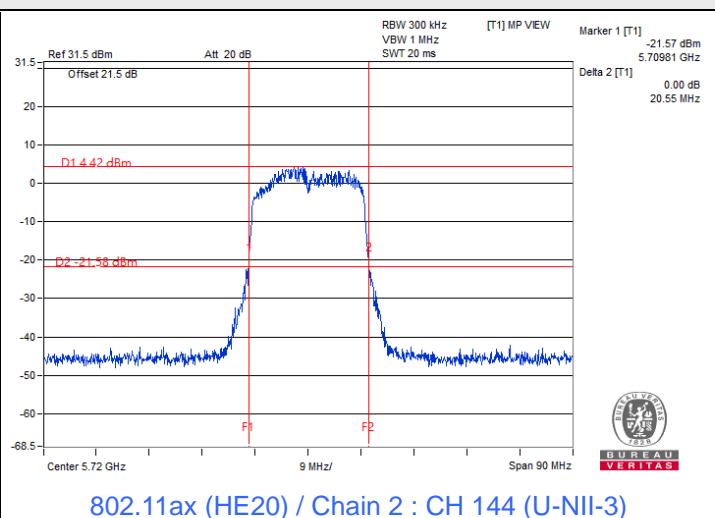
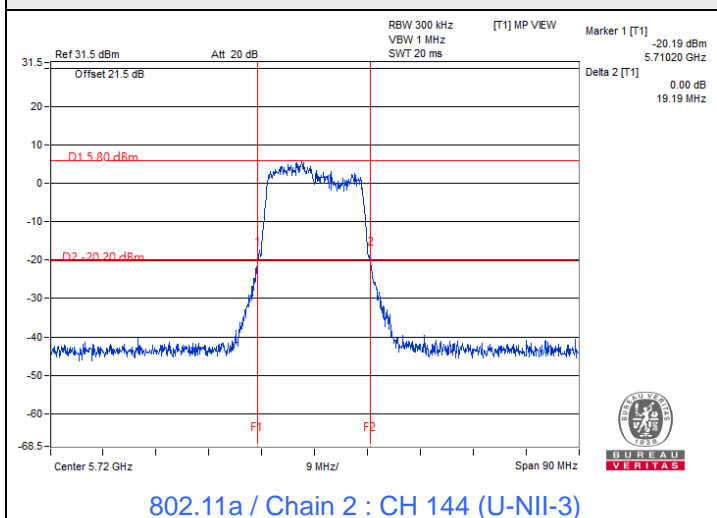

Notes:

1. For U-NII-2C straddle channel = 5725 MHz - Marker 1
2. For U-NII-3 straddle channel = Marker 1 + Delta 2 - 5725 MHz

7.2 RF Output Power

| | | | | | |
|--------------|--------|---------------------------|--------------|------------|-----------|
| Input Power: | 12 Vdc | Environmental Conditions: | 25°C, 60% RH | Tested By: | John Peng |
|--------------|--------|---------------------------|--------------|------------|-----------|

802.11a CDD

| Chan. | Chan. Freq. (MHz) | Average Power (dBm) | | | | Total Power (mW) | Total Power (dBm) | Power Limit (dBm) | Test Result |
|-----------------|-------------------|---------------------|---------|---------|---------|------------------|-------------------|-------------------|-------------|
| | | Chain 0 | Chain 1 | Chain 2 | Chain 3 | | | | |
| 52 | 5260 | 12.96 | 13.21 | 13.06 | 13.01 | 80.94 | 19.08 | 23.88 | Pass |
| 60 | 5300 | 12.44 | 12.48 | 12.82 | 12.71 | 73.046 | 18.64 | 23.75 | Pass |
| 64 | 5320 | 12.47 | 12.16 | 12.86 | 12.45 | 71.003 | 18.51 | 23.8 | Pass |
| 100 | 5500 | 12.83 | 12.46 | 12.47 | 12.46 | 72.087 | 18.58 | 23.8 | Pass |
| 116 | 5580 | 12.52 | 13.01 | 13.25 | 13.48 | 81.283 | 19.10 | 23.82 | Pass |
| 140 | 5700 | 12.62 | 13.30 | 12.79 | 12.67 | 77.164 | 18.87 | 23.77 | Pass |
| *144 (U-NII-2C) | 5720 | 12.41 | 11.85 | 12.55 | 12.14 | 70.716 | 18.50 | 22.59 | Pass |
| *144 (U-NII-3) | 5720 | 7.65 | 6.55 | 4.37 | 5.93 | 17.912 | 12.53 | 30 | Pass |

Notes:

- * : Test was performed in accordance with measurement follow FCC KDB 789033 UNII test procedure Method SA-2 and use spectrum analyzer test , the duty factor was included in the total power.
- Directional gain is the maximum gain of antennas.
- For U-NII-2A, the directional gain is 5.4 dBi < 6 dBi, so the output power limit shall not be reduced.
- For U-NII-2C, the directional gain is 5.4 dBi < 6 dBi, so the output power limit shall not be reduced.
- For U-NII-3, the directional gain is 5.4 dBi < 6 dBi, so the output power limit shall not be reduced.

802.11ac (VHT20) CDD

| Chan. | Chan. Freq. (MHz) | Average Power (dBm) | | | | Total Power (mW) | Total Power (dBm) | Power Limit (dBm) | Test Result |
|-----------------|-------------------|---------------------|---------|---------|---------|------------------|-------------------|-------------------|-------------|
| | | Chain 0 | Chain 1 | Chain 2 | Chain 3 | | | | |
| 52 | 5260 | 12.06 | 12.74 | 12.93 | 13.02 | 74.541 | 18.72 | 24 | Pass |
| 60 | 5300 | 12.27 | 12.61 | 12.73 | 12.71 | 72.518 | 18.60 | 24 | Pass |
| 64 | 5320 | 12.88 | 12.57 | 12.54 | 12.84 | 74.659 | 18.73 | 24 | Pass |
| 100 | 5500 | 12.64 | 12.36 | 12.89 | 12.72 | 73.744 | 18.68 | 24 | Pass |
| 116 | 5580 | 12.21 | 12.72 | 12.77 | 13.10 | 74.682 | 18.73 | 24 | Pass |
| 140 | 5700 | 12.10 | 12.92 | 12.78 | 12.38 | 72.072 | 18.58 | 24 | Pass |
| *144 (U-NII-2C) | 5720 | 11.40 | 11.86 | 11.77 | 11.36 | 61.427 | 17.88 | 22.81 | Pass |
| *144 (U-NII-3) | 5720 | 8.28 | 8.35 | 6.03 | 5.26 | 22.226 | 13.47 | 30 | Pass |

Notes:

- * : Test was performed in accordance with measurement follow FCC KDB 789033 UNII test procedure Method SA-2 and use spectrum analyzer test , the duty factor was included in the total power.
- Directional gain is the maximum gain of antennas.
- For U-NII-2A, the directional gain is 5.4 dBi < 6 dBi, so the output power limit shall not be reduced.
- For U-NII-2C, the directional gain is 5.4 dBi < 6 dBi, so the output power limit shall not be reduced.
- For U-NII-3, the directional gain is 5.4 dBi < 6 dBi, so the output power limit shall not be reduced.

802.11ac (VHT40) CDD

| Chan. | Chan. Freq. (MHz) | Average Power (dBm) | | | | Total Power (mW) | Total Power (dBm) | Power Limit (dBm) | Test Result |
|-----------------|-------------------|---------------------|---------|---------|---------|------------------|-------------------|-------------------|-------------|
| | | Chain 0 | Chain 1 | Chain 2 | Chain 3 | | | | |
| 54 | 5270 | 15.58 | 16.17 | 16.08 | 16.07 | 158.549 | 22.00 | 24 | Pass |
| 62 | 5310 | 15.26 | 15.69 | 15.81 | 15.77 | 146.506 | 21.66 | 24 | Pass |
| 102 | 5510 | 15.78 | 15.67 | 15.70 | 15.63 | 148.455 | 21.72 | 24 | Pass |
| 110 | 5550 | 15.10 | 15.42 | 15.58 | 15.66 | 140.147 | 21.47 | 24 | Pass |
| 134 | 5670 | 16.24 | 16.46 | 15.91 | 15.68 | 162.309 | 22.10 | 24 | Pass |
| *142 (U-NII-2C) | 5710 | 15.87 | 15.68 | 15.77 | 15.05 | 152.485 | 21.83 | 24 | Pass |
| *142 (U-NII-3) | 5710 | 6.07 | 2.56 | 3.32 | 4.89 | 11.622 | 10.65 | 30 | Pass |

Notes:

- * : Test was performed in accordance with measurement follow FCC KDB 789033 UNII test procedure Method SA-2 and use spectrum analyzer test , the duty factor was included in the total power.
- Directional gain is the maximum gain of antennas.
- For U-NII-2A, the maximum gain is 5.4 dBi < 6 dBi, so the output power limit shall not be reduced.
- For U-NII-2C, the maximum gain is 5.4 dBi < 6 dBi, so the output power limit shall not be reduced.
- For U-NII-3, the maximum gain is 5.4 dBi < 6 dBi, so the output power limit shall not be reduced.

802.11ac (VHT80) CDD

| Chan. | Chan. Freq. (MHz) | Average Power (dBm) | | | | Total Power (mW) | Total Power (dBm) | Power Limit (dBm) | Test Result |
|-----------------|-------------------|---------------------|---------|---------|---------|------------------|-------------------|-------------------|-------------|
| | | Chain 0 | Chain 1 | Chain 2 | Chain 3 | | | | |
| 58 | 5290 | 15.53 | 16.25 | 16.20 | 16.13 | 160.604 | 22.06 | 24 | Pass |
| 106 | 5530 | 16.73 | 17.08 | 17.07 | 17.39 | 203.909 | 23.09 | 24 | Pass |
| 122 | 5610 | 17.48 | 17.71 | 17.90 | 17.27 | 229.989 | 23.62 | 24 | Pass |
| *138 (U-NII-2C) | 5690 | 15.86 | 16.67 | 16.06 | 16.31 | 177.988 | 22.50 | 24 | Pass |
| *138 (U-NII-3) | 5690 | 3.10 | 0.81 | -0.10 | 3.13 | 6.6485 | 8.23 | 30 | Pass |

Notes:

- * : Test was performed in accordance with measurement follow FCC KDB 789033 UNII test procedure Method SA-2 and use spectrum analyzer test , the duty factor was included in the total power.
- Directional gain is the maximum gain of antennas.
- For U-NII-2A, the maximum gain is 5.4 dBi < 6 dBi, so the output power limit shall not be reduced.
- For U-NII-2C, the maximum gain is 5.4 dBi < 6 dBi, so the output power limit shall not be reduced.
- For U-NII-3, the maximum gain is 5.4 dBi < 6 dBi, so the output power limit shall not be reduced.

802.11ax (HE20) CDD

| Chan. | Chan. Freq. (MHz) | Average Power (dBm) | | | | Total Power (mW) | Total Power (dBm) | Power Limit (dBm) | Test Result |
|-----------------|-------------------|---------------------|---------|---------|---------|------------------|-------------------|-------------------|-------------|
| | | Chain 0 | Chain 1 | Chain 2 | Chain 3 | | | | |
| 52 | 5260 | 12.26 | 13.02 | 13.14 | 13.23 | 78.516 | 18.95 | 24 | Pass |
| 60 | 5300 | 12.51 | 12.87 | 12.97 | 12.96 | 76.773 | 18.85 | 24 | Pass |
| 64 | 5320 | 13.11 | 12.85 | 12.82 | 13.04 | 79.019 | 18.98 | 24 | Pass |
| 100 | 5500 | 12.92 | 12.63 | 13.13 | 12.95 | 78.195 | 18.93 | 24 | Pass |
| 116 | 5580 | 12.50 | 12.97 | 12.98 | 13.37 | 79.186 | 18.99 | 24 | Pass |
| 140 | 5700 | 12.39 | 13.20 | 13.05 | 12.62 | 76.696 | 18.85 | 24 | Pass |
| *144 (U-NII-2C) | 5720 | 11.40 | 11.86 | 11.77 | 11.36 | 61.427 | 17.88 | 22.81 | Pass |
| *144 (U-NII-3) | 5720 | 8.28 | 8.35 | 6.03 | 5.26 | 22.226 | 13.47 | 30 | Pass |

Notes:

- * : Test was performed in accordance with measurement follow FCC KDB 789033 UNII test procedure Method SA-2 and use spectrum analyzer test , the duty factor was included in the total power.
- Directional gain is the maximum gain of antennas.
- For U-NII-2A, the directional gain is 5.4 dBi < 6 dBi, so the output power limit shall not be reduced.
- For U-NII-2C, the directional gain is 5.4 dBi < 6 dBi, so the output power limit shall not be reduced.
- For U-NII-3, the directional gain is 5.4 dBi < 6 dBi, so the output power limit shall not be reduced.

802.11ax (HE40) CDD

| Chan. | Chan. Freq. (MHz) | Average Power (dBm) | | | | Total Power (mW) | Total Power (dBm) | Power Limit (dBm) | Test Result |
|-----------------|-------------------|---------------------|---------|---------|---------|------------------|-------------------|-------------------|-------------|
| | | Chain 0 | Chain 1 | Chain 2 | Chain 3 | | | | |
| 54 | 5270 | 15.82 | 16.40 | 16.34 | 16.29 | 167.459 | 22.24 | 24 | Pass |
| 62 | 5310 | 15.54 | 15.98 | 16.04 | 15.99 | 155.336 | 21.91 | 24 | Pass |
| 102 | 5510 | 15.99 | 15.94 | 15.93 | 15.91 | 157.152 | 21.96 | 24 | Pass |
| 110 | 5550 | 15.36 | 15.65 | 15.84 | 15.93 | 148.629 | 21.72 | 24 | Pass |
| 134 | 5670 | 16.52 | 16.72 | 16.20 | 15.97 | 173.088 | 22.38 | 24 | Pass |
| *142 (U-NII-2C) | 5710 | 15.87 | 15.68 | 15.77 | 15.05 | 152.485 | 21.83 | 24 | Pass |
| *142 (U-NII-3) | 5710 | 6.07 | 2.56 | 3.32 | 4.89 | 11.622 | 10.65 | 30 | Pass |

Notes:

- * : Test was performed in accordance with measurement follow FCC KDB 789033 UNII test procedure Method SA-2 and use spectrum analyzer test , the duty factor was included in the total power.
- Directional gain is the maximum gain of antennas.
- For U-NII-2A, the maximum gain is 5.4 dBi < 6 dBi, so the output power limit shall not be reduced.
- For U-NII-2C, the maximum gain is 5.4 dBi < 6 dBi, so the output power limit shall not be reduced.
- For U-NII-3, the maximum gain is 5.4 dBi < 6 dBi, so the output power limit shall not be reduced.

802.11ax (HE80) CDD

| Chan. | Chan. Freq. (MHz) | Average Power (dBm) | | | | Total Power (mW) | Total Power (dBm) | Power Limit (dBm) | Test Result |
|-----------------|-------------------|---------------------|---------|---------|---------|------------------|-------------------|-------------------|-------------|
| | | Chain 0 | Chain 1 | Chain 2 | Chain 3 | | | | |
| 58 | 5290 | 15.75 | 16.51 | 16.48 | 16.37 | 170.169 | 22.31 | 24 | Pass |
| 106 | 5530 | 17.02 | 17.32 | 17.30 | 17.63 | 215.947 | 23.34 | 24 | Pass |
| 122 | 5610 | 17.71 | 17.91 | 18.12 | 17.56 | 242.702 | 23.85 | 24 | Pass |
| *138 (U-NII-2C) | 5690 | 15.86 | 16.67 | 16.06 | 16.31 | 177.988 | 22.50 | 24 | Pass |
| *138 (U-NII-3) | 5690 | 3.10 | 0.81 | -0.10 | 3.13 | 6.6485 | 8.23 | 30 | Pass |

Notes:

- * : Test was performed in accordance with measurement follow FCC KDB 789033 UNII test procedure Method SA-2 and use spectrum analyzer test , the duty factor was included in the total power.
- Directional gain is the maximum gain of antennas.
- For U-NII-2A, the maximum gain is 5.4 dBi < 6 dBi, so the output power limit shall not be reduced.
- For U-NII-2C, the maximum gain is 5.4 dBi < 6 dBi, so the output power limit shall not be reduced.
- For U-NII-3, the maximum gain is 5.4 dBi < 6 dBi, so the output power limit shall not be reduced.

802.11ax (HE20) CDD_RU242

| Chan. | Chan. Freq. (MHz) | Average Power (dBm) | | | | Total Power (mW) | Total Power (dBm) | Power Limit (dBm) | Test Result |
|-----------------|-------------------|---------------------|---------|---------|---------|------------------|-------------------|-------------------|-------------|
| | | Chain 0 | Chain 1 | Chain 2 | Chain 3 | | | | |
| 52 | 5260 | 12.24 | 12.39 | 13.12 | 12.68 | 73.134 | 18.64 | 24 | Pass |
| 60 | 5300 | 12.17 | 12.69 | 12.37 | 12.31 | 69.34 | 18.41 | 24 | Pass |
| 64 | 5320 | 13.05 | 12.25 | 12.78 | 12.82 | 75.081 | 18.76 | 24 | Pass |
| 100 | 5500 | 12.90 | 12.46 | 13.11 | 12.91 | 77.126 | 18.87 | 24 | Pass |
| 116 | 5580 | 12.44 | 12.65 | 12.63 | 12.83 | 73.456 | 18.66 | 24 | Pass |
| 140 | 5700 | 12.24 | 13.07 | 12.97 | 12.43 | 74.34 | 18.71 | 24 | Pass |
| *144 (U-NII-2C) | 5720 | 11.40 | 11.86 | 11.77 | 11.36 | 61.427 | 17.88 | 22.81 | Pass |
| *144 (U-NII-3) | 5720 | 8.28 | 8.35 | 6.03 | 5.26 | 22.226 | 13.47 | 30 | Pass |

Notes:

- * : Test was performed in accordance with measurement follow FCC KDB 789033 UNII test procedure Method SA-2 and use spectrum analyzer test , the duty factor was included in the total power.
- Directional gain is the maximum gain of antennas.
- For U-NII-2A, the directional gain is 5.4 dBi < 6 dBi, so the output power limit shall not be reduced.
- For U-NII-2C, the directional gain is 5.4 dBi < 6 dBi, so the output power limit shall not be reduced.
- For U-NII-3, the directional gain is 5.4 dBi < 6 dBi, so the output power limit shall not be reduced.

802.11ax (HE40) CDD_RU484

| Chan. | Chan. Freq. (MHz) | Average Power (dBm) | | | | Total Power (mW) | Total Power (dBm) | Power Limit (dBm) | Test Result |
|-----------------|-------------------|---------------------|---------|---------|---------|------------------|-------------------|-------------------|-------------|
| | | Chain 0 | Chain 1 | Chain 2 | Chain 3 | | | | |
| 54 | 5270 | 15.78 | 16.19 | 16.13 | 15.83 | 158.738 | 22.01 | 24 | Pass |
| 62 | 5310 | 15.50 | 15.33 | 15.95 | 15.92 | 148.04 | 21.70 | 24 | Pass |
| 102 | 5510 | 15.94 | 15.90 | 15.64 | 15.42 | 149.646 | 21.75 | 24 | Pass |
| 110 | 5550 | 15.02 | 15.02 | 15.80 | 15.39 | 136.15 | 21.34 | 24 | Pass |
| 134 | 5670 | 16.49 | 16.56 | 15.78 | 15.92 | 166.784 | 22.22 | 24 | Pass |
| *142 (U-NII-2C) | 5710 | 15.87 | 15.68 | 15.77 | 15.05 | 152.485 | 21.83 | 24 | Pass |
| *142 (U-NII-3) | 5710 | 6.07 | 2.56 | 3.32 | 4.89 | 11.622 | 10.65 | 30 | Pass |

Notes:

- * : Test was performed in accordance with measurement follow FCC KDB 789033 UNII test procedure Method SA-2 and use spectrum analyzer test , the duty factor was included in the total power.
- Directional gain is the maximum gain of antennas.
- For U-NII-2A, the maximum gain is 5.4 dBi < 6 dBi, so the output power limit shall not be reduced.
- For U-NII-2C, the maximum gain is 5.4 dBi < 6 dBi, so the output power limit shall not be reduced.
- For U-NII-3, the maximum gain is 5.4 dBi < 6 dBi, so the output power limit shall not be reduced.

802.11ax (HE80) CDD_RU996

| Chan. | Chan. Freq. (MHz) | Average Power (dBm) | | | | Total Power (mW) | Total Power (dBm) | Power Limit (dBm) | Test Result |
|-----------------|-------------------|---------------------|---------|---------|---------|------------------|-------------------|-------------------|-------------|
| | | Chain 0 | Chain 1 | Chain 2 | Chain 3 | | | | |
| 58 | 5290 | 15.13 | 15.98 | 15.99 | 16.29 | 154.49 | 21.89 | 24 | Pass |
| 106 | 5530 | 16.48 | 17.30 | 16.83 | 17.37 | 200.937 | 23.03 | 24 | Pass |
| 122 | 5610 | 17.29 | 17.85 | 18.10 | 17.11 | 230.503 | 23.63 | 24 | Pass |
| *138 (U-NII-2C) | 5690 | 15.86 | 16.67 | 16.06 | 16.31 | 177.988 | 22.50 | 24 | Pass |
| *138 (U-NII-3) | 5690 | 3.10 | 0.81 | -0.10 | 3.13 | 6.6485 | 8.23 | 30 | Pass |

Notes:

- * : Test was performed in accordance with measurement follow FCC KDB 789033 UNII test procedure Method SA-2 and use spectrum analyzer test , the duty factor was included in the total power.
- Directional gain is the maximum gain of antennas.
- For U-NII-2A, the maximum gain is 5.4 dBi < 6 dBi, so the output power limit shall not be reduced.
- For U-NII-2C, the maximum gain is 5.4 dBi < 6 dBi, so the output power limit shall not be reduced.
- For U-NII-3, the maximum gain is 5.4 dBi < 6 dBi, so the output power limit shall not be reduced.

802.11ac (VHT20) Beamforming

| Chan. | Chan. Freq. (MHz) | Average Power (dBm) | | | | Total Power (mW) | Total Power (dBm) | Power Limit (dBm) | Test Result |
|-----------------|-------------------|---------------------|---------|---------|---------|------------------|-------------------|-------------------|-------------|
| | | Chain 0 | Chain 1 | Chain 2 | Chain 3 | | | | |
| 52 | 5260 | 12.06 | 12.74 | 12.93 | 13.02 | 74.541 | 18.72 | 19.13 | Pass |
| 60 | 5300 | 12.27 | 12.61 | 12.73 | 12.71 | 72.518 | 18.60 | 19.13 | Pass |
| 64 | 5320 | 12.88 | 12.57 | 12.54 | 12.84 | 74.659 | 18.73 | 19.13 | Pass |
| 100 | 5500 | 12.64 | 12.36 | 12.89 | 12.72 | 73.744 | 18.68 | 19.13 | Pass |
| 116 | 5580 | 12.21 | 12.72 | 12.77 | 13.10 | 74.682 | 18.73 | 19.13 | Pass |
| 140 | 5700 | 12.10 | 12.92 | 12.78 | 12.38 | 72.072 | 18.58 | 19.13 | Pass |
| *144 (U-NII-2C) | 5720 | 11.40 | 11.86 | 11.77 | 11.36 | 61.427 | 17.88 | 17.94 | Pass |
| *144 (U-NII-3) | 5720 | 8.28 | 8.35 | 6.03 | 5.26 | 22.226 | 13.47 | 25.13 | Pass |

Notes:

- * : Test was performed in accordance with measurement follow FCC KDB 789033 UNII test procedure Method SA-2 and use spectrum analyzer test , the duty factor was included in the total power.
- Directional gain = $10 \log[(10^{\text{Chain0}/20} + 10^{\text{Chain1}/20} + 10^{\text{Chain2}/20} + 10^{\text{Chain3}/20})^2 / 4]$
- For U-NII-2A, the directional gain is 10.87 dBi > 6 dBi, so the output power limit shall be reduced to [Determined Conducted Power Limit-(10.87-6)].
- For U-NII-2C, the directional gain is 10.87 dBi > 6 dBi, so the output power limit shall be reduced to [Determined Conducted Power Limit-(10.87-6)].
- For U-NII-3, the directional gain is 10.87 dBi > 6 dBi, so the output power limit shall be reduced to $30 - (10.87 - 6) = 25.13$ dBm.

802.11ac (VHT40) Beamforming

| Chan. | Chan. Freq. (MHz) | Average Power (dBm) | | | | Total Power (mW) | Total Power (dBm) | Power Limit (dBm) | Test Result |
|-----------------|-------------------|---------------------|---------|---------|---------|------------------|-------------------|-------------------|-------------|
| | | Chain 0 | Chain 1 | Chain 2 | Chain 3 | | | | |
| 54 | 5270 | 11.93 | 12.69 | 12.69 | 12.52 | 70.616 | 18.49 | 19.13 | Pass |
| 62 | 5310 | 11.95 | 12.49 | 12.40 | 12.58 | 68.901 | 18.38 | 19.13 | Pass |
| 102 | 5510 | 12.15 | 12.07 | 12.00 | 12.00 | 64.21 | 18.08 | 19.13 | Pass |
| 110 | 5550 | 11.77 | 12.00 | 12.34 | 12.37 | 65.278 | 18.15 | 19.13 | Pass |
| 134 | 5670 | 12.69 | 13.04 | 12.65 | 12.50 | 74.906 | 18.75 | 19.13 | Pass |
| *142 (U-NII-2C) | 5710 | 12.85 | 12.63 | 12.74 | 12.01 | 75.817 | 18.80 | 19.13 | Pass |
| *142 (U-NII-3) | 5710 | 3.05 | -0.42 | 0.31 | 1.80 | 5.7838 | 7.62 | 25.13 | Pass |

Notes:

- * : Test was performed in accordance with measurement follow FCC KDB 789033 UNII test procedure Method SA-2 and use spectrum analyzer test , the duty factor was included in the total power.
- Directional gain = $10 \log[(10^{\text{Chain0}/20} + 10^{\text{Chain1}/20} + 10^{\text{Chain2}/20} + 10^{\text{Chain3}/20})^2 / 4]$
- For U-NII-2A, the directional gain is 10.87 dBi > 6 dBi, so the output power limit shall be reduced to [Determined Conducted Power Limit-(10.87-6)].
- For U-NII-2C, the directional gain is 10.87 dBi > 6 dBi, so the output power limit shall be reduced to [Determined Conducted Power Limit-(10.87-6)].
- For U-NII-3, the directional gain is 10.87 dBi > 6 dBi, so the output power limit shall be reduced to $30 - (10.87 - 6) = 25.13$ dBm.

802.11ac (VHT80) Beamforming

| Chan. | Chan. Freq. (MHz) | Average Power (dBm) | | | | Total Power (mW) | Total Power (dBm) | Power Limit (dBm) | Test Result |
|-----------------|-------------------|---------------------|---------|---------|---------|------------------|-------------------|-------------------|-------------|
| | | Chain 0 | Chain 1 | Chain 2 | Chain 3 | | | | |
| 58 | 5290 | 12.24 | 12.62 | 12.68 | 12.88 | 72.975 | 18.63 | 19.13 | Pass |
| 106 | 5530 | 12.54 | 12.60 | 12.63 | 12.86 | 73.787 | 18.68 | 19.13 | Pass |
| 122 | 5610 | 12.72 | 12.66 | 13.17 | 12.60 | 76.103 | 18.81 | 19.13 | Pass |
| *138 (U-NII-2C) | 5690 | 12.33 | 13.15 | 12.54 | 12.79 | 79.097 | 18.98 | 19.13 | Pass |
| *138 (U-NII-3) | 5690 | -0.43 | -2.66 | -3.55 | -0.41 | 2.9635 | 4.72 | 25.13 | Pass |

Notes:

- * : Test was performed in accordance with measurement follow FCC KDB 789033 UNII test procedure Method SA-2 and use spectrum analyzer test , the duty factor was included in the total power.
- Directional gain = $10 \log[(10^{\text{Chain0}/20} + 10^{\text{Chain1}/20} + 10^{\text{Chain2}/20} + 10^{\text{Chain3}/20})^2 / 4]$
- For U-NII-2A, the directional gain is 10.87 dBi > 6 dBi, so the output power limit shall be reduced to [Determined Conducted Power Limit-(10.87-6)].
- For U-NII-2C, the directional gain is 10.87 dBi > 6 dBi, so the output power limit shall be reduced to [Determined Conducted Power Limit-(10.87-6)].
- For U-NII-3, the directional gain is 10.87 dBi > 6 dBi, so the output power limit shall be reduced to $30 - (10.87 - 6) = 25.13$ dBm.

802.11ax (HE20) Beamforming

| Chan. | Chan. Freq. (MHz) | Average Power (dBm) | | | | Total Power (mW) | Total Power (dBm) | Power Limit (dBm) | Test Result |
|-----------------|-------------------|---------------------|---------|---------|---------|------------------|-------------------|-------------------|-------------|
| | | Chain 0 | Chain 1 | Chain 2 | Chain 3 | | | | |
| 52 | 5260 | 12.26 | 13.02 | 13.14 | 13.23 | 78.516 | 18.95 | 19.13 | Pass |
| 60 | 5300 | 12.51 | 12.87 | 12.97 | 12.96 | 76.773 | 18.85 | 19.13 | Pass |
| 64 | 5320 | 13.11 | 12.85 | 12.82 | 13.04 | 79.019 | 18.98 | 19.13 | Pass |
| 100 | 5500 | 12.92 | 12.63 | 13.13 | 12.95 | 78.195 | 18.93 | 19.13 | Pass |
| 116 | 5580 | 12.50 | 12.97 | 12.98 | 13.37 | 79.186 | 18.99 | 19.13 | Pass |
| 140 | 5700 | 12.39 | 13.20 | 13.05 | 12.62 | 76.696 | 18.85 | 19.13 | Pass |
| *144 (U-NII-2C) | 5720 | 11.40 | 11.86 | 11.77 | 11.36 | 61.427 | 17.88 | 17.94 | Pass |
| *144 (U-NII-3) | 5720 | 8.28 | 8.35 | 6.03 | 5.26 | 22.226 | 13.47 | 25.13 | Pass |

Notes:

- * : Test was performed in accordance with measurement follow FCC KDB 789033 UNII test procedure Method SA-2 and use spectrum analyzer test , the duty factor was included in the total power.
- Directional gain = $10 \log[(10^{\text{Chain0}/20} + 10^{\text{Chain1}/20} + 10^{\text{Chain2}/20} + 10^{\text{Chain3}/20})^2 / 4]$
- For U-NII-2A, the directional gain is 10.87 dBi > 6 dBi, so the output power limit shall be reduced to [Determined Conducted Power Limit-(10.87-6)].
- For U-NII-2C, the directional gain is 10.87 dBi > 6 dBi, so the output power limit shall be reduced to [Determined Conducted Power Limit-(10.87-6)].
- For U-NII-3, the directional gain is 10.87 dBi > 6 dBi, so the output power limit shall be reduced to $30 - (10.87 - 6) = 25.13$ dBm.

802.11ax (HE40) Beamforming

| Chan. | Chan. Freq. (MHz) | Average Power (dBm) | | | | Total Power (mW) | Total Power (dBm) | Power Limit (dBm) | Test Result |
|-----------------|-------------------|---------------------|---------|---------|---------|------------------|-------------------|-------------------|-------------|
| | | Chain 0 | Chain 1 | Chain 2 | Chain 3 | | | | |
| 54 | 5270 | 12.14 | 12.92 | 12.97 | 12.79 | 74.783 | 18.74 | 19.13 | Pass |
| 62 | 5310 | 12.24 | 12.73 | 12.68 | 12.82 | 73.177 | 18.64 | 19.13 | Pass |
| 102 | 5510 | 12.43 | 12.31 | 12.27 | 12.24 | 68.135 | 18.33 | 19.13 | Pass |
| 110 | 5550 | 12.06 | 12.29 | 12.56 | 12.64 | 69.408 | 18.41 | 19.13 | Pass |
| 134 | 5670 | 12.94 | 13.27 | 12.87 | 12.78 | 79.243 | 18.99 | 19.13 | Pass |
| *142 (U-NII-2C) | 5710 | 12.85 | 12.63 | 12.74 | 12.01 | 75.817 | 18.80 | 19.13 | Pass |
| *142 (U-NII-3) | 5710 | 3.05 | -0.42 | 0.31 | 1.80 | 5.7838 | 7.62 | 25.13 | Pass |

Notes:

- * : Test was performed in accordance with measurement follow FCC KDB 789033 UNII test procedure Method SA-2 and use spectrum analyzer test , the duty factor was included in the total power.
- Directional gain = $10 \log[(10^{\text{Chain0}/20} + 10^{\text{Chain1}/20} + 10^{\text{Chain2}/20} + 10^{\text{Chain3}/20})^2 / 4]$
- For U-NII-2A, the directional gain is 10.87 dBi > 6 dBi, so the output power limit shall be reduced to [Determined Conducted Power Limit-(10.87-6)].
- For U-NII-2C, the directional gain is 10.87 dBi > 6 dBi, so the output power limit shall be reduced to [Determined Conducted Power Limit-(10.87-6)].
- For U-NII-3, the directional gain is 10.87 dBi > 6 dBi, so the output power limit shall be reduced to $30 - (10.87 - 6) = 25.13$ dBm.

802.11ax (HE80) Beamforming

| Chan. | Chan. Freq. (MHz) | Average Power (dBm) | | | | Total Power (mW) | Total Power (dBm) | Power Limit (dBm) | Test Result |
|-----------------|-------------------|---------------------|---------|---------|---------|------------------|-------------------|-------------------|-------------|
| | | Chain 0 | Chain 1 | Chain 2 | Chain 3 | | | | |
| 58 | 5290 | 12.47 | 12.85 | 12.91 | 13.11 | 76.943 | 18.86 | 19.13 | Pass |
| 106 | 5530 | 12.81 | 12.83 | 12.86 | 13.12 | 78.117 | 18.93 | 19.13 | Pass |
| 122 | 5610 | 12.98 | 12.86 | 13.37 | 12.87 | 80.272 | 19.05 | 19.13 | Pass |
| *138 (U-NII-2C) | 5690 | 12.33 | 13.15 | 12.54 | 12.79 | 79.097 | 18.98 | 19.13 | Pass |
| *138 (U-NII-3) | 5690 | -0.43 | -2.66 | -3.55 | -0.41 | 2.9635 | 4.72 | 25.13 | Pass |

Notes:

- * : Test was performed in accordance with measurement follow FCC KDB 789033 UNII test procedure Method SA-2 and use spectrum analyzer test , the duty factor was included in the total power.
- Directional gain = $10 \log[(10^{\text{Chain0}/20} + 10^{\text{Chain1}/20} + 10^{\text{Chain2}/20} + 10^{\text{Chain3}/20})^2 / 4]$
- For U-NII-2A, the directional gain is 10.87 dBi > 6 dBi, so the output power limit shall be reduced to [Determined Conducted Power Limit-(10.87-6)].
- For U-NII-2C, the directional gain is 10.87 dBi > 6 dBi, so the output power limit shall be reduced to [Determined Conducted Power Limit-(10.87-6)].
- For U-NII-3, the directional gain is 10.87 dBi > 6 dBi, so the output power limit shall be reduced to $30 - (10.87 - 6) = 25.13$ dBm.

802.11ax (HE20) Beamforming_RU242

| Chan. | Chan. Freq. (MHz) | Average Power (dBm) | | | | Total Power (mW) | Total Power (dBm) | Power Limit (dBm) | Test Result |
|-----------------|-------------------|---------------------|---------|---------|---------|------------------|-------------------|-------------------|-------------|
| | | Chain 0 | Chain 1 | Chain 2 | Chain 3 | | | | |
| 52 | 5260 | 12.20 | 12.42 | 12.59 | 13.19 | 73.054 | 18.64 | 19.13 | Pass |
| 60 | 5300 | 12.20 | 12.47 | 12.52 | 12.87 | 71.485 | 18.54 | 19.13 | Pass |
| 64 | 5320 | 12.61 | 12.40 | 12.38 | 12.46 | 70.535 | 18.48 | 19.13 | Pass |
| 100 | 5500 | 12.83 | 12.41 | 12.84 | 12.93 | 75.469 | 18.78 | 19.13 | Pass |
| 116 | 5580 | 12.26 | 12.39 | 12.67 | 13.07 | 72.934 | 18.63 | 19.13 | Pass |
| 140 | 5700 | 12.31 | 13.00 | 12.98 | 12.33 | 73.935 | 18.69 | 19.13 | Pass |
| *144 (U-NII-2C) | 5720 | 11.40 | 11.86 | 11.77 | 11.36 | 61.427 | 17.88 | 17.94 | Pass |
| *144 (U-NII-3) | 5720 | 8.28 | 8.35 | 6.03 | 5.26 | 22.226 | 13.47 | 25.13 | Pass |

Notes:

- * : Test was performed in accordance with measurement follow FCC KDB 789033 UNII test procedure Method SA-2 and use spectrum analyzer test , the duty factor was included in the total power.
- Directional gain = $10 \log[(10^{\text{Chain0}/20} + 10^{\text{Chain1}/20} + 10^{\text{Chain2}/20} + 10^{\text{Chain3}/20})^2 / 4]$
- For U-NII-2A, the directional gain is 10.87 dBi > 6 dBi, so the output power limit shall be reduced to [Determined Conducted Power Limit-(10.87-6)].
- For U-NII-2C, the directional gain is 10.87 dBi > 6 dBi, so the output power limit shall be reduced to [Determined Conducted Power Limit-(10.87-6)].
- For U-NII-3, the directional gain is 10.87 dBi > 6 dBi, so the output power limit shall be reduced to $30 - (10.87 - 6) = 25.13$ dBm.

802.11ax (HE40) Beamforming_RU484

| Chan. | Chan. Freq. (MHz) | Average Power (dBm) | | | | Total Power (mW) | Total Power (dBm) | Power Limit (dBm) | Test Result |
|-----------------|-------------------|---------------------|---------|---------|---------|------------------|-------------------|-------------------|-------------|
| | | Chain 0 | Chain 1 | Chain 2 | Chain 3 | | | | |
| 54 | 5270 | 12.09 | 12.74 | 12.77 | 12.28 | 70.802 | 18.50 | 19.13 | Pass |
| 62 | 5310 | 11.79 | 12.21 | 12.10 | 12.29 | 64.896 | 18.12 | 19.13 | Pass |
| 102 | 5510 | 12.27 | 12.30 | 12.21 | 11.86 | 65.828 | 18.18 | 19.13 | Pass |
| 110 | 5550 | 11.47 | 12.16 | 11.92 | 12.02 | 61.954 | 17.92 | 19.13 | Pass |
| 134 | 5670 | 12.43 | 13.01 | 12.56 | 12.53 | 73.433 | 18.66 | 19.13 | Pass |
| *142 (U-NII-2C) | 5710 | 12.85 | 12.63 | 12.74 | 12.01 | 75.817 | 18.80 | 19.13 | Pass |
| *142 (U-NII-3) | 5710 | 3.05 | -0.42 | 0.31 | 1.80 | 5.7838 | 7.62 | 25.13 | Pass |

Notes:

- * : Test was performed in accordance with measurement follow FCC KDB 789033 UNII test procedure Method SA-2 and use spectrum analyzer test , the duty factor was included in the total power.
- Directional gain = $10 \log[(10^{\text{Chain0}/20} + 10^{\text{Chain1}/20} + 10^{\text{Chain2}/20} + 10^{\text{Chain3}/20})^2 / 4]$
- For U-NII-2A, the directional gain is 10.87 dBi > 6 dBi, so the output power limit shall be reduced to [Determined Conducted Power Limit-(10.87-6)].
- For U-NII-2C, the directional gain is 10.87 dBi > 6 dBi, so the output power limit shall be reduced to [Determined Conducted Power Limit-(10.87-6)].
- For U-NII-3, the directional gain is 10.87 dBi > 6 dBi, so the output power limit shall be reduced to $30 - (10.87 - 6) = 25.13$ dBm.



802.11ax (HE80) Beamforming_RU996

| Chan. | Chan. Freq. (MHz) | Average Power (dBm) | | | | Total Power (mW) | Total Power (dBm) | Power Limit (dBm) | Test Result |
|-----------------|-------------------|---------------------|---------|---------|---------|------------------|-------------------|-------------------|-------------|
| | | Chain 0 | Chain 1 | Chain 2 | Chain 3 | | | | |
| 58 | 5290 | 12.29 | 12.49 | 12.86 | 13.06 | 74.235 | 18.71 | 19.13 | Pass |
| 106 | 5530 | 12.58 | 12.62 | 12.72 | 13.00 | 75.054 | 18.75 | 19.13 | Pass |
| 122 | 5610 | 12.74 | 12.81 | 12.99 | 12.80 | 76.853 | 18.86 | 19.13 | Pass |
| *138 (U-NII-2C) | 5690 | 12.33 | 13.15 | 12.54 | 12.79 | 79.097 | 18.98 | 19.13 | Pass |
| *138 (U-NII-3) | 5690 | -0.43 | -2.66 | -3.55 | -0.41 | 2.9635 | 4.72 | 25.13 | Pass |

Notes:

- * : Test was performed in accordance with measurement follow FCC KDB 789033 UNII test procedure Method SA-2 and use spectrum analyzer test , the duty factor was included in the total power.
- Directional gain = $10 \log[(10^{\text{Chain0}/20} + 10^{\text{Chain1}/20} + 10^{\text{Chain2}/20} + 10^{\text{Chain3}/20})^2 / 4]$
- For U-NII-2A, the directional gain is 10.87 dBi > 6 dBi, so the output power limit shall be reduced to [Determined Conducted Power Limit-(10.87-6)].
- For U-NII-2C, the directional gain is 10.87 dBi > 6 dBi, so the output power limit shall be reduced to [Determined Conducted Power Limit-(10.87-6)].
- For U-NII-3, the directional gain is 10.87 dBi > 6 dBi, so the output power limit shall be reduced to $30-(10.87-6) = 25.13$ dBm.

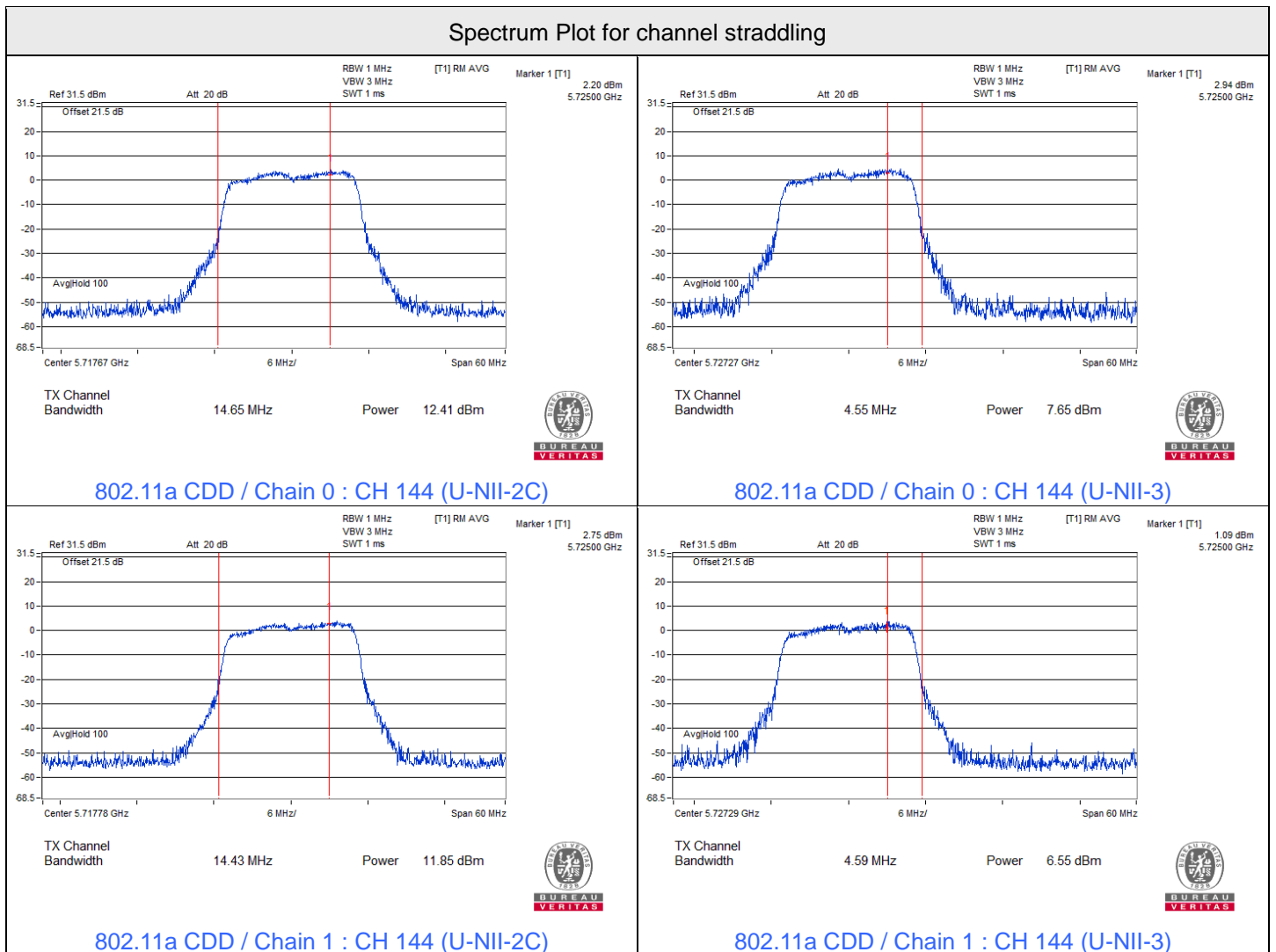

Spectrum Plot for channel straddling

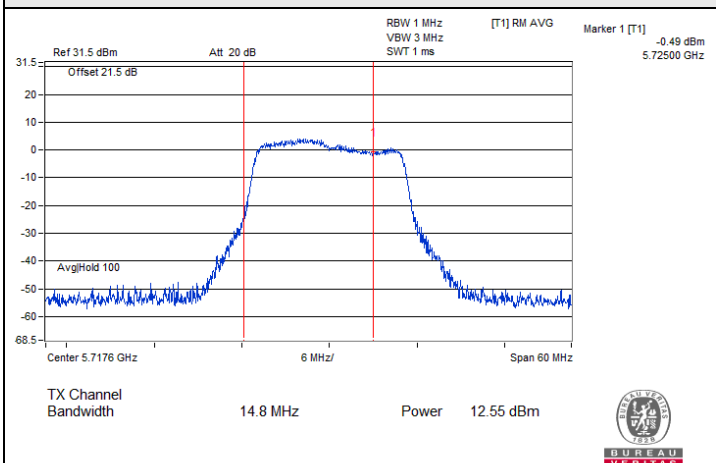

802.11a CDD / Chain 2 : CH 144 (U-NII-2C)

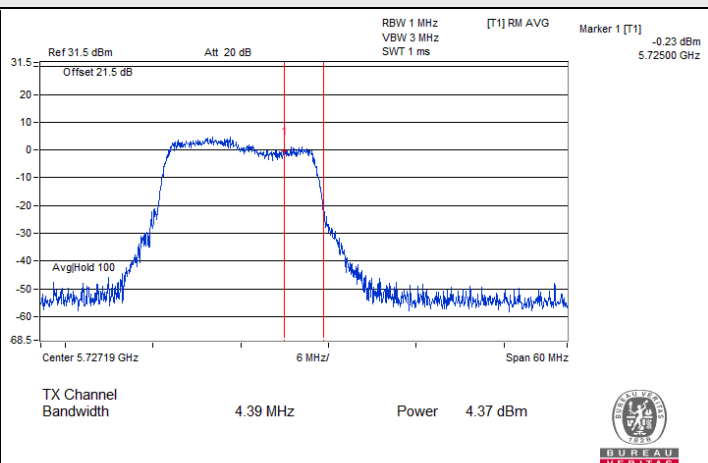

802.11a CDD / Chain 2 : CH 144 (U-NII-3)

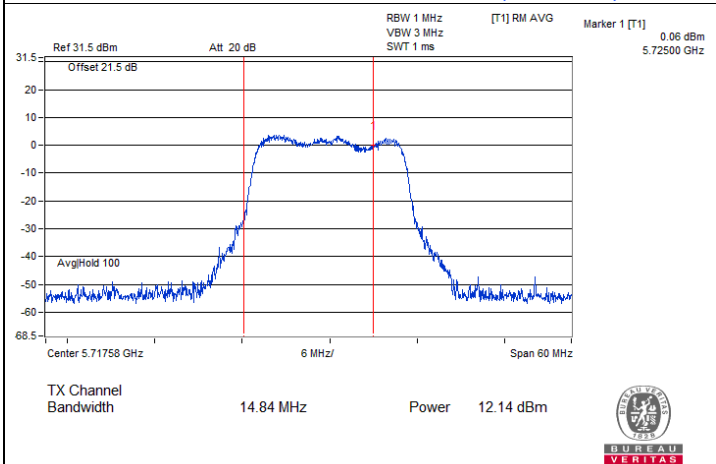

802.11a CDD / Chain 3 : CH 144 (U-NII-2C)

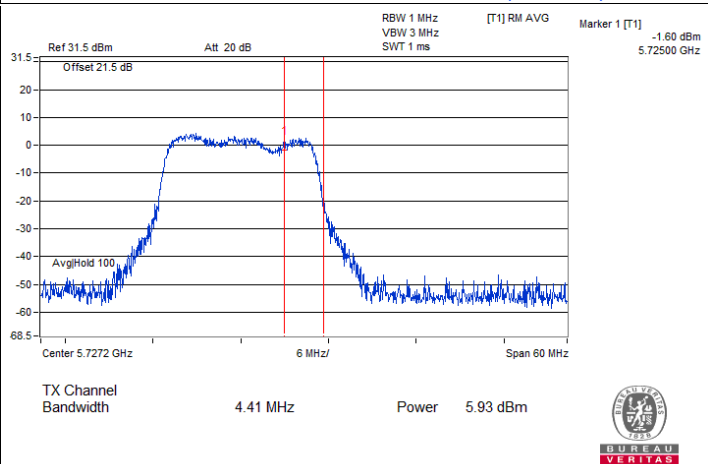

802.11a CDD / Chain 3 : CH 144 (U-NII-3)

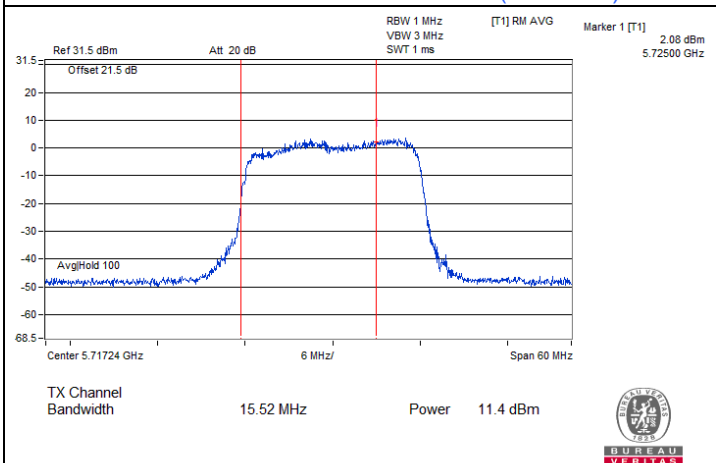

802.11ac (VHT20) CDD / Chain 0 : CH 144 (U-NII-2C)

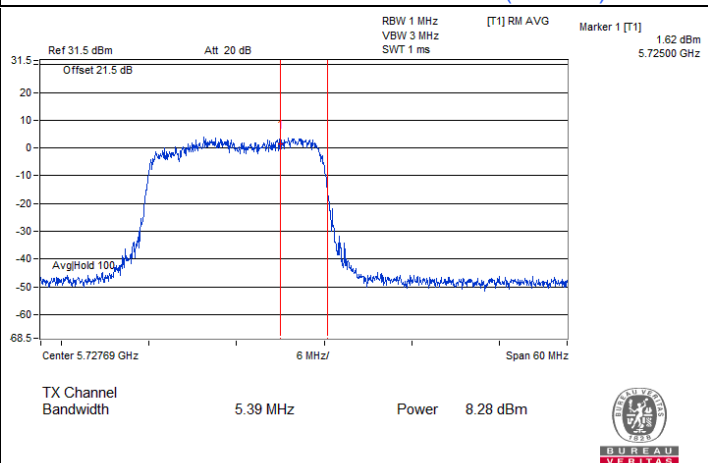

802.11ac (VHT20) CDD / Chain 0 : CH 144 (U-NII-3)

Spectrum Plot for channel straddling

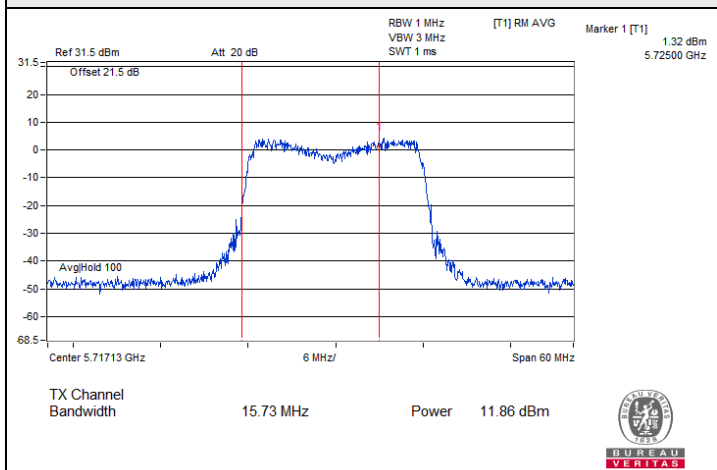

802.11ac (VHT20) CDD / Chain 1 : CH 144 (U-NII-2C)

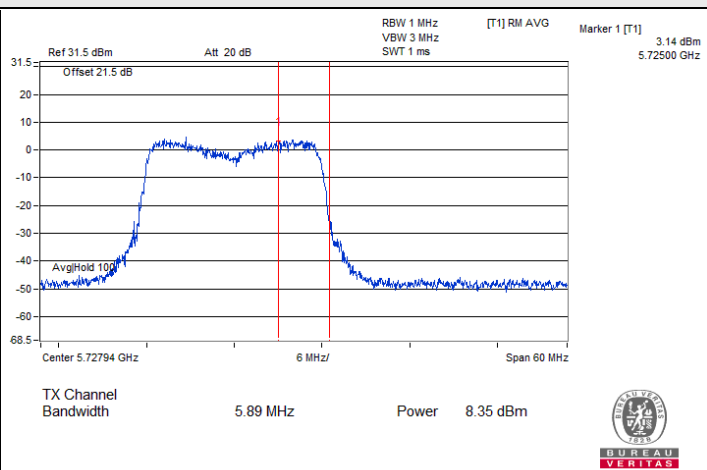

802.11ac (VHT20) CDD / Chain 1 : CH 144 (U-NII-3)

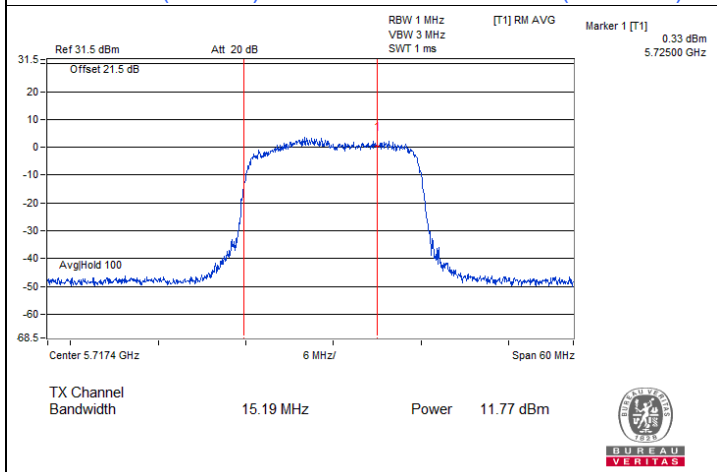

802.11ac (VHT20) CDD / Chain 2 : CH 144 (U-NII-2C)

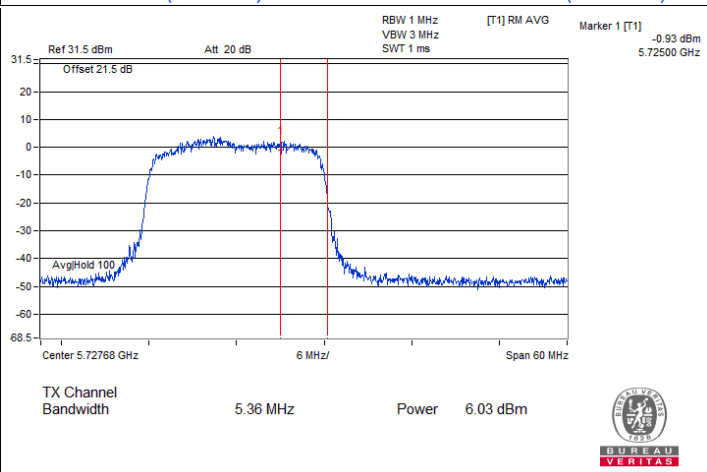

802.11ac (VHT20) CDD / Chain 2 : CH 144 (U-NII-3)

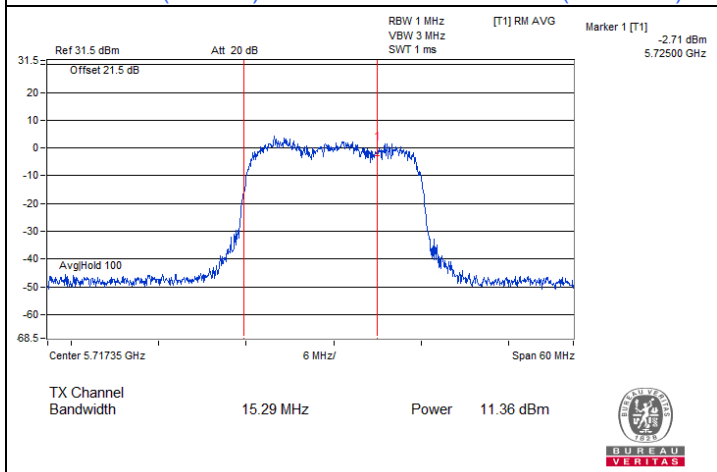

802.11ac (VHT20) CDD / Chain 3 : CH 144 (U-NII-2C)

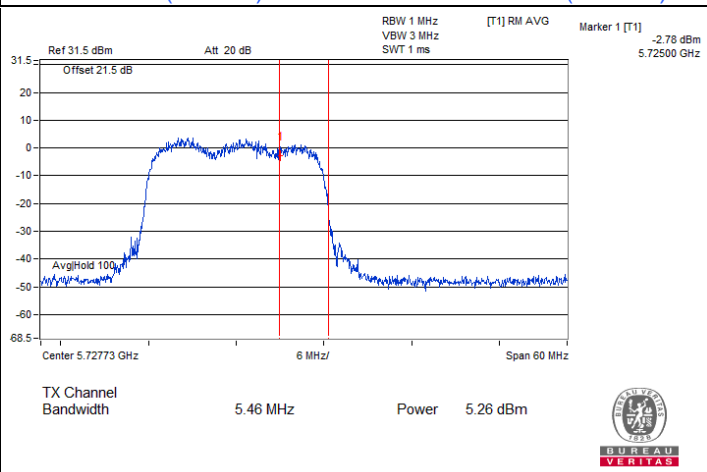

802.11ac (VHT20) CDD / Chain 3 : CH 144 (U-NII-3)

Spectrum Plot for channel straddling

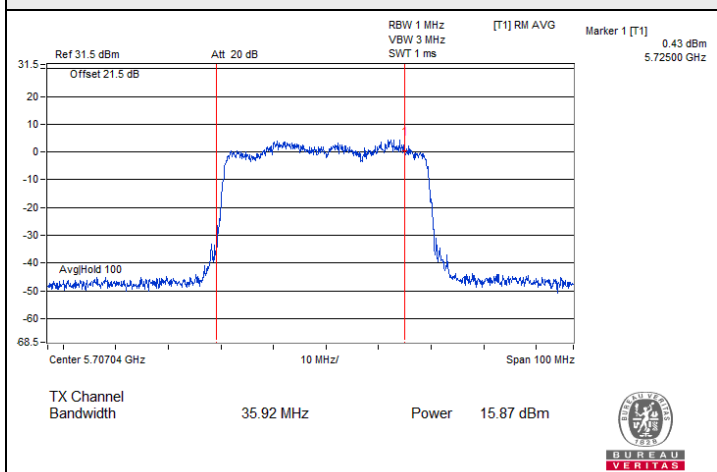

802.11ac (VHT40) CDD / Chain 0 : CH 142 (U-NII-2C)

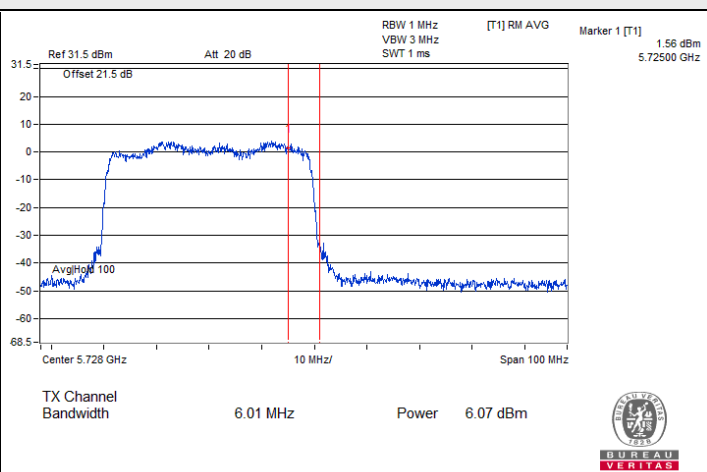

802.11ac (VHT40) CDD / Chain 0 : CH 142 (U-NII-3)

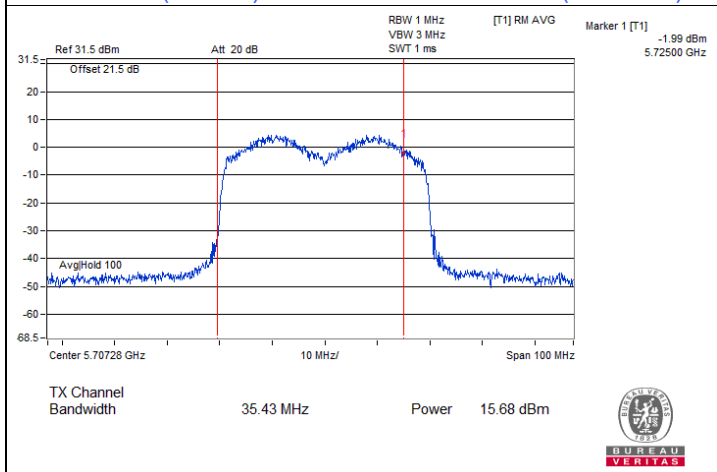

802.11ac (VHT40) CDD / Chain 1 : CH 142 (U-NII-2C)

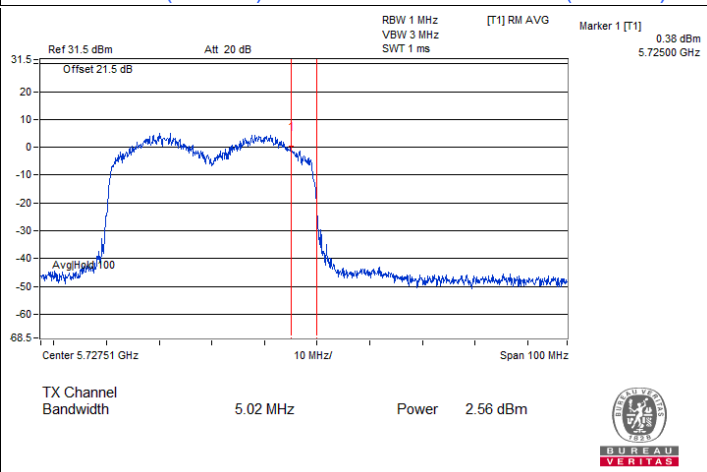

802.11ac (VHT40) CDD / Chain 1 : CH 142 (U-NII-3)

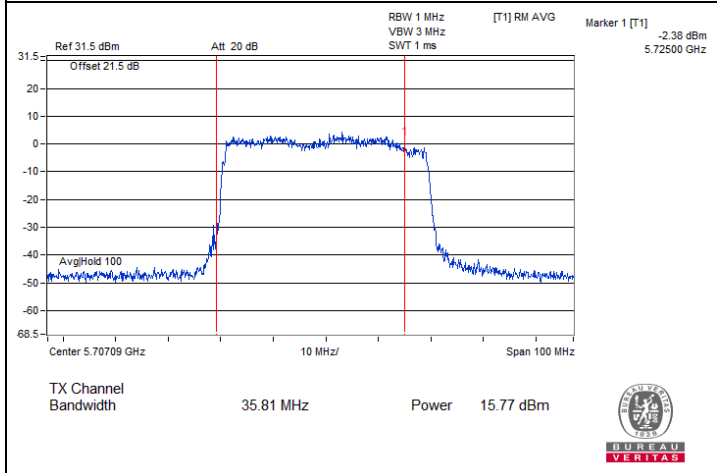

802.11ac (VHT40) CDD / Chain 2 : CH 142 (U-NII-2C)

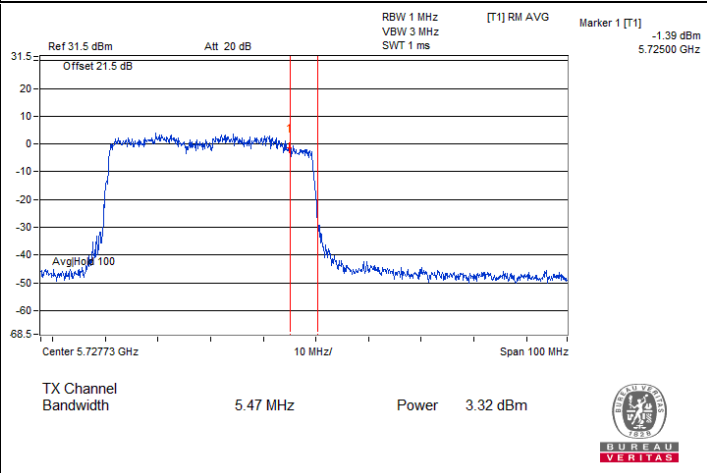

802.11ac (VHT40) CDD / Chain 2 : CH 142 (U-NII-3)

Spectrum Plot for channel straddling

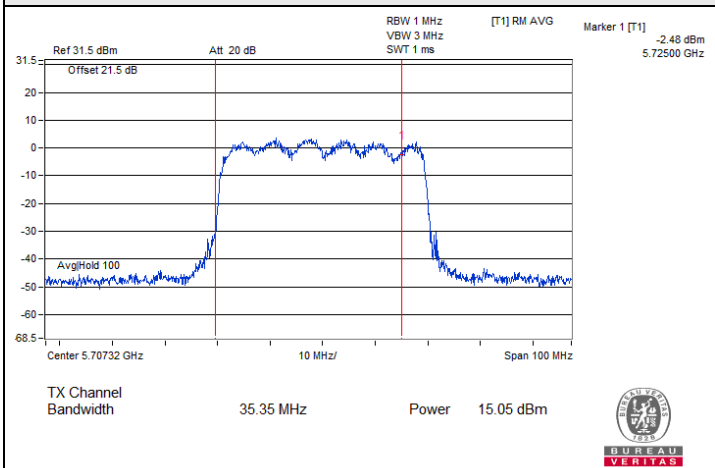

802.11ac (VHT40) CDD / Chain 3 : CH 142 (U-NII-2C)

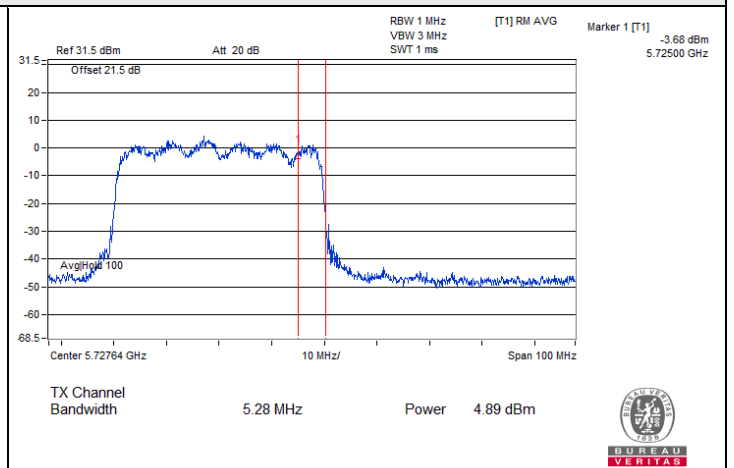

802.11ac (VHT40) CDD / Chain 3 : CH 142 (U-NII-3)

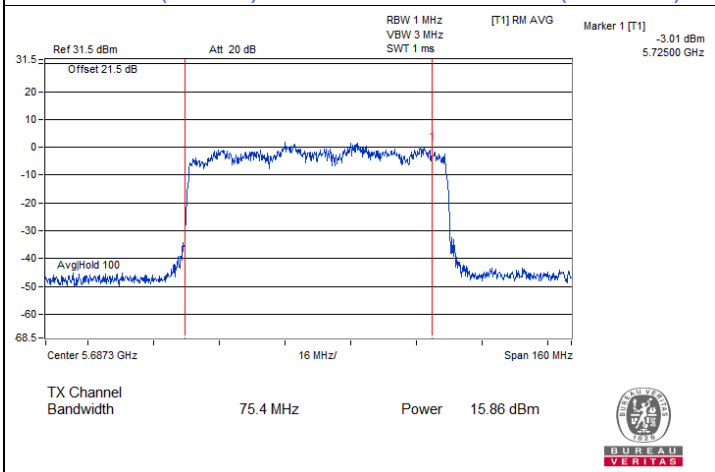

802.11ac (VHT80) CDD / Chain 0 : CH 138 (U-NII-2C)

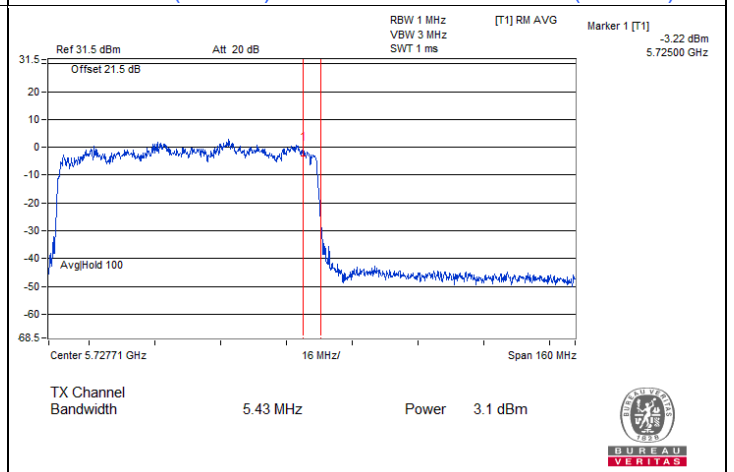

802.11ac (VHT80) CDD / Chain 0 : CH 138 (U-NII-3)

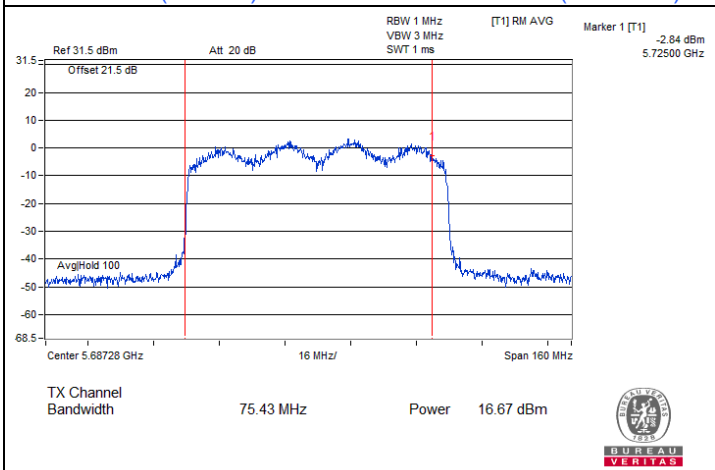

802.11ac (VHT80) CDD / Chain 1 : CH 138 (U-NII-2C)

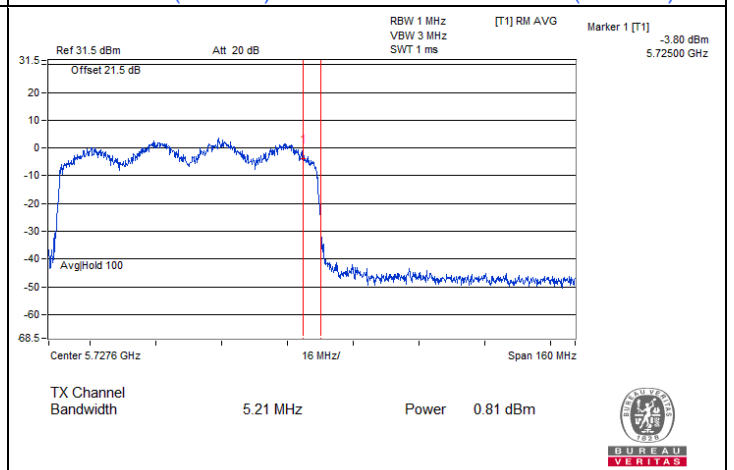

802.11ac (VHT80) CDD / Chain 1 : CH 138 (U-NII-3)

Spectrum Plot for channel straddling

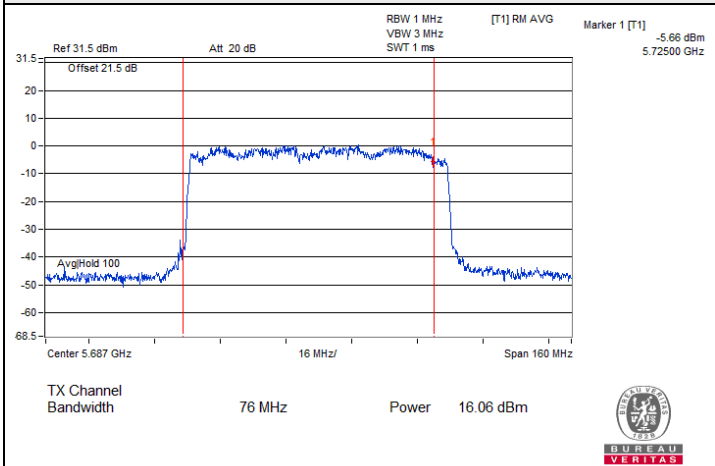

802.11ac (VHT80) CDD / Chain 2 : CH 138 (U-NII-2C)

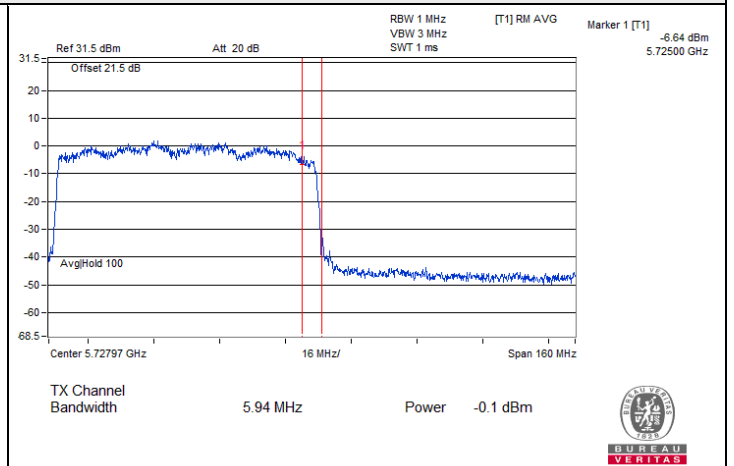

802.11ac (VHT80) CDD / Chain 2 : CH 138 (U-NII-3)

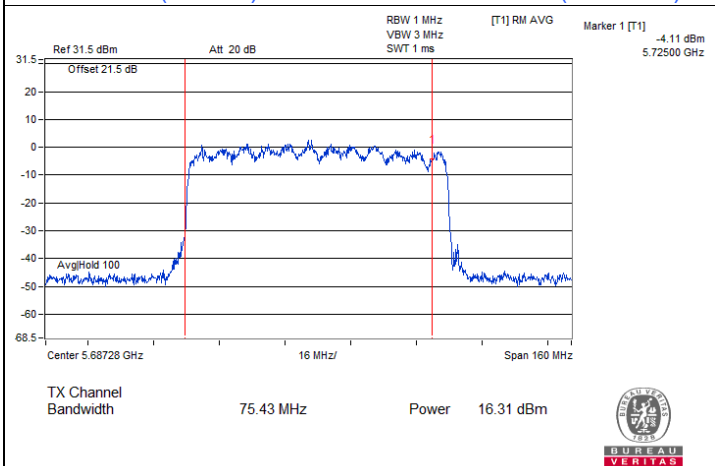

802.11ac (VHT80) CDD / Chain 3 : CH 138 (U-NII-2C)

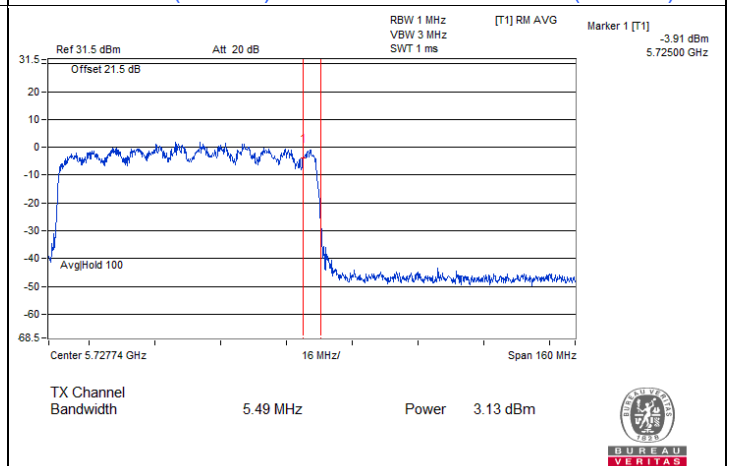

802.11ac (VHT80) CDD / Chain 3 : CH 138 (U-NII-3)

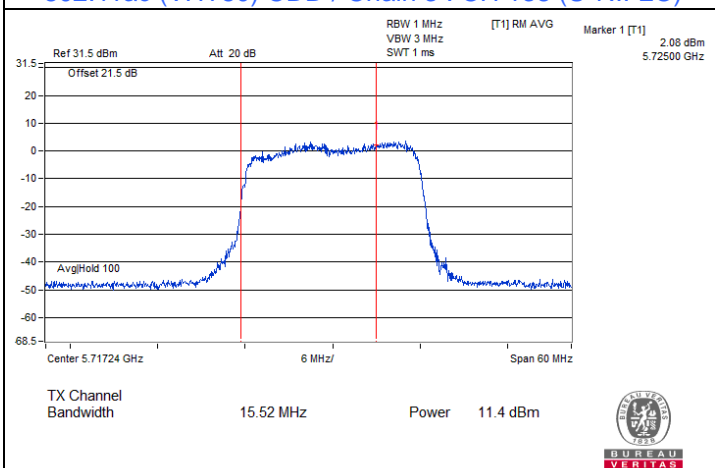

802.11ax (HE20) CDD / Chain 0 : CH 144 (U-NII-2C)

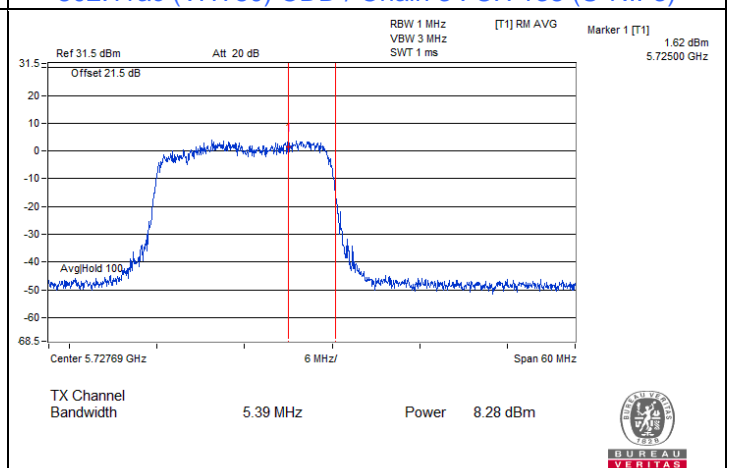

802.11ax (HE20) CDD / Chain 0 : CH 144 (U-NII-3)

Spectrum Plot for channel straddling

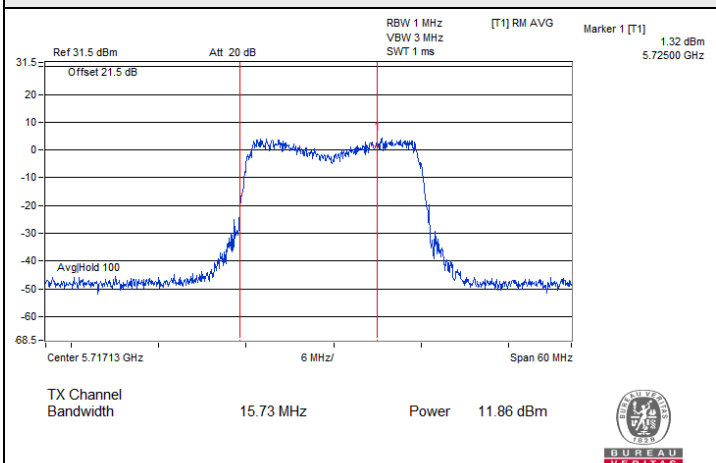

802.11ax (HE20) CDD / Chain 1 : CH 144 (U-NII-2C)

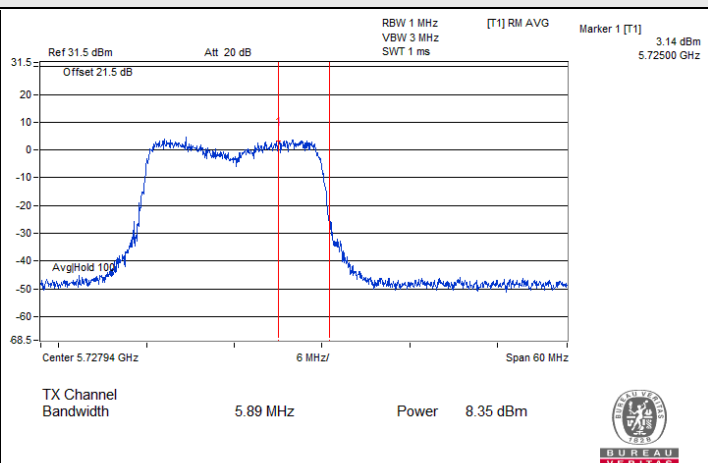

802.11ax (HE20) CDD / Chain 1 : CH 144 (U-NII-3)

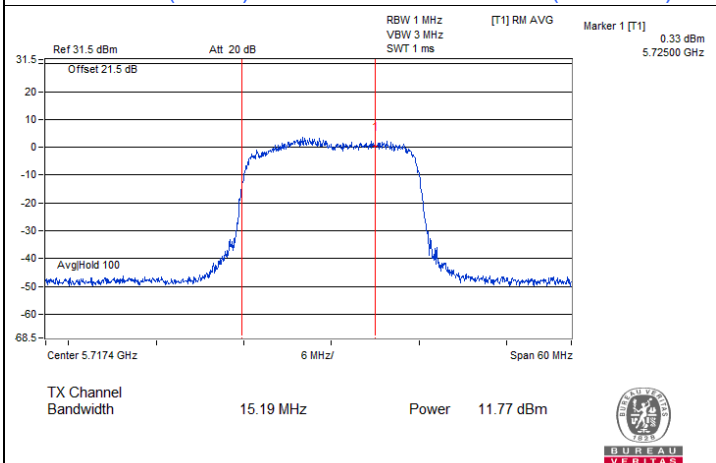

802.11ax (HE20) CDD / Chain 2 : CH 144 (U-NII-2C)

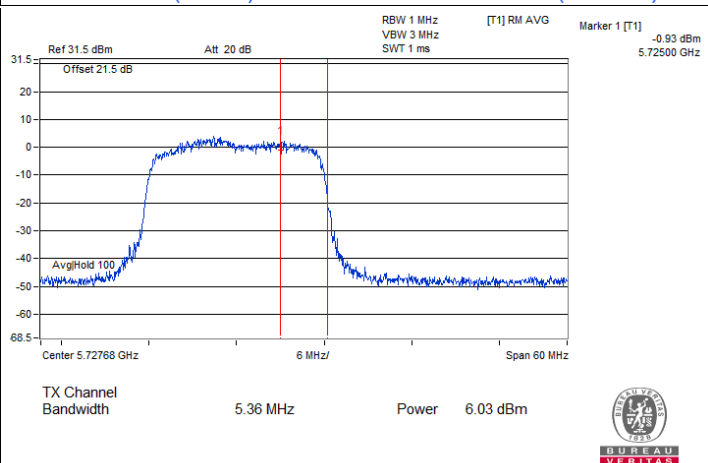

802.11ax (HE20) CDD / Chain 2 : CH 144 (U-NII-3)

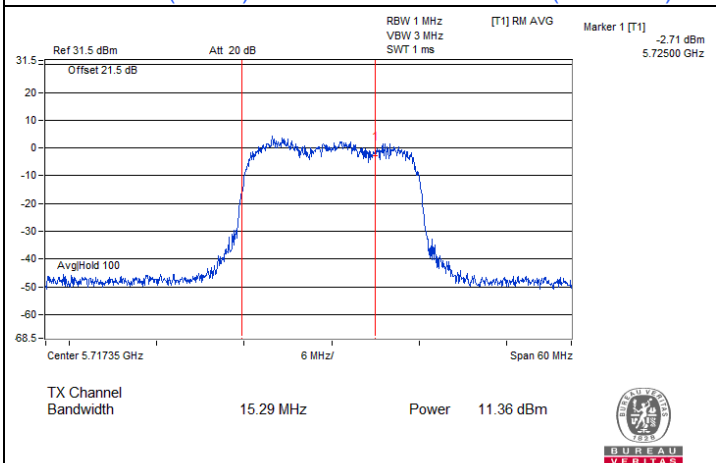

802.11ax (HE20) CDD / Chain 3 : CH 144 (U-NII-2C)

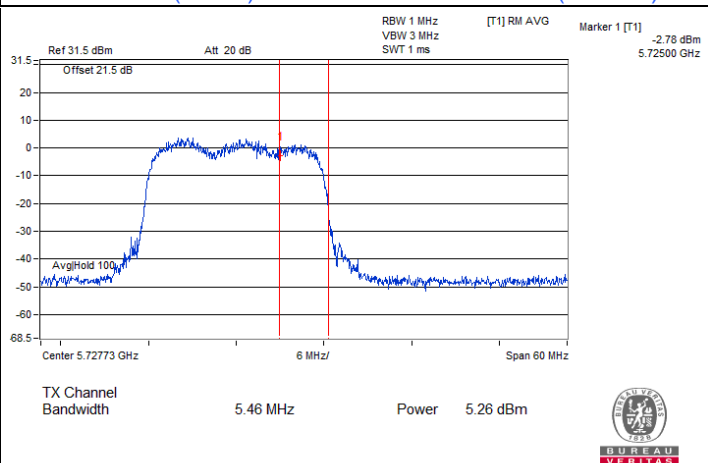

802.11ax (HE20) CDD / Chain 3 : CH 144 (U-NII-3)

Spectrum Plot for channel straddling

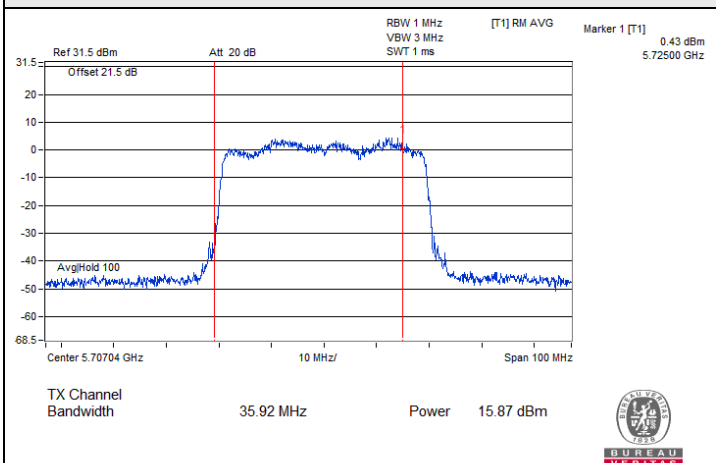

802.11ax (HE40) CDD / Chain 0 : CH 142 (U-NII-2C)

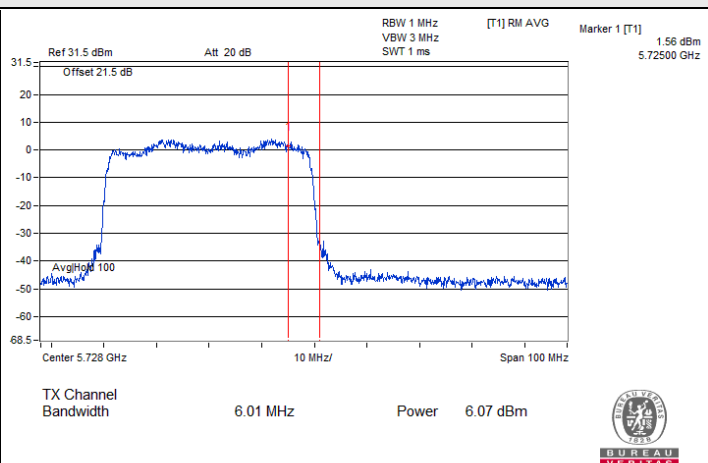

802.11ax (HE40) CDD / Chain 0 : CH 142 (U-NII-3)

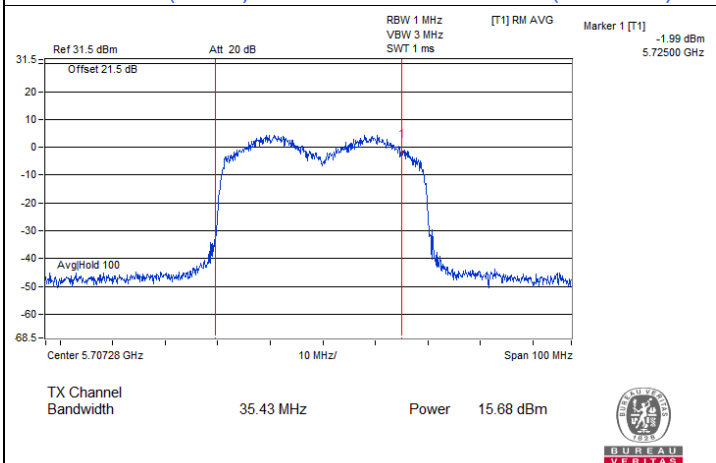

802.11ax (HE40) CDD / Chain 1 : CH 142 (U-NII-2C)

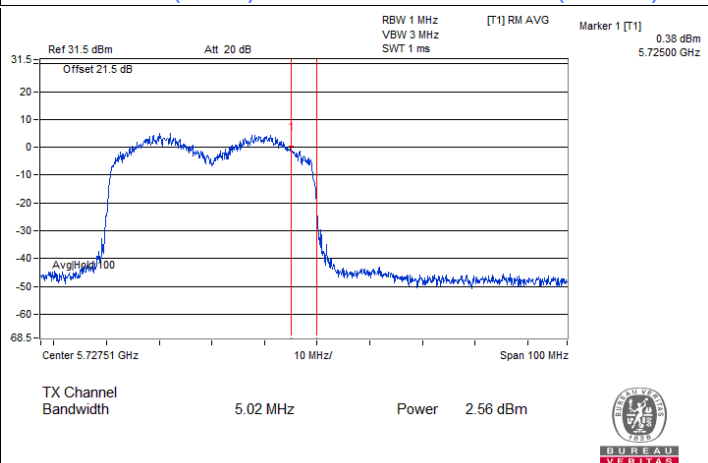

802.11ax (HE40) CDD / Chain 1 : CH 142 (U-NII-3)

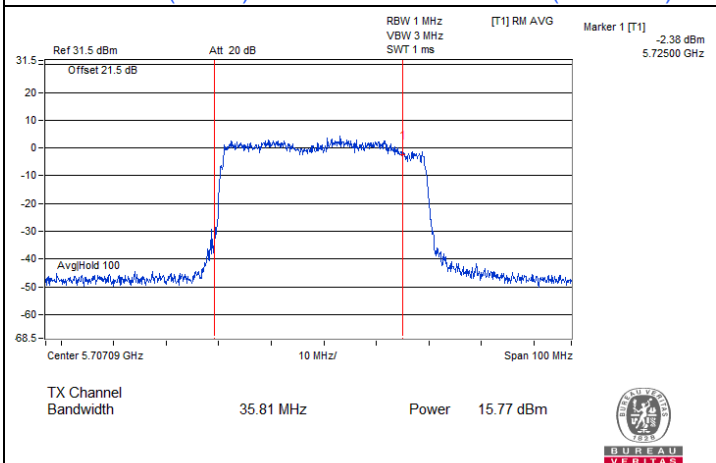

802.11ax (HE40) CDD / Chain 2 : CH 142 (U-NII-2C)

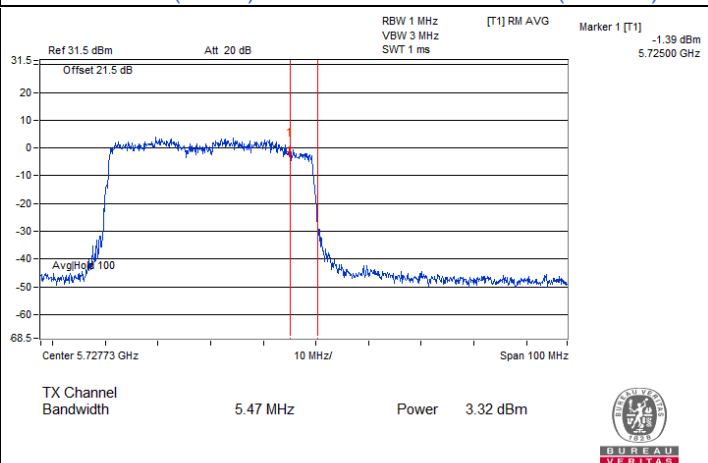

802.11ax (HE40) CDD / Chain 2 : CH 142 (U-NII-3)

Spectrum Plot for channel straddling

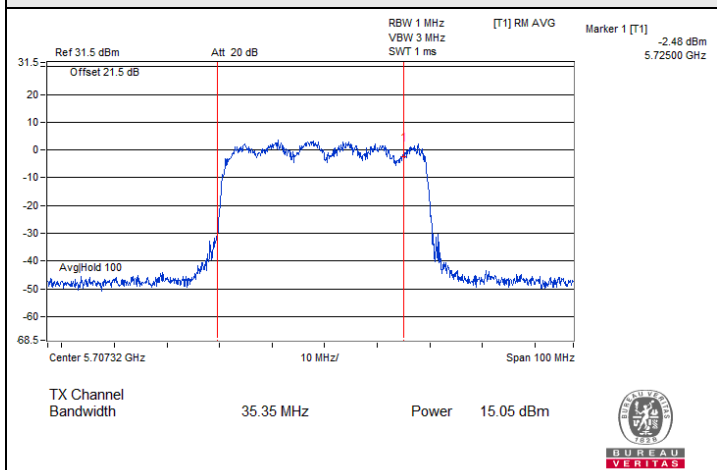

802.11ax (HE40) CDD / Chain 3 : CH 142 (U-NII-2C)

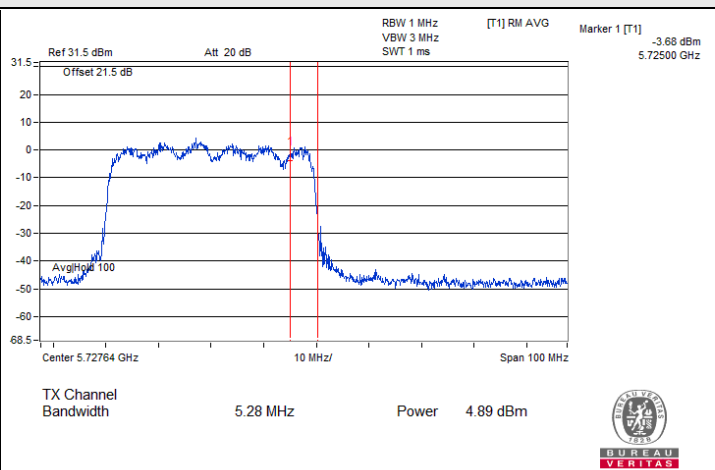

802.11ax (HE40) CDD / Chain 3 : CH 142 (U-NII-3)

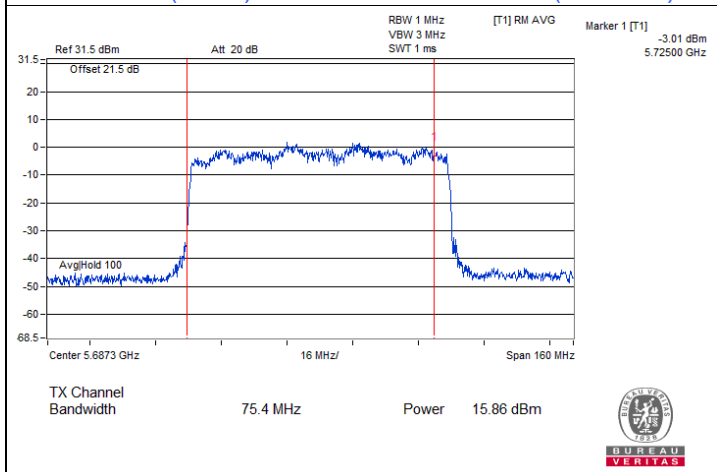

802.11ax (HE80) CDD / Chain 0 : CH 138 (U-NII-2C)

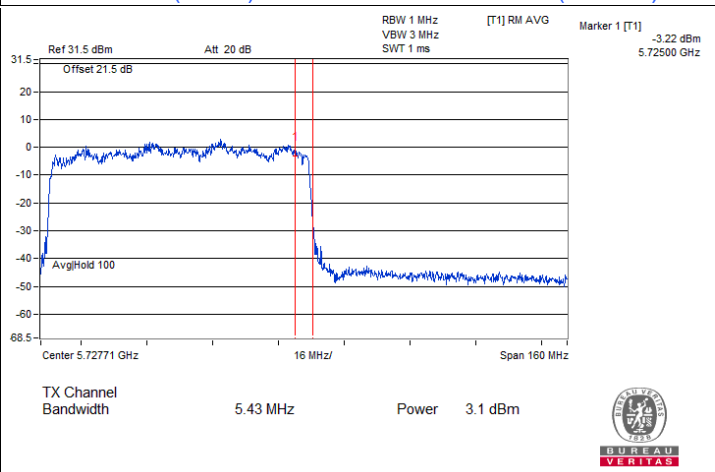

802.11ax (HE80) CDD / Chain 0 : CH 138 (U-NII-3)

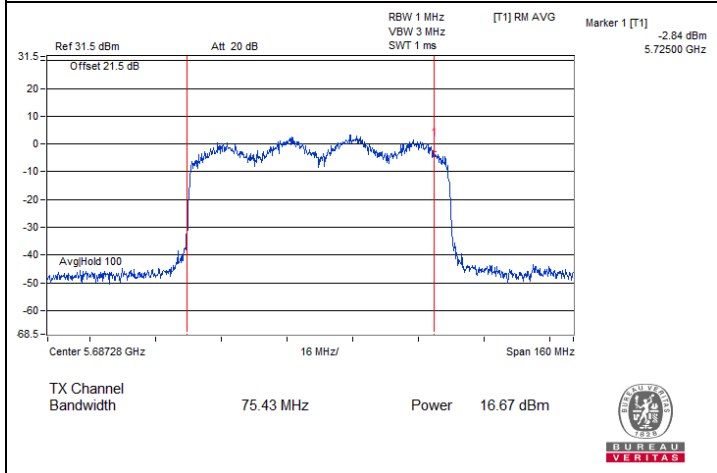

802.11ax (HE80) CDD / Chain 1 : CH 138 (U-NII-2C)

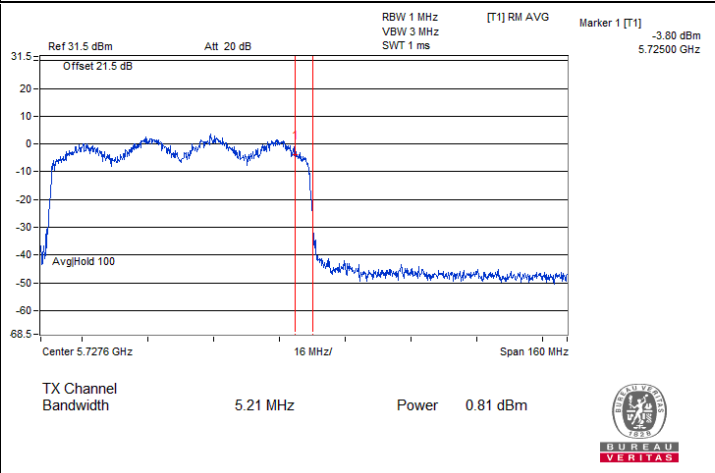

802.11ax (HE80) CDD / Chain 1 : CH 138 (U-NII-3)



Spectrum Plot for channel straddling

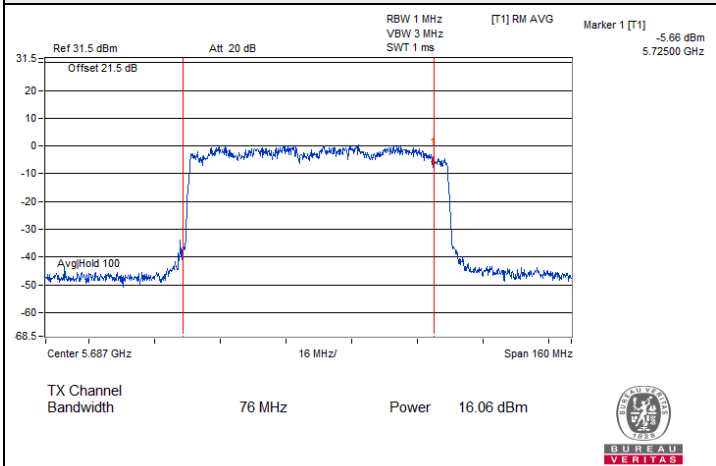

802.11ax (HE80) CDD / Chain 2 : CH 138 (U-NII-2C)

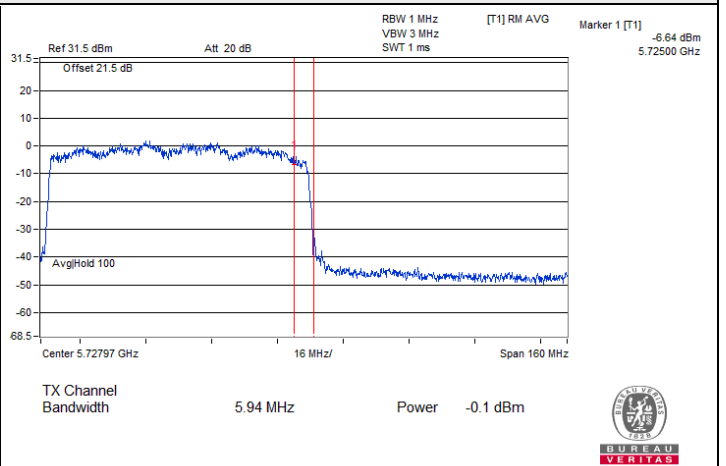

802.11ax (HE80) CDD / Chain 2 : CH 138 (U-NII-3)

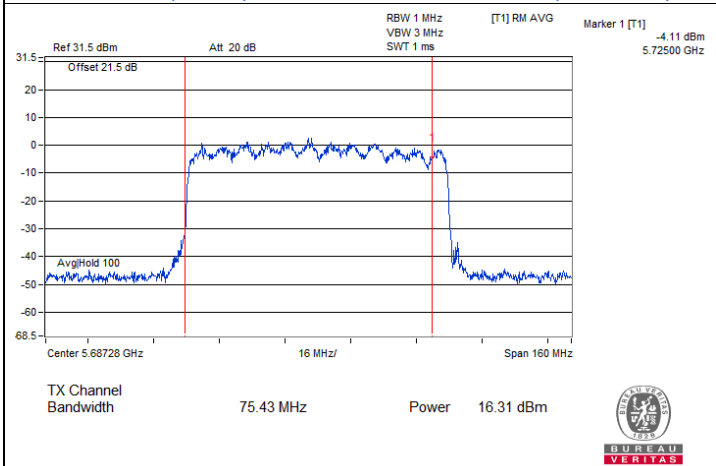

802.11ax (HE80) CDD / Chain 3 : CH 138 (U-NII-2C)

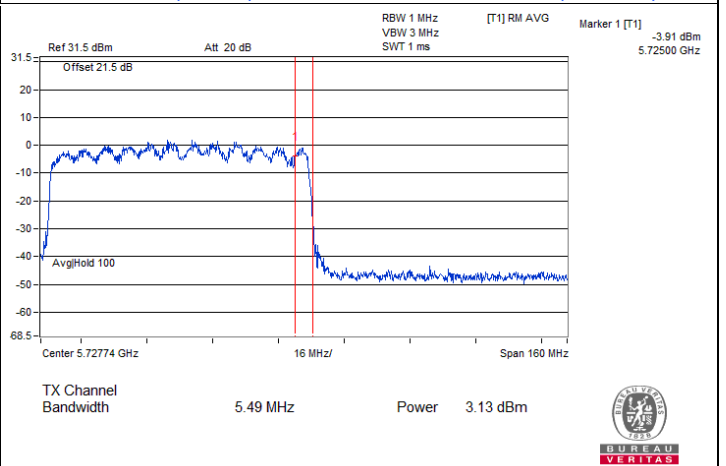

802.11ax (HE80) CDD / Chain 3 : CH 138 (U-NII-3)

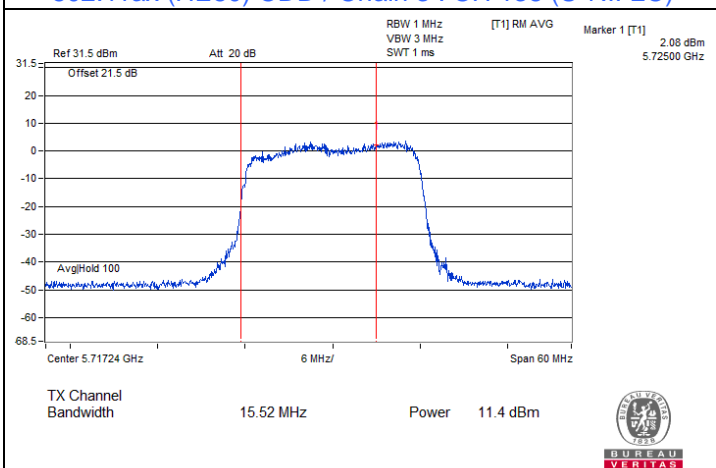

802.11ax (HE20) CDD_RU242 / Chain 0 : CH 144 (U-NII-2C)

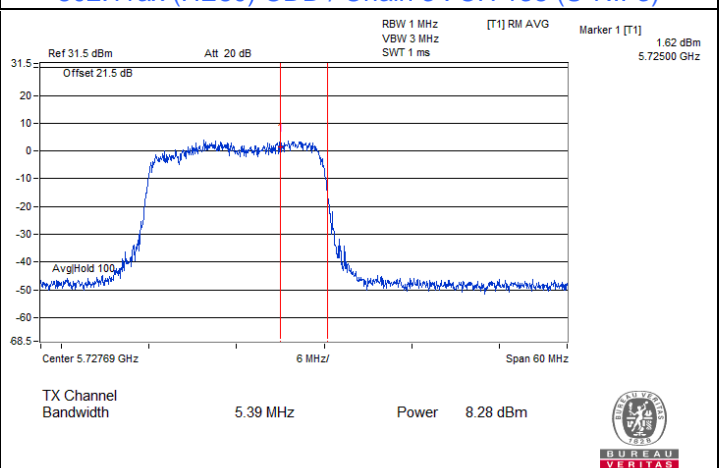

802.11ax (HE20) CDD_RU242 / Chain 0 : CH 144 (U-NII-3)

Spectrum Plot for channel straddling

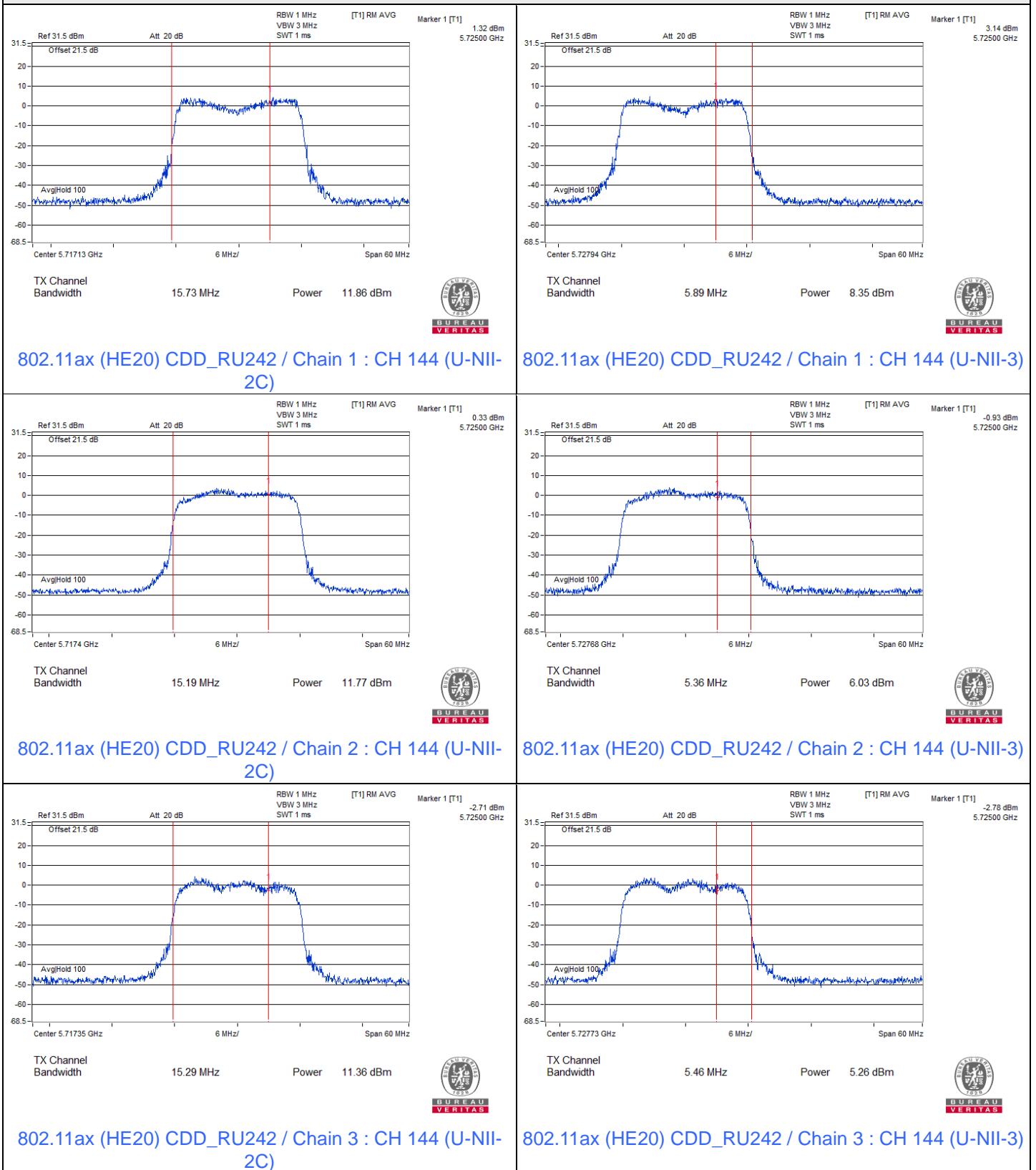

Spectrum Plot for channel straddling

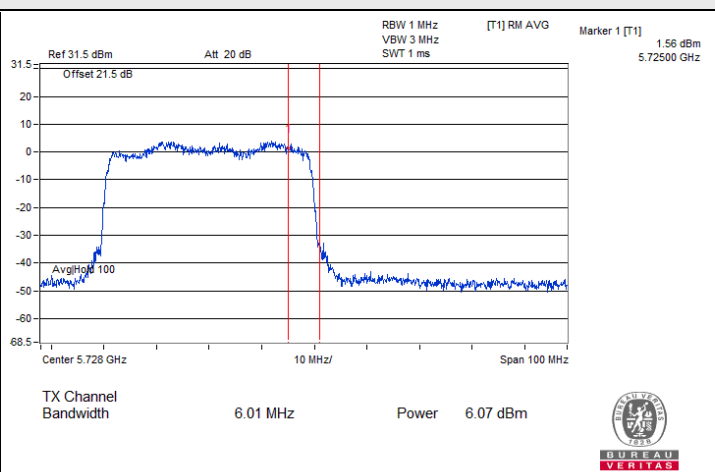
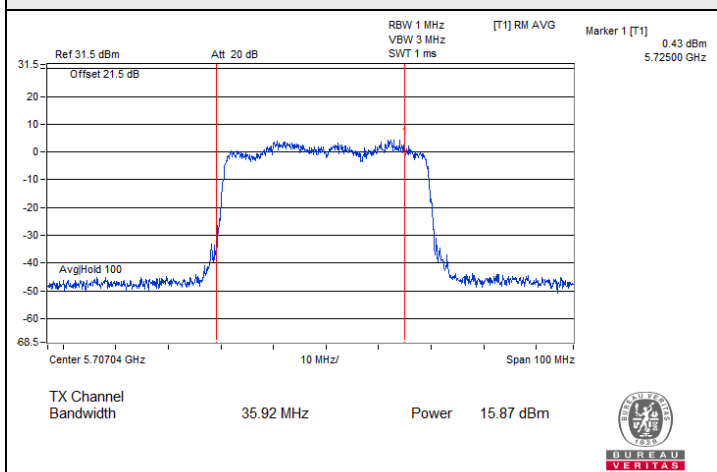

802.11ax (HE40) CDD_RU484 / Chain 0 : CH 142 (U-NII-2C)

802.11ax (HE40) CDD_RU484 / Chain 0 : CH 142 (U-NII-3)

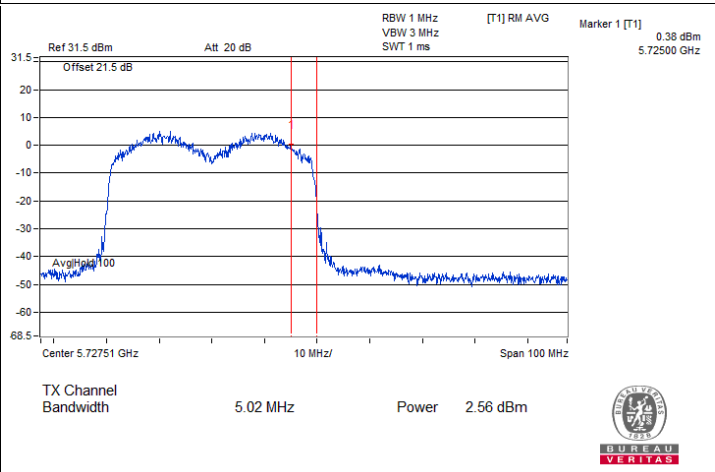
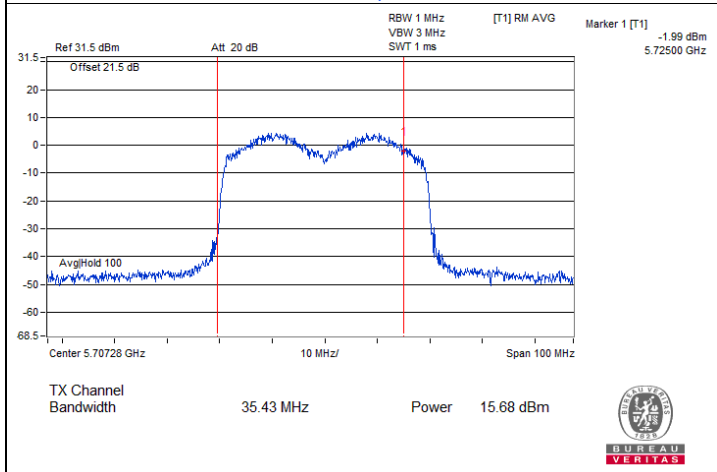

802.11ax (HE40) CDD_RU484 / Chain 1 : CH 142 (U-NII-2C)

802.11ax (HE40) CDD_RU484 / Chain 1 : CH 142 (U-NII-3)

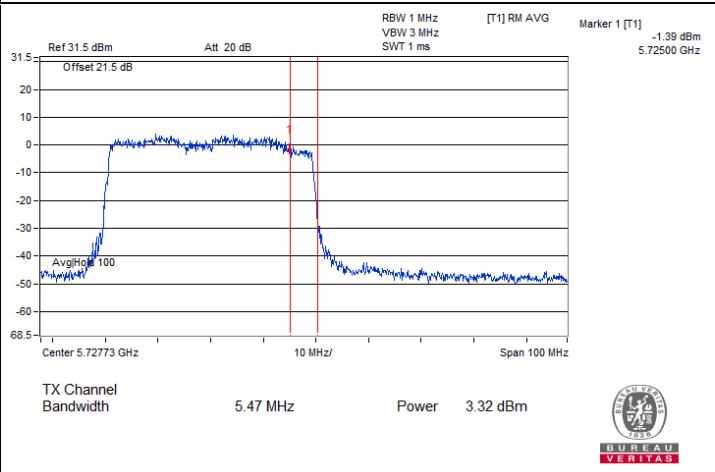
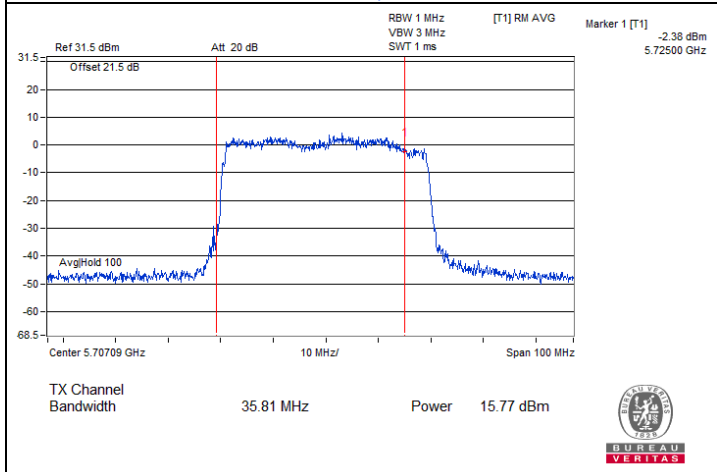

802.11ax (HE40) CDD_RU484 / Chain 2 : CH 142 (U-NII-2C)

802.11ax (HE40) CDD_RU484 / Chain 2 : CH 142 (U-NII-3)

Spectrum Plot for channel straddling

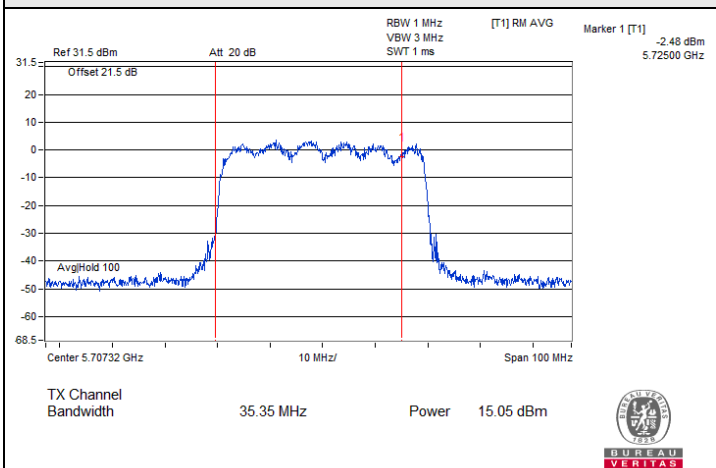

802.11ax (HE40) CDD_RU484 / Chain 3 : CH 142 (U-NII-2C)

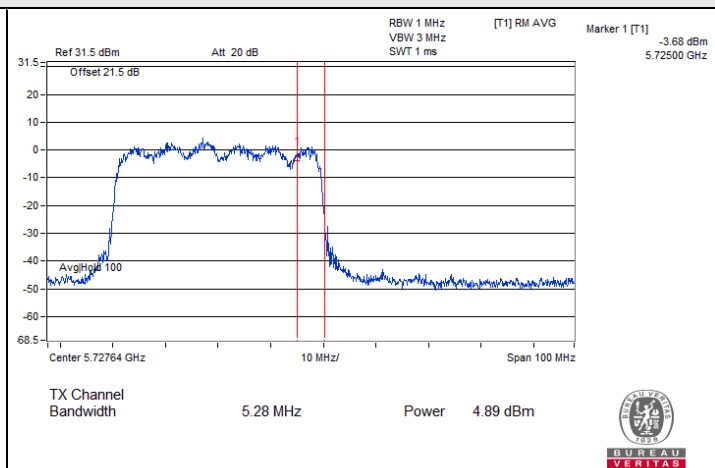

802.11ax (HE40) CDD_RU484 / Chain 3 : CH 142 (U-NII-3)

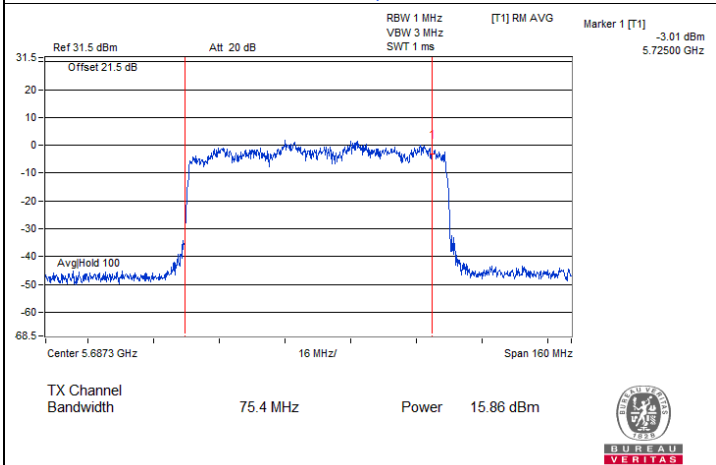

802.11ax (HE80) CDD_RU996 / Chain 0 : CH 138 (U-NII-2C)

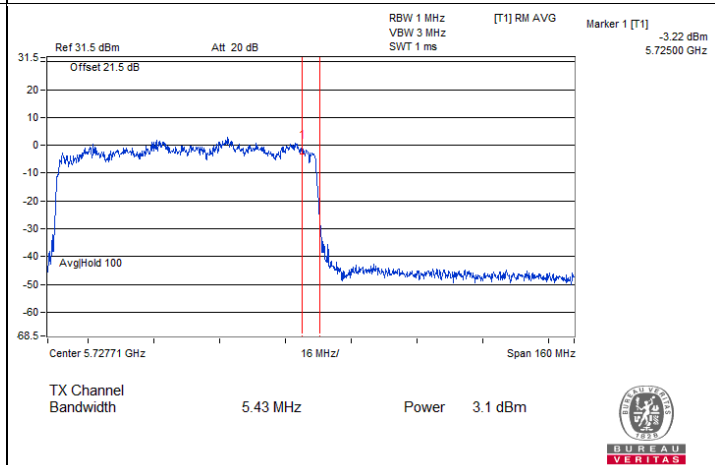

802.11ax (HE80) CDD_RU996 / Chain 0 : CH 138 (U-NII-3)

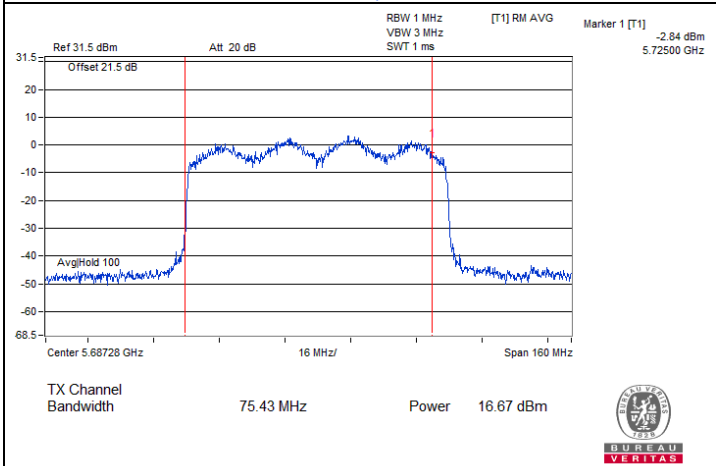

802.11ax (HE80) CDD_RU996 / Chain 1 : CH 138 (U-NII-2C)

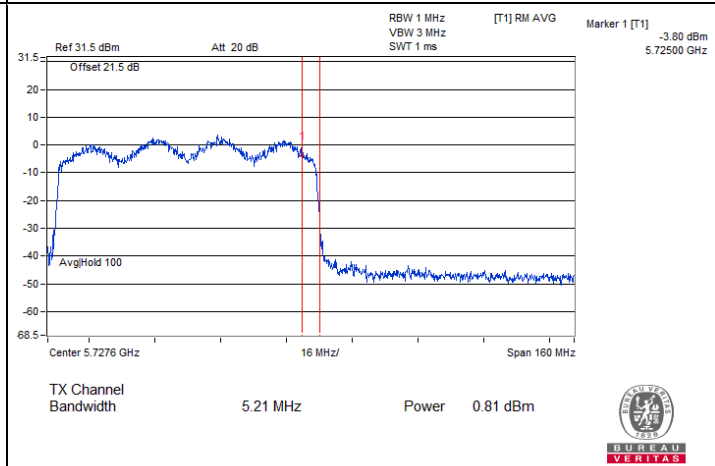

802.11ax (HE80) CDD_RU996 / Chain 1 : CH 138 (U-NII-3)



Spectrum Plot for channel straddling

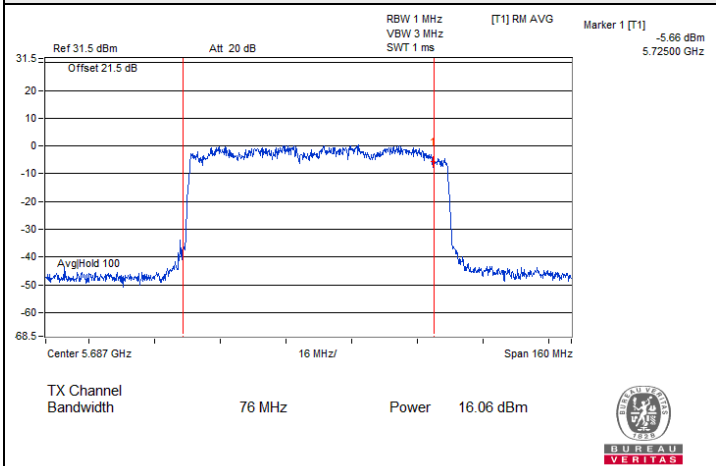

802.11ax (HE80) CDD_RU996 / Chain 2 : CH 138 (U-NII-2C)

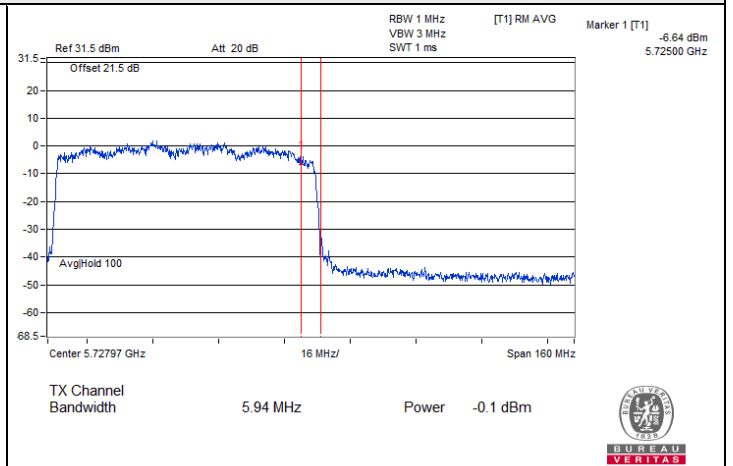

802.11ax (HE80) CDD_RU996 / Chain 2 : CH 138 (U-NII-3)

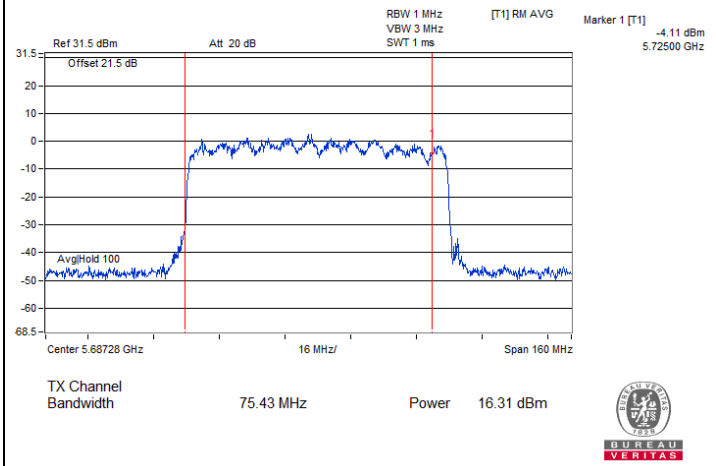

802.11ax (HE80) CDD_RU996 / Chain 3 : CH 138 (U-NII-2C)

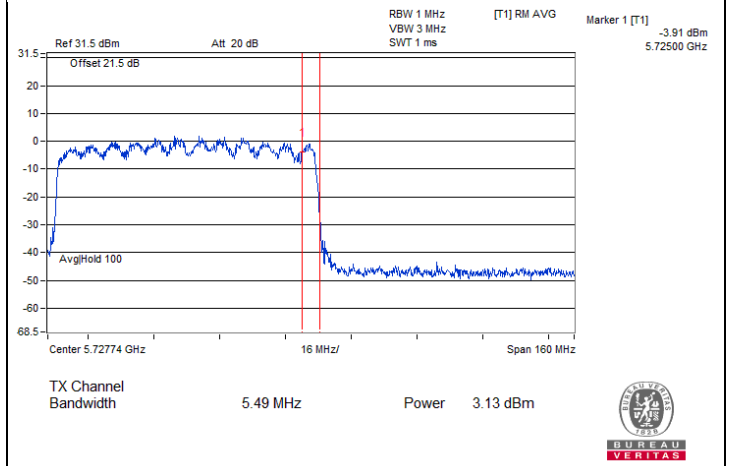

802.11ax (HE80) CDD_RU996 / Chain 3 : CH 138 (U-NII-3)

7.3 Power Spectral Density

| | | | | | |
|--------------|--------|---------------------------|--------------|------------|-----------|
| Input Power: | 12 Vdc | Environmental Conditions: | 25°C, 60% RH | Tested By: | John Peng |
|--------------|--------|---------------------------|--------------|------------|-----------|

802.11a

| Chan. | Chan. Freq. (MHz) | PSD w/o Duty Factor (dBm/MHz) | | | | Duty Factor (dB) | Total PSD (dBm/MHz) | Max. PSD Limit (dBm/MHz) | Test Result |
|----------------|-------------------|-------------------------------|---------|---------|---------|------------------|---------------------|--------------------------|-------------|
| | | Chain 0 | Chain 1 | Chain 2 | Chain 3 | | | | |
| 52 | 5260 | -0.22 | -0.56 | -0.34 | -0.02 | 0.23 | 5.97 | 6.13 | Pass |
| 60 | 5300 | -0.10 | -1.10 | 0.15 | -0.75 | 0.23 | 5.83 | 6.13 | Pass |
| 64 | 5320 | -1.65 | -0.13 | -0.53 | -0.79 | 0.23 | 5.51 | 6.13 | Pass |
| 100 | 5500 | -0.62 | -0.27 | -0.89 | -1.14 | 0.23 | 5.53 | 6.13 | Pass |
| 116 | 5580 | -0.56 | -2.17 | 0.75 | 0.13 | 0.23 | 5.92 | 6.13 | Pass |
| 140 | 5700 | -1.52 | -0.39 | 0.67 | -0.06 | 0.23 | 6.00 | 6.13 | Pass |
| 144 (U-NII-2C) | 5720 | 0.08 | -0.79 | -2.74 | 1.17 | 0.23 | 5.90 | 6.13 | Pass |

Notes:

- Method E) 2) a) of power density measurement of KDB 662911 is using for calculating total power density. Total power density is summing entire spectra across corresponding frequency bins on the various outputs by computer.
- Directional gain = $10 \log[(10^{\text{Chain0}/20} + 10^{\text{Chain1}/20} + 10^{\text{Chain2}/20} + 10^{\text{Chain3}/20})^2 / 4]$
- For U-NII-2A, the directional gain is 10.87 dBi > 6 dBi, so the power density limit shall be reduced to $11 - (10.87 - 6) = 6.13$ dBm/MHz.
- For U-NII-2C, the directional gain is 10.87 dBi > 6 dBi, so the power density limit shall be reduced to $11 - (10.87 - 6) = 6.13$ dBm/MHz.

802.11ax (HE20)

| Chan. | Chan. Freq. (MHz) | PSD w/o Duty Factor (dBm/MHz) | | | | Duty Factor (dB) | Total PSD (dBm/MHz) | Max. PSD Limit (dBm/MHz) | Test Result |
|----------------|-------------------|-------------------------------|---------|---------|---------|------------------|---------------------|--------------------------|-------------|
| | | Chain 0 | Chain 1 | Chain 2 | Chain 3 | | | | |
| 52 | 5260 | -0.38 | -0.30 | -0.64 | -0.60 | 0.26 | 5.80 | 6.13 | Pass |
| 60 | 5300 | -1.95 | -1.10 | -0.66 | -1.72 | 0.26 | 4.95 | 6.13 | Pass |
| 64 | 5320 | -0.90 | -2.28 | -1.07 | -1.16 | 0.26 | 4.96 | 6.13 | Pass |
| 100 | 5500 | -1.15 | -2.04 | -0.82 | -0.86 | 0.26 | 5.09 | 6.13 | Pass |
| 116 | 5580 | -1.94 | -0.73 | -0.59 | 0.21 | 0.26 | 5.58 | 6.13 | Pass |
| 140 | 5700 | -1.45 | -2.09 | -2.74 | 0.10 | 0.26 | 4.87 | 6.13 | Pass |
| 144 (U-NII-2C) | 5720 | -3.17 | -0.34 | -2.19 | 0.25 | 0.26 | 5.13 | 6.13 | Pass |

Notes:

- Method E) 2) a) of power density measurement of KDB 662911 is using for calculating total power density. Total power density is summing entire spectra across corresponding frequency bins on the various outputs by computer.
- Directional gain = $10 \log[(10^{\text{Chain0}/20} + 10^{\text{Chain1}/20} + 10^{\text{Chain2}/20} + 10^{\text{Chain3}/20})^2 / 4]$
- For U-NII-2A, the directional gain is 10.87 dBi > 6 dBi, so the power density limit shall be reduced to $11 - (10.87 - 6) = 6.13$ dBm/MHz.
- For U-NII-2C, the directional gain is 10.87 dBi > 6 dBi, so the power density limit shall be reduced to $11 - (10.87 - 6) = 6.13$ dBm/MHz.

802.11ax (HE40)

| Chan. | Chan. Freq. (MHz) | PSD w/o Duty Factor (dBm/MHz) | | | | Duty Factor (dB) | Total PSD (dBm/MHz) | Max. PSD Limit (dBm/MHz) | Test Result |
|----------------|-------------------|-------------------------------|---------|---------|---------|------------------|---------------------|--------------------------|-------------|
| | | Chain 0 | Chain 1 | Chain 2 | Chain 3 | | | | |
| 54 | 5270 | -1.19 | -1.00 | 0.27 | -0.67 | 0.21 | 5.62 | 6.13 | Pass |
| 62 | 5310 | -1.33 | -0.77 | -0.71 | -1.08 | 0.21 | 5.27 | 6.13 | Pass |
| 102 | 5510 | -0.50 | -1.45 | -0.65 | -0.26 | 0.21 | 5.54 | 6.13 | Pass |
| 110 | 5550 | -0.72 | -0.44 | -0.44 | 0.62 | 0.21 | 6.02 | 6.13 | Pass |
| 134 | 5670 | -0.27 | -0.26 | 0.08 | 0.00 | 0.21 | 6.12 | 6.13 | Pass |
| 142 (U-NII-2C) | 5710 | -0.90 | 0.00 | 0.32 | -0.13 | 0.21 | 6.08 | 6.13 | Pass |

Notes:

- Method E) 2) a) of power density measurement of KDB 662911 is using for calculating total power density. Total power density is summing entire spectra across corresponding frequency bins on the various outputs by computer.
- Directional gain = $10 \log[(10^{\text{Chain0}/20} + 10^{\text{Chain1}/20} + 10^{\text{Chain2}/20} + 10^{\text{Chain3}/20})^2 / 4]$
- For U-NII-2A, the directional gain is 10.87 dBi > 6 dBi, so the power density limit shall be reduced to $11 - (10.87 - 6) = 6.13$ dBm/MHz.
- For U-NII-2C, the directional gain is 10.87 dBi > 6 dBi, so the power density limit shall be reduced to $11 - (10.87 - 6) = 6.13$ dBm/MHz.

802.11ax (HE80)

| Chan. | Chan. Freq. (MHz) | PSD w/o Duty Factor (dBm/MHz) | | | | Duty Factor (dB) | Total PSD (dBm/MHz) | Max. PSD Limit (dBm/MHz) | Test Result |
|----------------|-------------------|-------------------------------|---------|---------|---------|------------------|---------------------|--------------------------|-------------|
| | | Chain 0 | Chain 1 | Chain 2 | Chain 3 | | | | |
| 58 | 5290 | -3.94 | -3.34 | -2.95 | -3.62 | 0.25 | 2.82 | 6.13 | Pass |
| 106 | 5530 | -2.27 | -2.12 | -1.98 | -0.59 | 0.25 | 4.59 | 6.13 | Pass |
| 122 | 5610 | -1.46 | -1.35 | -0.92 | -1.15 | 0.25 | 5.06 | 6.13 | Pass |
| 138 (U-NII-2C) | 5690 | -1.34 | -0.34 | -3.65 | -2.22 | 0.25 | 4.55 | 6.13 | Pass |

Notes:

- Method E) 2) a) of power density measurement of KDB 662911 is using for calculating total power density. Total power density is summing entire spectra across corresponding frequency bins on the various outputs by computer.
- Directional gain = $10 \log[(10^{\text{Chain0}/20} + 10^{\text{Chain1}/20} + 10^{\text{Chain2}/20} + 10^{\text{Chain3}/20})^2 / 4]$
- For U-NII-2A, the directional gain is 10.87 dBi > 6 dBi, so the power density limit shall be reduced to $11 - (10.87 - 6) = 6.13$ dBm/MHz.
- For U-NII-2C, the directional gain is 10.87 dBi > 6 dBi, so the power density limit shall be reduced to $11 - (10.87 - 6) = 6.13$ dBm/MHz.

802.11a

| Chan. | Chan. Freq. (MHz) | PSD w/o Duty Factor (dBm/300kHz) | | | | Total PSD w/o Duty Factor (dBm/300kHz) | Duty Factor (dB) | Total PSD (dBm/500kHz) | PSD Limit (dBm/500kHz) | Test Result |
|---------------|-------------------|----------------------------------|---------|---------|---------|--|------------------|------------------------|------------------------|-------------|
| | | Chain 0 | Chain 1 | Chain 2 | Chain 3 | | | | | |
| 144 (U-NII-3) | 5720 | -8.30 | -5.93 | -7.43 | -5.15 | -0.51 | 0.23 | 1.94 | 25.13 | Pass |

Notes:

- Method E) 2) b) Measure and sum spectral maxima across the outputs of KDB 662911 is using for calculating total power density.
- Directional gain = $10 \log[(10^{\text{Chain0}/20} + 10^{\text{Chain1}/20} + 10^{\text{Chain2}/20} + 10^{\text{Chain3}/20})^2 / 4]$

802.11ax (HE20)

| Chan. | Chan. Freq. (MHz) | PSD w/o Duty Factor (dBm/300kHz) | | | | Total PSD w/o Duty Factor (dBm/300kHz) | Duty Factor (dB) | Total PSD (dBm/500kHz) | PSD Limit (dBm/500kHz) | Test Result |
|---------------|-------------------|----------------------------------|---------|---------|---------|--|------------------|------------------------|------------------------|-------------|
| | | Chain 0 | Chain 1 | Chain 2 | Chain 3 | | | | | |
| 144 (U-NII-3) | 5720 | -5.28 | -4.94 | -7.02 | -6.29 | 0.21 | 0.26 | 2.69 | 25.13 | Pass |

Notes:

- Method E) 2) b) Measure and sum spectral maxima across the outputs of KDB 662911 is using for calculating total power density.
- Directional gain = $10 \log[(10^{\text{Chain0}/20} + 10^{\text{Chain1}/20} + 10^{\text{Chain2}/20} + 10^{\text{Chain3}/20})^2 / 4]$

802.11ax (HE40)

| Chan. | Chan. Freq. (MHz) | PSD w/o Duty Factor (dBm/300kHz) | | | | Total PSD w/o Duty Factor (dBm/300kHz) | Duty Factor (dB) | Total PSD (dBm/500kHz) | PSD Limit (dBm/500kHz) | Test Result |
|---------------|-------------------|----------------------------------|---------|---------|---------|--|------------------|------------------------|------------------------|-------------|
| | | Chain 0 | Chain 1 | Chain 2 | Chain 3 | | | | | |
| 142 (U-NII-3) | 5710 | -6.77 | -10.36 | -8.83 | -6.08 | -1.68 | 0.21 | 0.75 | 25.13 | Pass |

Notes:

- Method E) 2) b) Measure and sum spectral maxima across the outputs of KDB 662911 is using for calculating total power density.
- Directional gain = $10 \log[(10^{\text{Chain0}/20} + 10^{\text{Chain1}/20} + 10^{\text{Chain2}/20} + 10^{\text{Chain3}/20})^2 / 4]$

802.11ax (HE80)

| Chan. | Chan. Freq. (MHz) | PSD w/o Duty Factor (dBm/300kHz) | | | | Total PSD w/o Duty Factor (dBm/300kHz) | Duty Factor (dB) | Total PSD (dBm/500kHz) | PSD Limit (dBm/500kHz) | Test Result |
|---------------|-------------------|----------------------------------|---------|---------|---------|--|------------------|------------------------|------------------------|-------------|
| | | Chain 0 | Chain 1 | Chain 2 | Chain 3 | | | | | |
| 138 (U-NII-3) | 5690 | -9.06 | -10.88 | -12.25 | -9.40 | -4.2 | 0.25 | -1.73 | 25.13 | Pass |

Notes:

- Method E) 2) b) Measure and sum spectral maxima across the outputs of KDB 662911 is using for calculating total power density.
- Directional gain = $10 \log[(10^{\text{Chain0}/20} + 10^{\text{Chain1}/20} + 10^{\text{Chain2}/20} + 10^{\text{Chain3}/20})^2 / 4]$

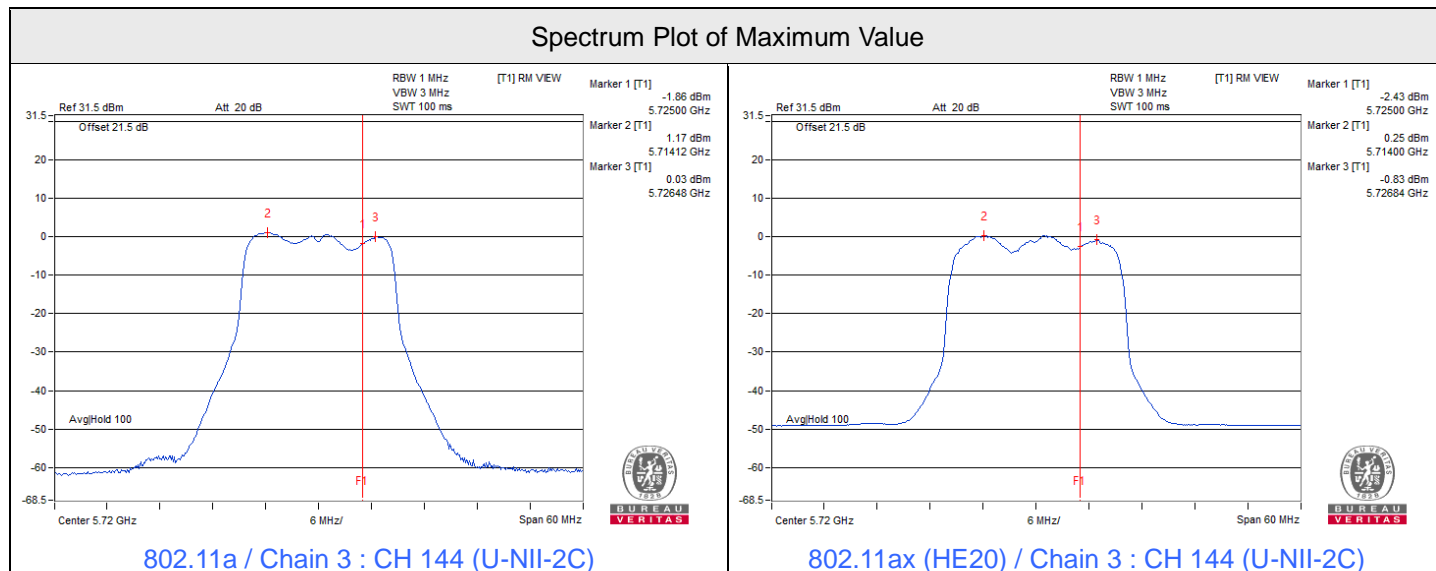

Spectrum Plot of Maximum Value

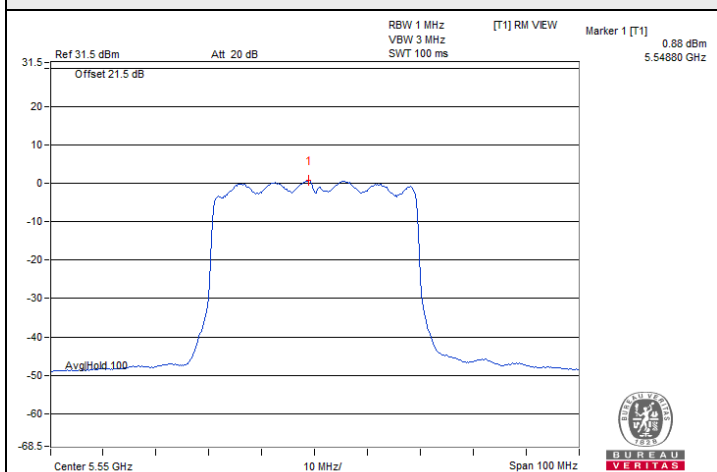

802.11ax (HE40) / Chain 3 : CH 110

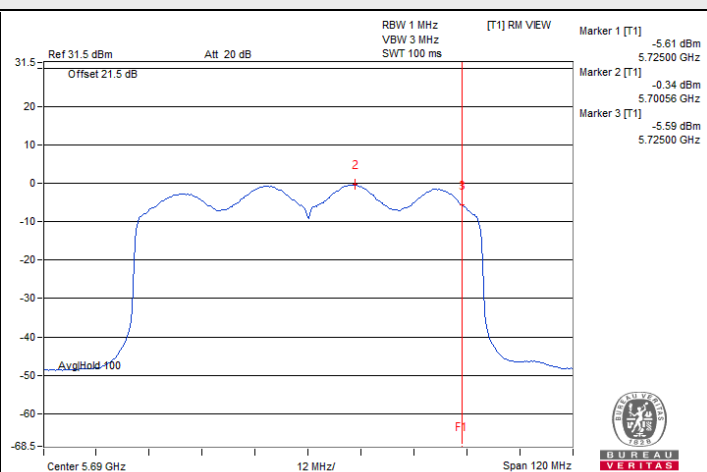

802.11ax (HE80) / Chain 1 : CH 138 (U-NII-2C)

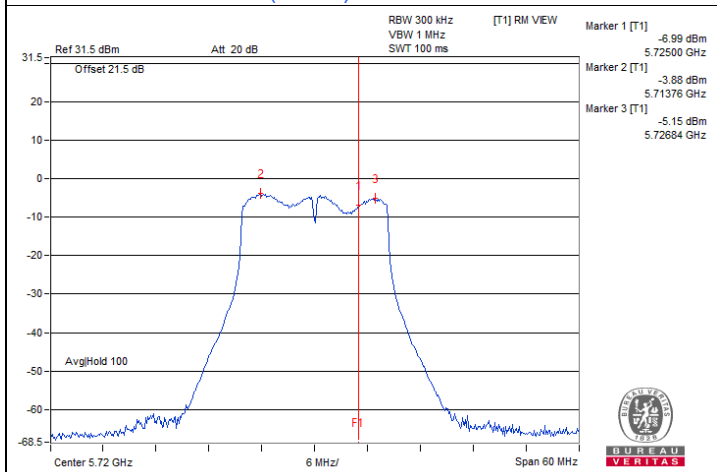

802.11a / Chain 3 : CH 144 (U-NII-3)

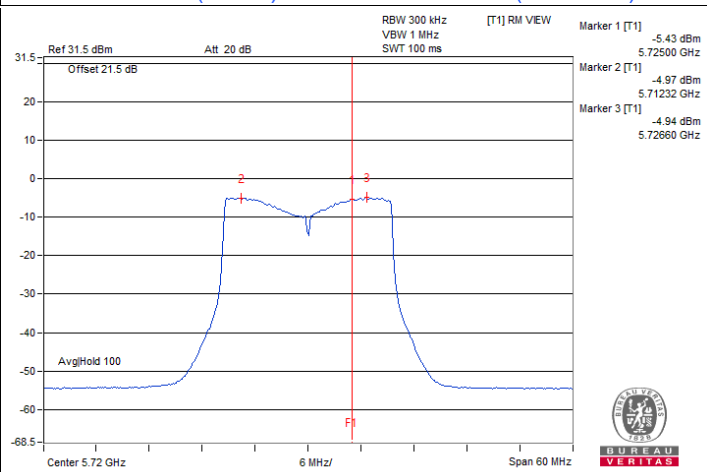

802.11ax (HE20) / Chain 1 : CH 144 (U-NII-3)

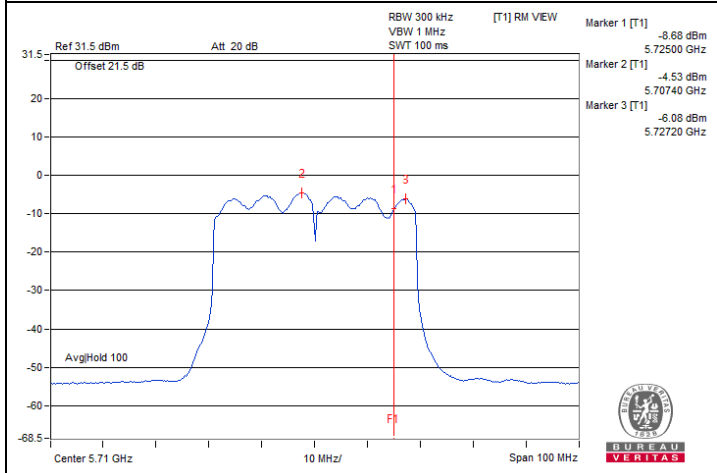

802.11ax (HE40) / Chain 3 : CH 142 (U-NII-3)

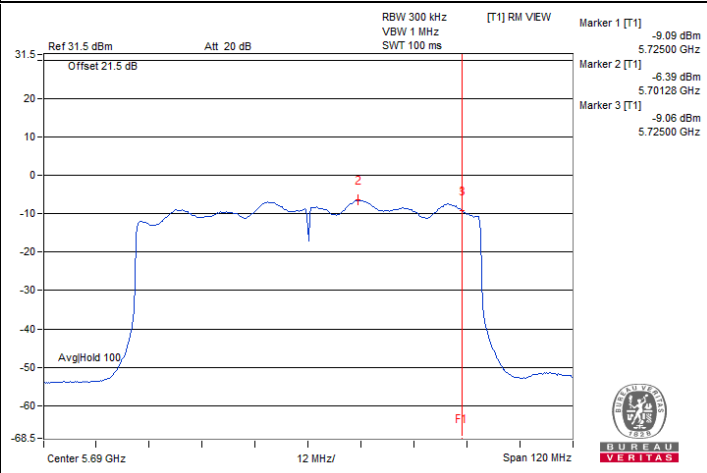

802.11ax (HE80) / Chain 0 : CH 138 (U-NII-3)

7.4 6 dB Bandwidth

| | | | | | |
|--------------|--------|---------------------------|--------------|------------|-----------|
| Input Power: | 12 Vdc | Environmental Conditions: | 25°C, 60% RH | Tested By: | John Peng |
|--------------|--------|---------------------------|--------------|------------|-----------|

802.11a

| Channel | Frequency (MHz) | 6 dB Bandwidth (MHz) | | | | Minimum Limit (MHz) | Test Result |
|---------------|-----------------|----------------------|---------|---------|---------|---------------------|-------------|
| | | Chain 0 | Chain 1 | Chain 2 | Chain 3 | | |
| 144 (U-NII-3) | 5720 | 3.14 | 3.15 | 2.75 | 3.13 | 0.5 | Pass |

802.11ax (HE20)

| Channel | Frequency (MHz) | 6 dB Bandwidth (MHz) | | | | Minimum Limit (MHz) | Test Result |
|---------------|-----------------|----------------------|---------|---------|---------|---------------------|-------------|
| | | Chain 0 | Chain 1 | Chain 2 | Chain 3 | | |
| 144 (U-NII-3) | 5720 | 4.41 | 4.44 | 4.42 | 3.80 | 0.5 | Pass |

802.11ax (HE40)

| Channel | Frequency (MHz) | 6 dB Bandwidth (MHz) | | | | Minimum Limit (MHz) | Test Result |
|---------------|-----------------|----------------------|---------|---------|---------|---------------------|-------------|
| | | Chain 0 | Chain 1 | Chain 2 | Chain 3 | | |
| 142 (U-NII-3) | 5710 | 4.01 | 3.40 | 3.47 | 3.70 | 0.5 | Pass |

802.11ax (HE80)

| Channel | Frequency (MHz) | 6 dB Bandwidth (MHz) | | | | Minimum Limit (MHz) | Test Result |
|---------------|-----------------|----------------------|---------|---------|---------|---------------------|-------------|
| | | Chain 0 | Chain 1 | Chain 2 | Chain 3 | | |
| 138 (U-NII-3) | 5690 | 3.64 | 2.52 | 3.52 | 3.23 | 0.5 | Pass |

Spectrum Plot of Minimum Value

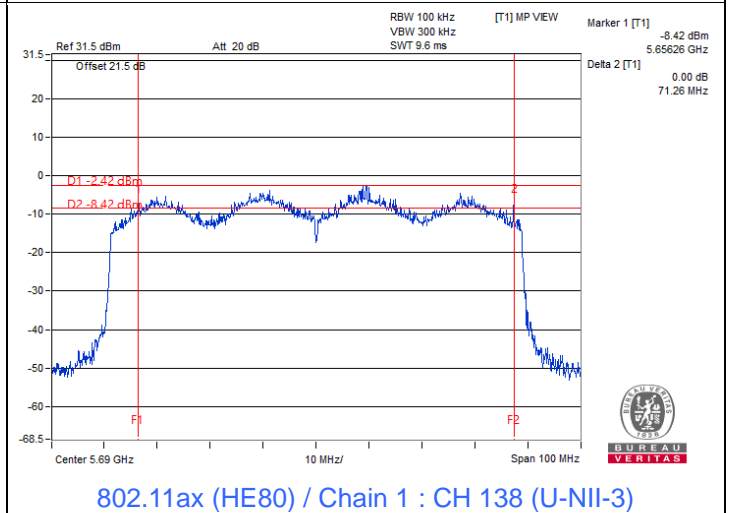
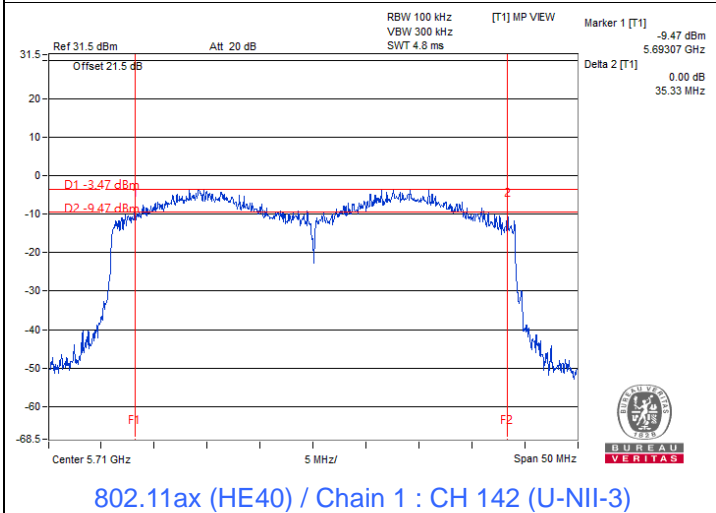
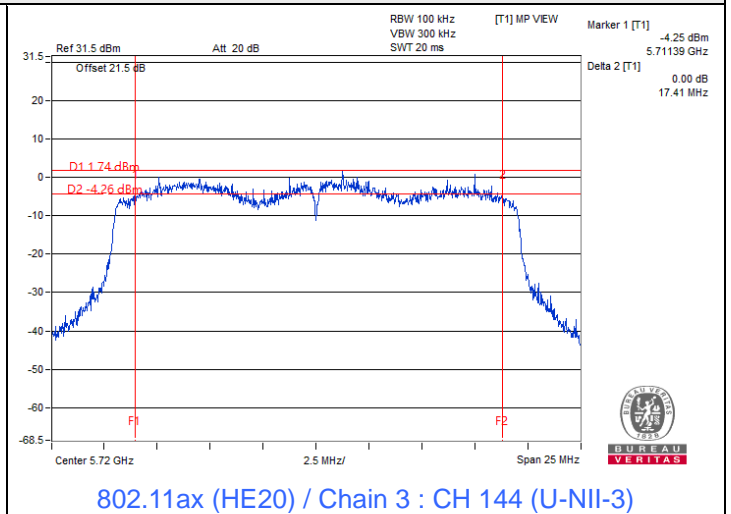
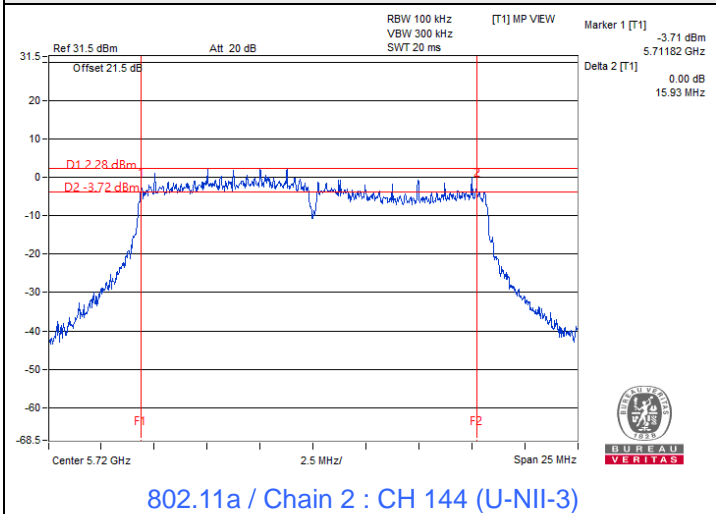

Notes:

1. For U-NII-3 straddle channel = Marker 1 + Delta 2 - 5725 MHz

7.5 Occupied Bandwidth

| | | | | | |
|--------------|--------|---------------------------|--------------|------------|-----------|
| Input Power: | 12 Vdc | Environmental Conditions: | 25°C, 60% RH | Tested By: | John Peng |
|--------------|--------|---------------------------|--------------|------------|-----------|

802.11a

| Channel | Frequency (MHz) | Occupied Bandwidth (MHz) | | | |
|----------------|-----------------|--------------------------|---------|---------|---------|
| | | Chain 0 | Chain 1 | Chain 2 | Chain 3 |
| 52 | 5260 | 16.56 | 16.50 | 16.50 | 16.38 |
| 60 | 5300 | 16.38 | 16.56 | 16.32 | 16.38 |
| 64 | 5320 | 16.50 | 16.32 | 16.32 | 16.50 |
| 100 | 5500 | 16.44 | 16.44 | 16.50 | 16.38 |
| 116 | 5580 | 16.44 | 16.38 | 16.44 | 16.44 |
| 140 | 5700 | 16.38 | 16.32 | 16.50 | 16.44 |
| 144 (U-NII-2C) | 5720 | 13.22 | 13.16 | 13.28 | 13.28 |
| 144 (U-NII-3) | 5720 | 3.22 | 3.28 | 3.22 | 3.16 |

802.11ax (HE20)

| Channel | Frequency (MHz) | Occupied Bandwidth (MHz) | | | |
|----------------|-----------------|--------------------------|---------|---------|---------|
| | | Chain 0 | Chain 1 | Chain 2 | Chain 3 |
| 52 | 5260 | 19.02 | 18.96 | 18.96 | 18.90 |
| 60 | 5300 | 18.84 | 18.90 | 18.90 | 18.90 |
| 64 | 5320 | 18.96 | 18.90 | 18.96 | 18.84 |
| 100 | 5500 | 18.96 | 19.02 | 18.90 | 18.90 |
| 116 | 5580 | 18.84 | 18.84 | 18.84 | 18.90 |
| 140 | 5700 | 18.90 | 19.14 | 18.90 | 18.96 |
| 144 (U-NII-2C) | 5720 | 14.48 | 14.54 | 14.42 | 14.42 |
| 144 (U-NII-3) | 5720 | 4.42 | 4.48 | 4.48 | 4.42 |

802.11ax (HE40)

| Channel | Frequency (MHz) | Occupied Bandwidth (MHz) | | | |
|----------------|-----------------|--------------------------|---------|---------|---------|
| | | Chain 0 | Chain 1 | Chain 2 | Chain 3 |
| 54 | 5270 | 37.80 | 38.04 | 37.92 | 37.80 |
| 62 | 5310 | 37.80 | 37.92 | 37.92 | 37.80 |
| 102 | 5510 | 38.04 | 38.04 | 37.80 | 37.92 |
| 110 | 5550 | 38.04 | 37.80 | 37.92 | 38.16 |
| 134 | 5670 | 38.04 | 37.44 | 37.92 | 37.68 |
| 142 (U-NII-2C) | 5710 | 33.84 | 33.48 | 33.96 | 33.72 |
| 142 (U-NII-3) | 5710 | 3.96 | 3.48 | 3.84 | 3.96 |



802.11ax (HE80)

| Channel | Frequency (MHz) | Occupied Bandwidth (MHz) | | | |
|----------------|-----------------|--------------------------|---------|---------|---------|
| | | Chain 0 | Chain 1 | Chain 2 | Chain 3 |
| 58 | 5290 | 76.80 | 77.04 | 77.04 | 77.28 |
| 106 | 5530 | 77.28 | 77.04 | 76.56 | 77.28 |
| 122 | 5610 | 77.04 | 76.32 | 77.04 | 77.52 |
| 138 (U-NII-2C) | 5690 | 73.40 | 72.92 | 73.64 | 73.40 |
| 138 (U-NII-3) | 5690 | 3.64 | 3.16 | 3.16 | 3.64 |

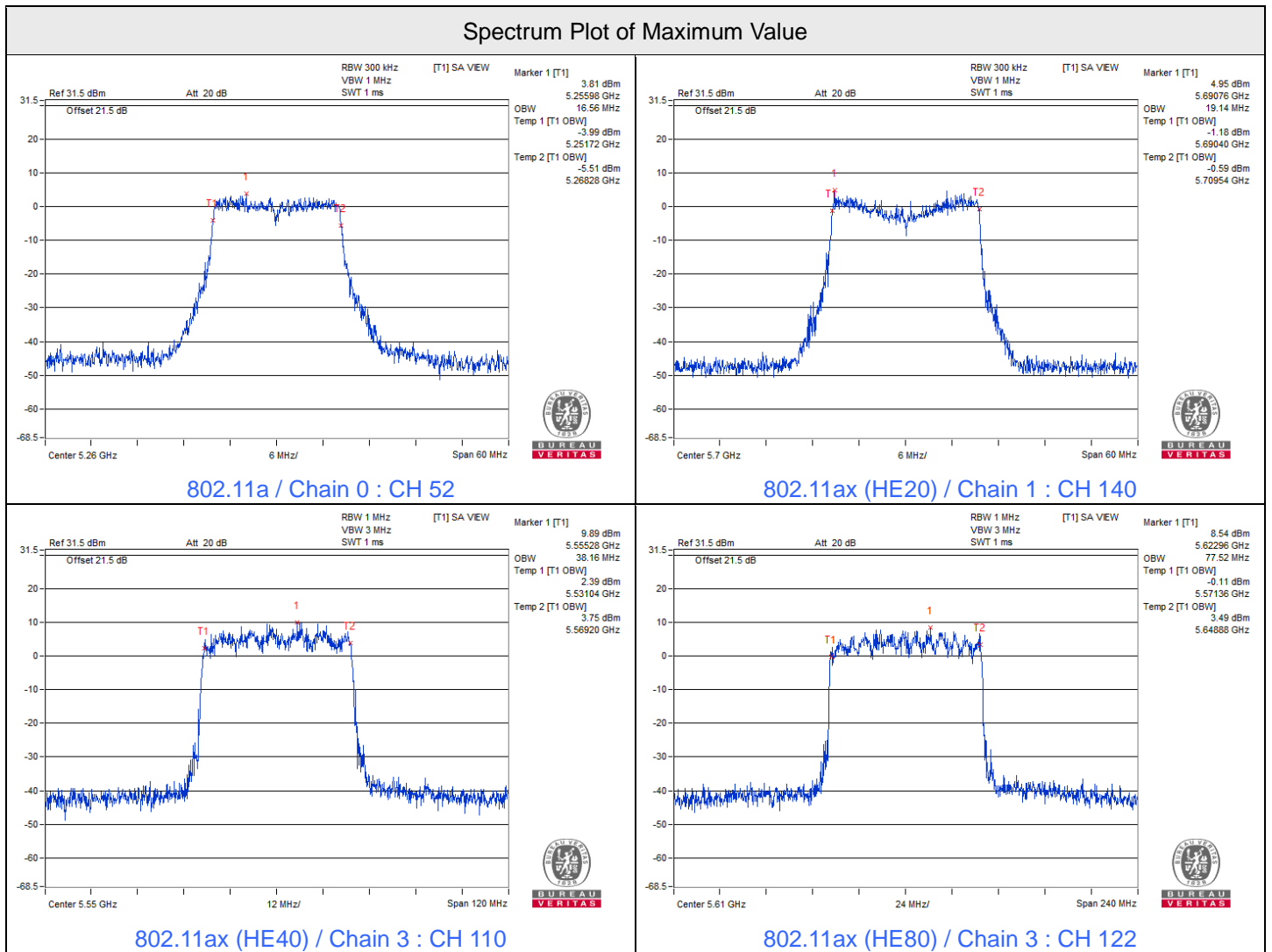

7.6 Frequency Stability

| | | | | | |
|--------------|--------|---------------------------|--------------|------------|-----------|
| Input Power: | 12 Vdc | Environmental Conditions: | 25°C, 60% RH | Tested By: | John Peng |
|--------------|--------|---------------------------|--------------|------------|-----------|

802.11a

| Frequency Stability Versus Temperature | | | | | | | | | |
|--|--------------------|--------------------------|-------------|--------------------------|-------------|--------------------------|-------------|--------------------------|-------------|
| Operating Frequency: 5260 MHz | | | | | | | | | |
| Temp. (°C) | Power Supply (Vdc) | 0 Minute | | 2 Minutes | | 5 Minutes | | 10 Minutes | |
| | | Measured Frequency (MHz) | Test Result | Measured Frequency (MHz) | Test Result | Measured Frequency (MHz) | Test Result | Measured Frequency (MHz) | Test Result |
| 50 | 12 | 5260.0184 | Pass | 5260.0172 | Pass | 5260.0193 | Pass | 5260.0183 | Pass |
| 40 | 12 | 5260.0045 | Pass | 5260.0003 | Pass | 5260.0038 | Pass | 5260.0038 | Pass |
| 30 | 12 | 5259.9949 | Pass | 5259.9976 | Pass | 5259.9946 | Pass | 5259.997 | Pass |
| 20 | 12 | 5260.0181 | Pass | 5260.0199 | Pass | 5260.0185 | Pass | 5260.0189 | Pass |
| 10 | 12 | 5259.9827 | Pass | 5259.9825 | Pass | 5259.9818 | Pass | 5259.9798 | Pass |
| 0 | 12 | 5259.9905 | Pass | 5259.9875 | Pass | 5259.99 | Pass | 5259.9906 | Pass |

| Frequency Stability Versus Voltage | | | | | | | | | |
|------------------------------------|--------------------|--------------------------|-------------|--------------------------|-------------|--------------------------|-------------|--------------------------|-------------|
| Operating Frequency: 5260 MHz | | | | | | | | | |
| Temp. (°C) | Power Supply (Vdc) | 0 Minute | | 2 Minutes | | 5 Minutes | | 10 Minutes | |
| | | Measured Frequency (MHz) | Test Result | Measured Frequency (MHz) | Test Result | Measured Frequency (MHz) | Test Result | Measured Frequency (MHz) | Test Result |
| 20 | 13.8 | 5260.0237 | Pass | 5260.024 | Pass | 5260.0202 | Pass | 5260.0224 | Pass |
| | 12 | 5260.0181 | Pass | 5260.0199 | Pass | 5260.0185 | Pass | 5260.0189 | Pass |
| | 10.2 | 5260.0238 | Pass | 5260.0248 | Pass | 5260.0243 | Pass | 5260.0272 | Pass |

7.7 AC Power Conducted Emissions

| | | | |
|----------------------|------------------|--|---------------------------------------|
| RF Mode | 802.11ax (HE20) | Channel | CH 144 : 5720 MHz |
| Frequency Range | 150 kHz ~ 30 MHz | Detector Function & Resolution Bandwidth | Quasi-Peak (QP) / Average (AV), 9 kHz |
| Input Power (System) | 56 Vdc | Environmental Conditions | 25°C, 75% RH |
| Tested By | Sampson Chen | | |

| Phase Of Power : Line (L) | | | | | | | | | | |
|---------------------------|-----------------|------------------------|----------------------|--------------|-----------------------|--------------|--------------|--------------|---------------|--------------|
| No | Frequency (MHz) | Correction Factor (dB) | Reading Value (dBuV) | | Emission Level (dBuV) | | Limit (dBuV) | | Margin (dB) | |
| | | | Q.P. | AV. | Q.P. | AV. | Q.P. | AV. | Q.P. | AV. |
| 1 | 0.15781 | 9.96 | 33.16 | 22.26 | 43.12 | 32.22 | 65.58 | 55.58 | -22.46 | -23.36 |
| 2 | 0.18516 | 9.96 | 29.21 | 22.08 | 39.17 | 32.04 | 64.25 | 54.25 | -25.08 | -22.21 |
| 3 | 0.22031 | 9.96 | 21.61 | 12.32 | 31.57 | 22.28 | 62.81 | 52.81 | -31.24 | -30.53 |
| 4 | 0.47422 | 9.97 | 32.18 | 29.91 | 42.15 | 39.88 | 56.44 | 46.44 | -14.29 | -6.56 |
| 5 | 11.60156 | 10.59 | 31.32 | 29.65 | 41.91 | 40.24 | 60.00 | 50.00 | -18.09 | -9.76 |
| 6 | 27.72266 | 11.22 | 27.76 | 20.21 | 38.98 | 31.43 | 60.00 | 50.00 | -21.02 | -18.57 |

Remarks:

1. Q.P. and AV. are abbreviations of quasi-peak and average individually.
2. The emission levels of other frequencies were very low against the limit.
3. Margin value = Emission level – Limit value
4. Correction factor = Insertion loss + Cable loss
5. Emission Level = Correction Factor + Reading Value

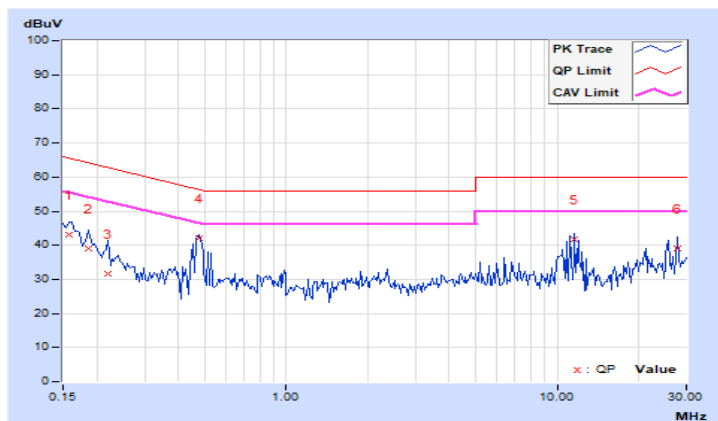

| | | | |
|-----------------------------|------------------|---|---------------------------------------|
| RF Mode | 802.11ax (HE20) | Channel | CH 144 : 5720 MHz |
| Frequency Range | 150 kHz ~ 30 MHz | Detector Function & Resolution Bandwidth | Quasi-Peak (QP) / Average (AV), 9 kHz |
| Input Power (System) | 56 Vdc | Environmental Conditions | 25°C, 75% RH |
| Tested By | Sampson Chen | | |

| Phase Of Power : Neutral (N) | | | | | | | | | | |
|------------------------------|-----------------|------------------------|----------------------|-------|-----------------------|-------|--------------|-------|-------------|--------|
| No | Frequency (MHz) | Correction Factor (dB) | Reading Value (dBuV) | | Emission Level (dBuV) | | Limit (dBuV) | | Margin (dB) | |
| | | | Q.P. | AV. | Q.P. | AV. | Q.P. | AV. | Q.P. | AV. |
| 1 | 0.15000 | 9.93 | 36.25 | 23.35 | 46.18 | 33.28 | 66.00 | 56.00 | -19.82 | -22.72 |
| 2 | 0.18906 | 9.94 | 29.51 | 19.87 | 39.45 | 29.81 | 64.08 | 54.08 | -24.63 | -24.27 |
| 3 | 0.27109 | 9.94 | 19.14 | 10.15 | 29.08 | 20.09 | 61.08 | 51.08 | -32.00 | -30.99 |
| 4 | 0.47422 | 9.94 | 31.20 | 29.16 | 41.14 | 39.10 | 56.44 | 46.44 | -15.30 | -7.34 |
| 5 | 11.60547 | 10.45 | 31.73 | 27.79 | 42.18 | 38.24 | 60.00 | 50.00 | -17.82 | -11.76 |
| 6 | 25.87500 | 10.86 | 30.62 | 29.91 | 41.48 | 40.77 | 60.00 | 50.00 | -18.52 | -9.23 |

Remarks:

1. Q.P. and AV. are abbreviations of quasi-peak and average individually.
2. The emission levels of other frequencies were very low against the limit.
3. Margin value = Emission level – Limit value
4. Correction factor = Insertion loss + Cable loss
5. Emission Level = Correction Factor + Reading Value

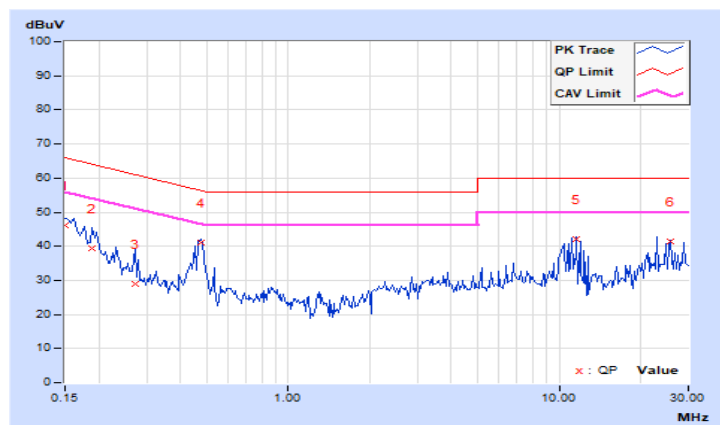

7.8 Unwanted Emissions below 1 GHz

| | | | |
|----------------------|----------------|-------------------------------|-------------------|
| RF Mode | RX | Channel | CH 144 : 5720 MHz |
| Frequency Range | 30 MHz ~ 1 GHz | Detector Function & Bandwidth | (QP) RB = 120kHz |
| Input Power (System) | 56 Vdc | Environmental Conditions | 21°C, 69% RH |
| Tested By | Carter Lin | | |

Antenna Polarity & Test Distance : Horizontal at 3 m

| No | Frequency (MHz) | Emission Level (dBuV/m) | Limit (dBuV/m) | Margin (dB) | Antenna Height (m) | Table Angle (Degree) | Raw Value (dBuV) | Correction Factor (dB/m) |
|----|-----------------|-------------------------|----------------|-------------|--------------------|----------------------|------------------|--------------------------|
| 1 | 31.98 | 27.5 QP | 40.0 | -12.5 | 1.00 H | 280 | 40.7 | -13.2 |
| 2 | 111.75 | 28.1 QP | 43.5 | -15.4 | 1.50 H | 272 | 42.7 | -14.6 |
| 3 | 186.08 | 31.5 QP | 43.5 | -12.0 | 1.50 H | 251 | 45.3 | -13.8 |
| 4 | 335.98 | 33.7 QP | 46.0 | -12.3 | 1.00 H | 55 | 43.0 | -9.3 |
| 5 | 834.79 | 34.3 QP | 46.0 | -11.7 | 2.00 H | 324 | 31.7 | 2.6 |
| 6 | 999.56 | 40.9 QP | 54.0 | -13.1 | 1.50 H | 314 | 35.5 | 5.4 |

Remarks:

1. Emission Level(dBuV/m) = Raw Value(dBuV) + Correction Factor(dB/m)
2. Correction Factor(dB/m) = Antenna Factor(dB/m) + Cable Factor(dB) – Pre-Amplifier Factor(dB)
3. Margin value = Emission Level – Limit value
4. The other emission levels were very low against the limit of frequency range 30 MHz ~ 1 GHz.
5. The emission levels were very low against the limit of frequency range 9 kHz ~ 30 MHz: the amplitude of spurious emissions attenuated more than 20 dB below the permissible value to be report.

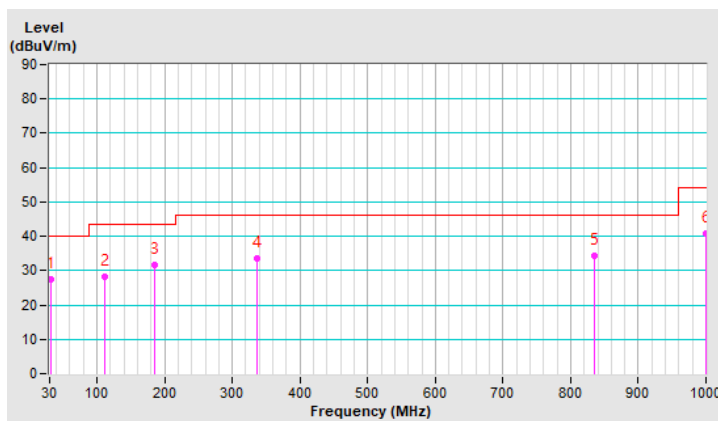

| | | | |
|-----------------------------|----------------|--|-------------------|
| RF Mode | RX | Channel | CH 144 : 5720 MHz |
| Frequency Range | 30 MHz ~ 1 GHz | Detector Function & Bandwidth | (QP) RB = 120kHz |
| Input Power (System) | 56 Vdc | Environmental Conditions | 21°C, 69% RH |
| Tested By | Carter Lin | | |

| Antenna Polarity & Test Distance : Vertical at 3 m | | | | | | | | |
|--|-----------------|-------------------------|----------------|-------------|--------------------|----------------------|------------------|--------------------------|
| No | Frequency (MHz) | Emission Level (dBuV/m) | Limit (dBuV/m) | Margin (dB) | Antenna Height (m) | Table Angle (Degree) | Raw Value (dBuV) | Correction Factor (dB/m) |
| 1 | 60.36 | 24.5 QP | 40.0 | -15.5 | 1.50 V | 36 | 37.3 | -12.8 |
| 2 | 119.81 | 27.0 QP | 43.5 | -16.5 | 1.50 V | 265 | 40.8 | -13.8 |
| 3 | 285.15 | 26.2 QP | 46.0 | -19.8 | 1.00 V | 301 | 37.0 | -10.8 |
| 4 | 359.89 | 32.4 QP | 46.0 | -13.6 | 1.00 V | 34 | 41.1 | -8.7 |
| 5 | 749.51 | 32.5 QP | 46.0 | -13.5 | 1.50 V | 264 | 31.4 | 1.1 |
| 6 | 907.49 | 35.0 QP | 46.0 | -11.0 | 2.00 V | 346 | 31.1 | 3.9 |

Remarks:

1. Emission Level(dBuV/m) = Raw Value(dBuV) + Correction Factor(dB/m)
2. Correction Factor(dB/m) = Antenna Factor(dB/m) + Cable Factor(dB) – Pre-Amplifier Factor(dB)
3. Margin value = Emission Level – Limit value
4. The other emission levels were very low against the limit of frequency range 30 MHz ~ 1 GHz.
5. The emission levels were very low against the limit of frequency range 9 kHz ~ 30 MHz: the amplitude of spurious emissions attenuated more than 20 dB below the permissible value to be report.

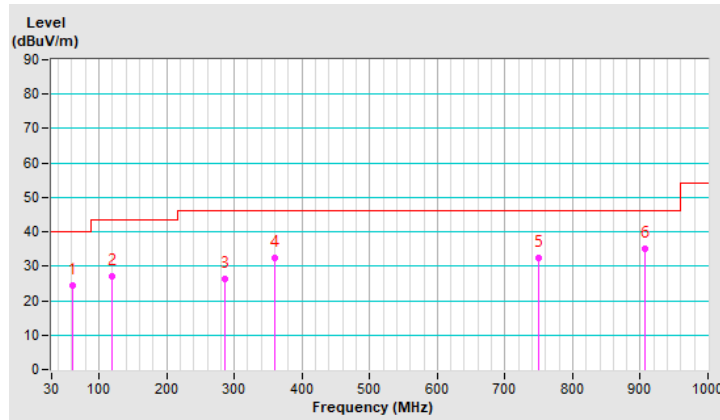

7.9 Unwanted Emissions above 1 GHz

| | | | |
|-----------------------------|----------------|--|---|
| RF Mode | 802.11a | Channel | CH 52 : 5260 MHz |
| Frequency Range | 1 GHz ~ 40 GHz | Detector Function & Bandwidth | (PK) RB = 1 MHz, VB = 3 MHz (AV) RB = 1 MHz, VB = 200 Hz |
| Input Power (System) | 56 Vdc | Environmental Conditions | 25°C, 75% RH |
| Tested By | Tom Yang | | |

| Antenna Polarity & Test Distance : Horizontal at 3 m | | | | | | | | |
|--|-----------------|-------------------------|----------------|-------------|--------------------|----------------------|------------------|--------------------------|
| No | Frequency (MHz) | Emission Level (dBuV/m) | Limit (dBuV/m) | Margin (dB) | Antenna Height (m) | Table Angle (Degree) | Raw Value (dBuV) | Correction Factor (dB/m) |
| 1 | 5150.00 | 51.3 PK | 74.0 | -22.7 | 2.36 H | 71 | 49.9 | 1.4 |
| 2 | 5150.00 | 38.7 AV | 54.0 | -15.3 | 2.36 H | 71 | 37.3 | 1.4 |
| 3 | *5260.00 | 117.0 PK | | | 2.36 H | 71 | 116.2 | 0.8 |
| 4 | *5260.00 | 107.6 AV | | | 2.36 H | 71 | 106.8 | 0.8 |
| 5 | #10520.00 | 59.5 PK | 68.2 | -8.7 | 3.14 H | 158 | 48.3 | 11.2 |
| 6 | 15780.00 | 56.5 PK | 74.0 | -17.5 | 3.05 H | 261 | 45.2 | 11.3 |
| 7 | 15780.00 | 45.2 AV | 54.0 | -8.8 | 3.05 H | 261 | 33.9 | 11.3 |

Remarks:

1. Emission Level(dBuV/m) = Raw Value(dBuV) + Correction Factor(dB/m)
2. Correction Factor(dB/m) = Antenna Factor(dB/m) + Cable Factor(dB) – Pre-Amplifier Factor(dB)
3. Margin value = Emission Level – Limit value
4. The other emission levels were very low against the limit.
5. " * ": Fundamental frequency, the limit was restricted at the RF Output Power.
6. " # ": The radiated frequency is out of the restricted band.

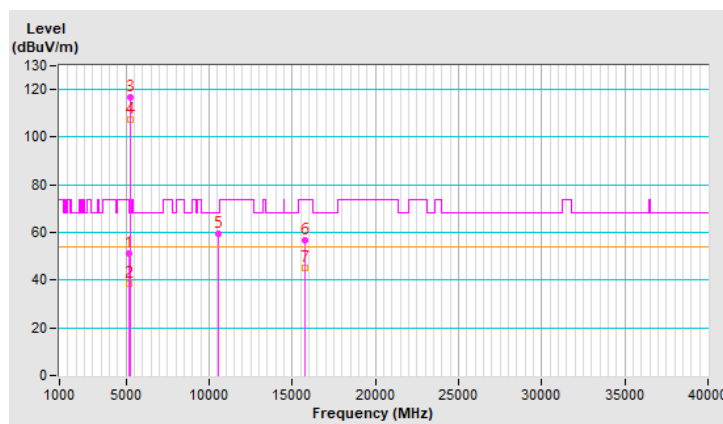

| | | | |
|-----------------------------|----------------|--|---|
| RF Mode | 802.11a | Channel | CH 52 : 5260 MHz |
| Frequency Range | 1 GHz ~ 40 GHz | Detector Function & Bandwidth | (PK) RB = 1 MHz, VB = 3 MHz (AV) RB = 1 MHz, VB = 200 Hz |
| Input Power (System) | 56 Vdc | Environmental Conditions | 25°C, 75% RH |
| Tested By | Tom Yang | | |

| Antenna Polarity & Test Distance : Vertical at 3 m | | | | | | | | |
|--|-----------------|-------------------------|----------------|-------------|--------------------|----------------------|------------------|--------------------------|
| No | Frequency (MHz) | Emission Level (dBuV/m) | Limit (dBuV/m) | Margin (dB) | Antenna Height (m) | Table Angle (Degree) | Raw Value (dBuV) | Correction Factor (dB/m) |
| 1 | 5150.00 | 49.3 PK | 74.0 | -24.7 | 1.62 V | 356 | 47.9 | 1.4 |
| 2 | 5150.00 | 37.7 AV | 54.0 | -16.3 | 1.62 V | 356 | 36.3 | 1.4 |
| 3 | *5260.00 | 114.0 PK | | | 1.62 V | 356 | 113.2 | 0.8 |
| 4 | *5260.00 | 104.9 AV | | | 1.62 V | 356 | 104.1 | 0.8 |
| 5 | #10520.00 | 59.1 PK | 68.2 | -9.1 | 1.81 V | 251 | 47.9 | 11.2 |
| 6 | 15780.00 | 54.9 PK | 74.0 | -19.1 | 1.66 V | 104 | 43.6 | 11.3 |
| 7 | 15780.00 | 43.7 AV | 54.0 | -10.3 | 1.66 V | 104 | 32.4 | 11.3 |

Remarks:

1. Emission Level(dBuV/m) = Raw Value(dBuV) + Correction Factor(dB/m)
2. Correction Factor(dB/m) = Antenna Factor(dB/m) + Cable Factor(dB) – Pre-Amplifier Factor(dB)
3. Margin value = Emission Level – Limit value
4. The other emission levels were very low against the limit.
5. " * " : Fundamental frequency, the limit was restricted at the RF Output Power.
6. " # " : The radiated frequency is out of the restricted band.

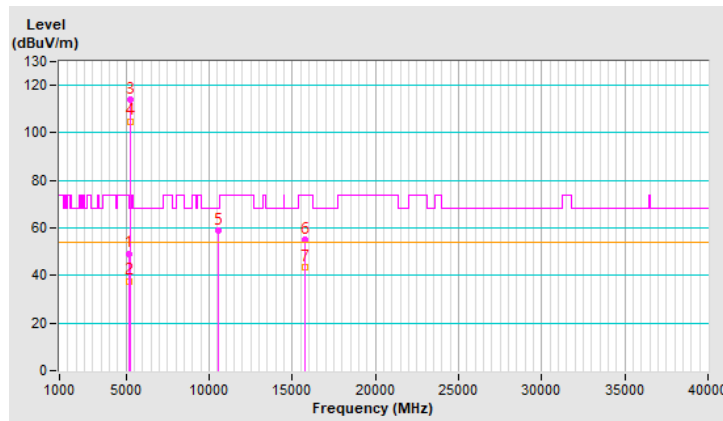

| | | | |
|-----------------------------|----------------|--|---|
| RF Mode | 802.11a | Channel | CH 60 : 5300 MHz |
| Frequency Range | 1 GHz ~ 40 GHz | Detector Function & Bandwidth | (PK) RB = 1 MHz, VB = 3 MHz (AV) RB = 1 MHz, VB = 200 Hz |
| Input Power (System) | 56 Vdc | Environmental Conditions | 25°C, 75% RH |
| Tested By | Tom Yang | | |

| Antenna Polarity & Test Distance : Horizontal at 3 m | | | | | | | | |
|--|-----------------|-------------------------|----------------|-------------|--------------------|----------------------|------------------|--------------------------|
| No | Frequency (MHz) | Emission Level (dBuV/m) | Limit (dBuV/m) | Margin (dB) | Antenna Height (m) | Table Angle (Degree) | Raw Value (dBuV) | Correction Factor (dB/m) |
| 1 | *5300.00 | 114.9 PK | | | 1.94 H | 46 | 114.1 | 0.8 |
| 2 | *5300.00 | 106.0 AV | | | 1.94 H | 46 | 105.2 | 0.8 |
| 3 | 10600.00 | 52.8 PK | 74.0 | -21.2 | 1.49 H | 156 | 42.0 | 10.8 |
| 4 | 10600.00 | 47.5 AV | 54.0 | -6.5 | 1.49 H | 156 | 36.7 | 10.8 |
| 5 | 15900.00 | 51.5 PK | 74.0 | -22.5 | 2.30 H | 230 | 39.9 | 11.6 |
| 6 | 15900.00 | 37.8 AV | 54.0 | -16.2 | 2.30 H | 230 | 26.2 | 11.6 |

Remarks:

1. Emission Level(dBuV/m) = Raw Value(dBuV) + Correction Factor(dB/m)
2. Correction Factor(dB/m) = Antenna Factor(dB/m) + Cable Factor(dB) – Pre-Amplifier Factor(dB)
3. Margin value = Emission Level – Limit value
4. The other emission levels were very low against the limit.
5. " * " : Fundamental frequency, the limit was restricted at the RF Output Power.

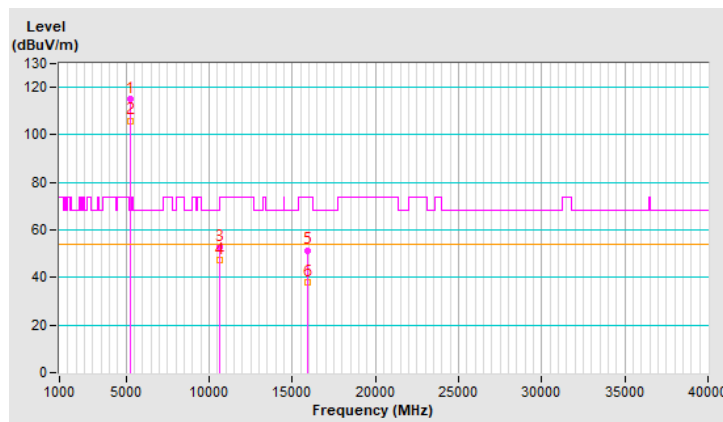

| | | | |
|-----------------------------|----------------|--|---|
| RF Mode | 802.11a | Channel | CH 60 : 5300 MHz |
| Frequency Range | 1 GHz ~ 40 GHz | Detector Function & Bandwidth | (PK) RB = 1 MHz, VB = 3 MHz (AV) RB = 1 MHz, VB = 200 Hz |
| Input Power (System) | 56 Vdc | Environmental Conditions | 25°C, 75% RH |
| Tested By | Tom Yang | | |

| Antenna Polarity & Test Distance : Vertical at 3 m | | | | | | | | |
|--|-----------------|-------------------------|----------------|-------------|--------------------|----------------------|------------------|--------------------------|
| No | Frequency (MHz) | Emission Level (dBuV/m) | Limit (dBuV/m) | Margin (dB) | Antenna Height (m) | Table Angle (Degree) | Raw Value (dBuV) | Correction Factor (dB/m) |
| 1 | *5300.00 | 113.3 PK | | | 1.36 V | 7 | 112.5 | 0.8 |
| 2 | *5300.00 | 104.3 AV | | | 1.36 V | 7 | 103.5 | 0.8 |
| 3 | 10600.00 | 47.9 PK | 74.0 | -26.1 | 1.43 V | 351 | 37.1 | 10.8 |
| 4 | 10600.00 | 39.5 AV | 54.0 | -14.5 | 1.43 V | 351 | 28.7 | 10.8 |
| 5 | 15900.00 | 48.0 PK | 74.0 | -26.0 | 1.55 V | 8 | 36.4 | 11.6 |
| 6 | 15900.00 | 35.6 AV | 54.0 | -18.4 | 1.55 V | 8 | 24.0 | 11.6 |

Remarks:

1. Emission Level(dBuV/m) = Raw Value(dBuV) + Correction Factor(dB/m)
2. Correction Factor(dB/m) = Antenna Factor(dB/m) + Cable Factor(dB) – Pre-Amplifier Factor(dB)
3. Margin value = Emission Level – Limit value
4. The other emission levels were very low against the limit.
5. " * " : Fundamental frequency, the limit was restricted at the RF Output Power.

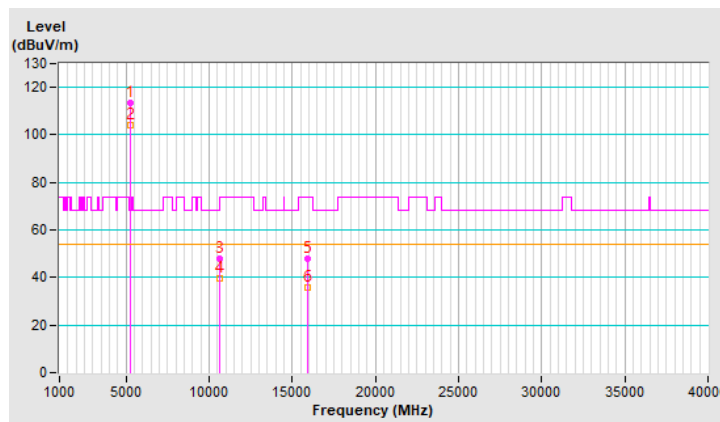

| | | | |
|-----------------------------|----------------|--|---|
| RF Mode | 802.11a | Channel | CH 64 : 5320 MHz |
| Frequency Range | 1 GHz ~ 40 GHz | Detector Function & Bandwidth | (PK) RB = 1 MHz, VB = 3 MHz (AV) RB = 1 MHz, VB = 200 Hz |
| Input Power (System) | 56 Vdc | Environmental Conditions | 25°C, 75% RH |
| Tested By | Tom Yang | | |

| Antenna Polarity & Test Distance : Horizontal at 3 m | | | | | | | | |
|--|-----------------|-------------------------|----------------|-------------|--------------------|----------------------|------------------|--------------------------|
| No | Frequency (MHz) | Emission Level (dBuV/m) | Limit (dBuV/m) | Margin (dB) | Antenna Height (m) | Table Angle (Degree) | Raw Value (dBuV) | Correction Factor (dB/m) |
| 1 | *5320.00 | 114.5 PK | | | 1.94 H | 45 | 113.6 | 0.9 |
| 2 | *5320.00 | 105.7 AV | | | 1.94 H | 45 | 104.8 | 0.9 |
| 3 | 5350.00 | 67.8 PK | 74.0 | -6.2 | 1.94 H | 45 | 66.7 | 1.1 |
| 4 | 5350.00 | 53.6 AV | 54.0 | -0.4 | 1.94 H | 45 | 52.5 | 1.1 |
| 5 | 10640.00 | 53.1 PK | 74.0 | -20.9 | 1.43 H | 168 | 42.2 | 10.9 |
| 6 | 10640.00 | 47.9 AV | 54.0 | -6.1 | 1.43 H | 168 | 37.0 | 10.9 |
| 7 | 15960.00 | 51.3 PK | 74.0 | -22.7 | 2.31 H | 221 | 39.3 | 12.0 |
| 8 | 15960.00 | 37.7 AV | 54.0 | -16.3 | 2.31 H | 221 | 25.7 | 12.0 |

Remarks:

1. Emission Level(dBuV/m) = Raw Value(dBuV) + Correction Factor(dB/m)
2. Correction Factor(dB/m) = Antenna Factor(dB/m) + Cable Factor(dB) – Pre-Amplifier Factor(dB)
3. Margin value = Emission Level – Limit value
4. The other emission levels were very low against the limit.
5. " * " : Fundamental frequency, the limit was restricted at the RF Output Power.

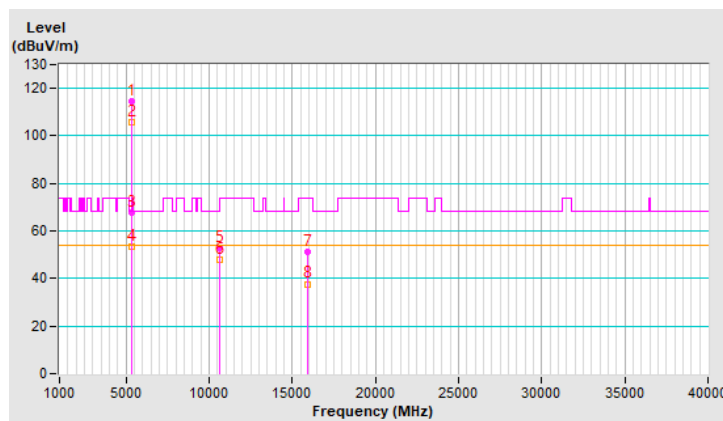

| | | | |
|-----------------------------|----------------|--|---|
| RF Mode | 802.11a | Channel | CH 64 : 5320 MHz |
| Frequency Range | 1 GHz ~ 40 GHz | Detector Function & Bandwidth | (PK) RB = 1 MHz, VB = 3 MHz (AV) RB = 1 MHz, VB = 200 Hz |
| Input Power (System) | 56 Vdc | Environmental Conditions | 25°C, 75% RH |
| Tested By | Tom Yang | | |

| Antenna Polarity & Test Distance : Vertical at 3 m | | | | | | | | |
|--|-----------------|-------------------------|----------------|-------------|--------------------|----------------------|------------------|--------------------------|
| No | Frequency (MHz) | Emission Level (dBuV/m) | Limit (dBuV/m) | Margin (dB) | Antenna Height (m) | Table Angle (Degree) | Raw Value (dBuV) | Correction Factor (dB/m) |
| 1 | *5320.00 | 113.9 PK | | | 1.37 V | 19 | 113.0 | 0.9 |
| 2 | *5320.00 | 104.6 AV | | | 1.37 V | 19 | 103.7 | 0.9 |
| 3 | 5350.00 | 58.3 PK | 74.0 | -15.7 | 1.37 V | 19 | 57.2 | 1.1 |
| 4 | 5350.00 | 46.2 AV | 54.0 | -7.8 | 1.37 V | 19 | 45.1 | 1.1 |
| 5 | 10640.00 | 47.8 PK | 74.0 | -26.2 | 1.48 V | 344 | 36.9 | 10.9 |
| 6 | 10640.00 | 39.2 AV | 54.0 | -14.8 | 1.48 V | 344 | 28.3 | 10.9 |
| 7 | 15960.00 | 47.7 PK | 74.0 | -26.3 | 1.60 V | 20 | 35.7 | 12.0 |
| 8 | 15960.00 | 35.3 AV | 54.0 | -18.7 | 1.60 V | 20 | 23.3 | 12.0 |

Remarks:

1. Emission Level(dBuV/m) = Raw Value(dBuV) + Correction Factor(dB/m)
2. Correction Factor(dB/m) = Antenna Factor(dB/m) + Cable Factor(dB) – Pre-Amplifier Factor(dB)
3. Margin value = Emission Level – Limit value
4. The other emission levels were very low against the limit.
5. " * " : Fundamental frequency, the limit was restricted at the RF Output Power.

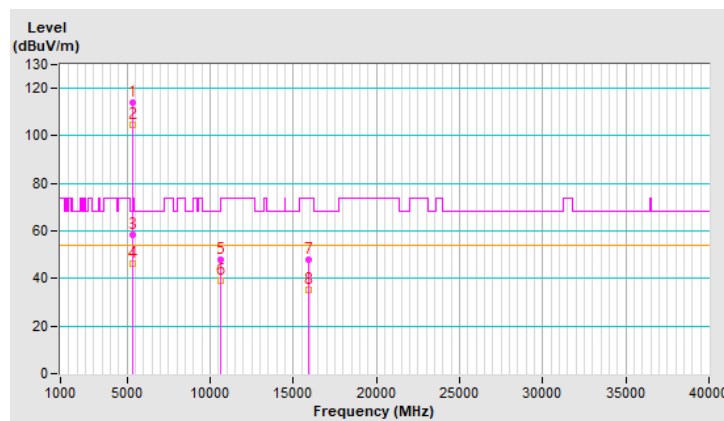

| | | | |
|-----------------------------|----------------|--|---|
| RF Mode | 802.11a | Channel | CH 100 : 5500 MHz |
| Frequency Range | 1 GHz ~ 40 GHz | Detector Function & Bandwidth | (PK) RB = 1 MHz, VB = 3 MHz (AV) RB = 1 MHz, VB = 200 Hz |
| Input Power (System) | 56 Vdc | Environmental Conditions | 25°C, 75% RH |
| Tested By | Tom Yang | | |

| Antenna Polarity & Test Distance : Horizontal at 3 m | | | | | | | | |
|--|-----------------|-------------------------|----------------|-------------|--------------------|----------------------|------------------|--------------------------|
| No | Frequency (MHz) | Emission Level (dBuV/m) | Limit (dBuV/m) | Margin (dB) | Antenna Height (m) | Table Angle (Degree) | Raw Value (dBuV) | Correction Factor (dB/m) |
| 1 | 5455.80 | 59.0 PK | 74.0 | -15.0 | 1.98 H | 45 | 57.7 | 1.3 |
| 2 | 5455.80 | 45.5 AV | 54.0 | -8.5 | 1.98 H | 45 | 44.2 | 1.3 |
| 3 | #5470.00 | 67.6 PK | 68.2 | -0.6 | 1.98 H | 45 | 66.3 | 1.3 |
| 4 | *5500.00 | 114.8 PK | | | 1.98 H | 45 | 113.5 | 1.3 |
| 5 | *5500.00 | 106.2 AV | | | 1.98 H | 45 | 104.9 | 1.3 |
| 6 | 11000.00 | 53.2 PK | 74.0 | -20.8 | 1.42 H | 164 | 41.4 | 11.8 |
| 7 | 11000.00 | 48.3 AV | 54.0 | -5.7 | 1.42 H | 164 | 36.5 | 11.8 |
| 8 | #16500.00 | 51.1 PK | 68.2 | -17.1 | 2.29 H | 219 | 37.0 | 14.1 |

Remarks:

1. Emission Level(dBuV/m) = Raw Value(dBuV) + Correction Factor(dB/m)
2. Correction Factor(dB/m) = Antenna Factor(dB/m) + Cable Factor(dB) – Pre-Amplifier Factor(dB)
3. Margin value = Emission Level – Limit value
4. The other emission levels were very low against the limit.
5. " * " : Fundamental frequency, the limit was restricted at the RF Output Power.
6. " # " : The radiated frequency is out of the restricted band.

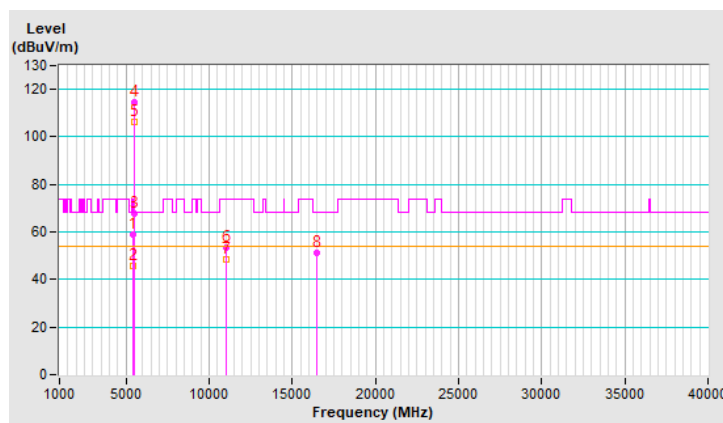

| | | | |
|-----------------------------|----------------|--|---|
| RF Mode | 802.11a | Channel | CH 100 : 5500 MHz |
| Frequency Range | 1 GHz ~ 40 GHz | Detector Function & Bandwidth | (PK) RB = 1 MHz, VB = 3 MHz (AV) RB = 1 MHz, VB = 200 Hz |
| Input Power (System) | 56 Vdc | Environmental Conditions | 25°C, 75% RH |
| Tested By | Tom Yang | | |

| Antenna Polarity & Test Distance : Vertical at 3 m | | | | | | | | |
|--|-----------------|-------------------------|----------------|-------------|--------------------|----------------------|------------------|--------------------------|
| No | Frequency (MHz) | Emission Level (dBuV/m) | Limit (dBuV/m) | Margin (dB) | Antenna Height (m) | Table Angle (Degree) | Raw Value (dBuV) | Correction Factor (dB/m) |
| 1 | 5454.40 | 54.2 PK | 74.0 | -19.8 | 1.50 V | 358 | 52.9 | 1.3 |
| 2 | 5454.40 | 40.3 AV | 54.0 | -13.7 | 1.50 V | 358 | 39.0 | 1.3 |
| 3 | #5470.00 | 57.2 PK | 68.2 | -11.0 | 1.50 V | 358 | 55.9 | 1.3 |
| 4 | *5500.00 | 113.1 PK | | | 1.50 V | 358 | 111.8 | 1.3 |
| 5 | *5500.00 | 104.1 AV | | | 1.50 V | 358 | 102.8 | 1.3 |
| 6 | 11000.00 | 59.0 PK | 74.0 | -15.0 | 2.33 V | 194 | 47.2 | 11.8 |
| 7 | 11000.00 | 47.7 AV | 54.0 | -6.3 | 2.33 V | 194 | 35.9 | 11.8 |
| 8 | #16500.00 | 58.1 PK | 68.2 | -10.1 | 2.31 V | 193 | 44.0 | 14.1 |

Remarks:

1. Emission Level(dBuV/m) = Raw Value(dBuV) + Correction Factor(dB/m)
2. Correction Factor(dB/m) = Antenna Factor(dB/m) + Cable Factor(dB) – Pre-Amplifier Factor(dB)
3. Margin value = Emission Level – Limit value
4. The other emission levels were very low against the limit.
5. " * " : Fundamental frequency, the limit was restricted at the RF Output Power.
6. " # " : The radiated frequency is out of the restricted band.

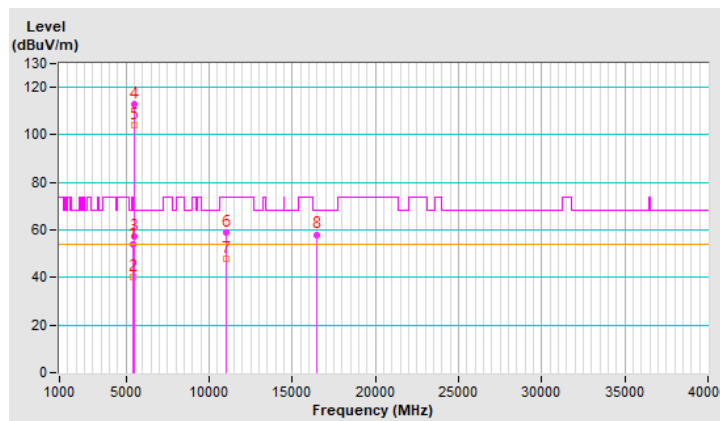

| | | | |
|-----------------------------|----------------|--|---|
| RF Mode | 802.11a | Channel | CH 116 : 5580 MHz |
| Frequency Range | 1 GHz ~ 40 GHz | Detector Function & Bandwidth | (PK) RB = 1 MHz, VB = 3 MHz (AV) RB = 1 MHz, VB = 200 Hz |
| Input Power (System) | 56 Vdc | Environmental Conditions | 25°C, 75% RH |
| Tested By | Tom Yang | | |

| Antenna Polarity & Test Distance : Horizontal at 3 m | | | | | | | | |
|--|-----------------|-------------------------|----------------|-------------|--------------------|----------------------|------------------|--------------------------|
| No | Frequency (MHz) | Emission Level (dBuV/m) | Limit (dBuV/m) | Margin (dB) | Antenna Height (m) | Table Angle (Degree) | Raw Value (dBuV) | Correction Factor (dB/m) |
| 1 | *5580.00 | 114.4 PK | | | 2.02 H | 51 | 113.1 | 1.3 |
| 2 | *5580.00 | 105.7 AV | | | 2.02 H | 51 | 104.4 | 1.3 |
| 3 | 11160.00 | 61.4 PK | 74.0 | -12.6 | 1.60 H | 240 | 50.0 | 11.4 |
| 4 | 11160.00 | 51.0 AV | 54.0 | -3.0 | 1.60 H | 240 | 39.6 | 11.4 |
| 5 | #16740.00 | 55.8 PK | 68.2 | -12.4 | 3.14 H | 273 | 41.0 | 14.8 |

Remarks:

1. Emission Level(dBuV/m) = Raw Value(dBuV) + Correction Factor(dB/m)
2. Correction Factor(dB/m) = Antenna Factor(dB/m) + Cable Factor(dB) – Pre-Amplifier Factor(dB)
3. Margin value = Emission Level – Limit value
4. The other emission levels were very low against the limit.
5. " * " : Fundamental frequency, the limit was restricted at the RF Output Power.
6. " # " : The radiated frequency is out of the restricted band.

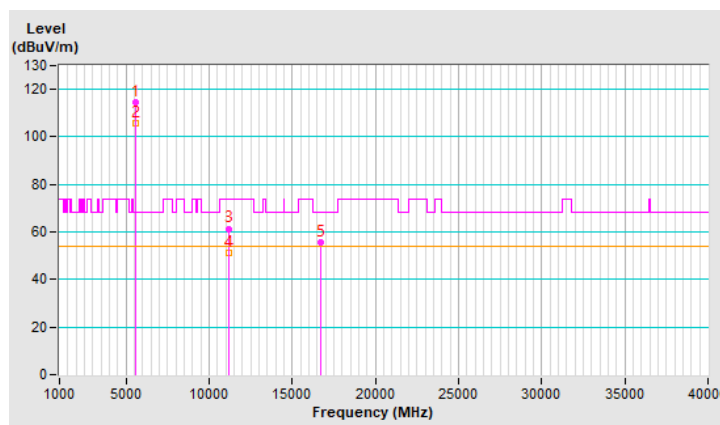

| | | | |
|-----------------------------|----------------|--|---|
| RF Mode | 802.11a | Channel | CH 116 : 5580 MHz |
| Frequency Range | 1 GHz ~ 40 GHz | Detector Function & Bandwidth | (PK) RB = 1 MHz, VB = 3 MHz (AV) RB = 1 MHz, VB = 200 Hz |
| Input Power (System) | 56 Vdc | Environmental Conditions | 25°C, 75% RH |
| Tested By | Tom Yang | | |

| Antenna Polarity & Test Distance : Vertical at 3 m | | | | | | | | |
|--|-----------------|-------------------------|----------------|-------------|--------------------|----------------------|------------------|--------------------------|
| No | Frequency (MHz) | Emission Level (dBuV/m) | Limit (dBuV/m) | Margin (dB) | Antenna Height (m) | Table Angle (Degree) | Raw Value (dBuV) | Correction Factor (dB/m) |
| 1 | *5580.00 | 113.1 PK | | | 1.48 V | 349 | 111.8 | 1.3 |
| 2 | *5580.00 | 103.8 AV | | | 1.48 V | 349 | 102.5 | 1.3 |
| 3 | 11160.00 | 58.8 PK | 74.0 | -15.2 | 2.31 V | 197 | 47.4 | 11.4 |
| 4 | 11160.00 | 47.3 AV | 54.0 | -6.7 | 2.31 V | 197 | 35.9 | 11.4 |
| 5 | #16740.00 | 58.5 PK | 68.2 | -9.7 | 2.37 V | 175 | 43.7 | 14.8 |

Remarks:

1. Emission Level(dBuV/m) = Raw Value(dBuV) + Correction Factor(dB/m)
2. Correction Factor(dB/m) = Antenna Factor(dB/m) + Cable Factor(dB) – Pre-Amplifier Factor(dB)
3. Margin value = Emission Level – Limit value
4. The other emission levels were very low against the limit.
5. " * " : Fundamental frequency, the limit was restricted at the RF Output Power.
6. " # " : The radiated frequency is out of the restricted band.

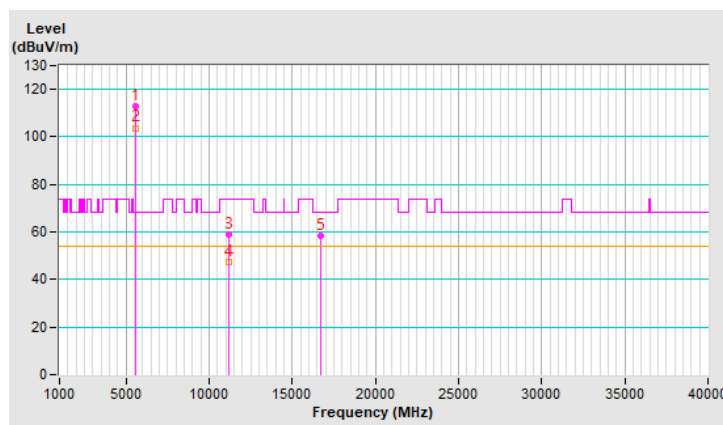

| | | | |
|-----------------------------|----------------|--|---|
| RF Mode | 802.11a | Channel | CH 140 : 5700 MHz |
| Frequency Range | 1 GHz ~ 40 GHz | Detector Function & Bandwidth | (PK) RB = 1 MHz, VB = 3 MHz (AV) RB = 1 MHz, VB = 200 Hz |
| Input Power (System) | 56 Vdc | Environmental Conditions | 25°C, 75% RH |
| Tested By | Tom Yang | | |

| Antenna Polarity & Test Distance : Horizontal at 3 m | | | | | | | | |
|--|-----------------|-------------------------|----------------|-------------|--------------------|----------------------|------------------|--------------------------|
| No | Frequency (MHz) | Emission Level (dBUV/m) | Limit (dBUV/m) | Margin (dB) | Antenna Height (m) | Table Angle (Degree) | Raw Value (dBUV) | Correction Factor (dB/m) |
| 1 | *5700.00 | 115.7 PK | | | 2.46 H | 80 | 113.8 | 1.9 |
| 2 | *5700.00 | 107.3 AV | | | 2.46 H | 80 | 105.4 | 1.9 |
| 3 | #5725.00 | 67.9 PK | 68.2 | -0.3 | 2.46 H | 80 | 65.9 | 2.0 |
| 4 | 11400.00 | 60.9 PK | 74.0 | -13.1 | 1.55 H | 260 | 48.9 | 12.0 |
| 5 | 11400.00 | 50.6 AV | 54.0 | -3.4 | 1.55 H | 260 | 38.6 | 12.0 |
| 6 | #17100.00 | 55.6 PK | 68.2 | -12.6 | 3.17 H | 255 | 39.7 | 15.9 |

Remarks:

1. Emission Level(dBUV/m) = Raw Value(dBUV) + Correction Factor(dB/m)
2. Correction Factor(dB/m) = Antenna Factor(dB/m) + Cable Factor(dB) – Pre-Amplifier Factor(dB)
3. Margin value = Emission Level – Limit value
4. The other emission levels were very low against the limit.
5. " * " : Fundamental frequency, the limit was restricted at the RF Output Power.
6. " # " : The radiated frequency is out of the restricted band.

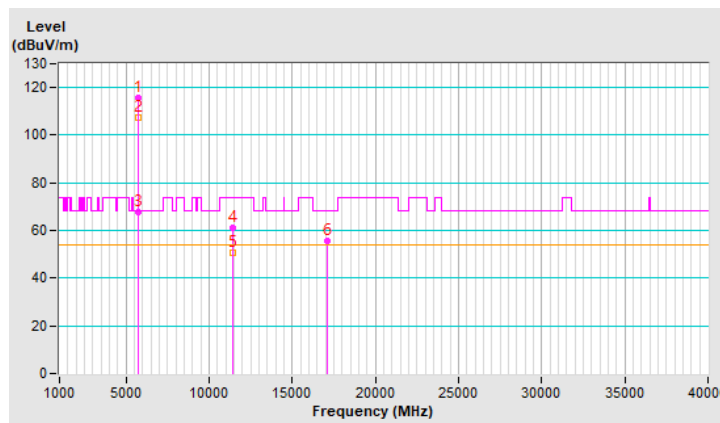

| | | | |
|-----------------------------|----------------|--|---|
| RF Mode | 802.11a | Channel | CH 140 : 5700 MHz |
| Frequency Range | 1 GHz ~ 40 GHz | Detector Function & Bandwidth | (PK) RB = 1 MHz, VB = 3 MHz (AV) RB = 1 MHz, VB = 200 Hz |
| Input Power (System) | 56 Vdc | Environmental Conditions | 25°C, 75% RH |
| Tested By | Tom Yang | | |

| Antenna Polarity & Test Distance : Vertical at 3 m | | | | | | | | |
|--|-----------------|-------------------------|----------------|-------------|--------------------|----------------------|------------------|--------------------------|
| No | Frequency (MHz) | Emission Level (dBuV/m) | Limit (dBuV/m) | Margin (dB) | Antenna Height (m) | Table Angle (Degree) | Raw Value (dBuV) | Correction Factor (dB/m) |
| 1 | *5700.00 | 112.7 PK | | | 1.50 V | 358 | 110.8 | 1.9 |
| 2 | *5700.00 | 103.7 AV | | | 1.50 V | 358 | 101.8 | 1.9 |
| 3 | #5725.00 | 54.1 PK | 68.2 | -14.1 | 1.50 V | 358 | 52.1 | 2.0 |
| 4 | 11400.00 | 59.1 PK | 74.0 | -14.9 | 2.38 V | 181 | 47.1 | 12.0 |
| 5 | 11400.00 | 47.7 AV | 54.0 | -6.3 | 2.38 V | 181 | 35.7 | 12.0 |
| 6 | #17100.00 | 59.0 PK | 68.2 | -9.2 | 2.35 V | 182 | 43.1 | 15.9 |

Remarks:

1. Emission Level(dBuV/m) = Raw Value(dBuV) + Correction Factor(dB/m)
2. Correction Factor(dB/m) = Antenna Factor(dB/m) + Cable Factor(dB) – Pre-Amplifier Factor(dB)
3. Margin value = Emission Level – Limit value
4. The other emission levels were very low against the limit.
5. " * " : Fundamental frequency, the limit was restricted at the RF Output Power.
6. " # " : The radiated frequency is out of the restricted band.

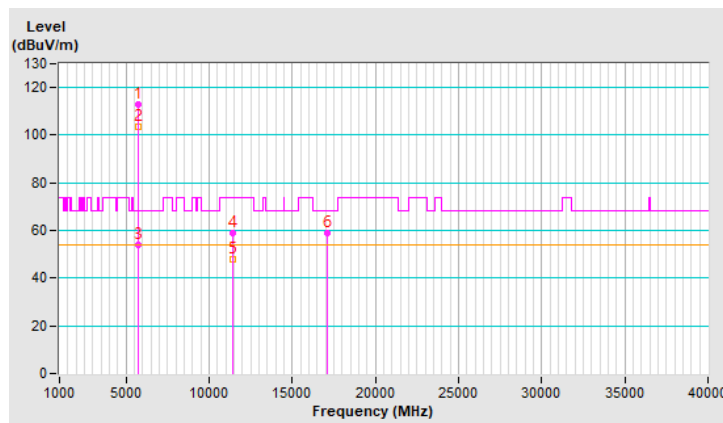

| | | | |
|-----------------------------|----------------|--|---|
| RF Mode | 802.11a | Channel | CH 144 : 5720 MHz |
| Frequency Range | 1 GHz ~ 40 GHz | Detector Function & Bandwidth | (PK) RB = 1 MHz, VB = 3 MHz (AV) RB = 1 MHz, VB = 200 Hz |
| Input Power (System) | 56 Vdc | Environmental Conditions | 25°C, 75% RH |
| Tested By | Tom Yang | | |

| Antenna Polarity & Test Distance : Horizontal at 3 m | | | | | | | | |
|--|-----------------|-------------------------|----------------|-------------|--------------------|----------------------|------------------|--------------------------|
| No | Frequency (MHz) | Emission Level (dBuV/m) | Limit (dBuV/m) | Margin (dB) | Antenna Height (m) | Table Angle (Degree) | Raw Value (dBuV) | Correction Factor (dB/m) |
| 1 | 5460.00 | 59.4 PK | 74.0 | -14.6 | 2.47 H | 79 | 58.1 | 1.3 |
| 2 | 5460.00 | 45.8 AV | 54.0 | -8.2 | 2.47 H | 79 | 44.5 | 1.3 |
| 3 | #5470.00 | 48.8 PK | 68.2 | -19.4 | 2.47 H | 79 | 47.5 | 1.3 |
| 4 | *5720.00 | 115.6 PK | | | 2.47 H | 79 | 113.6 | 2.0 |
| 5 | *5720.00 | 106.7 AV | | | 2.47 H | 79 | 104.7 | 2.0 |
| 6 | #5850.00 | 49.1 PK | 68.2 | -19.1 | 2.47 H | 79 | 47.1 | 2.0 |
| 7 | 11440.00 | 60.9 PK | 74.0 | -13.1 | 1.55 H | 256 | 49.0 | 11.9 |
| 8 | 11440.00 | 50.5 AV | 54.0 | -3.5 | 1.55 H | 256 | 38.6 | 11.9 |
| 9 | #17160.00 | 55.4 PK | 68.2 | -12.8 | 3.13 H | 265 | 39.6 | 15.8 |

Remarks:

1. Emission Level(dBuV/m) = Raw Value(dBuV) + Correction Factor(dB/m)
2. Correction Factor(dB/m) = Antenna Factor(dB/m) + Cable Factor(dB) – Pre-Amplifier Factor(dB)
3. Margin value = Emission Level – Limit value
4. The other emission levels were very low against the limit.
5. " * " : Fundamental frequency, the limit was restricted at the RF Output Power.
6. " # " : The radiated frequency is out of the restricted band.

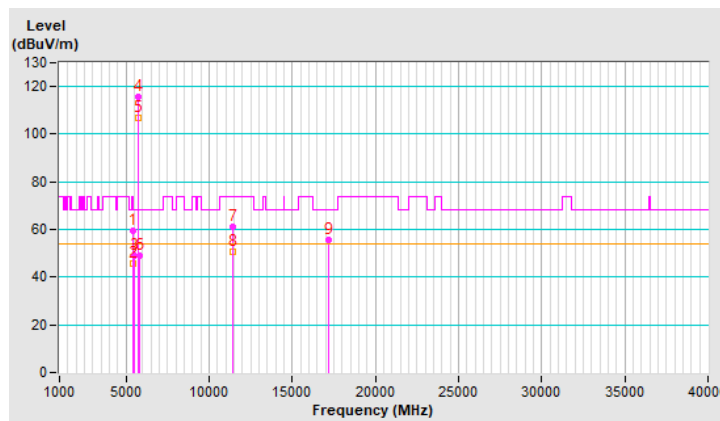

| | | | |
|-----------------------------|----------------|--|---|
| RF Mode | 802.11a | Channel | CH 144 : 5720 MHz |
| Frequency Range | 1 GHz ~ 40 GHz | Detector Function & Bandwidth | (PK) RB = 1 MHz, VB = 3 MHz (AV) RB = 1 MHz, VB = 200 Hz |
| Input Power (System) | 56 Vdc | Environmental Conditions | 25°C, 75% RH |
| Tested By | Tom Yang | | |

| Antenna Polarity & Test Distance : Vertical at 3 m | | | | | | | | |
|--|-----------------|-------------------------|----------------|-------------|--------------------|----------------------|------------------|--------------------------|
| No | Frequency (MHz) | Emission Level (dBuV/m) | Limit (dBuV/m) | Margin (dB) | Antenna Height (m) | Table Angle (Degree) | Raw Value (dBuV) | Correction Factor (dB/m) |
| 1 | 5460.00 | 54.3 PK | 74.0 | -19.7 | 1.54 V | 360 | 53.0 | 1.3 |
| 2 | 5460.00 | 40.5 AV | 54.0 | -13.5 | 1.54 V | 360 | 39.2 | 1.3 |
| 3 | #5470.00 | 49.1 PK | 68.2 | -19.1 | 1.54 V | 360 | 47.8 | 1.3 |
| 4 | *5720.00 | 113.5 PK | | | 1.54 V | 360 | 111.5 | 2.0 |
| 5 | *5720.00 | 104.6 AV | | | 1.54 V | 360 | 102.6 | 2.0 |
| 6 | #5850.00 | 49.0 PK | 68.2 | -19.2 | 1.54 V | 360 | 47.0 | 2.0 |
| 7 | 11440.00 | 59.5 PK | 74.0 | -14.5 | 2.37 V | 199 | 47.6 | 11.9 |
| 8 | 11440.00 | 48.0 AV | 54.0 | -6.0 | 2.37 V | 199 | 36.1 | 11.9 |
| 9 | #17160.00 | 58.0 PK | 68.2 | -10.2 | 2.38 V | 200 | 42.2 | 15.8 |

Remarks:

1. Emission Level(dBuV/m) = Raw Value(dBuV) + Correction Factor(dB/m)
2. Correction Factor(dB/m) = Antenna Factor(dB/m) + Cable Factor(dB) – Pre-Amplifier Factor(dB)
3. Margin value = Emission Level – Limit value
4. The other emission levels were very low against the limit.
5. " * " : Fundamental frequency, the limit was restricted at the RF Output Power.
6. " # " : The radiated frequency is out of the restricted band.

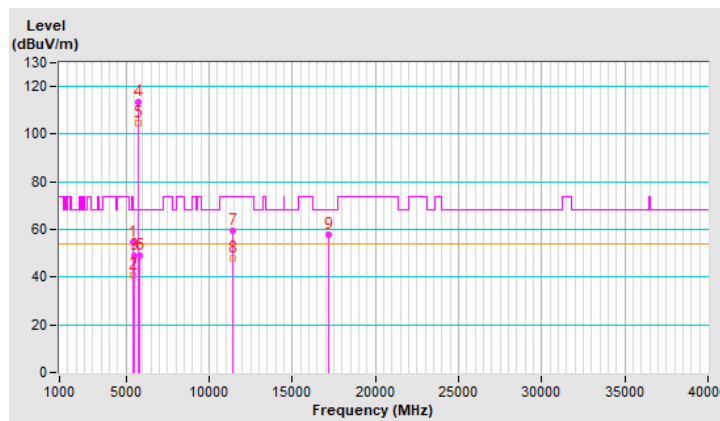

| | | | |
|-----------------------------|-----------------|--|---|
| RF Mode | 802.11ax (HE20) | Channel | CH 52 : 5260 MHz |
| Frequency Range | 1 GHz ~ 40 GHz | Detector Function & Bandwidth | (PK) RB = 1 MHz, VB = 3 MHz (AV) RB = 1 MHz, VB = 200 Hz |
| Input Power (System) | 56 Vdc | Environmental Conditions | 25°C, 75% RH |
| Tested By | Tom Yang | | |

| Antenna Polarity & Test Distance : Horizontal at 3 m | | | | | | | | |
|--|-----------------|-------------------------|----------------|-------------|--------------------|----------------------|------------------|--------------------------|
| No | Frequency (MHz) | Emission Level (dBuV/m) | Limit (dBuV/m) | Margin (dB) | Antenna Height (m) | Table Angle (Degree) | Raw Value (dBuV) | Correction Factor (dB/m) |
| 1 | 5150.00 | 49.5 PK | 74.0 | -24.5 | 3.20 H | 290 | 48.1 | 1.4 |
| 2 | 5150.00 | 41.7 AV | 54.0 | -12.3 | 3.20 H | 290 | 40.3 | 1.4 |
| 3 | *5260.00 | 120.3 PK | | | 3.20 H | 290 | 119.5 | 0.8 |
| 4 | *5260.00 | 110.3 AV | | | 3.20 H | 290 | 109.5 | 0.8 |
| 5 | #10520.00 | 57.1 PK | 68.2 | -11.1 | 1.49 H | 252 | 45.9 | 11.2 |
| 6 | 15780.00 | 55.5 PK | 74.0 | -18.5 | 3.12 H | 268 | 44.2 | 11.3 |
| 7 | 15780.00 | 44.2 AV | 54.0 | -9.8 | 3.12 H | 268 | 32.9 | 11.3 |

Remarks:

1. Emission Level(dBuV/m) = Raw Value(dBuV) + Correction Factor(dB/m)
2. Correction Factor(dB/m) = Antenna Factor(dB/m) + Cable Factor(dB) – Pre-Amplifier Factor(dB)
3. Margin value = Emission Level – Limit value
4. The other emission levels were very low against the limit.
5. " * " : Fundamental frequency, the limit was restricted at the RF Output Power.
6. " # " : The radiated frequency is out of the restricted band.

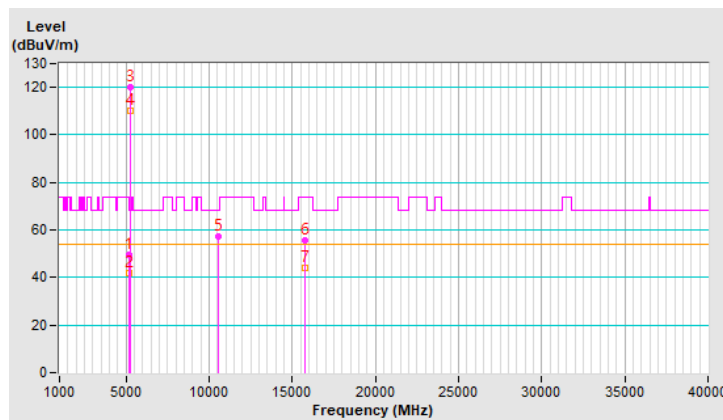

| | | | |
|-----------------------------|-----------------|--|---|
| RF Mode | 802.11ax (HE20) | Channel | CH 52 : 5260 MHz |
| Frequency Range | 1 GHz ~ 40 GHz | Detector Function & Bandwidth | (PK) RB = 1 MHz, VB = 3 MHz (AV) RB = 1 MHz, VB = 200 Hz |
| Input Power (System) | 56 Vdc | Environmental Conditions | 25°C, 75% RH |
| Tested By | Tom Yang | | |

| Antenna Polarity & Test Distance : Vertical at 3 m | | | | | | | | |
|--|-----------------|-------------------------|----------------|-------------|--------------------|----------------------|------------------|--------------------------|
| No | Frequency (MHz) | Emission Level (dBuV/m) | Limit (dBuV/m) | Margin (dB) | Antenna Height (m) | Table Angle (Degree) | Raw Value (dBuV) | Correction Factor (dB/m) |
| 1 | 5150.00 | 49.1 PK | 74.0 | -24.9 | 1.45 V | 10 | 47.7 | 1.4 |
| 2 | 5150.00 | 38.9 AV | 54.0 | -15.1 | 1.45 V | 10 | 37.5 | 1.4 |
| 3 | *5260.00 | 118.2 PK | | | 1.45 V | 10 | 117.4 | 0.8 |
| 4 | *5260.00 | 106.0 AV | | | 1.45 V | 10 | 105.2 | 0.8 |
| 5 | #10520.00 | 57.3 PK | 68.2 | -10.9 | 1.83 V | 224 | 46.1 | 11.2 |
| 6 | 15780.00 | 54.3 PK | 74.0 | -19.7 | 1.64 V | 98 | 43.0 | 11.3 |
| 7 | 15780.00 | 43.1 AV | 54.0 | -10.9 | 1.64 V | 98 | 31.8 | 11.3 |

Remarks:

1. Emission Level(dBuV/m) = Raw Value(dBuV) + Correction Factor(dB/m)
2. Correction Factor(dB/m) = Antenna Factor(dB/m) + Cable Factor(dB) – Pre-Amplifier Factor(dB)
3. Margin value = Emission Level – Limit value
4. The other emission levels were very low against the limit.
5. " * " : Fundamental frequency, the limit was restricted at the RF Output Power.
6. " # " : The radiated frequency is out of the restricted band.

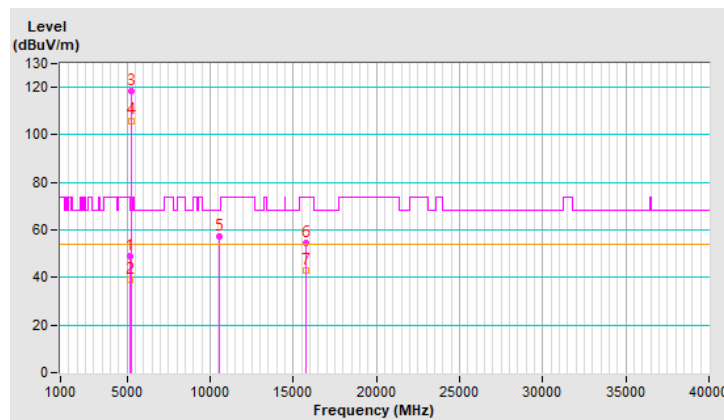

| | | | |
|-----------------------------|-----------------|--|---|
| RF Mode | 802.11ax (HE20) | Channel | CH 60 : 5300 MHz |
| Frequency Range | 1 GHz ~ 40 GHz | Detector Function & Bandwidth | (PK) RB = 1 MHz, VB = 3 MHz (AV) RB = 1 MHz, VB = 200 Hz |
| Input Power (System) | 56 Vdc | Environmental Conditions | 25°C, 75% RH |
| Tested By | Tom Yang | | |

Antenna Polarity & Test Distance : Horizontal at 3 m

| No | Frequency (MHz) | Emission Level (dBuV/m) | Limit (dBuV/m) | Margin (dB) | Antenna Height (m) | Table Angle (Degree) | Raw Value (dBuV) | Correction Factor (dB/m) |
|----|-----------------|-------------------------|----------------|-------------|--------------------|----------------------|------------------|--------------------------|
| 1 | *5300.00 | 120.1 PK | | | 3.17 H | 291 | 119.3 | 0.8 |
| 2 | *5300.00 | 110.3 AV | | | 3.17 H | 291 | 109.5 | 0.8 |
| 3 | 10600.00 | 57.5 PK | 74.0 | -16.5 | 1.46 H | 253 | 46.7 | 10.8 |
| 4 | 10600.00 | 48.1 AV | 54.0 | -5.9 | 1.46 H | 253 | 37.3 | 10.8 |
| 5 | 15900.00 | 55.5 PK | 74.0 | -18.5 | 3.16 H | 257 | 43.9 | 11.6 |
| 6 | 15900.00 | 44.1 AV | 54.0 | -9.9 | 3.16 H | 257 | 32.5 | 11.6 |

Remarks:

1. Emission Level(dBuV/m) = Raw Value(dBuV) + Correction Factor(dB/m)
2. Correction Factor(dB/m) = Antenna Factor(dB/m) + Cable Factor(dB) – Pre-Amplifier Factor(dB)
3. Margin value = Emission Level – Limit value
4. The other emission levels were very low against the limit.
5. " * " : Fundamental frequency, the limit was restricted at the RF Output Power.

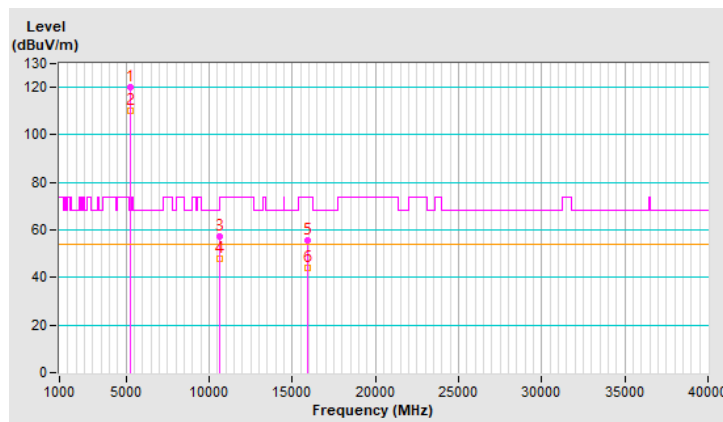

| | | | |
|-----------------------------|-----------------|--|---|
| RF Mode | 802.11ax (HE20) | Channel | CH 60 : 5300 MHz |
| Frequency Range | 1 GHz ~ 40 GHz | Detector Function & Bandwidth | (PK) RB = 1 MHz, VB = 3 MHz (AV) RB = 1 MHz, VB = 200 Hz |
| Input Power (System) | 56 Vdc | Environmental Conditions | 25°C, 75% RH |
| Tested By | Tom Yang | | |

| Antenna Polarity & Test Distance : Vertical at 3 m | | | | | | | | |
|--|-----------------|-------------------------|----------------|-------------|--------------------|----------------------|------------------|--------------------------|
| No | Frequency (MHz) | Emission Level (dBuV/m) | Limit (dBuV/m) | Margin (dB) | Antenna Height (m) | Table Angle (Degree) | Raw Value (dBuV) | Correction Factor (dB/m) |
| 1 | *5300.00 | 117.9 PK | | | 1.10 V | 14 | 117.1 | 0.8 |
| 2 | *5300.00 | 106.2 AV | | | 1.10 V | 14 | 105.4 | 0.8 |
| 3 | 10600.00 | 57.2 PK | 74.0 | -16.8 | 1.73 V | 215 | 46.4 | 10.8 |
| 4 | 10600.00 | 47.8 AV | 54.0 | -6.2 | 1.73 V | 215 | 37.0 | 10.8 |
| 5 | 15900.00 | 55.1 PK | 74.0 | -18.9 | 1.59 V | 96 | 43.5 | 11.6 |
| 6 | 15900.00 | 43.6 AV | 54.0 | -10.4 | 1.59 V | 96 | 32.0 | 11.6 |

Remarks:

1. Emission Level(dBuV/m) = Raw Value(dBuV) + Correction Factor(dB/m)
2. Correction Factor(dB/m) = Antenna Factor(dB/m) + Cable Factor(dB) – Pre-Amplifier Factor(dB)
3. Margin value = Emission Level – Limit value
4. The other emission levels were very low against the limit.
5. " * " : Fundamental frequency, the limit was restricted at the RF Output Power.

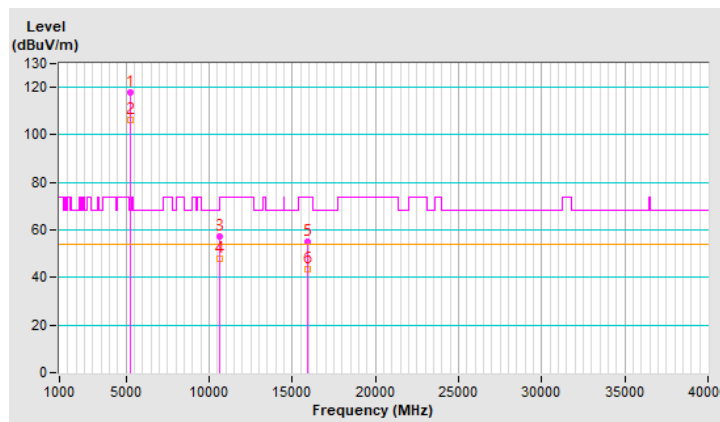

| | | | |
|-----------------------------|-----------------|--|---|
| RF Mode | 802.11ax (HE20) | Channel | CH 64 : 5320 MHz |
| Frequency Range | 1 GHz ~ 40 GHz | Detector Function & Bandwidth | (PK) RB = 1 MHz, VB = 3 MHz (AV) RB = 1 MHz, VB = 200 Hz |
| Input Power (System) | 56 Vdc | Environmental Conditions | 25°C, 75% RH |
| Tested By | Tom Yang | | |

| Antenna Polarity & Test Distance : Horizontal at 3 m | | | | | | | | |
|--|-----------------|-------------------------|----------------|-------------|--------------------|----------------------|------------------|--------------------------|
| No | Frequency (MHz) | Emission Level (dBuV/m) | Limit (dBuV/m) | Margin (dB) | Antenna Height (m) | Table Angle (Degree) | Raw Value (dBuV) | Correction Factor (dB/m) |
| 1 | *5320.00 | 117.5 PK | | | 2.37 H | 59 | 116.6 | 0.9 |
| 2 | *5320.00 | 106.3 AV | | | 2.37 H | 59 | 105.4 | 0.9 |
| 3 | 5350.00 | 63.8 PK | 74.0 | -10.2 | 2.37 H | 59 | 62.7 | 1.1 |
| 4 | 5350.00 | 53.6 AV | 54.0 | -0.4 | 2.37 H | 59 | 52.5 | 1.1 |
| 5 | 10640.00 | 58.0 PK | 74.0 | -16.0 | 1.50 H | 259 | 47.1 | 10.9 |
| 6 | 10640.00 | 48.6 AV | 54.0 | -5.4 | 1.50 H | 259 | 37.7 | 10.9 |
| 7 | 15960.00 | 55.9 PK | 74.0 | -18.1 | 3.12 H | 274 | 43.9 | 12.0 |
| 8 | 15960.00 | 44.6 AV | 54.0 | -9.4 | 3.12 H | 274 | 32.6 | 12.0 |

Remarks:

1. Emission Level(dBuV/m) = Raw Value(dBuV) + Correction Factor(dB/m)
2. Correction Factor(dB/m) = Antenna Factor(dB/m) + Cable Factor(dB) – Pre-Amplifier Factor(dB)
3. Margin value = Emission Level – Limit value
4. The other emission levels were very low against the limit.
5. " * ": Fundamental frequency, the limit was restricted at the RF Output Power.

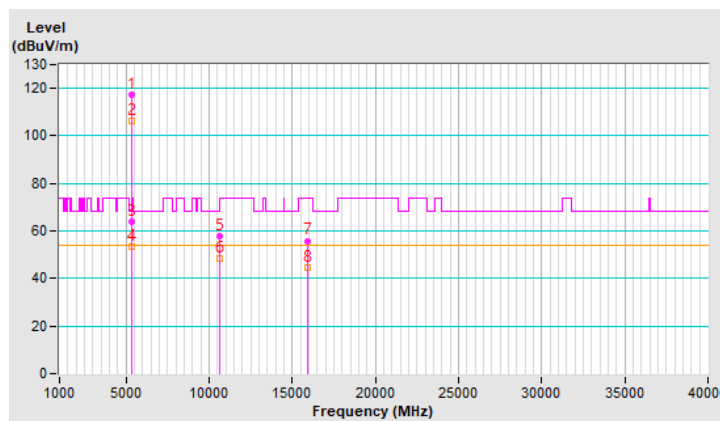

| | | | |
|-----------------------------|-----------------|--|---|
| RF Mode | 802.11ax (HE20) | Channel | CH 64 : 5320 MHz |
| Frequency Range | 1 GHz ~ 40 GHz | Detector Function & Bandwidth | (PK) RB = 1 MHz, VB = 3 MHz (AV) RB = 1 MHz, VB = 200 Hz |
| Input Power (System) | 56 Vdc | Environmental Conditions | 25°C, 75% RH |
| Tested By | Tom Yang | | |

| Antenna Polarity & Test Distance : Vertical at 3 m | | | | | | | | |
|--|-----------------|-------------------------|----------------|-------------|--------------------|----------------------|------------------|--------------------------|
| No | Frequency (MHz) | Emission Level (dBuV/m) | Limit (dBuV/m) | Margin (dB) | Antenna Height (m) | Table Angle (Degree) | Raw Value (dBuV) | Correction Factor (dB/m) |
| 1 | *5320.00 | 116.0 PK | | | 1.28 V | 18 | 115.1 | 0.9 |
| 2 | *5320.00 | 103.7 AV | | | 1.28 V | 18 | 102.8 | 0.9 |
| 3 | 5350.00 | 54.9 PK | 74.0 | -19.1 | 1.28 V | 18 | 53.8 | 1.1 |
| 4 | 5350.00 | 42.4 AV | 54.0 | -11.6 | 1.28 V | 18 | 41.3 | 1.1 |
| 5 | 10640.00 | 57.5 PK | 74.0 | -16.5 | 1.79 V | 197 | 46.6 | 10.9 |
| 6 | 10640.00 | 48.1 AV | 54.0 | -5.9 | 1.79 V | 197 | 37.2 | 10.9 |
| 7 | 15960.00 | 55.2 PK | 74.0 | -18.8 | 1.58 V | 111 | 43.2 | 12.0 |
| 8 | 15960.00 | 44.1 AV | 54.0 | -9.9 | 1.58 V | 111 | 32.1 | 12.0 |

Remarks:

1. Emission Level(dBuV/m) = Raw Value(dBuV) + Correction Factor(dB/m)
2. Correction Factor(dB/m) = Antenna Factor(dB/m) + Cable Factor(dB) – Pre-Amplifier Factor(dB)
3. Margin value = Emission Level – Limit value
4. The other emission levels were very low against the limit.
5. " * " : Fundamental frequency, the limit was restricted at the RF Output Power.

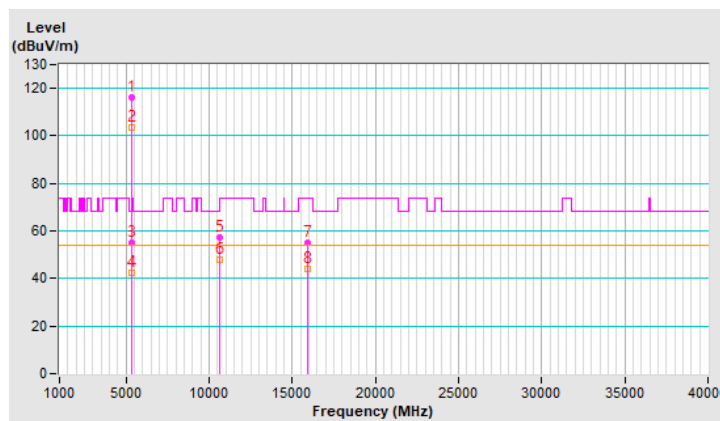

| | | | |
|-----------------------------|-----------------|--|---|
| RF Mode | 802.11ax (HE20) | Channel | CH 100 : 5500 MHz |
| Frequency Range | 1 GHz ~ 40 GHz | Detector Function & Bandwidth | (PK) RB = 1 MHz, VB = 3 MHz (AV) RB = 1 MHz, VB = 200 Hz |
| Input Power (System) | 56 Vdc | Environmental Conditions | 25°C, 75% RH |
| Tested By | Tom Yang | | |

| Antenna Polarity & Test Distance : Horizontal at 3 m | | | | | | | | |
|--|-----------------|-------------------------|----------------|-------------|--------------------|----------------------|------------------|--------------------------|
| No | Frequency (MHz) | Emission Level (dBuV/m) | Limit (dBuV/m) | Margin (dB) | Antenna Height (m) | Table Angle (Degree) | Raw Value (dBuV) | Correction Factor (dB/m) |
| 1 | 5460.00 | 62.2 PK | 74.0 | -11.8 | 1.49 H | 280 | 60.9 | 1.3 |
| 2 | 5460.00 | 47.9 AV | 54.0 | -6.1 | 1.49 H | 280 | 46.6 | 1.3 |
| 3 | #5468.45 | 67.8 PK | 68.2 | -0.4 | 1.49 H | 280 | 66.5 | 1.3 |
| 4 | *5500.00 | 118.0 PK | | | 1.49 H | 280 | 116.7 | 1.3 |
| 5 | *5500.00 | 106.7 AV | | | 1.49 H | 280 | 105.4 | 1.3 |
| 6 | 11000.00 | 57.6 PK | 74.0 | -16.4 | 1.50 H | 253 | 45.8 | 11.8 |
| 7 | 11000.00 | 48.1 AV | 54.0 | -5.9 | 1.50 H | 253 | 36.3 | 11.8 |
| 8 | #16500.00 | 55.5 PK | 68.2 | -12.7 | 3.16 H | 249 | 41.4 | 14.1 |

Remarks:

1. Emission Level(dBuV/m) = Raw Value(dBuV) + Correction Factor(dB/m)
2. Correction Factor(dB/m) = Antenna Factor(dB/m) + Cable Factor(dB) – Pre-Amplifier Factor(dB)
3. Margin value = Emission Level – Limit value
4. The other emission levels were very low against the limit.
5. " * " : Fundamental frequency, the limit was restricted at the RF Output Power.
6. " # " : The radiated frequency is out of the restricted band.

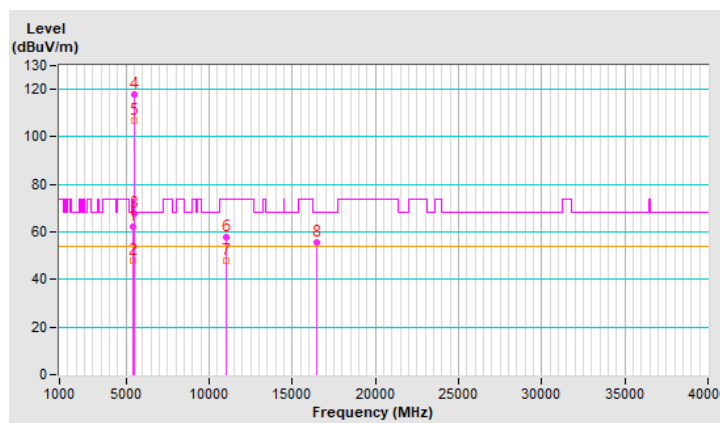

| | | | |
|-----------------------------|-----------------|--|---|
| RF Mode | 802.11ax (HE20) | Channel | CH 100 : 5500 MHz |
| Frequency Range | 1 GHz ~ 40 GHz | Detector Function & Bandwidth | (PK) RB = 1 MHz, VB = 3 MHz (AV) RB = 1 MHz, VB = 200 Hz |
| Input Power (System) | 56 Vdc | Environmental Conditions | 25°C, 75% RH |
| Tested By | Tom Yang | | |

| Antenna Polarity & Test Distance : Vertical at 3 m | | | | | | | | |
|--|-----------------|-------------------------|----------------|-------------|--------------------|----------------------|------------------|--------------------------|
| No | Frequency (MHz) | Emission Level (dBuV/m) | Limit (dBuV/m) | Margin (dB) | Antenna Height (m) | Table Angle (Degree) | Raw Value (dBuV) | Correction Factor (dB/m) |
| 1 | 5460.00 | 53.6 PK | 74.0 | -20.4 | 1.54 V | 18 | 52.3 | 1.3 |
| 2 | 5460.00 | 41.0 AV | 54.0 | -13.0 | 1.54 V | 18 | 39.7 | 1.3 |
| 3 | #5470.00 | 63.1 PK | 68.2 | -5.1 | 1.54 V | 18 | 61.8 | 1.3 |
| 4 | *5500.00 | 115.7 PK | | | 1.54 V | 18 | 114.4 | 1.3 |
| 5 | *5500.00 | 104.4 AV | | | 1.54 V | 18 | 103.1 | 1.3 |
| 6 | 11000.00 | 56.8 PK | 74.0 | -17.2 | 1.82 V | 199 | 45.0 | 11.8 |
| 7 | 11000.00 | 47.9 AV | 54.0 | -6.1 | 1.82 V | 199 | 36.1 | 11.8 |
| 8 | #16500.00 | 55.1 PK | 68.2 | -13.1 | 1.65 V | 108 | 41.0 | 14.1 |

Remarks:

1. Emission Level(dBuV/m) = Raw Value(dBuV) + Correction Factor(dB/m)
2. Correction Factor(dB/m) = Antenna Factor(dB/m) + Cable Factor(dB) – Pre-Amplifier Factor(dB)
3. Margin value = Emission Level – Limit value
4. The other emission levels were very low against the limit.
5. " * " : Fundamental frequency, the limit was restricted at the RF Output Power.
6. " # " : The radiated frequency is out of the restricted band.

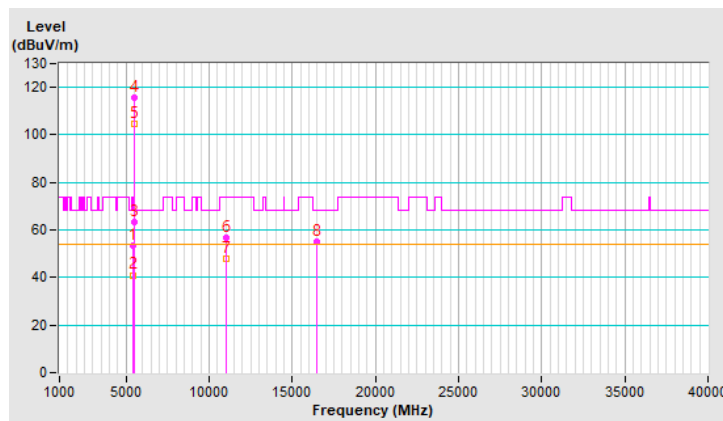

| | | | |
|-----------------------------|-----------------|--|---|
| RF Mode | 802.11ax (HE20) | Channel | CH 116 : 5580 MHz |
| Frequency Range | 1 GHz ~ 40 GHz | Detector Function & Bandwidth | (PK) RB = 1 MHz, VB = 3 MHz (AV) RB = 1 MHz, VB = 200 Hz |
| Input Power (System) | 56 Vdc | Environmental Conditions | 25°C, 75% RH |
| Tested By | Tom Yang | | |

| Antenna Polarity & Test Distance : Horizontal at 3 m | | | | | | | | |
|--|-----------------|-------------------------|----------------|-------------|--------------------|----------------------|------------------|--------------------------|
| No | Frequency (MHz) | Emission Level (dBuV/m) | Limit (dBuV/m) | Margin (dB) | Antenna Height (m) | Table Angle (Degree) | Raw Value (dBuV) | Correction Factor (dB/m) |
| 1 | *5580.00 | 119.7 PK | | | 3.22 H | 289 | 118.4 | 1.3 |
| 2 | *5580.00 | 110.0 AV | | | 3.22 H | 289 | 108.7 | 1.3 |
| 3 | 11160.00 | 58.2 PK | 74.0 | -15.8 | 1.53 H | 235 | 46.8 | 11.4 |
| 4 | 11160.00 | 48.8 AV | 54.0 | -5.2 | 1.53 H | 235 | 37.4 | 11.4 |
| 5 | #16740.00 | 55.9 PK | 68.2 | -12.3 | 3.18 H | 266 | 41.1 | 14.8 |

Remarks:

1. Emission Level(dBuV/m) = Raw Value(dBuV) + Correction Factor(dB/m)
2. Correction Factor(dB/m) = Antenna Factor(dB/m) + Cable Factor(dB) – Pre-Amplifier Factor(dB)
3. Margin value = Emission Level – Limit value
4. The other emission levels were very low against the limit.
5. " * " : Fundamental frequency, the limit was restricted at the RF Output Power.
6. " # " : The radiated frequency is out of the restricted band.

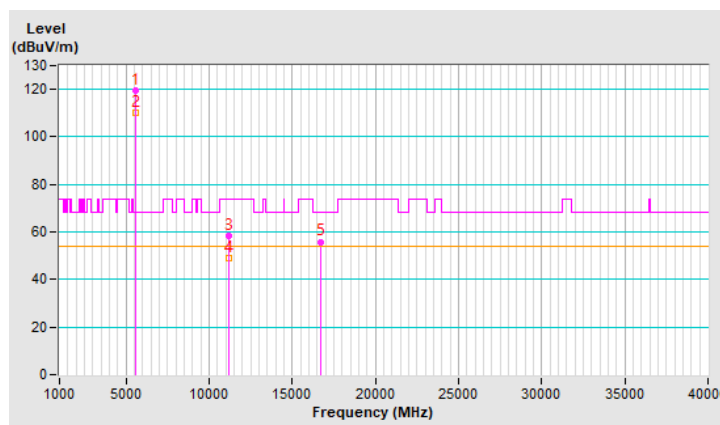

| | | | |
|-----------------------------|-----------------|--|---|
| RF Mode | 802.11ax (HE20) | Channel | CH 116 : 5580 MHz |
| Frequency Range | 1 GHz ~ 40 GHz | Detector Function & Bandwidth | (PK) RB = 1 MHz, VB = 3 MHz (AV) RB = 1 MHz, VB = 200 Hz |
| Input Power (System) | 56 Vdc | Environmental Conditions | 25°C, 75% RH |
| Tested By | Tom Yang | | |

| Antenna Polarity & Test Distance : Vertical at 3 m | | | | | | | | |
|--|-----------------|-------------------------|----------------|-------------|--------------------|----------------------|------------------|--------------------------|
| No | Frequency (MHz) | Emission Level (dBuV/m) | Limit (dBuV/m) | Margin (dB) | Antenna Height (m) | Table Angle (Degree) | Raw Value (dBuV) | Correction Factor (dB/m) |
| 1 | *5580.00 | 117.7 PK | | | 1.10 V | 16 | 116.4 | 1.3 |
| 2 | *5580.00 | 105.6 AV | | | 1.10 V | 16 | 104.3 | 1.3 |
| 3 | 11160.00 | 56.6 PK | 74.0 | -17.4 | 1.76 V | 207 | 45.2 | 11.4 |
| 4 | 11160.00 | 47.6 AV | 54.0 | -6.4 | 1.76 V | 207 | 36.2 | 11.4 |
| 5 | #16740.00 | 54.5 PK | 68.2 | -13.7 | 1.60 V | 105 | 39.7 | 14.8 |

Remarks:

1. Emission Level(dBuV/m) = Raw Value(dBuV) + Correction Factor(dB/m)
2. Correction Factor(dB/m) = Antenna Factor(dB/m) + Cable Factor(dB) – Pre-Amplifier Factor(dB)
3. Margin value = Emission Level – Limit value
4. The other emission levels were very low against the limit.
5. " * " : Fundamental frequency, the limit was restricted at the RF Output Power.
6. " # " : The radiated frequency is out of the restricted band.

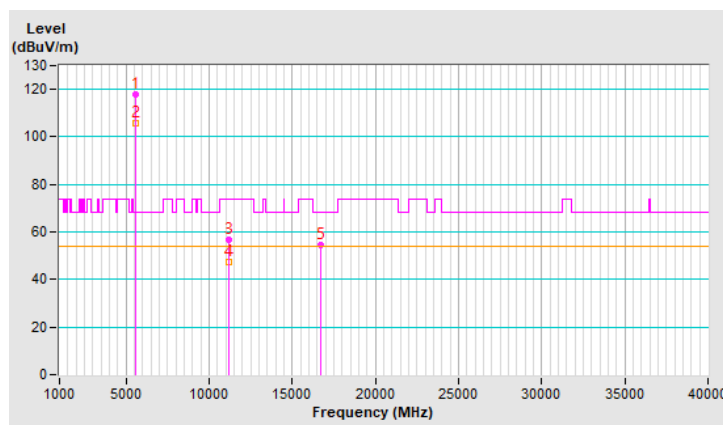

| | | | |
|-----------------------------|-----------------|--|---|
| RF Mode | 802.11ax (HE20) | Channel | CH 140 : 5700 MHz |
| Frequency Range | 1 GHz ~ 40 GHz | Detector Function & Bandwidth | (PK) RB = 1 MHz, VB = 3 MHz (AV) RB = 1 MHz, VB = 200 Hz |
| Input Power (System) | 56 Vdc | Environmental Conditions | 25°C, 75% RH |
| Tested By | Tom Yang | | |

| Antenna Polarity & Test Distance : Horizontal at 3 m | | | | | | | | |
|--|-----------------|-------------------------|----------------|-------------|--------------------|----------------------|------------------|--------------------------|
| No | Frequency (MHz) | Emission Level (dBuV/m) | Limit (dBuV/m) | Margin (dB) | Antenna Height (m) | Table Angle (Degree) | Raw Value (dBuV) | Correction Factor (dB/m) |
| 1 | *5700.00 | 120.0 PK | | | 2.34 H | 77 | 118.1 | 1.9 |
| 2 | *5700.00 | 109.3 AV | | | 2.34 H | 77 | 107.4 | 1.9 |
| 3 | #5725.00 | 67.7 PK | 68.2 | -0.5 | 2.34 H | 77 | 65.7 | 2.0 |
| 4 | 11400.00 | 57.8 PK | 74.0 | -16.2 | 1.44 H | 246 | 45.8 | 12.0 |
| 5 | 11400.00 | 48.5 AV | 54.0 | -5.5 | 1.44 H | 246 | 36.5 | 12.0 |
| 6 | #17100.00 | 55.0 PK | 68.2 | -13.2 | 3.19 H | 255 | 39.1 | 15.9 |

Remarks:

1. Emission Level(dBuV/m) = Raw Value(dBuV) + Correction Factor(dB/m)
2. Correction Factor(dB/m) = Antenna Factor(dB/m) + Cable Factor(dB) – Pre-Amplifier Factor(dB)
3. Margin value = Emission Level – Limit value
4. The other emission levels were very low against the limit.
5. " * " : Fundamental frequency, the limit was restricted at the RF Output Power.
6. " # " : The radiated frequency is out of the restricted band.

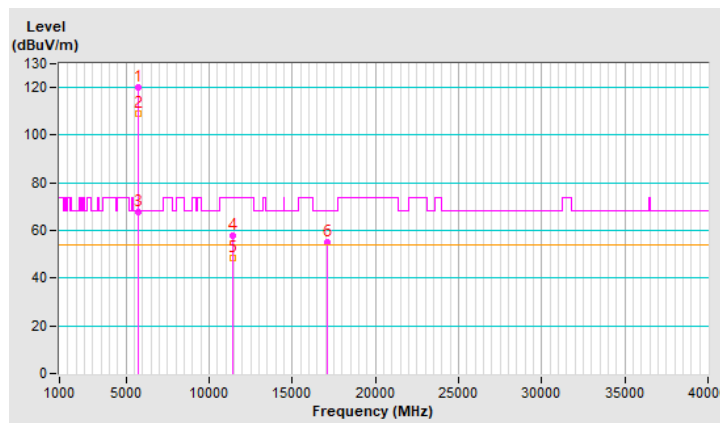

| | | | |
|-----------------------------|-----------------|--|---|
| RF Mode | 802.11ax (HE20) | Channel | CH 140 : 5700 MHz |
| Frequency Range | 1 GHz ~ 40 GHz | Detector Function & Bandwidth | (PK) RB = 1 MHz, VB = 3 MHz (AV) RB = 1 MHz, VB = 200 Hz |
| Input Power (System) | 56 Vdc | Environmental Conditions | 25°C, 75% RH |
| Tested By | Tom Yang | | |

| Antenna Polarity & Test Distance : Vertical at 3 m | | | | | | | | |
|--|-----------------|-------------------------|----------------|-------------|--------------------|----------------------|------------------|--------------------------|
| No | Frequency (MHz) | Emission Level (dBuV/m) | Limit (dBuV/m) | Margin (dB) | Antenna Height (m) | Table Angle (Degree) | Raw Value (dBuV) | Correction Factor (dB/m) |
| 1 | *5700.00 | 116.0 PK | | | 1.27 V | 13 | 114.1 | 1.9 |
| 2 | *5700.00 | 103.6 AV | | | 1.27 V | 13 | 101.7 | 1.9 |
| 3 | #5725.00 | 49.7 PK | 68.2 | -18.5 | 1.27 V | 13 | 47.7 | 2.0 |
| 4 | 11400.00 | 57.3 PK | 74.0 | -16.7 | 1.75 V | 201 | 45.3 | 12.0 |
| 5 | 11400.00 | 47.9 AV | 54.0 | -6.1 | 1.75 V | 201 | 35.9 | 12.0 |
| 6 | #17100.00 | 55.3 PK | 68.2 | -12.9 | 1.57 V | 95 | 39.4 | 15.9 |

Remarks:

1. Emission Level(dBuV/m) = Raw Value(dBuV) + Correction Factor(dB/m)
2. Correction Factor(dB/m) = Antenna Factor(dB/m) + Cable Factor(dB) – Pre-Amplifier Factor(dB)
3. Margin value = Emission Level – Limit value
4. The other emission levels were very low against the limit.
5. " * " : Fundamental frequency, the limit was restricted at the RF Output Power.
6. " # " : The radiated frequency is out of the restricted band.

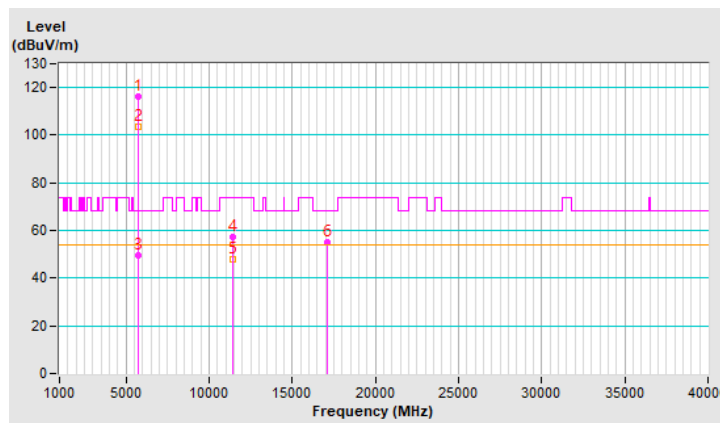

| | | | |
|-----------------------------|-----------------|--|---|
| RF Mode | 802.11ax (HE20) | Channel | CH 144 : 5720 MHz |
| Frequency Range | 1 GHz ~ 40 GHz | Detector Function & Bandwidth | (PK) RB = 1 MHz, VB = 3 MHz (AV) RB = 1 MHz, VB = 200 Hz |
| Input Power (System) | 56 Vdc | Environmental Conditions | 25°C, 75% RH |
| Tested By | Tom Yang | | |

| Antenna Polarity & Test Distance : Horizontal at 3 m | | | | | | | | |
|--|-----------------|-------------------------|----------------|-------------|--------------------|----------------------|------------------|--------------------------|
| No | Frequency (MHz) | Emission Level (dBuV/m) | Limit (dBuV/m) | Margin (dB) | Antenna Height (m) | Table Angle (Degree) | Raw Value (dBuV) | Correction Factor (dB/m) |
| 1 | 5460.00 | 48.7 PK | 74.0 | -25.3 | 3.24 H | 282 | 47.4 | 1.3 |
| 2 | 5460.00 | 38.5 AV | 54.0 | -15.5 | 3.24 H | 282 | 37.2 | 1.3 |
| 3 | #5470.00 | 49.3 PK | 68.2 | -18.9 | 3.24 H | 282 | 48.0 | 1.3 |
| 4 | *5720.00 | 120.1 PK | | | 3.24 H | 282 | 118.1 | 2.0 |
| 5 | *5720.00 | 109.9 AV | | | 3.24 H | 282 | 107.9 | 2.0 |
| 6 | #5850.00 | 48.8 PK | 68.2 | -19.4 | 3.24 H | 282 | 46.8 | 2.0 |
| 7 | 11440.00 | 57.9 PK | 74.0 | -16.1 | 1.47 H | 234 | 46.0 | 11.9 |
| 8 | 11440.00 | 48.5 AV | 54.0 | -5.5 | 1.47 H | 234 | 36.6 | 11.9 |
| 9 | #17160.00 | 55.3 PK | 68.2 | -12.9 | 3.20 H | 261 | 39.5 | 15.8 |

Remarks:

1. Emission Level(dBuV/m) = Raw Value(dBuV) + Correction Factor(dB/m)
2. Correction Factor(dB/m) = Antenna Factor(dB/m) + Cable Factor(dB) – Pre-Amplifier Factor(dB)
3. Margin value = Emission Level – Limit value
4. The other emission levels were very low against the limit.
5. " * " : Fundamental frequency, the limit was restricted at the RF Output Power.
6. " # " : The radiated frequency is out of the restricted band.

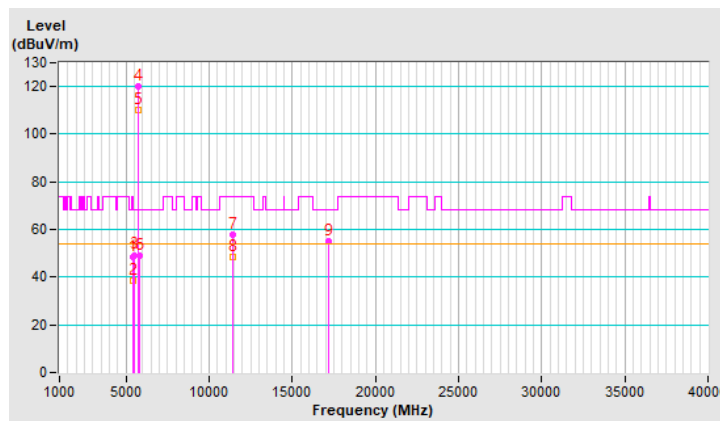

| | | | |
|-----------------------------|-----------------|--|---|
| RF Mode | 802.11ax (HE20) | Channel | CH 144 : 5720 MHz |
| Frequency Range | 1 GHz ~ 40 GHz | Detector Function & Bandwidth | (PK) RB = 1 MHz, VB = 3 MHz (AV) RB = 1 MHz, VB = 200 Hz |
| Input Power (System) | 56 Vdc | Environmental Conditions | 25°C, 75% RH |
| Tested By | Tom Yang | | |

| Antenna Polarity & Test Distance : Vertical at 3 m | | | | | | | | |
|--|-----------------|-------------------------|----------------|-------------|--------------------|----------------------|------------------|--------------------------|
| No | Frequency (MHz) | Emission Level (dBuV/m) | Limit (dBuV/m) | Margin (dB) | Antenna Height (m) | Table Angle (Degree) | Raw Value (dBuV) | Correction Factor (dB/m) |
| 1 | 5460.00 | 48.6 PK | 74.0 | -25.4 | 1.14 V | 15 | 47.3 | 1.3 |
| 2 | 5460.00 | 38.6 AV | 54.0 | -15.4 | 1.14 V | 15 | 37.3 | 1.3 |
| 3 | #5470.00 | 49.3 PK | 68.2 | -18.9 | 1.14 V | 15 | 48.0 | 1.3 |
| 4 | *5720.00 | 117.8 PK | | | 1.14 V | 15 | 115.8 | 2.0 |
| 5 | *5720.00 | 106.1 AV | | | 1.14 V | 15 | 104.1 | 2.0 |
| 6 | #5850.00 | 49.7 PK | 68.2 | -18.5 | 1.14 V | 15 | 47.7 | 2.0 |
| 7 | 11440.00 | 57.4 PK | 74.0 | -16.6 | 1.76 V | 203 | 45.5 | 11.9 |
| 8 | 11440.00 | 48.2 AV | 54.0 | -5.8 | 1.76 V | 203 | 36.3 | 11.9 |
| 9 | #17160.00 | 54.5 PK | 68.2 | -13.7 | 1.63 V | 100 | 38.7 | 15.8 |

Remarks:

1. Emission Level(dBuV/m) = Raw Value(dBuV) + Correction Factor(dB/m)
2. Correction Factor(dB/m) = Antenna Factor(dB/m) + Cable Factor(dB) – Pre-Amplifier Factor(dB)
3. Margin value = Emission Level – Limit value
4. The other emission levels were very low against the limit.
5. " * " : Fundamental frequency, the limit was restricted at the RF Output Power.
6. " # " : The radiated frequency is out of the restricted band.

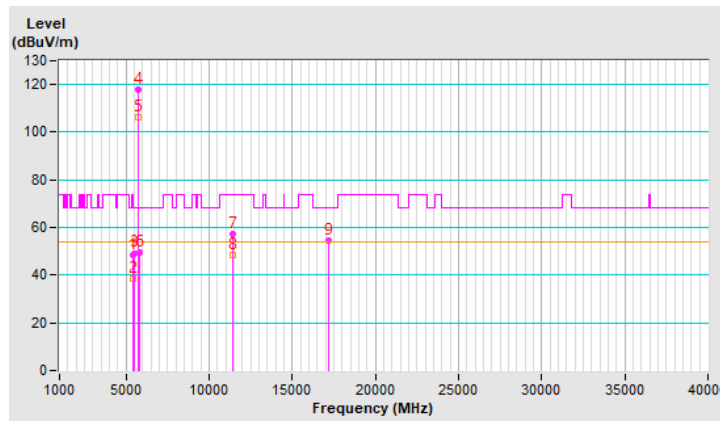

| | | | |
|-----------------------------|-----------------|--|---|
| RF Mode | 802.11ax (HE40) | Channel | CH 54 : 5270 MHz |
| Frequency Range | 1 GHz ~ 40 GHz | Detector Function & Bandwidth | (PK) RB = 1 MHz, VB = 3 MHz (AV) RB = 1 MHz, VB = 200 Hz |
| Input Power (System) | 56 Vdc | Environmental Conditions | 25°C, 75% RH |
| Tested By | Tom Yang | | |

| Antenna Polarity & Test Distance : Horizontal at 3 m | | | | | | | | |
|--|-----------------|-------------------------|----------------|-------------|--------------------|----------------------|------------------|--------------------------|
| No | Frequency (MHz) | Emission Level (dBuV/m) | Limit (dBuV/m) | Margin (dB) | Antenna Height (m) | Table Angle (Degree) | Raw Value (dBuV) | Correction Factor (dB/m) |
| 1 | *5270.00 | 118.0 PK | | | 2.55 H | 55 | 117.2 | 0.8 |
| 2 | *5270.00 | 107.7 AV | | | 2.55 H | 55 | 106.9 | 0.8 |
| 3 | 5350.00 | 62.0 PK | 74.0 | -12.0 | 2.55 H | 55 | 60.9 | 1.1 |
| 4 | 5350.00 | 51.3 AV | 54.0 | -2.7 | 2.55 H | 55 | 50.2 | 1.1 |
| 5 | #10540.00 | 59.1 PK | 68.2 | -9.1 | 1.50 H | 246 | 48.0 | 11.1 |
| 6 | 15810.00 | 55.1 PK | 74.0 | -18.9 | 3.10 H | 253 | 43.8 | 11.3 |
| 7 | 15810.00 | 43.9 AV | 54.0 | -10.1 | 3.10 H | 253 | 32.6 | 11.3 |

Remarks:

1. Emission Level(dBuV/m) = Raw Value(dBuV) + Correction Factor(dB/m)
2. Correction Factor(dB/m) = Antenna Factor(dB/m) + Cable Factor(dB) – Pre-Amplifier Factor(dB)
3. Margin value = Emission Level – Limit value
4. The other emission levels were very low against the limit.
5. " * " : Fundamental frequency, the limit was restricted at the RF Output Power.
6. " # " : The radiated frequency is out of the restricted band.

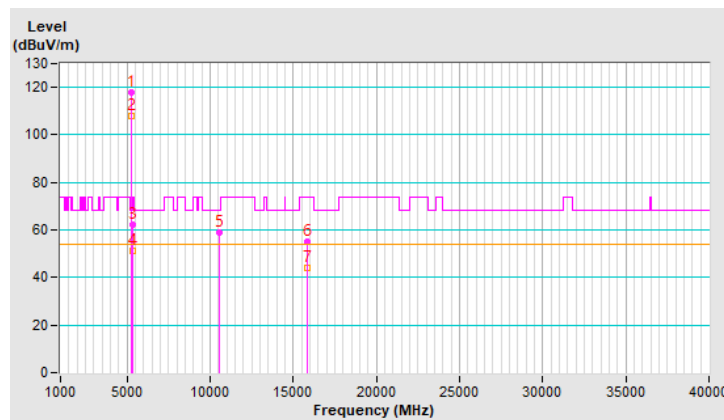

| | | | |
|-----------------------------|-----------------|--|---|
| RF Mode | 802.11ax (HE40) | Channel | CH 54 : 5270 MHz |
| Frequency Range | 1 GHz ~ 40 GHz | Detector Function & Bandwidth | (PK) RB = 1 MHz, VB = 3 MHz (AV) RB = 1 MHz, VB = 200 Hz |
| Input Power (System) | 56 Vdc | Environmental Conditions | 25°C, 75% RH |
| Tested By | Tom Yang | | |

| Antenna Polarity & Test Distance : Vertical at 3 m | | | | | | | | |
|--|-----------------|-------------------------|----------------|-------------|--------------------|----------------------|------------------|--------------------------|
| No | Frequency (MHz) | Emission Level (dBuV/m) | Limit (dBuV/m) | Margin (dB) | Antenna Height (m) | Table Angle (Degree) | Raw Value (dBuV) | Correction Factor (dB/m) |
| 1 | *5270.00 | 117.6 PK | | | 1.02 V | 27 | 116.8 | 0.8 |
| 2 | *5270.00 | 105.8 AV | | | 1.02 V | 27 | 105.0 | 0.8 |
| 3 | 5350.00 | 66.1 PK | 74.0 | -7.9 | 1.02 V | 27 | 65.0 | 1.1 |
| 4 | 5350.00 | 50.9 AV | 54.0 | -3.1 | 1.02 V | 27 | 49.8 | 1.1 |
| 5 | #10540.00 | 58.4 PK | 68.2 | -9.8 | 2.39 V | 210 | 47.3 | 11.1 |
| 6 | 15810.00 | 55.1 PK | 74.0 | -18.9 | 1.61 V | 116 | 43.8 | 11.3 |
| 7 | 15810.00 | 43.7 AV | 54.0 | -10.3 | 1.61 V | 116 | 32.4 | 11.3 |

Remarks:

1. Emission Level(dBuV/m) = Raw Value(dBuV) + Correction Factor(dB/m)
2. Correction Factor(dB/m) = Antenna Factor(dB/m) + Cable Factor(dB) – Pre-Amplifier Factor(dB)
3. Margin value = Emission Level – Limit value
4. The other emission levels were very low against the limit.
5. " * " : Fundamental frequency, the limit was restricted at the RF Output Power.
6. " # " : The radiated frequency is out of the restricted band.

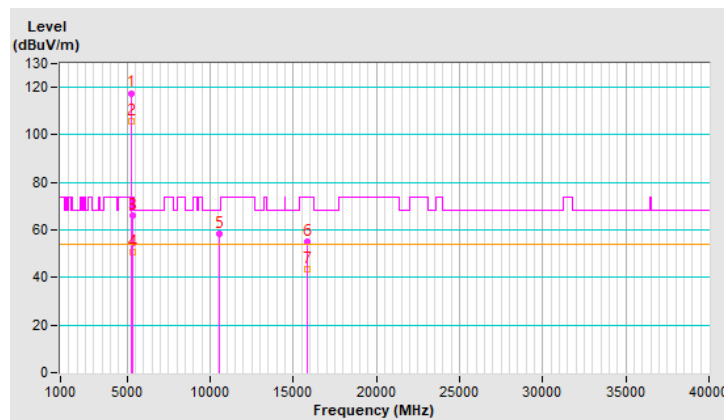

| | | | |
|-----------------------------|-----------------|--|---|
| RF Mode | 802.11ax (HE40) | Channel | CH 62 : 5310 MHz |
| Frequency Range | 1 GHz ~ 40 GHz | Detector Function & Bandwidth | (PK) RB = 1 MHz, VB = 3 MHz (AV) RB = 1 MHz, VB = 200 Hz |
| Input Power (System) | 56 Vdc | Environmental Conditions | 25°C, 75% RH |
| Tested By | Tom Yang | | |

| Antenna Polarity & Test Distance : Horizontal at 3 m | | | | | | | | |
|--|-----------------|-------------------------|----------------|-------------|--------------------|----------------------|------------------|--------------------------|
| No | Frequency (MHz) | Emission Level (dBuV/m) | Limit (dBuV/m) | Margin (dB) | Antenna Height (m) | Table Angle (Degree) | Raw Value (dBuV) | Correction Factor (dB/m) |
| 1 | *5310.00 | 113.5 PK | | | 2.55 H | 280 | 112.6 | 0.9 |
| 2 | *5310.00 | 102.7 AV | | | 2.55 H | 280 | 101.8 | 0.9 |
| 3 | 5350.00 | 63.1 PK | 74.0 | -10.9 | 2.55 H | 280 | 62.0 | 1.1 |
| 4 | 5350.00 | 53.7 AV | 54.0 | -0.3 | 2.55 H | 280 | 52.6 | 1.1 |
| 5 | 10620.00 | 59.3 PK | 74.0 | -14.7 | 1.47 H | 239 | 48.4 | 10.9 |
| 6 | 10620.00 | 48.3 AV | 54.0 | -5.7 | 1.47 H | 239 | 37.4 | 10.9 |
| 7 | 15930.00 | 54.9 PK | 74.0 | -19.1 | 3.05 H | 270 | 43.0 | 11.9 |
| 8 | 15930.00 | 43.9 AV | 54.0 | -10.1 | 3.05 H | 270 | 32.0 | 11.9 |

Remarks:

1. Emission Level(dBuV/m) = Raw Value(dBuV) + Correction Factor(dB/m)
2. Correction Factor(dB/m) = Antenna Factor(dB/m) + Cable Factor(dB) – Pre-Amplifier Factor(dB)
3. Margin value = Emission Level – Limit value
4. The other emission levels were very low against the limit.
5. " * ": Fundamental frequency, the limit was restricted at the RF Output Power.

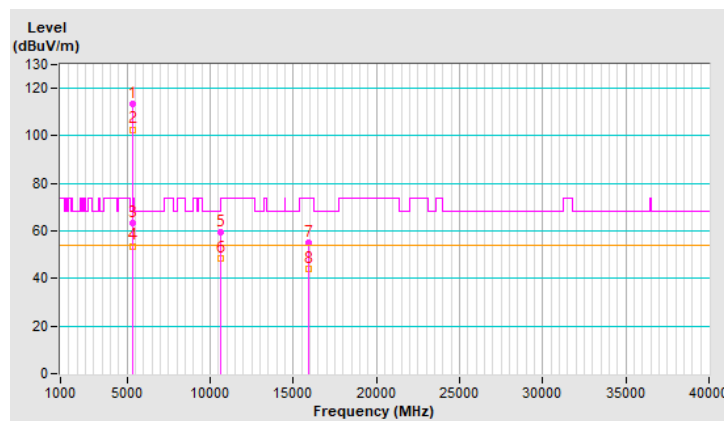

| | | | |
|-----------------------------|-----------------|--|---|
| RF Mode | 802.11ax (HE40) | Channel | CH 62 : 5310 MHz |
| Frequency Range | 1 GHz ~ 40 GHz | Detector Function & Bandwidth | (PK) RB = 1 MHz, VB = 3 MHz (AV) RB = 1 MHz, VB = 200 Hz |
| Input Power (System) | 56 Vdc | Environmental Conditions | 25°C, 75% RH |
| Tested By | Tom Yang | | |

| Antenna Polarity & Test Distance : Vertical at 3 m | | | | | | | | |
|--|-----------------|-------------------------|----------------|-------------|--------------------|----------------------|------------------|--------------------------|
| No | Frequency (MHz) | Emission Level (dBuV/m) | Limit (dBuV/m) | Margin (dB) | Antenna Height (m) | Table Angle (Degree) | Raw Value (dBuV) | Correction Factor (dB/m) |
| 1 | *5310.00 | 111.2 PK | | | 1.57 V | 36 | 110.3 | 0.9 |
| 2 | *5310.00 | 99.3 AV | | | 1.57 V | 36 | 98.4 | 0.9 |
| 3 | 5350.00 | 54.9 PK | 74.0 | -19.1 | 1.57 V | 36 | 53.8 | 1.1 |
| 4 | 5350.00 | 45.5 AV | 54.0 | -8.5 | 1.57 V | 36 | 44.4 | 1.1 |
| 5 | 10620.00 | 58.7 PK | 74.0 | -15.3 | 2.35 V | 182 | 47.8 | 10.9 |
| 6 | 10620.00 | 47.8 AV | 54.0 | -6.2 | 2.35 V | 182 | 36.9 | 10.9 |
| 7 | 15930.00 | 55.7 PK | 74.0 | -18.3 | 1.65 V | 101 | 43.8 | 11.9 |
| 8 | 15930.00 | 44.0 AV | 54.0 | -10.0 | 1.65 V | 101 | 32.1 | 11.9 |

Remarks:

1. Emission Level(dBuV/m) = Raw Value(dBuV) + Correction Factor(dB/m)
2. Correction Factor(dB/m) = Antenna Factor(dB/m) + Cable Factor(dB) – Pre-Amplifier Factor(dB)
3. Margin value = Emission Level – Limit value
4. The other emission levels were very low against the limit.
5. " * " : Fundamental frequency, the limit was restricted at the RF Output Power.

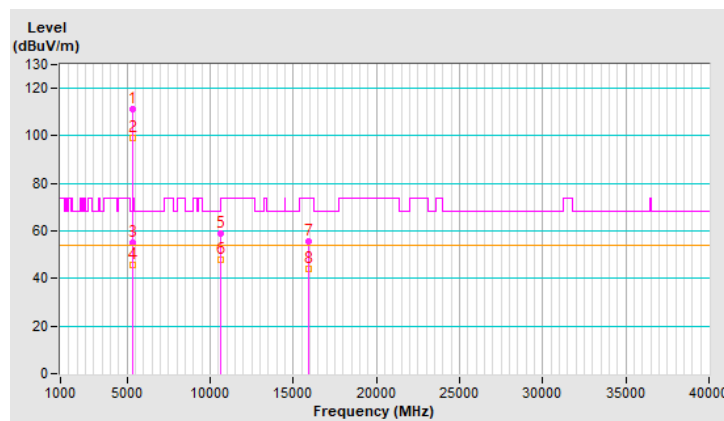

| | | | |
|-----------------------------|-----------------|--|---|
| RF Mode | 802.11ax (HE40) | Channel | CH 102 : 5510 MHz |
| Frequency Range | 1 GHz ~ 40 GHz | Detector Function & Bandwidth | (PK) RB = 1 MHz, VB = 3 MHz (AV) RB = 1 MHz, VB = 200 Hz |
| Input Power (System) | 56 Vdc | Environmental Conditions | 25°C, 75% RH |
| Tested By | Tom Yang | | |

| Antenna Polarity & Test Distance : Horizontal at 3 m | | | | | | | | |
|--|-----------------|-------------------------|----------------|-------------|--------------------|----------------------|------------------|--------------------------|
| No | Frequency (MHz) | Emission Level (dBuV/m) | Limit (dBuV/m) | Margin (dB) | Antenna Height (m) | Table Angle (Degree) | Raw Value (dBuV) | Correction Factor (dB/m) |
| 1 | 5456.04 | 55.9 PK | 74.0 | -18.1 | 3.03 H | 70 | 54.6 | 1.3 |
| 2 | 5456.04 | 42.3 AV | 54.0 | -11.7 | 3.03 H | 70 | 41.0 | 1.3 |
| 3 | #5470.00 | 67.7 PK | 68.2 | -0.5 | 3.03 H | 70 | 66.4 | 1.3 |
| 4 | *5510.00 | 116.7 PK | | | 3.03 H | 70 | 115.4 | 1.3 |
| 5 | *5510.00 | 104.3 AV | | | 3.03 H | 70 | 103.0 | 1.3 |
| 6 | 11020.00 | 59.4 PK | 74.0 | -14.6 | 1.48 H | 252 | 47.6 | 11.8 |
| 7 | 11020.00 | 48.4 AV | 54.0 | -5.6 | 1.48 H | 252 | 36.6 | 11.8 |
| 8 | #16530.00 | 55.4 PK | 68.2 | -12.8 | 3.05 H | 270 | 41.3 | 14.1 |

Remarks:

1. Emission Level(dBuV/m) = Raw Value(dBuV) + Correction Factor(dB/m)
2. Correction Factor(dB/m) = Antenna Factor(dB/m) + Cable Factor(dB) – Pre-Amplifier Factor(dB)
3. Margin value = Emission Level – Limit value
4. The other emission levels were very low against the limit.
5. " * " : Fundamental frequency, the limit was restricted at the RF Output Power.
6. " # " : The radiated frequency is out of the restricted band.

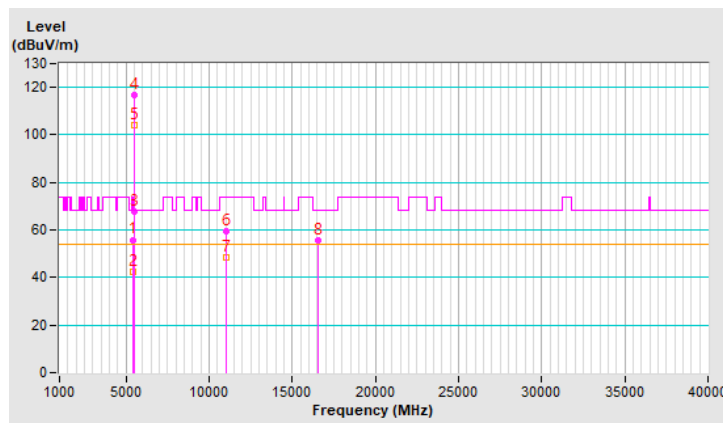

| | | | |
|-----------------------------|-----------------|--|---|
| RF Mode | 802.11ax (HE40) | Channel | CH 102 : 5510 MHz |
| Frequency Range | 1 GHz ~ 40 GHz | Detector Function & Bandwidth | (PK) RB = 1 MHz, VB = 3 MHz (AV) RB = 1 MHz, VB = 200 Hz |
| Input Power (System) | 56 Vdc | Environmental Conditions | 25°C, 75% RH |
| Tested By | Tom Yang | | |

| Antenna Polarity & Test Distance : Vertical at 3 m | | | | | | | | |
|--|-----------------|-------------------------|----------------|-------------|--------------------|----------------------|------------------|--------------------------|
| No | Frequency (MHz) | Emission Level (dBuV/m) | Limit (dBuV/m) | Margin (dB) | Antenna Height (m) | Table Angle (Degree) | Raw Value (dBuV) | Correction Factor (dB/m) |
| 1 | 5416.43 | 49.6 PK | 74.0 | -24.4 | 1.81 V | 19 | 48.4 | 1.2 |
| 2 | 5416.43 | 38.4 AV | 54.0 | -15.6 | 1.81 V | 19 | 37.2 | 1.2 |
| 3 | #5470.00 | 57.2 PK | 68.2 | -11.0 | 1.81 V | 19 | 55.9 | 1.3 |
| 4 | *5510.00 | 107.2 PK | | | 1.81 V | 19 | 105.9 | 1.3 |
| 5 | *5510.00 | 95.4 AV | | | 1.81 V | 19 | 94.1 | 1.3 |
| 6 | 11020.00 | 58.4 PK | 74.0 | -15.6 | 2.42 V | 190 | 46.6 | 11.8 |
| 7 | 11020.00 | 47.4 AV | 54.0 | -6.6 | 2.42 V | 190 | 35.6 | 11.8 |
| 8 | #16530.00 | 55.4 PK | 68.2 | -12.8 | 1.64 V | 124 | 41.3 | 14.1 |

Remarks:

1. Emission Level(dBuV/m) = Raw Value(dBuV) + Correction Factor(dB/m)
2. Correction Factor(dB/m) = Antenna Factor(dB/m) + Cable Factor(dB) – Pre-Amplifier Factor(dB)
3. Margin value = Emission Level – Limit value
4. The other emission levels were very low against the limit.
5. " * " : Fundamental frequency, the limit was restricted at the RF Output Power.
6. " # " : The radiated frequency is out of the restricted band.

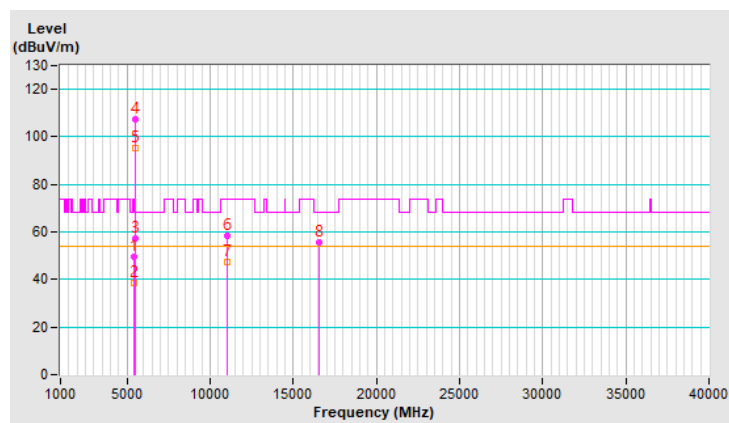

| | | | |
|-----------------------------|-----------------|--|---|
| RF Mode | 802.11ax (HE40) | Channel | CH 110 : 5550 MHz |
| Frequency Range | 1 GHz ~ 40 GHz | Detector Function & Bandwidth | (PK) RB = 1 MHz, VB = 3 MHz (AV) RB = 1 MHz, VB = 200 Hz |
| Input Power (System) | 56 Vdc | Environmental Conditions | 25°C, 75% RH |
| Tested By | Tom Yang | | |

| Antenna Polarity & Test Distance : Horizontal at 3 m | | | | | | | | |
|--|-----------------|-------------------------|----------------|-------------|--------------------|----------------------|------------------|--------------------------|
| No | Frequency (MHz) | Emission Level (dBuV/m) | Limit (dBuV/m) | Margin (dB) | Antenna Height (m) | Table Angle (Degree) | Raw Value (dBuV) | Correction Factor (dB/m) |
| 1 | *5550.00 | 118.7 PK | | | 2.50 H | 40 | 117.4 | 1.3 |
| 2 | *5550.00 | 108.1 AV | | | 2.50 H | 40 | 106.8 | 1.3 |
| 3 | 11100.00 | 59.4 PK | 74.0 | -14.6 | 1.43 H | 238 | 48.0 | 11.4 |
| 4 | 11100.00 | 48.3 AV | 54.0 | -5.7 | 1.43 H | 238 | 36.9 | 11.4 |
| 5 | #16650.00 | 55.9 PK | 68.2 | -12.3 | 3.11 H | 271 | 41.4 | 14.5 |

Remarks:

1. Emission Level(dBuV/m) = Raw Value(dBuV) + Correction Factor(dB/m)
2. Correction Factor(dB/m) = Antenna Factor(dB/m) + Cable Factor(dB) – Pre-Amplifier Factor(dB)
3. Margin value = Emission Level – Limit value
4. The other emission levels were very low against the limit.
5. " * " : Fundamental frequency, the limit was restricted at the RF Output Power.
6. " # " : The radiated frequency is out of the restricted band.

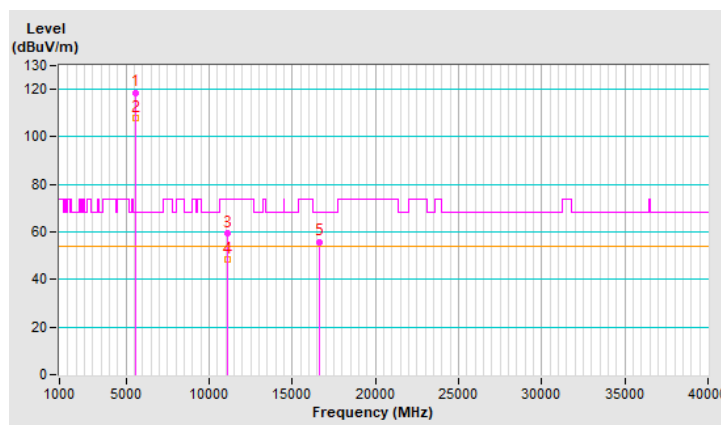

| | | | |
|-----------------------------|-----------------|--|---|
| RF Mode | 802.11ax (HE40) | Channel | CH 110 : 5550 MHz |
| Frequency Range | 1 GHz ~ 40 GHz | Detector Function & Bandwidth | (PK) RB = 1 MHz, VB = 3 MHz (AV) RB = 1 MHz, VB = 200 Hz |
| Input Power (System) | 56 Vdc | Environmental Conditions | 25°C, 75% RH |
| Tested By | Tom Yang | | |

| Antenna Polarity & Test Distance : Vertical at 3 m | | | | | | | | |
|--|-----------------|-------------------------|----------------|-------------|--------------------|----------------------|------------------|--------------------------|
| No | Frequency (MHz) | Emission Level (dBuV/m) | Limit (dBuV/m) | Margin (dB) | Antenna Height (m) | Table Angle (Degree) | Raw Value (dBuV) | Correction Factor (dB/m) |
| 1 | *5550.00 | 117.1 PK | | | 1.07 V | 34 | 115.8 | 1.3 |
| 2 | *5550.00 | 105.4 AV | | | 1.07 V | 34 | 104.1 | 1.3 |
| 3 | 11100.00 | 58.0 PK | 74.0 | -16.0 | 2.34 V | 185 | 46.6 | 11.4 |
| 4 | 11100.00 | 47.3 AV | 54.0 | -6.7 | 2.34 V | 185 | 35.9 | 11.4 |
| 5 | #16650.00 | 55.6 PK | 68.2 | -12.6 | 1.70 V | 116 | 41.1 | 14.5 |

Remarks:

1. Emission Level(dBuV/m) = Raw Value(dBuV) + Correction Factor(dB/m)
2. Correction Factor(dB/m) = Antenna Factor(dB/m) + Cable Factor(dB) – Pre-Amplifier Factor(dB)
3. Margin value = Emission Level – Limit value
4. The other emission levels were very low against the limit.
5. " * " : Fundamental frequency, the limit was restricted at the RF Output Power.
6. " # " : The radiated frequency is out of the restricted band.

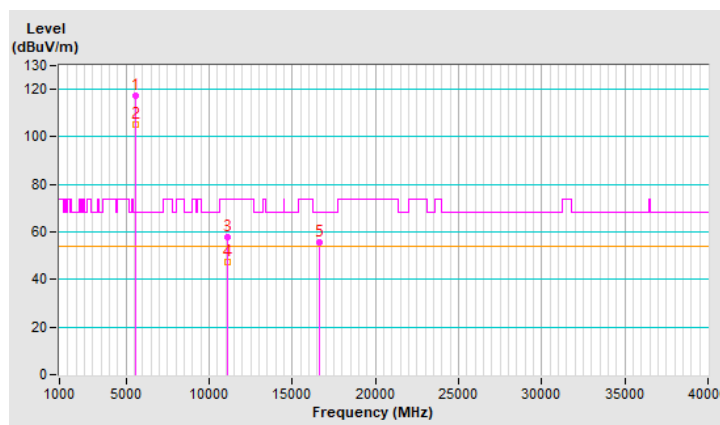

| | | | |
|-----------------------------|-----------------|--|---|
| RF Mode | 802.11ax (HE40) | Channel | CH 134 : 5670 MHz |
| Frequency Range | 1 GHz ~ 40 GHz | Detector Function & Bandwidth | (PK) RB = 1 MHz, VB = 3 MHz (AV) RB = 1 MHz, VB = 200 Hz |
| Input Power (System) | 56 Vdc | Environmental Conditions | 25°C, 75% RH |
| Tested By | Tom Yang | | |

| Antenna Polarity & Test Distance : Horizontal at 3 m | | | | | | | | |
|--|-----------------|-------------------------|----------------|-------------|--------------------|----------------------|------------------|--------------------------|
| No | Frequency (MHz) | Emission Level (dBuV/m) | Limit (dBuV/m) | Margin (dB) | Antenna Height (m) | Table Angle (Degree) | Raw Value (dBuV) | Correction Factor (dB/m) |
| 1 | *5670.00 | 117.6 PK | | | 1.62 H | 51 | 116.0 | 1.6 |
| 2 | *5670.00 | 106.3 AV | | | 1.62 H | 51 | 104.7 | 1.6 |
| 3 | #5725.00 | 67.9 PK | 68.2 | -0.3 | 1.62 H | 51 | 65.9 | 2.0 |
| 4 | 11340.00 | 59.4 PK | 74.0 | -14.6 | 1.41 H | 239 | 47.4 | 12.0 |
| 5 | 11340.00 | 48.5 AV | 54.0 | -5.5 | 1.41 H | 239 | 36.5 | 12.0 |
| 6 | #17010.00 | 55.2 PK | 68.2 | -13.0 | 3.03 H | 278 | 39.7 | 15.5 |

Remarks:

1. Emission Level(dBuV/m) = Raw Value(dBuV) + Correction Factor(dB/m)
2. Correction Factor(dB/m) = Antenna Factor(dB/m) + Cable Factor(dB) – Pre-Amplifier Factor(dB)
3. Margin value = Emission Level – Limit value
4. The other emission levels were very low against the limit.
5. " * " : Fundamental frequency, the limit was restricted at the RF Output Power.
6. " # " : The radiated frequency is out of the restricted band.

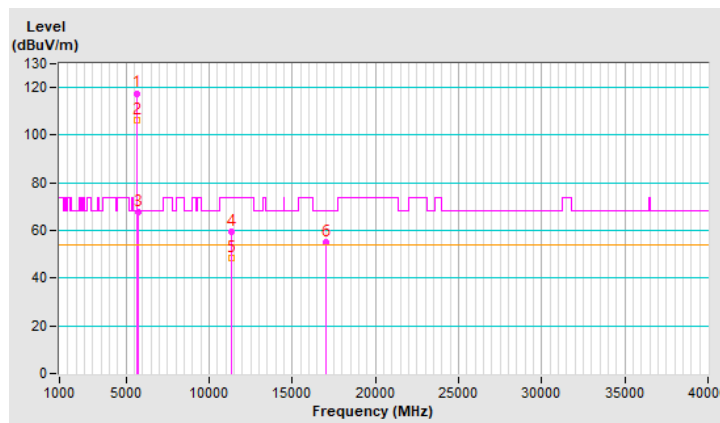

| | | | |
|-----------------------------|-----------------|--|---|
| RF Mode | 802.11ax (HE40) | Channel | CH 134 : 5670 MHz |
| Frequency Range | 1 GHz ~ 40 GHz | Detector Function & Bandwidth | (PK) RB = 1 MHz, VB = 3 MHz (AV) RB = 1 MHz, VB = 200 Hz |
| Input Power (System) | 56 Vdc | Environmental Conditions | 25°C, 75% RH |
| Tested By | Tom Yang | | |

| Antenna Polarity & Test Distance : Vertical at 3 m | | | | | | | | |
|--|-----------------|-------------------------|----------------|-------------|--------------------|----------------------|------------------|--------------------------|
| No | Frequency (MHz) | Emission Level (dBuV/m) | Limit (dBuV/m) | Margin (dB) | Antenna Height (m) | Table Angle (Degree) | Raw Value (dBuV) | Correction Factor (dB/m) |
| 1 | *5670.00 | 117.4 PK | | | 1.06 V | 16 | 115.8 | 1.6 |
| 2 | *5670.00 | 105.3 AV | | | 1.06 V | 16 | 103.7 | 1.6 |
| 3 | #5725.00 | 49.8 PK | 68.2 | -18.4 | 1.06 V | 16 | 47.8 | 2.0 |
| 4 | 11340.00 | 58.3 PK | 74.0 | -15.7 | 2.38 V | 200 | 46.3 | 12.0 |
| 5 | 11340.00 | 47.6 AV | 54.0 | -6.4 | 2.38 V | 200 | 35.6 | 12.0 |
| 6 | #17010.00 | 55.6 PK | 68.2 | -12.6 | 1.71 V | 124 | 40.1 | 15.5 |

Remarks:

1. Emission Level(dBuV/m) = Raw Value(dBuV) + Correction Factor(dB/m)
2. Correction Factor(dB/m) = Antenna Factor(dB/m) + Cable Factor(dB) – Pre-Amplifier Factor(dB)
3. Margin value = Emission Level – Limit value
4. The other emission levels were very low against the limit.
5. " * " : Fundamental frequency, the limit was restricted at the RF Output Power.
6. " # " : The radiated frequency is out of the restricted band.

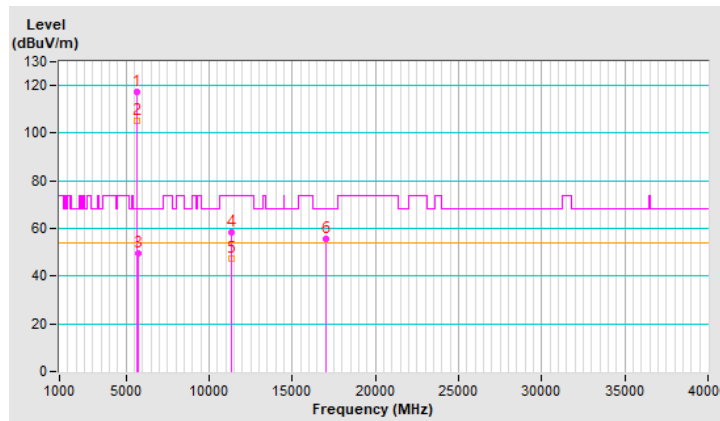

| | | | |
|-----------------------------|-----------------|--|---|
| RF Mode | 802.11ax (HE40) | Channel | CH 142 : 5710 MHz |
| Frequency Range | 1 GHz ~ 40 GHz | Detector Function & Bandwidth | (PK) RB = 1 MHz, VB = 3 MHz (AV) RB = 1 MHz, VB = 200 Hz |
| Input Power (System) | 56 Vdc | Environmental Conditions | 25°C, 75% RH |
| Tested By | Tom Yang | | |

| Antenna Polarity & Test Distance : Horizontal at 3 m | | | | | | | | |
|--|-----------------|-------------------------|----------------|-------------|--------------------|----------------------|------------------|--------------------------|
| No | Frequency (MHz) | Emission Level (dBuV/m) | Limit (dBuV/m) | Margin (dB) | Antenna Height (m) | Table Angle (Degree) | Raw Value (dBuV) | Correction Factor (dB/m) |
| 1 | 5460.00 | 50.6 PK | 74.0 | -23.4 | 1.56 H | 52 | 49.3 | 1.3 |
| 2 | 5460.00 | 38.6 AV | 54.0 | -15.4 | 1.56 H | 52 | 37.3 | 1.3 |
| 3 | #5470.00 | 50.5 PK | 68.2 | -17.7 | 1.56 H | 52 | 49.2 | 1.3 |
| 4 | *5710.00 | 118.6 PK | | | 1.56 H | 52 | 116.7 | 1.9 |
| 5 | *5710.00 | 106.7 AV | | | 1.56 H | 52 | 104.8 | 1.9 |
| 6 | #5850.00 | 51.6 PK | 68.2 | -16.6 | 1.56 H | 52 | 49.6 | 2.0 |
| 7 | 11420.00 | 59.0 PK | 74.0 | -15.0 | 1.42 H | 258 | 47.1 | 11.9 |
| 8 | 11420.00 | 47.9 AV | 54.0 | -6.1 | 1.42 H | 258 | 36.0 | 11.9 |
| 9 | #17130.00 | 55.1 PK | 68.2 | -13.1 | 3.13 H | 265 | 39.3 | 15.8 |

Remarks:

1. Emission Level(dBuV/m) = Raw Value(dBuV) + Correction Factor(dB/m)
2. Correction Factor(dB/m) = Antenna Factor(dB/m) + Cable Factor(dB) – Pre-Amplifier Factor(dB)
3. Margin value = Emission Level – Limit value
4. The other emission levels were very low against the limit.
5. " * " : Fundamental frequency, the limit was restricted at the RF Output Power.
6. " # " : The radiated frequency is out of the restricted band.

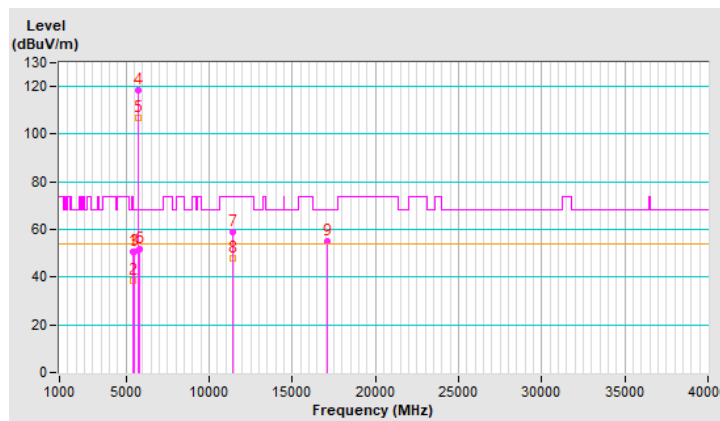

| | | | |
|-----------------------------|-----------------|--|---|
| RF Mode | 802.11ax (HE40) | Channel | CH 142 : 5710 MHz |
| Frequency Range | 1 GHz ~ 40 GHz | Detector Function & Bandwidth | (PK) RB = 1 MHz, VB = 3 MHz (AV) RB = 1 MHz, VB = 200 Hz |
| Input Power (System) | 56 Vdc | Environmental Conditions | 25°C, 75% RH |
| Tested By | Tom Yang | | |

| Antenna Polarity & Test Distance : Vertical at 3 m | | | | | | | | |
|--|-----------------|-------------------------|----------------|-------------|--------------------|----------------------|------------------|--------------------------|
| No | Frequency (MHz) | Emission Level (dBuV/m) | Limit (dBuV/m) | Margin (dB) | Antenna Height (m) | Table Angle (Degree) | Raw Value (dBuV) | Correction Factor (dB/m) |
| 1 | 5460.00 | 49.7 PK | 74.0 | -24.3 | 1.01 V | 15 | 48.4 | 1.3 |
| 2 | 5460.00 | 38.5 AV | 54.0 | -15.5 | 1.01 V | 15 | 37.2 | 1.3 |
| 3 | #5470.00 | 50.2 PK | 68.2 | -18.0 | 1.01 V | 15 | 48.9 | 1.3 |
| 4 | *5710.00 | 117.6 PK | | | 1.01 V | 15 | 115.7 | 1.9 |
| 5 | *5710.00 | 105.5 AV | | | 1.01 V | 15 | 103.6 | 1.9 |
| 6 | #5850.00 | 50.1 PK | 68.2 | -18.1 | 1.01 V | 15 | 48.1 | 2.0 |
| 7 | 11420.00 | 58.1 PK | 74.0 | -15.9 | 2.37 V | 185 | 46.2 | 11.9 |
| 8 | 11420.00 | 47.4 AV | 54.0 | -6.6 | 2.37 V | 185 | 35.5 | 11.9 |
| 9 | #17130.00 | 55.1 PK | 68.2 | -13.1 | 1.71 V | 105 | 39.3 | 15.8 |

Remarks:

1. Emission Level(dBuV/m) = Raw Value(dBuV) + Correction Factor(dB/m)
2. Correction Factor(dB/m) = Antenna Factor(dB/m) + Cable Factor(dB) – Pre-Amplifier Factor(dB)
3. Margin value = Emission Level – Limit value
4. The other emission levels were very low against the limit.
5. " * " : Fundamental frequency, the limit was restricted at the RF Output Power.
6. " # " : The radiated frequency is out of the restricted band.

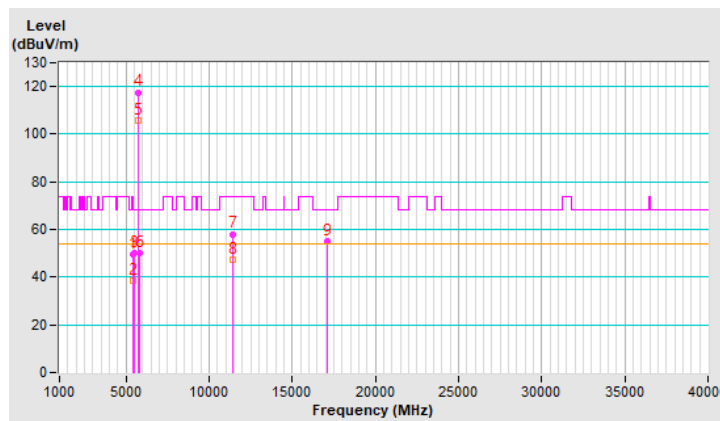

| | | | |
|-----------------------------|-----------------|--|---|
| RF Mode | 802.11ax (HE80) | Channel | CH 58 : 5290 MHz |
| Frequency Range | 1 GHz ~ 40 GHz | Detector Function & Bandwidth | (PK) RB = 1 MHz, VB = 3 MHz (AV) RB = 1 MHz, VB = 200 Hz |
| Input Power (System) | 56 Vdc | Environmental Conditions | 25°C, 75% RH |
| Tested By | Tom Yang | | |

| Antenna Polarity & Test Distance : Horizontal at 3 m | | | | | | | | |
|--|-----------------|-------------------------|----------------|-------------|--------------------|----------------------|------------------|--------------------------|
| No | Frequency (MHz) | Emission Level (dBuV/m) | Limit (dBuV/m) | Margin (dB) | Antenna Height (m) | Table Angle (Degree) | Raw Value (dBuV) | Correction Factor (dB/m) |
| 1 | 5150.00 | 48.5 PK | 74.0 | -25.5 | 2.85 H | 81 | 47.1 | 1.4 |
| 2 | 5150.00 | 37.6 AV | 54.0 | -16.4 | 2.85 H | 81 | 36.2 | 1.4 |
| 3 | *5290.00 | 110.7 PK | | | 2.85 H | 81 | 109.9 | 0.8 |
| 4 | *5290.00 | 98.9 AV | | | 2.85 H | 81 | 98.1 | 0.8 |
| 5 | 5350.00 | 63.6 PK | 74.0 | -10.4 | 2.85 H | 81 | 62.5 | 1.1 |
| 6 | 5350.00 | 53.8 AV | 54.0 | -0.2 | 2.85 H | 81 | 52.7 | 1.1 |
| 7 | #10580.00 | 59.3 PK | 68.2 | -8.9 | 1.53 H | 238 | 48.4 | 10.9 |
| 8 | 15870.00 | 55.7 PK | 74.0 | -18.3 | 3.11 H | 290 | 44.1 | 11.6 |
| 9 | 15870.00 | 44.6 AV | 54.0 | -9.4 | 3.11 H | 290 | 33.0 | 11.6 |

Remarks:

1. Emission Level(dBuV/m) = Raw Value(dBuV) + Correction Factor(dB/m)
2. Correction Factor(dB/m) = Antenna Factor(dB/m) + Cable Factor(dB) – Pre-Amplifier Factor(dB)
3. Margin value = Emission Level – Limit value
4. The other emission levels were very low against the limit.
5. " * " : Fundamental frequency, the limit was restricted at the RF Output Power.
6. " # " : The radiated frequency is out of the restricted band.

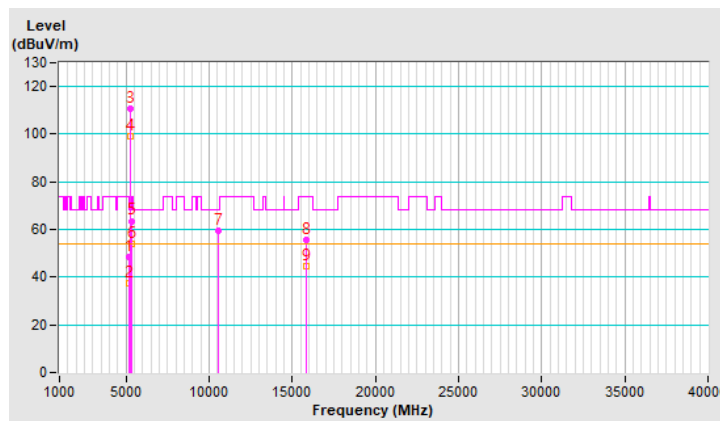

| | | | |
|-----------------------------|-----------------|--|---|
| RF Mode | 802.11ax (HE80) | Channel | CH 58 : 5290 MHz |
| Frequency Range | 1 GHz ~ 40 GHz | Detector Function & Bandwidth | (PK) RB = 1 MHz, VB = 3 MHz (AV) RB = 1 MHz, VB = 200 Hz |
| Input Power (System) | 56 Vdc | Environmental Conditions | 25°C, 75% RH |
| Tested By | Tom Yang | | |

| Antenna Polarity & Test Distance : Vertical at 3 m | | | | | | | | |
|--|-----------------|-------------------------|----------------|-------------|--------------------|----------------------|------------------|--------------------------|
| No | Frequency (MHz) | Emission Level (dBuV/m) | Limit (dBuV/m) | Margin (dB) | Antenna Height (m) | Table Angle (Degree) | Raw Value (dBuV) | Correction Factor (dB/m) |
| 1 | 5150.00 | 47.3 PK | 74.0 | -26.7 | 2.34 V | 271 | 45.9 | 1.4 |
| 2 | 5150.00 | 36.8 AV | 54.0 | -17.2 | 2.34 V | 271 | 35.4 | 1.4 |
| 3 | *5290.00 | 102.7 PK | | | 2.34 V | 271 | 101.9 | 0.8 |
| 4 | *5290.00 | 92.4 AV | | | 2.34 V | 271 | 91.6 | 0.8 |
| 5 | 5350.00 | 55.1 PK | 74.0 | -18.9 | 2.34 V | 271 | 54.0 | 1.1 |
| 6 | 5350.00 | 43.8 AV | 54.0 | -10.2 | 2.34 V | 271 | 42.7 | 1.1 |
| 7 | #10580.00 | 59.5 PK | 68.2 | -8.7 | 2.53 V | 199 | 48.6 | 10.9 |
| 8 | 15870.00 | 55.2 PK | 74.0 | -18.8 | 1.58 V | 106 | 43.6 | 11.6 |
| 9 | 15870.00 | 44.3 AV | 54.0 | -9.7 | 1.58 V | 106 | 32.7 | 11.6 |

Remarks:

1. Emission Level(dBuV/m) = Raw Value(dBuV) + Correction Factor(dB/m)
2. Correction Factor(dB/m) = Antenna Factor(dB/m) + Cable Factor(dB) – Pre-Amplifier Factor(dB)
3. Margin value = Emission Level – Limit value
4. The other emission levels were very low against the limit.
5. " * " : Fundamental frequency, the limit was restricted at the RF Output Power.
6. " # " : The radiated frequency is out of the restricted band.

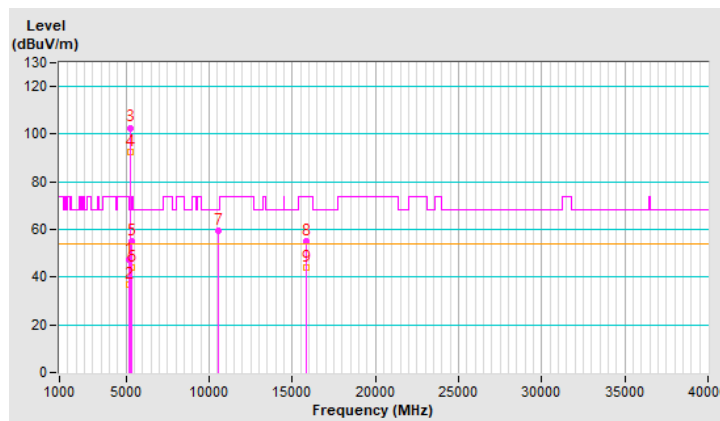

| | | | |
|-----------------------------|-----------------|--|---|
| RF Mode | 802.11ax (HE80) | Channel | CH 106 : 5530 MHz |
| Frequency Range | 1 GHz ~ 40 GHz | Detector Function & Bandwidth | (PK) RB = 1 MHz, VB = 3 MHz (AV) RB = 1 MHz, VB = 200 Hz |
| Input Power (System) | 56 Vdc | Environmental Conditions | 25°C, 75% RH |
| Tested By | Tom Yang | | |

| Antenna Polarity & Test Distance : Horizontal at 3 m | | | | | | | | |
|--|-----------------|-------------------------|----------------|-------------|--------------------|----------------------|------------------|--------------------------|
| No | Frequency (MHz) | Emission Level (dBuV/m) | Limit (dBuV/m) | Margin (dB) | Antenna Height (m) | Table Angle (Degree) | Raw Value (dBuV) | Correction Factor (dB/m) |
| 1 | 5449.06 | 63.5 PK | 74.0 | -10.5 | 2.88 H | 74 | 62.2 | 1.3 |
| 2 | 5449.06 | 50.6 AV | 54.0 | -3.4 | 2.88 H | 74 | 49.3 | 1.3 |
| 3 | #5470.00 | 67.9 PK | 68.2 | -0.3 | 2.88 H | 74 | 66.6 | 1.3 |
| 4 | *5530.00 | 110.8 PK | | | 2.88 H | 74 | 109.5 | 1.3 |
| 5 | *5530.00 | 99.2 AV | | | 2.88 H | 74 | 97.9 | 1.3 |
| 6 | #5836.34 | 50.6 PK | 68.2 | -17.6 | 2.88 H | 74 | 48.6 | 2.0 |
| 7 | 11060.00 | 59.2 PK | 74.0 | -14.8 | 1.56 H | 225 | 47.5 | 11.7 |
| 8 | 11060.00 | 47.4 AV | 54.0 | -6.6 | 1.56 H | 225 | 35.7 | 11.7 |
| 9 | #16590.00 | 56.2 PK | 68.2 | -12.0 | 3.17 H | 292 | 42.0 | 14.2 |

Remarks:

1. Emission Level(dBuV/m) = Raw Value(dBuV) + Correction Factor(dB/m)
2. Correction Factor(dB/m) = Antenna Factor(dB/m) + Cable Factor(dB) – Pre-Amplifier Factor(dB)
3. Margin value = Emission Level – Limit value
4. The other emission levels were very low against the limit.
5. " * " : Fundamental frequency, the limit was restricted at the RF Output Power.
6. " # " : The radiated frequency is out of the restricted band.

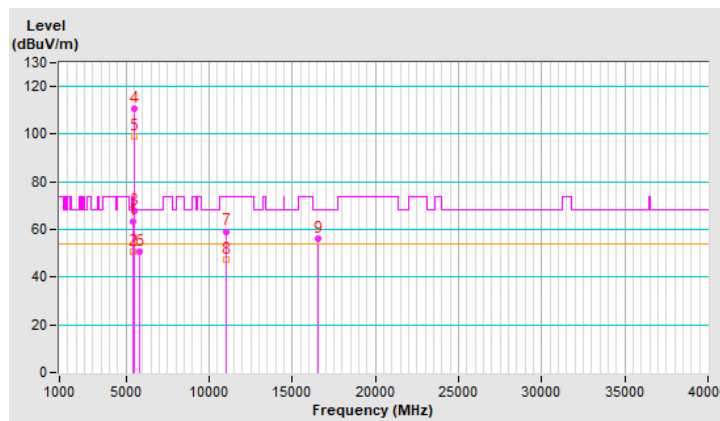

| | | | |
|-----------------------------|-----------------|--|---|
| RF Mode | 802.11ax (HE80) | Channel | CH 106 : 5530 MHz |
| Frequency Range | 1 GHz ~ 40 GHz | Detector Function & Bandwidth | (PK) RB = 1 MHz, VB = 3 MHz (AV) RB = 1 MHz, VB = 200 Hz |
| Input Power (System) | 56 Vdc | Environmental Conditions | 25°C, 75% RH |
| Tested By | Tom Yang | | |

| Antenna Polarity & Test Distance : Vertical at 3 m | | | | | | | | |
|--|-----------------|-------------------------|----------------|-------------|--------------------|----------------------|------------------|--------------------------|
| No | Frequency (MHz) | Emission Level (dBuV/m) | Limit (dBuV/m) | Margin (dB) | Antenna Height (m) | Table Angle (Degree) | Raw Value (dBuV) | Correction Factor (dB/m) |
| 1 | 5459.79 | 56.3 PK | 74.0 | -17.7 | 3.87 V | 343 | 55.0 | 1.3 |
| 2 | 5459.79 | 43.0 AV | 54.0 | -11.0 | 3.87 V | 343 | 41.7 | 1.3 |
| 3 | #5470.00 | 56.0 PK | 68.2 | -12.2 | 3.87 V | 343 | 54.7 | 1.3 |
| 4 | *5530.00 | 386.8 PK | | | 3.87 V | 343 | 385.5 | 1.3 |
| 5 | *5530.00 | 93.6 AV | | | 3.87 V | 343 | 92.3 | 1.3 |
| 6 | #5753.86 | 49.5 PK | 68.2 | -18.7 | 3.87 V | 343 | 47.4 | 2.1 |
| 7 | 11060.00 | 59.3 PK | 74.0 | -14.7 | 2.47 V | 182 | 47.6 | 11.7 |
| 8 | 11060.00 | 47.8 AV | 54.0 | -6.2 | 2.47 V | 182 | 36.1 | 11.7 |
| 9 | #16590.00 | 55.8 PK | 68.2 | -12.4 | 1.58 V | 103 | 41.6 | 14.2 |

Remarks:

1. Emission Level(dBuV/m) = Raw Value(dBuV) + Correction Factor(dB/m)
2. Correction Factor(dB/m) = Antenna Factor(dB/m) + Cable Factor(dB) – Pre-Amplifier Factor(dB)
3. Margin value = Emission Level – Limit value
4. The other emission levels were very low against the limit.
5. " * " : Fundamental frequency, the limit was restricted at the RF Output Power.
6. " # " : The radiated frequency is out of the restricted band.

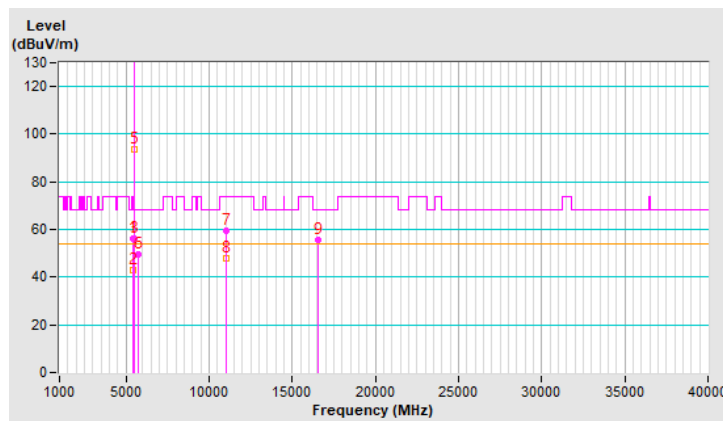

| | | | |
|-----------------------------|-----------------|--|---|
| RF Mode | 802.11ax (HE80) | Channel | CH 122 : 5610 MHz |
| Frequency Range | 1 GHz ~ 40 GHz | Detector Function & Bandwidth | (PK) RB = 1 MHz, VB = 3 MHz (AV) RB = 1 MHz, VB = 200 Hz |
| Input Power (System) | 56 Vdc | Environmental Conditions | 25°C, 75% RH |
| Tested By | Tom Yang | | |

| Antenna Polarity & Test Distance : Horizontal at 3 m | | | | | | | | |
|--|-----------------|-------------------------|----------------|-------------|--------------------|----------------------|------------------|--------------------------|
| No | Frequency (MHz) | Emission Level (dBUV/m) | Limit (dBUV/m) | Margin (dB) | Antenna Height (m) | Table Angle (Degree) | Raw Value (dBUV) | Correction Factor (dB/m) |
| 1 | *5610.00 | 115.7 PK | | | 1.70 H | 52 | 114.2 | 1.5 |
| 2 | *5610.00 | 105.1 AV | | | 1.70 H | 52 | 103.6 | 1.5 |
| 3 | #5725.00 | 67.8 PK | 68.2 | -0.4 | 1.70 H | 52 | 65.8 | 2.0 |
| 4 | 11220.00 | 58.6 PK | 74.0 | -15.4 | 1.58 H | 234 | 47.2 | 11.4 |
| 5 | 11220.00 | 47.2 AV | 54.0 | -6.8 | 1.58 H | 234 | 35.8 | 11.4 |
| 6 | #16830.00 | 56.4 PK | 68.2 | -11.8 | 3.22 H | 265 | 41.6 | 14.8 |

Remarks:

1. Emission Level(dBUV/m) = Raw Value(dBUV) + Correction Factor(dB/m)
2. Correction Factor(dB/m) = Antenna Factor(dB/m) + Cable Factor(dB) – Pre-Amplifier Factor(dB)
3. Margin value = Emission Level – Limit value
4. The other emission levels were very low against the limit.
5. " * " : Fundamental frequency, the limit was restricted at the RF Output Power.
6. " # " : The radiated frequency is out of the restricted band.

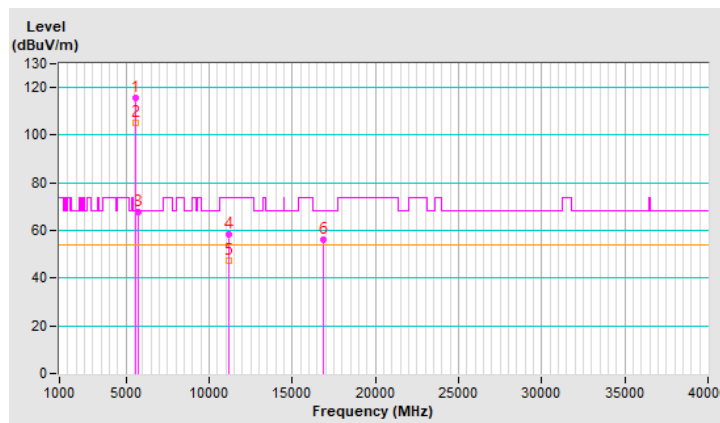

| | | | |
|-----------------------------|-----------------|--|---|
| RF Mode | 802.11ax (HE80) | Channel | CH 122 : 5610 MHz |
| Frequency Range | 1 GHz ~ 40 GHz | Detector Function & Bandwidth | (PK) RB = 1 MHz, VB = 3 MHz (AV) RB = 1 MHz, VB = 200 Hz |
| Input Power (System) | 56 Vdc | Environmental Conditions | 25°C, 75% RH |
| Tested By | Tom Yang | | |

| Antenna Polarity & Test Distance : Vertical at 3 m | | | | | | | | |
|--|-----------------|-------------------------|----------------|-------------|--------------------|----------------------|------------------|--------------------------|
| No | Frequency (MHz) | Emission Level (dBuV/m) | Limit (dBuV/m) | Margin (dB) | Antenna Height (m) | Table Angle (Degree) | Raw Value (dBuV) | Correction Factor (dB/m) |
| 1 | *5610.00 | 111.3 PK | | | 1.51 V | 360 | 109.8 | 1.5 |
| 2 | *5610.00 | 100.0 AV | | | 1.51 V | 360 | 98.5 | 1.5 |
| 3 | #5725.00 | 46.7 PK | 68.2 | -21.5 | 1.51 V | 360 | 44.7 | 2.0 |
| 4 | 11220.00 | 60.0 PK | 74.0 | -14.0 | 2.55 V | 193 | 48.6 | 11.4 |
| 5 | 11220.00 | 48.7 AV | 54.0 | -5.3 | 2.55 V | 193 | 37.3 | 11.4 |
| 6 | #16830.00 | 55.5 PK | 68.2 | -12.7 | 1.68 V | 108 | 40.7 | 14.8 |

Remarks:

1. Emission Level(dBuV/m) = Raw Value(dBuV) + Correction Factor(dB/m)
2. Correction Factor(dB/m) = Antenna Factor(dB/m) + Cable Factor(dB) – Pre-Amplifier Factor(dB)
3. Margin value = Emission Level – Limit value
4. The other emission levels were very low against the limit.
5. " * " : Fundamental frequency, the limit was restricted at the RF Output Power.
6. " # " : The radiated frequency is out of the restricted band.

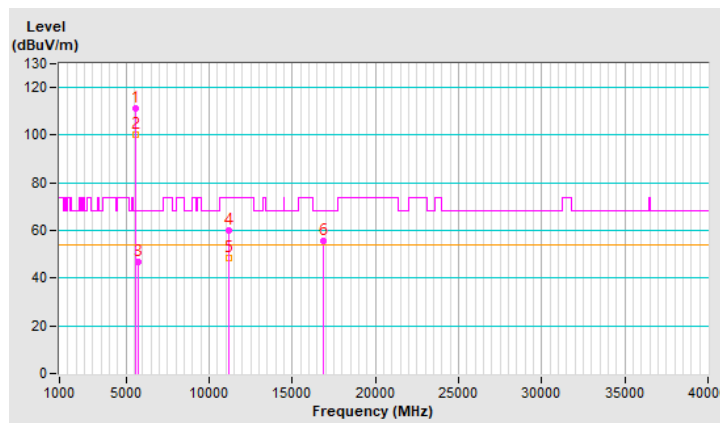

| | | | |
|-----------------------------|-----------------|--|---|
| RF Mode | 802.11ax (HE80) | Channel | CH 138 : 5690 MHz |
| Frequency Range | 1 GHz ~ 40 GHz | Detector Function & Bandwidth | (PK) RB = 1 MHz, VB = 3 MHz (AV) RB = 1 MHz, VB = 200 Hz |
| Input Power (System) | 56 Vdc | Environmental Conditions | 25°C, 75% RH |
| Tested By | Tom Yang | | |

| Antenna Polarity & Test Distance : Horizontal at 3 m | | | | | | | | |
|--|-----------------|-------------------------|----------------|-------------|--------------------|----------------------|------------------|--------------------------|
| No | Frequency (MHz) | Emission Level (dBuV/m) | Limit (dBuV/m) | Margin (dB) | Antenna Height (m) | Table Angle (Degree) | Raw Value (dBuV) | Correction Factor (dB/m) |
| 1 | 5460.00 | 47.9 PK | 74.0 | -26.1 | 1.64 H | 64 | 46.6 | 1.3 |
| 2 | 5460.00 | 37.2 AV | 54.0 | -16.8 | 1.64 H | 64 | 35.9 | 1.3 |
| 3 | #5470.00 | 46.8 PK | 68.2 | -21.4 | 1.64 H | 64 | 45.5 | 1.3 |
| 4 | *5690.00 | 115.7 PK | | | 1.64 H | 64 | 114.0 | 1.7 |
| 5 | *5690.00 | 104.9 AV | | | 1.64 H | 64 | 103.2 | 1.7 |
| 6 | #5850.00 | 47.0 PK | 68.2 | -21.2 | 1.64 H | 64 | 45.0 | 2.0 |
| 7 | 11380.00 | 58.8 PK | 74.0 | -15.2 | 1.54 H | 234 | 46.8 | 12.0 |
| 8 | 11380.00 | 47.3 AV | 54.0 | -6.7 | 1.54 H | 234 | 35.3 | 12.0 |
| 9 | #17070.00 | 56.0 PK | 68.2 | -12.2 | 3.16 H | 276 | 40.2 | 15.8 |

Remarks:

1. Emission Level(dBuV/m) = Raw Value(dBuV) + Correction Factor(dB/m)
2. Correction Factor(dB/m) = Antenna Factor(dB/m) + Cable Factor(dB) – Pre-Amplifier Factor(dB)
3. Margin value = Emission Level – Limit value
4. The other emission levels were very low against the limit.
5. " * " : Fundamental frequency, the limit was restricted at the RF Output Power.
6. " # " : The radiated frequency is out of the restricted band.

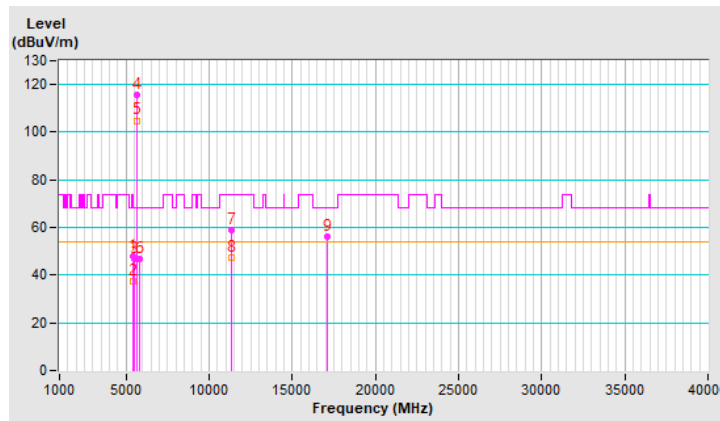

| | | | |
|-----------------------------|-----------------|--|---|
| RF Mode | 802.11ax (HE80) | Channel | CH 138 : 5690 MHz |
| Frequency Range | 1 GHz ~ 40 GHz | Detector Function & Bandwidth | (PK) RB = 1 MHz, VB = 3 MHz (AV) RB = 1 MHz, VB = 200 Hz |
| Input Power (System) | 56 Vdc | Environmental Conditions | 25°C, 75% RH |
| Tested By | Tom Yang | | |

| Antenna Polarity & Test Distance : Vertical at 3 m | | | | | | | | |
|--|-----------------|-------------------------|----------------|-------------|--------------------|----------------------|------------------|--------------------------|
| No | Frequency (MHz) | Emission Level (dBuV/m) | Limit (dBuV/m) | Margin (dB) | Antenna Height (m) | Table Angle (Degree) | Raw Value (dBuV) | Correction Factor (dB/m) |
| 1 | 5460.00 | 47.3 PK | 74.0 | -26.7 | 1.53 V | 360 | 46.0 | 1.3 |
| 2 | 5460.00 | 37.1 AV | 54.0 | -16.9 | 1.53 V | 360 | 35.8 | 1.3 |
| 3 | #5470.00 | 47.1 PK | 68.2 | -21.1 | 1.53 V | 360 | 45.8 | 1.3 |
| 4 | *5690.00 | 111.1 PK | | | 1.53 V | 360 | 109.4 | 1.7 |
| 5 | *5690.00 | 100.3 AV | | | 1.53 V | 360 | 98.6 | 1.7 |
| 6 | #5850.00 | 47.0 PK | 68.2 | -21.2 | 1.53 V | 360 | 45.0 | 2.0 |
| 7 | 11380.00 | 59.7 PK | 74.0 | -14.3 | 2.56 V | 178 | 47.7 | 12.0 |
| 8 | 11380.00 | 48.5 AV | 54.0 | -5.5 | 2.56 V | 178 | 36.5 | 12.0 |
| 9 | #17070.00 | 56.0 PK | 68.2 | -12.2 | 1.65 V | 88 | 40.2 | 15.8 |

Remarks:

1. Emission Level(dBuV/m) = Raw Value(dBuV) + Correction Factor(dB/m)
2. Correction Factor(dB/m) = Antenna Factor(dB/m) + Cable Factor(dB) – Pre-Amplifier Factor(dB)
3. Margin value = Emission Level – Limit value
4. The other emission levels were very low against the limit.
5. " * " : Fundamental frequency, the limit was restricted at the RF Output Power.
6. " # " : The radiated frequency is out of the restricted band.

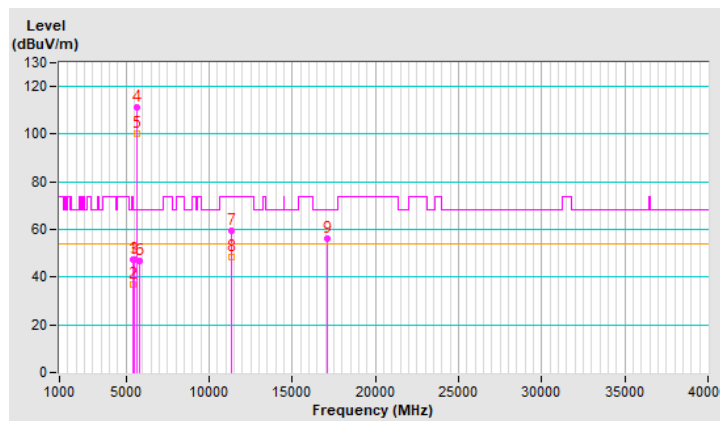



Plot of Band Edge

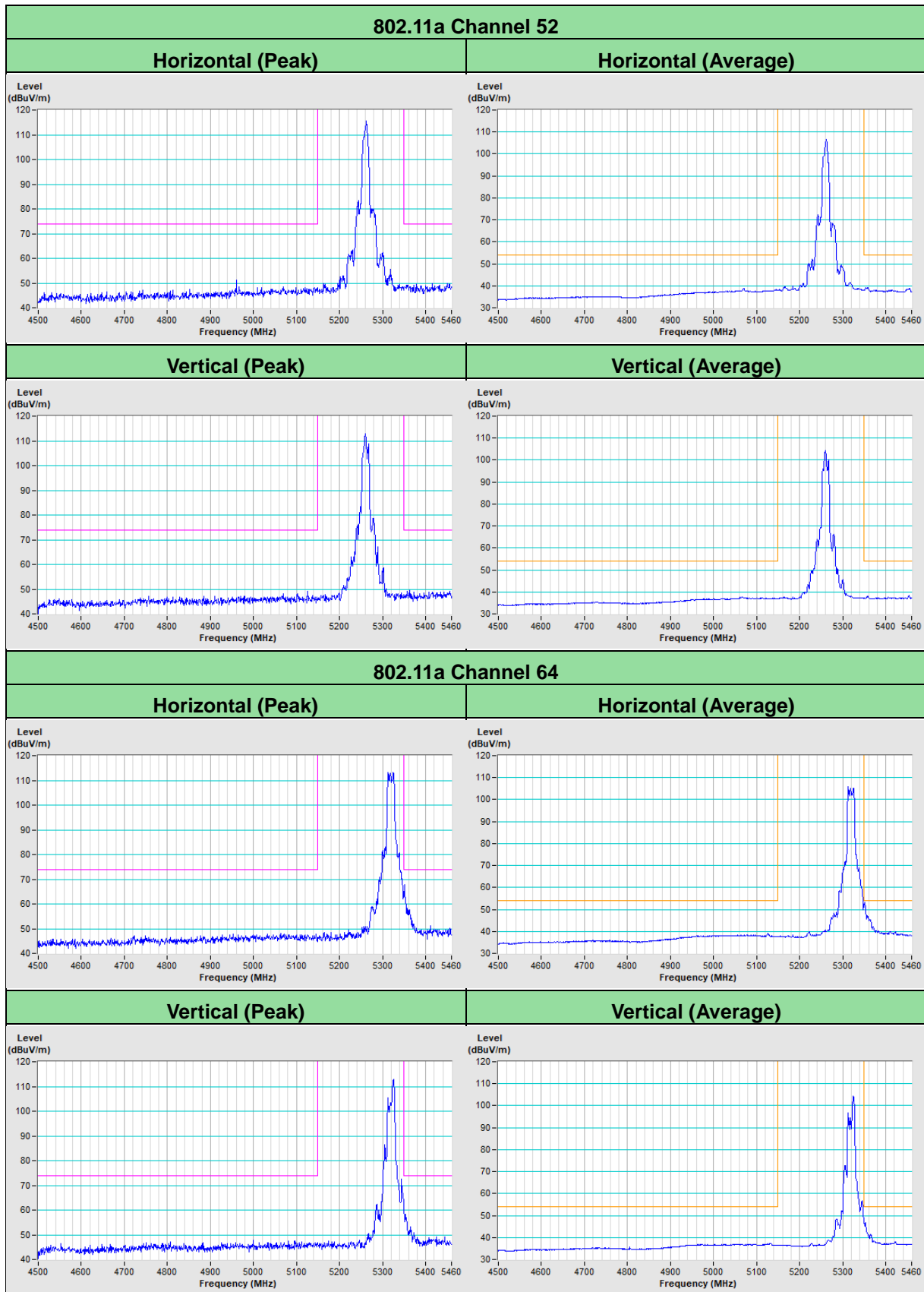

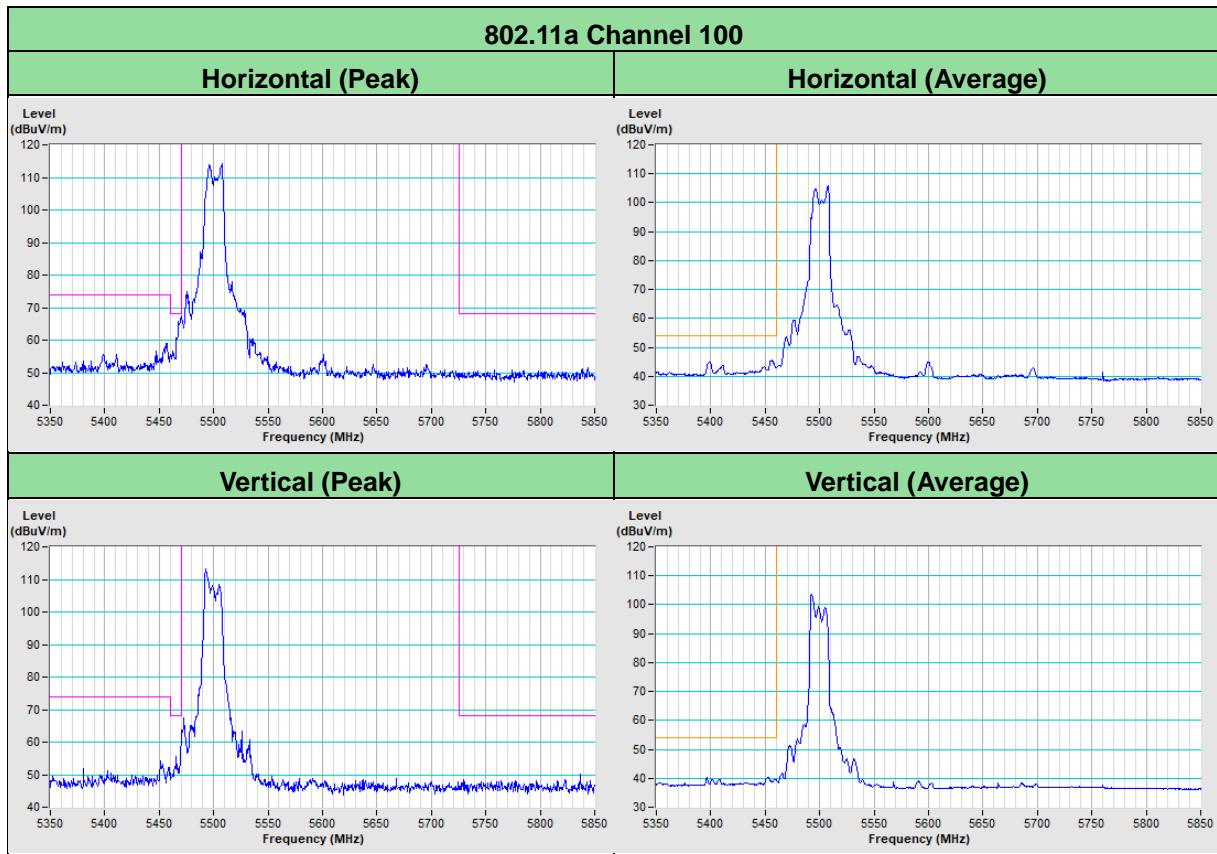

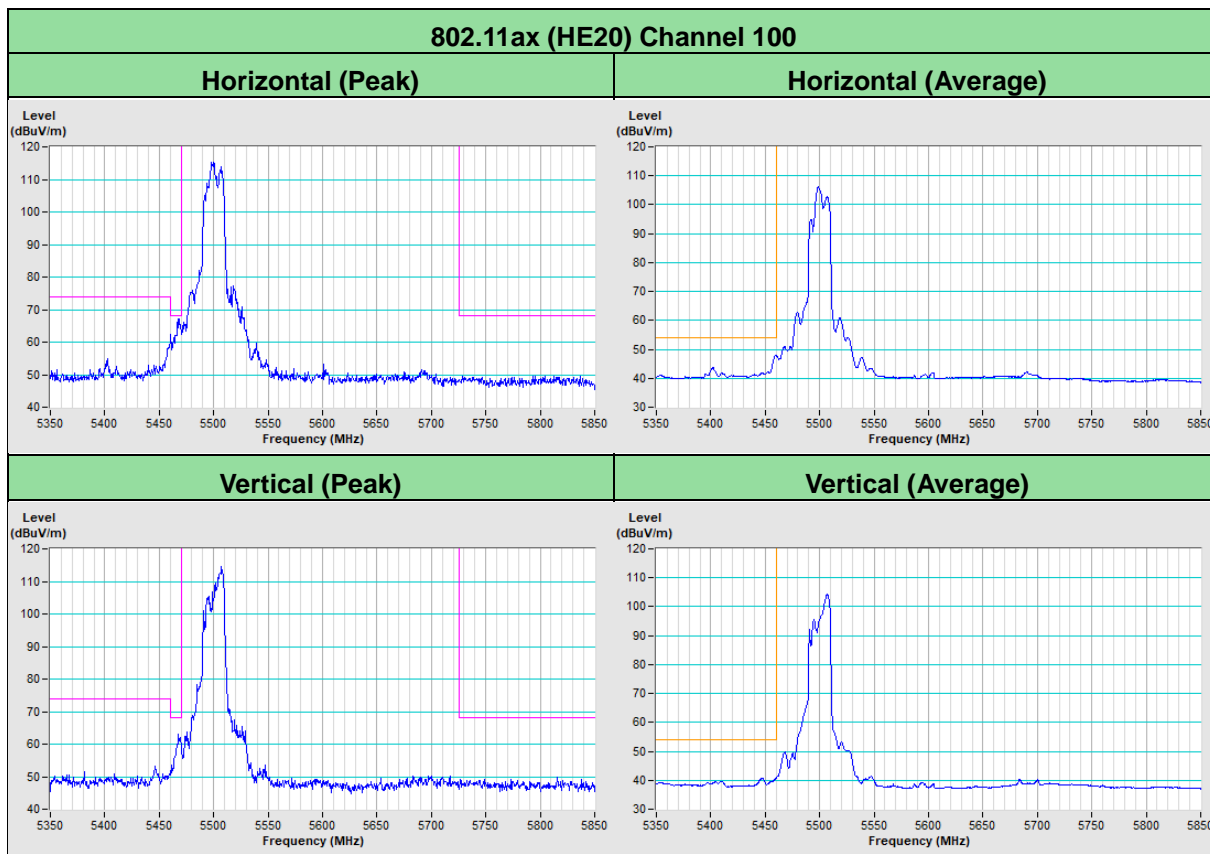

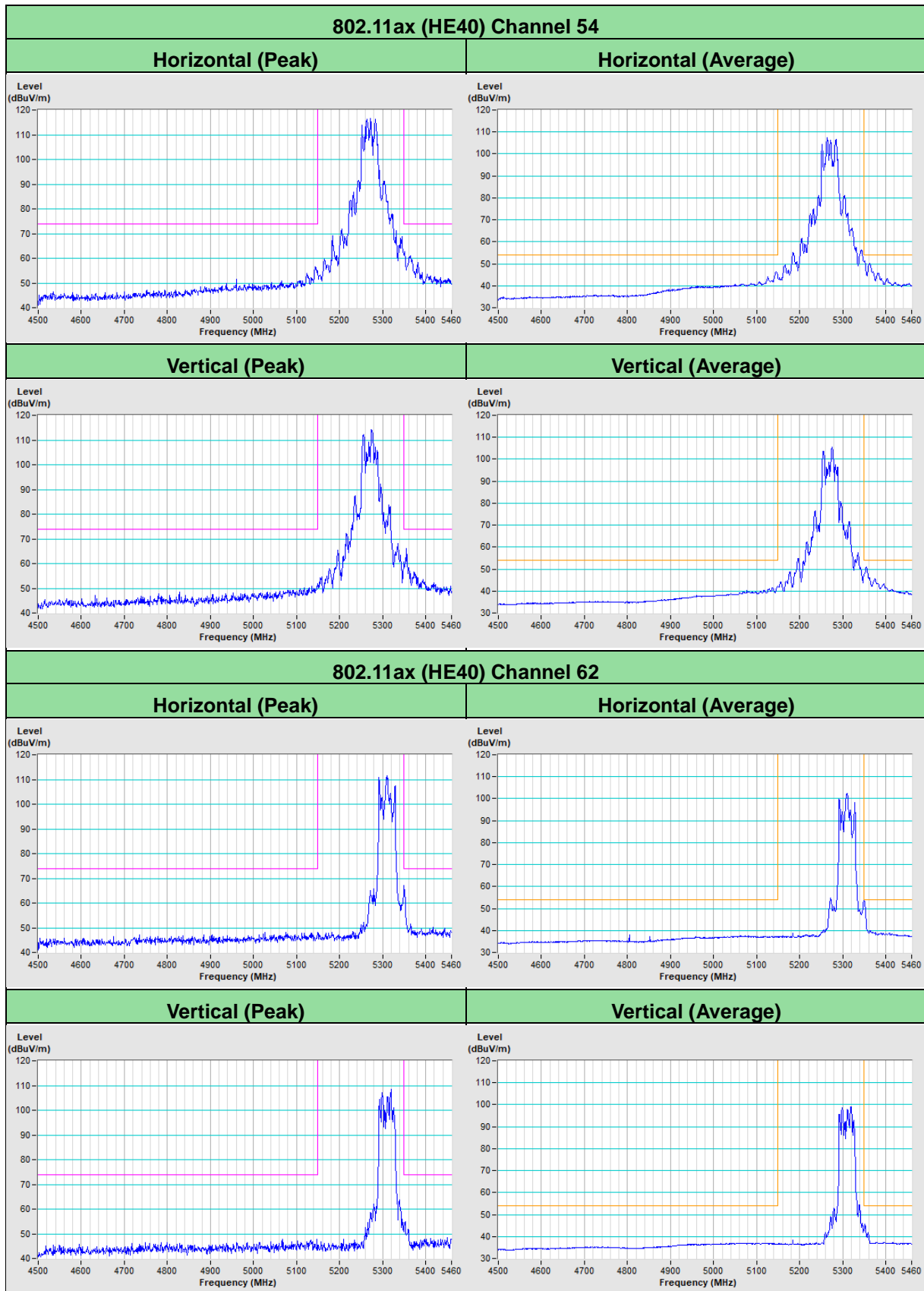

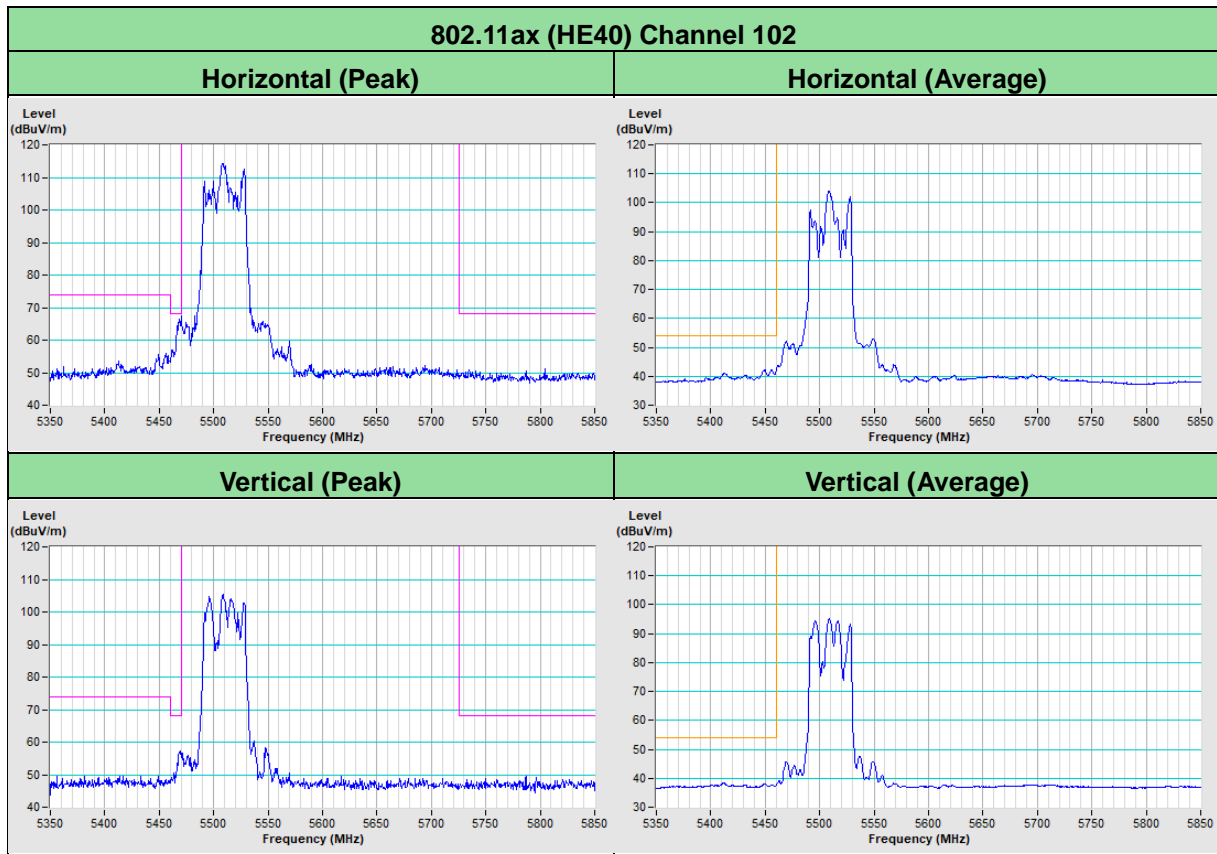

8 Pictures of Test Arrangements

Please refer to the attached file (Test Setup Photo)

9 Information of the Testing Laboratories

We, Bureau Veritas Consumer Products Services (H.K.) Ltd., Taoyuan Branch, were founded in 1988 to provide our best service in EMC, Radio, Telecom and Safety consultation. Our laboratories are FCC recognized accredited test firms and accredited according to ISO/IEC 17025.

If you have any comments, please feel free to contact us at the following:

Lin Kou EMC/RF Lab

Tel: 886-2-26052180

Fax: 886-2-26051924

Hsin Chu EMC/RF/Telecom Lab

Tel: 886-3-6668565

Fax: 886-3-6668323

Hwa Ya EMC/RF/Safety Lab

Tel: 886-3-3183232

Fax: 886-3-3270892

Email: service.adt@bureauveritas.com

Web Site: <http://ee.bureauveritas.com.tw>

The address and road map of all our labs can be found in our web site also.

--- END ---