



Radio Test Report

Application for Grant of Equipment Authorization

FCC Part 27 Subpart C

IC RSS-130 Issue 1

718MHz – 728MHz and 746MHz – 756MHz

FCC ID: VBNFRBE-01

IC: 661W-FRBE

Model: FRBE

Product Name: Flexi Multiradio BTS

APPLICANT: Nokia Solutions and Networks

6000 Connection Drive

Irving, TX 75039

TEST SITE(S): National Technical Systems - Plano

1701 E Plano Pkwy #150

Plano, TX 75074

REPORT DATE: Apr 10, 2015

FINAL TEST DATES: Feb 5 – Feb 11, 2015

TOTAL NUMBER OF PAGES: 66

Prepared By:

Yunus E. Faziloglu
Wireless Manager

Approved By:

Kimberly Zavala
Quality Assurance Manager

Reviewed By:

John Ngo
General Manager

This report and the information contained herein represent the results of testing test articles identified and selected by the client performed to specifications and/or procedures selected by the client. National Technical Systems (NTS) makes no representations, expressed or implied, that such testing is adequate (or inadequate) to demonstrate efficiency, performance, reliability, or any other characteristic of the articles being tested, or similar products. This report should not be relied upon as an endorsement or certification by NTS of the equipment tested, nor does it represent any statement whatsoever as to its merchantability or fitness of the test article, or similar products, for a particular purpose. This report shall not be reproduced except in full.

REVISION HISTORY

Rev#	Date	Comments	Modified By
0	Apr 10, 2015	1 st release	Yunus Faziloglu

TABLE OF CONTENTS

REVISION HISTORY2

TABLE OF CONTENTS3

SCOPE.....4

OBJECTIVE5

STATEMENT OF COMPLIANCE5

DEVIATIONS FROM THE STANDARDS5

TEST RESULTS.....6

 FCC PART 27 SUBPART C AND RSS-130 ISSUE 1 (BASE STATIONS OPERATING IN 718MHZ-728MHZ BAND).....6

 FCC PART 27 SUBPART C AND RSS-130 ISSUE 1 (BASE STATIONS OPERATING IN 746MHZ-756MHZ BAND).....7

 EXTREME CONDITIONS8

 MEASUREMENT UNCERTAINTIES8

EQUIPMENT UNDER TEST (EUT) DETAILS9

 GENERAL.....9

 ENCLOSURE10

 AUXILLARY EQUIPMENT10

 SUPPORT EQUIPMENT10

 EUT INTERFACE PORTS.....10

 EUT OPERATION11

 EUT FIRMWARE/SOFTWARE.....11

 MODIFICATIONS11

TESTING12

 GENERAL INFORMATION12

MEASUREMENT PROCEDURES13

TEST EQUIPMENT15

APPENDIX A TEST DATA16

 RF OUTPUT POWER17

 EMISSION BANDWIDTHS (26dB AND 99%).....31

 ANTENNA PORT CONDUCTED BANDEGE38

 TRANSMITTER ANTENNA PORT CONDUCTED SPURIOUS EMISSIONS51

 TRANSMITTER RADIATED SPURIOUS EMISSIONS62

 FREQUENCY STABILITY65

END OF REPORT.....66

SCOPE

Tests have been performed on Nokia Solutions and Networks product Flexi Multiradio BTS RRH Model FRBE, pursuant to the relevant requirements of the following standard(s) in order to obtain device certification against the regulatory requirements of the Federal Communications Commission.

- Code of Federal Regulations (CFR) Title 47 Part 2
- CFR Title 47 Part 27 Subpart C
- RSS-Gen Issue 4 November 2014
- RSS-130 Issue 1 October 2013

Conducted and radiated emissions data has been collected, reduced, and analyzed within this report in accordance with measurement guidelines set forth in the following reference standards:

ANSI C63.4-2009
ANSI TIA-603-C
FCC KDB 971168 D01 v02r02

The intentional radiator above has been tested in a simulated typical installation to demonstrate compliance with the relevant FCC requirements.

Every practical effort was made to perform an impartial test using appropriate test equipment of known calibration. All pertinent factors have been applied to reach the determination of compliance.

The test results recorded herein are based on a single type test of Nokia Solutions and Networks product Flexi Multiradio BTS RRH Model FRBE and therefore apply only to the tested sample. The sample was selected and prepared by Hobert Smith of Nokia Solutions and Networks.

OBJECTIVE

The primary objective of the manufacturer is compliance with the regulations outlined in the previous section.

Prior to marketing in the USA, the device requires certification.

Certification is a procedure where the manufacturer submits test data and technical information to a certification body and receives a certificate or grant of equipment authorization upon successful completion of the certification body's review of the submitted documents. Once the equipment authorization has been obtained, the label indicating compliance must be attached to all identical units, which are subsequently manufactured.

Maintenance of compliance is the responsibility of the manufacturer. Any modification of the product which may result in increased emissions should be checked to ensure compliance has been maintained (i.e., printed circuit board layout changes, different line filter, different power supply, harnessing or I/O cable changes, etc.).

Testing was performed only on Model FRBE. No additional models were described or supplied for testing.

STATEMENT OF COMPLIANCE

The tested sample of Nokia Solutions and Networks product Flexi Multiradio BTS RRH Model FRBE complied with the requirements of the standards and frequency bands declared in the scope of this test report.

Maintenance of compliance is the responsibility of the manufacturer. Any modifications to the product should be assessed to determine their potential impact on the compliance status of the device with respect to the standards detailed in this test report.

DEVIATIONS FROM THE STANDARDS

No deviations were made from the published requirements listed in the scope of this report.

TEST RESULTS

FCC Part 27 Subpart C and RSS-130 Issue 1 (Base Stations Operating in 718MHz-728MHz band)

FCC	IC	Description	Measured	Limit	Result
Transmitter Modulation, output power and other characteristics					
§27.5(c)	RSS-130 Section 4.2	Frequency range(s)	720.5MHz - 725.5MHz (5M LTE) 723.0MHz - 723.0MHz (10M LTE)	718MHz - 728MHz	Pass
§2.1033(c)(4)	RSS-130 Section 4.1	Modulation Type	QPSK, 16QAM, 64QAM (5M and 10M for each)	Digital	Pass
§27.50(c)	RSS-130 Section 4.4	Output Power	Conducted Output Power (Highest on Port 3) RMS: 45.3Bm ERP will depend on antenna gain (unknown)	1000W ERP	Pass
N/A Informational	RSS-130 Section 4.4	Peak to Average Ratio	10.79dB highest	13dB	Pass
§2.1049	RSS-Gen Section 6.6	Emission Bandwidth (99%)	4.502MHz (5M LTE) 8.997MHz (10M LTE)	Remain in Block	Pass
N/A Informational	N/A Informational	Emission Bandwidth (26dB)	4.885MHz (5M LTE) 9.764MHz (10M LTE)	Remain in Block	Pass
Transmitter spurious emissions¹					
§27.53(f)	RSS-130 Section 4.6	At the antenna terminals	< -16.02dBm	-16.02 dBm (per TX chain)	Pass
		Field strength	39.7dBuV/m at 3m Eq. to -55.5dBm EIRP	-13 dBm EIRP	Pass
N/A Informational	N/A Informational	Limitations within 1559MHz -1610MHz band	Conducted measurements on Port 3. No emissions observed above the instrumentation noise floor.	-70 dBW/MHz EIRP (wideband) -80 dBW/MHz EIRP (discrete)	Pass
Other details					
§27.54	RSS-130 Section 4.3	Frequency stability	0.0006ppm	Remain in Block	Pass
§1.1310	RSS-102 Issue 5	RF Exposure	N/A		Pass ²
Notes					
Note 1 – Based on 100kHz RBW. In 100kHz bands immediately outside and adjacent to the frequency block 30kHz RBW has been used.					
Note 2 – Applicant’s declaration on a separate exhibit based on hypothetical antenna gains.					

	Emission Designators					
	LTE-QPSK		LTE-16QAM		LTE-64QAM	
	FCC	IC	FCC	IC	FCC	IC
5M	4M88F9W	4M49F9W	4M87F9W	4M49F9W	4M89F9W	4M50F9W
10M	9M73F9W	8M98F9W	9M71F9W	9M00F9W	9M76F9W	8M99F9W

Note: FCC based on 26dB emission bandwidth, IC based on 99% emissions bandwidth.

FCC Part 27 Subpart C and RSS-130 Issue 1 (Base Stations Operating in 746MHz-756MHz band)

FCC	IC	Description	Measured	Limit	Result
Transmitter Modulation, output power and other characteristics					
§27.5(b)	RSS-130 Section 4.2	Frequency range(s)	748.5MHz - 753.5MHz (5M LTE) 751.0MHz - 751.0MHz (10M LTE)	746MHz - 756MHz	Pass
§2.1033(c)(4)	RSS-130 Section 4.1	Modulation Type	QPSK, 16QAM, 64QAM (5M and 10M for each)	Digital	Pass
§27.50(b)	RSS-130 Section 4.4	Output Power	Conducted Output Power (Highest on Port 2) RMS: 45.33Bm ERP will depend on antenna gain (unknown)	1000W ERP	Pass
N/A Informational	RSS-130 Section 4.4	Peak to Average Ratio	10.76dB highest	13dB	Pass
§2.1049	RSS-Gen Section 6.6	Emission Bandwidth (99%)	4.507MHz (5M LTE) 9.009MHz (10M LTE)	Remain in Block	Pass
N/A Informational	N/A Informational	Emission Bandwidth (26dB)	4.888MHz (5M LTE) 9.745MHz (10M LTE)	Remain in Block	Pass
Transmitter spurious emissions¹					
§27.53(c)	RSS-130 Section 4.6	At the antenna terminals	< -16.02dBm	-16.02 dBm (per TX chain)	Pass
		Field strength	39.7dBuV/m at 3m Eq. to -55.5dBm EIRP	-13 dBm EIRP	Pass
§27.53(e)	RSS-130 Section 4.6	Limitations within 1559MHz -1610MHz band	Conducted measurements on Port 3. No emissions observed above the instrumentation noise floor.	-70 dBW/MHz EIRP (wideband) -80 dBW/MHz EIRP (discrete)	Pass
Other details					
§27.54	RSS-130 Section 4.3	Frequency stability	0.0007ppm	Remain in Block	Pass
§1.1310	RSS-102 Issue 5	RF Exposure	N/A		Pass ²
Notes					
Note 1 – Based on 100kHz RBW. In 100kHz bands immediately outside and adjacent to the frequency block 30kHz RBW has been used.					
Note 2 – Applicant’s declaration on a separate exhibit based on hypothetical antenna gains.					

	Emission Designators					
	LTE-QPSK		LTE-16QAM		LTE-64QAM	
	FCC	IC	FCC	IC	FCC	IC
5M	4M89F9W	4M49F9W	4M86F9W	4M49F9W	4M89F9W	4M51F9W
10M	9M73F9W	8M99F9W	9M71F9W	9M01F9W	9M75F9W	9M00F9W

Note: FCC based on 26dB emission bandwidth, IC based on 99% emissions bandwidth.

EXTREME CONDITIONS

Frequency stability is determined over extremes of temperature and voltage. The extremes of voltage were 85 to 115 percent of the nominal value.

The extremes of temperature were -30°C to +50°C as specified in FCC §2.1055(a)(1).

MEASUREMENT UNCERTAINTIES

Measurement uncertainties of the test facility based on a 95% confidence level are as follows,

Test	Uncertainty
Radio frequency	± 0.2ppm
RF power conducted	±1.2 dB
RF power radiated	±3.3 dB
RF power density conducted	±1.2 dB
Spurious emissions conducted	±1.2 dB
Adjacent channel power	±0.4 dB
Spurious emissions radiated	±4 dB
Temperature	±1°C
Humidity	±1.6 %
Voltage (DC)	±0.2 %
Voltage (AC)	±0.3 %

EQUIPMENT UNDER TEST (EUT) DETAILS

GENERAL

The equipment under test (EUT) is a Nokia Solutions and Networks Flexi Multiradio Base Transceiver Station (BTS) Remote Radio Head (RRH) module, model FRBE which operates over 3GPP frequency bands 13 and 29 (BTS Rx: 777 to 787 MHz/BTS Tx: 746 to 756 MHz and 718 to 728 MHz). The FRBE has four co-located transmitters with each transmit port supporting 40 watts maximum rated RF output power. The FRBE can be operated as MIMO or as non-MIMO. Multi-carrier operation is supported.

The FRBE is multi-standard capable (GSM/EDGE/WCDMA/LTE), but for this effort only the LTE mode is tested. The FRBE supports three downlink modulation types for LTE (QPSK, 16QAM and 64QAM). The FRBE supports two LTE channel bandwidths (5 MHz and 10 MHz).

The FRBE has external interfaces including DC power, ground, TX/RX (Ant), RX monitor (RXO), external alarm (EAC), optical OBSAI (OPT) and remote electrical tilt (RET). The RRH with applicable installation kit may be pole or wall mounted.

The FRBE LTE channel numbers and frequencies are as follows:

	Downlink EARFCN	Downlink Frequency (MHz)	LTE Channel Bandwidth	
			5 MHz	10 MHz
Band 29 (Ant 3 and 4)	9670	718.0	Bandedge	Bandedge
			
	9695	720.5	Bottom Ch	
			
	9720	723.0	Middle Ch	Bottom Ch Middle Ch Top Channel
			
	9745	725.5	Top Channel	
			
	9770	728.0	Bandedge	Bandedge
Band 13 (Ant 1 and 2)	5180	746.0	Bandedge	Bandedge
			
	5205	748.5	Bottom Ch	
			
	5230	751	Middle Ch	Bottom Ch Middle Ch Top Channel
			
	5255	753.5	Top Channel	
			
	5280	756	Bandedge	Bandedge

FRBE Downlink LTE Frequency Channels

The sample was received on Feb 5, 2015 and tested on Feb 5 – Feb 11, 2015. The EUT consisted of the following component(s):

Company	Model	Description	Part/Serial Number	FCC ID/IC Number
Nokia Solutions and Networks	FRBE	Flexi Multiradio BTS RRH	Part#: 473111A.x12 Serial#: YK144000255	FCC ID: VBNFRBE-01 IC: 661W-FRBE

ENCLOSURE

The EUT enclosure is made of heavy duty aluminum and measures approximately 12(W) x 7(D) x 24(H) inches.

AUXILLARY EQUIPMENT

Company	Model	Description	Part/Serial Number	FCC ID/IC Number
Nokia Solutions and Networks	FOSH	6GHz SFP Module (Plugs into FRBE Opt Ports 1&2)	Part#: 472579A.101 (2 units per RRH) Serial#: CE30LC5Z2 and CE30LCCBA	N/A

SUPPORT EQUIPMENT

Company	Model	Description	Part/Serial Number	FCC ID/IC Number
Nokia Solutions and Networks	FSMF	Flexi System Module	Part#: 472181A.103	N/A
Nokia Solutions and Networks	FBBA	Baseband Extension Module	Part#: 472182A.101 (2 units per FSMF)	N/A
HP	Elite Book 6930p	Laptop PC	N/A	N/A

EUT INTERFACE PORTS

The I/O cabling configuration during testing was as follows:

Cable	Type	Shield	Length	Used in Test	Quantity	Termination
Power Input	Power	No	~ 3 m	Yes	1	Power Supply
Earth	Earth	No	~ 1 m	Yes	1	Lab earth ground
Antenna	RF	Yes	~ 3 m	Yes	4	50Ω Load
RX monitor	RF	Yes	~ 2 m	Yes	2	50Ω Load
External Alarm	Signal	Yes	~ 3 m	Yes	1	Un-terminated
Remote Electrical Tilt	Signal	Yes	~ 3 m	Yes	1	Un-terminated
Multimode Optical	Optical	No	>6 m	Yes	2	System Module

The connector layout for FRBE is provided below:

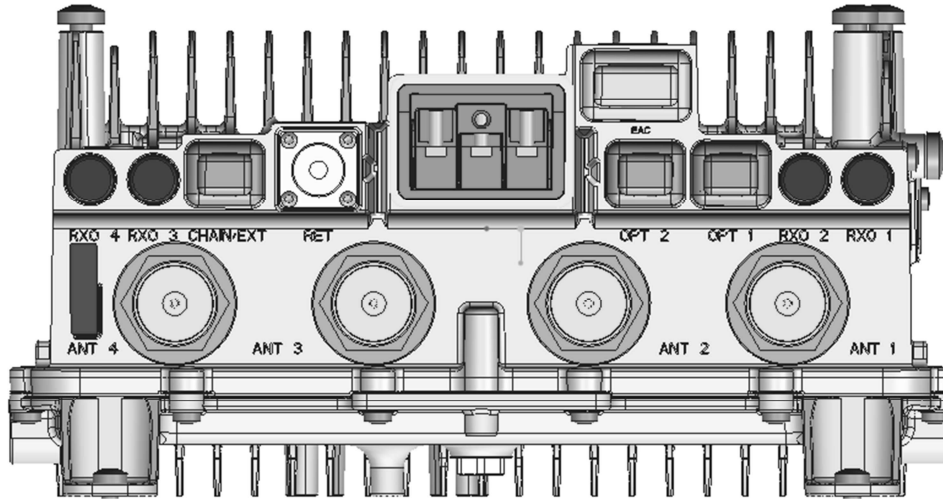

FRBE External Interfaces:

Name	Qty	Connector Type	Purpose (and Description)
DC In	1	Screw Terminal	3-port Power Input -48 VDC, up to AWG 4 cable
GND	1	Screw lug (2xM5/1xM8)	Ground
ANT	4	7/16	RF signal for Transmitter/Receiver (50 Ohm)
RXO	4	QMA	RX output for monitoring/location services
Unit	1	LED	Unit Status LED
LMP	1	Card edge	Local Management/Test Port (Ethernet 10Base-T/100Base-Tx and others, not field accessible)
EAC	1	MDR14	External Alarm Interface (4 alarms)
OPT	3	SFP+ cage	Optical OBSAI Interface up to 6 Gps.
RET	1	8-pin circular connector conforming to IEC 60130-9 – Ed.3.0	AISG 2.0 to external devices

EUT OPERATION

During testing, the EUT was transmitting continuously with 100% duty-cycle at full power on all chains.

EUT FIRMWARE/SOFTWARE

The laptop PC connects to the FSMF System Module over the LMP (Ethernet) port. The system module controls the FRBE RRH via the optical (OBSAI) interface. The laptop is used for changing configuration settings, monitoring tests and controlling the BTS. The following software versions are used for the FRBE testing:

- (1) RRH Unit Software: FRM3401R10_FRBEFG
- (2) System Module Software: FB_PS_REL_2013_09_016

MODIFICATIONS

No modifications were made to the EUT during testing.

TESTING

GENERAL INFORMATION

Antenna port measurements were taken at NTS Plano branch located at 1701 E Plano Pkwy #150 Plano, TX 75074.

Radiated spurious emissions measurements were taken at the NTS Plano Anechoic Chamber listed below. The sites conform to the requirements of ANSI C63.4-2009 *American National Standard for Methods of Measurement of Radio-Noise Emissions from Low-Voltage Electrical and Electronic Equipment in the Range of 9 kHz to 40 GHz* and CISPR 16-1-4:2007 - *Specification for radio disturbance and immunity measuring apparatus and methods Part 1-4: Radio disturbance and immunity measuring apparatus Ancillary equipment Radiated disturbances*. They are on file with the FCC and Industry Canada.

Site	Registration Numbers		Location
	FCC	Canada	
Chamber 1	A2LA Accredited Designation Number US1077	IC 4319A	1701 E Plano Pkwy #150 Plano, TX 75074.

Considerable engineering effort has been expended to ensure that the facilities conform to all pertinent requirements.

MEASUREMENT PROCEDURES

Output power, emission bandwidth, conducted spurious, conducted bandedge and carrier frequency stability measurements were all performed via a spectrum analyzer connected to the individual RF chains via a 40dB attenuator and an RF cable. The EUT was operating in 2x2 MIMO configuration in each frequency band at full power for all tests. While measuring one transmit chain, others were terminated with termination blocks. All measurements were corrected for the insertion loss of the attenuator and cable inserted between the RF port of the EUT and the spectrum analyzer. Simple test diagram is shown below.

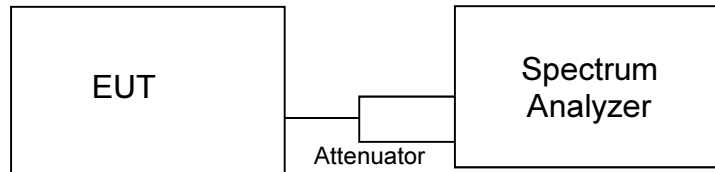

Test Configuration for Antenna Port Measurements

26dB emission bandwidth was measured in accordance with Section 4.1 of FCC KDB 971168 D01 v02r02. 99% occupied bandwidth was measured in accordance with Section 6.6 of RSS-Gen Issue 4. For both measurements an NTS custom software tool was used. Spectrum analyzer settings are shown on their corresponding plots in test results section.

Emissions at the band-edges were also captured with an NTS custom software tool with settings described in the corresponding sections of the FCC and IC rules. Spectrum analyzer settings are shown on their corresponding plots in test results section.

Peak and average output power measurements were performed in accordance with FCC KDB 971168 D01 v02r02. An NTS custom software tool was used for power integration to compensate for resolution bandwidth limitations of the spectrum analyzer and settings are shown on their corresponding plots in test results section.

Peak to average power ratio was calculated in accordance with Section 5.7.2 of FCC KDB 971168 D01 v02r02.

Conducted spurious emissions were captured with TILE6 software which corrected the readings for cable loss and attenuator loss across the 9kHz-8GHz frequency span. Settings of the spectrum analyzer are described in the corresponding test result section.

For frequency stability, the EUT was placed inside a temperature chamber with all support and test equipment located outside of the chamber. Temperature was varied across the specified range in 10 degree increments and EUT was allowed enough time to stabilize at each temperature step. A signal analyzer as detailed in the test equipment section has been used for précised frequency error measurements.

Transmitter radiated spurious emissions measurements were made in accordance with ANSI C63.4-2009 by measuring the field strength of the emissions from the device at 3m

test distance. The eirp limit as specified in the relevant rule part(s) is converted to a field strength at the test distance and the emissions from the EUT are then compared to that limit. Only emissions within 20dB of this limit are subjected to a substitution measurement in accordance with TIA-603-C-2004. Both preliminary and final measurements were performed at the same FCC listed test chamber. Preliminary scans were performed with TILE6 software. This software corrected the measurements for antenna factors, cable losses and pre-amplifier gains. Both polarizations of the receiving antenna were scanned from 30MHz to 8GHz with a peak detector (RBW=100kHz, VBW=300kHz, with trace max hold over multiple sweeps). Based on the preliminary scan results, frequencies of interest have been maximized via rotating the EUT 360 degrees and varying the height of the test antenna (1m to 4m). Final measurements were also taken with the peak detector as described above. A biconilog antenna was used for 30MHz-1GHz range. A double ridged waveguide horn antenna was used for 1-8GHz range. The antennas used to measure the radiated electric field strength are mounted on a non-conductive antenna mast equipped with a motor-drive to vary the antenna height. EUT was placed on a non-conductive RF transparent structure to provide 80cm height from the ground floor. A motorized turntable allowed it to be rotated during testing to determine the angle with the highest level of emissions.

Test Equipment

NTS Equipment #	Description	Manufacturer	Model	Calibration Duration	Calibration Due Date
E1529P	PSA	Agilent	E4446A	12 Months	2/14/2015
E1554P	PreAmp (1GHz-40GHz)	MITEQ	JS32-00104000-62-5P	12 Months	5/14/2015
E1366P	PreAmp (30MHz-1GHz)	MITEQ	AM-1431-N-1197SC	12 Months	12/12/2015
E1524P	Biconilog Antenna (30MHz-1GHz)	ETS Lindgren	3142D	12 Months	3/10/2015
E1149P	Horn Antenna (1GHz-18GHz)	EMCO	3115	12 Months	12/10/2015
E1447P	RMS Multimeter	Fluke	87V	12 Months	5/20/2015
ENV1384P	Data Acquisition Switch Unit	Agilent	34970A	12 Months	2/24/2015
ENV1195P	Climatic Chamber	Thermotron	SE-300-2-2	N/A	NCR
* NM04508	MXA Signal Analyzer	Agilent	N9020A	24 Months	1/27/2017

* Test equipment supplied by the customer for LTE frequency error measurements

Appendix A Test Data

RF Output Power

RF output power has been measured in both Peak and RMS Average terms in both frequency bands for each transmit chain at the center channel for all modulations and bandwidth modes. Peak to average ratio (PAR) has been calculated as described in Section 5.7.2 of KDB971168 D01 v02r02 and all results are presented in tabular form below.

Results for 718MHz – 728MHz band:

		LTE - QPSK			LTE - 16QAM			LTE - 64QAM		
		Peak (dBm)	Average (dBm)	PAR (dB)	Peak (dBm)	Average (dBm)	PAR (dB)	Peak (dBm)	Average (dBm)	PAR (dB)
Port 3 Center Ch	5M	55.25	45.3	9.95	55.91	45.17	10.74	55.13	45.3	9.83
	10M	55.36	45.25	10.11	55.94	45.15	10.79	55.24	45.19	10.05
Port 4 Center Ch	5M	55.23	45.24	9.99	55.88	45.18	10.7	55.11	45.27	9.84
	10M	55.39	45.23	10.16	55.87	45.11	10.76	55.17	45.12	10.05
Combined Center Ch	5M	58.25	48.28	9.97	58.91	48.19	10.72	58.13	48.3	9.83
	10M	58.39	48.25	10.14	58.92	48.14	10.78	58.22	48.17	10.05

Based on the results above, Port 3 had the highest RMS average power and therefore it was selected for all the remaining antenna port tests on the product.

Subsequently output power levels on lowest and highest channels in 5MHz channel bandwidth mode were tested only at Port 3 and results presented below. 10MHz channel bandwidth mode had only 1 channel of operation at the center.

		LTE - QPSK			LTE - 16QAM			LTE - 64QAM		
		Peak (dBm)	Average (dBm)	PAR (dB)	Peak (dBm)	Average (dBm)	PAR (dB)	Peak (dBm)	Average (dBm)	PAR (dB)
Port 3 Low Ch	5M	55.39	45.28	10.11	56.01	45.23	10.78	55.16	45.28	9.88
Port 3 High Ch	5M	55.09	45.04	10.05	55.84	45.09	10.75	54.99	45.06	9.93

All corresponding plots included on the following pages. Total path loss of 40.4dB (Attenuator Loss: 40dB, RF cable loss: 0.4dB) accounted in via reference level offset to the spectrum analyzer.

Results for 746MHz – 756MHz band:

		LTE - QPSK			LTE - 16QAM			LTE - 64QAM		
		Peak (dBm)	Average (dBm)	PAR (dB)	Peak (dBm)	Average (dBm)	PAR (dB)	Peak (dBm)	Average (dBm)	PAR (dB)
Port 1 Center Ch	5M	55.01	44.96	10.05	55.68	44.92	10.76	54.91	44.99	9.92
	10M	55.19	45.03	10.16	55.69	44.96	10.73	54.95	44.93	10.02
Port 2 Center Ch	5M	55.1	45.09	10.01	55.78	45.14	10.64	55.08	45.26	9.82
	10M	55.27	45.13	10.14	55.88	45.23	10.65	55.23	45.13	10.1
Combined Center Ch	5M	58.07	48.04	10.03	58.74	48.04	10.7	58.01	48.14	9.87
	10M	58.24	48.09	10.15	58.8	48.11	10.69	58.1	48.04	10.06

Based on the results above, Port 2 had the highest RMS average power and therefore it was selected for all the remaining antenna port tests on the product.

Subsequently output power levels on lowest and highest channels in 5MHz channel bandwidth mode were tested only at Port 2 and results presented below. 10MHz channel bandwidth mode had only 1 channel of operation at the center.

		LTE - QPSK			LTE - 16QAM			LTE - 64QAM		
		Peak (dBm)	Average (dBm)	PAR (dB)	Peak (dBm)	Average (dBm)	PAR (dB)	Peak (dBm)	Average (dBm)	PAR (dB)
Port 2 Low Ch	5M	55.32	45.3	10.02	56.02	45.33	10.69	55.17	45.26	9.91
Port 2 High Ch	5M	55.14	45.1	10.04	55.84	45.1	10.74	55.06	45.07	9.99

All corresponding plots included on the following pages. Total path loss of 40.4dB (Attenuator Loss: 40dB, RF cable loss: 0.4dB) accounted in via reference level offset to the spectrum analyzer.

Plots for 718MHz – 728MHz band:

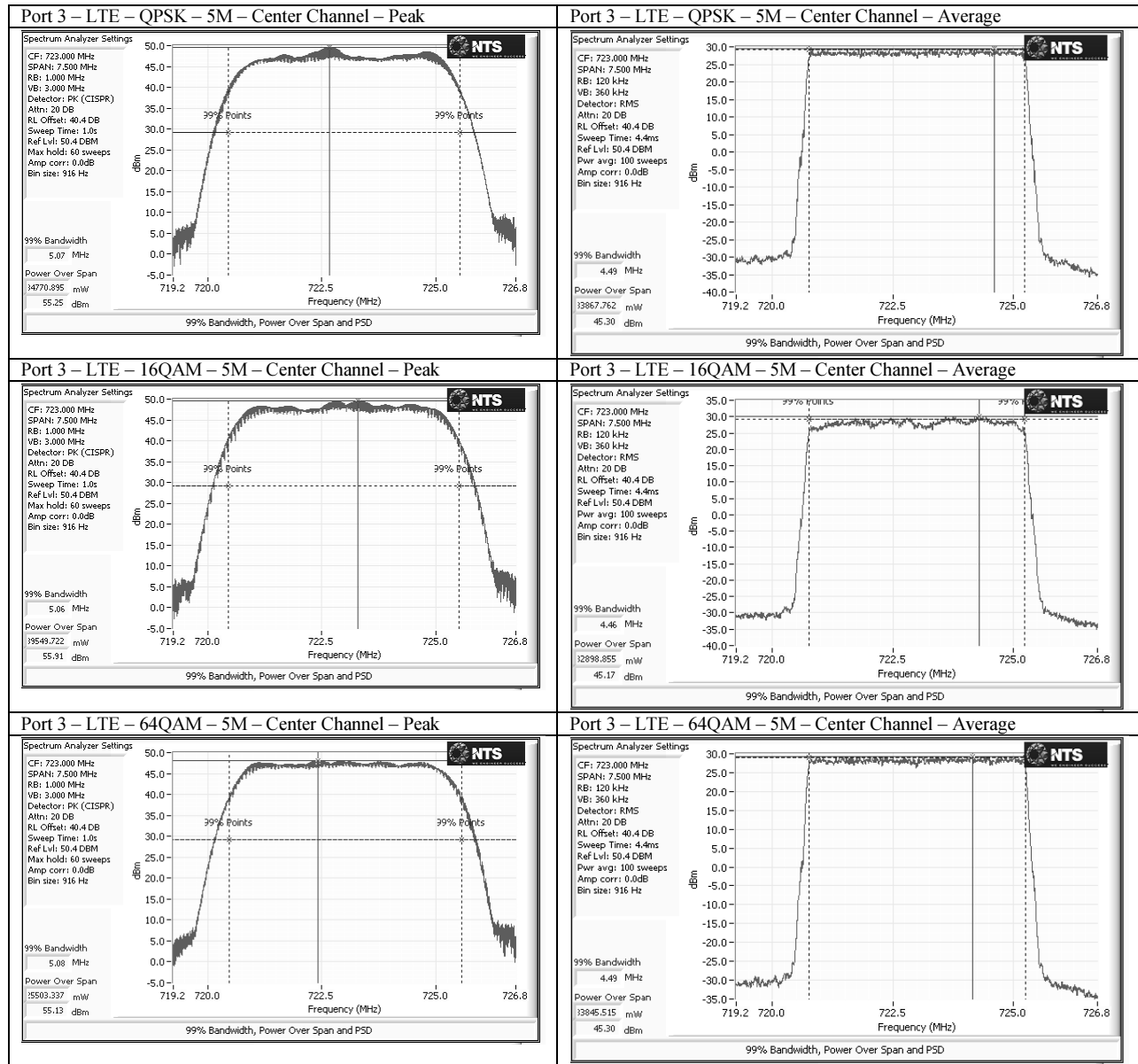

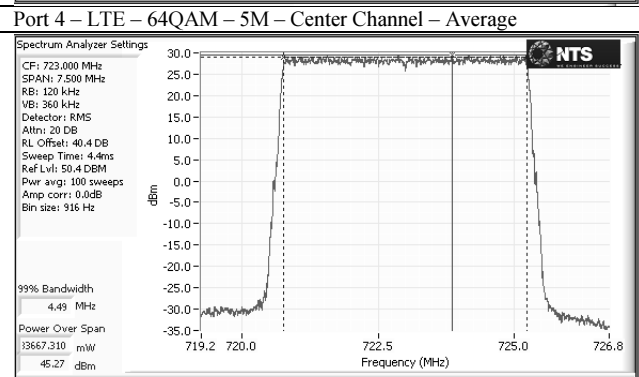
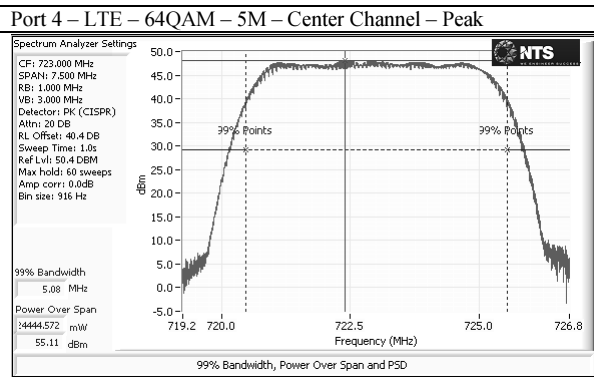
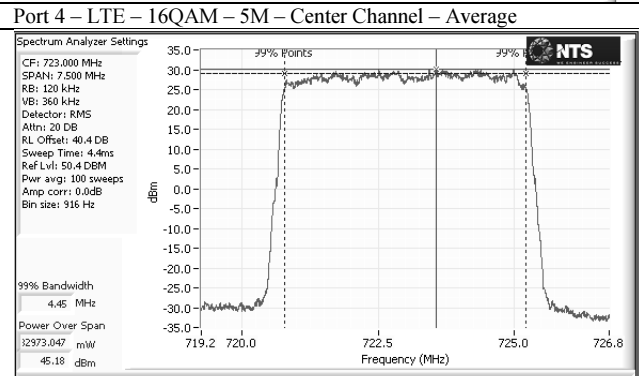
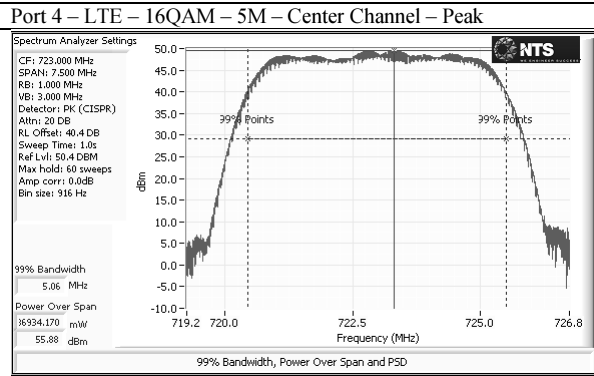
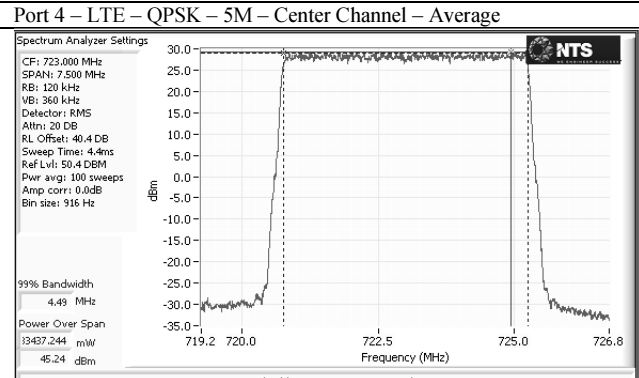
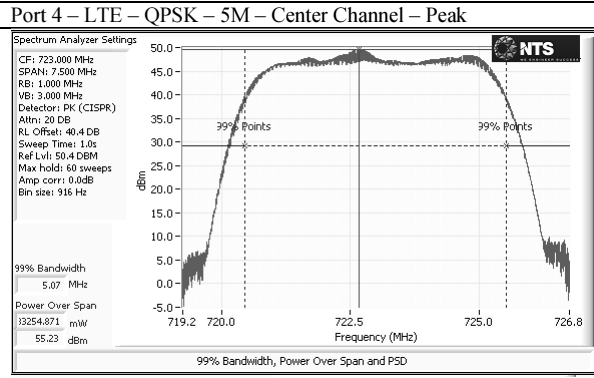

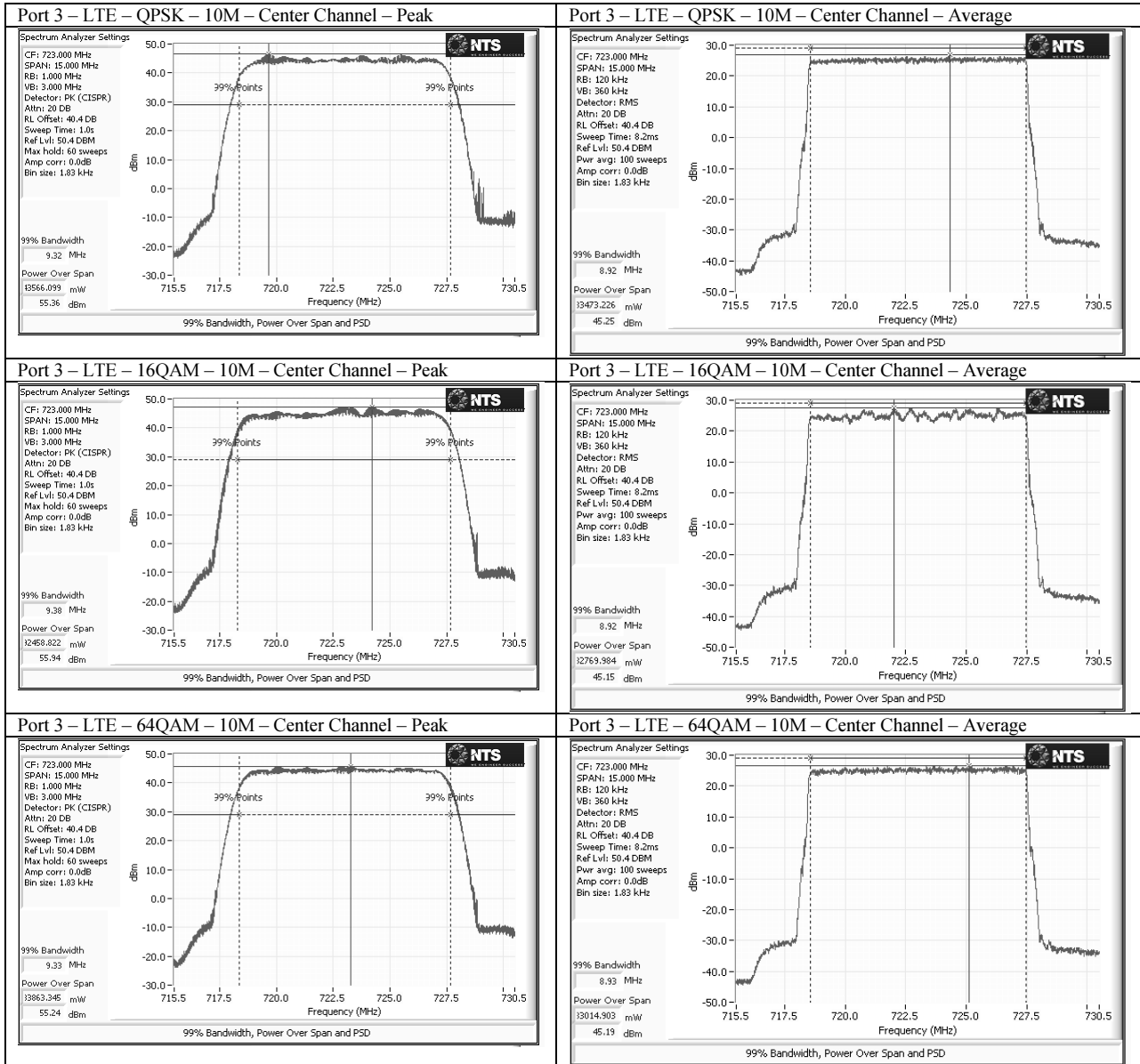

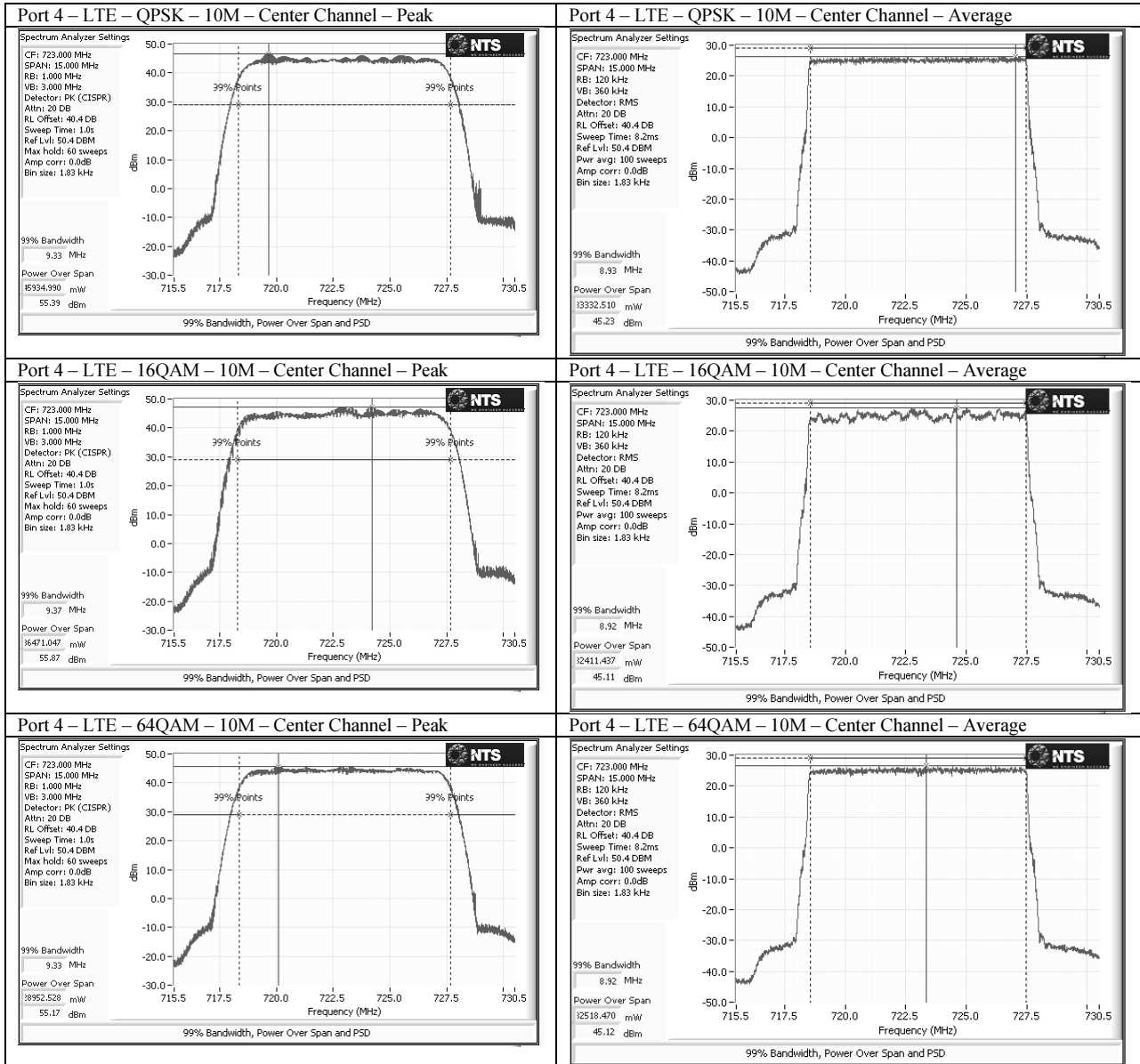

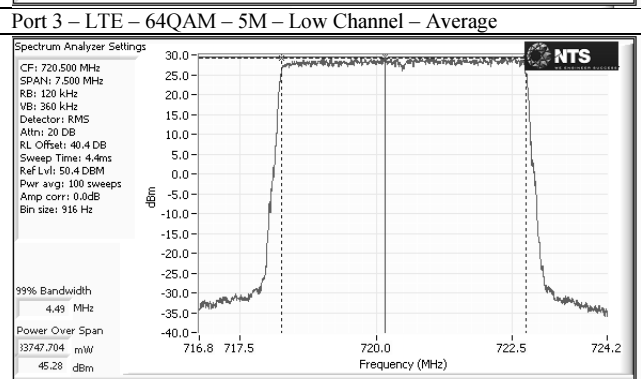
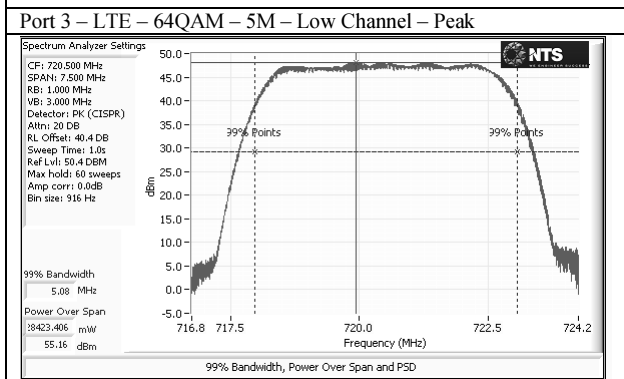
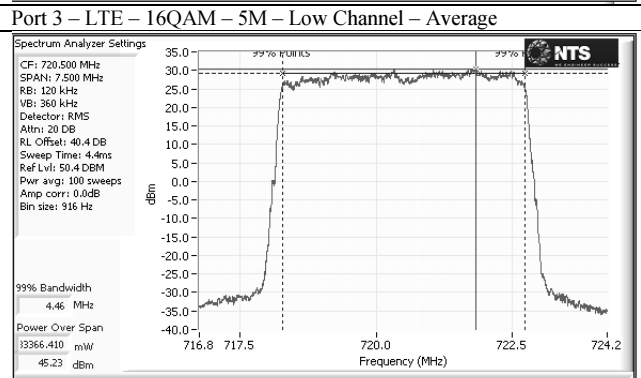
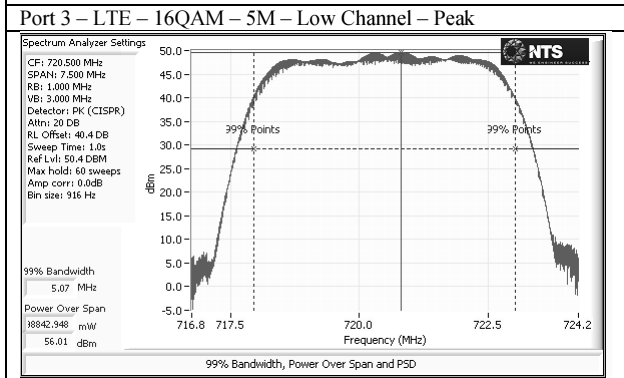
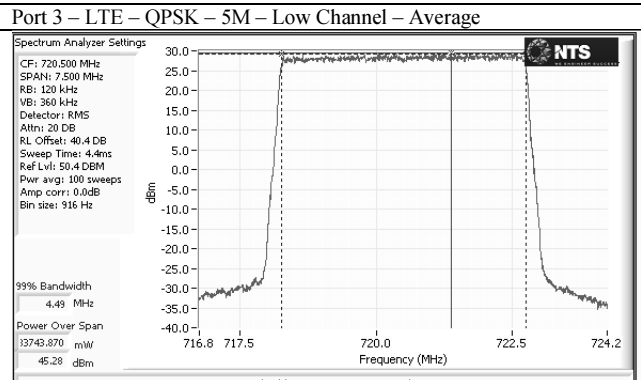
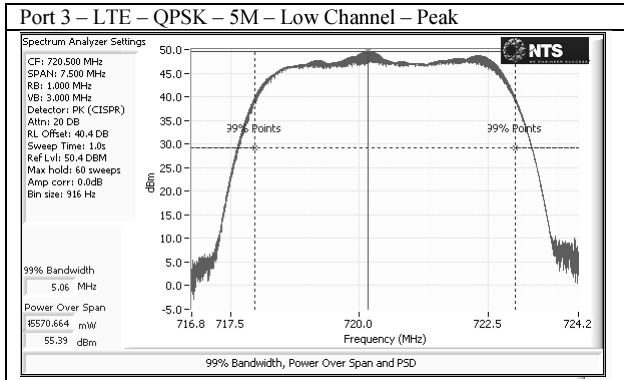

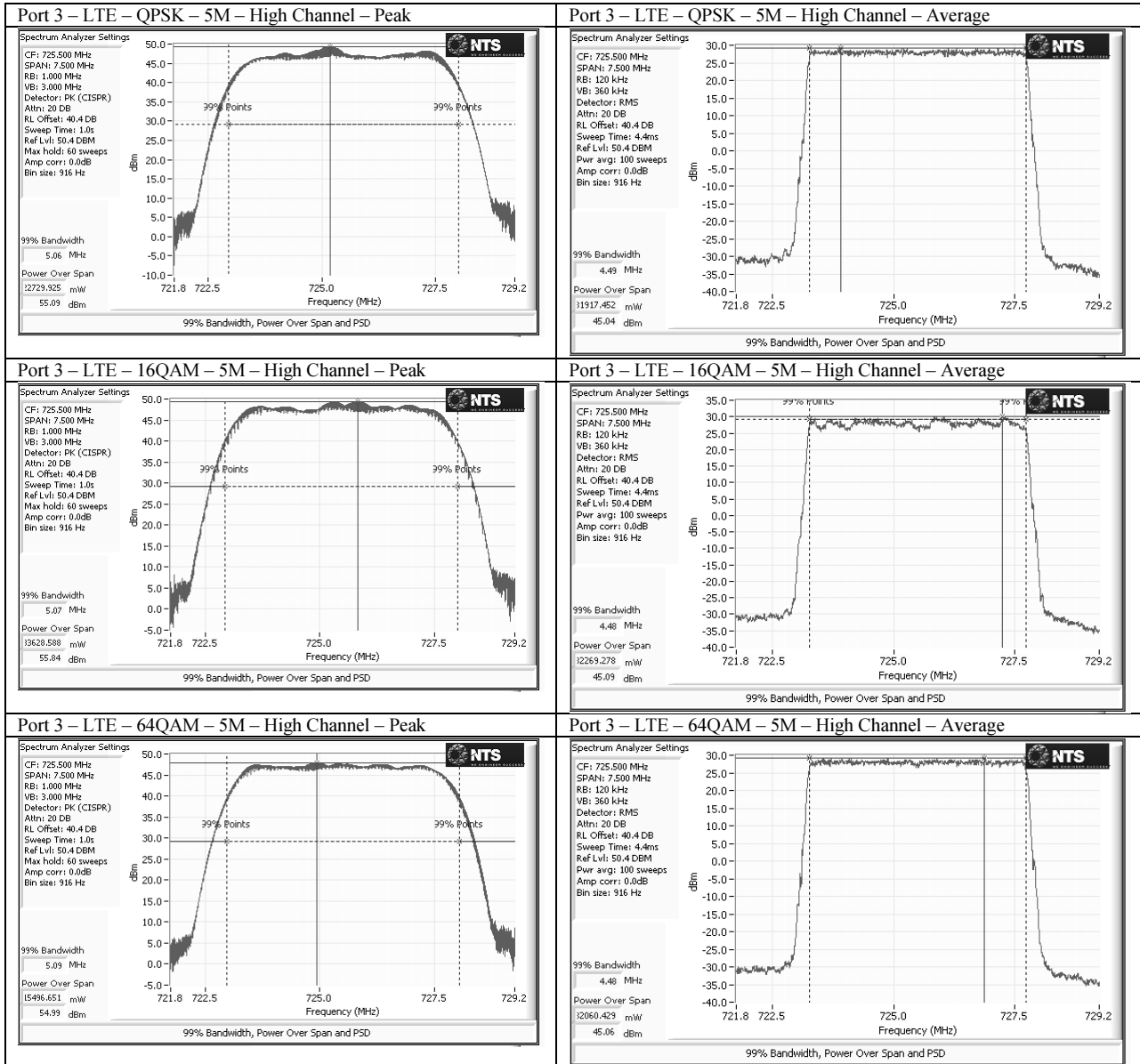

Plots for 746MHz – 756MHz band:

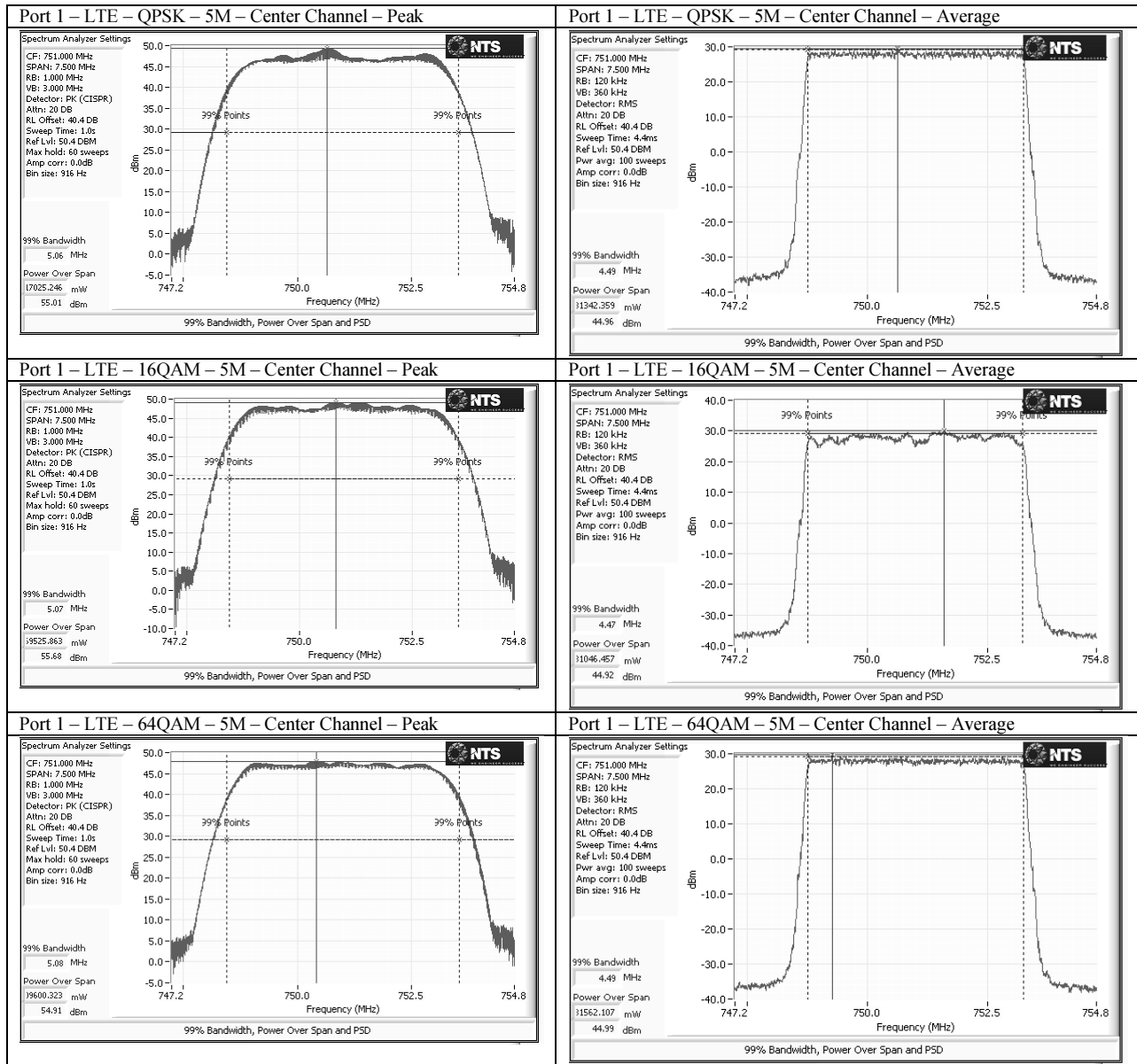

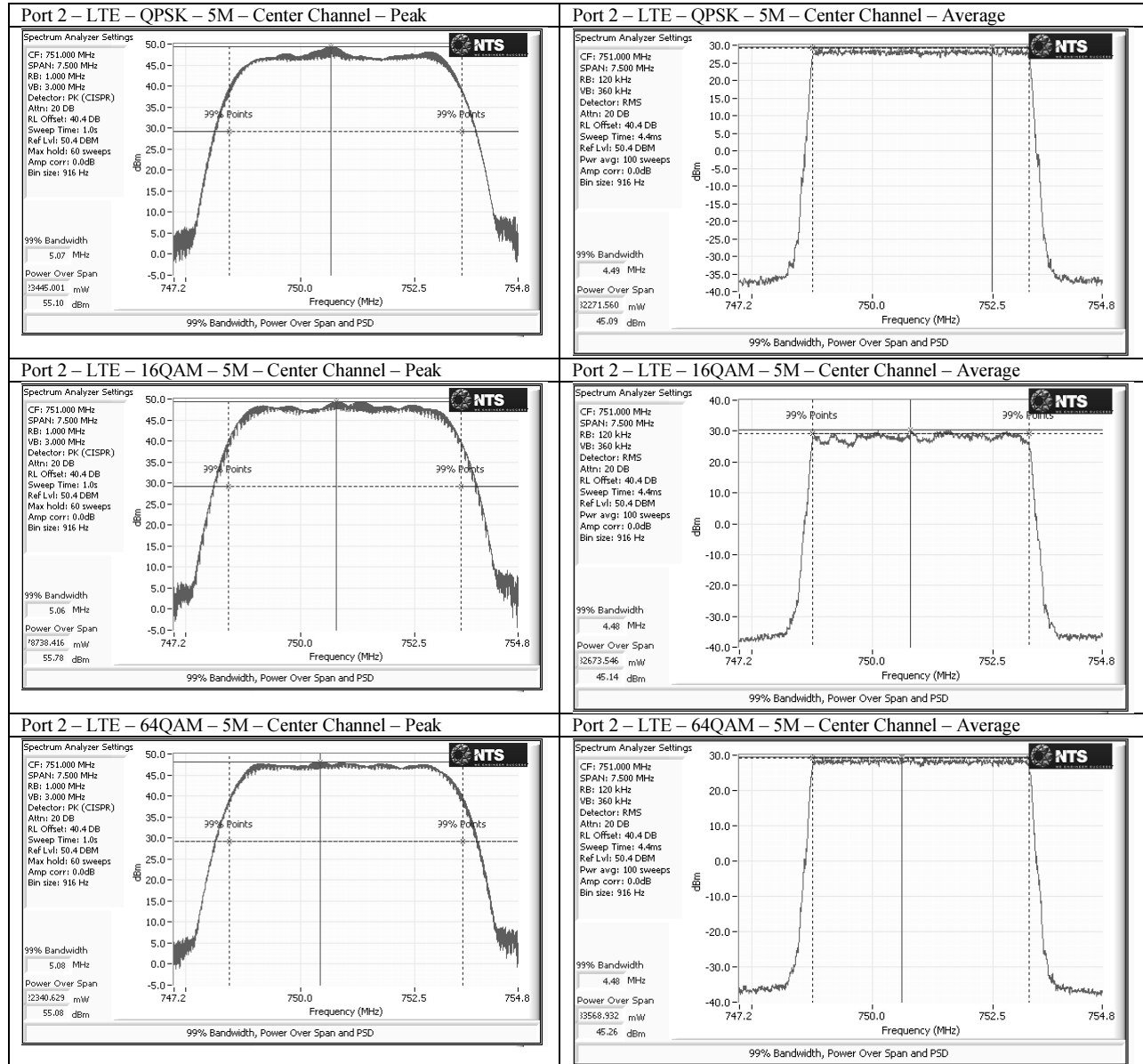

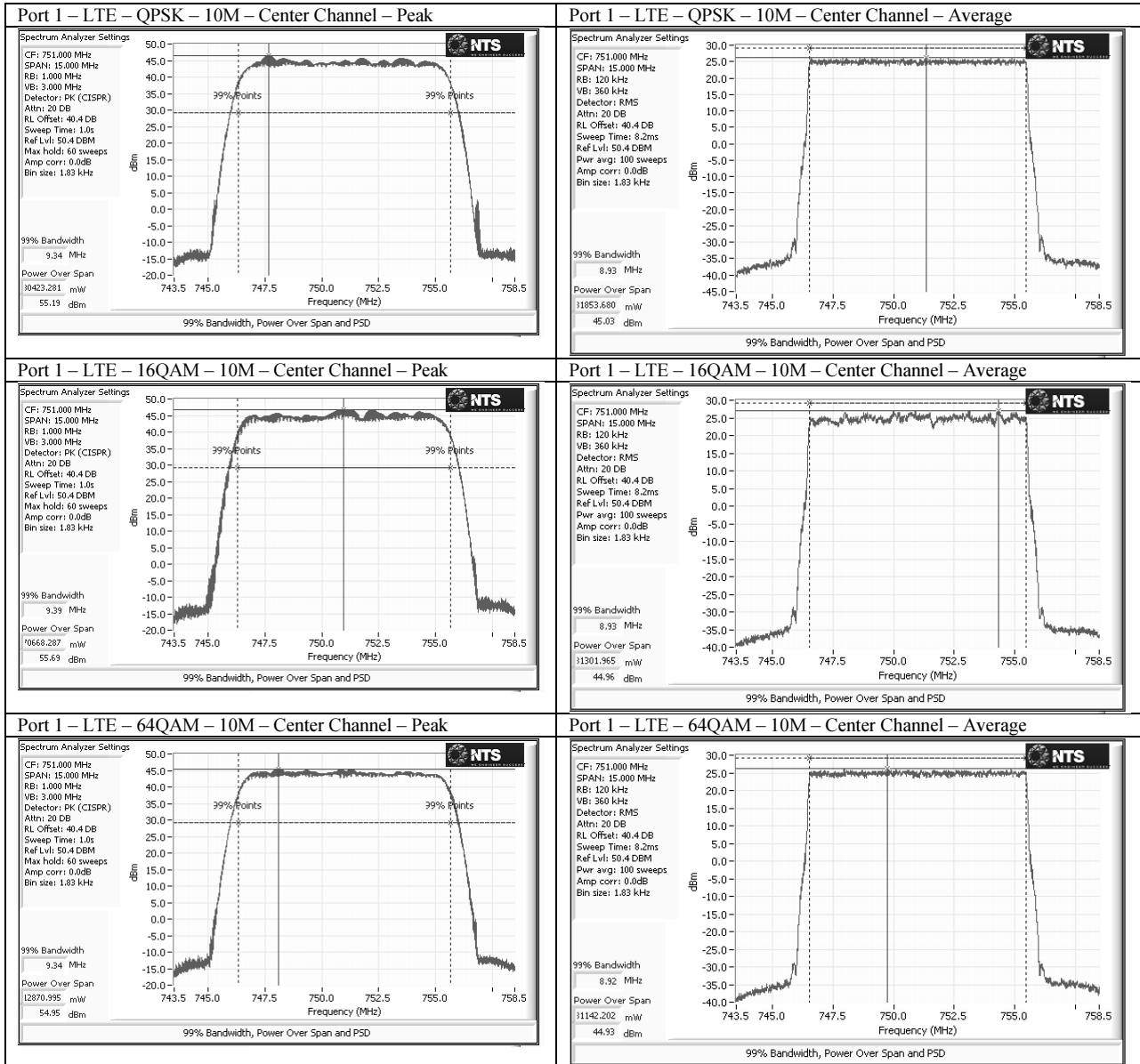

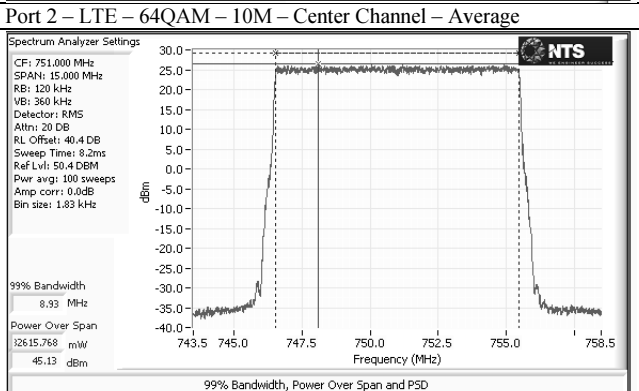
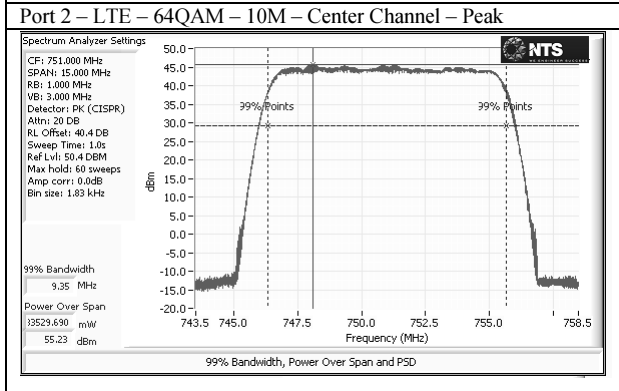
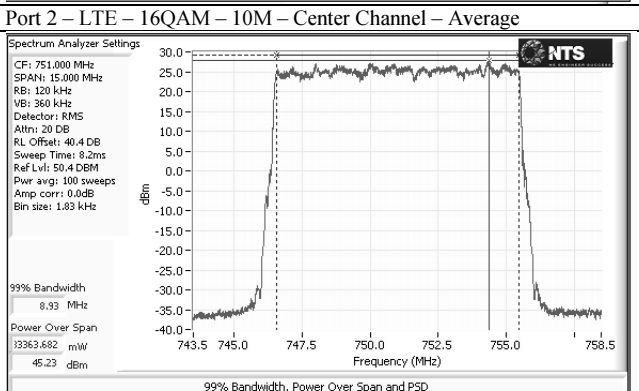
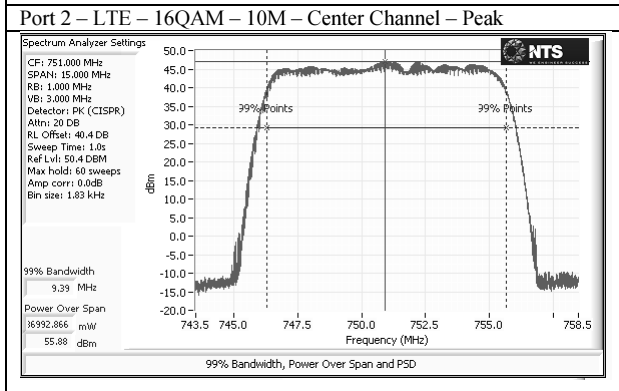
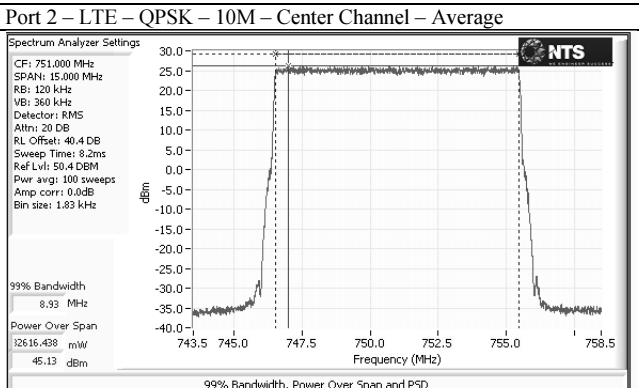
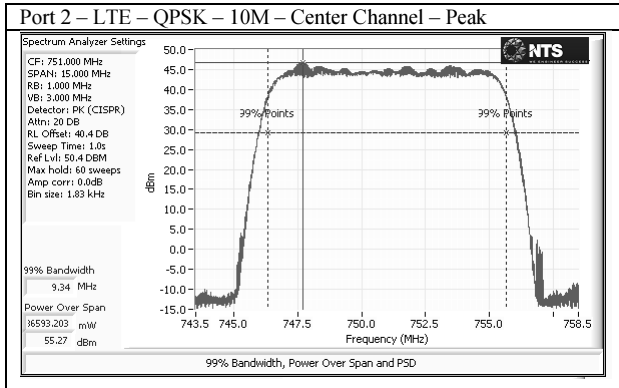

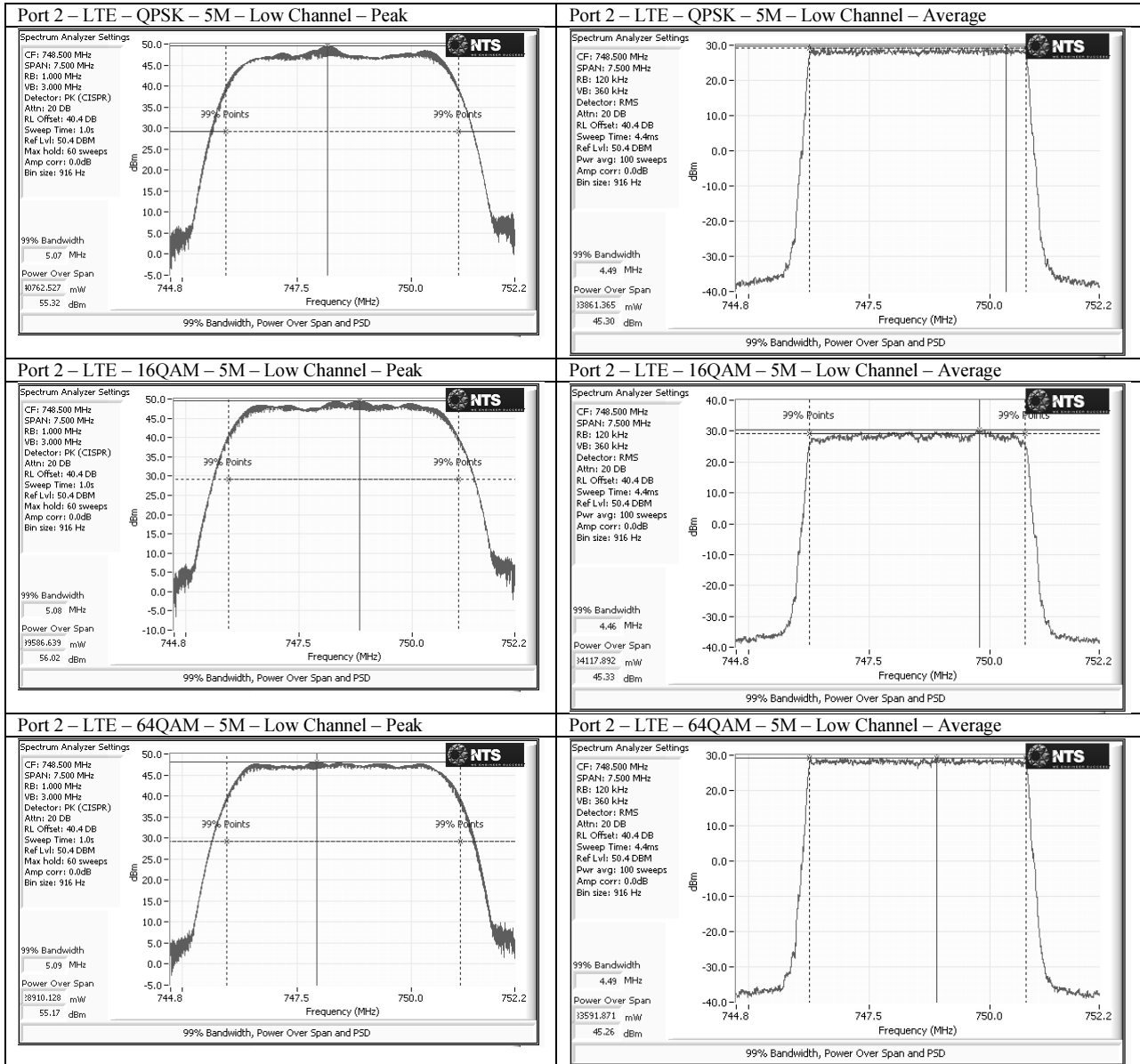

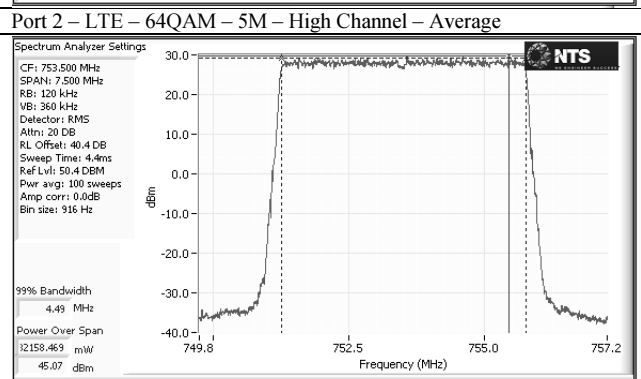
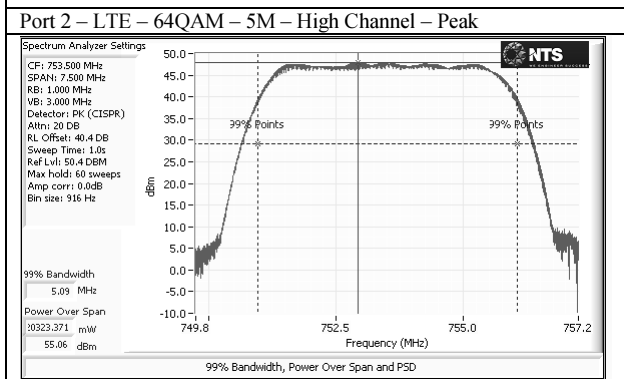
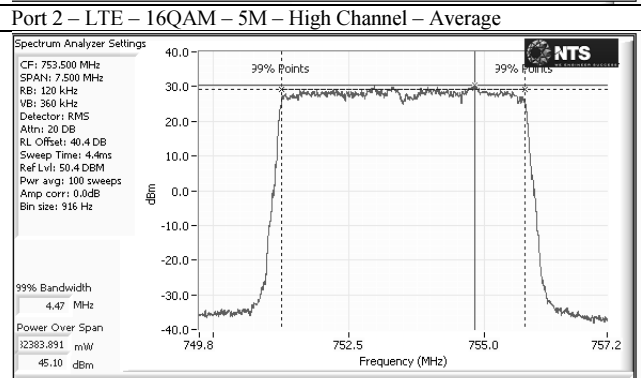
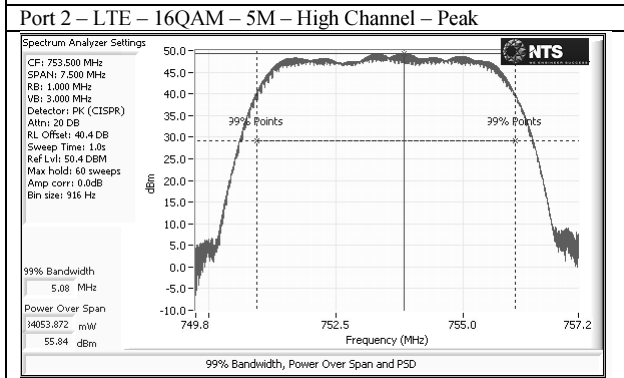
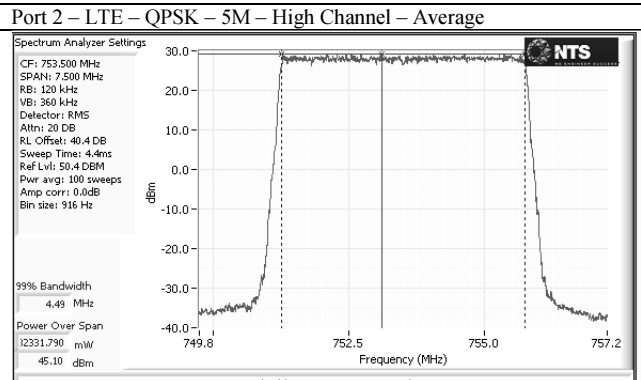
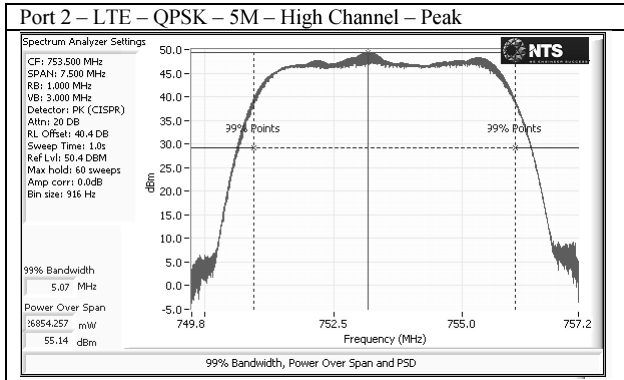

Emission Bandwidths (26dB and 99%)

Emissions bandwidths were measured in both frequency bands on low and high channels in 5MHz channel bandwidth mode and on center channel in 10MHz channel bandwidth mode for all modulations and results presented below.

Results for 718MHz – 728MHz band (Port 3):

	LTE - QPSK				LTE - 16QAM				LTE - 64QAM			
	Low		High		Low		High		Low		High	
	26dB (MHz)	99% (MHz)	26dB (MHz)	99% (MHz)	26dB (MHz)	99% (MHz)	26dB (MHz)	99% (MHz)	26dB (MHz)	99% (MHz)	26dB (MHz)	99% (MHz)
5M	4.876	4.491	4.876	4.492	4.866	4.482	4.858	4.487	4.859	4.501	4.885	4.502

	LTE - QPSK				LTE - 16QAM				LTE - 64QAM			
	Center				Center				Center			
	26dB (MHz)		99% (MHz)		26dB (MHz)		99% (MHz)		26dB (MHz)		99% (MHz)	
10M	9.725		8.982		9.708		8.997		9.764		8.987	

Results for 746MHz – 756MHz band (Port 2):

	LTE - QPSK				LTE - 16QAM				LTE - 64QAM			
	Low		High		Low		High		Low		High	
	26dB (MHz)	99% (MHz)	26dB (MHz)	99% (MHz)	26dB (MHz)	99% (MHz)	26dB (MHz)	99% (MHz)	26dB (MHz)	99% (MHz)	26dB (MHz)	99% (MHz)
5M	4.888	4.492	4.885	4.491	4.863	4.489	4.861	4.487	4.886	4.507	4.861	4.503

	LTE - QPSK				LTE - 16QAM				LTE - 64QAM			
	Center				Center				Center			
	26dB (MHz)		99% (MHz)		26dB (MHz)		99% (MHz)		26dB (MHz)		99% (MHz)	
10M	9.733		8.994		9.711		9.009		9.745		8.997	

Corresponding plots included on the following pages.

Plots for 718MHz – 728MHz band (Port 3):

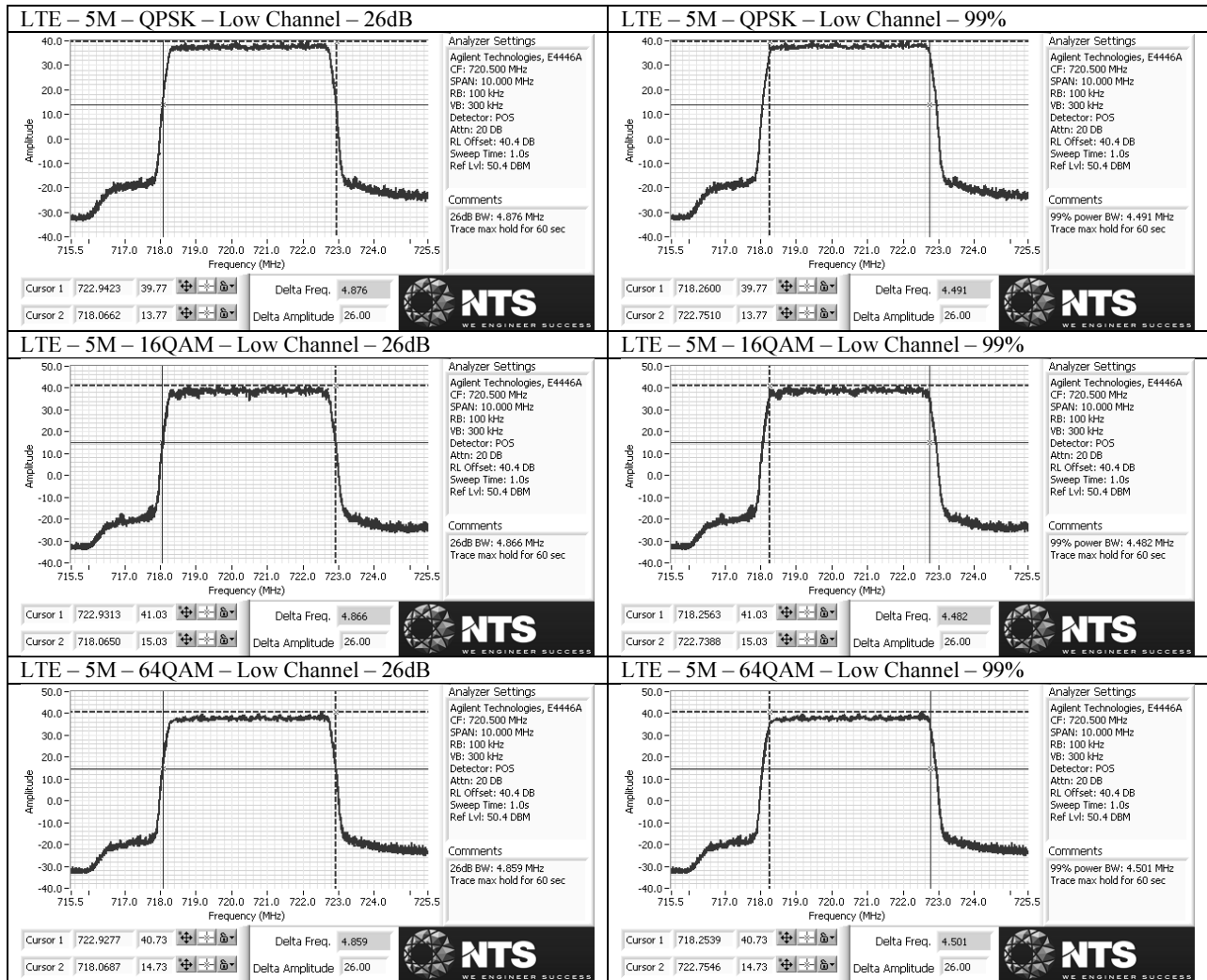

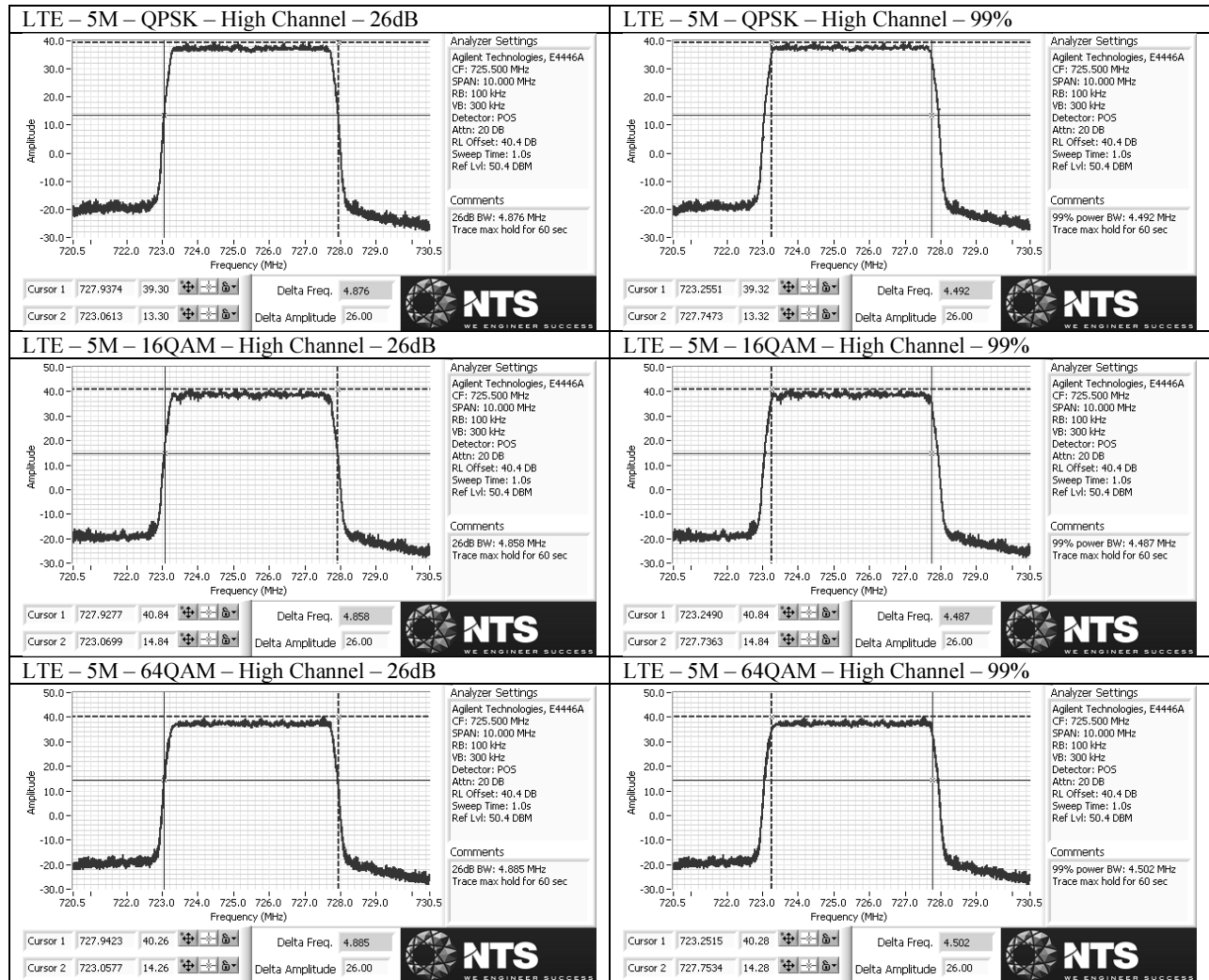

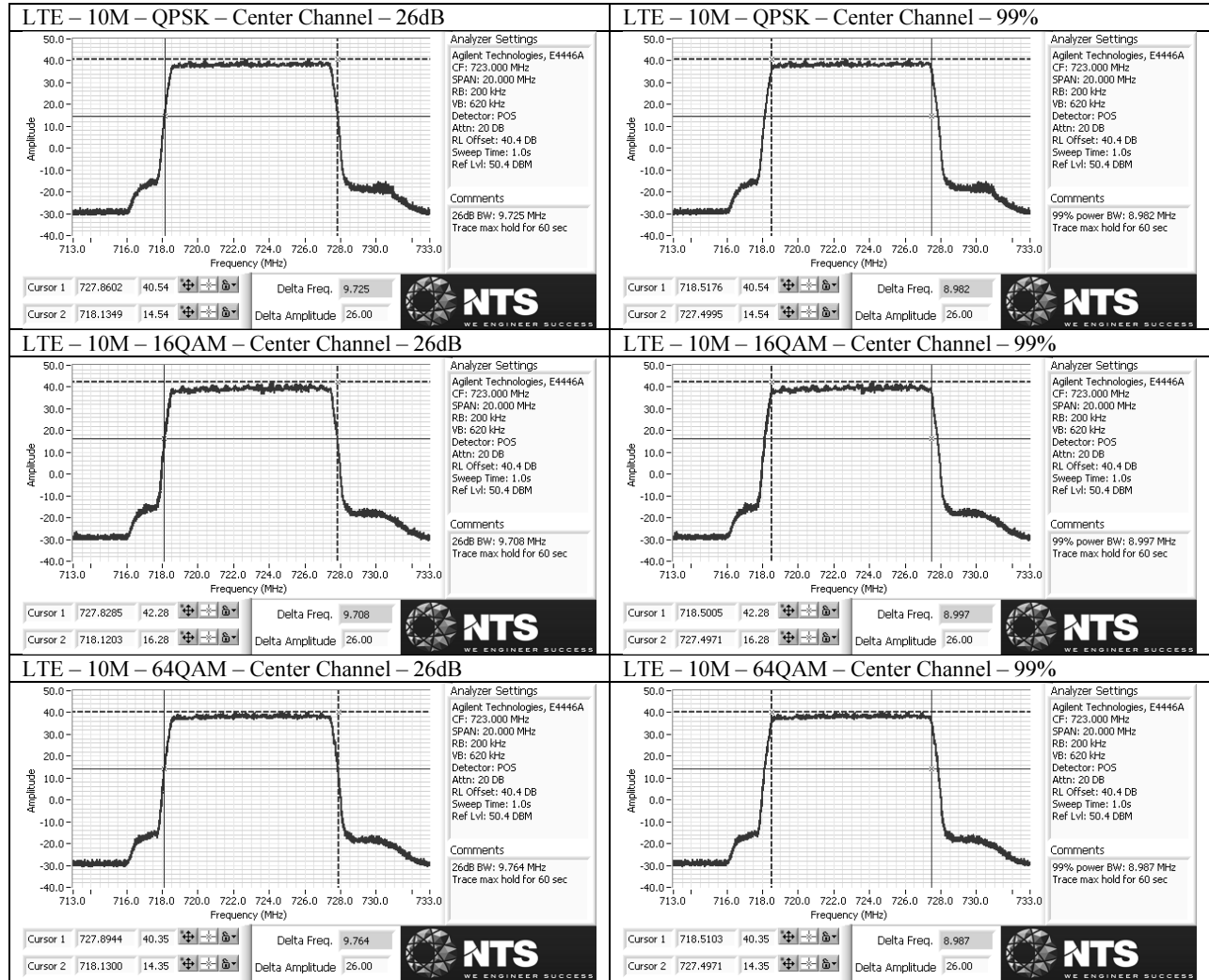

Plots for 746MHz – 756MHz band (Port 2):

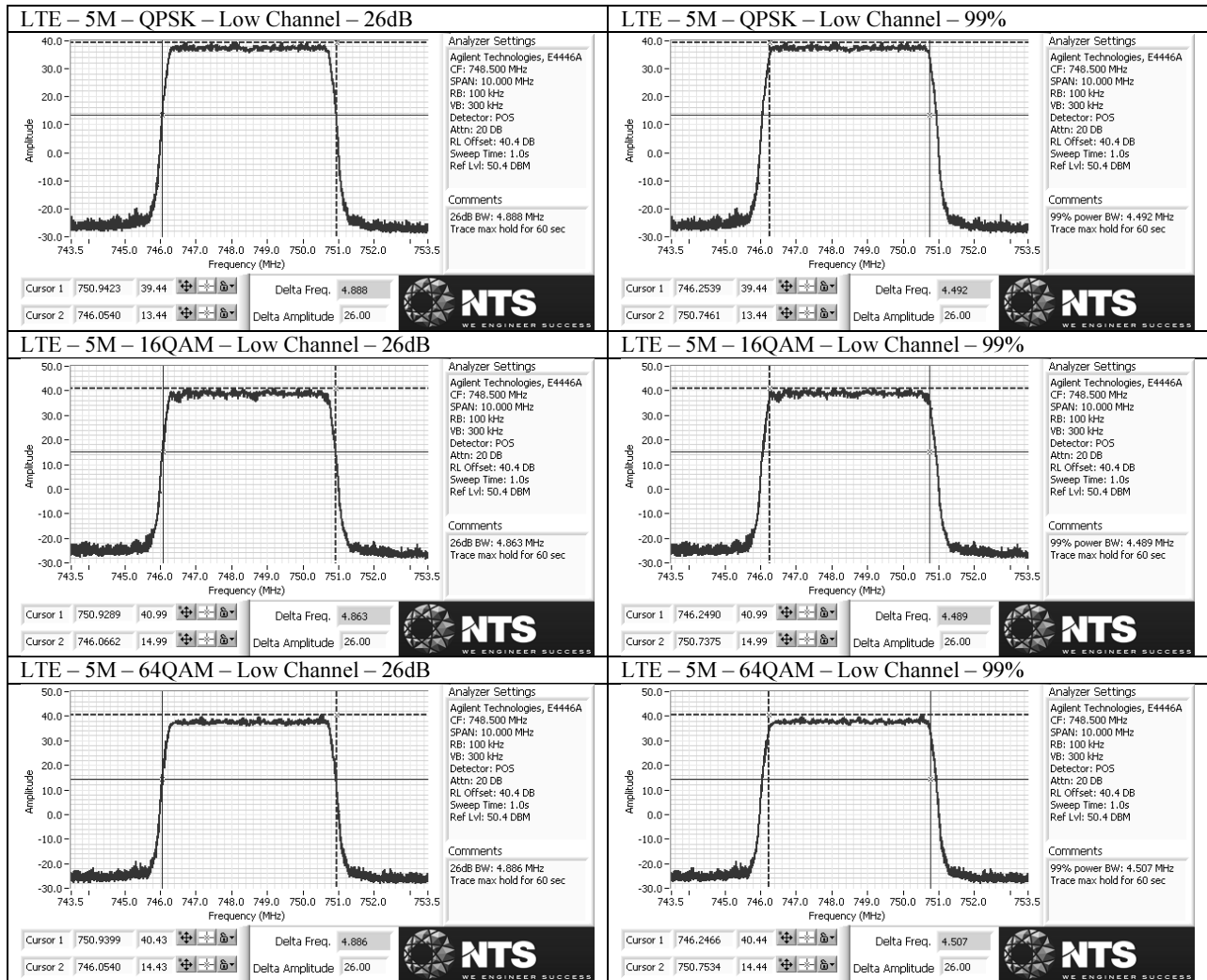

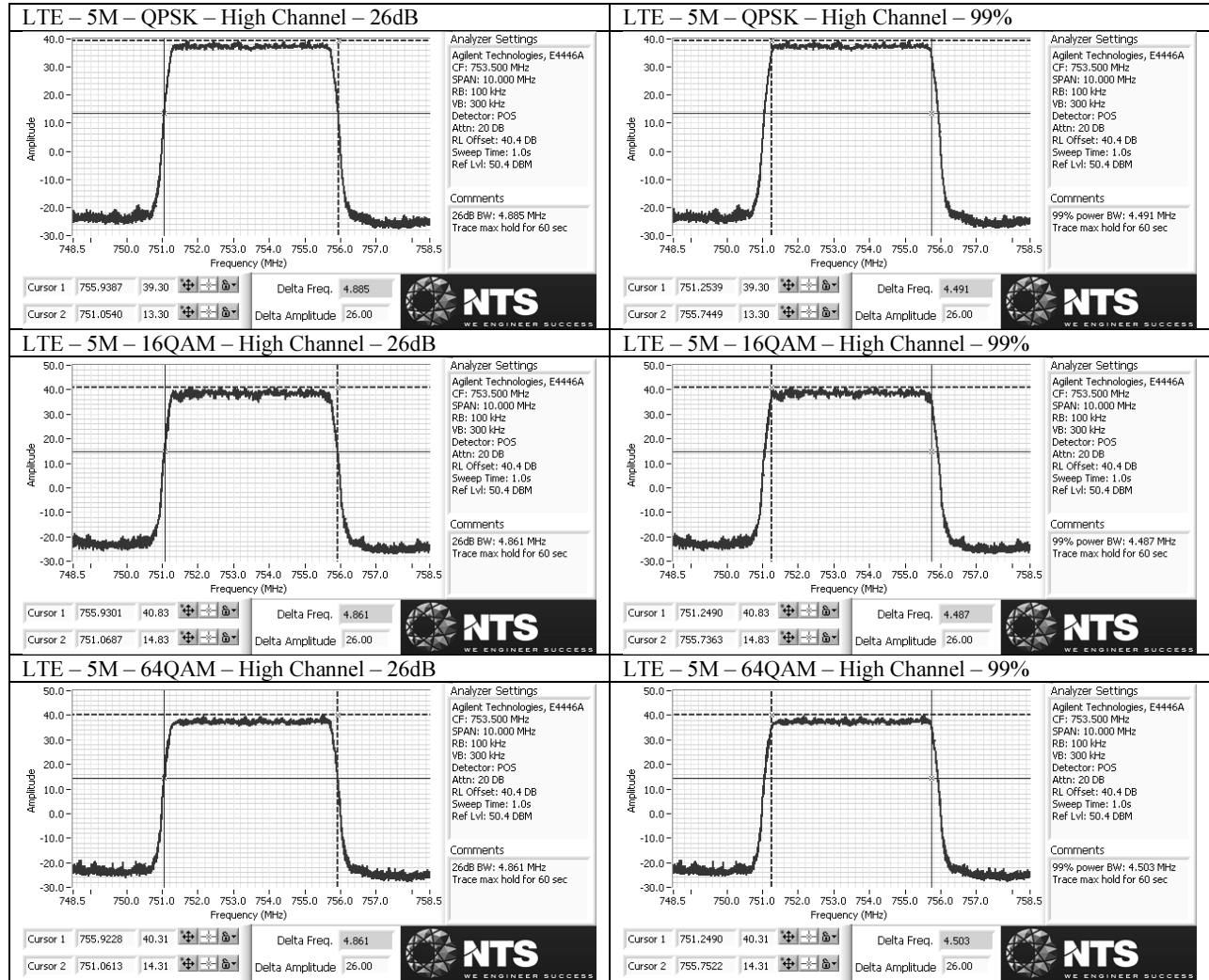

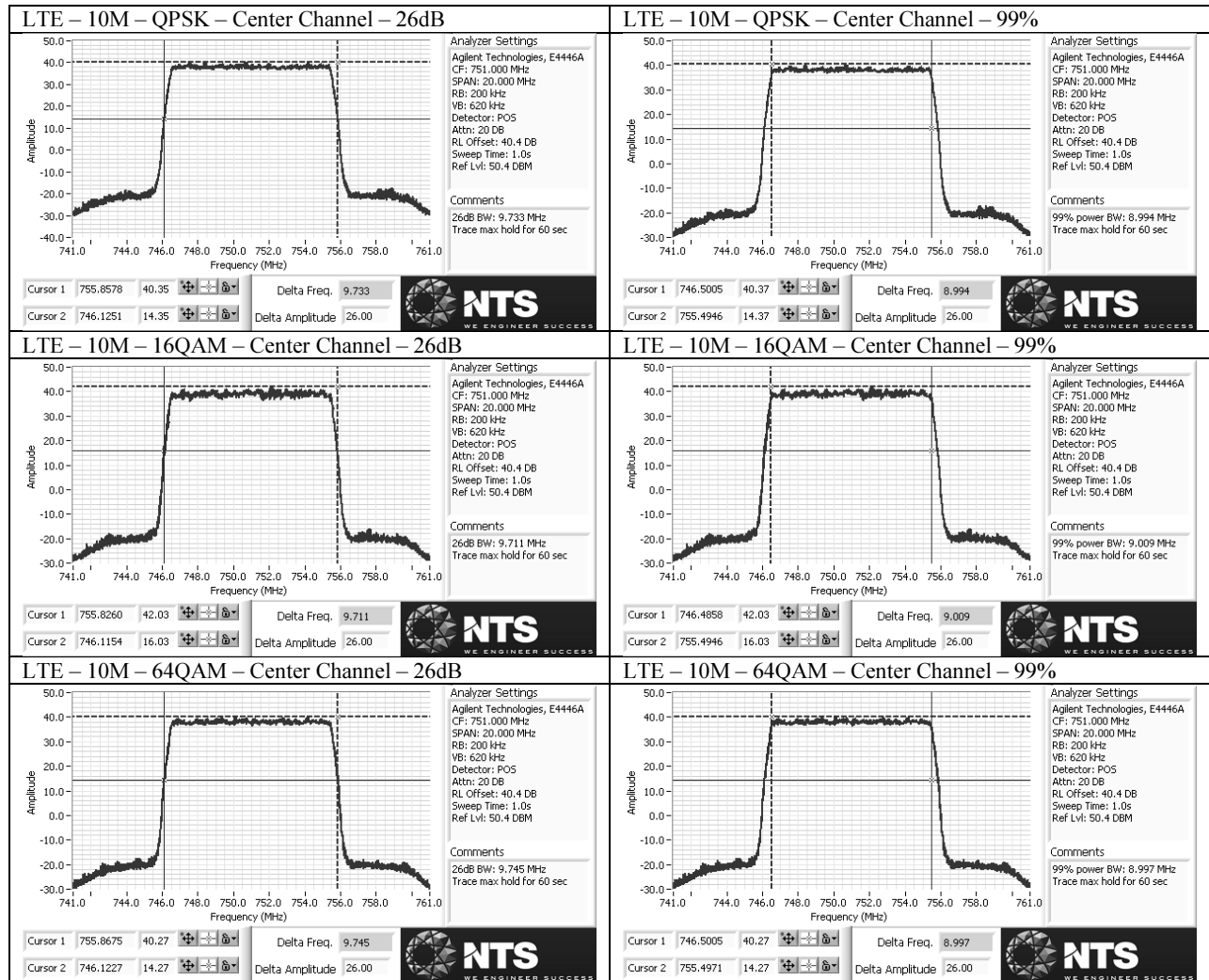

Antenna Port Conducted Bandedge

718MHz – 728MHz band (Port 3):

Limit is -13dBm per §27.53(f) and is further reduced by $10 \cdot \log(2)$ per FCC KDB 662911D01 v02r01 due to 2x2 MIMO operation, which brings it down to -16.02dBm.

In 5MHz channel bandwidth mode, low and high channels as well as dual carrier mode (low channel + high channel) configurations were tested. In 10MHz channel bandwidth mode, unit can only operate in single carrier mode at the center channel.

Results summary:

	LTE - QPSK		LTE - 16QAM		LTE - 64QAM	
	Low	High	Low	High	Low	High
5M	-27.41	-27.61	-27.9	-27.56	-28.4	-27.4
10M	-24.2	-24.03	-24.72	-23.67	-24.47	-24.41
5M Dual	-30.17	-29.84	-30.65	-30.36	-30.74	-29.32

All corresponding plots are included on the following pages.

Measurements performed in RMS average mode with 100kHz RBW and 300kHz VBW over 100 traces. In 100kHz bands immediately outside and adjacent to the frequency block, resolution bandwidth has been reduced to 30kHz as allowed in §27.53(f).

Total path loss of 40.4dB accounted in via reference level offset to the spectrum analyzer.

746MHz – 756MHz band (Port 2):

27.53(c) Limits (dBm)			
Frequency Range (MHz)	Channel BW Mode		Notes
	5MHz	10MHz	
<746	-16.02	-16.02	Note 1
756 806	-20.02	-17.02	Notes 2, 3 and 4
>806	-16.02	-16.02	Notes 1 and 4

- Note 1 Due to 2x2 MIMO operation, limit is -16.02dBm (-13dBm – 10log(2)) per FCC KDB 662911D01 v02r01.
- Note 2 For 5MHz channel BW mode: $76+10\log(P)-10\log(5\text{MHz}/6.25\text{kHz}) = 47+10\log(P)$ per FCC KDB 971168 D02 Misc OOB License Digital Systems v01
- For 10MHz channel BW mode: $76+10\log(P)-10\log(10\text{MHz}/6.25\text{kHz}) = 44+10\log(P)$ per FCC KDB 971168 D02 Misc OOB License Digital Systems v01
- Note 3 In addition, limit is reduced by 10log(2) per FCC KDB 662911D01 v02r01 due to 2x2 MIMO operation.
- Note 4 For simplicity a more conservative limit has been used in the entire 756MHz to 806MHz frequency range
- 806MHz cutoff frequency has been used to show compliance with RSS-130 Issue 1 Section 4.6

In 5MHz channel bandwidth mode, low and high channels as well as dual carrier mode (low channel + high channel) configurations were tested. In 10MHz channel bandwidth mode, unit can only operate in single carrier mode at the center channel.

Results summary:

	LTE - QPSK		LTE - 16QAM		LTE - 64QAM	
	Low	High	Low	High	Low	High
5M	-27.88	-28.05	-28.11	-27.84	-27.86	-28.16
10M	-24.14	-24.84	-24.05	-24.44	-25.1	-23.59
5M Dual	-24.78	-24.67	-30.1	-30.9	-30.61	-30.41

All corresponding plots are included on the following pages.

Measurements performed in RMS average mode with 100kHz RBW and 300kHz VBW over 100 traces. In 100kHz bands immediately outside and adjacent to the frequency block, resolution bandwidth has been reduced to 30kHz as allowed in §27.53(c).

Total path loss of 40.4dB accounted in via reference level offset to the spectrum analyzer.

Plots for 718MHz – 728MHz band (Port 3):

5M – LTE – QPSK – Low

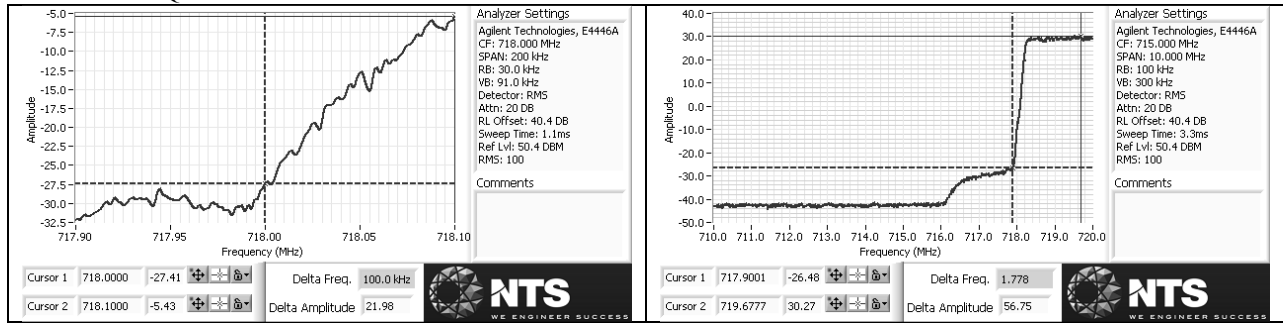

5M – LTE – 16QAM – Low

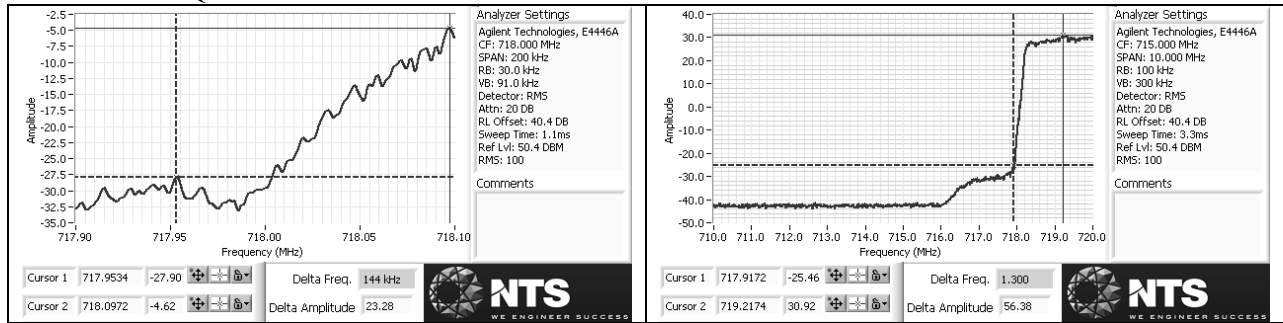

5M – LTE – 64QAM – Low

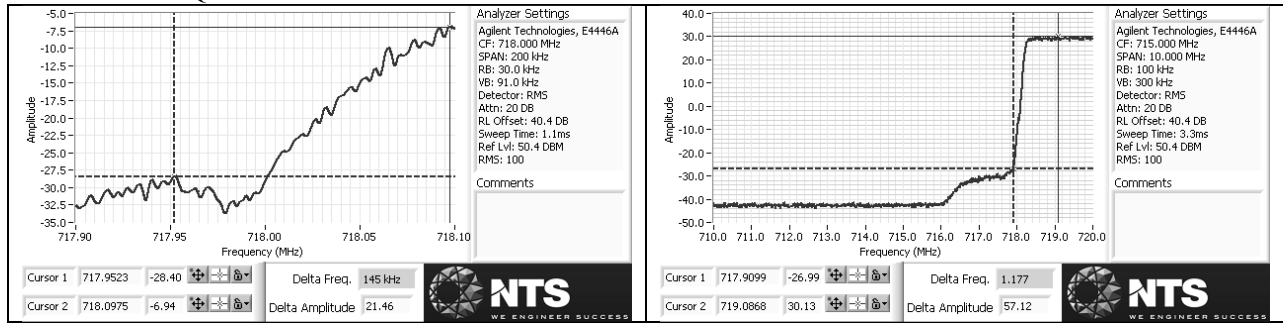

5M - LTE - QPSK - High

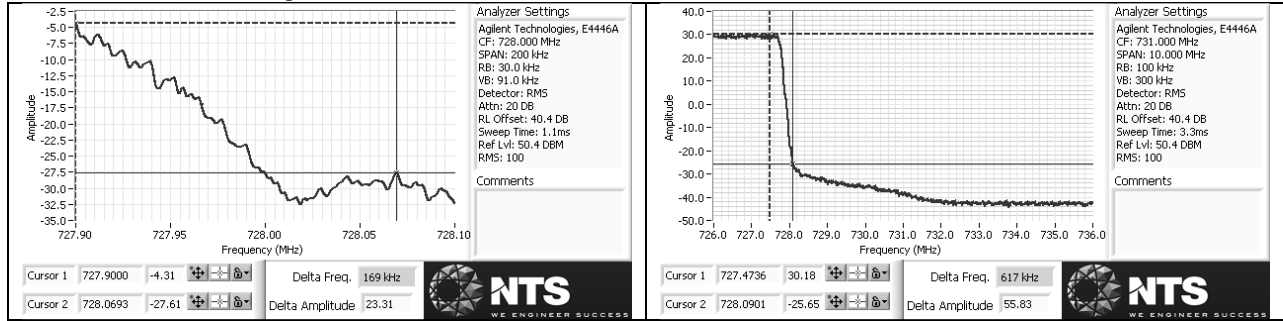

5M - LTE - 16QAM - High

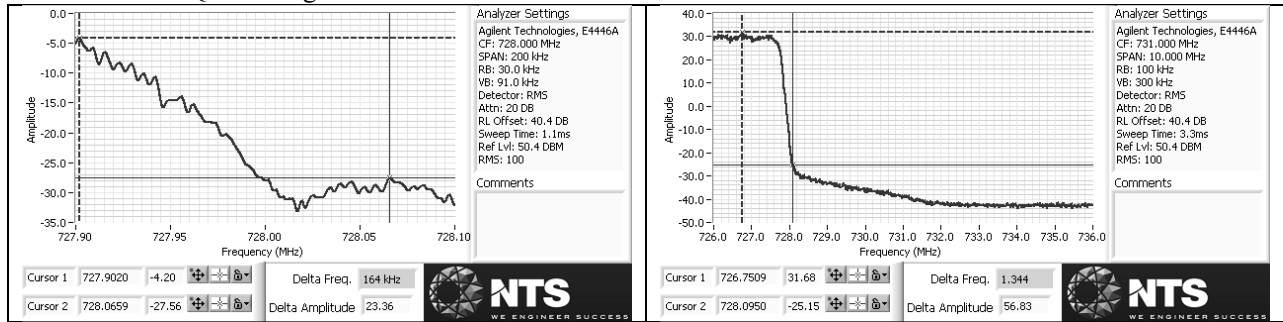

5M - LTE - 64QAM - High

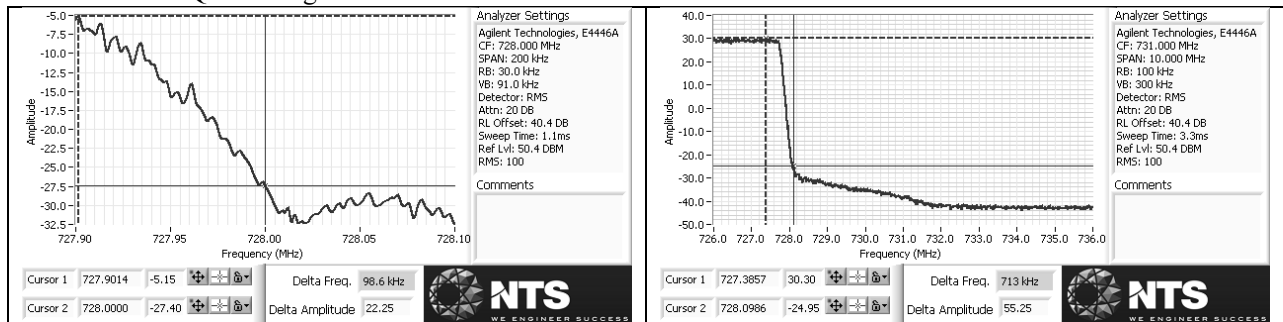

5M Dual Carrier - LTE - QPSK - Low

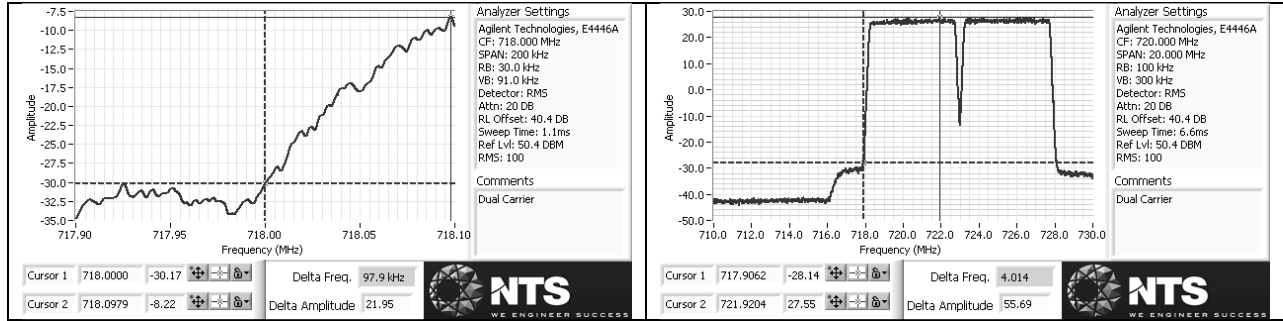

5M Dual Carrier - LTE - 16QAM - Low

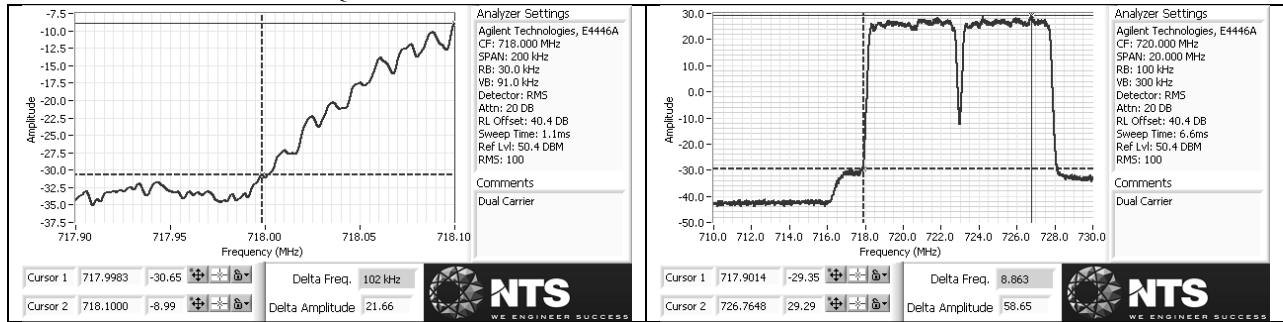

5M Dual Carrier - LTE - 64QAM - Low

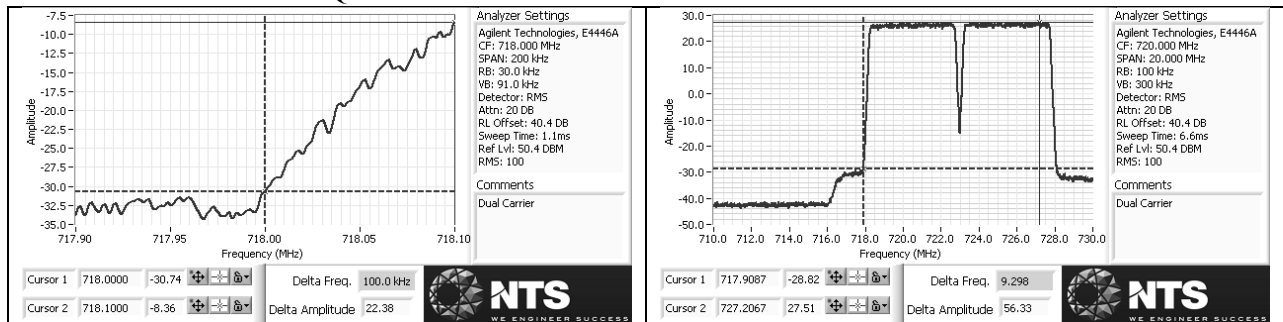

5M Dual Carrier – LTE – QPSK – High

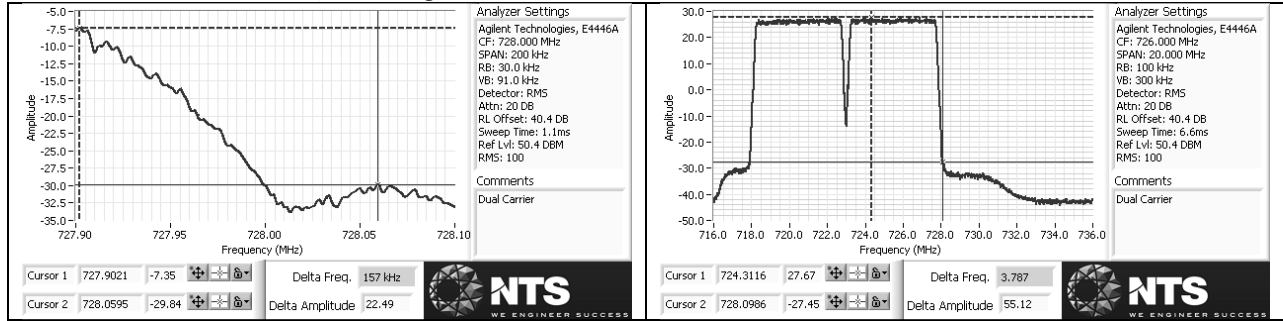

5M Dual Carrier – LTE – 16QAM – High

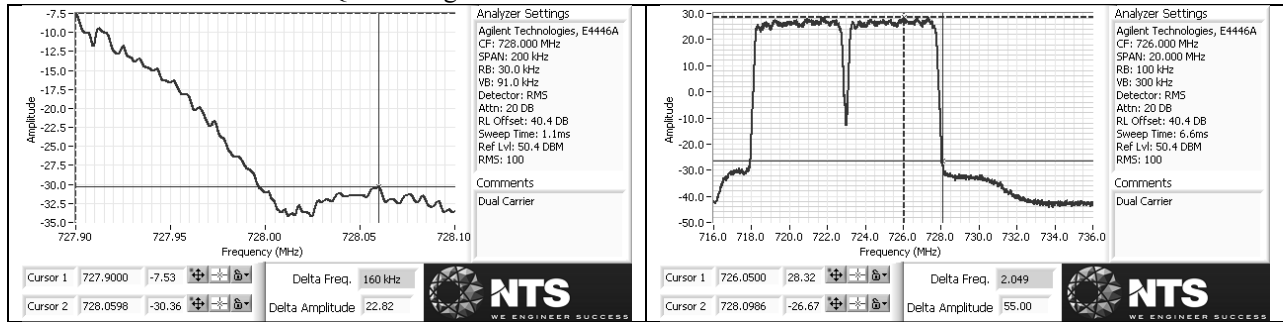

5M Dual Carrier – LTE – 64QAM – High

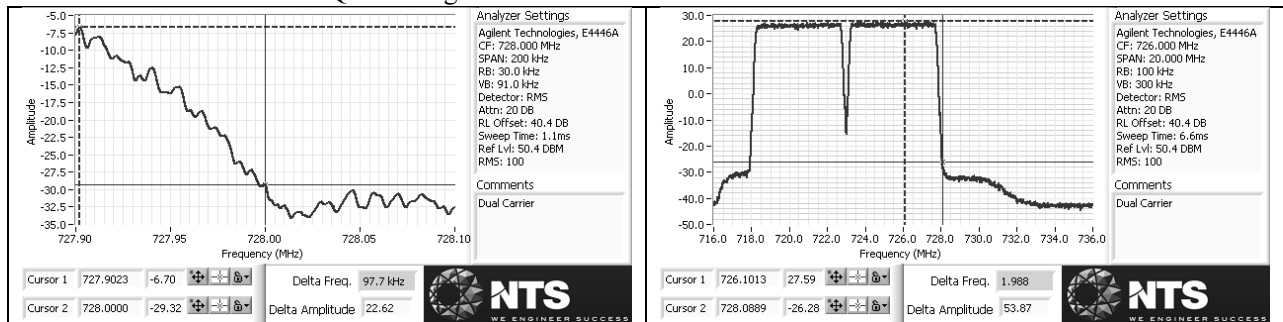

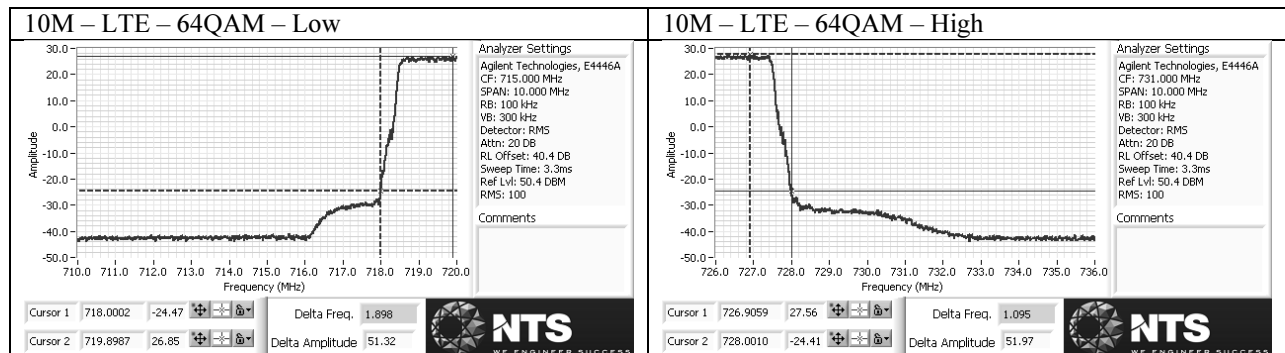
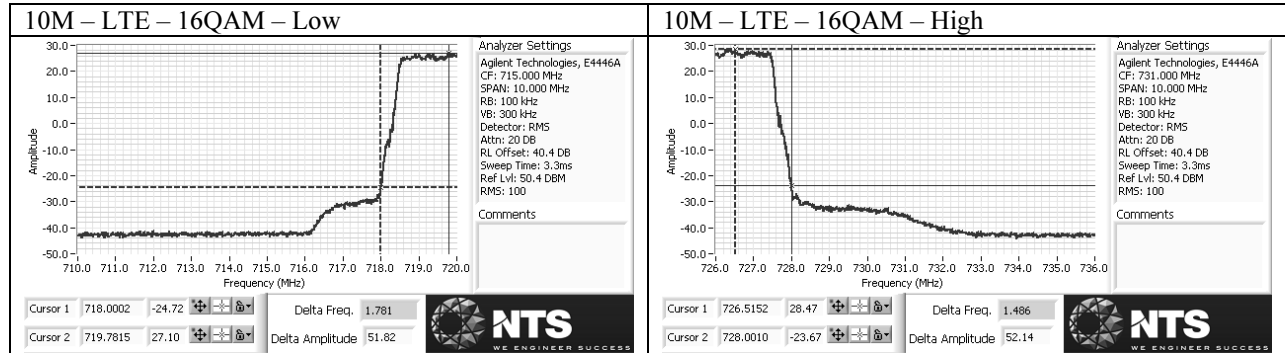
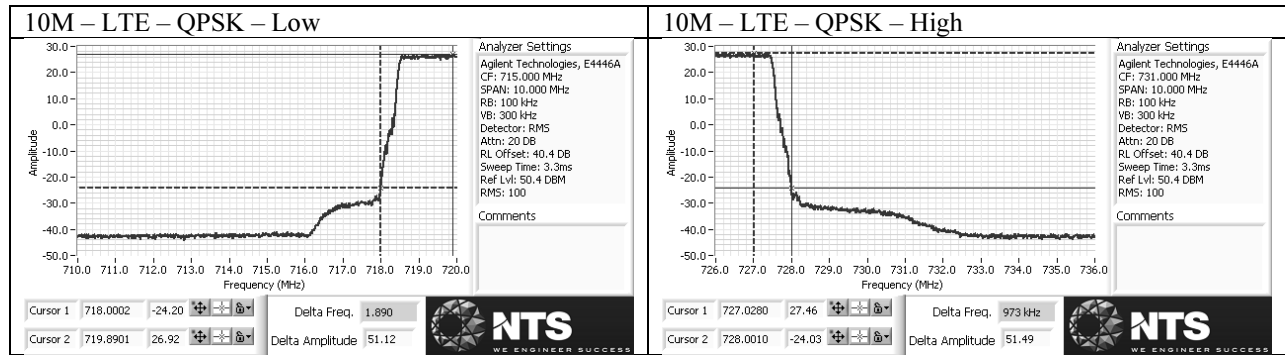

Plots for 746MHz – 756MHz band (Port 2):

5M – LTE – QPSK – Low

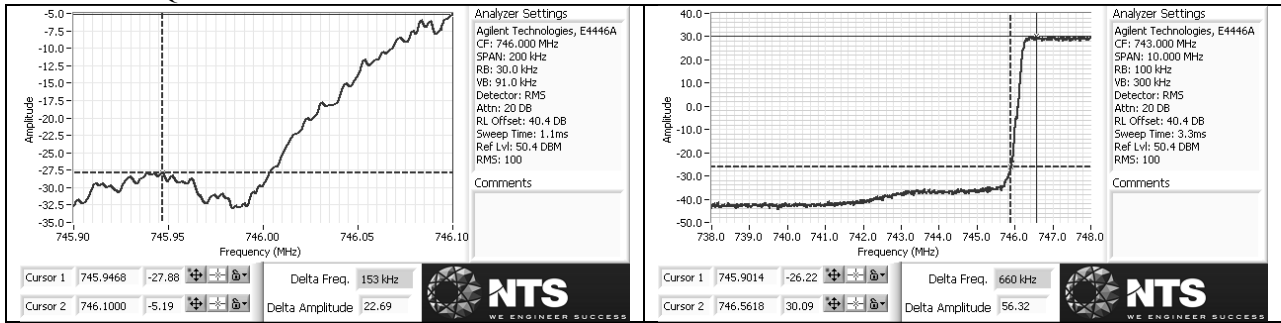

5M – LTE – 16QAM – Low

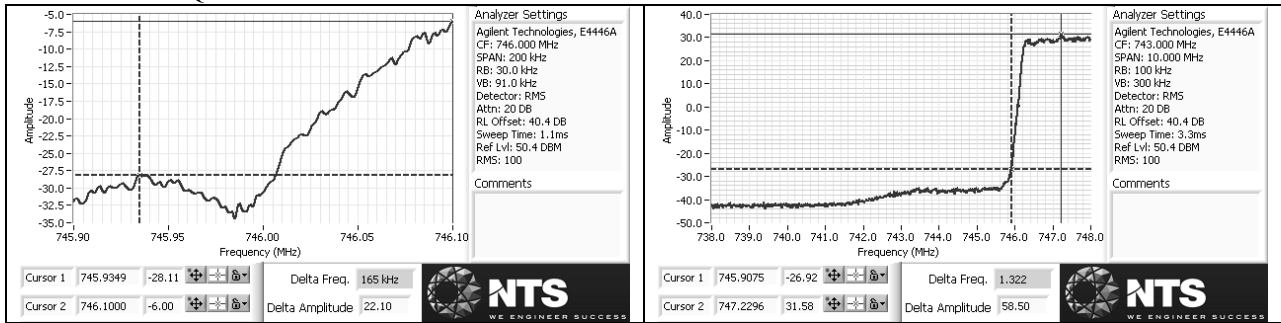

5M – LTE – 64QAM – Low

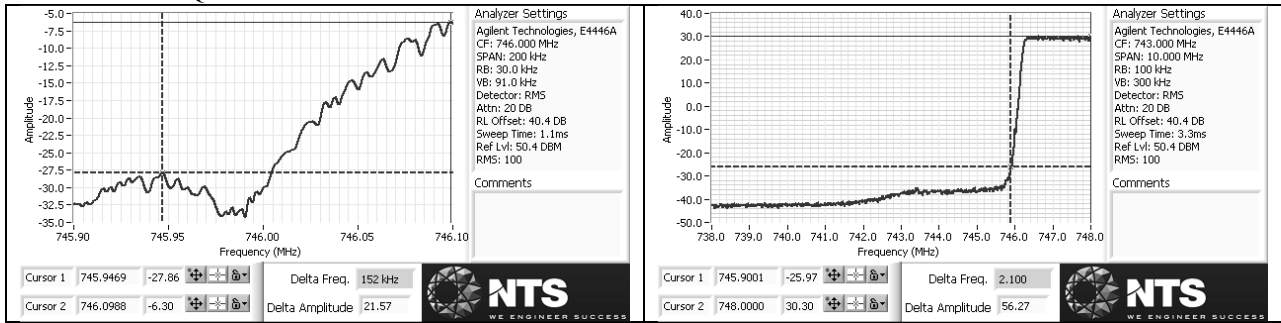

5M - LTE - QPSK - High

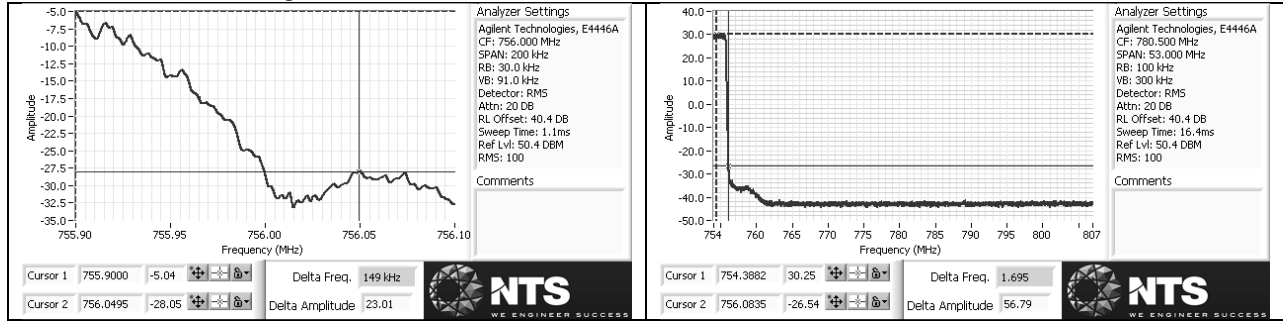

5M - LTE - 16QAM - High

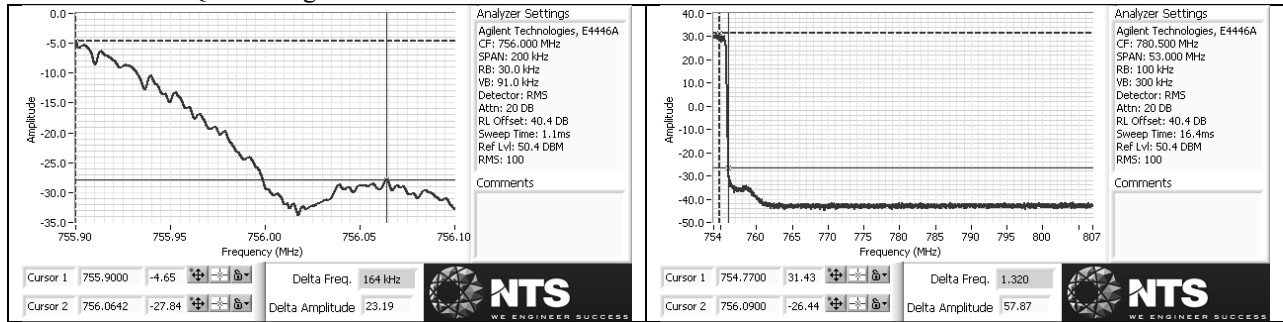

5M - LTE - 64QAM - High

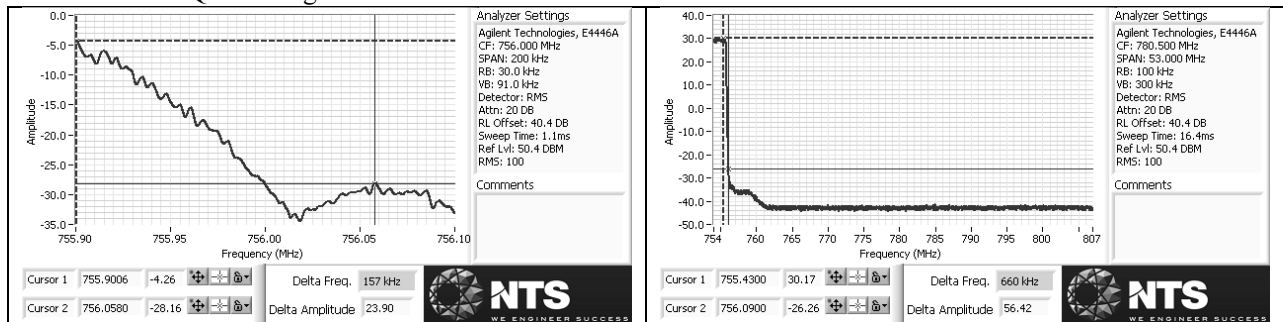

5M Dual Carrier - LTE - QPSK - Low

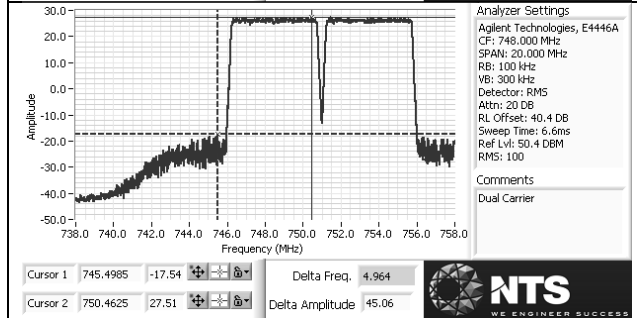
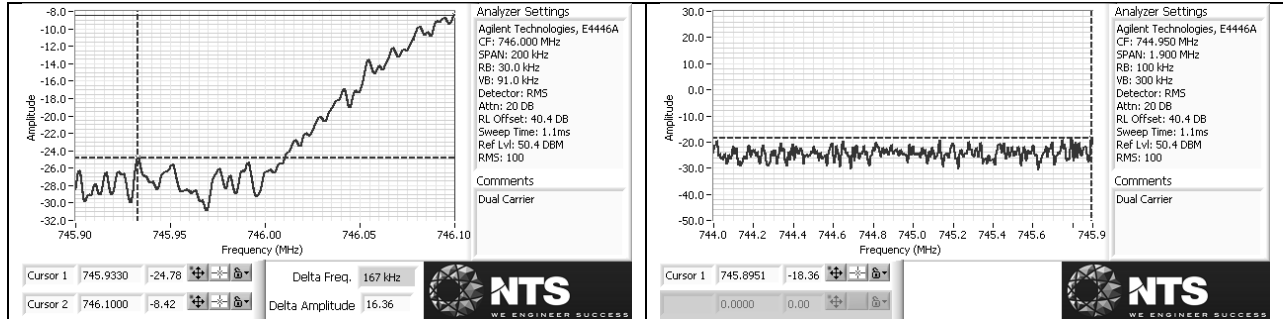

5M Dual Carrier - LTE - 16QAM - Low

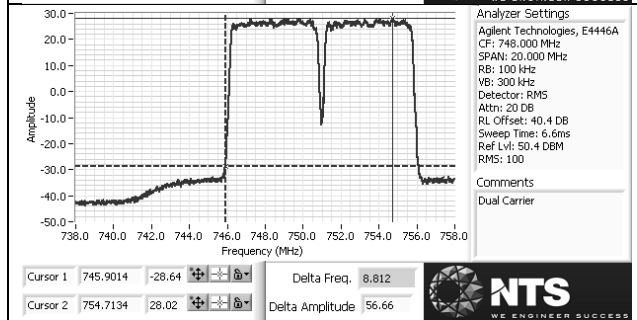
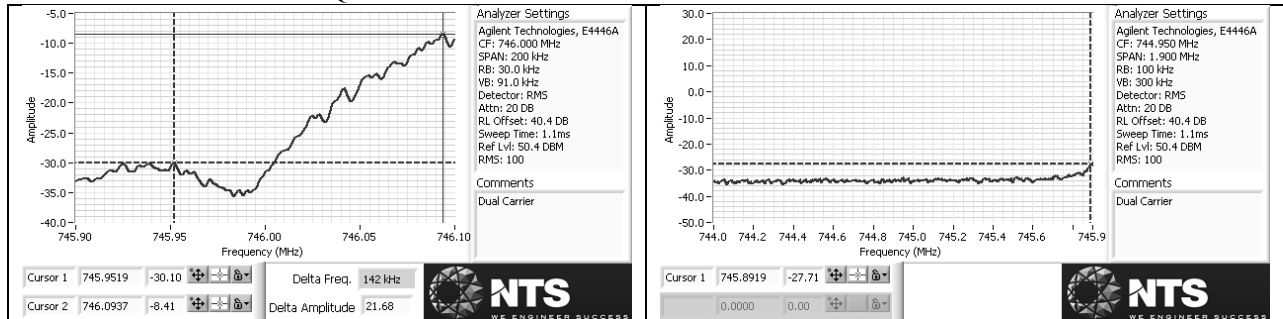

5M Dual Carrier - LTE - 64QAM - Low

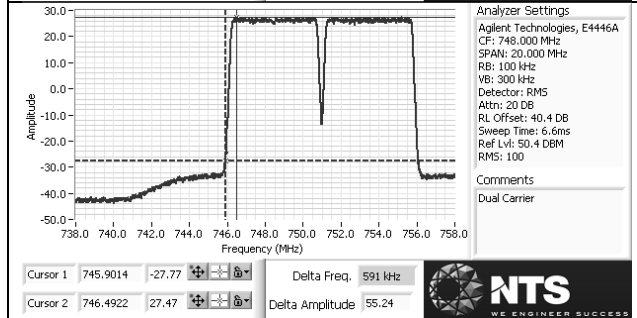
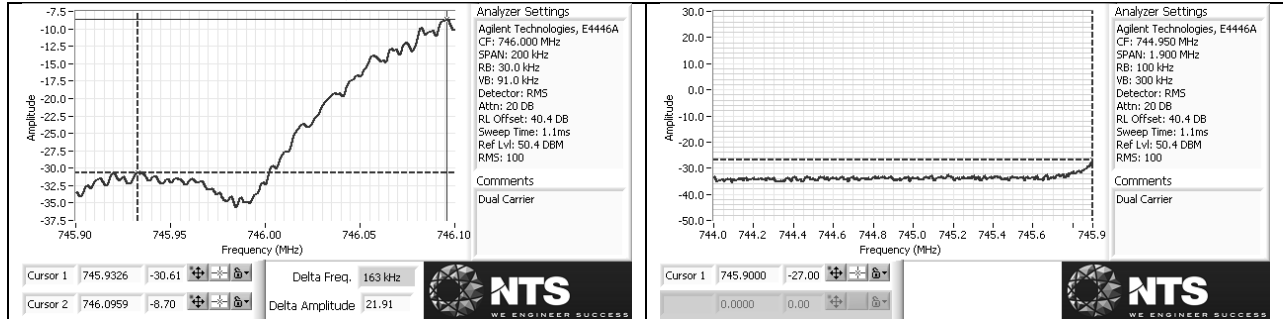

5M Dual Carrier - LTE - QPSK - High

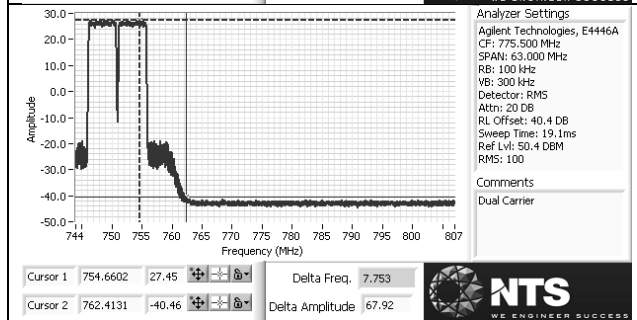
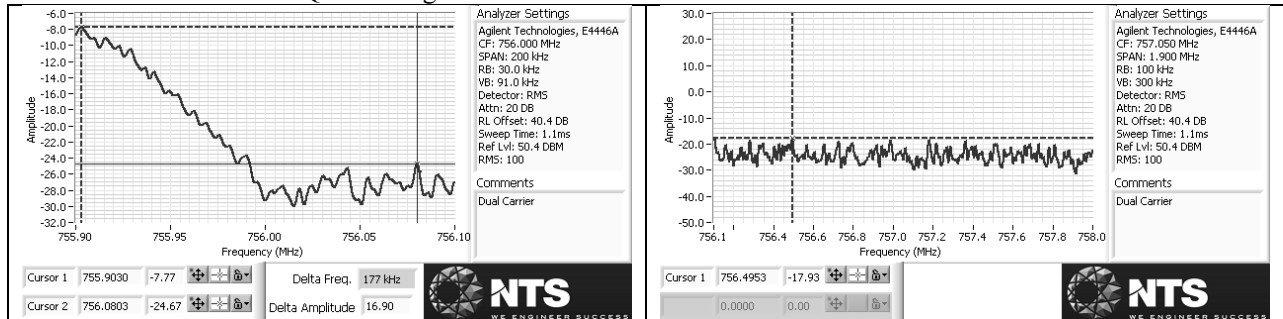

5M Dual Carrier - LTE - 16QAM - High

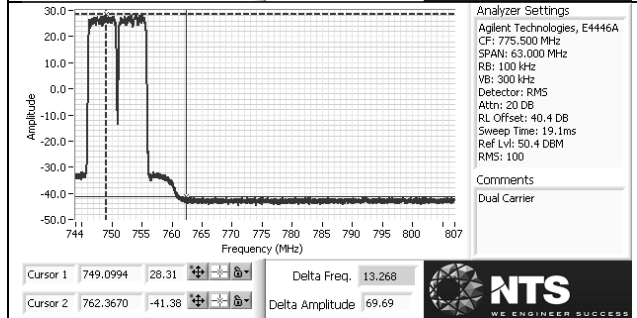
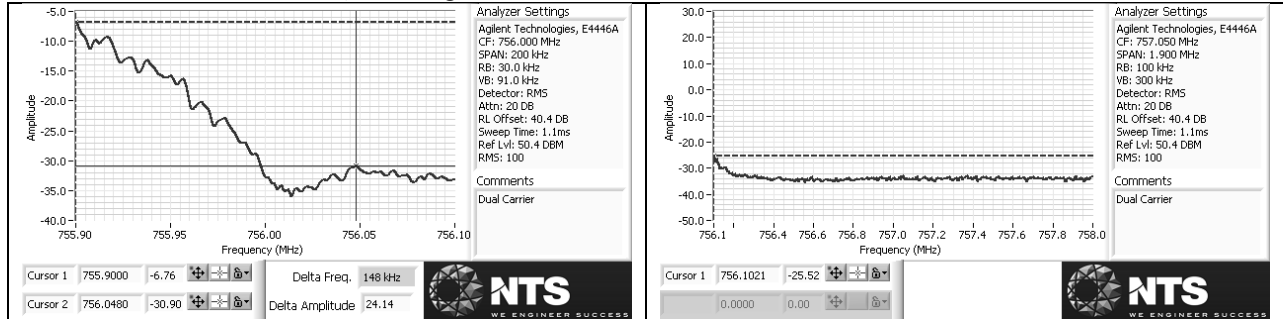

5M Dual Carrier - LTE - 64QAM - High

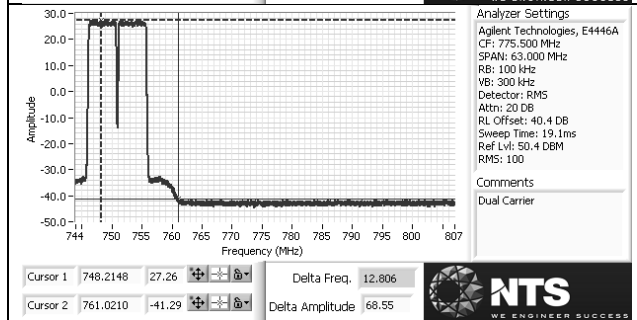
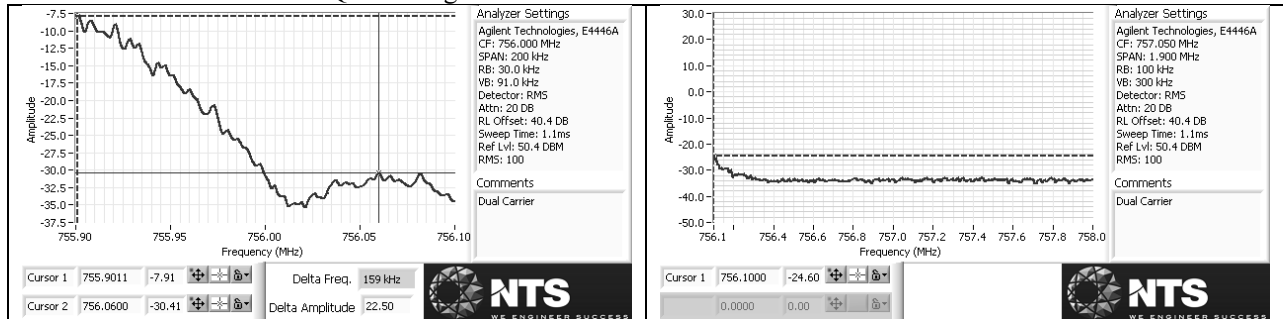

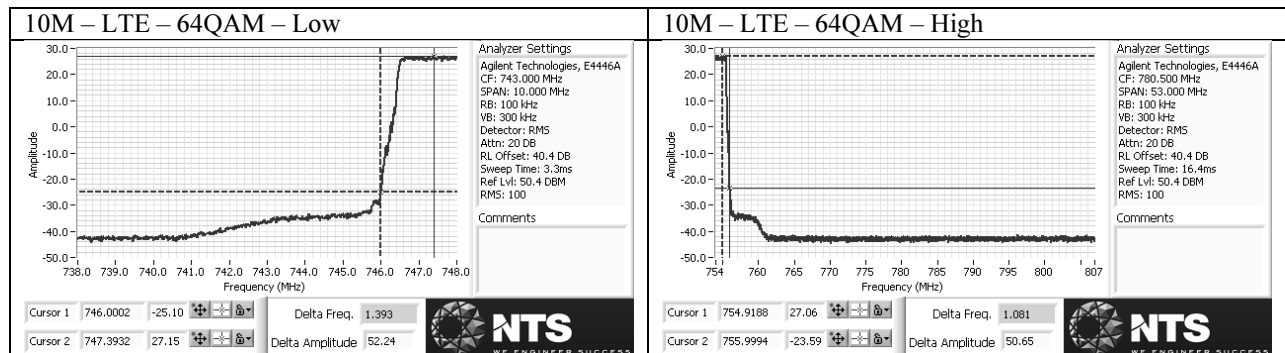
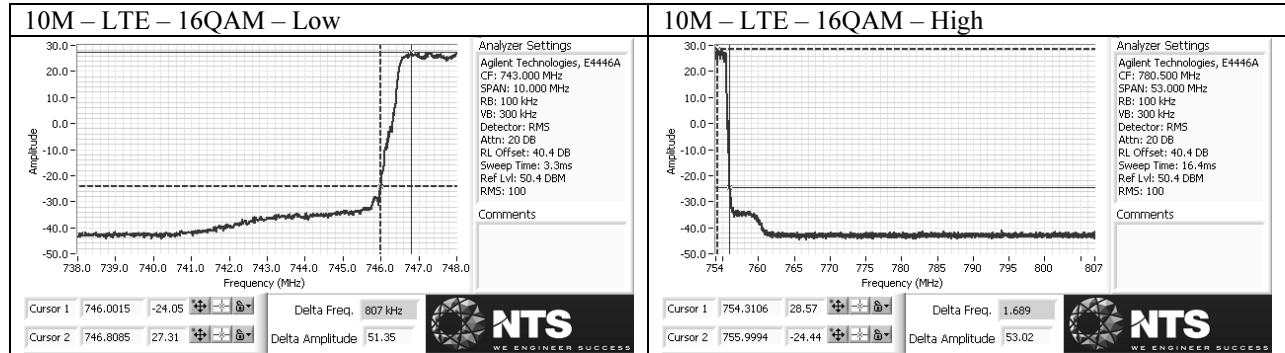
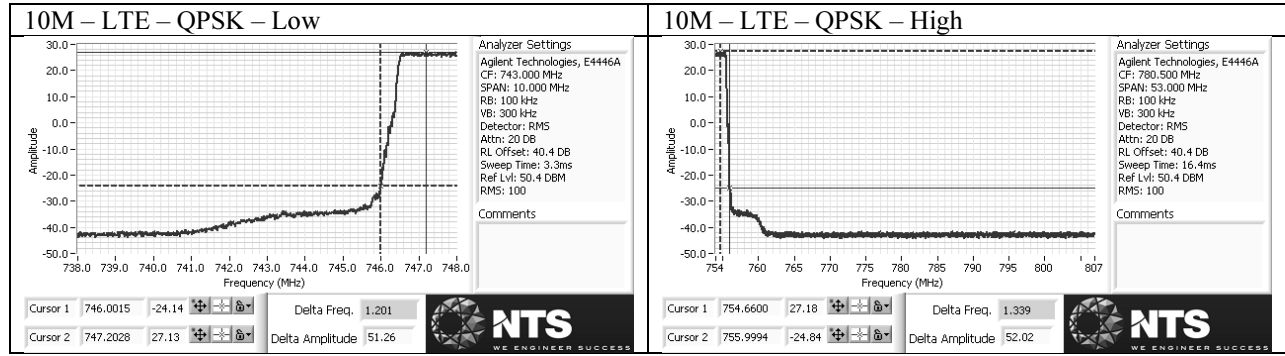

Transmitter Antenna Port Conducted Spurious Emissions

Tests performed on both frequency bands at center channel for all modulations and bandwidth modes. Due to 2x2 MIMO operation, limit is -16.02dBm (-13dBm – 10*log(2)) per FCC KDB 662911D01 v02r01.

TILE6 measurement software was used during testing with the following settings:

Frequency Range	RBW	VBW	Number of data points	Divided into	Detector	Sweep Time	Max hold over
9kHz-150kHz	1kHz	3kHz	8000	1 segment	Peak	Auto	50 sweeps
150kHz-8GHz	100kHz	300kHz	8000	12 segments	Peak	Auto	50 sweeps

Corresponding plots are included on the following pages.

Plots for 718MHz – 728MHz band (Port 3):

5M – LTE – QPSK

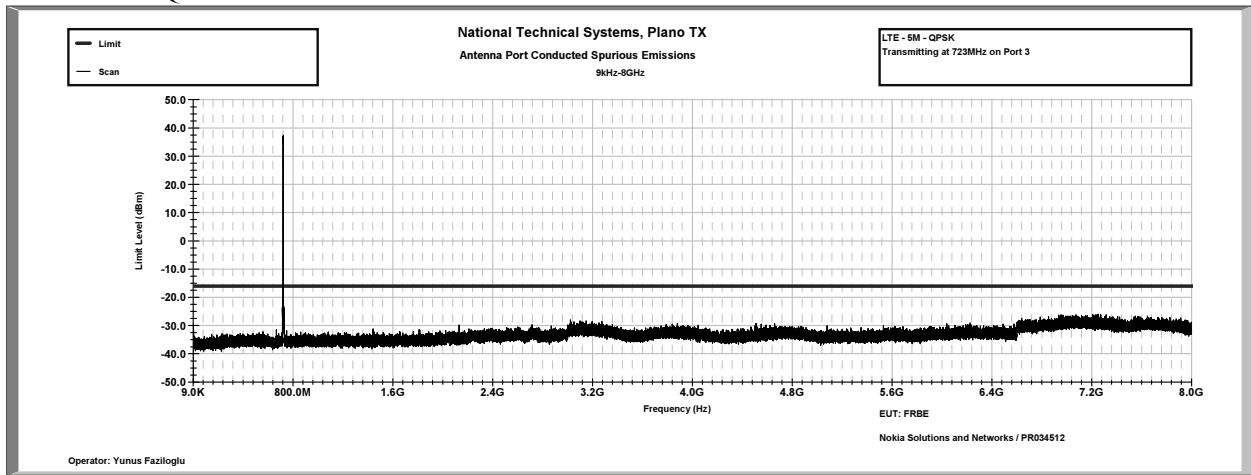

5M – LTE – 16QAM

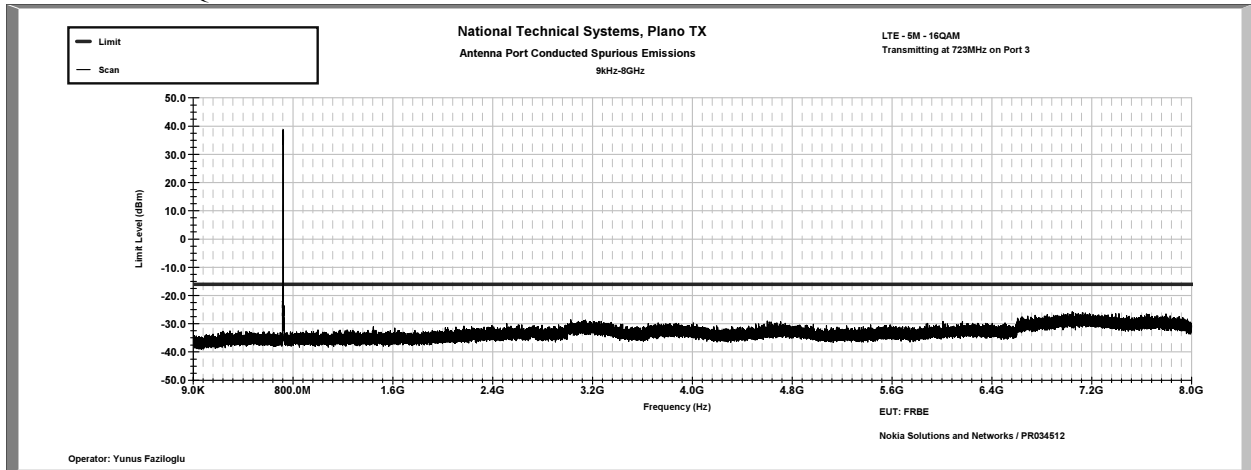

5M – LTE – 64QAM

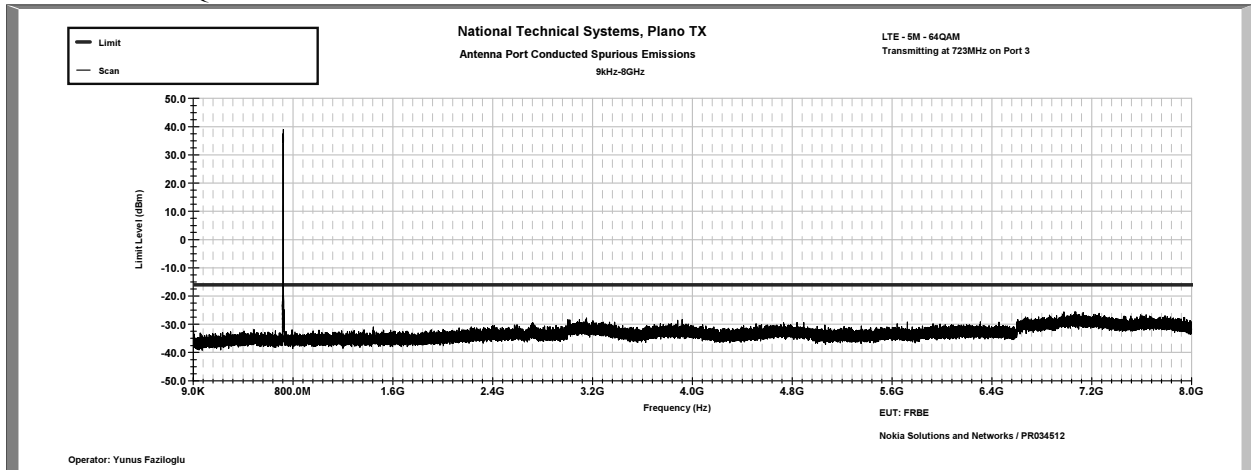

10M - LTE - QPSK

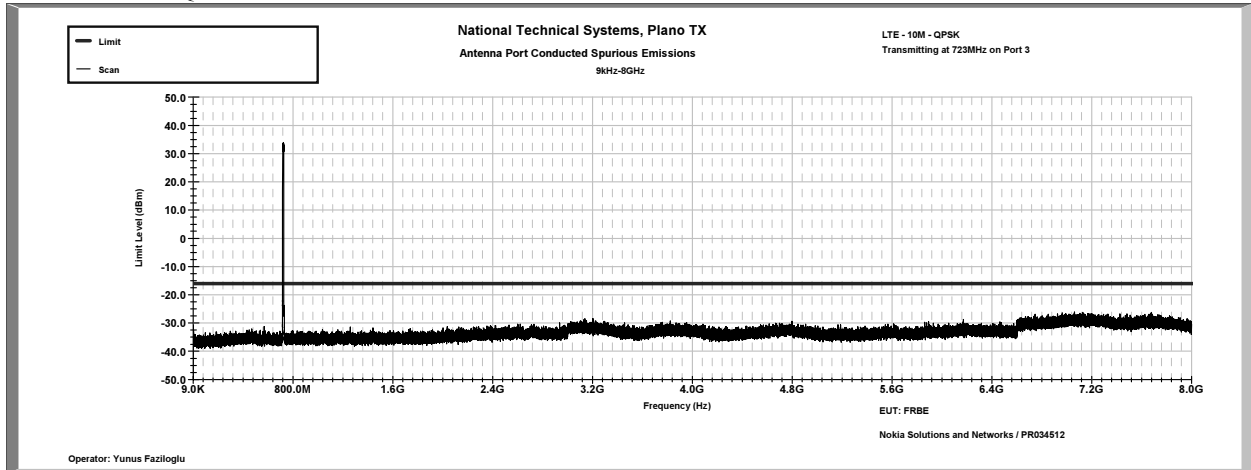

10M - LTE - 16QAM

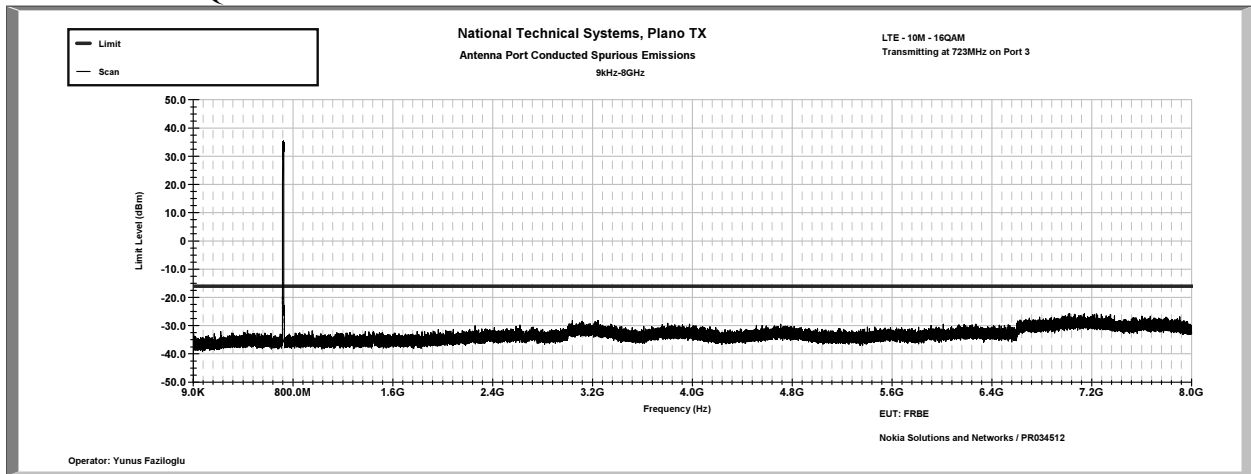

10M - LTE - 64QAM

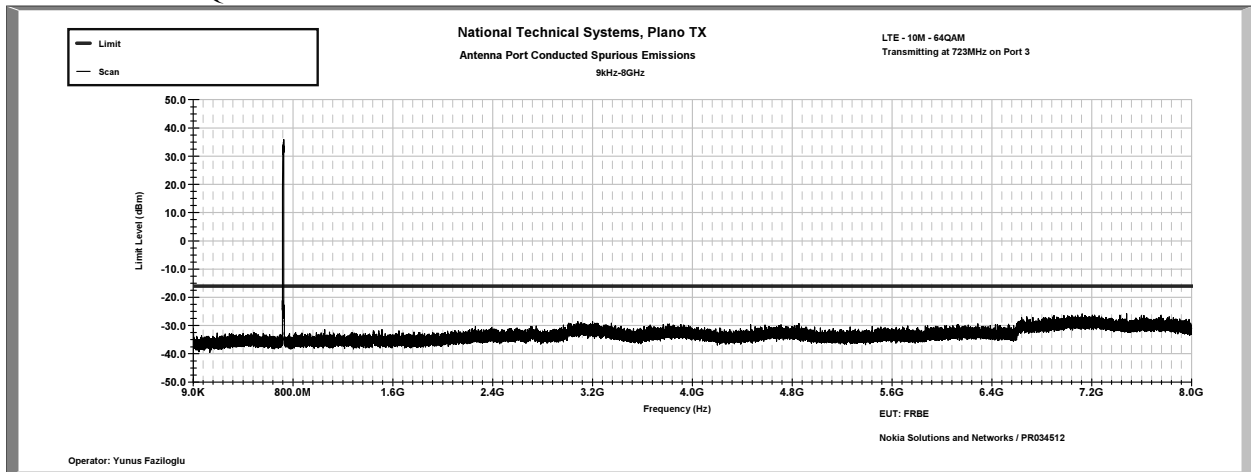

27.53(e):

This section is informational only for 718MHz - 728MHz band (Port 3)

Limit: -40dBm/MHz EIRP for wideband emissions, -50dBm/MHz EIRP for discrete emissions

Results summary:

	LTE-QPSK			LTE-16QAM			LTE-64QAM		
	Low	Center	High	Low	Center	High	Low	Center	High
5M	-49.21	-49.11	-49.12	-49.2	-49.13	-49.03	-49.07	-49.15	-49.28
10M	-49.17			-49.16			-49.23		
5M Dual	-49.08			-49.02			-49.06		

Measurements performed conducted at the antenna port in RMS average mode with 1MHz RBW and 3MHz VBW over 100 traces. All readings were at the instrumentation noise floor.

In order to reduce the measurement instrumentation noise floor a 1GHz high pass filter has been used to block the fundamental. Total path loss of 42.2dB accounted in via reference level offset to the spectrum analyzer.

All corresponding plots are included on the following pages.

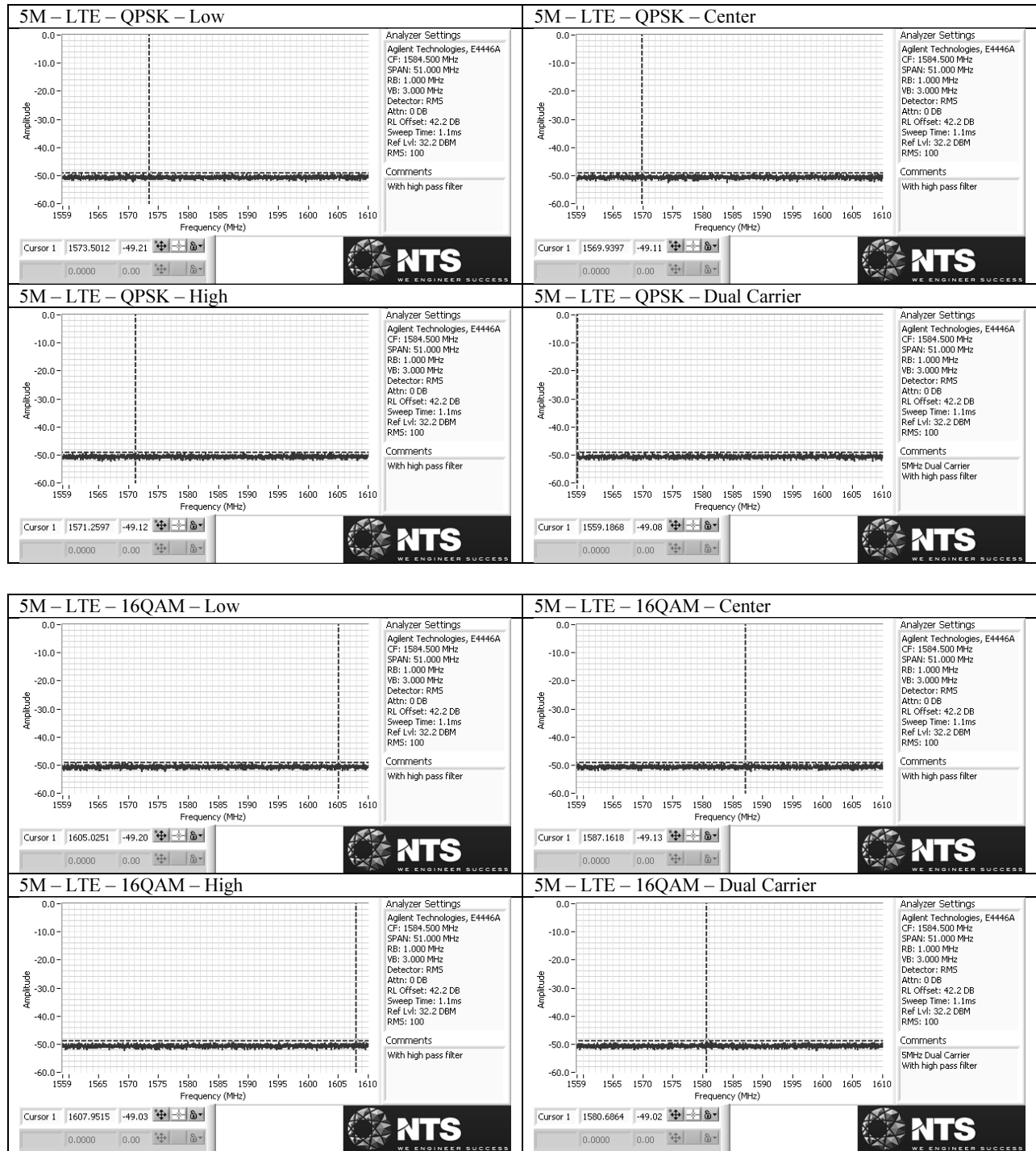

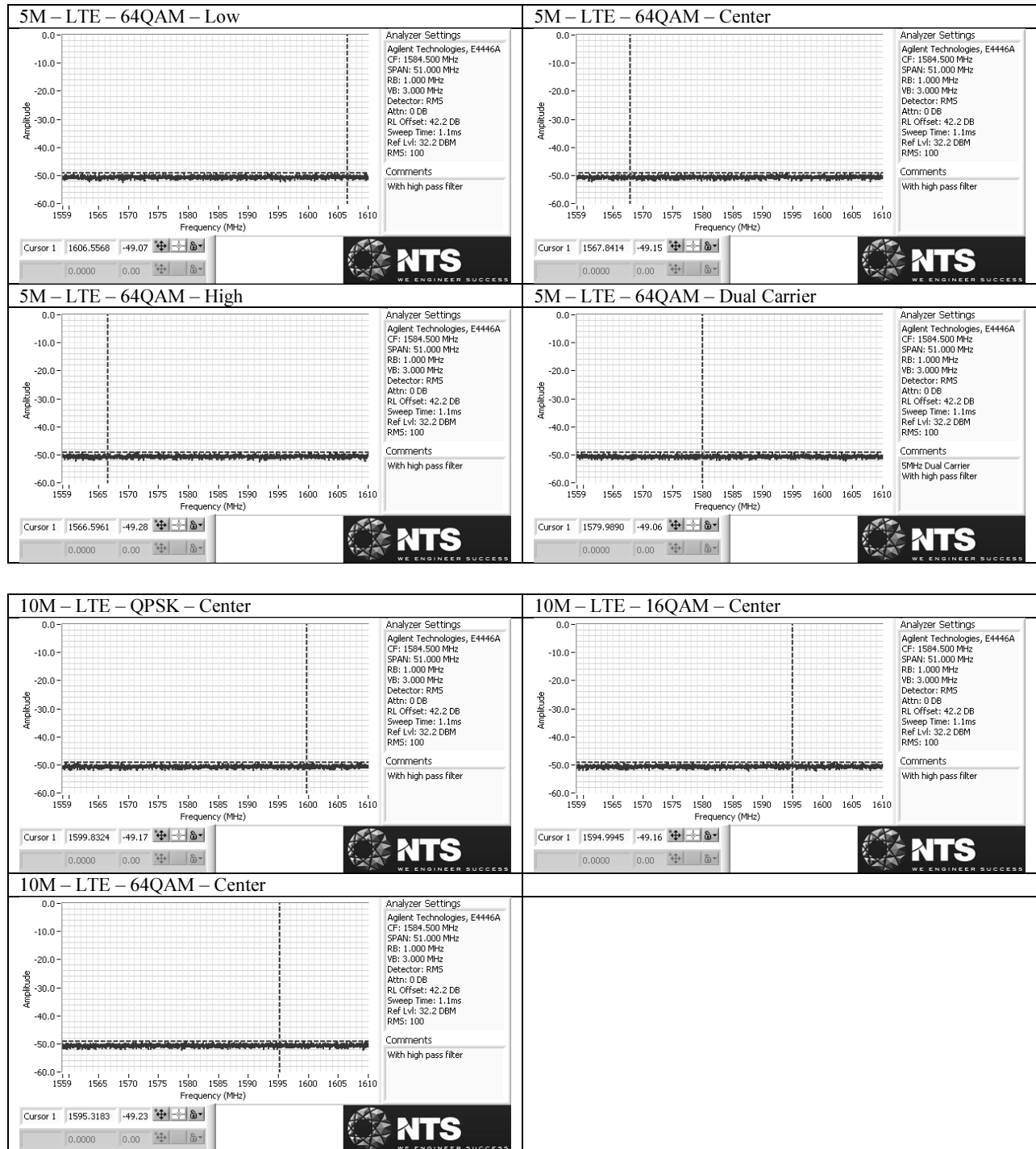

Plots for 746MHz – 756MHz band (Port 2):

5M – LTE – QPSK

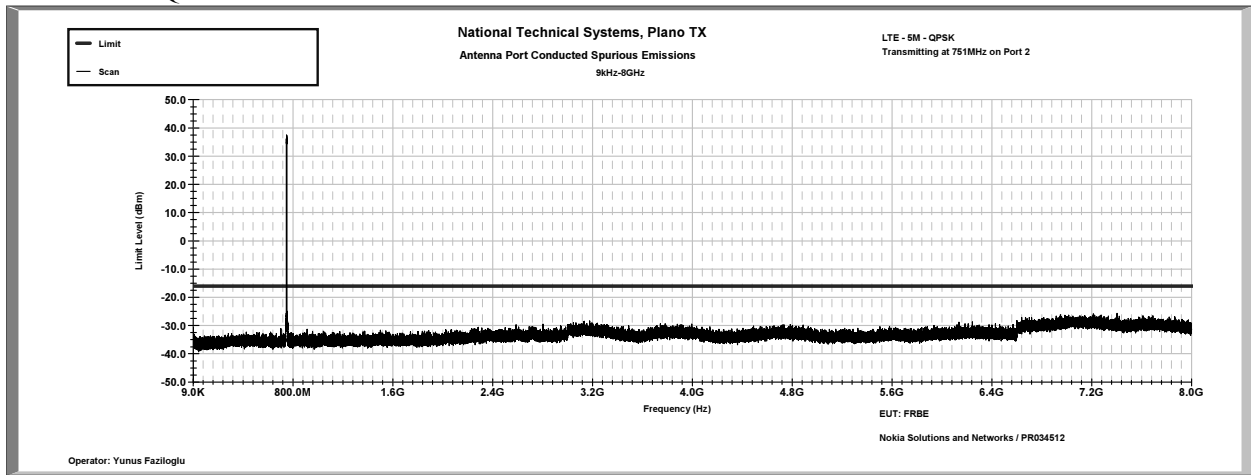

5M – LTE – 16QAM

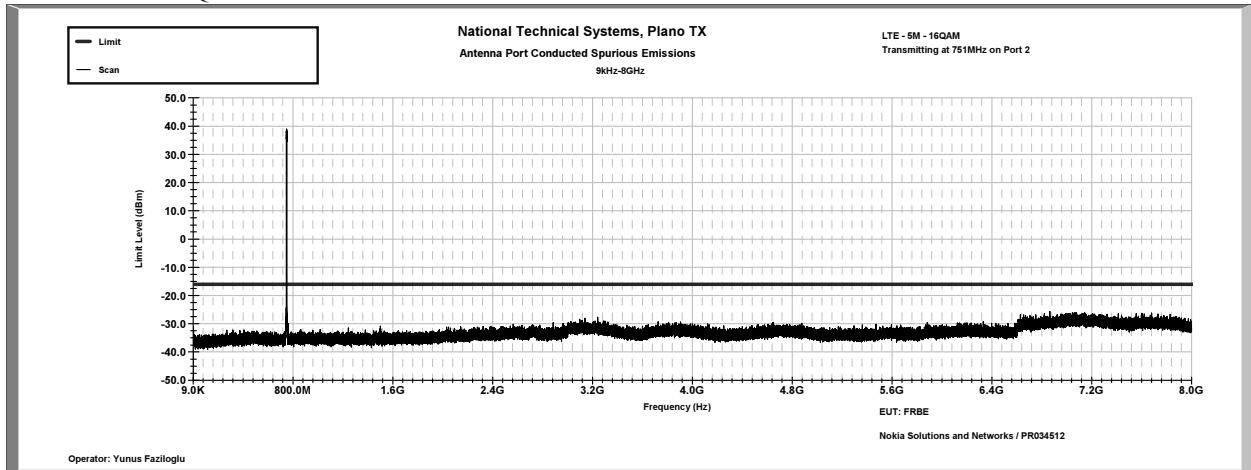

5M – LTE – 64QAM

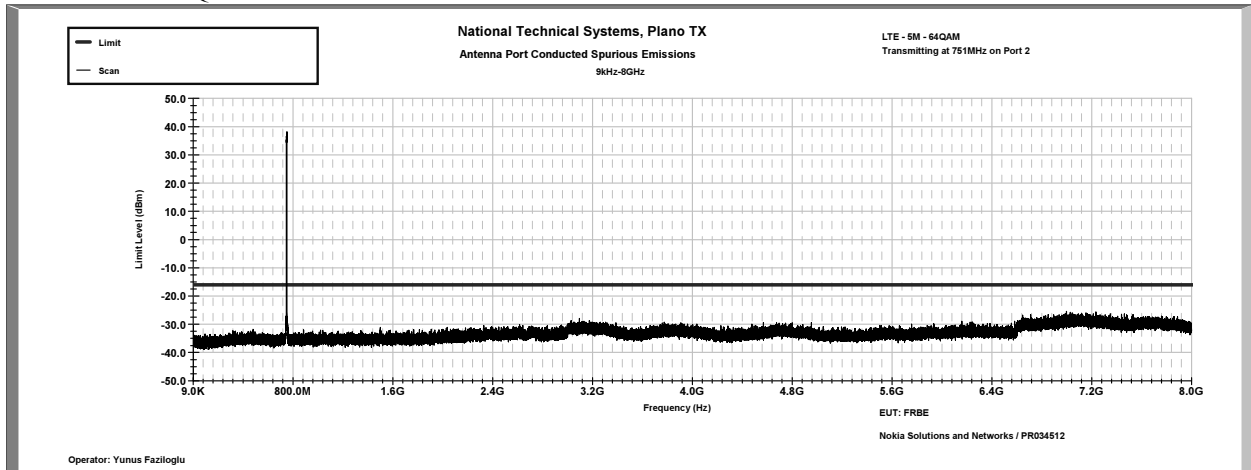

10M - LTE - QPSK

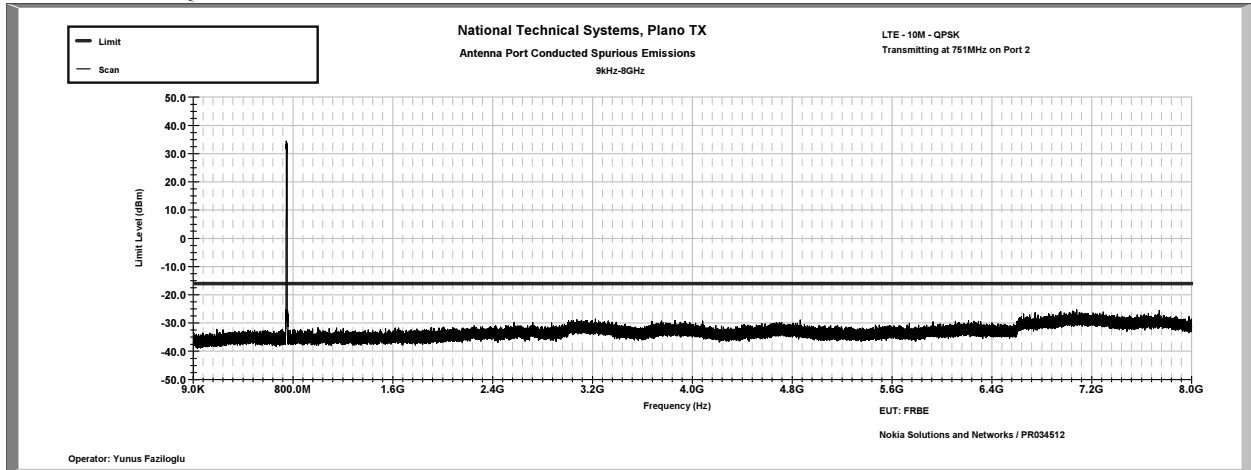

10M - LTE - 16QAM

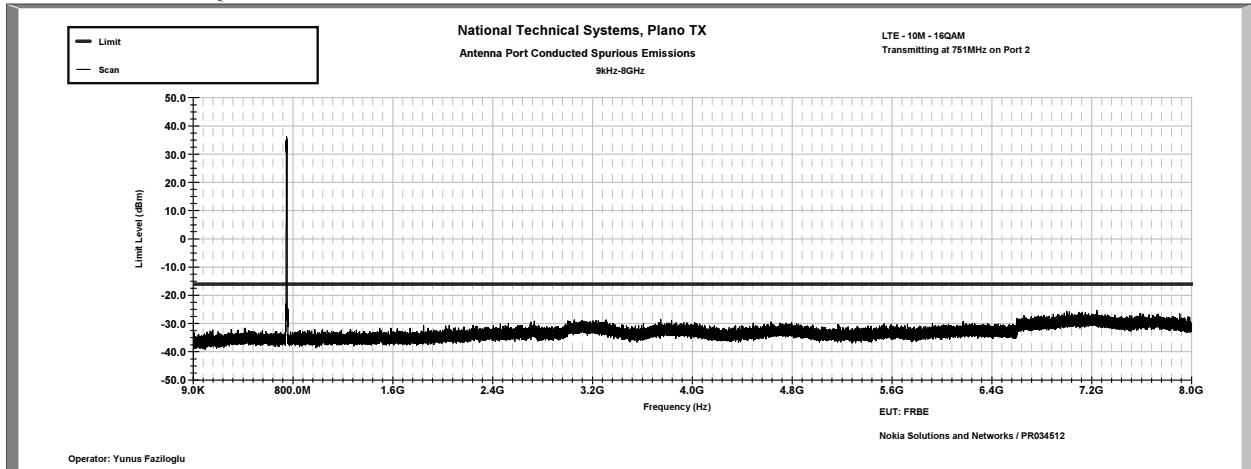

10M - LTE - 64QAM

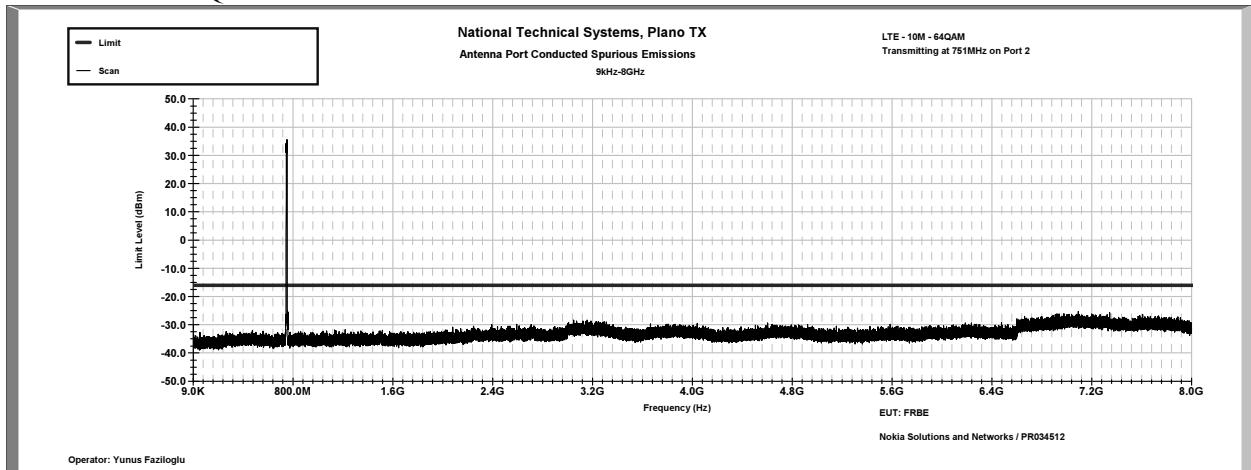

27.53(e):

For 746MHz - 756MHz band (Port 2)

Limit: -40dBm/MHz EIRP for wideband emissions, -50dBm/MHz EIRP for discrete emissions

Results summary:

	LTE-QPSK			LTE-16QAM			LTE-64QAM		
	Low	Center	High	Low	Center	High	Low	Center	High
5M	-49.06	-49.16	-49.13	-49.15	-49.07	-49.11	-49.16	-49.13	-49.1
10M	-49.13			-49.05			-49.22		
5M Dual	-49.27			-49.03			-49.01		

Measurements performed conducted at the antenna port in RMS average mode with 1MHz RBW and 3MHz VBW over 100 traces. All readings were at the instrumentation noise floor.

In order to reduce the measurement instrumentation noise floor a 1GHz high pass filter has been used to block the fundamental. Total path loss of 42.2dB accounted in via reference level offset to the spectrum analyzer.

All corresponding plots are included on the following pages.

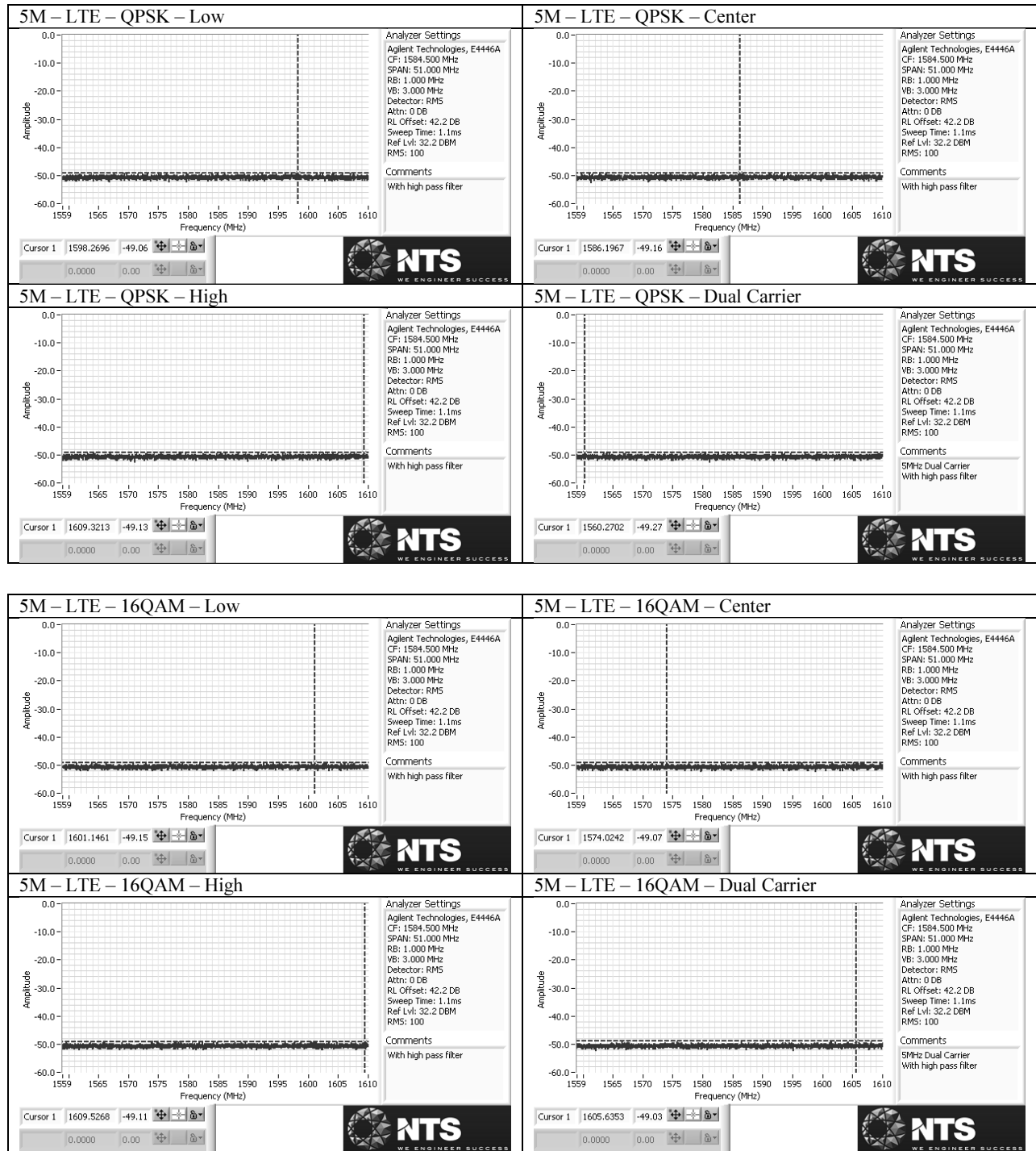

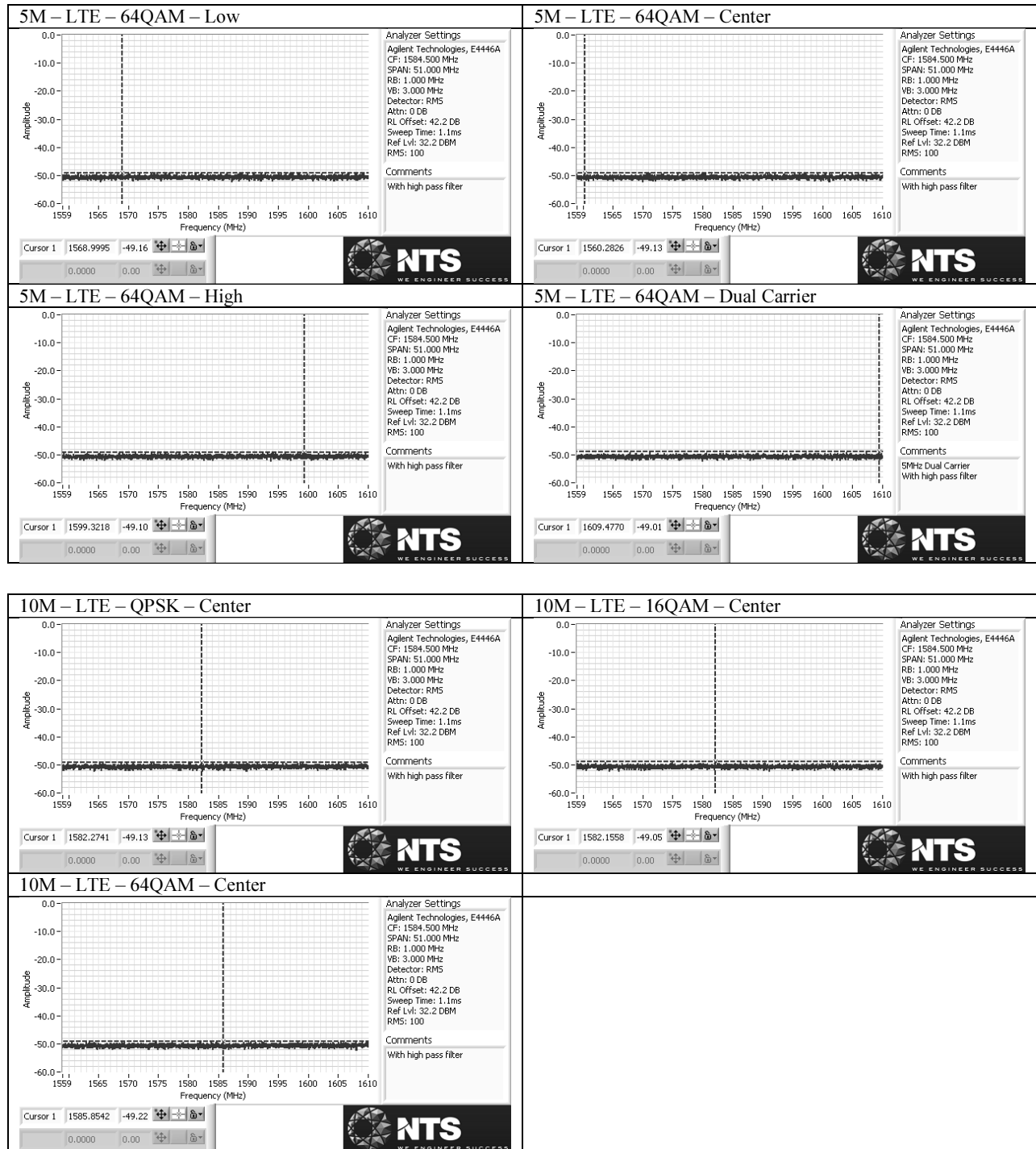

Transmitter Radiated Spurious Emissions

Antenna port conducted spurious emissions tests produced similar results for all modulations and channel bandwidth modes. Preliminary scans for radiated spurious emissions were performed in 30MHz – 8GHz frequency range in the following configuration:

- Transmitting in 5MHz-16QAM-LTE mode at center channel (751MHz) on ports 1 and 2.
- Transmitting in 5MHz-64QAM-LTE mode at center channel (723MHz) on ports 3 and 4.

Final maximized peak radiated emissions were measured in these modes. During testing all 4 antenna ports of the base station were terminated with 50ohm termination blocks and unit was transmitting on all of its ports at full power as described above.

Frequency (MHz)	Polarity (H/V)	Raw Reading at 3m (dBuV)	Amplifier Gain (dB)	Antenna Factor (dB/m)	Cable Loss (dB)	Corrected Field Strength at 3m (dBuV/m)	Limit at 3m (dBuV/m)	Margin (dB)
921.6	V	50.6	-40.2	24.6	2.9	37.9	82.2	-44.3
921.6	H	46.5	-40.2	24.6	2.9	33.8	82.2	-48.4
1000	V	44.9	-39.8	25.6	3.2	33.9	82.2	-48.3
1000	H	44.6	-39.8	25.6	3.2	33.6	82.2	-48.6
1502	V	60.1	-49.2	25.4	2.5	38.8	82.2	-43.4
1502	H	56.3	-49.2	25.4	2.5	35	82.2	-47.2
2457.6	V	53.6	-48.2	28.4	3.1	36.9	82.2	-45.3
2457.6	H	50.2	-48.2	28.4	3.1	33.5	82.2	-48.7
7.371 (NF)	V	42.7	-45.2	36.6	5.6	39.7	82.2	-42.5
7.371 (NF)	H	42.1	-45.2	36.6	5.6	39.1	82.2	-43.1
Corrected Field Strength = Raw Reading + Amplifier Gain + Antenna Factor + Cable Loss								
Negative margin indicates a passing result.								
Detector: Peak, RBW=100kHz, VBW=300kHz, Max-hold								
NF: Noise Floor								

Highest noise floor of the measurement instrumentation was more than 20dB below the 82.2dBuV/m at 3m limit (equivalent to -13dBm EIRP).

Since all maximized readings were more than 20dB below the 82.2dBuV/m at 3m limit (equivalent to -13dBm EIRP), substitution measurements were not performed.

TILE software was used for all prescans and plots included on the following pages. The limit shown on the plots is 20dB below the 82.2dBuV/m at 3m limit.

30MHz – 1GHz Peak Prescan at 3m - H

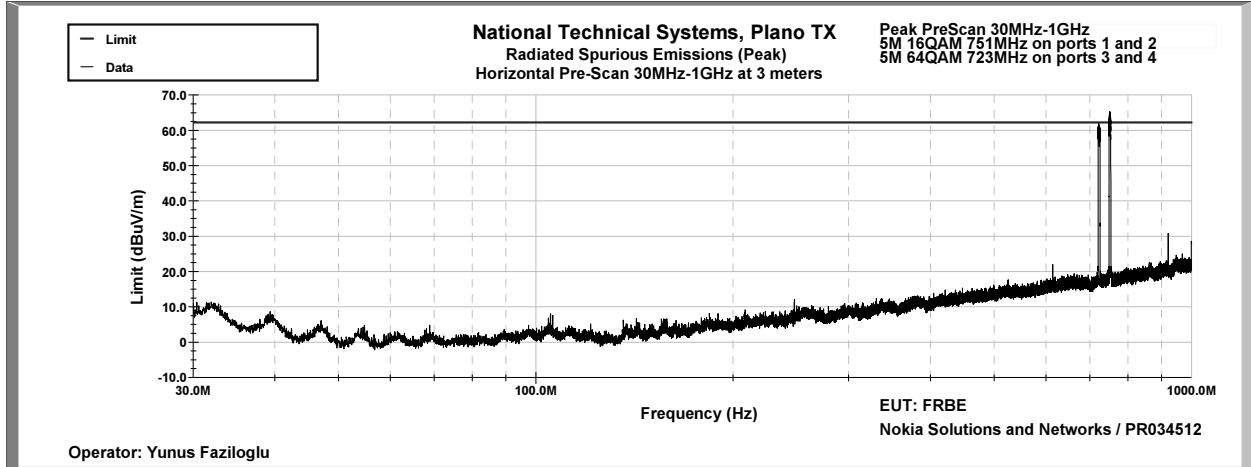

30MHz – 1GHz Peak Prescan at 3m - V

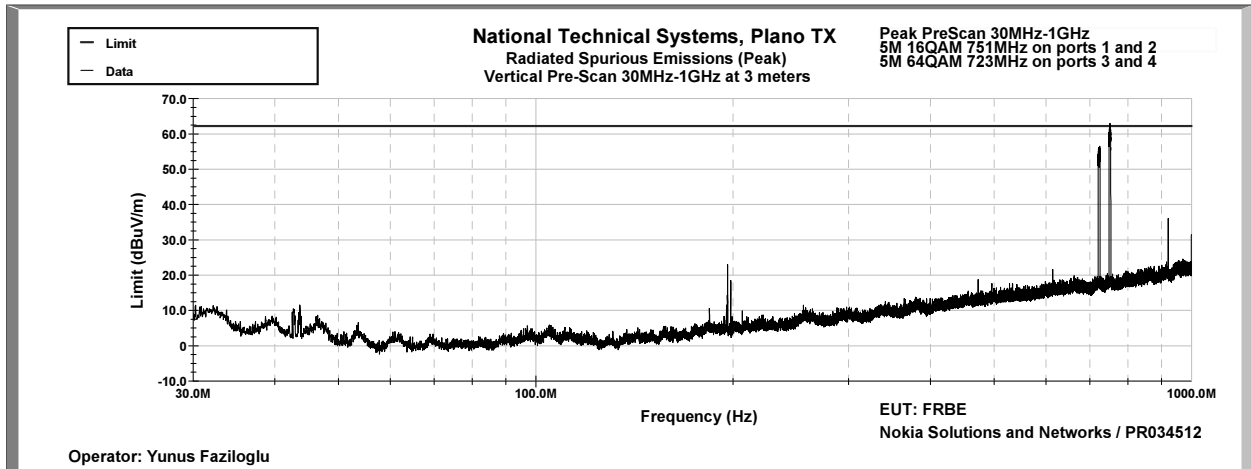

1GHz – 8GHz Peak Prescan at 3m – H

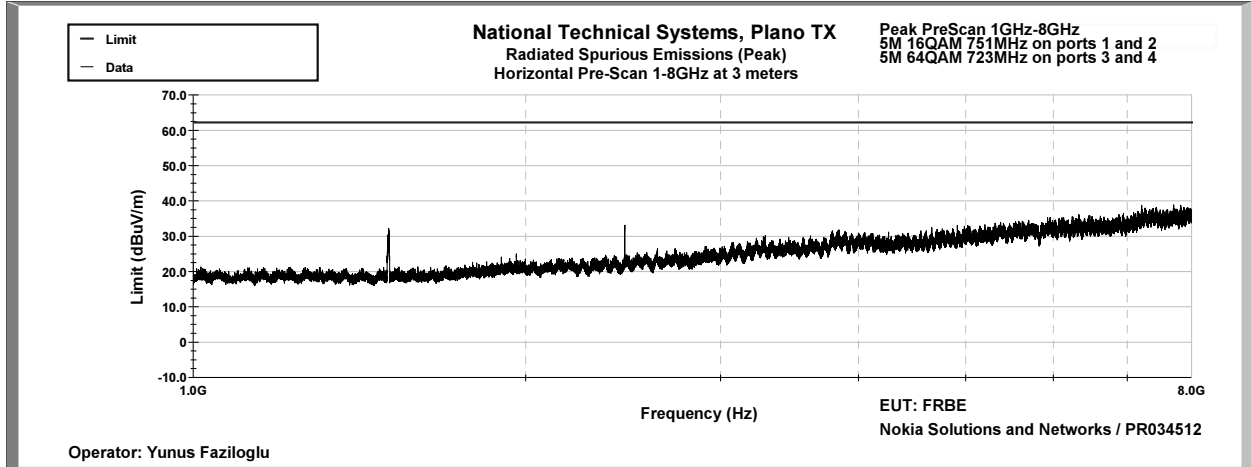

1GHz – 8GHz Peak Prescan at 3m – V

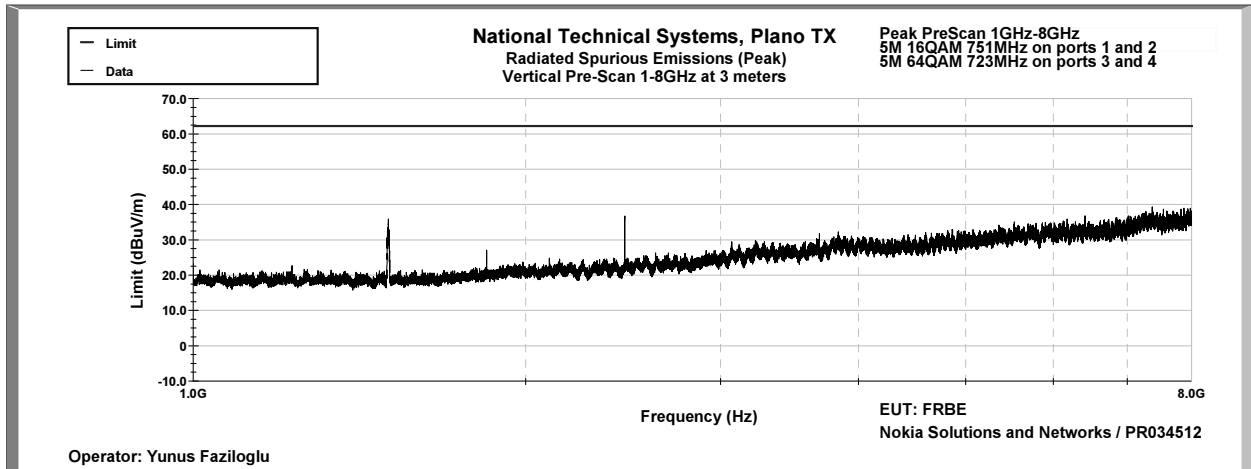

Frequency Stability

In order to demonstrate carrier frequency stability at extreme temperatures and voltages, frequency error was measured in the following configuration:

Transmitting in 10MHz-64QAM-LTE mode at center channel (751MHz) on port 2.
Transmitting in 10MHz-64QAM-LTE mode at center channel (723MHz) on port 3.

Nominal operating voltage of the product is declared as 48VDC.

Frequency error results are listed below for extreme voltages and temperatures.

Extreme Voltages

	723MHz	751MHz
20C	Freq. Error (mHz)	Freq. Error (mHz)
40.8VDC	451	494
55.2VDC	435	393

Extreme Temperatures

	723MHz	751MHz
48VDC	Freq. Error (mHz)	Freq. Error (mHz)
-30	259	308
-20	325	403
-10	271	264
0	267	184
10	238	306
20	278	387
30	412	426
40	256	518
50	362	403

Based on the results above, highest recorded frequency error is equivalent to 0.0007ppm, which ensures that the transmitted signal remains in its authorized frequency block at extreme voltages and temperatures.

Results above are deemed sufficient to demonstrate carrier frequency stability for all other channel bandwidth modes and modulations since all carriers are controlled by the same frequency stabilization circuitry that was subjected to the extreme conditions under this test.

End of Report

This page is intentionally blank and marks the last page of this test report.