

## RF exposure compliance assessment

Nokia AirScale Multiband Remote Radio Head Solution – AHLOB

---

Author	Katarzyna Stopa, Kamil Bechta
Owner	Christophe Grangeat
Organization	MN RAN Arch
Approver	Jaimeen Kamdar
Document Type	Final test report
Document ID	LPITPN2I4Q5L-1109616211-3461
Document location	<a href="https://nokia.sharepoint.com/:f:/r/sites/EMFProductManagement/Shared%20Documents/General/Products-RF-exposure-assessment/AHLOB?csf=1&amp;web=1&amp;e=4bgDVG">https://nokia.sharepoint.com/:f:/r/sites/EMFProductManagement/Shared%20Documents/General/Products-RF-exposure-assessment/AHLOB?csf=1&amp;web=1&amp;e=4bgDVG</a>

---

### Change History

Version	Status	Date	Author	Owner	Reviewed by	Reviewed date	Approver	Approval date	Description of changes
1.0	Final	01-07-2022	K. Stopa, K. Bechta	C. Grangeat	C. Grangeat, S. Mitchell	06-07-2022	J. Kamdar	14-07-2022	

This material, including documentation and any related computer programs, is protected by copyright controlled by Nokia. All rights are reserved. Copying, including reproducing, storing, adapting or translating, any or all of this material requires the prior written consent of Nokia. This material also contains confidential information, which may not be disclosed to others without the prior written consent of Nokia.

## Contents

1	General content.....	5
2	References.....	5
2.1	Applicable RF exposure standards and regulations .....	5
2.2	Product and assessment method.....	6
3	RF exposure limits .....	6
4	Description of the equipment under test (EUT) .....	7
5	RF exposure assessment method.....	10
6	RF exposure computation results.....	11
6.1	Regions of application: US/related .....	11
6.2	Regions of application: EU/ICNIRP and Australia/NZ.....	13
6.3	Regions of application: Canada .....	16
7	Conclusion and installation recommendations.....	18

## List of Tables

Table 1 – Applicable RF exposure levels in B71 and B85 bands expressed in power density .....	6
Table 2 – AHLOB and Commscope FF-65C-R1 general technical characteristics.....	7
Table 3 - Reference system used in this report (from NGMN white paper [14]) .....	8
Table 4 – Antenna beam pattern models for band B71 used for EMF evaluation .....	9
Table 5 – Antenna gain characteristics for band B71 used during EMF evaluation.....	10
Table 6 - Validation of the antenna model for band B71 .....	11
Table 7 – AHLOB RF exposure compliance distances based on the time-averaged maximum transmitted power of 452 W for US/related .....	18
Table 8 – AHLOB RF exposure compliance distances based on the time-averaged maximum transmitted power of 452 W for EU/ICNIRP and Australia/NZ.....	19
Table 9 - AHLOB RF exposure compliance distances based on the time-averaged maximum transmitted power of 452 W for Canada .....	19
Table 10 – AHLOB RF exposure compliance distances based on actual maximum transmitted power of 180 W for US/related.....	20

Table 11 – AHLOB RF exposure compliance distances based on actual maximum transmitted power of 180 W for EU/ICNIRP and Australia/NZ .....20

Table 12 – AHLOB RF exposure compliance distances based on actual maximum transmitted power of 180 W for Canada .....21

## List of Figures

Figure 1 – Shape of the compliance boundary used for the RF exposure compliance assessment (from [4])..... 10

Figure 2 – Top view of the power density for the time-averaged maximum transmitted power of 452 W in band B71 (corresponding to the time-averaged maximum EIRP of 72.25 dBm in the boresight direction) and the beam oriented in azimuth = 0° & elevation = +8.0° (US/related).... 12

Figure 3 - Top view of the power density for the actual maximum transmitted power of 180 W in band B71 (corresponding to the actual EIRP threshold of 68.25 dBm) and the beam oriented in azimuth = 0° & elevation = +8° (US/related)..... 12

Figure 4 – Side view of the power density for the time-averaged maximum transmitted power of 452 W in band B71 (corresponding to the time-averaged maximum EIRP of 72.25 dBm in the boresight direction) and the beam oriented in azimuth = 0° & elevation = +13° (US/related)..... 13

Figure 5 - Top view of the power density for the actual maximum transmitted power of 180 W in band B71 (corresponding to the actual EIRP threshold of 68.25 dBm) and the beam oriented in azimuth = 0° & elevation = +13° (US/related) ..... 13

Figure 6 – Top view of the power density for the time-averaged maximum transmitted power of 452 W in band B71 (corresponding to the time-averaged maximum EIRP of 72.25 dBm in the boresight direction) and the beam oriented in azimuth = 0° & elevation = +8.0° (EU/ICNIRP, Australia/NZ)..... 14

Figure 7 - Top view of the power density for the actual maximum transmitted power of 180 W in band B71 (corresponding to the actual EIRP threshold of 68.25 dBm) and the beam oriented in azimuth = 0° & elevation = +8° (EU/ICNIRP, Australia/NZ) ..... 14

Figure 8 – Side view of the power density for the time-averaged maximum transmitted power of 452 W in band B71 (corresponding to the time-averaged maximum EIRP of 72.25 dBm in the boresight direction) and the beam oriented in azimuth = 0° & elevation = +13° (EU/ICNIRP, Australia/NZ)..... 15

Figure 9 - Top view of the power density for the actual maximum transmitted power of 180 W in band B71 (corresponding to the actual EIRP threshold of 68.25 dBm) and the beam oriented in azimuth = 0° & elevation = +13° (EU/ICNIRP, Australia/NZ)..... 15

Figure 10 – Top view of the power density for the time-averaged maximum transmitted power of 452 W in band B71 (corresponding to the time-averaged maximum EIRP of 72.25 dBm in the boresight direction) and the beam oriented in azimuth = 0° & elevation = +8.0° (Canada)..... 16

Figure 11 - Top view of the power density for the actual maximum transmitted power of 180 W in band B71 (corresponding to the actual EIRP threshold of 68.25 dBm) and the beam oriented in azimuth = 0° & elevation = +8° (Canada) ..... 17

Figure 12 - Side view of the power density for the time-averaged maximum transmitted power of 452 W in band B71 (corresponding to the time-averaged maximum EIRP of 72.25 dBm in the boresight direction) and the beam oriented in azimuth = 0° & elevation = +13° (Canada)..... 17

Figure 13 - Top view of the power density for the actual maximum transmitted power of 180 W in band B71 (corresponding to the actual EIRP threshold of 68.25 dBm) and the beam oriented in azimuth = 0° & elevation = +13° (Canada) ..... 18

## 1 General content

This test report is addressing human exposure to radiofrequency electromagnetic fields (RF-EMF) transmitted by the following Nokia Multiband Remote Radio Head (RRH) product (see §4):

- Nokia AHLOB AirScale RRH 4T4R B71/85 320W

It provides the RF exposure compliance boundaries for this product when it is connected with a typical external antenna, such as Commscope FF-65C-R1. The assessment is performed regarding both general population and occupational exposure. Outside of these compliance boundaries, human exposure to RF-EMF is below the limits defined by the US Federal Communications Commission (FCC), Canada Safety Code 6, Australia ARPANSA and European regulations (see §2.1 and [14]).

## 2 References

### 2.1 Applicable RF exposure standards and regulations

- [1] EU 1999/519/EC, "Council Recommendation on the limitation of exposure of the general public to electromagnetic fields (0 Hz to 300 GHz)", July 1999
- [2] EU 2013/35/EU, "Directive of the European Parliament and of the Council on the minimum health and safety requirements regarding the exposure of workers to the risks arising from physical agents (electromagnetic fields) (20th individual Directive within the meaning of Article 16(1) of Directive 89/391/EEC) and repealing Directive 2004/40/EC", June 2013
- [3] EN 50385:2017, "Product standard to demonstrate the compliance of base station equipment with radiofrequency electromagnetic field exposure limits (110 MHz - 100 GHz), when placed on the market", July 2017
- [4] IEC 62232 ED3 CDV (106/550/CDV), "Determination of RF field strength, power density and SAR in the vicinity of radiocommunication base stations for the purpose of evaluating human exposure", 2021.
- [5] AS/NZS 2772.2, "Radiofrequency fields Part 2: Principles and methods of measurement and computation-3 kHz to 300 GHz", 2016
- [6] ARPANSA "Maximum Exposure Levels to Radiofrequency Fields — 3 kHz to 300 GHz", Radiation Protection Series Publication No. 3, 2016
- [7] Canada Safety Code 6, "Limits of Human Exposure to Radiofrequency Electromagnetic Energy in the Frequency Range from 3 kHz to 300 GHz", June 2015

- [8] Canada RSS-102, “Radio Frequency (RF) Exposure Compliance of Radiocommunication Apparatus (All Frequency Bands)”, Issue 5, March 2015,
- [9] US FCC 47CFR 1.1310 “Radiofrequency radiation exposure limits”, August 1997.
- [10] US FCC OET Bulletin 65, “Evaluating Compliance with FCC Guidelines for Human Exposure to Radiofrequency Electromagnetic Fields and its supplements”, edition 97-01, August 1997.

## 2.2 Product and assessment method

- [11] Microwave Vision Group (MVG), “EMF Visual User Manual”, SEWB/EMF-VISUAL-UM.1/v2021.3.
- [12] Z. Altman, B. Begasse, C. Dale, A. Karwowski, J. Wiart, M. Wong and L. Gattoufi, “Efficient models for base station antennas for human exposure assessment”, IEEE Trans. Electromagnetic Compatibility, Nov 2002, vol.44, pp. 588-592.
- [13] IEC TR62669, “Case studies supporting the implementation of IEC 62232”, (106/463/CD, July 2018).
- [14] NGMN white paper, “Recommendation on Base Station Active Antenna System Standards v1.0”, July 2020,  
[https://www.ngmn.org/wp-content/uploads/Publications/2020/NGMN\\_BASTA-AA\\_WP\\_1\\_0.pdf](https://www.ngmn.org/wp-content/uploads/Publications/2020/NGMN_BASTA-AA_WP_1_0.pdf)
- [15] Commscope FF-65C-R1, 4-port sector antenna, 4x 617–806 MHz, 65° HPBW, 1x RET, 600MHz-Ready Antenna Technology

## 3 RF exposure limits

The applicable RF exposure limits are defined by [1] and [2] in Europe and ICNIRP countries, by [5] in Australia and New Zealand, by [7] in Canada and by [9] in the US and related countries such as Bolivia, Estonia, Mexico and Panama. The applicable power density limits are recalled in Table 1 for the frequency range applicable to the equipment under test.

Table 1 – Applicable RF exposure levels in B71 and B85 bands expressed in power density

Region of application	General Population/Uncontrolled Exposures		Occupational/Controlled Exposures	
	B71	B85	B71	B85
US/related	4.1 W/m <sup>2</sup>	4.9 W/m <sup>2</sup>	20.6 W/m <sup>2</sup>	24.3 W/m <sup>2</sup>
EU/ICNIRP, Australia/NZ	3.1 W/m <sup>2</sup>	3.6 W/m <sup>2</sup>	15.4 W/m <sup>2</sup>	18.2 W/m <sup>2</sup>
Canada	2.1 W/m <sup>2</sup>	2.4 W/m <sup>2</sup>	16.0 W/m <sup>2</sup>	17.4 W/m <sup>2</sup>

## 4 Description of the equipment under test (EUT)

The main technical characteristics of AHLOB product, when it is connected with a typical external antenna, such as Commscope FF-65C-R1, are provided in Table 2.

Table 2 – AHLOB and Commscope FF-65C-R1 general technical characteristics

RRH Product name	Nokia AHLOB AirScale RRH 4T4R B71/85 320W	
Model number	475910A	
Rated max Tx power	320 W	
Number of TXRX	4TX4RX	
Beamforming	No	
SW supported techno.	3GPP compliant, FCC&ISED, FDD-LTE, NR	
Frequency range	Band 71: RX 663 MHz – 698 MHz, TX 617 MHz – 652 MHz Band 85: RX 698 MHz – 716 MHz, TX 728 MHz – 746 MHz	
Antenna Product name	Commscope FF-65C-R1	
Max Antenna Gain	Band 71: 15.7 dBi Band 85: 15.9 dBi	
Electrical Tilt range	+2.0° to +13.0°	
Dimensions	Height: 2437 mm Width: 640 mm Depth: 235 mm	
Technology duty cycle factor	100 %	
Transmitted power tolerance	1.5 dB	

NOTE: Nokia AHLOB AirScale RRH 4T4R B71/85 320W radio is capable to transmit with the full power of 320 W only in one of supported bands, either B71 or B85. The antenna gain difference between both bands is within 0.2 dB. The RF exposure levels in band B71 are lower by 0.6 dB to 0.8 dB compared to band B85 for all regions of applications (see Table 1). The compliance boundaries established for band B71 are providing conservative distances for band B85 and therefore are applicable to both bands.

The EMF Visual model used for the RF exposure assessment is derived based on datasheet of Commscope FF-65C-R1 antenna [15]. The EMF Visual model is validated with the product antenna model using the same pattern and gain. Table 4 to Table 5 presents EMF Visual models of beam patterns in configurations used for the assessment of the compliance boundary. Selected patterns ensure that maximum compliance distance, applicable to evaluated product, is obtained.

Azimuth and elevation angles indicated in this report are provided according to the reference system used in product data sheets (see Table 3), unless otherwise stated.

Table 3 - Reference system used in this report (from NGMN white paper [14])

<p>3D view Definition of azimuth <math>\varphi</math> and elevation <math>\theta</math></p>	
<p>Top view (horizontal cut) Definition of azimuth <math>\varphi</math></p>	
<p>Side view (vertical cut) Definition of elevation <math>\theta</math></p>	



Table 4 – Antenna beam pattern models for band B71 used for EMF evaluation

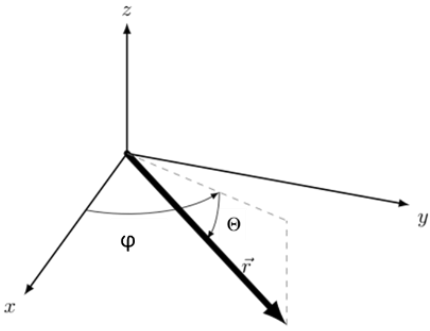
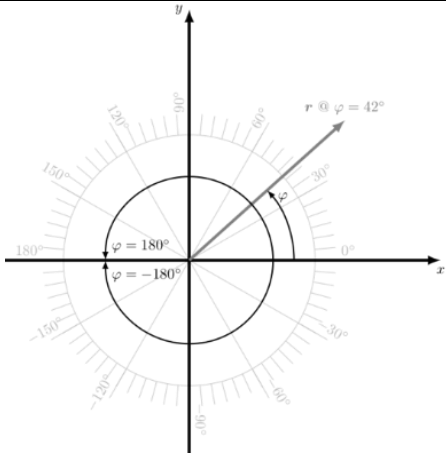
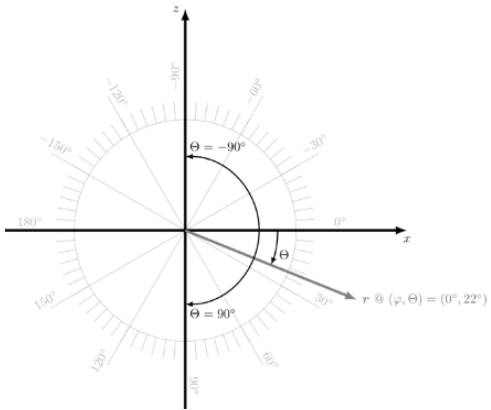
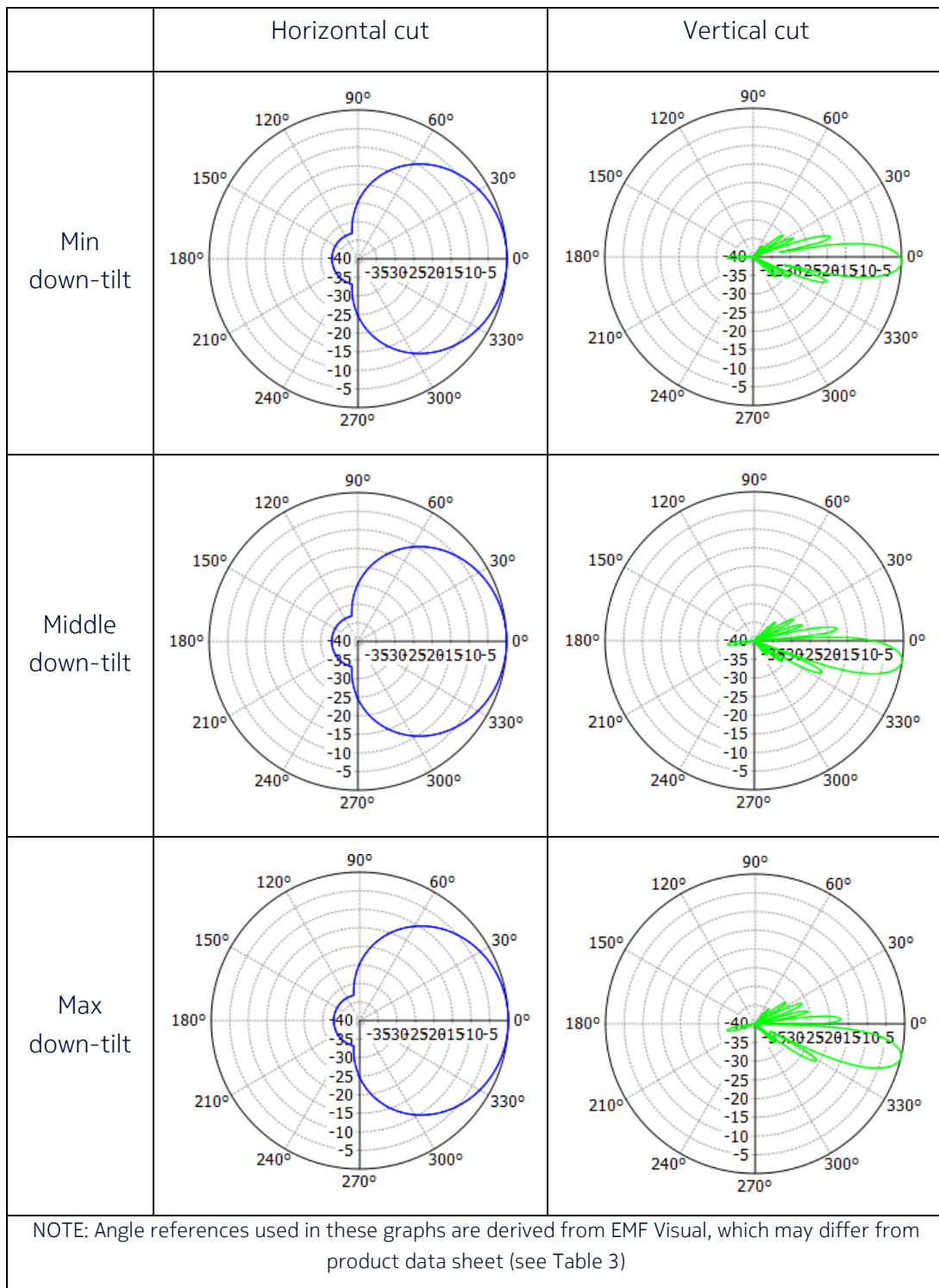

Table 5 – Antenna gain characteristics for band B71 used during EMF evaluation

	Azimuth pointing angle	Elevation pointing angle	Gain (dBi)
Min down-tilt	0°	+2.0°	15.4 dBi
Middle down-tilt	0°	+8.0°	15.7 dBi
Max down-tilt	0°	+13.0°	15.6 dBi

The compliance boundary is defined by the box shape perimeter shown in Figure 4 of IEC 62232:2017 [4] and displayed in Figure 1. The distances  $D_f$ ,  $D_{s,a}$ ,  $D_{u,a}$  and  $D_{d,a}$  are taken from the nearest point of the antenna. For convenience, the distances  $D_{s,c}$ ,  $D_{u,c}$  and  $D_{d,c}$  (respectively) taken from antenna center are also provided.

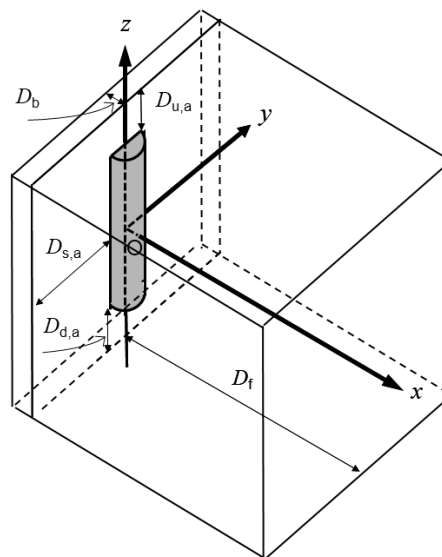

Figure 1 – Shape of the compliance boundary used for the RF exposure compliance assessment (from [4]).

## 5 RF exposure assessment method

RF exposure assessment is performed using the synthetic model computation method defined in B.4.4.1 of IEC 62232:2017. Calculations are performed with the “EMF Visual” software release OKTAL Version 4.0 2021.3 (see [11] and [12]).

The validation of the model is performed in the configuration with the beam in front and max available gain in band B71 (azimuth = 0° and elevation = +8.0°). The validation results are provided in Table 6.

Table 6 - Validation of the antenna model for band B71

	Product	EMF Visual model	Deviation
Gain	15.7 dBi	15.7 dBi	0.0 dB
Horizontal half-power beamwidth	64.0° ± 3.3°	64.5°	0.5°
Vertical half-power beamwidth	10.3° ± 0.6°	10.5°	0.2°

The directivity pattern is derived from the simulation model and the antenna gain is adjusted to match exactly the simulated values for accurate scaling.

The RF compliance distances are provided for the maximum transmitted power of 452 W. This corresponds to the maximum EIRP of 72.25 dBm in the direction of maximum gain. The RF compliance distances are also provided for the actual EIRP threshold of 68.25 dBm, applying a power reduction factor of - 4 dB as defined in [4] and [13]. These values include a technology duty cycle factor of 100 % (see Table 2) for time averaging and a power tolerance of 1.5 dB due to electronic component dispersion and operational environmental conditions (temperature).

## 6 RF exposure computation results

### 6.1 Regions of application: US/related

The computed 3D distributions corresponding to a total exposure ratio (TER) of 1, for both general public and occupational exposure limits, are displayed in Figure 2 through Figure 5 for RF exposure limits defined in [9] for US/related countries.

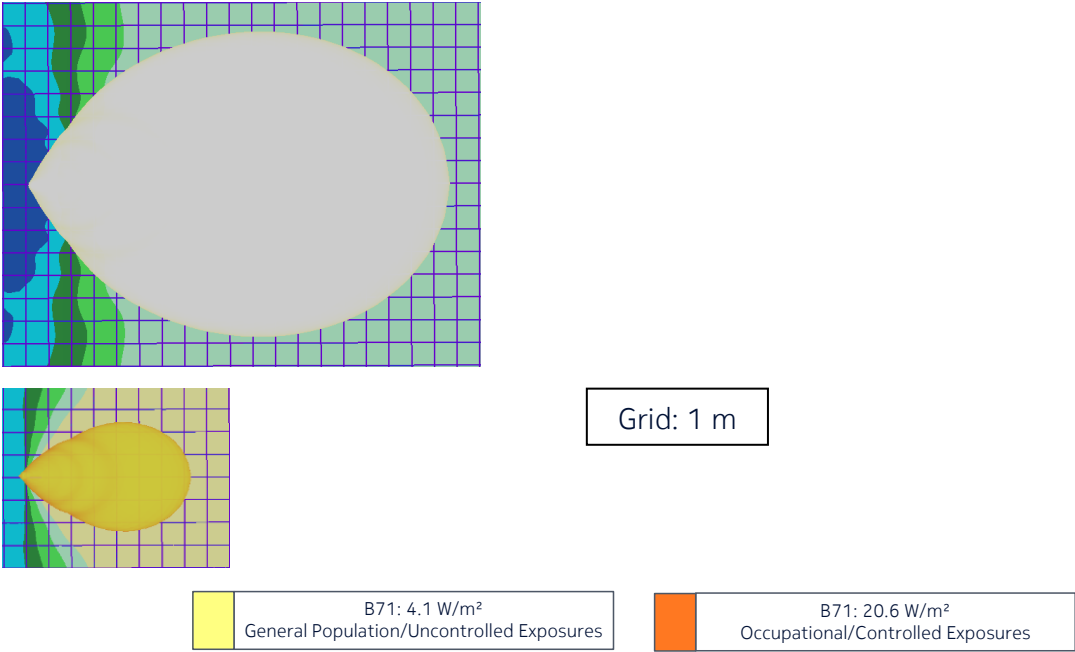

Figure 2 – Top view of the power density for the time-averaged maximum transmitted power of 452 W in band B71 (corresponding to the time-averaged maximum EIRP of 72.25 dBm in the boresight direction) and the beam oriented in azimuth = 0° & elevation = +8.0° (US/related)

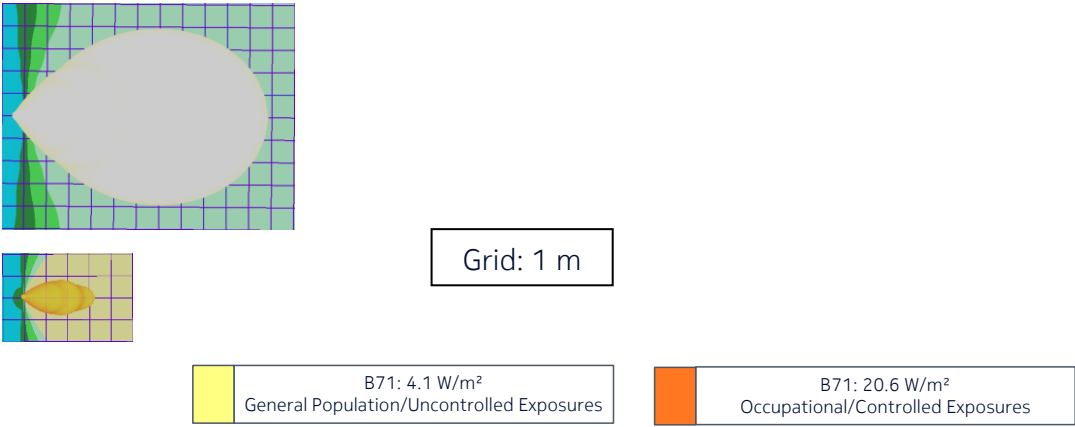

Figure 3 - Top view of the power density for the actual maximum transmitted power of 180 W in band B71 (corresponding to the actual EIRP threshold of 68.25 dBm) and the beam oriented in azimuth = 0° & elevation = +8° (US/related)

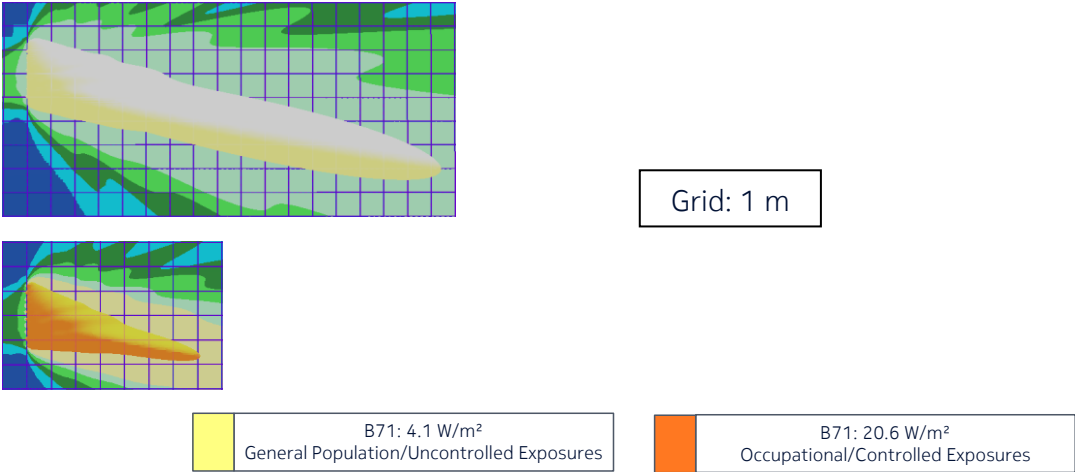

Figure 4 – Side view of the power density for the time-averaged maximum transmitted power of 452 W in band B71 (corresponding to the time-averaged maximum EIRP of 72.25 dBm in the boresight direction) and the beam oriented in azimuth = 0° & elevation = +13° (US/related)

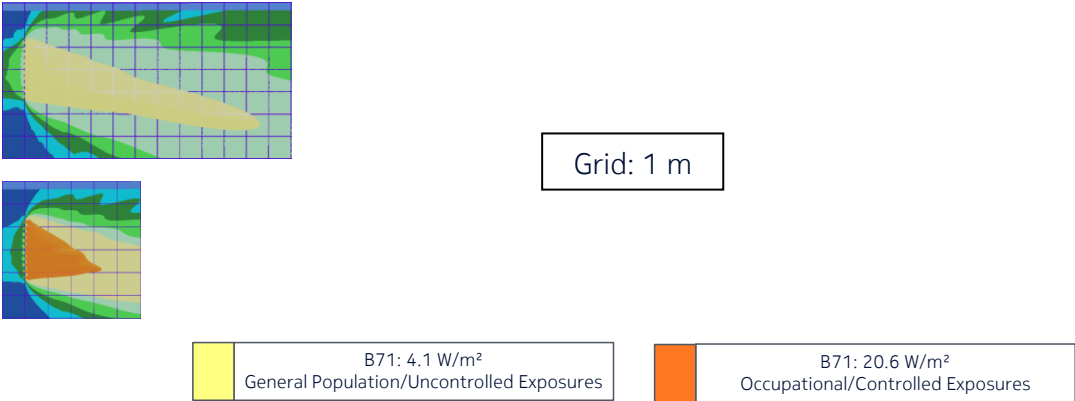

Figure 5 - Top view of the power density for the actual maximum transmitted power of 180 W in band B71 (corresponding to the actual EIRP threshold of 68.25 dBm) and the beam oriented in azimuth = 0° & elevation = +13° (US/related)

6.2 Regions of application: EU/ICNIRP and Australia/NZ

The computed 3D distributions corresponding to a total exposure ratio (TER) of 1, for both general public and occupational exposure limits, are displayed in Figure 6 through Figure 9 for RF exposure limits defined in [1], [2] for EU/ICNIRP countries and [5] for Australia/NZ.

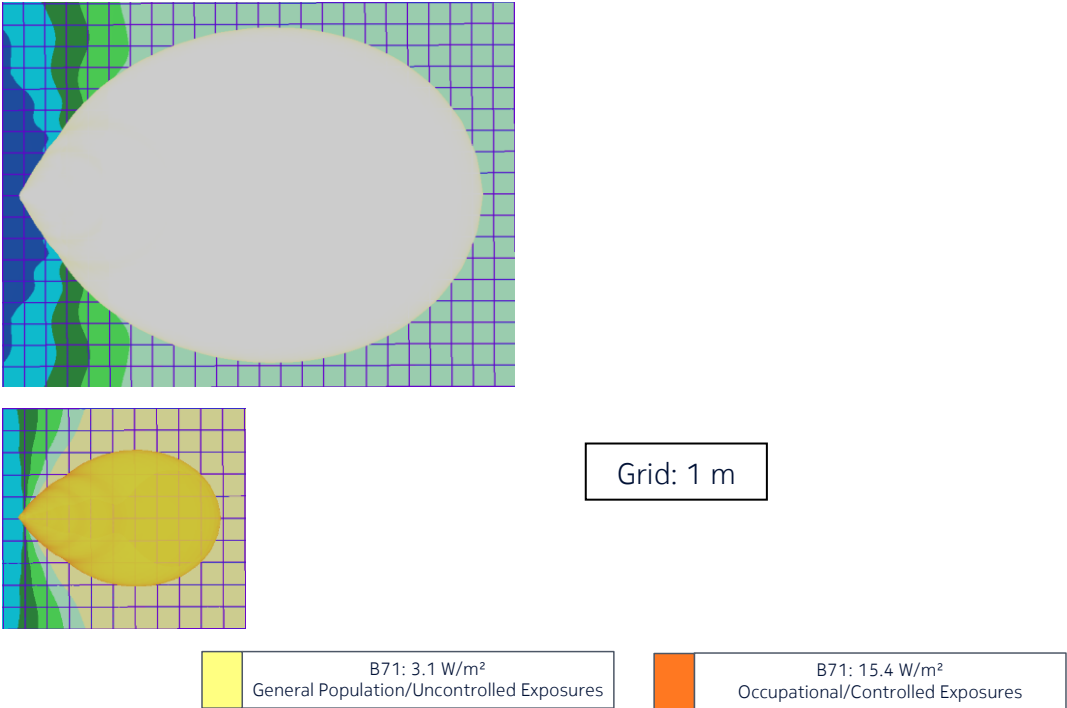

Figure 6 – Top view of the power density for the time-averaged maximum transmitted power of 452 W in band B71 (corresponding to the time-averaged maximum EIRP of 72.25 dBm in the boresight direction) and the beam oriented in azimuth = 0° & elevation = +8.0° (EU/ICNIRP, Australia/NZ)

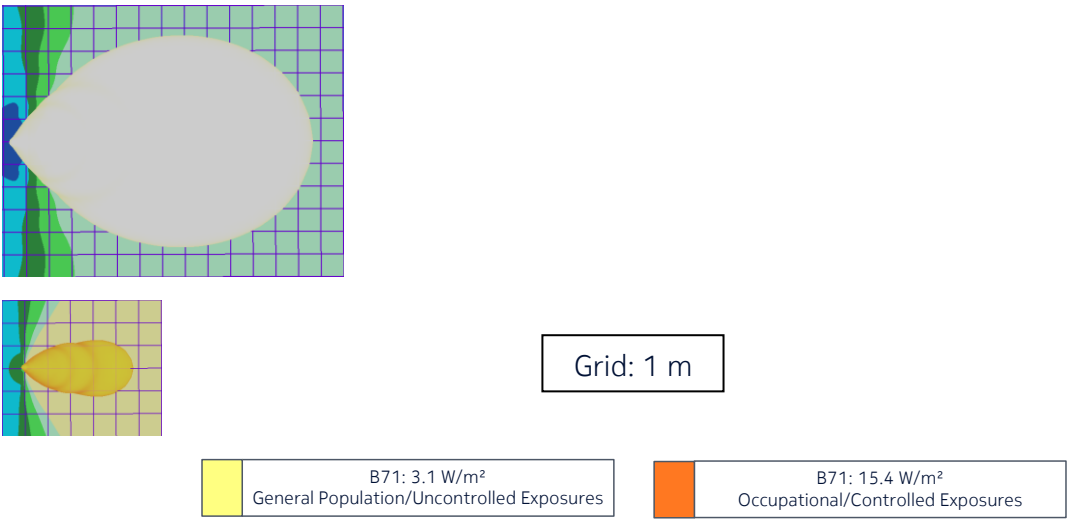

Figure 7 - Top view of the power density for the actual maximum transmitted power of 180 W in band B71 (corresponding to the actual EIRP threshold of 68.25 dBm) and the beam oriented in azimuth = 0° & elevation = +8° (EU/ICNIRP, Australia/NZ)

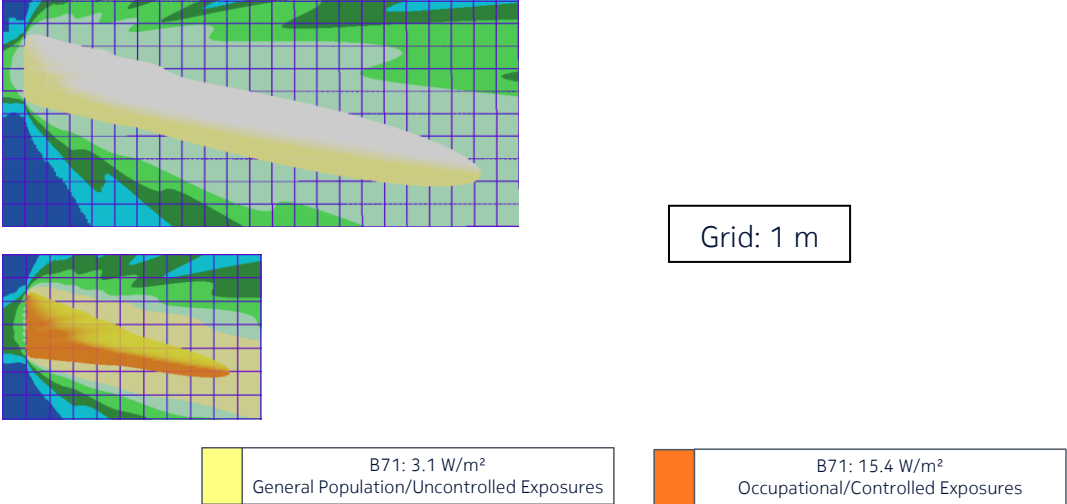

Figure 8 – Side view of the power density for the time-averaged maximum transmitted power of 452 W in band B71 (corresponding to the time-averaged maximum EIRP of 72.25 dBm in the boresight direction) and the beam oriented in azimuth = 0° & elevation = +13° (EU/ICNIRP, Australia/NZ)

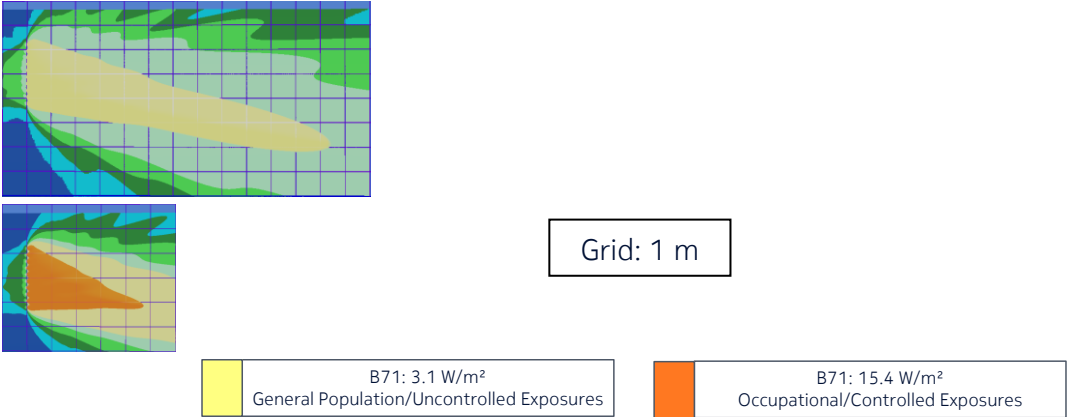

Figure 9 - Top view of the power density for the actual maximum transmitted power of 180 W in band B71 (corresponding to the actual EIRP threshold of 68.25 dBm) and the beam oriented in azimuth = 0° & elevation = +13° (EU/ICNIRP, Australia/NZ)

## 6.3 Regions of application: Canada

The computed 3D distributions corresponding to a total exposure ratio (TER) of 1, for both general public and occupational exposure limits, are displayed in Figure 10 through Figure 13 for RF exposure limits defined in [7] for Canada.

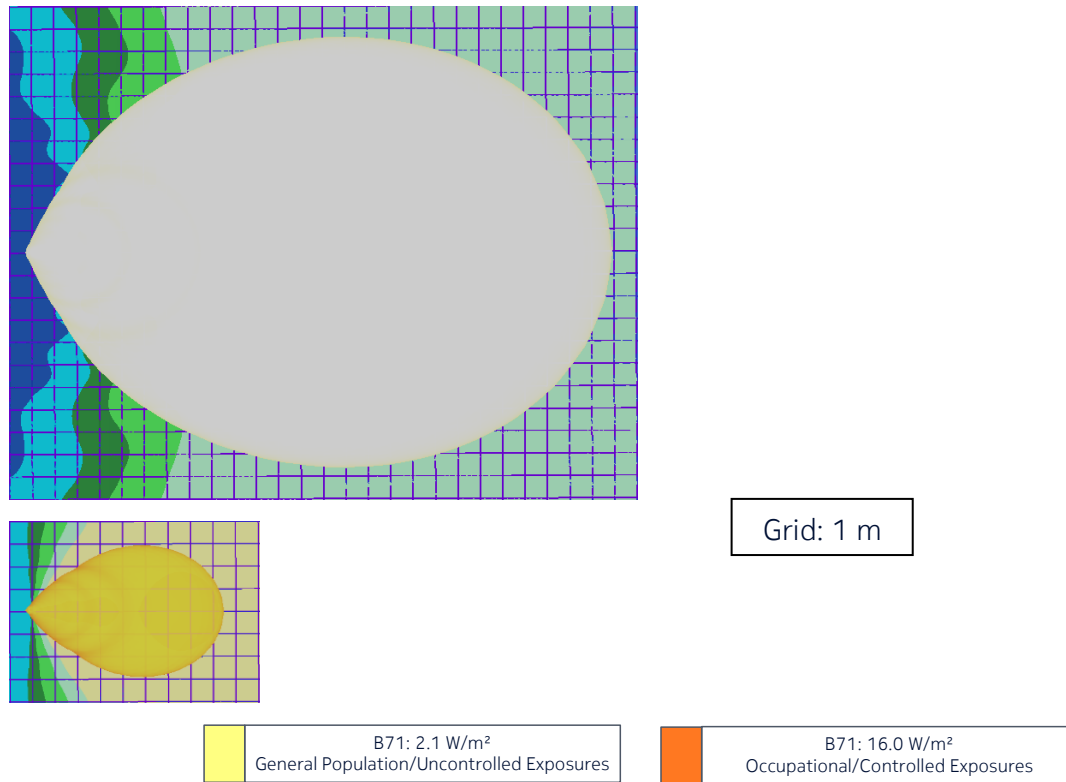

Figure 10 – Top view of the power density for the time-averaged maximum transmitted power of 452 W in band B71 (corresponding to the time-averaged maximum EIRP of 72.25 dBm in the boresight direction) and the beam oriented in azimuth = 0° & elevation = +8.0° (Canada)



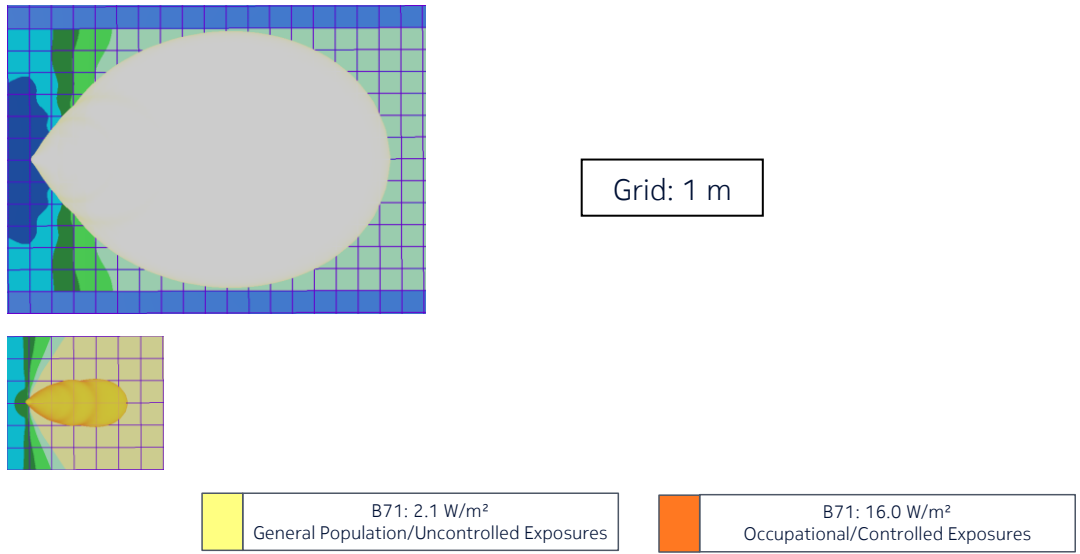

Figure 11 - Top view of the power density for the actual maximum transmitted power of 180 W in band B71 (corresponding to the actual EIRP threshold of 68.25 dBm) and the beam oriented in azimuth = 0° & elevation = +8° (Canada)

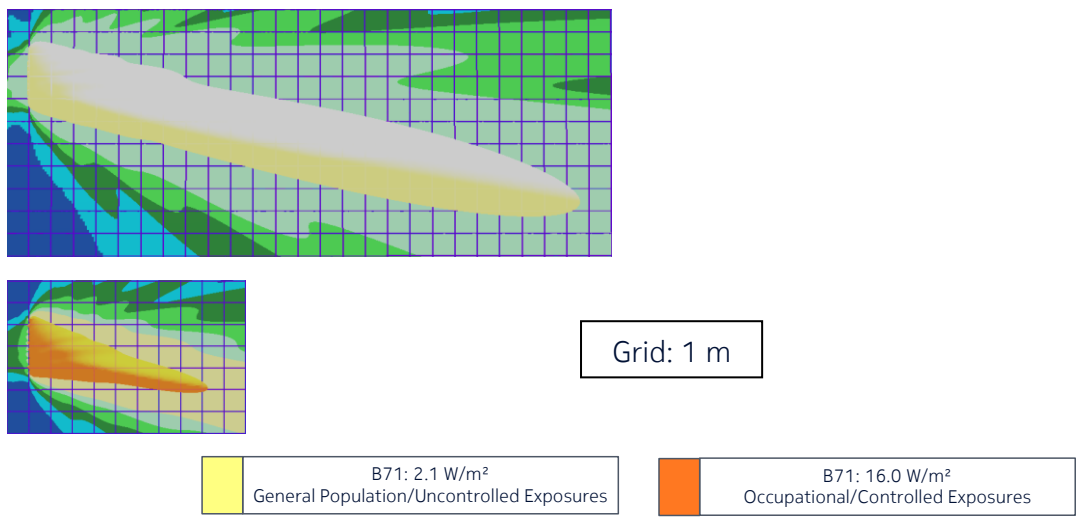
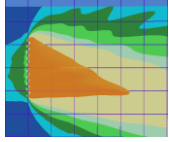
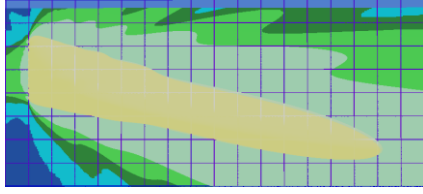

Figure 12 - Side view of the power density for the time-averaged maximum transmitted power of 452 W in band B71 (corresponding to the time-averaged maximum EIRP of 72.25 dBm in the boresight direction) and the beam oriented in azimuth = 0° & elevation = +13° (Canada)



Grid: 1 m

 B71: 2.1 W/m<sup>2</sup>  
General Population/Uncontrolled Exposures

 B71: 16.0 W/m<sup>2</sup>  
Occupational/Controlled Exposures

Figure 13 - Top view of the power density for the actual maximum transmitted power of 180 W in band B71 (corresponding to the actual EIRP threshold of 68.25 dBm) and the beam oriented in azimuth = 0° & elevation = +13° (Canada)

## 7 Conclusion and installation recommendations

The RF exposure compliance distances for the Nokia AHLOB AirScale RRH 4T4R B71/85 320W product, when it is connected with a typical external antenna, such as Commscope FF-65C-R1, are summarized in Table 7 for US/related [9] requirements, in Table 8 for EU/ICNIRP [1][2], Australia/NZ [5] and in Table 9 for Canada [7] requirements.

Table 7 – AHLOB RF exposure compliance distances based on the time-averaged maximum transmitted power of 452 W for US/related

Region of application: US/related	General Population/Uncontrolled Exposures	Occupational/Controlled Exposures
RF-EMF power density exposure limits	B71: 4.1 W/m <sup>2</sup>	B71: 20.6 W/m <sup>2</sup>
Distance in front ( $D_f$ )	17.7 m	7.3 m
Distance to the side ( $D_{s,a}$ )	6.5 m	2.1 m
Distance below ( $D_{d,a}$ )	3.3 m	0.7 m
Distance above ( $D_{u,a}$ )	0.3 m	0.2 m
Distance to the side ( $D_{s,c}$ )	6.8 m	2.4 m
Distance below ( $D_{d,c}$ )	4.5 m	1.9 m
Distance above ( $D_{u,c}$ )	1.5 m	1.4 m

Table 8 – AHLOB RF exposure compliance distances based on the time-averaged maximum transmitted power of 452 W for EU/ICNIRP and Australia/NZ

Region of application: EU/ICNIRP and Australia/NZ	General Population/Uncontrolled Exposures	Occupational/Controlled Exposures
RF-EMF power density exposure limits	B71: 3.1 W/m <sup>2</sup>	B71: 15.4 W/m <sup>2</sup>
Distance in front ( $D_f$ )	20.5 m	8.9 m
Distance to the side ( $D_{s,a}$ )	7.6 m	2.8 m
Distance below ( $D_{d,a}$ )	4.1 m	1.1 m
Distance above ( $D_{u,a}$ )	0.3 m	0.2 m
Distance to the side ( $D_{s,c}$ )	7.9 m	3.1 m
Distance below ( $D_{d,c}$ )	5.3 m	2.3 m
Distance above ( $D_{u,c}$ )	1.5 m	1.4 m

Table 9 - AHLOB RF exposure compliance distances based on the time-averaged maximum transmitted power of 452 W for Canada

Region of application: Canada	General Population/Uncontrolled Exposures	Occupational/Controlled Exposures
RF-EMF power density exposure limits	B71: 2.1 W/m <sup>2</sup>	B71: 16.0 W/m <sup>2</sup>
Distance in front ( $D_f$ )	25.0 m	8.5 m
Distance to the side ( $D_{s,a}$ )	9.4 m	2.7 m
Distance below ( $D_{d,a}$ )	5.1 m	1.0 m
Distance above ( $D_{u,a}$ )	0.4 m	0.2 m
Distance to the side ( $D_{s,c}$ )	9.7 m	3.0 m
Distance below ( $D_{d,c}$ )	6.3 m	2.2 m
Distance above ( $D_{u,c}$ )	1.6 m	1.4 m

The RF exposure compliance distances based on the actual maximum transmitted power, applying a power reduction factor of – 4 dB, are summarized in Table 10 - Table 12. These values are provided for information about the RF exposure levels that may be reached in operational conditions considering a time-averaging window of 6 minutes according to [4] and [13].

Table 10 – AHLOB RF exposure compliance distances based on actual maximum transmitted power of 180 W for US/related

For information in US/related countries based on IEC/EN 62232:2017 [4] and IEC TR62669 [13]	General Population/Uncontrolled Exposures	Occupational/Controlled Exposures
RF-EMF power density exposure limits	B71: 4.1 W/m <sup>2</sup>	B71: 20.6 W/m <sup>2</sup>
Distance in front ( $D_f$ )	10.9 m	3.3 m
Distance to the side ( $D_{s,a}$ )	3.7 m	0.5 m
Distance below ( $D_{d,a}$ )	1.6 m	0.1 m
Distance above ( $D_{u,a}$ )	0.2 m	0.1 m
Distance to the side ( $D_{s,c}$ )	4.0 m	0.8 m
Distance below ( $D_{d,c}$ )	2.8 m	1.3 m
Distance above ( $D_{u,c}$ )	1.4 m	1.3 m

Table 11 – AHLOB RF exposure compliance distances based on actual maximum transmitted power of 180 W for EU/ICNIRP and Australia/NZ

For information in EU/ICNIRP and Australia/NZ based on IEC/EN 62232:2017 [4] and IEC TR62669 [13]	General Population/Uncontrolled Exposures	Occupational/Controlled Exposures
RF-EMF power density exposure limits	B71: 3.1 W/m <sup>2</sup>	B71: 15.4 W/m <sup>2</sup>
Distance in front ( $D_f$ )	12.7 m	4.8 m
Distance to the side ( $D_{s,a}$ )	4.4 m	1.0 m
Distance below ( $D_{d,a}$ )	2.0 m	0.2 m
Distance above ( $D_{u,a}$ )	0.3 m	0.2 m
Distance to the side ( $D_{s,c}$ )	4.7 m	1.3 m
Distance below ( $D_{d,c}$ )	3.2 m	1.4 m
Distance above ( $D_{u,c}$ )	1.5 m	1.4 m

Table 12 - AHLOB RF exposure compliance distances based on actual maximum transmitted power of 180 W for Canada

For information in Canada based on IEC/EN 62232:2017 [4] and IEC TR62669 [13]	General Population/Uncontrolled Exposures	Occupational/Controlled Exposures
RF-EMF power density exposure limits	B71: 2.1 W/m <sup>2</sup>	B71: 16.0 W/m <sup>2</sup>
Distance in front (D <sub>f</sub> )	15.5 m	4.4 m
Distance to the side (D <sub>s,a</sub> )	5.6 m	0.8 m
Distance below (D <sub>d,a</sub> )	2.7 m	0.2 m
Distance above (D <sub>u,a</sub> )	0.3 m	0.2 m
Distance to the side (D <sub>s,c</sub> )	5.9 m	1.1 m
Distance below (D <sub>d,c</sub> )	3.9 m	1.4 m
Distance above (D <sub>u,c</sub> )	1.5 m	1.4 m

Installation of the Nokia AHLOB AirScale RRH 4T4R B71/85 320W product, when it is connected with a typical external antenna, such as Commscope FF-65C-R1, shall be performed in accordance with all applicable manufacturer's recommendations and national laws and regulations related to human exposure to radiofrequency fields.

In particular:

- The operator or entity putting the equipment into service shall take the necessary measures to ensure that the general population cannot access the area within the general population/uncontrolled compliance boundary in the vicinity of the transmitting antennas (see Table 7 - Table 9)
- Depending on the site installation configuration, the operator or the entity putting the equipment into service determines the most suitable place to display the appropriate warning signs and any other necessary information or precautionary measures.
- Workers that are required to operate in the close proximity of the transmitting antennas connected to the equipment, for example installation and maintenance personnel, need to be informed about the potential risks of human exposure to RF fields and how to protect against them. They should strictly follow instructions provided by their employer. They should stand-off the occupational/controlled exposure compliance boundary defined in the vicinity of transmitting antennas (see Table 7 - Table 9). If it is necessary to operate within this compliance boundary, workers shall make sure that the transmitters contributing to exposure in this area are all switched off, or they must contact the relevant operator(s) to switch off emissions during operation period.

----- end of the test report -----