

FCC Test Report (Part 24)

Report No.: RF181221C07D

FCC ID: VBNAHFB-01

Test Model: AHFB

Received Date: Oct. 15, 2019

Test Date: Apr. 16 ~ Apr. 23, 2020

Issued Date: Jun. 08, 2020

Applicant: Nokia Solutions and Networks

Address: 3201 Olympus Blvd, Dallas, Texas 75019

Issued By: Bureau Veritas Consumer Products Services (H.K.) Ltd., Taoyuan Branch
Lin Kou Laboratories

Lab Address: No. 47-2, 14th Ling, Chia Pau Vil., Lin Kou Dist., New Taipei City, Taiwan

Test Location: No. 19, Hwa Ya 2nd Rd., Wen Hwa Vil., Kwei Shan Dist., Taoyuan City
33383, Taiwan

FCC Registration / 788550 / TW0003

Designation Number:



This report is for your exclusive use. Any copying or replication of this report to or for any other person or entity, or use of our name or trademark, is permitted only with our prior written permission. This report sets forth our findings solely with respect to the test samples identified herein. The results set forth in this report are not indicative or representative of the quality or characteristics of the lot from which a test sample was taken or any similar or identical product specifically and expressly noted. Our report includes all of the tests requested by you and the results thereof based upon the information that you provided to us. You have 60 days from date of issuance of this report to notify us of any material error or omission caused by our negligence, provided, however, that such notice shall be in writing and shall specifically address the issue you wish to raise. A failure to raise such issue within the prescribed time shall constitute your unqualified acceptance of the completeness of this report, the tests conducted and the correctness of the report contents. Unless specific mention, the uncertainty of measurement has been explicitly taken into account to declare the compliance or non-compliance to the specification. The report must not be used by the client to claim product certification, approval, or endorsement by TAF or any government agencies

Table of Contents

Release Control Record	4
1 Certificate of Conformity	5
2 Summary of Test Results	6
2.1 Measurement Uncertainty.....	6
2.2 Test Site and Instruments.....	7
3 General Information	8
3.1 General Description of EUT.....	8
3.2 Configuration of System under Test.....	9
3.2.1 Description of Support Units.....	9
3.3 Test Mode Applicability and Tested Channel Detail.....	10
3.4 EUT Operating Conditions.....	11
3.5 General Description of Applied Standards and References.....	11
4 Test Types and Results	12
4.1 Output Power Measurement.....	12
4.1.1 Limits of Output Power Measurement.....	12
4.1.2 Test Procedures.....	12
4.1.3 Test Setup.....	12
4.1.4 Test Results.....	13
4.2 Modulation Characteristics Measurement.....	16
4.2.1 Limits of Modulation Characteristics.....	16
4.2.2 Test Procedure.....	16
4.2.3 Test Setup.....	16
4.2.4 Test Results.....	16
4.3 Frequency Stability Measurement.....	17
4.3.1 Limits of Frequency Stability Measurement.....	17
4.3.2 Test Instruments.....	17
4.3.3 Test Procedure.....	17
4.3.4 Conducted Setup.....	17
4.3.5 Test Results.....	18
4.4 Occupied Bandwidth Measurement.....	19
4.4.1 Test Procedure.....	19
4.4.2 Test Setup.....	19
4.4.3 Test Result.....	20
4.5 Band Edge Measurement.....	24
4.5.1 Limits of Band Edge Measurement.....	24
4.5.2 Test Setup.....	24
4.5.3 Test Procedures.....	24
4.5.4 Test Results.....	25
4.6 Peak to Average Ratio.....	27
4.6.1 Limits of Peak to Average Ratio Measurement.....	27
4.6.2 Test Setup.....	27
4.6.3 Test Procedures.....	27
4.6.4 Test Results.....	28
4.7 Conducted Spurious Emissions.....	30
4.7.1 Limits of Conducted Spurious Emissions Measurement.....	30
4.7.2 Test Setup.....	30
4.7.3 Test Procedure.....	30
4.7.4 Test Results.....	31
4.8 Radiated Emission Measurement.....	35
4.8.1 Limits of Radiated Emission Measurement.....	35
4.8.2 Test Procedure.....	35
4.8.3 Deviation from Test Standard.....	35
4.8.4 Test Setup.....	36

4.8.5 Test Results	37
5 Pictures of Test Arrangements.....	40
Appendix – Information of the Testing Laboratories	41



Release Control Record

Issue No.	Description	Date Issued
RF181221C07D	Original release	Jun. 08, 2020

1 Certificate of Conformity

Product: AirScale Base Station RRH 1.9GHz

Brand: Nokia

Test Model: AHFB

Sample Status: Mass product

Applicant: Nokia Solutions and Networks

Test Date: Apr. 16 ~ Apr. 23, 2020

Standards: FCC Part 24, Subpart E

The above equipment has been tested by **Bureau Veritas Consumer Products Services (H.K.) Ltd., Taoyuan Branch**, and found compliance with the requirement of the above standards. The test record, data evaluation & Equipment Under Test (EUT) configurations represented herein are true and accurate accounts of the measurements of the sample's RF characteristics under the conditions specified in this report.

Prepared by : Pettie Chen , **Date:** Jun. 08, 2020
Pettie Chen / Senior Specialist

Approved by : Bruce Chen , **Date:** Jun. 08, 2020
Bruce Chen / Senior Project Engineer

2 Summary of Test Results

Applied Standard: FCC Part 24 & Part 2			
FCC Clause	Test Item	Result	Remarks
2.1046 24.232	Effective radiated power	Pass	Meet the requirement of limit.
2.1046 24.232(d)	Peak To Average Ratio	Pass	Meet the requirement of limit.
2.1047	Modulation Characteristics	Pass	Meet the requirement
2.1055 24.235	Frequency Stability	Pass	Meet the requirement of limit.
2.1049 24.238(b)	Occupied Bandwidth	Pass	Meet the requirement of limit.
24.238(b)	Band Edge Measurements	Pass	Meet the requirement of limit.
2.1051 24.238	Conducted Spurious Emissions	Pass	Meet the requirement of limit.
2.1053 24.238	Radiated Spurious Emissions	Pass	Meet the requirement of limit. Minimum passing margin is -10.6dB at 58.13MHz.

Note:

Determining compliance based on the results of the compliance measurement, not taking into account measurement instrumentation uncertainty.

2.1 Measurement Uncertainty

Where relevant, the following measurement uncertainty levels have been estimated for tests performed on the EUT as specified in CISPR 16-4-2:

Measurement	Frequency	Expanded Uncertainty (k=2) (\pm)
Radiated Emissions up to 1 GHz	9kHz ~ 30MHz	3.04 dB
	30MHz ~ 200MHz	3.59 dB
	200MHz ~ 1000MHz	3.60 dB
Radiated Emissions above 1 GHz	1GHz ~ 18GHz	2.29 dB
	18GHz ~ 40GHz	2.29 dB

2.2 Test Site and Instruments

Description & Manufacturer	Model No.	Serial No.	Cal. Date	Cal. Due
Test Receiver KEYSIGHT	N9038A	MY55420137	Apr. 15, 2019	Apr. 14, 2020
			Apr. 16, 2020	Apr. 15, 2021
Spectrum Analyzer ROHDE & SCHWARZ	FSP40	100269	Jun. 04, 2019	Jun. 03, 2020
BILOG Antenna SCHWARZBECK	VULB9168	9168-160	Nov. 21, 2018	Nov. 20, 2019
			Nov. 07, 2019	Nov. 06, 2020
HORN Antenna SCHWARZBECK	BBHA 9120 D	9120D-1169	Nov. 25, 2018	Nov. 24, 2019
			Nov. 24, 2019	Nov. 23, 2020
HORN Antenna SCHWARZBECK	BBHA 9170	BBHA9170241	Nov. 25, 2018	Nov. 24, 2019
			Nov. 24, 2019	Nov. 23, 2020
Loop Antenna TESEQ	HLA 6121	45745	Jul. 01, 2019	Jun. 30, 2020
Preamplifier Agilent (Below 1GHz)	8447D	2944A10638	Jul. 11, 2019	Jul. 10, 2020
Preamplifier Agilent (Above 1GHz)	8449B	3008A02367	Feb. 19, 2019	Feb. 18, 2020
			Feb. 18, 2020	Feb. 17, 2021
RF signal cable HUBER+SUHNER&EMCI	SUCOFLEX 104 & EMC104-SM-SM8000	CABLE-CH9-02 (248780+171006)	Jan. 19, 2019	Jan. 18, 2020
			Jan. 18, 2020	Jan. 17, 2021
RF signal cable HUBER+SUHNER	SUCOFLEX 104	CABLE-CH9-(250795/4)	Jul. 11, 2019	Jul. 10, 2020
RF signal cable Woken	8D-FB	Cable-CH9-01	Jul. 30, 2019	Jul. 29, 2020
Software BV ADT	ADT_Radiated_ V7.6.15.9.5	NA	NA	NA
Antenna Tower EMCO	2070/2080	512.835.4684	NA	NA
Turn Table EMCO	2087-2.03	NA	NA	NA
Antenna Tower & Turn BV ADT	AT100	AT93021705	NA	NA
Turn Table BV ADT	TT100	TT93021705	NA	NA
Turn Table Controller BV ADT	SC100	SC93021705	NA	NA
Boresight Antenna Fixture	FBA-01	FBA-SIP01	NA	NA
WIT Standard Temperature And Humidity Chamber	TH-4S-C	W981030	Jun. 03, 2019	Jun. 02, 2020
JFW 20dB attenuation	50HF-020-SMA	NA	NA	NA

Note: 1. The calibration interval of the above test instruments is 12 months and the calibrations are traceable to NML/ROC and NIST/USA.
2. The test was performed in HwaYa Chamber 9.

3 General Information

3.1 General Description of EUT

Product	AirScale Base Station RRH 1.9GHz				
Brand	Nokia				
Test Model	AHFB				
Sample Status	Mass product				
Power Supply Rating	DC: -40.5V to -57VDC AC: 100-240VAC				
Modulation Type	QPSK, 16QAM, 64QAM, 256QAM				
Operating Frequency	Multi Carrier				
	LTE Band 25 (Channel Bandwidth: 65MHz)	1962.5MHz			
		QPSK	16QAM	64QAM	256QAM
Max. EIRP Power	Multi Carrier				
	LTE Band 25 (Channel Bandwidth: 65MHz)	363078.055mW (55.60dBm)	359749.335mW (55.56dBm)	349945.167mW (55.44dBm)	349140.315mW (55.43dBm)
Emission Designator	Multi Carrier				
	LTE Band 25 (Channel Bandwidth: 65MHz)	63M4G7D	63M4D7W	63M4D7W	63M4D7W
Antenna Type	Direction Panel antenna with 12.5dBi gain				
Antenna Connector	Nex10				
S/N	474036A.102				
HW Version	A102				
SW Version	5G19B				
Accessory Device	Refer to Note as below				
Cable Supplied	NA				

Note:

1. This report is prepared for FCC class II permissive change. This report is issued as a supplementary report of BV CPS report no.: RF181221C07C. Difference compared with the original report is adding LTE Multiple carrier (up to 65MHz). Therefore, the EUT was re-tested and presented in the test report.
2. The EUT contains following accessory devices.

AC PSU (Optional)	
Brand	Nokia
Model	APAB
Sales Item	474130A.102
S/N	U7174800066
Remark	SUPLET/S818A16
Input Power	100-240Vac, 50-60Hz, 3A MAX
Output Power	-54Vdc, 3A MAX

3. This device operate with Multiple Antennas Using Multiple-input, Multiple-output (MIMO) Technology for uncorrelated Transmission.
4. A representative Nokia antenna, AAFA 12.5dBi antenna, is referred to comply with the EIRP limits.

3.2 Configuration of System under Test

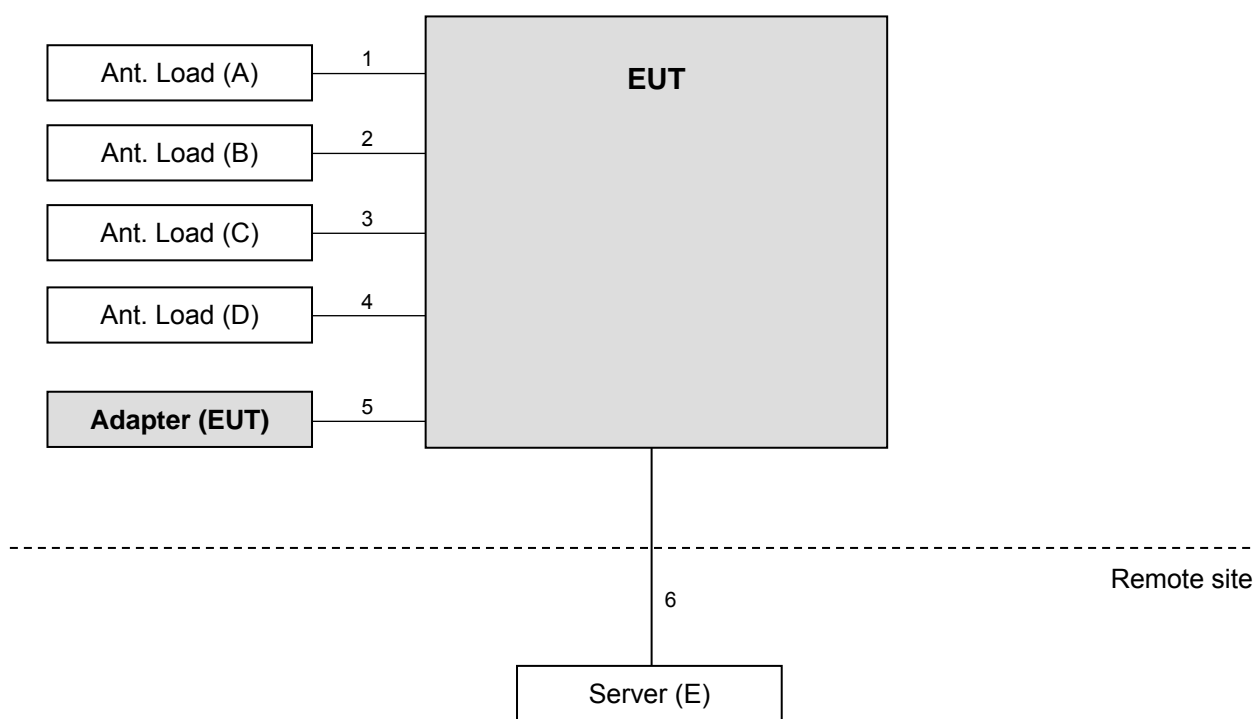

3.2.1 Description of Support Units

The EUT has been tested as an independent unit together with other necessary accessories or support units. The following support units or accessories were used to form a representative test configuration during the tests.

ID	Product	Brand	Model No.	Serial No.	FCC ID	Remarks
A.	Ant. Load	NA	NA	NA	NA	Provided by manufacturer
B.	Ant. Load	NA	NA	NA	NA	Provided by manufacturer
C.	Ant. Load	NA	NA	NA	NA	Provided by manufacturer
D.	Ant. Load	NA	NA	NA	NA	Provided by manufacturer
E.	Server	Nokia	ASIK	EA193380917	NA	Provided by manufacturer

Note:

1. All power cords of the above support units are non-shielded (1.8m).
2. Item E acted as a communication partner to transfer data.

ID	Descriptions	Qty.	Length (m)	Shielding (Yes/No)	Cores (Qty.)	Remarks
1.	Ant. Cable	1	0.3	Y	0	-
2.	Ant. Cable	1	0.3	Y	0	-
3.	Ant. Cable	1	0.3	Y	0	-
4.	Ant. Cable	1	0.3	Y	0	-
5.	DC Cable	1	0.55	N	0	Provided by manufacturer
6.	Fiber Cable	1	2	N	0	-

3.3 Test Mode Applicability and Tested Channel Detail

Pre-Scan has been conducted to determine the worst-case mode from all possible combinations between available modulations, data rates, XYZ axis and antenna ports. The worst case was found when positioned on X-plane. Following channel(s) was (were) selected for the final test as listed below:

LTE Band 25

Multi Carrier:

Test Condition	
LTE Band 25 QPSK (LTE(20M)+LTE(20M)+LTE(20M)+LTE(5M))	

EUT Configure Mode	Test item	Available channel	Tested Channel		Channel Bandwidth	Modulation	Mode
-	EIRP	8140 to 8665	8365 (1962.5MHz)	CH 8140 (1940.0MHz)+ CH 8340 (1960.0MHz)+ CH 8540 (1980.0MHz)+ CH 8665 (1992.5MHz)	65MHz	QPSK / 16QAM / 64QAM / 256QAM	Full RB
-	Frequency Stability	8140 to 8665	8365 (1962.5MHz)	CH 8140 (1940.0MHz)+ CH 8340 (1960.0MHz)+ CH 8540 (1980.0MHz)+ CH 8665 (1992.5MHz)	65MHz	QPSK	Full RB
-	Occupied Bandwidth	8140 to 8665	8365 (1962.5MHz)	CH 8140 (1940.0MHz)+ CH 8340 (1960.0MHz)+ CH 8540 (1980.0MHz)+ CH 8665 (1992.5MHz)	65MHz	QPSK / 16QAM / 64QAM / 256QAM	Full RB
-	Band Edge	8140 to 8665	8365 (1962.5MHz)	CH 8140 (1940.0MHz)+ CH 8340 (1960.0MHz)+ CH 8540 (1980.0MHz)+ CH 8665 (1992.5MHz)	65MHz	QPSK	Full RB
-	Peak to Average Ratio	8140 to 8665	8365 (1962.5MHz)	CH 8140 (1940.0MHz)+ CH 8340 (1960.0MHz)+ CH 8540 (1980.0MHz)+ CH 8665 (1992.5MHz)	65MHz	QPSK / 16QAM / 64QAM / 256QAM	Full RB
-	Conducted Emission	8140 to 8665	8365 (1962.5MHz)	CH 8140 (1940.0MHz)+ CH 8340 (1960.0MHz)+ CH 8540 (1980.0MHz)+ CH 8665 (1992.5MHz)	65MHz	QPSK	Full RB
-	Radiated Emission Below 1GHz	8140 to 8665	8365 (1962.5MHz)	CH 8140 (1940.0MHz)+ CH 8340 (1960.0MHz)+ CH 8540 (1980.0MHz)+ CH 8665 (1992.5MHz)	65MHz	QPSK	Full RB
-	Radiated Emission Above 1GHz	8140 to 8665	8365 (1962.5MHz)	CH 8140 (1940.0MHz)+ CH 8340 (1960.0MHz)+ CH 8540 (1980.0MHz)+ CH 8665 (1992.5MHz)	65MHz	QPSK	Full RB

Test Condition:

Test Item	Environmental Conditions	Input Power (system)	Tested By
EIRP	24deg. C, 64%RH	120Vac, 60Hz	James Yang
Modulation Characteristics	24deg. C, 64%RH	120Vac, 60Hz	James Yang
Frequency Stability	24deg. C, 64%RH	-48Vdc	James Yang
Occupied Bandwidth	24deg. C, 64%RH	120Vac, 60Hz	James Yang
Band Edge	24deg. C, 64%RH	120Vac, 60Hz	James Yang
Peak To Average Ratio	24deg. C, 64%RH	120Vac, 60Hz	James Yang
Conducted Emission	24deg. C, 64%RH	120Vac, 60Hz	James Yang
Radiated Emission	24deg. C, 68%RH	120Vac, 60Hz	Greg Lin

3.4 EUT Operating Conditions

The EUT makes a call to the communication simulator. The communication simulator station system controlled a EUT to export maximum output power under transmission mode and specific channel frequency

3.5 General Description of Applied Standards and References

The EUT is a RF Product. According to the specifications of the manufacturer, it must comply with the requirements of the following standards and References:

Test Standard:

FCC 47 CFR Part 2
FCC 47 CFR Part 24
ANSI/TIA/EIA-603-E 2016
ANSI 63.26-2015

All test items have been performed and recorded as per the above standards.

References Test Guidance:

KDB 971168 D01 Power Meas License Digital Systems v03r01

All test items have been performed as a reference to the above KDB test guidance.

4 Test Types and Results

4.1 Output Power Measurement

4.1.1 Limits of Output Power Measurement

Para. No. 24.232(a)(2) Base stations with an emission bandwidth greater than 1 MHz are limited to 1640 watts/MHz equivalent isotropically radiated power (EIRP) with an antenna height up to 300 meters

4.1.2 Test Procedures

Conducted Power Measurement:

The EUT was set up for the maximum power link data modulation and link up with spectrum. Set the EUT to transmit under low, middle and high channel and record the power level.

$EIRP = \text{Conducted power} + \text{antenna gain}$

4.1.3 Test Setup

Conducted Power Measurement:

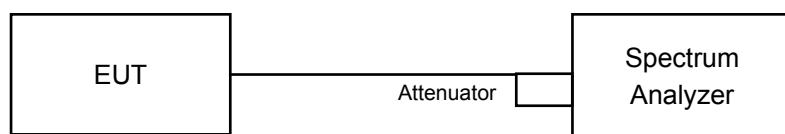

For the actual test configuration, please refer to the attached file (Test Setup Photo).

4.1.4 Test Results

LTE Band 25

Multi Carrier:

Conducted Output Power (dBm)

1TX

Band / BW	Chain	QPSK	16QAM	64QAM	256QAM
		Mid CH	Mid CH	Mid CH	Mid CH
		8365	8365	8365	8365
		1962.5 MHz	1962.5 MHz	1962.5 MHz	1962.5 MHz
LTE Band 25 / 65M	0	36.95	36.94	36.81	37.04
	1	37.35	36.85	36.91	36.74
	2	37.03	37.09	37.21	36.75
	3	36.98	37.28	36.73	37.10

2TX

Band / BW	Chain	QPSK	16QAM	64QAM	256QAM
		Mid CH	Mid CH	Mid CH	Mid CH
		8365	8365	8365	8365
		1962.5 MHz	1962.5 MHz	1962.5 MHz	1962.5 MHz
LTE Band 25 / 65M	0+1	40.16	39.91	39.87	39.90
	2+3	40.02	40.20	39.99	39.94

3TX

Band / BW	Chain	QPSK	16QAM	64QAM	256QAM
		Mid CH	Mid CH	Mid CH	Mid CH
		8365	8365	8365	8365
		1962.5 MHz	1962.5 MHz	1962.5 MHz	1962.5 MHz
LTE Band 25 / 65M	0+1+2	41.88	41.73	41.75	41.62

4TX

Band / BW	Chain	QPSK	16QAM	64QAM	256QAM
		Mid CH	Mid CH	Mid CH	Mid CH
		8365	8365	8365	8365
		1962.5 MHz	1962.5 MHz	1962.5 MHz	1962.5 MHz
LTE Band 25 / 65M	0+1+2+3	43.10	43.06	42.94	42.93

*All available TX Chain combination as below:

2TX:

1. Chain 0+ Chain 1
2. Chain 0+ Chain 2
3. Chain 0+ Chain 3
4. Chain 1+ Chain 2
5. Chain 1+ Chain 3
6. Chain 2+ Chain 3

The worst combination is Chain 0+Chain 1 & Chain 2+Chain 3, therefore they were chosen for the final test.

3TX:

1. Chain 0+ Chain 1+ Chain 2
2. Chain 0+ Chain 1+ Chain 3
3. Chain 1+ Chain 2+ Chain 3

The worst combination is Chain 0+Chain 1+Chain 2, therefore it was chosen for the final test.

EIRP Power (dBm)

1TX

Band / BW	Chain	QPSK	16QAM	64QAM	256QAM
		Mid CH	Mid CH	Mid CH	Mid CH
		8365	8365	8365	8365
		1962.5 MHz	1962.5 MHz	1962.5 MHz	1962.5 MHz
LTE Band 25 / 65M	0	49.45	49.44	49.31	49.54
	1	49.85	49.35	49.41	49.24
	2	49.53	49.59	49.71	49.25
	3	49.48	49.78	49.23	49.60

2TX

Band / BW	Chain	QPSK	16QAM	64QAM	256QAM
		Mid CH	Mid CH	Mid CH	Mid CH
		8365	8365	8365	8365
		1962.5 MHz	1962.5 MHz	1962.5 MHz	1962.5 MHz
LTE Band 25 / 65M	0+1	52.66	52.41	52.37	52.40
	2+3	52.52	52.70	52.49	52.44

3TX

Band / BW	Chain	QPSK	16QAM	64QAM	256QAM
		Mid CH	Mid CH	Mid CH	Mid CH
		8365	8365	8365	8365
		1962.5 MHz	1962.5 MHz	1962.5 MHz	1962.5 MHz
LTE Band 25 / 65M	0+1+2	54.38	54.23	54.25	54.12

4TX

Band / BW	Chain	QPSK	16QAM	64QAM	256QAM
		Mid CH	Mid CH	Mid CH	Mid CH
		8365	8365	8365	8365
		1962.5 MHz	1962.5 MHz	1962.5 MHz	1962.5 MHz
LTE Band 25 / 65M	0+1+2+3	55.60	55.56	55.44	55.43

Note: EIRP(dBm) = Conducted Output Power (dBm) + antenna gain (dBi)

*All available TX Chain combination as below:

2TX:

1. Chain 0+Chain 1
2. Chain 0+Chain 2
3. Chain 0+Chain 3
4. Chain 1+Chain 2
5. Chain 1+Chain 3
6. Chain 2+Chain 3

The worst combination is Chain 0+Chain 1 & Chain 2+Chain 3, therefore they were chosen for the final test.

3TX:

1. Chain 0+Chain 1+Chain 2
2. Chain 0+Chain 1+Chain 3
3. Chain 1+Chain 2+Chain 3

The worst combination is Chain 0+Chain 1+Chain 2, therefore it was chosen for the final test.

4.2 Modulation Characteristics Measurement

4.2.1 Limits of Modulation Characteristics

N/A

4.2.2 Test Procedure

Connect the EUT to Communication Simulator via the antenna connector, the frequency band is set as EUT supported Modulation and Channels, the EUT output is matched with 50 ohm load, the waveform quality and constellation of the EUT was tested.

4.2.3 Test Setup



4.2.4 Test Results

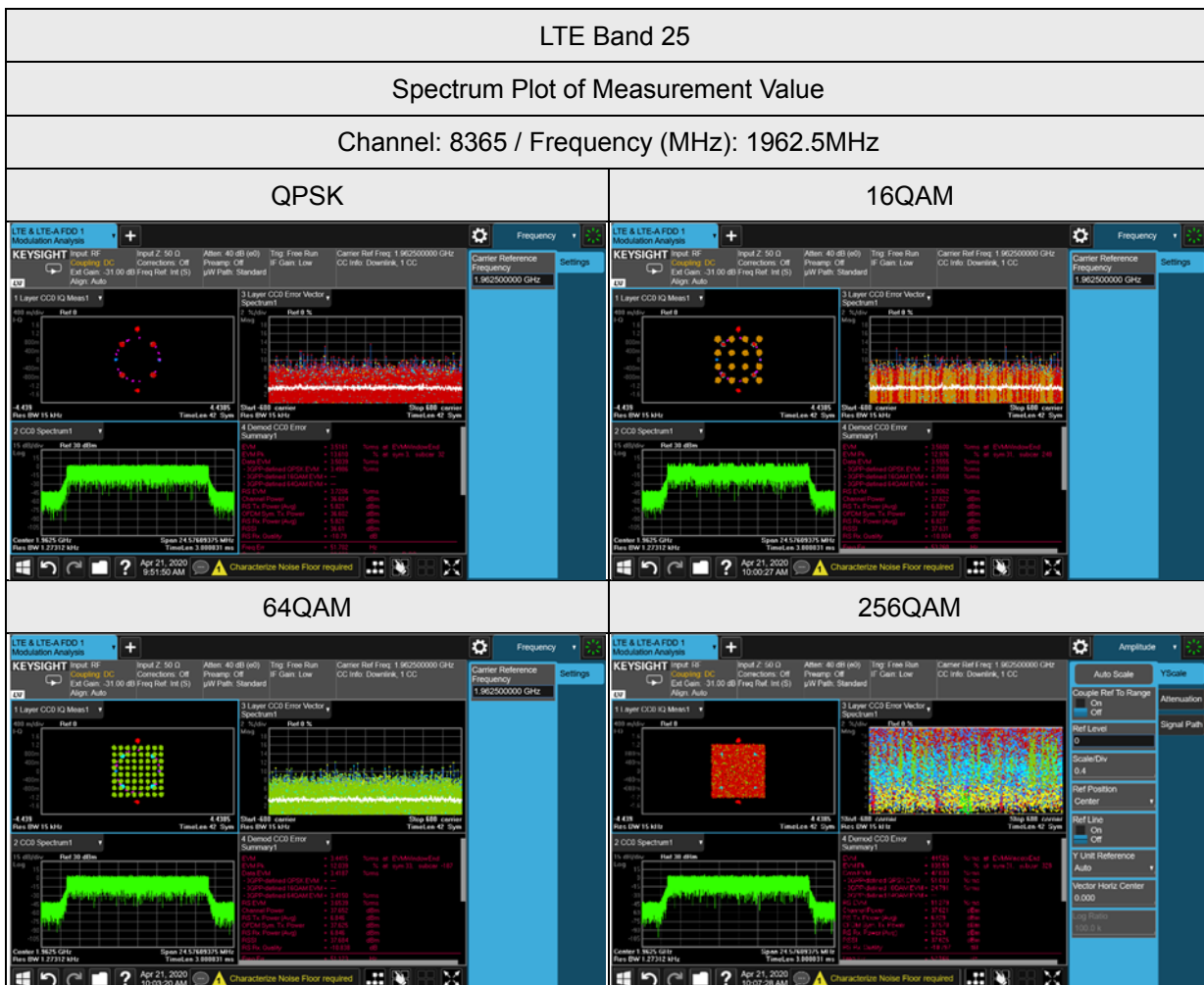

4.3 Frequency Stability Measurement

4.3.1 Limits of Frequency Stability Measurement

1.5 ppm is for base and fixed station.

4.3.2 Test Instruments

Description & Manufacturer	Model No.	Serial No.	Cal. Date	Cal. Due
Spectrum Analyzer ROHDE & SCHWARZ	FSP40	100040	Sep. 23, 2019	Sep. 22, 2020
WIT Standard Temperature And Humidity Chamber	TH-4S-C	W981030	Jun. 03, 2019	Jun. 02, 2020
Digital Multimeter Fluke	87-III	70360742	Jun. 27, 2019	Jun. 26, 2020
DC Power Supply Topward	6306A	727263	NA	NA
True RMS Clamp Meter / Fluke	325	31130711WS	May 21, 2019	May 20, 2020

4.3.3 Test Procedure

- Device is placed at the oven room. The oven room could control the temperatures and humidity. Power warm up is at least 15 min and power applied should perform before recording frequency error.
- EUT is connected the external power supply to control the DC input power. The test voltage range is from minimum to maximum working voltage. Each step shall be record the frequency error rate.
- The temperature range step is 10 degrees in this test items. All temperature levels shall be hold the ± 0.5 °C during the measurement testing. The each temperature step shall be at least 0.5 hours, consider the EUT could be test under the stability condition.

Note: The frequency error was recorded frequency error from the communication simulator.

4.3.4 Conducted Setup

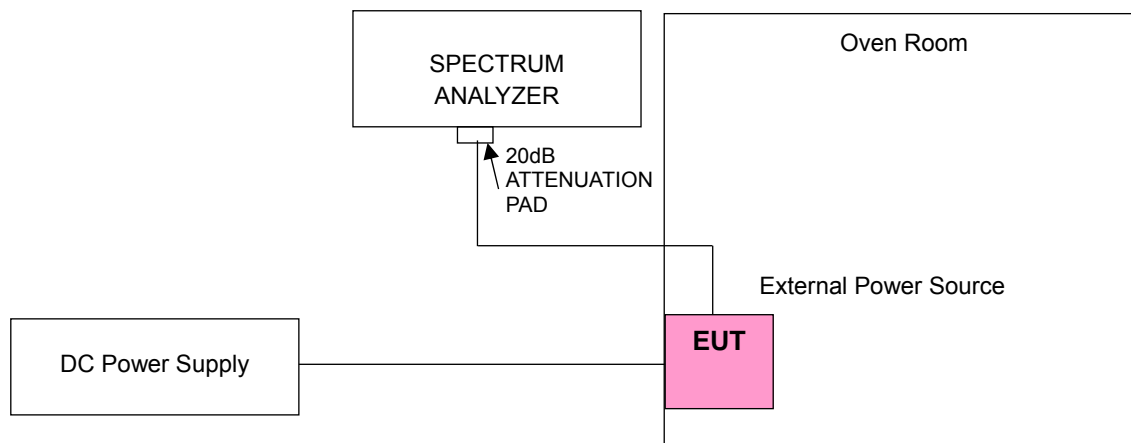

4.3.5 Test Results

Multi Carrier:

Frequency Error vs. Voltage

Voltage (Volts)	LTE Band 25	
	Channel Bandwidth: 65 MHz	
	Frequency (MHz)	Frequency Error (ppm)
-40.5	1962.500003	0.001
-48	1962.500003	0.001
-57.0	1962.500003	0.002

Note: The applicant defined the normal working voltage is from -40.5Vdc to -57.0Vdc.

Frequency Error vs. Temperature

Temp. (°C)	LTE Band 25	
	Channel Bandwidth: 65 MHz	
	Low Channel	
	Frequency (MHz)	Frequency Error (ppm)
-30	1962.500004	0.002
-20	1962.500002	0.001
-10	1962.500002	0.001
0	1962.500003	0.001
10	1962.500003	0.002
20	1962.499997	-0.002
30	1962.499997	-0.001
40	1962.499996	-0.002
50	1962.499997	-0.001

4.4 Occupied Bandwidth Measurement

4.4.1 Test Procedure

The EUT makes a call to the communication simulator. All measurements were done at low, middle and high operational frequency range. The communication simulator station system controlled a EUT to export maximum output power under transmission mode and specific channel frequency. Use OBW measurement function of Spectrum analyzer to measure 99 % occupied bandwidth.

4.4.2 Test Setup

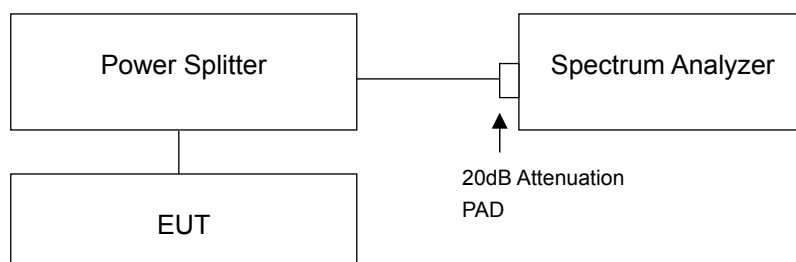

4.4.3 Test Result

Multi Carrier:

LTE Band 25, Channel Bandwidth 65MHz					
Channel	Frequency (MHz)	99% Occupied Bandwidth (MHz)			
		QPSK			
		Chain 0	Chain 1	Chain 2	Chain 3
8365	1962.5	63.35	63.37	63.37	63.36

LTE Band 25, Channel Bandwidth 65MHz					
Channel	Frequency (MHz)	99% Occupied Bandwidth (MHz)			
		16QAM			
		Chain 0	Chain 1	Chain 2	Chain 3
8365	1962.5	63.35	63.37	63.37	63.36

LTE Band 25, Channel Bandwidth 65MHz					
Channel	Frequency (MHz)	99% Occupied Bandwidth (MHz)			
		64QAM			
		Chain 0	Chain 1	Chain 2	Chain 3
8365	1962.5	63.35	63.36	63.37	63.36

LTE Band 25, Channel Bandwidth 65MHz					
Channel	Frequency (MHz)	99% Occupied Bandwidth (MHz)			
		256QAM			
		Chain 0	Chain 1	Chain 2	Chain 3
8365	1962.5	63.35	63.37	63.37	63.35

Spectrum Plot of Worst Value

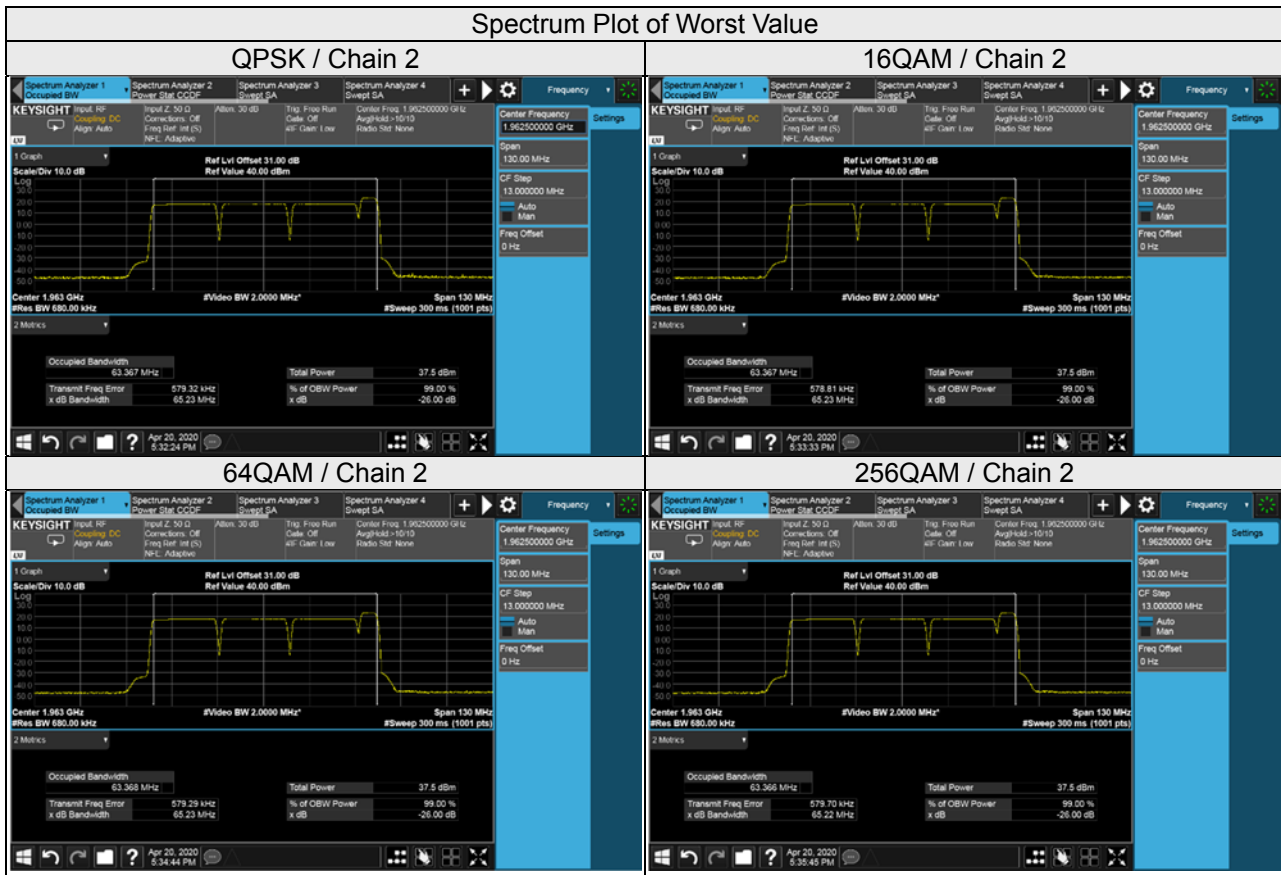

26dB Bandwidth
Multi Carrier:

LTE Band 25, Channel Bandwidth 65MHz					
Channel	Frequency (MHz)	26dBc Bandwidth (MHz)			
		QPSK			
		Chain 0	Chain 1	Chain 2	Chain 3
8365	1962.5	65.21	65.22	65.23	65.22

LTE Band 25, Channel Bandwidth 65MHz					
Channel	Frequency (MHz)	26dBc Bandwidth (MHz)			
		16QAM			
		Chain 0	Chain 1	Chain 2	Chain 3
8365	1962.5	65.22	65.22	65.23	65.22

LTE Band 25, Channel Bandwidth 65MHz					
Channel	Frequency (MHz)	26dBc Bandwidth (MHz)			
		64QAM			
		Chain 0	Chain 1	Chain 2	Chain 3
8365	1962.5	65.22	65.22	65.23	65.22

LTE Band 25, Channel Bandwidth 65MHz					
Channel	Frequency (MHz)	26dBc Bandwidth (MHz)			
		256QAM			
		Chain 0	Chain 1	Chain 2	Chain 3
8365	1962.5	65.22	65.23	65.22	65.22

Spectrum Plot of Worst Value

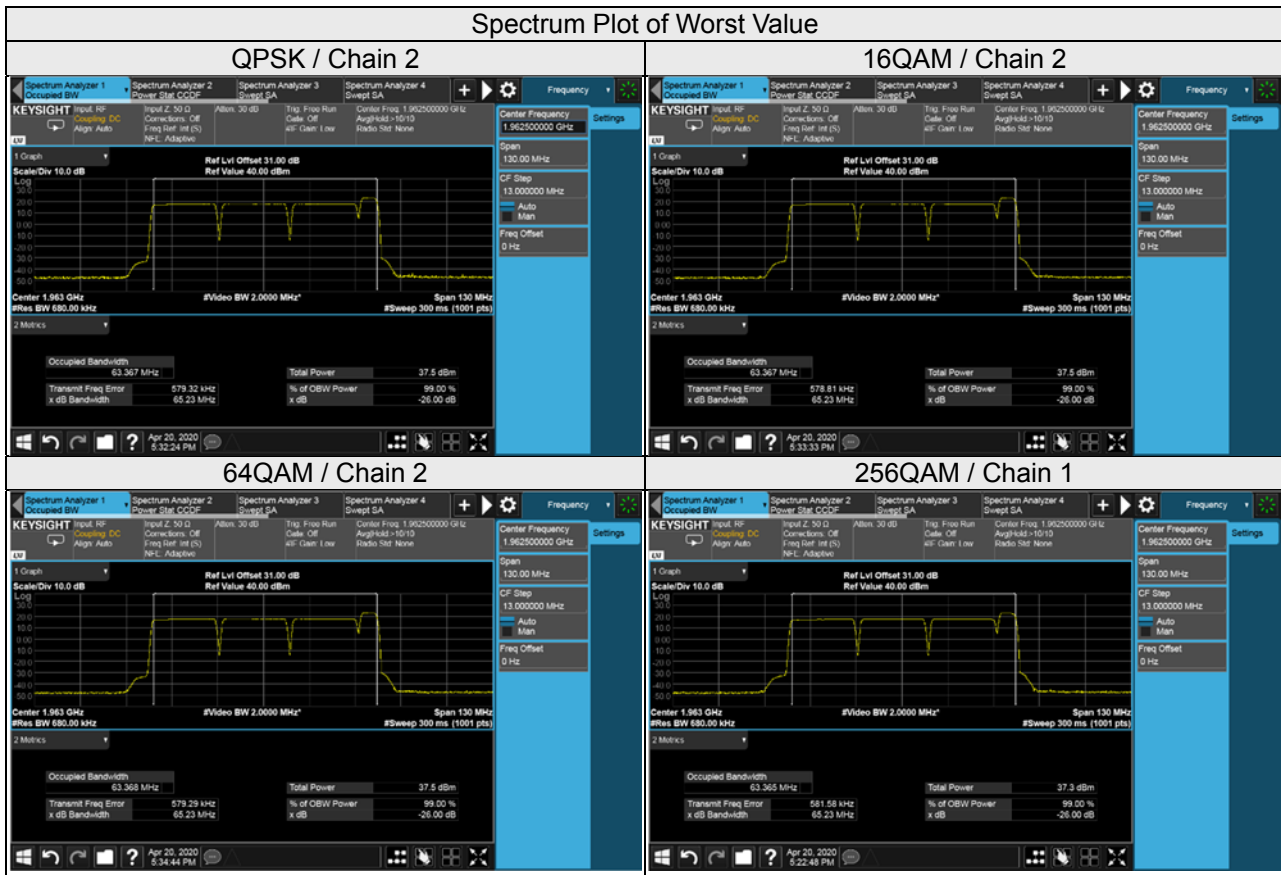

4.5 Band Edge Measurement

4.5.1 Limits of Band Edge Measurement

Power of any emission outside of the authorized operating frequency ranges must be attenuated below the transmitting power (P) by a factor of at least $43 + 10 \log(P)$ dB. In the 1 MHz bands immediately outside and adjacent to the frequency block a resolution bandwidth of at least one percent of the emission bandwidth of the fundamental emission of the transmitter may be employed.

Note:

This device can be implement MIMO function, so the limit of spurious emissions needs to be reduced by $10\log(\text{Numbers}_{\text{Ant}})$ according to FCC KDB 662911 D01 guidance.

4.5.2 Test Setup



4.5.3 Test Procedures

a. All measurements were done at low and high operational frequency range.

b. For Multi Carrier:

Multi-Carrier BW, extend the 1% range from 650kHz above and below the channel edge and then reduce the limit further by $10 \log(100/650) = -8.12\text{dB}$ (i.e. total $-19.02 + (-8.12) = -27.14\text{dBm}$) to compensate for the integration from 100kHz.

c. Record the max trace plot into the test report.

4.5.4 Test Results

Multi Carrier:

LTE Band 25, Channel Bandwidth 65MHz

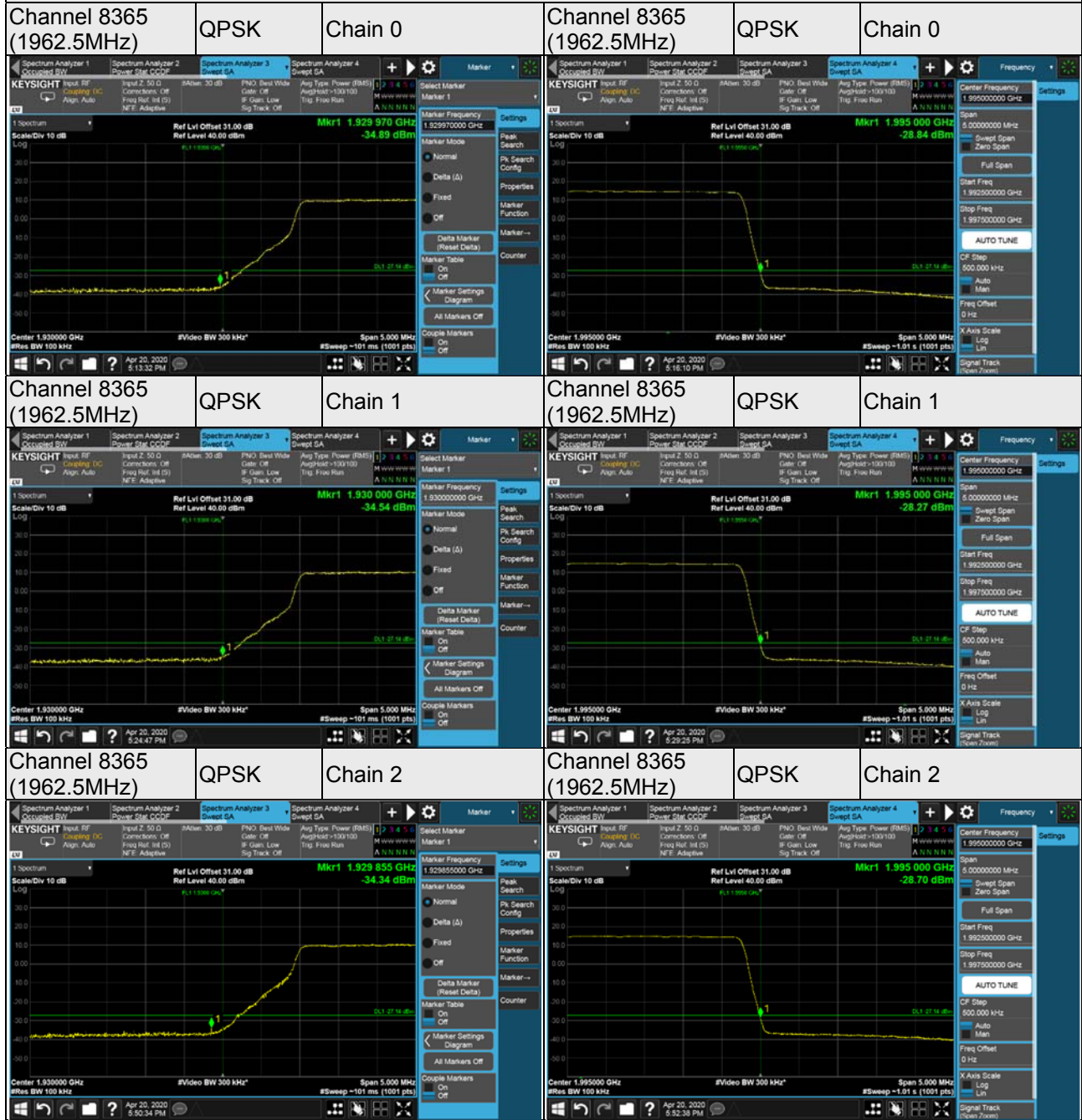

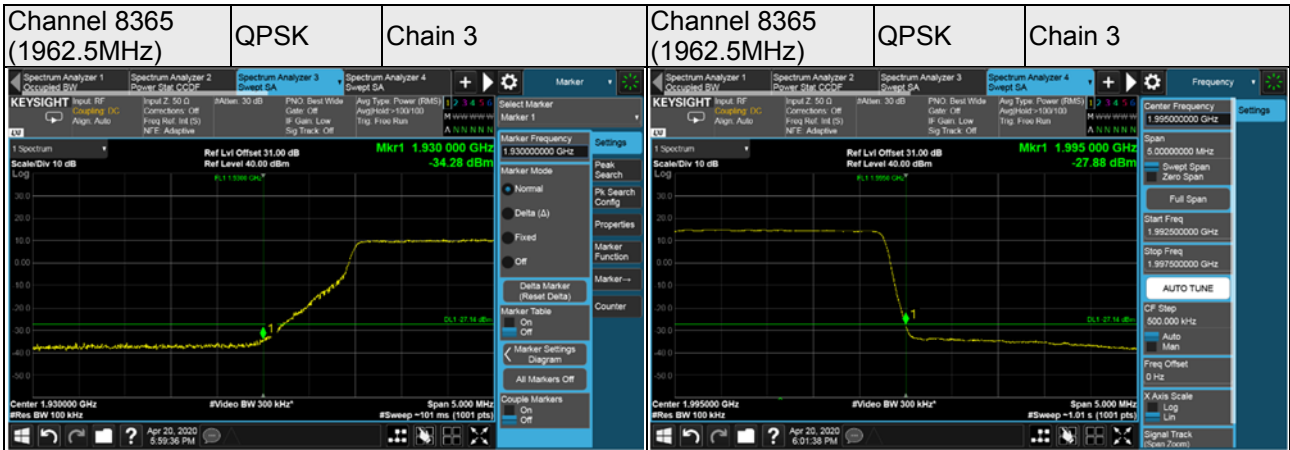

4.6 Peak to Average Ratio

4.6.1 Limits of Peak to Average Ratio Measurement

In measuring transmissions in this band using an average power technique, the peak to-average ratio (PAR) of the transmission may not exceed 13 dB

4.6.2 Test Setup

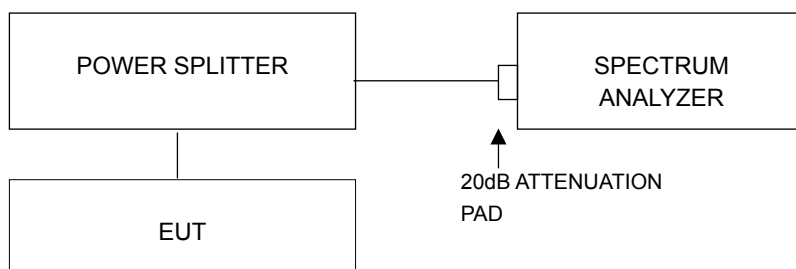

4.6.3 Test Procedures

- Set resolution/measurement bandwidth \geq signal's occupied bandwidth;
- Set the number of counts to a value that stabilizes the measured CCDF curve;
- Record the maximum PAPR level associated with a probability of 0.1%.

4.6.4 Test Results

Multi Carrier:

LTE Band 25, Channel Bandwidth 65MHz					
Channel	Frequency (MHz)	Peak To Average Ratio (dB)			
		QPSK			
		Chain 0	Chain 1	Chain 2	Chain 3
8365	1962.5	7.60	7.58	7.59	7.58

LTE Band 25, Channel Bandwidth 65MHz					
Channel	Frequency (MHz)	Peak To Average Ratio (dB)			
		16QAM			
		Chain 0	Chain 1	Chain 2	Chain 3
8365	1962.5	7.59	7.56	7.60	7.59

LTE Band 25, Channel Bandwidth 65MHz					
Channel	Frequency (MHz)	Peak To Average Ratio (dB)			
		64QAM			
		Chain 0	Chain 1	Chain 2	Chain 3
8365	1962.5	7.59	7.58	7.58	7.59

LTE Band 25, Channel Bandwidth 65MHz					
Channel	Frequency (MHz)	Peak To Average Ratio (dB)			
		256QAM			
		Chain 0	Chain 1	Chain 2	Chain 3
8365	1962.5	7.59	7.57	7.59	7.59

Spectrum Plot of Worst Value

QPSK / Chain 0

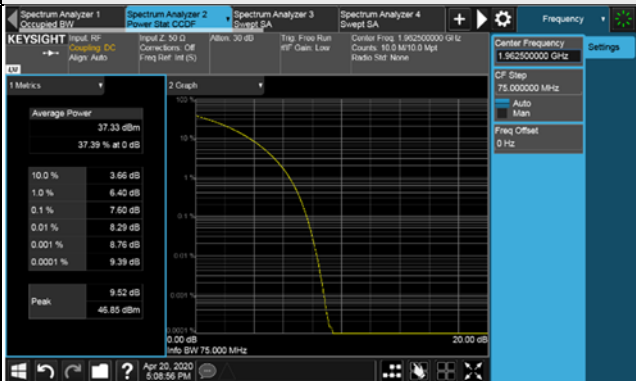

16QAM / Chain 2

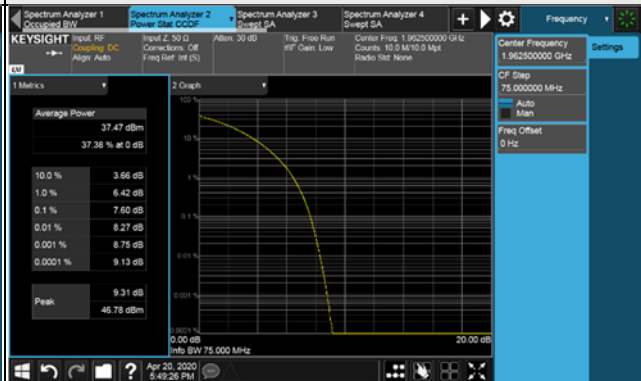

64QAM / Chain 3

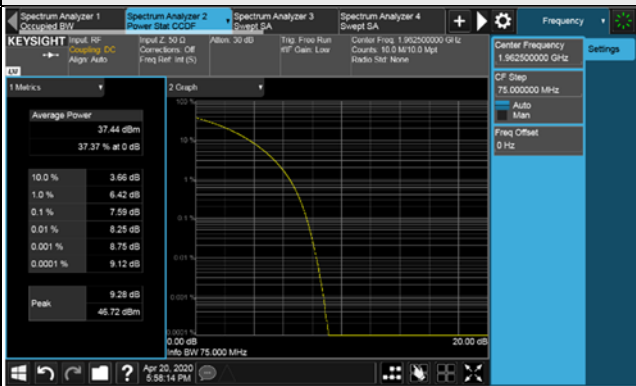

256QAM / Chain 3

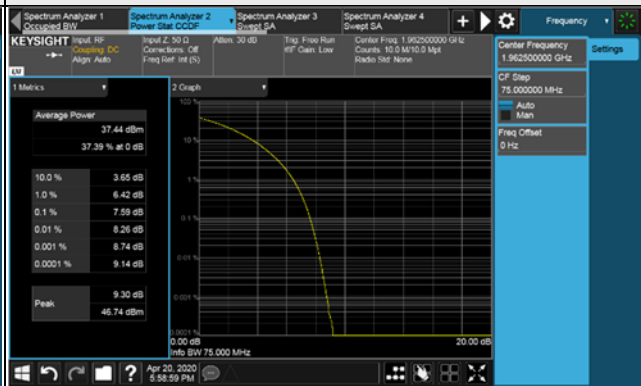

4.7 Conducted Spurious Emissions

4.7.1 Limits of Conducted Spurious Emissions Measurement

The power of any emission outside of the authorized operating frequency ranges must be attenuated below the transmitting power (P) by a factor of at least $43 + 10 \log(P)$ dB. The emission limit equal to -13dBm .

Note:

This device can be implement MIMO function, so the limit of spurious emissions needs to be reduced by $10\log(\text{Numbers}_{\text{Ant}})$ according to FCC KDB 662911 D01 guidance.

4.7.2 Test Setup

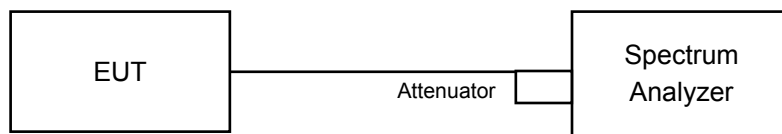

4.7.3 Test Procedure

- a. All measurements were done at low, middle and high operational frequency range.
- b. Measuring frequency range is from 9 kHz to 26.5GHz. 20dB attenuation pad is connected with spectrum. RBW=1MHz and VBW=3MHz is used for conducted emission measurement.

4.7.4 Test Results

Multi Carrier:

LTE Band 25, Channel Bandwidth 65MHz, Chain 0

Channel 8365 (1962.5MHz)

Frequency Range : 9kHz~1GHz

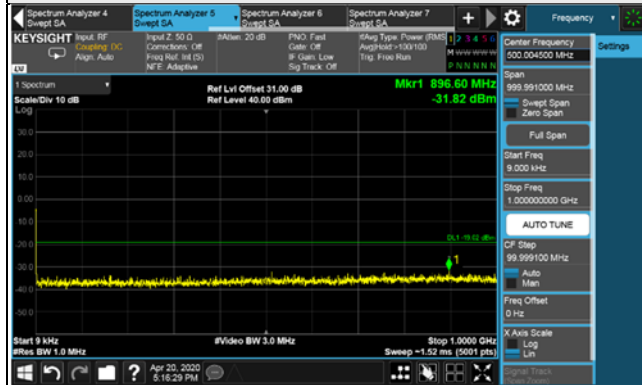

Frequency Range : 1GHz~18GHz

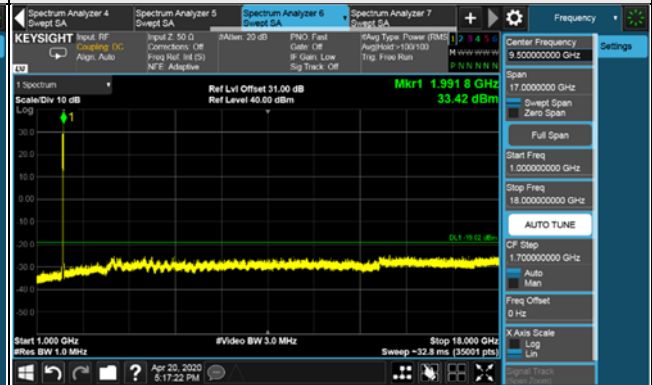

Frequency Range : 18GHz~26.5GHz



LTE Band 25, Channel Bandwidth 65MHz, Chain 1

Channel 8365 (1962.5MHz)

Frequency Range : 9kHz~1GHz

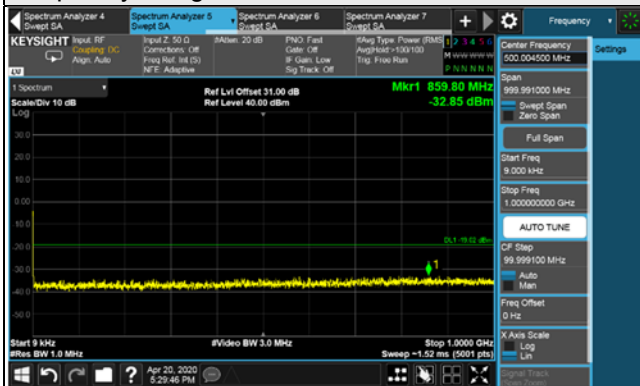

Frequency Range : 1GHz~18GHz

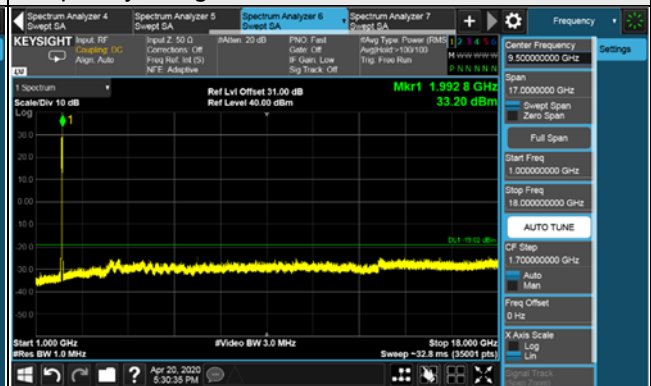

Frequency Range : 18GHz~26.5GHz

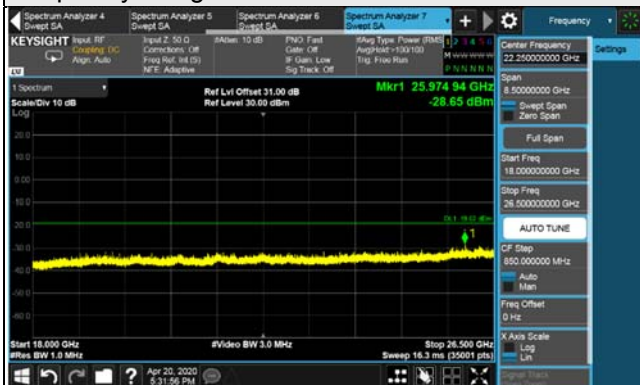

LTE Band 25, Channel Bandwidth 65MHz, Chain 2

Channel 8365 (1962.5MHz)

Frequency Range : 9kHz~1GHz

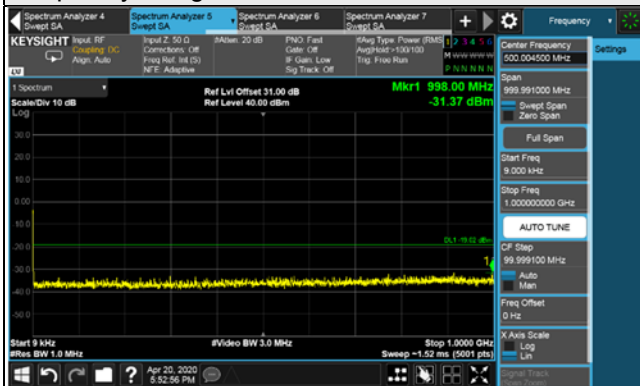

Frequency Range : 1GHz~18GHz

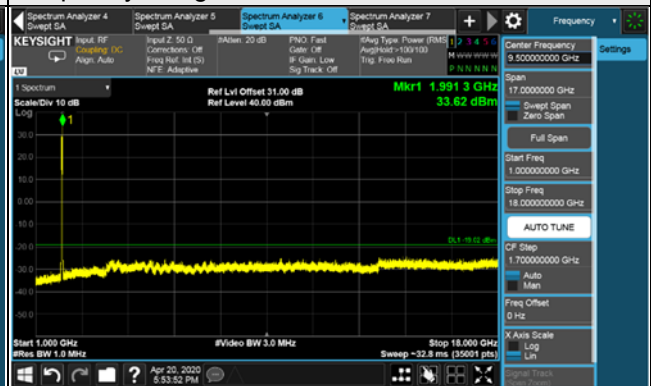

Frequency Range : 18GHz~26.5GHz

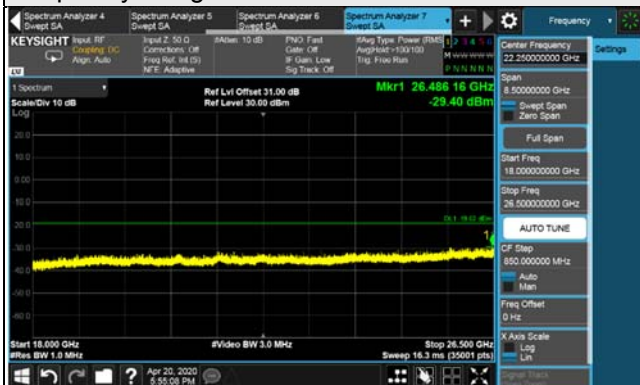

LTE Band 25, Channel Bandwidth 65MHz, Chain 3

Channel 8365 (1962.5MHz)

Frequency Range : 9kHz~1GHz

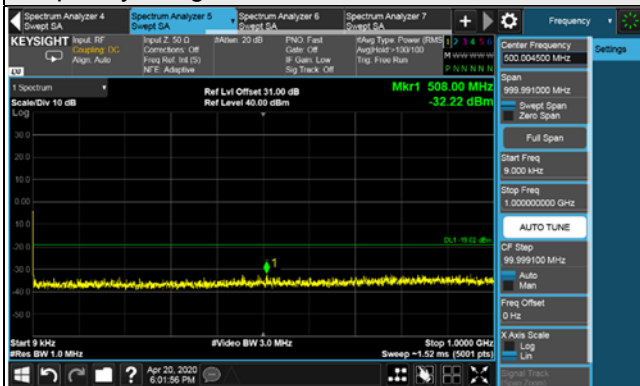

Frequency Range : 1GHz~18GHz

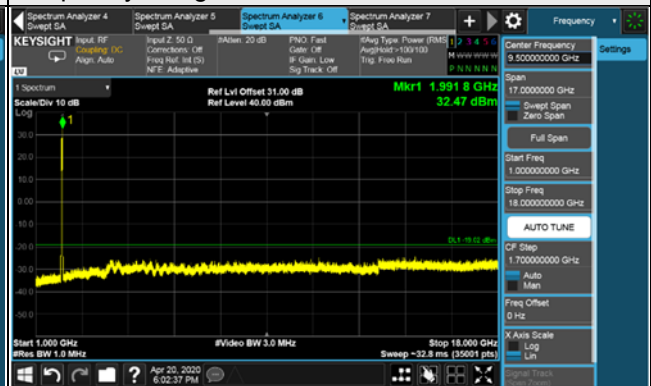

Frequency Range : 18GHz~26.5GHz



4.8 Radiated Emission Measurement

4.8.1 Limits of Radiated Emission Measurement

The power of any emission outside of the authorized operating frequency ranges must be attenuated below the transmitting power (P) by a factor of at least $43 + 10 \log(P)$ dB. The emission limit equal to -13dBm .

4.8.2 Test Procedure

- a. Substitution method is used for E.I.R.P measurement. In the semi-anechoic chamber, EUT placed on the 0.8m height of Turn Table, rotated the table around 360 degrees to search the maximum radiation power and receiver antenna shall be rotated vertical and horizontal polarization and moved height from 1m to 4m to find the maximum polar radiated power. The "Read Value" is the spectrum reading the maximum power value.
- b. The substitution horn antenna is substituted for EUT at the same position and signals generator export the CW signal to the substitution antenna via a TX cable. Rotated the Turn Table and moved receiving antenna to find the maximum radiation power. Adjust output power level of S.G to get a Value of spectrum reading equal to "Read Value" of step a. Record the power level of S.G
- c. $\text{EIRP} = \text{Output power level of S.G} - \text{TX cable loss} + \text{Antenna gain of substitution horn}$.
- d. E.R.P power can be calculated form E.I.R.P power by subtracting the gain of dipole, $\text{E.R.P power} = \text{E.I.R.P power} - 2.15\text{dBi}$.

NOTE: The resolution bandwidth and video bandwidth of test receiver/spectrum analyzer is 1MHz/3MHz.

4.8.3 Deviation from Test Standard

No deviation.

4.8.4 Test Setup

For radiated emission 30MHz to 1GHz

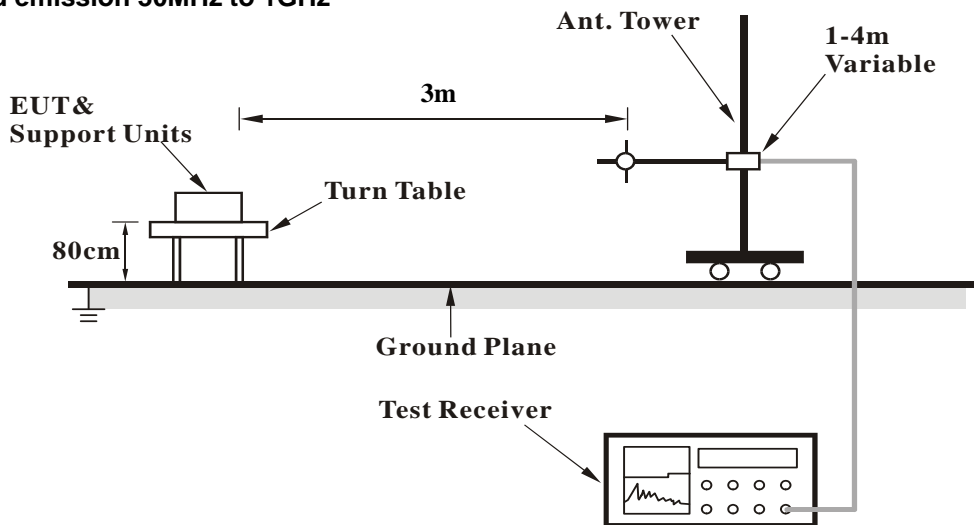

For radiated emission above 1GHz

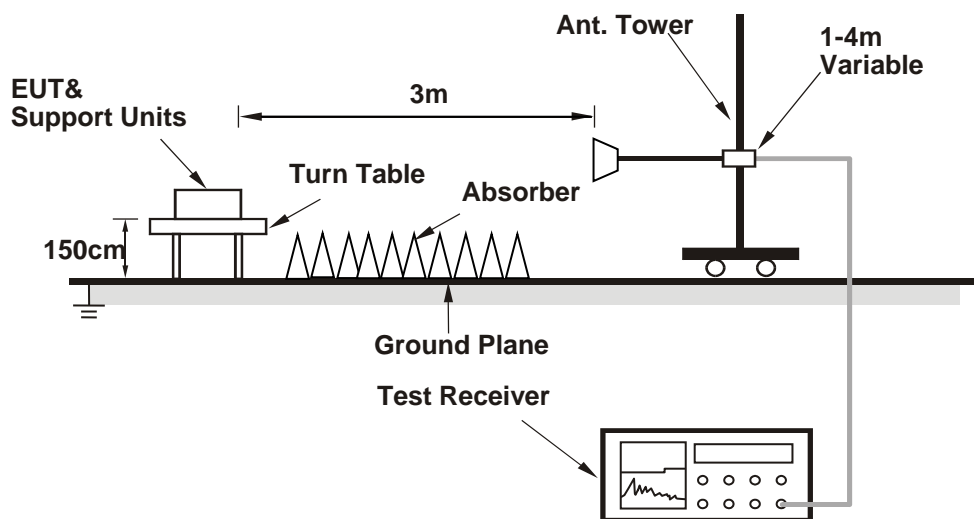

For the actual test configuration, please refer to the attached file (Test Setup Photo).

4.8.5 Test Results

Below 1GHz

LTE Band 25

Multi Carrier:

Channel Bandwidth: 65MHz

Mode	TX channel 8365 (1962.5MHz)	Frequency Range	Below 1000 MHz
Environmental Conditions	24deg. C, 68%RH	Input Power	120Vac, 60Hz
Tested By	Greg Lin		

Antenna Polarity & Test Distance: Horizontal at 3 M							
No.	Freq. (MHz)	Reading (dBm)	S.G Power Value (dBm)	Correction Factor (dB)	EIRP (dBm)	Limit (dBm)	Margin (dB)
1	41.64	-32.0	-17.6	-12.3	-29.9	-13.0	-16.9
2	80.44	-33.0	-38.4	0.5	-37.9	-13.0	-24.9
3	134.76	-31.1	-33.9	-3.2	-37.1	-13.0	-24.1
4	212.36	-44.6	-51.0	-2.1	-53.1	-13.0	-40.1
5	416.06	-62.2	-65.6	3.4	-62.2	-13.0	-49.2
6	840.92	-68.1	-65.1	3.7	-61.4	-13.0	-48.4

Remarks:

1. EIRP (dBm) = S.G Value (dBm) + Correction Factor (dB).
2. Correction Factor (dB) = Substitution Antenna Gain (dB) + Cable Loss (dB).

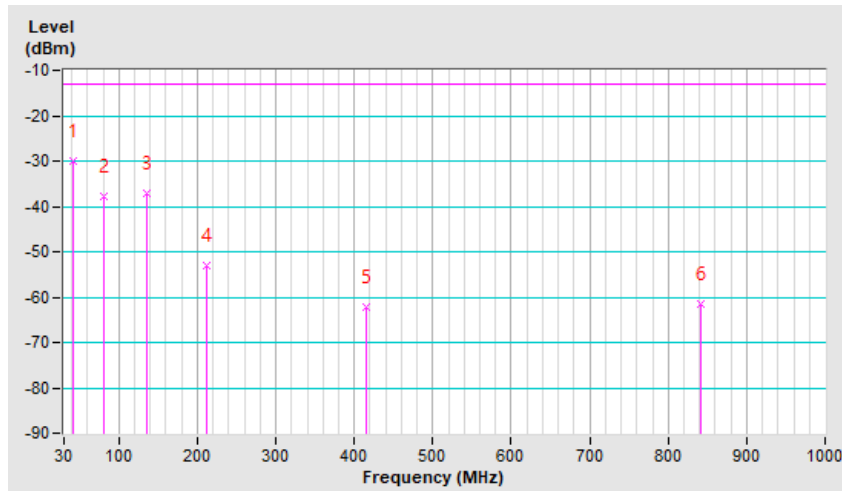

Mode	TX channel 8365 (1962.5MHz)	Frequency Range	Below 1000 MHz
Environmental Conditions	24deg. C, 68%RH	Input Power	120Vac, 60Hz
Tested By	Greg Lin		

Antenna Polarity & Test Distance: Vertical at 3 M							
No.	Freq. (MHz)	Reading (dBm)	S.G Power Value (dBm)	Correction Factor (dB)	EIRP (dBm)	Limit (dBm)	Margin (dB)
1	58.13	-16.7	-19.4	-4.2	-23.6	-13.0	-10.6
2	114.39	-34.2	-38.7	-2.8	-41.5	-13.0	-28.5
3	175.50	-31.1	-32.0	-2.8	-34.8	-13.0	-21.8
4	215.27	-45.6	-47.3	-2.0	-49.3	-13.0	-36.3
5	386.96	-52.0	-56.1	3.5	-52.6	-13.0	-39.6
6	820.55	-67.4	-64.0	3.9	-60.1	-13.0	-47.1

Remarks:

1. EIRP (dBm) = S.G Value (dBm) + Correction Factor (dB).
2. Correction Factor (dB) = Substitution Antenna Gain (dB) + Cable Loss (dB).

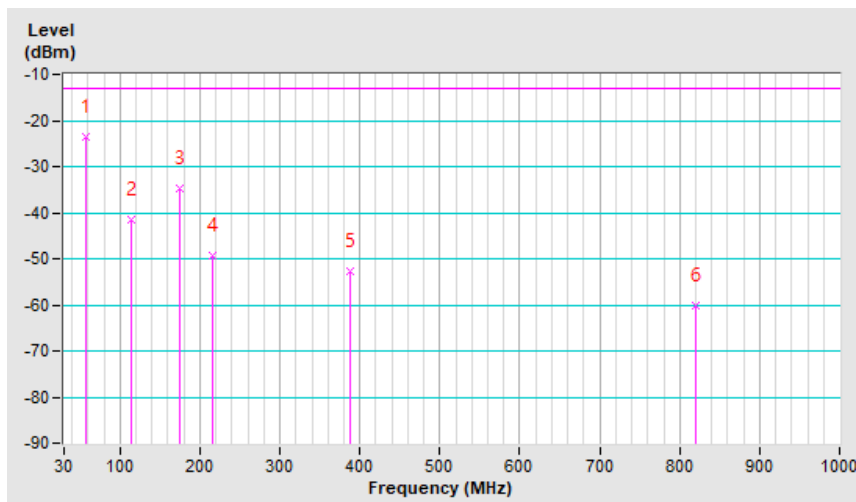

Above 1GHz
 LTE Band 25
Multi Carrier:

Mode	TX channel 8365 (1962.5MHz)	Frequency Range	1GHz ~ 20GHz
Environmental Conditions	24deg. C, 68%RH	Input Power	120Vac, 60Hz
Tested By	Greg Lin		

Antenna Polarity & Test Distance: Horizontal at 3 M							
No.	Freq. (MHz)	Reading (dBm)	S.G Power Value (dBm)	Correction Factor (dB)	EIRP (dBm)	Limit (dBm)	Margin (dB)
1	3925.00	-62.2	-53.7	1.3	-52.4	-13.0	-39.4
Antenna Polarity & Test Distance: Vertical at 3 M							
No.	Freq. (MHz)	Reading (dBm)	S.G Power Value (dBm)	Correction Factor (dB)	EIRP (dBm)	Limit (dBm)	Margin (dB)
1	3925.00	-60.4	-51.7	1.3	-50.4	-13.0	-37.4

Remarks:

1. EIRP (dBm) = S.G Value (dBm) + Correction Factor (dB).
2. Correction Factor (dB) = Substitution Antenna Gain (dB) + Cable Loss (dB).

5 Pictures of Test Arrangements

Please refer to the attached file (Test Setup Photo).

Appendix – Information of the Testing Laboratories

We, Bureau Veritas Consumer Products Services (H.K.) Ltd., Taoyuan Branch, were founded in 1988 to provide our best service in EMC, Radio, Telecom and Safety consultation. Our laboratories are FCC recognized accredited test firms and accredited and approved according to ISO/IEC 17025.

If you have any comments, please feel free to contact us at the following:

Lin Kou EMC/RF Lab

Tel: 886-2-26052180

Fax: 886-2-26051924

Hsin Chu EMC/RF/Telecom Lab

Tel: 886-3-6668565

Fax: 886-3-6668323

Hwa Ya EMC/RF/Safety Lab

Tel: 886-3-3183232

Fax: 886-3-3270892

Email: service.adt@tw.bureauveritas.com

Web Site: www.bureauveritas-adt.com

The address and road map of all our labs can be found in our web site also.

--- END ---