

Global Product Compliance Laboratory
600-700 Mountain Avenue
Room 5B-108
Murray Hill, New Jersey 07974-0636 USA



TESTING
NVLAP LAB CODE: 100275-0

FCC Certification Part 30 Test Report

Product Evaluated

**AEWF 39 GHz 3rd Gen - 8Carrier
FCC ID: VBNAEWF-01**

Customer

**Nokia Solutions and Networks US LLC
3201 Olympus Boulevard
Dallas, Texas 75019 USA**

Test Laboratory

Nokia Bell Labs

Nokia, Global Product Compliance Laboratory

**600-700 Mountain Avenue, Rm 5B-108
Murray Hill, New Jersey 07974-0636 USA**

Date: August 26, 2020

This report shall not be reproduced, in whole or in part without the approval of Nokia Global Product Compliance Laboratory. This report must not be used by the recipient to claim product endorsement by NVLAP or any other agency of the U.S. Government.

Revisions

Date	Revision	Section	Change
8/25/2020	0		Initial Release
8/26/2020	1		Cover information. Reference information Page 5

Nokia Global Product Compliance Laboratory represents to the client that testing was done in accordance with standard procedures as applicable, and that reported test results are accurate within generally accepted commercial ranges of accuracy in accordance with the scope of our NVLAP Accreditation. Nokia Global Product Compliance reports only apply to the specific samples tested. This report is the property of the client. This report shall not be reproduced except in full without the written approval of the Nokia Global Product Compliance Laboratory.

Nokia Global Product Compliance Laboratory is accredited with the US Department of Commerce National Institute of Standards and Technology's National Voluntary Laboratory Accreditation Program (NVLAP) for satisfactory compliance with criteria established in Title 15, Part 7 Code of Federal Regulations for offering test services for selected test methods in Electromagnetic Compatibility; Voluntary Control Council for Interference (VCCI), Japan; Australian Communications and Media Authority (ACMA). The laboratory is ISO 9001:2008 Certified.

Nokia Global Product Compliance Laboratory represents to the client that the laboratory's accreditation or any of its calibration or test reports in no way constitutes or implies product certification, approval, or endorsement by NVLAP, NIST, or any agency of the federal government.

Prepared & Reviewed By: W. Steve Majkowski NCE

Approved By: Ray Johnson



8/26/2020



8/26/2020

Product Certification Filing Lead
Nokia Bell Labs
Nokia, Global Product Compliance Laboratory

Technical Manager
Nokia Bell Labs
Nokia, Global Product Compliance Laboratory

Prepared By: Ann Chang



8/26/2020

Compliance Engineer
Nokia Bell Labs
Nokia, Global Product Compliance Laboratory

Table of Contents

- 1. ATTESTATION OF TEST RESULTS 5**
- 2. SUMMARY OF THE TEST RESULTS 7**
 - 2.1 MEASUREMENT UNCERTAINTY 7
- 3. GENERAL INFORMATION 8**
 - 3.1 PRODUCT DESCRIPTIONS 8
 - 3.2 EIRP/ PSD COMPLIANCE AND ANTENNA INFORMATION. 9
 - 3.3 ANTENNA FAR FIELD DETERMINATION DISTANCE 9
- 4. REQUIRED MEASUREMENTS AND RESULTS..... 10**
 - 4.1 SECTION 2.1046 MEASUREMENT REQUIRED: RF POWER OUTPUT 11
 - 4.1.1 *RF Power Output Measurement* 11
 - 4.1.1.1 RF Power Output Results 12
 - 4.2 SECTION 2.1047 MEASUREMENT REQUIRED: MODULATION CHARACTERISTICS 16
 - 4.2.1 *Modulation Characteristics Measurement* 16
 - 4.2.2 *Modulation Measurements Results:* 16
 - 4.3 SECTION 2.1049 MEASUREMENT REQUIRED: OCCUPIED BANDWIDTH AND EDGE OF BAND EMISSIONS . 18
 - 4.3.1 *Results Occupied Bandwidth (Signal Bandwidth)*..... 18
 - 4.3.1.1 99% Signal Bandwidth 10 MHz RBW Plots 20
 - 4.3.2 *Occupied Bandwidth-Edge of Block Emissions*..... 26
 - 4.3.3 *Requirements 28 GHz Emissions Limits*..... 26
 - 4.3.4 *Measurement Offset and MIMO*..... 26
 - 4.3.5 *Mask Parameters*..... 26
 - 4.3.6 *Measurement Path Adjustments*..... 27
 - 4.3.7 *Edge of Band Measurements* 28
 - 4.3.7.1 Results - Occupied Bandwidth-Edge of Block Emissions 28
 - 4.4 SECTION 2.1051 MEASUREMENT REQUIRED: SPURIOUS EMISSIONS AT THE ANTENNA TERMINALS 32
 - 4.4.1 *Section 2.1051 Spurious Emissions at Antenna Terminals* 32
 - 4.4.2 *Required Limit*..... 32
 - 4.4.3 *Results*..... 32
 - 4.5 SECTION 2.1053 MEASUREMENT REQUIRED: FIELD STRENGTH OF SPURIOUS RADIATION 33
 - 4.5.1 *Spurious Radiation and Radiated Emissions Requirements.* 33
 - 4.5.2 *Radiated Spurious Emissions Measurements: 40 GHz - 100 GHz*..... 34
 - 4.5.2.1 Bandwidth Limits and Corrections: Radiated Measurements 40 GHz - 100 GHz..... 35
 - 4.5.2.2 Resolution Bandwidth and # of Points: 35
 - 4.5.2.3 Part 30 Limit: 35
 - 4.5.2.4 Emissions Corrections 35
 - 4.5.3 *Field Strength of Spurious Radiation Results:* 37
 - 4.5.4 *Transmitter Measurements of Radiated Spurious Emissions* 39
 - 4.6 SECTION 2.1055 MEASUREMENT NOT REQUIRED: FREQUENCY STABILITY 59
 - 4.6.1 *Frequency Stability Results:* 59
 - 4.6.2 *Frequency Stability – Original Results:* 59
 - 4.7 LIST OF TEST EQUIPMENT..... 60
 - 4.7.1 *List of Radio Measurements and Radiated Emissions Test Equipment*..... 60
 - 4.8 PHOTOGRAPHS OF THE TEST SETUPS 62
 - 4.9 FACILITIES AND ACCREDITATION 68

5. APPENDIX A - CALIBRATION CERTIFICATES..... 70

1. ATTESTATION OF TEST RESULTS

Company Name	Nokia Solutions and Networks, OY 2000 Lucent Lane Naperville, Illinois 60563
FCC ID	VBNAEWF-01
Product Name	AirScale 39 GHz Radio Unit (AEWF) Band 30 (AEWF 39 GHz RRH - 8 Carrier)
Model Name	AEWF
Part No	474870A.X21
Serial Number(s)	L1183608589
Test Standard(s)	<ul style="list-style-type: none"> • 47 CFR FCC Parts 2 • KDB 971168 D01 Power Measurement License Digital Systems v03r01 April 9, 2018 • KDB 662911 D01 Multiple Transmitter Output v02r01 Oct 2013 • KDB 842590 D01 Upper Microwave Flexible Use Service v01r01 - April 3, 2020. • Procedures on TRP Compliance for Out of Band and Spurious Emissions C63.26 mmWave JTG - Version # 1 July 14th 2018
Reference(s)	<ul style="list-style-type: none"> • 47 CFR FCC Part 2 and Part 30 • ANSI C63.26 (2015) • ANSI C63.4 (2014) • TR 14-1001, MMW Measurements with Harmonic Mixers (April-4-2014)
Frequency Band	(Tx: 37 – 40.0 GHz), NR Band n260
Technology	5G-New Radio, LTE-TDD: 100M0G7W
Test Frequency Range	30 MHz – 200 GHz
Operation Mode(s)	2x 54dBm EIRP, 57 dBm EIRP Total. MIMO, 1 to 8 Carriers
Submission Type	Class II Change
FCC Part 15 Subpart B	Compliance with Class B
Test Date	July 30, 2020 - August 21, 2020
Test Laboratory	Nokia Global Product Compliance Laboratory 600-700 Mountain Avenue, Rm 5B-108 Murray Hill, New Jersey 07974-0636 USA NVLAP Lab Code: 100275-0 FCC Registration Number: 395774

This is to certify that the above product has been evaluated and found to be in compliance with the Rules and Regulations set forth in the above standard(s). The data and the descriptions about the test setup, procedures and configuration presented in this report are accurate. The results of testing in this report apply only to the product/system which was tested. Other similar equipment will not necessarily produce the same results due to production tolerance and measurement uncertainties.

Per the requirement of Section 2.911(d) Certification of Technical Test Data, I hereby certify that the technical test data are the results of tests either performed or supervised by me.

W. Steve Majkowski NCE
Member of Technical Staff
Nokia, Global Product Compliance Laboratory

2. SUMMARY OF THE TEST RESULTS

47 CFR FCC Sections	Description of Tests	Compliance Results
2.1046, 30.202 (a)	RF Power Output	Pass
2.1047,	Modulation Characteristics	Pass
2.1049, 30.203	(a) Occupied Bandwidth (b) Edge-of-Band Emissions	Pass
2.1051, 30.203	Spurious Emissions at Antenna Terminals - Radiated	Pass
2.1053, 30.203	Field Strength of Spurious Radiation	Pass
2.1055,	Measurement of Frequency Stability	Not Required*

* The measurement of frequency stability was performed during the original filing tests. There has been no change to the frequency generating and stabilizing circuitry. Additional frequency stability testing is therefore not required.

2.1 Measurement Uncertainty

The results of the calculations to estimate uncertainties for the several test methods and standards are shown in the Tables below. These are the worst-case values.

Worst-Case Estimated Measurement Uncertainties

Standard, Method or Procedure	Condition	Frequency MHz	Expanded Uncertainty (k=2)
a. Classical Emissions, (e.g., ANSI C63.4, CISPR 11, 14, 22, etc., using ESHS 30,	Conducted Emissions	0.009 - 30	±3.5 dB
	Radiated Emissions (AR-8 Semi-Anechoic Chamber)	30 MHz – 200MHz H	±5.4 dB
		30 MHz – 200 MHz V	±5.4 dB
		200 MHz – 1000 MHz H	±4.7 dB
		200 MHz – 1000 MHz V	±4.7 dB
	1 GHz- 18 GHz	±3.3 dB	

Antenna Port Test	Signal Bandwidth	Frequency Range	Expanded Uncertainty (k=2), Amplitude
Occupied Bandwidth, Edge of Band,	10 Hz 100 Hz 10 kHz to 1 MHz 1MHz to 100 MHz	9 kHz to 20 MHz 20 MHz to 1 GHz 1 GHz to 10 GHz 10 GHz to 40 GHz:	±2.2 dB
Conducted Spurious Emissions	30 kHz to 100 MHz	10 MHz to 40 GHz:	±2.8 dB
RF Power, Channel Power	10 Hz to 100 MHz	10 MHz to 40 GHz	±1.4 dB

3. GENERAL INFORMATION

3.1 Product Descriptions

The equipment under test (EUT) has the following specifications.

Table 3.1.1 Product Specifications

Specification Items	Description
Product Type	Compact Base Station LTE Module (2Tx, 2Rx), 2x2 MIMO
Radio Type	Intentional Transceiver
Power Type	-48V DC
Modulation	5G New Radio LTE-TDD with QPSK, 16QAM and 64QAM
Operating Frequency Range	TDD (Tx/Rx: 37.0-40.0 GHz),
Channel Bandwidth	800 MHz,
Max Radiated Power (EIRP)	54 dBm EIRP per polarizations; based upon 28 dBm Tx output. 57 dBm EIRP Total for the two polarizations.
Antenna Gain	29 dBi
Operating Mode	2x2 MIMO (2 duplex Tx/Rx Ports)
Software Version	5G20B
Hardware Version	474870A.X21
Antenna(s)	Refer to Section 3.2

The EUT supports the following carrier configurations:

Table 3.1.2 EUT Supported Configurations

Carrier Bandwidth (MHz)	Carriers per Path	MIMO Modes	Signal Type	Modulation
100	1	2x	LTE-TDD	QPSK, 16QAM & 64QAM

3.2 EIRP/ PSD Compliance and Antenna Information.

The product incorporates integrated antennas. Externally mounted antennas cannot be attached to the unit or mounted remotely. The units integrated antennas are electronically steerable with a maximum gain of 29 dBi. There are two antenna assembly boards inside the product. Each antenna assembly board is a pair of 16x16 matrix (a transmit matrix and a receive matrix with 256 elements each). One assembly board is vertically polarized, and the second assembly board is horizontally polarized. The antennas nominal RF drive level is 28 dBm. The 28 dBm RF power and 29 dBi gain results in a 54 dBm EIRP per assembly. The sum of the two 54 dBm EIRP beams results in a maximum EIRP of 57 dBm. Antenna Gain vs frequency is detailed in Exhibit 6 of the filing package.

3.3 Antenna Far Field Determination Distance

The Moongilan Test (1) was performed to determine the far field boundary location using calculations and low power measurements. For the antenna array we can calculate the Fraunhofer distance from

$$d_{ff} = 2D^2/\lambda$$

where d_{ff} = Far Field distance in meters,

D is the maximum size of the radiating array

λ = wavelength of the operating signal in meters

The antenna patch height is 15 mm and 7.6 mm wide and the patches are 15 cm apart.

At 39 GHz the 15 cm dimension results in a far field distance d_{ff} of 5.85 meters.

At 39 GHz the 7.6 cm dimension results in a far field distance d_{ff} of 1.50 meters.

Measurements for the Moongilan Test were performed at low power using a standard gain horn antenna. In the horizontal polarization the determined boundary was 4 m.

To eliminate any inconsistency all Power, OBW and OOB measurements were made at 4.5 m.

(1) The Moongilan Test is named in honor of the late Dheena Moongilan who discovered it and formulated its use into C63.26.

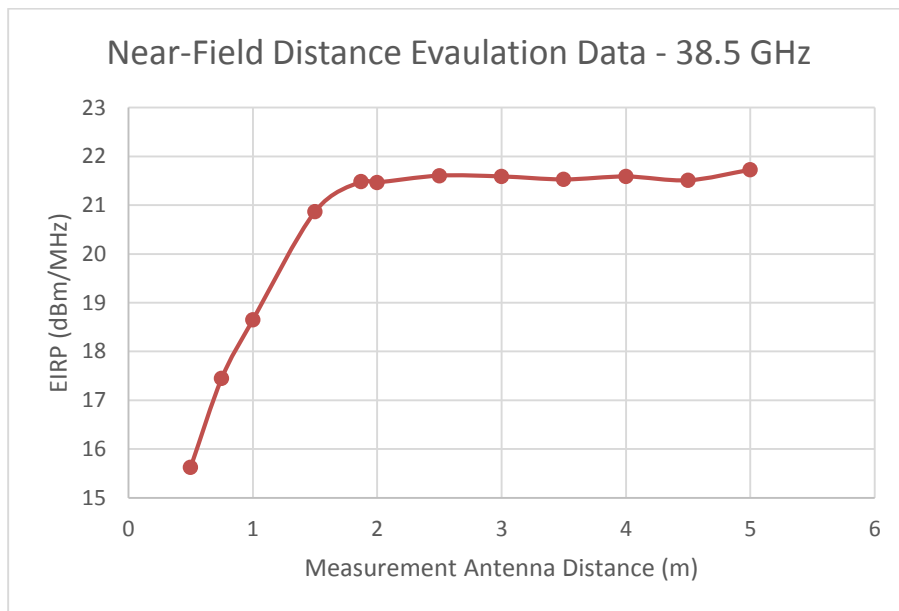

4. REQUIRED MEASUREMENTS AND RESULTS

Per 47CFR FCC Section 2.1033(c)(14), the following certification tests are required by Section 2.1046 through Section 2.1057. These tests are identified in Table 4.0a below.

Table 4.0a Required Certification Measurements

47 CFR FCC Sections	Description of Tests	Test Required for Class II Authorization
2.1046, 30.202 (a)	RF Power Output (a) Power Limits, EIRP, PSD	Yes
2.1047,	Modulation Characteristics	Yes
2.1049, 30.203	(a) Occupied Bandwidth (b) Out-of-Band Emissions	Yes
2.1051, 30.203	Spurious Emissions at Antenna Terminals	Yes
2.1053, 30.203, 30.204, 15.109(a) Class B	Field Strength of Spurious Radiation	Yes
2.1055,	Measurement of Frequency Stability	N/A

The measurements were conducted in accordance with the procedures set out in Section 2.1041 and as appropriate per the test Standards listed in Table 4.0b below. The comprehensive list of tests performed included measurements at Left, Center and Right side of the Part 30 Band. These tests are presented to demonstrate compliance with FCC requirements.

The procedures defined in ANSI C63.26-2015 and KDB 971168 D01 were developed for conducted measurements. The mmWave Joint Technical Group with FCC oversight has been working diligently on revisions to add mmWave measurements for Upper Microwave Flexible Use Service (UMFUS). The new KDB, 842590, is closely aligned with those efforts.

All of the measurements performed herein were performed as radiated measurements. In order to perform these measurements, the equipment settings required to enable the FSW internal noise reduction capability were used. This typically required the use of average detector, and multiple sweep averages. The individual test sections identify any changes in measurement process.

Table 4.0b Test Standards Used for Radiated Measurements of Radio Performance

Test Standard(s)	<ul style="list-style-type: none"> • 47 CFR FCC Parts 2 • KDB 971168 D01 Licensed DTS Guidance v03r01 April 9, 2018 • KDB 662911 D01 Multiple Transmitter Output v02r01 Oct 2013 • Procedures on TRP Compliance for Out of Band and Spurious Emissions, C63.26 mmWave JTG - Version # 1 July 14th, 2018 • KDB 842590 D01 Upper Microwave Flexible Use Service v01 April 5, 2019
Reference(s)	<ul style="list-style-type: none"> • 47 CFR FCC Part 2 and Part 30 • ANSI C63.26 (2015) • ANSI C63.4 (2014) • TR 14-1001, MMW Measurements with Harmonic Mixers (April-4-2014)

4.1 Section 2.1046 MEASUREMENT REQUIRED: RF POWER OUTPUT

The product incorporates internal antennas that are part of the signal source. There is no antenna terminal connection on the product. Therefore, this test as implemented is not a measurement of the total conducted power at the antenna terminal but rather the total radiated power in terms of the maximum EIRP radiated by the product.

The FCC recognized that these products would use integrated antennas and likewise structured the requirements under Part 30. Under Part 30 the average power of the sum of all antenna elements is limited to an equivalent isotopically radiated power (EIRP) density of +75dBm/100 MHz.

The **Nokia AirScale 39 GHz Radio Unit (AEWF), FCC ID: VBNAEWF-01**, is a LTE TDD Remote radio head presently configured for single carrier operation. It is specified to provide a maximum power output of 54 dBm EIRP/500 W EIRP per transmit polarization for a sum total of 57 dBm EIRP /500W EIRP per unit. The product is designed for the 5G global market including operation per 47 CFR Part 30 rules for operation in the 5G New Radio Band n260 from 37 – 40 GHz.

4.1.1 RF Power Output Measurement

The product was configured for test as shown in Figure 4.1.1 below and allowed to warm up and stabilize per KDB 971168 D01 and ANSI C63.26.

Radiated Power measurements of the 5G New Radio transmit signal were conducted with an FSW Spectrum Analyzer per KDB 971168 D01 and KDB 842590 D01. Measurements were performed at a 4 m distance using a nominal 67.64 dB offset. An additional correction is necessary to ascertain the actual measured EIRP power. The calculation of path loss, cable loss and measurement antenna gain are listed in Table 4.1.1. below. The unit was configured to transmit at its maximum power.

The Channel Power function of the FSW spectrum analyzer was used to measure the maximum average Horizontal and Vertical EIRP at the 4.5m boundary distance. The measurements were performed at the Left, Center and Right side of the 37-40 GHz frequency range for a 100 MHz bandwidth carrier with 5G-NR 64QAM modulation. Channel power plots identify the individual carrier power and the total power.

Table 4.1.1 Corrections For Transmitter Power Measurements

Frequency	Free Space Path Loss, "PL"	Measurement Antenna Gain, "G1"	Measurement Cable Loss, "L1"	Total Offset Required PL -G1 + L1	FSW Measurement Offset	Required Final Correction
GHz	dB	dBi	dB	dB	dB	dB
35.0	75.36	23.25	14.59	66.71	67.64	-0.93
36.0	75.61	23.40	14.85	67.06	67.64	-0.58
37.0	75.85	23.45	15.11	67.50	67.64	-0.14
37.5	75.96	23.60	15.25	67.61	67.64	-0.03
38.0	76.08	23.60	15.38	67.86	67.64	0.22
38.5	76.19	23.60	15.49	68.09	67.64	0.45
39.0	76.30	23.70	15.67	68.27	67.64	0.63
39.5	76.41	23.78	15.81	68.44	67.64	0.80
40.0	76.52	23.80	15.85	68.57	67.64	0.93
41.0	76.74	23.85	16.03	68.92	67.64	1.28

4.1.1.1 RF Power Output Results

Power output measurements verified the expected performance of 54 dBm EIRP per polarization for a Total Power of 57 dBm. The maximum measured level was 54.68 dBm for a single polarization and 57.51 dBm total. This level is well within the maximum Part 30.202a limit of 75 dBm EIRP. Measurements were performed for each modulation.

The measured performance was in full compliance with the Rules of the Commission. The data plots are detailed below.

Table 4.1.1.1 – Channel Power Measurements

Location in Band	Channel Center Frequencies, MHz	# of carriers	Modulation	Horizontal Polarization Total Channel Power, EIRP	Vertical Polarization Total Channel Power, EIRP	Sum Total Channel Power EIRP
				dBm	dBm	dBm
Left	37050.00 37149.96 37249.92 37349.88 37449.84	5	16QAM	54.50	54.49	57.51
Center	38149.56 38249.52 38349.48 38449.44 38549.40 38649.36	6	QPSK	54.11	54.33	57.23
Right	39349.08 39449.04 39549.00 39648.96 39748.92 39848.88 39948.84	7	64QAM	54.13	54.67	57.42
Left	37050.00 37149.96 37249.92 37349.88 37449.84 37549.80 37649.76 37749.72	8	64QAM	54.68	54.28	57.49
Center	38149.56 38249.52 38349.48 38449.44 38549.40 38649.36 38749.32 38849.28	8	16QAM	54.19	54.30	57.26
Right	39249.12 39349.08 39449.04 39549.00 39648.96 39748.92 39848.88 39948.84	8	QPSK	54.33	54.44	57.40

Figure 4.1.1 Test Set-Up for Measurement of Radio Transmitter Performance

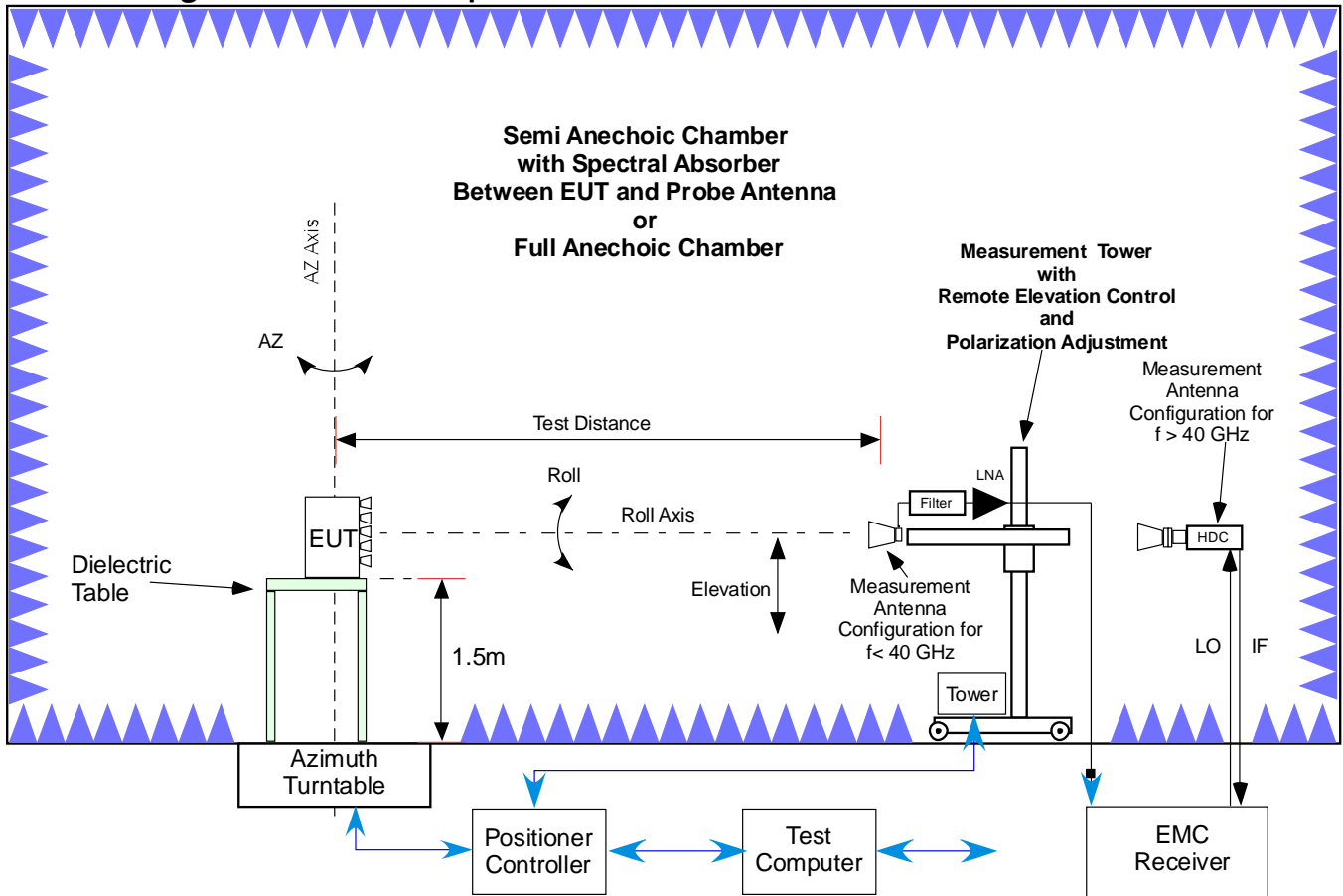

4.1.1.1.1 Channel Power Measurement Plots

Channel Power Measurements, 4.5m, 5 Carrier – 16QAM - Left Side of Band

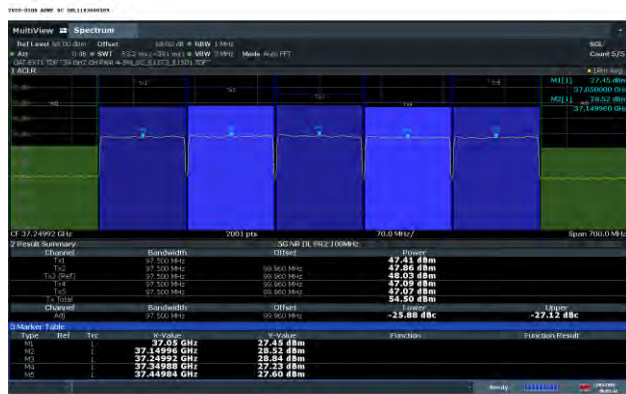

Vertical

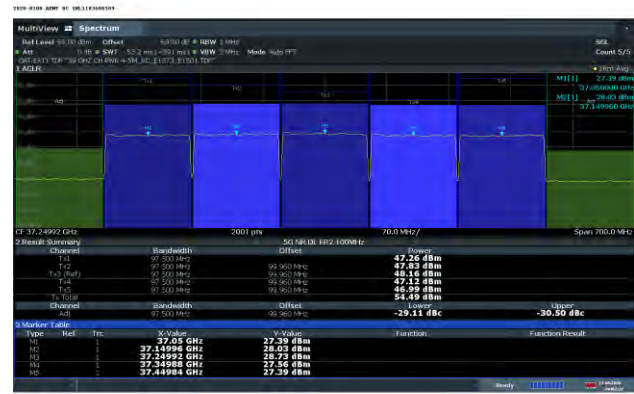

Channel Power Measurements, 4.5m, 6 Carrier – QPSK – Middle of Band

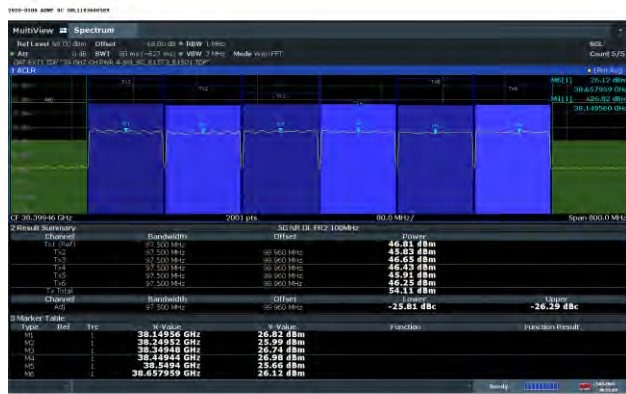

Vertical

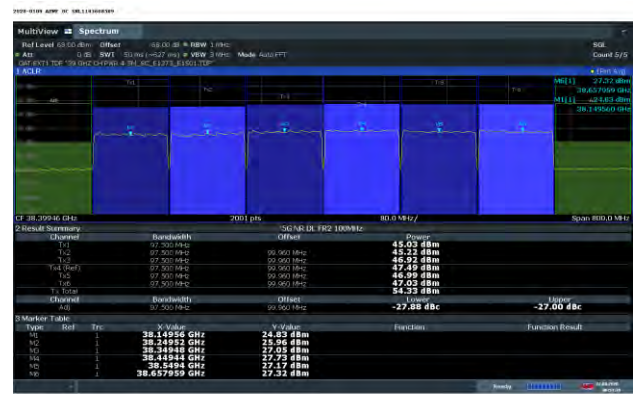

Channel Power Measurements, 4.5m, 7 Carrier – 64QAM – Right Side of Band

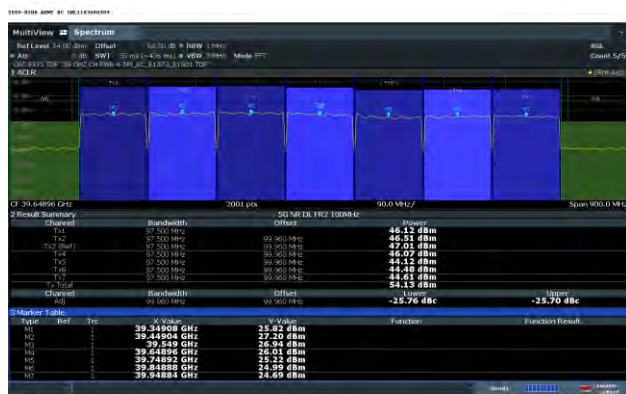

Vertical

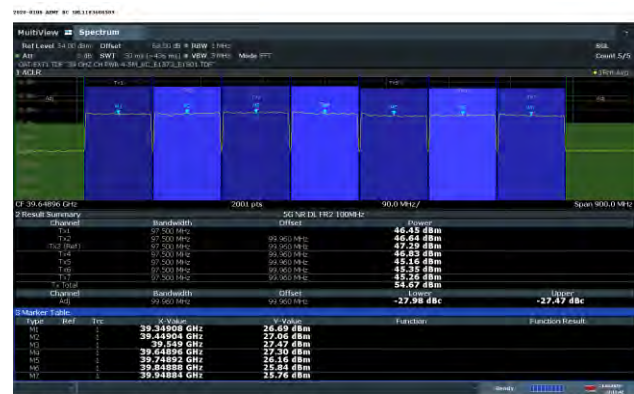

Channel Power Measurements, 4.5m, 8 Carrier – 64QAM – Left Side of Band

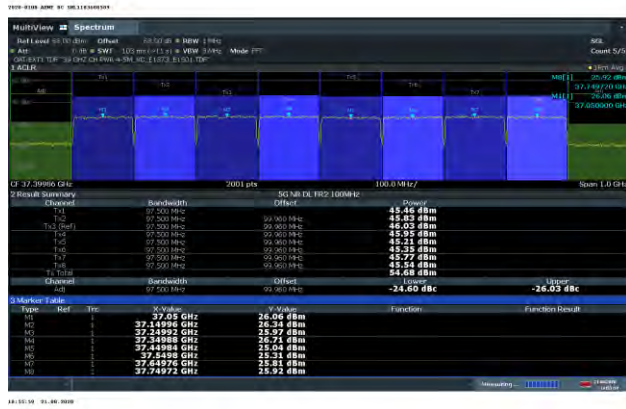

Vertical

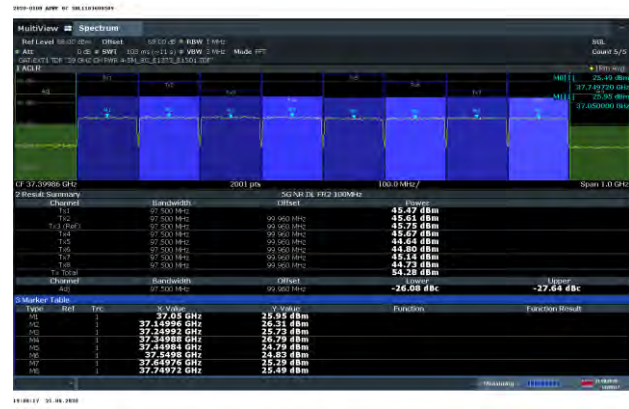

Channel Power Measurements, 4.5m, 8 Carrier – 16QAM – Middle of Band

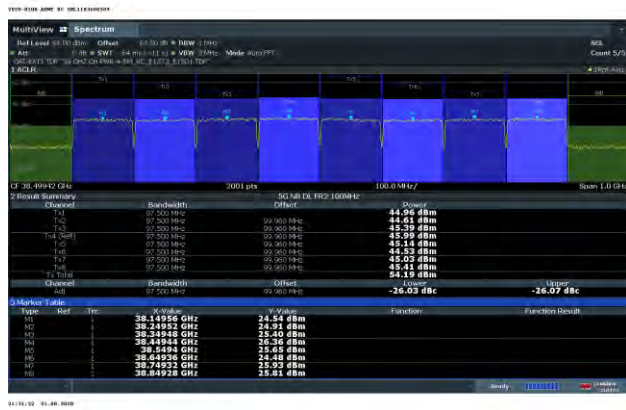

Vertical

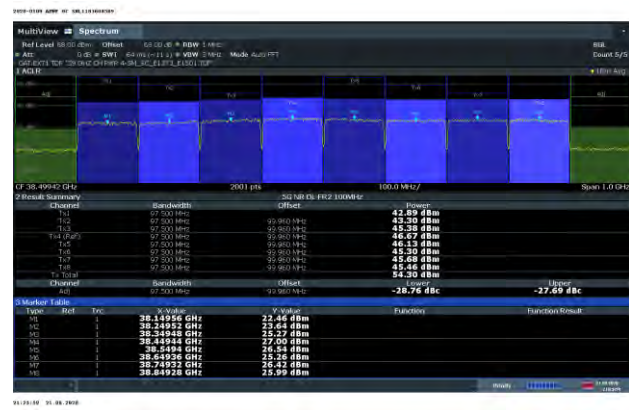

Channel Power Measurements, 4.5m, 8 Carrier – QPSK – Right Side of Band

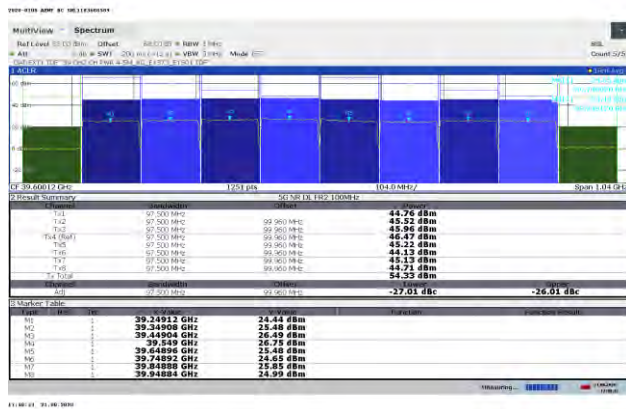

Vertical

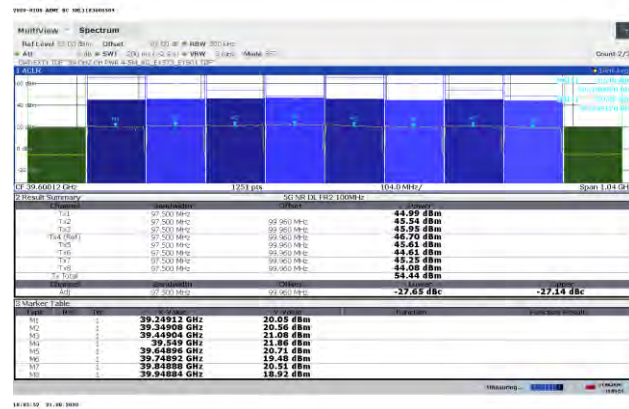

4.2 Section 2.1047 MEASUREMENT REQUIRED: MODULATION CHARACTERISTICS

The **VBNAEWF-01** supports the 5G New Radio Modulation Format based upon LTE TDD technologies. LTE utilizes Orthogonal Frequency Division Multiplexing (OFDM) which splits the carrier frequency bandwidth into many small subcarriers. Each individual subcarrier can be modulated with QPSK, 16QAM and 64QAM digital modulation formats.

In QPSK, there are 4 possible symbol states and each symbol carries 2 bits of information. In 16QAM, there are 16 possible symbol states and each 16-QAM symbol carries 4 bits of information. In 64QAM, there are 64 possible symbol states and each 64-QAM symbol carries 6 bits of information. The higher-order modulations, those where the constellations are more dense, are more sensitive to poor channel conditions than the lower-order modulation.

The modulation characteristics measurement of LTE carriers measures the difference between the ideal symbols and the measured symbols after the equalization. The 5G-New Radio format is still in revision in 3GPP and Release 16 is expected Q4 of 2018. This present evolutionary nature of 5G-NR prevents all of the nominal EVM measurements from being performed at this time. However, constellations were recorded to assess that the subcarrier configurations were achieved.

There are no FCC Limits for Modulation and all of the formats above look spectrally the same from a channel edge and regrowth standpoint. It is expected that greater fidelity will be available after test equipment is configurable with the final format of Release 16. A Class II change is planned for this unit for Multi-carrier operation and Release 16 should be testable at that time.

4.2.1 Modulation Characteristics Measurement

The measurements were performed at a distance of 4 m from the unit utilizing the test configuration in Figure 4.4.1 utilizing a Keysight 44 GHz MXA Signal analyzer with the 3GPP 5G-NR DL Measurement software option. Representative screen plots of the modulation measurement are attached below for all three of the subcarrier configurations and sample polarizations. Data was collected at left, center and right side of the 37-40 GHz frequency band.

4.2.2 Modulation Measurements Results:

The typical measured modulation characteristics of the EUT are shown below:

Figure 4.2 Modulation Results

Sample QPSK 27.6GHz Vertical Polarization

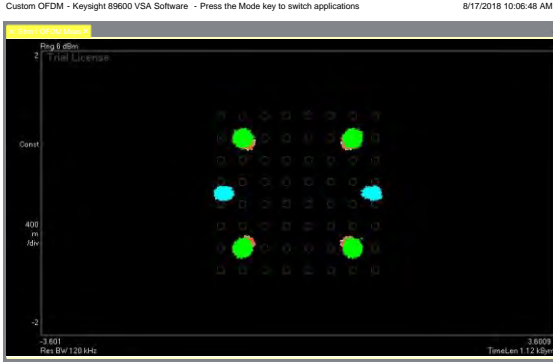

Sample QPSK 27.6GHz Horizontal Polarization

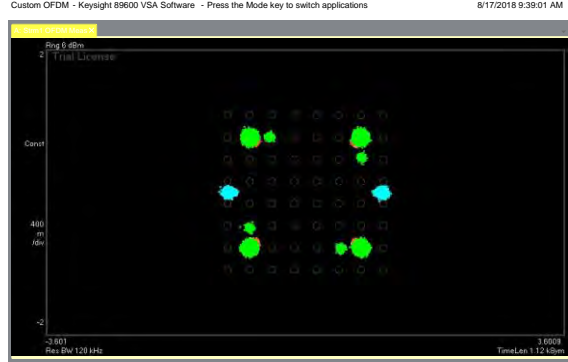

Sample 16QAM 27.6 GHz Vertical Polarization

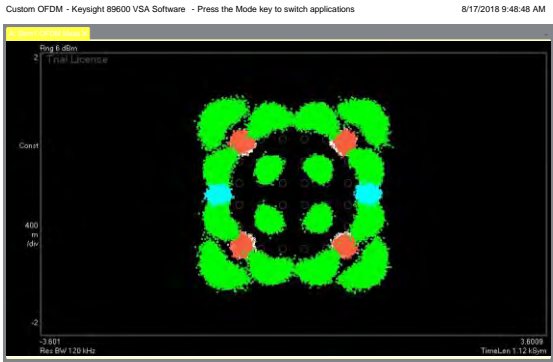

Sample 16QAM 27.6 GHz Horizontal Polarization

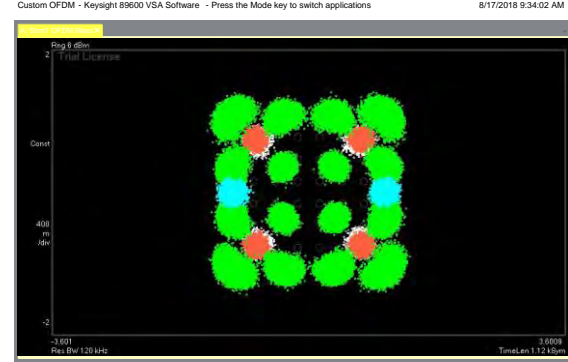

Sample 64QAM 27.6 GHz Vertical Polarization

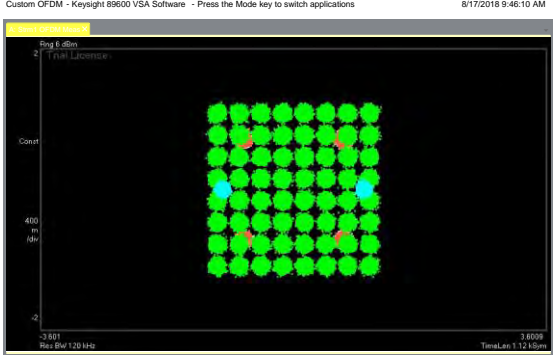

Sample 64QAM 27.6 GHz Horizontal Polarization

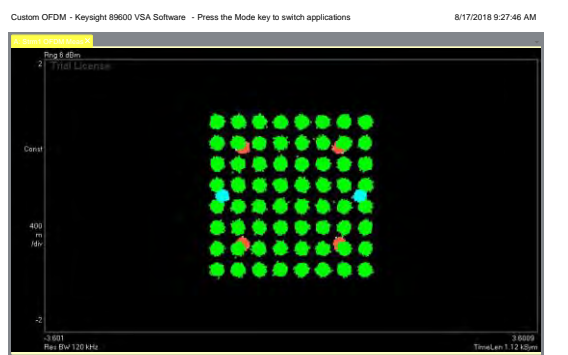

4.3 Section 2.1049 MEASUREMENT REQUIRED: OCCUPIED BANDWIDTH and EDGE of BAND EMISSIONS

This test measures the Occupied Bandwidth of the transmitting carrier and the Edge of-Block Emissions in the frequency spectrum immediately outside and adjacent to the transmitting carrier(s).

The occupied bandwidth (OBW) is usually defined either as the 99% power OBW or a relative OBW. The 99% OBW is the signal bandwidth such that, below its lower and above its upper frequency limits, the mean power radiated or conducted are each equal to 0.5 percent of the total mean power radiated or conducted by a given emission. The relative OBW is defined as the width of the signal between two points, one below the carrier center frequency and one above the carrier center frequency, outside of which all emissions are attenuated by at least X dB below the transmitter power, where the value of X is typically specified as 26.

Per KDB 971168 D01 v02, the relative OBW must be measured and reported when it is specified in the applicable rule part; otherwise, the 99% OBW shall be measured and reported. The OBW shall be measured when modulated by an input signal such that its amplitude and symbol rate represent the maximum rated conditions under which the equipment is operated.

4.3.1 Results Occupied Bandwidth (Signal Bandwidth)

The measurements of 99% occupied bandwidth were performed with a Rohde & Schwartz FSW 67 GHz spectrum analyzer. The measurements of the intended 100 MHz 5G-NR carrier indicated compliance for the 97M5G7D emission designator. Sample results are presented below and shows that the measured signals are within the parameters of the 97M5G7D emissions designator.

Tabular Data – Occupied Bandwidth 1MHz RBW

Location in Band	Carrier Frequencies (GHz)	Number of Carriers	Modulation	Horizontal Polarization Occupied Signal Bandwidth (MHz)	Vertical Polarization Occupied Signal Bandwidth (MHz)
Left	37.24982 To 37.494925	5	16QAM	490.542	490.163
Middle	38.39946 To 38.693815	6	QPSK	590.088	588.411
Right	39.64896 To 39.993051	7	64QAM	688.846	687.707
Left	37.39988 To 37.793417	8	64QAM	787.466	786.989
Middle	37.99942 To 38.89327	8	16QAM	788.773	785.564
Right	39.59898 To 39.9117983	8	QPSK	787.161	787.125

Tabular Data – Occupied Bandwidth **3MHz** RBW

Location in Band	Carrier Frequencies (GHz)	Number of Carriers	Modulation	Horizontal Polarization Occupied Signal Bandwidth (MHz)	Vertical Polarization Occupied Signal Bandwidth (MHz)
Left	37.24982 To 37.494962	5	16QAM	490.610	490.025
Middle	38.39946 To 38.693763	6	QPSK	589.684	588.215
Right	39.64896 To 39.992314	7	64QAM	688.530	687.536
Left	37.39988 To 37.793212	8	64QAM	787.127	787.052
Middle	37.99942 To 38.893066	8	16QAM	788.601	785.618
Right	39.59898 To 39.991904	8	QPSK	787.283	787.178

Tabular Data – Occupied Bandwidth **5MHz** RBW

Location in Band	Carrier Frequencies (GHz)	Number of Carriers	Modulation	Horizontal Polarization Occupied Signal Bandwidth (MHz)	Vertical Polarization Occupied Signal Bandwidth (MHz)
Left	37.24982 To 37.495075	5	16QAM	490.911	490.442
Middle	38.39946 To 38.694044	6	QPSK	590.233	588.715
Right	39.64896 To 39.992739	7	64QAM	688.942	687.578
Left	37.39988 To 37.793409	8	64QAM	787.345	787.075
Middle	37.99942 To 38.892791	8	16QAM	788.229	785.572
Right	39.59898 To 39.992018	8	QPSK	787.122	787.346

4.3.1.1 99% Signal Bandwidth 10 MHz RBW Plots

1MHz RBW

5 Carrier 16QAM Horizontal



Vertical

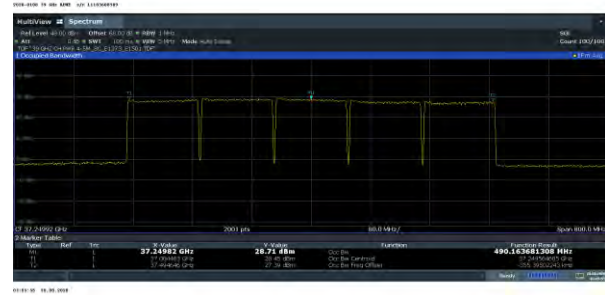

6 Carrier QPSK Horizontal



Vertical

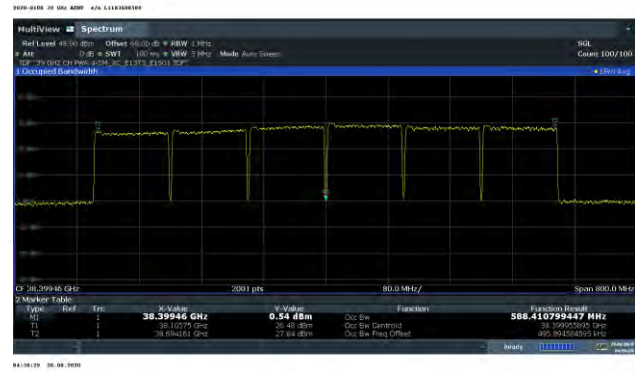

7 Carrier 64QAM Horizontal



Vertical



8 Carrier 64QAM Horizontal



Vertical



8 Carrier 16QAM Horizontal



Vertical



8 Carrier QPSK Horizontal



Vertical

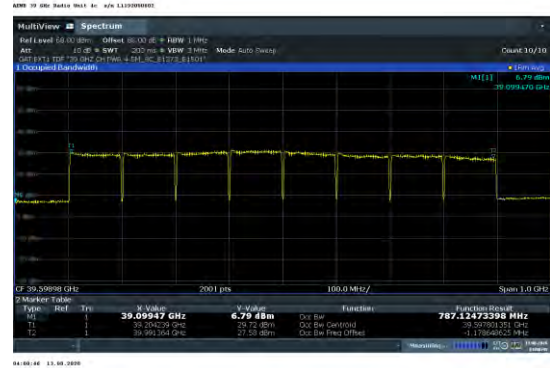

3MHz RBW

5 Carrier 16QAM Horizontal

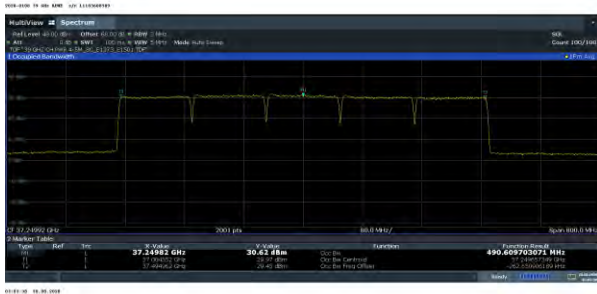

Vertical



6 Carrier QPSK Horizontal

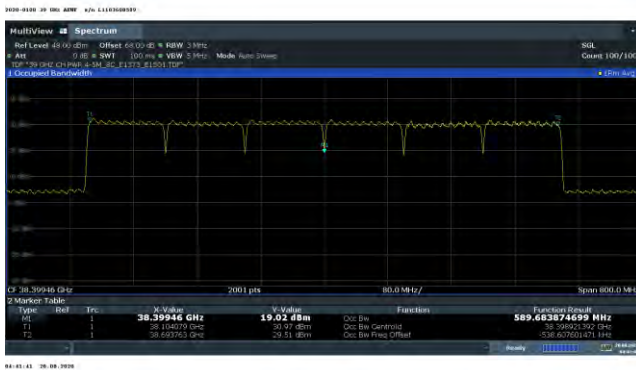

Vertical



7 Carrier 64QAM Horizontal



Vertical



8 Carrier 64QAM Horizontal



Vertical



8 Carrier 16QAM Horizontal



Vertical

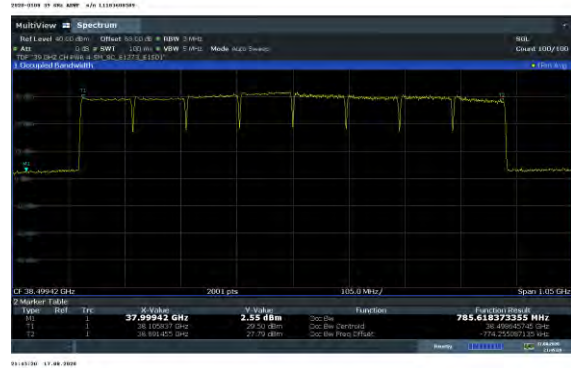

8 Carrier QPSK Horizontal

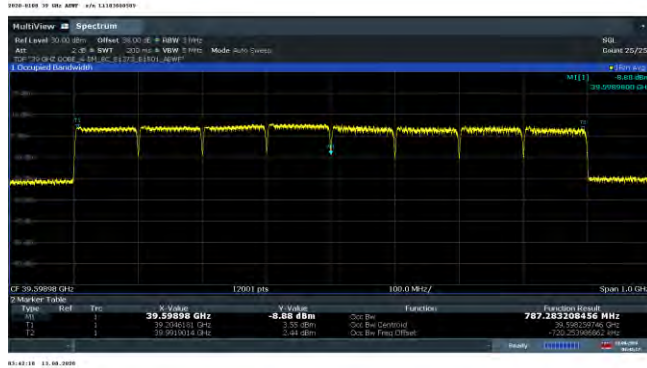

Vertical

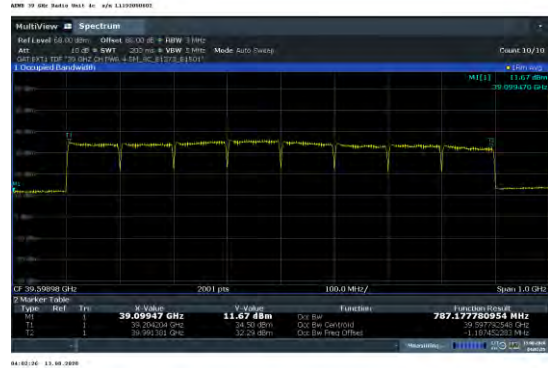

5MHz RBW

5 Carrier 16QAM
 Horizontal



Vertical



6 Carrier QPSK
 Horizontal



Vertical



7 Carrier 64QAM
 Horizontal



Vertical



8 Carrier 64QAM Horizontal



Vertical



8 Carrier 16QAM Horizontal



Vertical



8 Carrier QPSK Horizontal

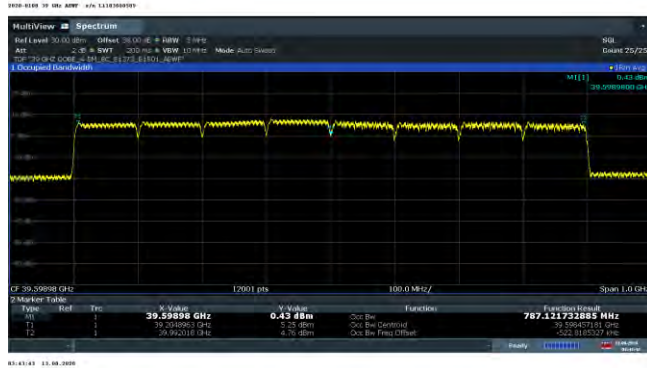

Vertical



4.3.2 Occupied Bandwidth-Edge of Block Emissions

Classical Occupied Bandwidth – Edge of Block Emissions is an evaluation of the transmit carrier compliance with edge of block/edge of band requirements. This measurement documents the product’s ability to maintain compliance with FCC Parts 2 and Part 30.203 limitations on emissions outside the block of operation.

The **VBNAEWF-01** 39 GHz Radio Unit presently supports single 5G-New Radio LTE TDD technologies. This evaluation addresses 2x2 MIMO operation with 100 MHz carriers. In each test configuration the carriers were configured at the left side, center and right side of the band as appropriate. Power was set to the total per polarization maximum and channel power measurements were performed prior to other measurements. The measurements are described below.

The occupied bandwidth of each of the signals identified in Table 4.3.6.1 was measured using a Rohde & Schwarz FSW Spectrum analyzer, a remote PC based instrumentation controller and the same calibrated RF attenuation path used for channel power. The measurement process meets the requirements of ANSI C63.26 and ISO17025. The test setup was as shown in Figure 4.1.1. Measurements were performed at 4 m for both vertical and horizontal polarizations.

Plots are provided using the triggered functionality of the test analyzer and demonstrate compliance with edge of band limits.

These sheets contain data for multiple mixed carrier configurations for “Left Edge of Block”, and “Right Edge of Block” across the Part 30 Upper Microwave Flexible Use Service spectrum.

4.3.3 Requirements 28 GHz Emissions Limits

The Limit in 47 CFR 30.203 for Emissions Limits is as follows:

- (a) The conductive power or the total radiated power of any emission outside a licensee's frequency block shall be -13 dBm/MHz or lower. However, in the bands immediately outside and adjacent to the licensee's frequency block, having a bandwidth equal to 10 percent of the channel bandwidth, the conductive power or the total radiated power of any emission shall be -5 dBm/MHz or lower.
- (b)(1) Compliance with this provision is based on the use of measurement instrumentation employing a resolution bandwidth of 1 megahertz or greater.
- (2) When measuring the emission limits, the nominal carrier frequency shall be adjusted as close to the licensee's frequency block edges as the design permits.
- (3) The measurements of emission power can be expressed in peak or average values.

In order to address the limit as imposed for the requirement in 47CFR 96.41 we evaluated emissions per the requirements in ANSI C63.26 and per KDB 940660 D01 Part 30 CBRS Equipment.

The average detector function was used for all MXA measurements and the Peak detector function were used for EMC receiver measurements.

4.3.4 Measurement Offset and MIMO

As this was a radiated EIRP measurement no MIMO adjustment was used.

4.3.5 Mask Parameters

The mask parameters are in units as stated in Part 30 and are listed in Table 4.3.5. Mask parameters are as stated in Table 4.3.5. Mask Edge Offsets = $\frac{1}{2}$ the measurement Resolution Bandwidth were not used.

Table 4.3.5 - Mask Parameters Out Of Band / Edge of Band Emissions

Frequency	Part 30 Limit
GHz	dBm
35.00	-13
36.00	-13
36.99	-13
36.99	-5
37.00	-5
37.00	57
40.00	57
40.00	-5
40.01	-5
40.01	-13
41.00	-13
42.00	-13

4.3.6 Measurement Path Adjustments

The measured power at the spectrum analyzer input was adjusted for calculated free space loss, cable loss, measurement antenna gain and the product antenna gain over its applicable frequency range as documented in Exhibit 6 of the filing and in the table below. This is appropriate for Out Of Band Emissions / Edge of Band emissions only for the frequency range that the transmit antenna has documentable and consistent gain. Since different products have different gain responses vs frequency, the products documentable antenna gain only applies for the operational frequency range for which the product is designed.

Sample calculation: The sample calculation below is the formula and the correction for 37 GHz;
 Adjustment = Free Space Path Loss - Measurement Antenna Gain + Cable Loss - Product Antenna Gain.
 Total Required Adjustment (@37 GHz) = 40.50 dB = 77.79 dB -23.25dBi + 15.11dB - 29.15 dBi

This adjustment was only used for the OOBE/EoB frequency range. Table 4.3.6 below lists the offset correction factors used for the measurement distance of 4.5m including the AEWf product gain. The measurements were made using a flat offset of 40.49 dB with a transducer correction identified below.

Table 4.3.6 Measurement Correction for Edge of Band / Out of Band Emissions

Frequency	Free Space Path Loss, PL	E1373 Measurement Antenna Gain, "G"	E1501 Measurement Cable Loss, "L"	Channel Power Path Loss PL-G1+L1	AEFW Antenna Gain, IEEF	OOBE Total Required Adjustment	FSW Offset	Transducer Correction Factor
GHz	dB	dBi	dB	dB	dBi	dB	dB	dB
35.0	76.39	24.30	14.66	66.75	26.50	40.25	38	2.247
35.5	76.51	24.24	14.76	67.03	27.20	39.83	38	1.832
36.0	76.63	24.37	14.87	67.14	27.80	39.34	38	1.337
36.5	76.75	24.28	15.01	67.48	28.20	39.28	38	1.282
37.0	76.87	24.44	15.18	67.61	28.70	38.91	38	0.905
37.5	76.99	24.37	15.32	67.93	29.00	38.93	38	0.935
38.0	77.10	24.45	15.43	68.08	29.30	38.78	38	0.781
38.5	77.22	24.38	15.57	68.41	29.50	38.91	38	0.913
39.0	77.33	24.48	15.66	68.51	29.60	38.91	38	0.911
39.5	77.44	24.52	15.77	68.69	29.40	39.29	38	1.289
40.0	77.55	24.55	15.78	68.78	29.30	39.48	38	1.476
40.5	77.66	24.61	15.82	68.87	29.20	39.67	38	1.666
41.0	77.76	24.66	15.93	69.03	29.00	40.03	38	2.033
41.5	77.87	24.71	16.04	69.20	28.80	40.40	38	2.398

4.3.7 Edge of Band Measurements

The Occupied Bandwidth and Edge-of-Band emissions measurements were made as a radiated measurement at a distance of 4.5m. The measurements were performed with an FSW spectrum analyzer in compliance with the procedure and requirements of ANSI C63.26. The test set-up diagram in Figure 4.1.1 was used. Testing was performed for the 100 MHz carrier configurations at the left side, and right side of the Part 30 Band. All of the Edge of Band measurements were performed at the specified 1 MHz resolution bandwidths. Adjustment factors were as described in Section 4.3.6 above.

4.3.7.1 Results - Occupied Bandwidth-Edge of Block Emissions

The occupied bandwidth plots for operation at the left side, center and the right side of the band for the 100 MHz signal bandwidth are below. The mask accurately depicts the limits for the Part 30 NAR Band to determine compliance with FCC requirements. The mask limits include the appropriate considerations for operation.

From the out-of-band emissions plots attached below, it can be seen that all the emissions are under the required emission masks.

The measurement results of the occupied bandwidth and the out-of-band emissions as documented in the plots and Table 4.3.6.1 demonstrate the full compliance with the Rules of the Commission for the operating band.

The Occupied Bandwidth and Edge-of-Band emissions measurements were made as a radiated measurement at a distance of 4.5m.

Table 4.3.7.1 Results - Occupied Bandwidth-Edge of Block Emissions/ OOB

Center Frequencies of Edge Channels, GHz	Location	Number of Carriers	Modulation	Polarization	Occupied Bandwidth Edge of Block / OOB Compliance
37.05000 to 37.44984	Left Side of Band	5 adjacent	16QAM	Horizontal	Compliant
				Vertical	Compliant
38.14956 to 38.64936	Middle of Band	6 adjacent	QPSK	Horizontal	Compliant
				Vertical	Compliant
39.34908 to 39.94884	Right Side of Band	7 adjacent	16QAM	Horizontal	Compliant
				Vertical	Compliant
37.05000 to 37.44972	Left Side of Band	8 adjacent	64QAM	Horizontal	Compliant
				Vertical	Compliant
38.14956 to 38.84928	Middle of Band	8 adjacent	16QAM	Horizontal	Compliant
				Vertical	Compliant
39.24912 to 39.994884	Right Side of Band	8 adjacent	QPSK	Horizontal	Compliant
				Vertical	Compliant

4.3.7.1.1 Occupied Bandwidth Edge of Band Plots

5 Carrier – 16QAM / Left OOBE/EoB – Horizontal Polarization



OOBE/EoB – Vertical Polarization

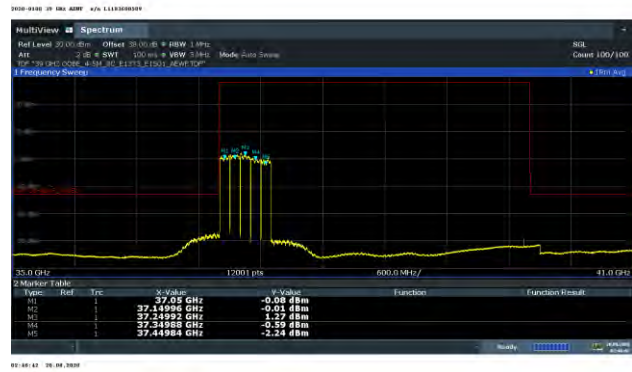

6 Carrier – QPSK / Middle OOBE/EoB – Horizontal Polarization



OOBE/EoB – Vertical Polarization



7 Carrier – 64 QAM / Right OOBE/EoB – Horizontal Polarization



OOBE/EoB – Vertical Polarization



8 Carrier – 64QAM / Left
OOBE/EoB – Horizontal Polarization

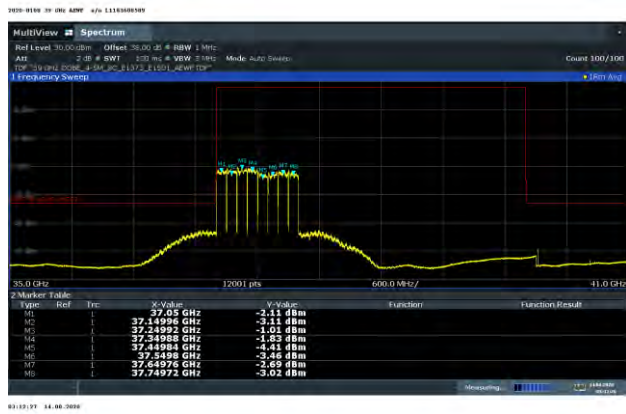

OOBE/EoB – Vertical Polarization



8 Carrier – 16QAM / Middle
OOBE/EoB – Horizontal Polarization

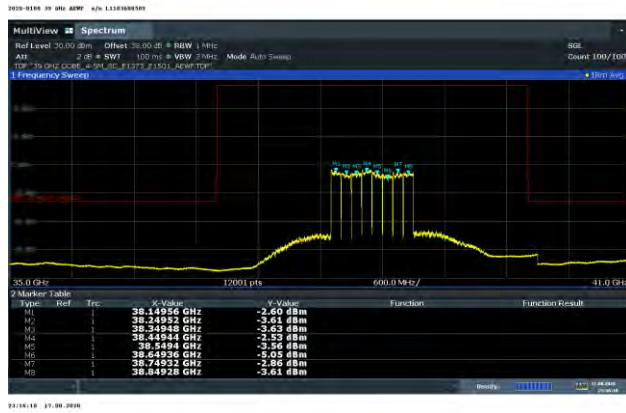

OOBE/EoB – Vertical Polarization



8 Carrier – QPSK / Right
OOBE/EoB – Horizontal Polarization



OOBE/EoB – Vertical Polarization



4.4 Section 2.1051 MEASUREMENT REQUIRED: SPURIOUS EMISSIONS AT THE ANTENNA TERMINALS

This test measures the emissions of spurious signals which may come from harmonic, parasitic, intermodulation and frequency conversion products and are outside the necessary bandwidth but excludes Edge-of-Band emissions.

4.4.1 Section 2.1051 Spurious Emissions at Antenna Terminals

Spurious Emissions were investigated per 47CFR Section 2.1057(a)(1) over the frequency range of 30 MHz to 200 GHz as specified in 2.1057(a)(3).

2.1057(a)(3) If the equipment operates at or above 30 GHz: to the fifth harmonic of the highest fundamental frequency or to 200 GHz, whichever is lower.

4.4.2 Required Limit

The required emission limitation specified in 47CFR 30.203 (a) was applied to these tests. Based upon the criterion given in Section 30 of the Code and as developed in 4.3.3, the required emission limit for emissions outside a licensee's frequency block is:

47CFR 30.203 (a) (a) The conductive power or the total radiated power of any emission outside a licensee's frequency block shall be -13 dBm/MHz or lower. However, in the bands immediately outside and adjacent to the licensee's frequency block, having a bandwidth equal to 10 percent of the channel bandwidth, the conductive power or the total radiated power of any emission shall be -5 dBm/MHz or lower.

4.4.3 Results

Since there is no antenna terminal, all measurements were performed as radiated measurements and standard radiated emissions. The Edge of Band emissions, presented in Section 4.3.7.1, document the 35 - 37 GHz and 40 - 42 GHz OOB ranges. Those measurements are appropriate as the products antenna gain is documented over the same ranges. There were no emissions detected in these ranges.

The standard radiated emissions are documented in Section 4.5 "*Section 2.1053 Measurement Required: Field Strength of Spurious Radiation*". The test configuration is shown in Figure 4.4.1 documents the test set up used for the measurements.

The measurements were performed in compliance with ANSI C63.26, C63.26 mmWave JTG, and our ISO17025 process. The measurement meets the ANSI C63.26 requirements in paragraphs 5.2.4.4.1 and 5.7 which requires that the number of points in the sweep be $> 2 \times \text{Span/RBW}$. The ESU-40 spectrum analyzer measurements examine the 30 MHz to 40 GHz range. The FSW based mmWave transmitter test system overlaps the transmit band for 37-40 GHz and extends the frequency range to examine the 40 GHz to 200 GHz range.

4.5 Section 2.1053 MEASUREMENT REQUIRED: FIELD STRENGTH OF SPURIOUS RADIATION

The field strength measurements of radiated spurious emissions were made in a FCC registered ten meter semi-anechoic chamber AR-8, (FCC Registration Number: 395774) NVLAP Lab Code: 100275-0 and IC (Filing Number: 6933F-8) which is maintained by Nokia Bell Labs in Murray Hill, New Jersey.

The VBNAEWF-01 (EUT) was configured in semi-anechoic chamber AR-8 in a manner simulating a normal field installation. The product’s field installation hardware was used to mount the product to a wooden pole with the bottom of the product 1.5m above the turntable ground plane. The recommendations of ANSI C63.4–2014, C63.26-2015, KDB 842590 D01 and C63.26 mmWave JTG were followed for EUT testing setup and cabling. The EUT was configured to operate in a 5G-NR test model per the constraints identified in section 4.2. A photograph of this setup is in Exhibit 12 of the filing package.

The base station was configured into the full power forward beam transmit configuration to transmit two 54 dBm EIRP 100 MHz bandwidth 5G-NR carriers, one Vertical and one Horizontal polarization, with the total transmit power of 57 dBm EIRP. This configuration provides the highest power spectral density transmit signal for the product. The product utilizing the configurations below was evaluated over the 30 MHz to 200 GHz frequency range as required.

Table 4.5.1 EUT Configurations

Test Configuration NRARFCN	AEWF Tx Reference Frequencies MHz	Transmit Active Polarization	Signal Bandwidth, MHz	Modulation	Total Power, dBm EIRP	Radiated Emissions Pass / Fail
2248325	38149.56	H & V	100	16QAM	57	Pass
2249991	38249.52					
2251657	38349.48					
2253323	38449.44					
2254989	38549.40					
2256655	38649.36					
2258321	38749.32					
2259987	38849.28					

4.5.1 Spurious Radiation and Radiated Emissions Requirements.

This product meets Part 15B, and Part 30.203 requirements. . FCC Part 15 Class B require emissions to be below 54.5 dBuV/m at 3m. Part 30.203 requires emissions to be below the value generated by a conducted emission of -13 dBm. This is a standard value for wireless products typically defined as

$$-43+10\text{LogP}=-13 \text{ dBm.}$$

The emissions at the Edge of Band were adjusted by the 29 dBi gain of the transmit antenna as the product is designed to operate globally over the 37 to 40 GHz frequency band. Emissions removed from the transmit band were evaluated identically to other wireless products.

Measurements were performed in compliance with Section 2.1053, FCC publication 442401, the requirements detailed above and clause 5.5 of ANSI C63.26. For this case the evaluation of acceptable radiated field strength is as follows.

The calculated emission levels were found by:

$$\begin{aligned} P_{\text{meas}} \text{ (dBm)} + \text{Cable Loss(dB)} + \text{Antenna Factor(dB)} + 107 \text{ (dB}\mu\text{V/dBm)} - \text{Amplifier Gain (dB)} \\ = \text{Field Strength (dB}\mu\text{V/m)} \end{aligned}$$

Title 47CFR section 30.203 and 2.1053 contains the requirements for the levels of spurious radiation as a function of the EIRP of the modulated carrier with 100 MHz of bandwidth. The reference level for the modulated carrier is calculated as the field produced by an isotropic radiator excited by the transmitter output power according to the following relation taken from Reference Data for Radio Engineers, page 27-7, 6th edition, IT&T Corp.

$$E = (120\pi P)^{1/2} = [(30 * P)^{1/2}] / R$$

$$20 \log (E * 10^6) - (43 + 10 \log P) = 82.23 \text{ dB } \mu\text{V/meter}$$

Where: E = Field Intensity in Volts/ meter R = Distance in meters = 3 m
 P = Transmitted Power, Watts = 53300 W

The field strength of radiated spurious emissions measured was determined by

$$E(\text{dB}\mu\text{V/m}) = V_{\text{meas}}(\text{dB}\mu\text{V}) + \text{Cable Loss (dB)} + \text{Antenna Factor (dBi/m)}.$$

Field strength measurements of radiated spurious emissions were made in the 10m semi-anechoic chamber, AR-8 as detailed above. The recommendations of ANSI C63.4 and ANSI C63.26 were followed for EUT testing setup, cabling, and measurement approach and procedures. All the measurement equipment used, including antennas, was calibrated in accordance with ISO 9001 process. The EUT setup diagram is given in the Figure 4.5. The minimum margins to the Part 30.203 limit is as measured in accordance with 2.1053. The test data follows.

4.5.2 Radiated Spurious Emissions Measurements: 40 GHz - 100 GHz

The radiated spurious emissions spectrum was investigated per 47CFR Section 2.1057(a)(1) for spurious emissions over the frequency range of 40 GHz to 200 GHz. The procedure and methodology followed the recommendations of ANSI C63.4–2014, C63.26-2015 and C63.26 mmWave JTG.

A Rohde & Schwarz FSW 67 was employed with external three port Harmonic Down Converters (HDC). The waveguide RF input converters provided coverage for 40-60 GHz (U), 60-90 GHz (E), 90-140 GHz (F) and 140-220 GHz (G) bands. The HDC’s were paired with 25 dB Standard Gain Horns. A 40 GHz waveguide high pass filter was utilized to limit the transmit carrier emissions from overloading the 40-60 GHz HDC.

Operation of the harmonic down converters utilizes a swept LO with a fixed IF frequency of 1.325 GHz. The IF cable loss for the 4m of cable was 1.03 dB and was corrected internally to the FSW along with the Conversion loss for the harmonic down converters. Additional external shielding of the HDC’s was necessary to limit carrier energy from creating immunity issues with the measurements.

Cable loss compensation for the LO cable loss was necessary to enable scan heights from 1-3 meters. The experience of this test indicated that a 3m maximum test height with this product is adequate (0.5 m above the top of product). This allowed for a reduction of the test cables length and reduce IF images which occurred at multiples of the 1.325 GHz IF frequency.

Measurements were performed at the following distances:

mmWave Band	Frequency Range, GHz	Measurement distance meters
U	40-60	4
E	60-90	4
F	90-140	3
G	140-220	3

Operation was verified prior to testing by bore-sighting a mmWave signal generator or mmWave source module with an antenna identical to the measurement antenna at the test distance. The location of the maximum beams had previously been ascertained for both vertical and horizontal polarizations. The beam is extremely narrow and radiated power is down 19 dB at just ± 7 degrees off center. All of the emissions and harmonics were found to be centered on the beam as well.

Based upon previous experience a continuous max hold (average detector) sweep of the product in elevation and azimuth was employed for full coverage scanning of the product. For these measurements in each band the scan was started at the beam peak location of 350 degrees' azimuth, and nominal elevations 170-175 cm for Vertical and 154-158 cm for Horizontal. The peak was first located for the most prominent emissions in the span. The elevation was then swept down to 1m and back up back to 3m and returned to the beam peak. The product was then rotated continuously to 360 degrees back to 0 degrees and back to 350 degrees. This method locates any emission and provides the maximum emissions but required operation without the analyzer internal noise reduction function. Peaks were noted using the marker function which were later formally measured with the required 1 MHz resolution bandwidth. Measurements for all four bands were performed this way.

4.5.2.1 Bandwidth Limits and Corrections: Radiated Measurements 40 GHz - 100 GHz

All corrections were made to the signal level as detailed below.

4.5.2.2 Resolution Bandwidth and # of Points:

For measurements above 40 GHz we performed final measurement scans with the required 1 MHz resolution bandwidth and preliminary scans with either a 10 MHz or 3 MHz resolution bandwidth.

Final measurements were performed so that the resolution bandwidth and span limitations of ANSI C63.26 were followed so that the number of measurement points $> 2(\text{Span}/\text{RBW})$.

Our FSW was upgraded from the original filing and now processes 100,000 data points across the screen which allows for 50 GHz spans with a 1 MHz RBW. Multiple spans were therefore used when necessary to evaluate the peak spurious emissions detected.

4.5.2.3 Part 30 Limit:

The -13 dBm emissions limit was not adjusted in any way.

4.5.2.4 Emissions Corrections

The measured signal was corrected by the FSW for the harmonic downconverter (HDC) conversion loss. In addition, a correction consisting of the radiated path loss, the gain of the measurement antenna and a 1 dB IF cable loss (at 1.3 GHz) was applied. There was no correction applied for the product antenna gain as these measurements are outside the transmit frequency range.

$$\text{Emissions Correction} = \text{Path Loss} - \text{Antenna Gain} + \text{IF Cable loss (1dB)}$$

$$\text{Where Free Space Path Loss} = ((4\pi d)/\lambda)^2$$

Table 4.5.2.4 details the correction for the three bands.

Table 4.5.2.4a Radiated Emissions Corrections for 40-60 GHz at 4m

Frequency	λ	Measurement Distance, d	Path Loss	Measurement Antenna Gain	IF Cable Loss	Emissions Correction Total
GHz	m	m	dB	dB	dB	dB
40.0	0.0075	4	76.52	21.80	1.03	55.75
42.5	0.0071	4	77.05	22.20	1.03	55.87
45.0	0.0067	4	77.55	22.50	1.03	56.07
47.5	0.0063	4	78.02	22.70	1.03	56.34
50.0	0.0060	4	78.46	23.00	1.03	56.49
52.5	0.0057	4	78.89	23.30	1.03	56.61
55.0	0.0055	4	79.29	23.40	1.03	56.91
57.5	0.0052	4	79.68	23.60	1.03	57.10
60.0	0.0050	4	80.05	23.70	1.03	57.37

Table 4.5.2.4b Radiated Emissions Corrections for 60-90 GHz at 3m

Frequency	λ	Measurement Distance, d	Path Loss	Measurement Antenna Gain	IF Cable Loss	Emissions Correction Total
GHz	m	m	dB	dB	dB	dB
60.0	0.0050	3	77.55	21.80	1.03	56.747
65.0	0.0046	3	78.24	22.30	1.03	56.942
70.0	0.0043	3	78.89	22.70	1.03	57.186
75.0	0.0040	3	79.49	23.00	1.03	57.485
80.0	0.0038	3	80.05	23.40	1.03	57.646
85.0	0.0035	3	80.57	23.60	1.03	57.973
90.0	0.0033	3	81.07	23.80	1.03	58.269

Table 4.5.2.4c Radiated Emissions Corrections for 90-140GHz at 3m

Frequency	λ	Measurement Distance, d	Path Loss	Measurement Antenna Gain	IF Cable Loss	Emissions Correction Total
GHz	m	m	dB	dB	dB	dB
90.0	0.0033	3	81.07	21.90	1.03	60.199
95.0	0.0032	3	81.54	22.30	1.03	60.369
100.0	0.0030	3	81.98	22.60	1.03	60.414
105.0	0.0029	3	82.41	22.95	1.03	60.438
110.0	0.0027	3	82.81	23.30	1.03	61.542
115.0	0.0026	3	83.20	23.60	1.03	60.603
120.0	0.0025	3	83.57	23.85	1.03	60.773
125.0	0.0024	3	83.92	24.05	1.03	60.952
130.0	0.0023	3	84.26	24.18	1.03	61.093
135.0	0.0022	3	84.59	24.35	1.03	61.221
140.0	0.0021	3	84.91	24.50	1.03	61.437

Table 4.5.2.4d Radiated Emissions Corrections for 140-200GHz at 3m.

Frequency	λ	Measurement Distance, d	Path Loss	Rx Antenna Gain	IF Cable Loss	Total
GHz	m	m	dB	dB	dB	dB
140.0	0.002143	3	84.91	21.80	1.03	64.137
145.0	0.002069	3	85.21	22.30	1.03	63.942
150.0	0.002000	3	85.51	22.70	1.03	63.836
155.0	0.001935	3	85.79	23.00	1.03	63.821
160.0	0.001875	3	86.07	23.40	1.03	63.697
165.0	0.001818	3	86.33	23.60	1.03	63.764
170.0	0.001765	3	86.59	23.80	1.03	63.823
175.0	0.001714	3	86.84	24.00	1.03	63.875
180.0	0.001667	3	87.09	24.20	1.03	63.920
185.0	0.001622	3	87.33	24.40	1.03	63.958
190.0	0.001579	3	87.56	24.60	1.03	63.989
195.0	0.001538	3	87.78	24.80	1.03	64.015
200.0	0.001500	3	88.00	25.00	1.03	64.035

4.5.3 Field Strength of Spurious Radiation Results:

This product meets Part 15B limits below 10 GHz and Part 30 Requirements. For the Title 47CFR section 30.203 and 2.1053 test, the field strength of any spurious radiation, measured at 3m, is required to be less than 82.23 dB μ V/meter. Emissions equal to or less than 62.23 dB μ V/meter are not reportable.

There were reportable emissions below 37 GHz. The minimum margin was 12.52 dB to the spurious noise floor at 25725.549 MHz. All other emissions below 37 GHz were below the Part 15 Class B limit.

Presented results include the standard measurements from 30 MHz to 40 GHz followed by the four mmWave bands. The worst-case emissions are presented. The scans are performed with the required 1 MHz resolution bandwidth and sufficient number of points per ANSI C63.26 with markers at the frequencies of interest. The limit in the measurement is the conducted -13 dBm limit as specified in Part 30.203. Corrections to the emissions levels consisted of only the HDC conversion loss, the Free Space Path Loss and the gain of the measurement antenna as detailed in Table 4.5.2.4.

Over the out of band spectrum investigated from 30 MHz to 200 GHz, reportable spurious emissions were detected and determined to be compliant with the Part 30 limit. The minimum margin, measured in the vertical polarization, was .1.67 dB at 129.06386 GHz. Additionally, from 30 MHz to 10 GHz all non-transmitter emissions were a minimum of 6.15 dB below the Part 15 Class B limit of 54.5 dB μ V/m.

This demonstrates that the **AirScale 39 GHz Radio Unit (AEWF) Band 30, FCC ID: VBNAEWF-01**, the subject of this application, complies with FCC Part 15 Class B, and FCC Sections 2.1053, 30.203 and 2.1057 of the Rules.

Photographs of the measurement setup are in the filing exhibits.

Figure 4.5 Radiated Emissions Product Setup
Radiated Emissions Setup
Nokia AirScale 39 GHz Radio Unit (AEUA)

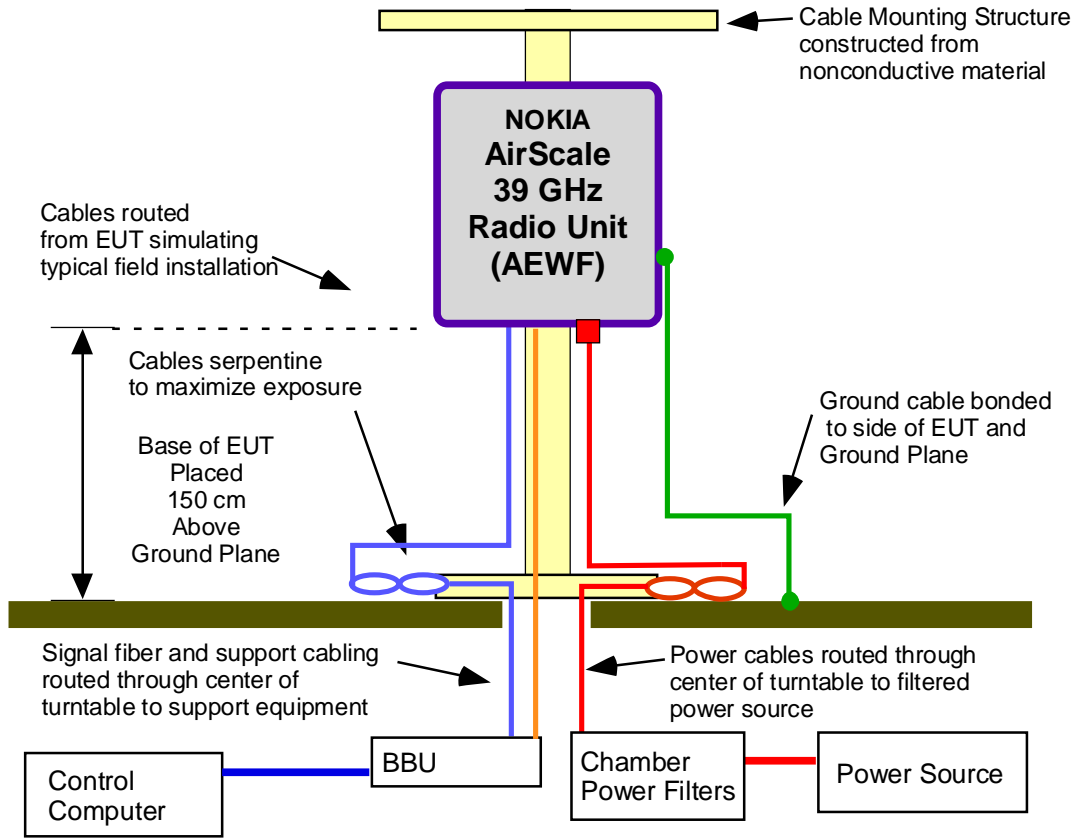

AirScale 39 GHz Radio Unit
AEWF RE Setup
W.S. Majkowski 10-2-2018

Preview Data

Freq. MHz	Raw dBuV	Cable dB	Factor dB	Level dBuV/m	Emission Type	Pol H/V	Ht cm	Az deg	Limit dBuV/m	Margin dB	Pass /Fail	Comments
131.688	47.61	1.55	-9.43	39.73	Debug	V	160	180	43.50	-3.77	Pass	
132.744	46.72	1.56	-9.42	38.86	Debug	H	102	135	43.50	-4.64	Pass	
133.176	46.42	1.56	-9.41	38.57	Debug	H	102	180	43.50	-4.93	Pass	
131.976	46.12	1.56	-9.43	38.25	Debug	V	160	135	43.50	-5.25	Pass	
115.512	47.45	1.45	-11.04	37.87	Debug	V	260	315	43.50	-5.63	Pass	
133.728	45.44	1.57	-9.40	37.61	Debug	H	102	135	43.50	-5.89	Pass	
131.136	45.49	1.55	-9.44	37.60	Debug	V	160	180	43.50	-5.90	Pass	
112.008	47.77	1.43	-11.62	37.58	Debug	H	102	135	43.50	-5.92	Pass	
132.264	45.30	1.56	-9.42	37.44	Debug	V	260	0	43.50	-6.06	Pass	
114.000	47.13	1.44	-11.29	37.28	Debug	V	260	90	43.50	-6.22	Pass	
114.528	46.92	1.45	-11.20	37.16	Debug	V	260	135	43.50	-6.34	Pass	
128.928	45.00	1.54	-9.48	37.06	Debug	V	260	0	43.50	-6.44	Pass	
115.056	46.62	1.45	-11.11	36.96	Debug	V	260	315	43.50	-6.54	Pass	
409.608	46.25	2.86	-9.70	39.42	Debug	H	102	0	46.00	-6.58	Pass	
126.408	44.92	1.52	-9.53	36.91	Debug	V	260	0	43.50	-6.59	Pass	
113.400	46.78	1.44	-11.39	36.83	Debug	H	102	135	43.50	-6.67	Pass	
112.872	46.82	1.43	-11.48	36.78	Debug	H	102	135	43.50	-6.72	Pass	
134.088	44.61	1.57	-9.39	36.78	Debug	V	160	135	43.50	-6.72	Pass	
128.136	44.73	1.53	-9.50	36.77	Debug	V	260	0	43.50	-6.73	Pass	
128.304	44.50	1.53	-9.49	36.54	Debug	V	160	180	43.50	-6.96	Pass	
116.160	45.73	1.46	-10.93	36.26	Debug	V	260	315	43.50	-7.24	Pass	
126.672	44.25	1.52	-9.52	36.25	Debug	V	260	0	43.50	-7.25	Pass	
115.920	45.74	1.46	-10.97	36.22	Debug	V	260	315	43.50	-7.28	Pass	
116.664	45.34	1.46	-10.85	35.95	Debug	V	260	315	43.50	-7.55	Pass	
134.496	43.65	1.57	-9.39	35.83	Debug	V	160	135	43.50	-7.67	Pass	
122.616	44.11	1.50	-9.91	35.69	Debug	V	260	315	43.50	-7.81	Pass	
135.216	43.47	1.58	-9.38	35.67	Debug	H	102	135	43.50	-7.83	Pass	
122.184	44.14	1.50	-9.98	35.65	Debug	V	260	315	43.50	-7.85	Pass	
118.248	44.76	1.47	-10.60	35.63	Debug	V	260	315	43.50	-7.87	Pass	
120.384	44.26	1.48	-10.26	35.49	Debug	V	260	0	43.50	-8.01	Pass	
125.400	43.49	1.52	-9.54	35.46	Debug	V	260	0	43.50	-8.04	Pass	
119.592	44.36	1.48	-10.38	35.45	Debug	V	160	315	43.50	-8.05	Pass	
111.360	45.69	1.42	-11.73	35.38	Debug	V	260	90	43.50	-8.12	Pass	
121.704	43.92	1.49	-10.05	35.35	Debug	V	360	0	43.50	-8.15	Pass	
124.320	43.40	1.51	-9.65	35.26	Debug	V	260	180	43.50	-8.24	Pass	
123.288	43.53	1.50	-9.81	35.22	Debug	V	260	315	43.50	-8.28	Pass	
120.864	43.71	1.49	-10.19	35.01	Debug	V	260	0	43.50	-8.49	Pass	
135.408	42.71	1.58	-9.37	34.91	Debug	V	260	45	43.50	-8.59	Pass	
138.480	42.48	1.59	-9.32	34.75	Debug	V	360	45	43.50	-8.75	Pass	
118.944	43.67	1.48	-10.49	34.66	Debug	V	260	180	43.50	-8.84	Pass	
117.528	43.80	1.47	-10.71	34.55	Debug	V	260	180	43.50	-8.95	Pass	
137.208	42.23	1.59	-9.34	34.47	Debug	V	160	135	43.50	-9.03	Pass	
136.008	42.13	1.58	-9.36	34.35	Debug	V	160	135	43.50	-9.15	Pass	
121.320	42.81	1.49	-10.11	34.19	Debug	V	260	0	43.50	-9.31	Pass	
136.440	41.87	1.58	-9.36	34.09	Debug	V	160	135	43.50	-9.41	Pass	
737.280	37.32	3.59	-4.35	36.55	Debug	H	102	0	46.00	-9.45	Pass	
123.816	42.26	1.51	-9.73	34.04	Debug	V	160	180	43.50	-9.46	Pass	

Note: Preview data was measured using a peak detector to identify frequencies of interest for formal measurement. Formal data consist of all frequencies in the preview list within 6 dB of specification limit or the top six frequencies. Failure in preview data does not necessarily constitute failure in formal data.

T1 Radiated Emissions 1GHz - 10GHz Tx-On

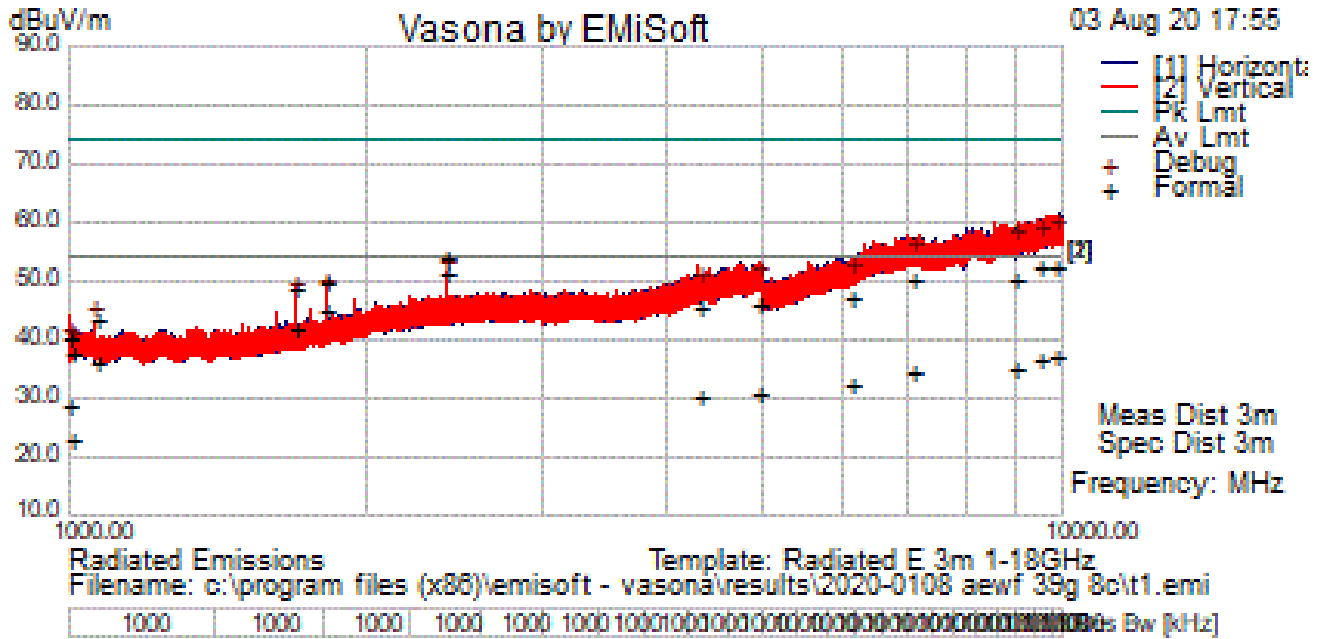

Test Information

Results Title	Radiated E 3m 1-18GHz
File Name	T1 RE1G-10G FCCB 8C-Tx On.emi
Test Laboratory	Global Product Compliance Lab
Test Engineer	MJS
Test Software	Vasona by EMISoft, version 6.061
Equipment	Nokia Wireless Group
EUT Details	AEWF, 39GHz. PN: 474870A.X21, SN: L1183608589, 8C, Modulation 16QAM, 57dBm/polarity, transmitting Top of Band 8C.
Configuration	Powered by -48VDC, Tested to FCC Class B, RE 1G-10GHz, @ 3-Meters, Double ridge E1074, Preamp-E1388, FSWL, Notch Filters E1361 & E1362. Internal attenuation 10dB, Preview RBW 100k; Formal RBW 1M. LMI Board connected
Date	2020-08-03 21:51:22

Formal Data

Freq. (MHz)	Raw (dBuV)	Cable (dB)	Factor (dB)	Level (dBuV/m)	Emission Type	Pol (H/V)	Ht (cm)	Az (deg)	Limit (dBuV/m)	Margin (dB)	Pass/Fail	Comments
2399.959	42.99	4.67	3.79	51.45	AvgMax	V	105	9	54.00	-2.55	Pass	
1812.354	39.50	3.99	1.54	45.03	AvgMax	V	103	223	54.00	-8.97	Pass	
1687.428	37.45	3.83	0.77	42.05	AvgMax	V	168	328	54.00	-11.95	Pass	
9874.156	18.87	10.05	8.39	37.31	AvgMax	V	261	287	54.00	-16.69	Pass	
9527.962	18.81	9.92	7.93	36.67	AvgMax	V	246	355	54.00	-17.33	Pass	
1062.535	33.63	3.11	-0.50	36.24	AvgMax	V	158	136	54.00	-17.76	Pass	
8994.976	17.93	9.91	7.45	35.29	AvgMax	V	217	337	54.00	-18.71	Pass	
7103.952	16.94	10.37	7.38	34.68	AvgMax	V	109	102	54.00	-19.32	Pass	
2399.959	45.57	4.67	3.79	54.03	PeakMax	V	105	9	74.00	-19.97	Pass	
6151.769	15.89	9.82	7.00	32.71	AvgMax	V	118	45	54.00	-21.29	Pass	
9874.156	33.99	10.05	8.39	52.43	PeakMax	V	261	287	74.00	-21.57	Pass	
9527.962	34.50	9.92	7.93	52.36	PeakMax	V	246	355	74.00	-21.64	Pass	
4960.209	17.43	7.65	5.75	30.83	AvgMax	V	231	0	54.00	-23.17	Pass	

Preview Data

Freq. (MHz)	Raw (dBuV)	Cable (dB)	Factor (dB)	Level (dBuV/m)	Emission Type	Pol (H/V)	Ht (cm)	Az (deg)	Limit (dBuV/m)	Margin (dB)	Pass/Fail	Comments
9874.156	39.58	10.05	8.39	58.02	Debug	V	100	315	54.00	4.02	Fail	
9527.962	39.17	9.92	7.93	57.03	Debug	V	100	315	54.00	3.03	Fail	
8994.976	39.25	9.91	7.45	56.61	Debug	V	100	315	54.00	2.61	Fail	
7103.952	36.83	10.37	7.38	54.58	Debug	V	100	315	54.00	0.58	Fail	
2399.912	42.48	4.67	3.79	50.94	Debug	V	100	315	54.00	-3.06	Pass	
6151.769	34.02	9.82	7.00	50.84	Debug	V	100	315	54.00	-3.16	Pass	
4960.209	36.98	7.65	5.75	50.38	Debug	V	100	315	54.00	-3.62	Pass	
4330.121	36.82	6.95	5.31	49.08	Debug	V	100	315	54.00	-4.92	Pass	
1812.212	42.42	3.99	1.54	47.95	Debug	V	100	315	54.00	-6.05	Pass	
1687.635	43.12	3.84	0.77	47.73	Debug	V	100	315	54.00	-6.27	Pass	
1062.333	40.47	3.11	-0.50	43.08	Debug	V	100	315	54.00	-10.92	Pass	
1000.497	36.84	3.03	-0.50	39.37	Debug	V	100	315	54.00	-14.63	Pass	
1009.253	36.61	3.05	-0.50	39.15	Debug	V	100	315	54.00	-14.85	Pass	

Note: Preview data was measured using a peak detector to identify frequencies of interest for formal measurement. Formal data consist of all frequencies in the preview list within 6 dB of specification limit or the top six frequencies. Failure in preview data does not necessarily constitute failure in formal data.

T1e Radiated Emissions 1GHz - 10GHz Tx-Off

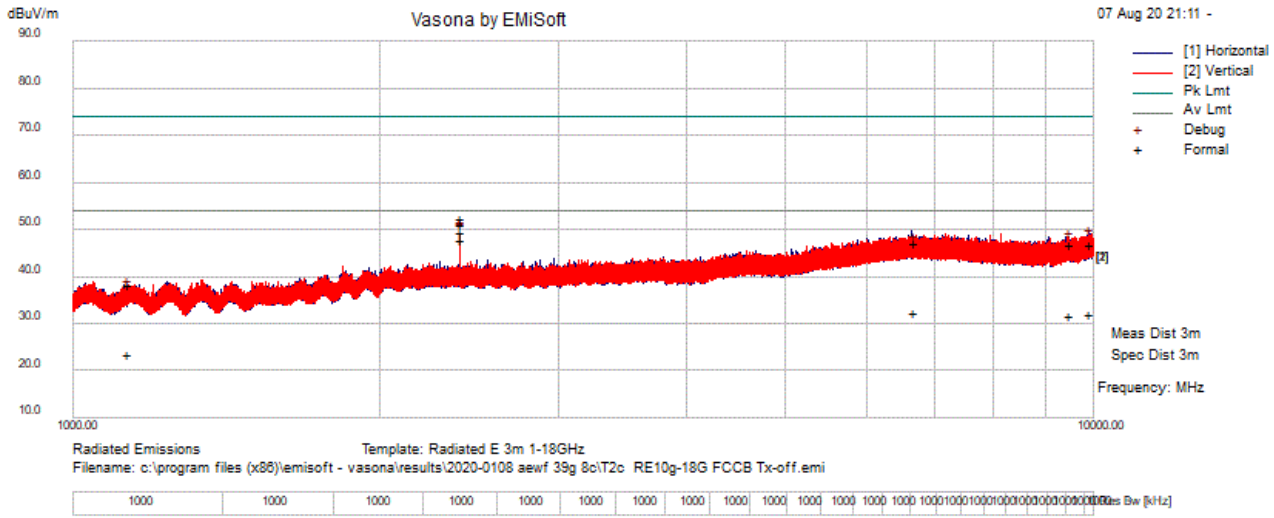

Test Information

Results Title	Radiated E 3m 1-18GHz
File Name	T1e RE1g-10G FCCB Tx-off.emi
Test Laboratory	Global Product Compliance Lab
Test Engineer	MJS
Test Software	Vasona by EMISoft, version 6.061
Equipment	Nokia Wireless Group
EUT Details	AEWF, 39GHz. PN: 474870A.X21, SN: L1183608589, 8C, Modulation 16QAM, 57dBm/polarity,Tx off.
Configuration	Powered by -48VDC, Tested to FCC Class B, RE 1G-10GHz, @ 3-Meters, Double ridge E1074, Preamp-E1388, FSWL, Notch Filters E1361 & E1362. Internal attenuation 10dB, Internal preamp on, Preview RBW 1M; Formal RBW 1M LMI board disconnected.
Date	2020-08-07 23:19:31

Formal Data

Freq. (MHz)	Raw (dBuV)	Cable (dB)	Factor (dB)	Level (dBuV/m)	Emission Type	Pol (H/V)	Ht (cm)	Az (deg)	Limit (dBuV/m)	Margin (dB)	Pass/Fail	Comments
2400.005	40.93	4.67	3.79	49.39	AvgMax	H	269	170	54.00	-4.61	Pass	
2400.026	39.55	4.67	3.79	48.01	AvgMax	V	125	240	54.00	-5.99	Pass	
2400.005	44.02	4.67	3.79	52.48	PeakMax	H	269	170	74.00	-21.52	Pass	
6668.068	14.68	10.31	7.33	32.31	AvgMax	V	232	7	54.00	-21.69	Pass	
9908.319	13.75	10.06	8.44	32.24	AvgMax	V	192	122	54.00	-21.76	Pass	
9473.272	13.95	9.91	7.87	31.74	AvgMax	H	201	133	54.00	-22.26	Pass	
2400.026	42.81	4.67	3.79	51.27	PeakMax	V	125	240	74.00	-22.73	Pass	
6668.068	29.64	10.31	7.33	47.28	PeakMax	V	232	7	74.00	-26.72	Pass	
9908.319	28.53	10.06	8.44	47.03	PeakMax	V	192	122	74.00	-26.97	Pass	
9473.272	29.11	9.91	7.87	46.90	PeakMax	H	201	133	74.00	-27.10	Pass	
1131.097	20.83	3.20	-0.50	23.52	AvgMax	H	247	52	54.00	-30.48	Pass	
1131.097	35.75	3.20	-0.50	38.45	PeakMax	H	247	52	74.00	-35.55	Pass	

Preview Data

Freq. (MHz)	Raw (dBuV)	Cable (dB)	Factor (dB)	Level (dBuV/m)	Emission Type	Pol (H/V)	Ht (cm)	Az (deg)	Limit (dBuV/m)	Margin (dB)	Pass/Fail	Comments
2400.026	39.54	4.67	3.79	48.00	Debug	V	101	314	54.00	-6.00	Pass	
2400.005	39.25	4.67	3.79	47.71	Debug	H	101	314	54.00	-6.29	Pass	
1131.097	32.94	3.20	-0.50	35.64	Debug	H	101	314	54.00	-18.36	Pass	
9473.272	28.01	9.91	7.87	45.80	Debug	H	101	314	54.00	-8.20	Pass	
6668.068	27.36	10.31	7.33	44.99	Debug	V	101	314	54.00	-9.01	Pass	
9908.319	27.78	10.06	8.44	46.28	Debug	V	101	314	54.00	-7.72	Pass	

Note: Preview data was measured using a peak detector to identify frequencies of interest for formal measurement. Formal data consist of all frequencies in the preview list within 6 dB of specification limit or the top six frequencies. Failure in preview data does not necessarily constitute failure in formal data.

T2b Radiated Emissions 10GHz - 18GHz Tx-On

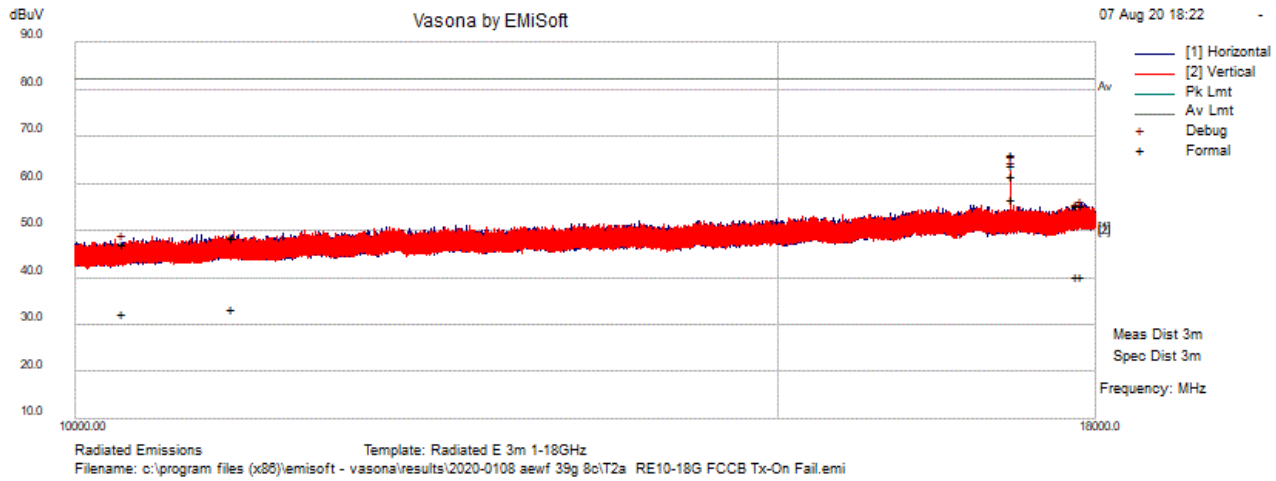

Test Information

Results Title	Radiated E 3m 1-18GHz
File Name	T2b RE10G-18G P30 Tx-On.emi
Test Laboratory	Global Product Compliance Lab
Test Engineer	MJS
Test Software	Vasona by EMISoft, version 6.061
Equipment	Nokia Wireless Group
EUT Details	AEFW, 39GHz. PN: 474870A.X21, SN: L1183608589, 8C, Modulation 16QAM, 57dBm/polarity, transmitting Top of Band 8C.
Configuration	Powered by -48VDC, Tested to FCC Part 30, RE 10G-18GHz, @ 3-Meters, Double ridge E1074, Preamp-E1388, FSWL, Notch Filters E1361 & E1362. Internal attenuation 10dB, Internal preamp on, Preview RBW 1M; Formal RBW 1M LMI board disconnected.
Date	2020-08-07 18:34:23

Formal Data

Freq. (MHz)	Raw (dBuV)	Cable (dB)	Factor (dB)	Level (dBuV/m)	Emission Type	Pol (H/V)	Ht (cm)	Az (deg)	Limit (dBuV/m)	Margin (dB)	Pass/Fail	Comments
17150.350	34.83	14.47	14.55	63.85	AvgMax	V	181	332	82.23	-18.38	Pass	
17150.465	27.72	14.47	14.55	56.74	AvgMax	H	214	76	82.23	-25.49	Pass	
17852.486	11.43	14.79	14.15	40.37	AvgMax	H	192	132	82.23	-41.86	Pass	
17800.095	11.45	14.77	14.13	40.35	AvgMax	V	272	6	82.23	-41.88	Pass	
10947.425	13.35	11.09	9.13	33.56	AvgMax	V	103	300	82.23	-48.67	Pass	
10280.111	13.31	10.41	8.77	32.49	AvgMax	H	113	78	82.23	-49.74	Pass	

Preview Data

Freq. (MHz)	Raw (dBuV)	Cable (dB)	Factor (dB)	Level (dBuV/m)	Emission Type	Pol (H/V)	Ht (cm)	Az (deg)	Limit (dBuV/m)	Margin (dB)	Pass/Fail	Comments
17800.095	23.00	14.77	14.13	51.90	Debug	V	100	315	82.23	-30.33	Pass	
17150.350	33.22	14.47	14.55	62.24	Debug	V	100	315	82.23	-19.99	Pass	
17852.486	23.71	14.79	14.15	52.65	Debug	H	100	315	82.23	-29.58	Pass	
17150.465	31.78	14.47	14.55	60.80	Debug	H	100	315	82.23	-21.43	Pass	
10280.111	26.17	10.41	8.77	45.35	Debug	H	100	315	82.23	-36.88	Pass	
10947.425	24.87	11.09	9.13	45.09	Debug	V	100	315	82.23	-37.14	Pass	

T2c Radiated Emissions 10GHz - 18GHz Tx-Off

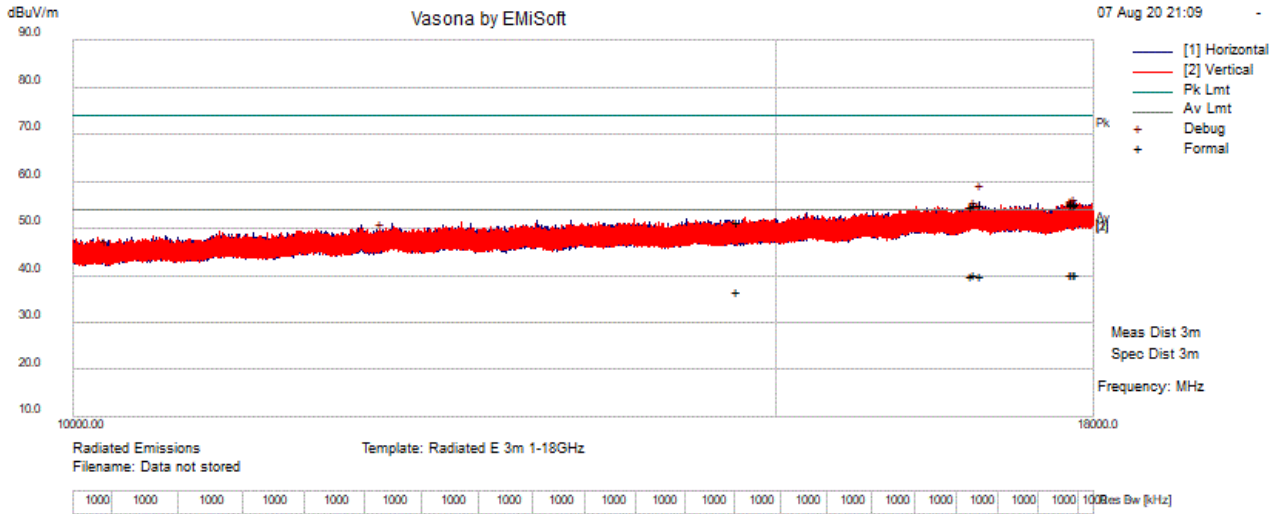

Test Information

Results Title	Radiated E 3m 1-18GHz
File Name	T2c RE10g-18G FCCB Tx-off.emi
Test Laboratory	Global Product Compliance Lab
Test Engineer	MJS
Test Software	Vasona by EMISoft, version 6.061
Equipment	Nokia Wireless Group
EUT Details	AEFW, 39GHz. PN: 474870A.X21, SN: L1183608589, 8C, Modulation 16QAM, 57dBm/polarity ,Tx off.
Configuration	Powered by -48VDC, Tested to FCC Class B, RE 10G-18GHz, @ 3-Meters, Double ridge E1074, Preamp-E1388, FSWL, Notch Filters E1361 & E1362. Internal attenuation 0dB, Internal preamp on, Preview RBW 1M; Formal RBW 1M LMI board disconnected.
Date	2020-08-07 21:11:25

Formal Data

Freq. (MHz)	Raw (dBuV)	Cable (dB)	Factor (dB)	Level (dBuV/m)	Emission Type	Pol (H/V)	Ht (cm)	Az (deg)	Limit (dBuV/m)	Margin (dB)	Pass/Fail	Comments
17815.796	11.48	14.77	14.14	40.40	AvgMax	V	233	260	54.00	-13.60	Pass	
17800.095	11.43	14.77	14.13	40.33	AvgMax	H	114	340	54.00	-13.67	Pass	
17768.735	11.44	14.75	14.12	40.32	AvgMax	H	112	286	54.00	-13.68	Pass	
17768.735	11.41	14.75	14.12	40.28	AvgMax	H	125	306	54.00	-13.72	Pass	
16803.727	11.47	14.27	14.44	40.19	AvgMax	H	138	129	54.00	-13.81	Pass	
16774.122	11.47	14.26	14.39	40.12	AvgMax	V	235	131	54.00	-13.88	Pass	
16865.746	11.15	14.31	14.55	40.02	AvgMax	H	226	164	54.00	-13.98	Pass	
14653.020	11.71	13.25	11.76	36.72	AvgMax	V	129	99	54.00	-17.28	Pass	
17768.735	26.56	14.75	14.12	55.43	PeakMax	H	125	306	74.00	-18.57	Pass	
17815.796	26.48	14.77	14.14	55.40	PeakMax	V	233	260	74.00	-18.60	Pass	
16803.727	26.51	14.27	14.44	55.23	PeakMax	H	138	129	74.00	-18.77	Pass	
17800.095	26.15	14.77	14.13	55.05	PeakMax	H	114	340	74.00	-18.95	Pass	
17768.735	26.13	14.75	14.12	55.01	PeakMax	H	112	286	74.00	-18.99	Pass	
16865.746	26.15	14.31	14.55	55.01	PeakMax	H	226	164	74.00	-18.99	Pass	
16774.122	26.14	14.26	14.39	54.78	PeakMax	V	235	131	74.00	-19.22	Pass	
14653.020	26.52	13.25	11.76	51.53	PeakMax	V	129	99	74.00	-22.47	Pass	

Preview Data

Freq. (MHz)	Raw (dBuV)	Cable (dB)	Factor (dB)	Level (dBuV/m)	Emission Type	Pol (H/V)	Ht (cm)	Az (deg)	Limit (dBuV/m)	Margin (dB)	Pass/Fail	Comments
16865.746	26.64	14.31	14.55	55.50	Debug	H	101	315	54.00	1.50	Fail	
17800.095	23.75	14.77	14.13	52.65	Debug	H	101	315	54.00	-1.35	Pass	
17768.735	23.50	14.75	14.12	52.38	Debug	H	101	315	54.00	-1.62	Pass	
17768.735	23.06	14.75	14.12	51.94	Debug	H	101	315	54.00	-2.06	Pass	
16803.727	23.20	14.27	14.44	51.92	Debug	H	101	315	54.00	-2.08	Pass	
17815.796	22.81	14.77	14.14	51.72	Debug	V	101	315	54.00	-2.28	Pass	
16774.122	22.40	14.26	14.39	51.05	Debug	V	101	315	54.00	-2.95	Pass	
14653.020	22.81	13.25	11.76	47.82	Debug	V	101	315	54.00	-6.18	Pass	
11935.401	25.17	11.83	10.33	47.33	Debug	V	101	315	54.00	-6.67	Pass	
10180.892	24.85	10.30	8.70	43.84	Debug	V	101	315	54.00	-10.16	Pass	

Note: Preview data was measured using a peak detector to identify frequencies of interest for formal measurement. Formal data consist of all frequencies in the preview list within 6 dB of specification limit or the top six frequencies. Failure in preview data does not necessarily constitute failure in formal data.

T4a Radiated Emissions 18GHz – 26.5GHz Tx-On

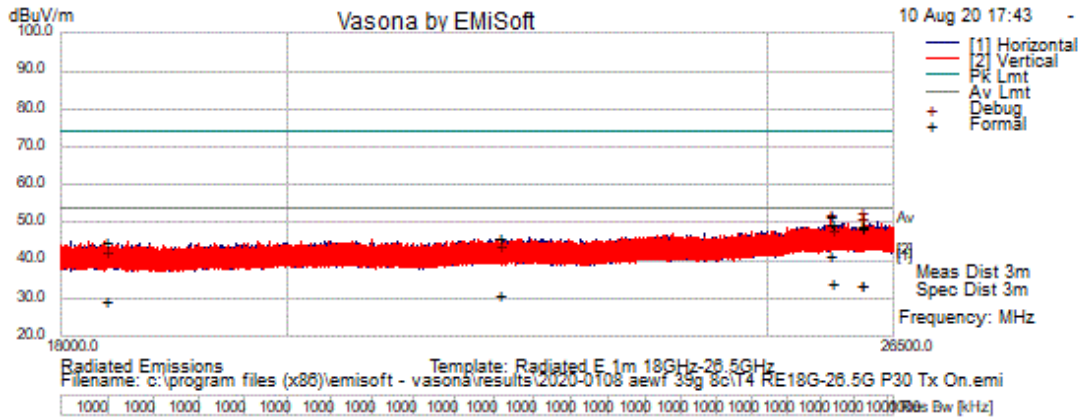

Test Information

Results Title	Radiated E 1m 18GHz-26.5GHz
File Name	T4a RE18G-26.5G Part 15b Tx On.emi
Test Laboratory	Global Product Compliance Lab
Test Engineer	MJS
Test Software	Vasona by EMIsoft, version 6.061
Equipment	Nokia Wireless Group
EUT Details	AEWF, 39GHz. PN: 474870A.X21, SN: L1183608589, 8C, Modulation 16QAM, 57dBm/polarity, Tx on.
Configuration	Powered by -48VDC, Tested to FCC Class B, RE 18G-26.5GHz, @ 3-Meters, A-INFO Horn Antenna E1451, Preamp-E1388, FSWL, Notch Filters E1361 & E1362, E1501 & E1502 cables. Internal attenuation 10dB, Internal preamp on, Preview RBW 1M; Formal RBW 1M, LMI board connected.
Date	2020-08-10 17:45:58

Formal Data

Freq. (MHz)	Raw (dBuV)	Cable (dB)	Factor (dB)	Level (dBuV/m)	Emission Type	Pol (H/V)	Ht (cm)	Az (deg)	Limit (dBuV/m)	Margin (dB)	Pass/Fail	Comments
25725.549	14.20	17.02	10.26	41.48	AvgMax	H	175	56	54.00	-12.52	Pass	
25750.041	6.65	17.03	10.29	33.97	AvgMax	H	185	208	54.00	-20.03	Pass	
26126.998	5.88	17.18	10.65	33.71	AvgMax	H	136	255	54.00	-20.29	Pass	
26126.520	5.76	17.18	10.65	33.59	AvgMax	H	247	44	54.00	-20.41	Pass	
25725.549	24.33	17.02	10.26	51.61	PeakMax	H	175	56	74.00	-22.39	Pass	
22073.868	8.31	15.98	6.51	30.80	AvgMax	V	176	308	54.00	-23.20	Pass	
25750.041	22.44	17.03	10.29	49.76	PeakMax	H	185	208	74.00	-24.24	Pass	
26126.998	21.55	17.18	10.65	49.38	PeakMax	V	250	205	74.00	-24.62	Pass	
18390.563	9.57	14.76	4.99	29.31	AvgMax	V	100	170	54.00	-24.69	Pass	
26126.520	20.93	17.18	10.65	48.76	PeakMax	H	247	44	74.00	-25.24	Pass	
22073.868	23.54	15.98	6.51	46.03	PeakMax	H	124	242	74.00	-27.97	Pass	
18390.563	25.20	14.76	4.99	44.95	PeakMax	V	100	170	74.00	-29.05	Pass	

Preview Data

Freq. (MHz)	Raw (dBuV)	Cable (dB)	Factor (dB)	Level (dBuV/m)	Emission Type	Pol (H/V)	Ht (cm)	Az (deg)	Limit (dBuV/m)	Margin (dB)	Pass/Fail	Comments
26126.998	22.60	17.18	10.65	50.43	Debug	V	100	352	54.00	-3.57	Pass	
26126.520	20.78	17.18	10.65	48.61	Debug	V	100	352	54.00	-5.39	Pass	
18390.563	19.94	14.76	4.99	39.69	Debug	V	100	352	54.00	-14.31	Pass	
22073.868	18.84	15.98	6.51	41.33	Debug	V	100	352	54.00	-12.67	Pass	
25725.549	22.58	17.02	10.26	49.86	Debug	V	100	352	54.00	-4.14	Pass	
25750.041	18.47	17.03	10.29	45.79	Debug	V	100	352	54.00	-8.21	Pass	

Preview Data

Freq. (MHz)	Raw (dBuV)	Cable (dB)	Factor (dB)	Level (dBuV/m)	Emission Type	Pol (H/V)	Ht (cm)	Az (deg)	Limit (dBuV/m)	Margin (dB)	Pass/Fail	Comments
25339.100	22.59	16.91	9.63	49.13	Debug	H	200	0	54.00	-4.87	Pass	
26214.301	20.65	17.22	10.72	48.60	Debug	V	100	0	54.00	-5.40	Pass	
26246.240	20.44	17.24	10.74	48.42	Debug	V	150	0	54.00	-5.58	Pass	
26381.334	20.16	17.31	10.85	48.32	Debug	V	100	352	54.00	-5.68	Pass	
26128.299	20.46	17.18	10.65	48.30	Debug	V	200	0	54.00	-5.70	Pass	
25821.841	20.77	17.05	10.37	48.19	Debug	H	100	0	54.00	-5.81	Pass	
25919.207	20.61	17.09	10.47	48.16	Debug	H	100	0	54.00	-5.84	Pass	
25892.723	20.61	17.08	10.44	48.13	Debug	H	150	0	54.00	-5.87	Pass	
25485.838	21.19	16.94	9.99	48.12	Debug	H	100	352	54.00	-5.88	Pass	
26445.886	19.86	17.34	10.90	48.10	Debug	V	100	352	54.00	-5.90	Pass	
26231.374	20.13	17.23	10.73	48.10	Debug	V	100	352	54.00	-5.90	Pass	
25828.606	20.64	17.05	10.37	48.06	Debug	H	150	352	54.00	-5.94	Pass	
26316.253	19.98	17.28	10.80	48.06	Debug	H	150	352	54.00	-5.94	Pass	
25763.017	20.72	17.03	10.30	48.05	Debug	V	200	352	54.00	-5.95	Pass	
26434.159	19.82	17.34	10.89	48.04	Debug	V	100	352	54.00	-5.96	Pass	
26464.560	19.77	17.35	10.91	48.03	Debug	H	100	352	54.00	-5.97	Pass	
25943.285	20.41	17.09	10.49	47.99	Debug	H	150	352	54.00	-6.01	Pass	
26437.735	19.76	17.34	10.89	47.99	Debug	V	100	352	54.00	-6.01	Pass	
25541.600	20.96	16.95	10.07	47.98	Debug	V	100	352	54.00	-6.02	Pass	
25326.720	21.45	16.91	9.60	47.96	Debug	V	100	0	54.00	-6.04	Pass	
25670.838	20.75	17.00	10.21	47.96	Debug	V	100	352	54.00	-6.04	Pass	
25431.988	21.14	16.93	9.86	47.92	Debug	V	150	0	54.00	-6.08	Pass	
25845.170	20.44	17.06	10.39	47.89	Debug	V	150	0	54.00	-6.11	Pass	
26442.069	19.64	17.34	10.90	47.88	Debug	H	200	0	54.00	-6.12	Pass	
25423.645	21.11	16.92	9.84	47.87	Debug	H	100	352	54.00	-6.13	Pass	
26471.285	19.58	17.36	10.92	47.85	Debug	H	150	352	54.00	-6.15	Pass	
25858.285	20.38	17.06	10.40	47.85	Debug	V	100	352	54.00	-6.15	Pass	
25693.940	20.60	17.01	10.23	47.84	Debug	H	100	0	54.00	-6.16	Pass	
26033.686	20.10	17.13	10.58	47.81	Debug	H	150	0	54.00	-6.19	Pass	
26473.973	19.53	17.36	10.92	47.81	Debug	H	200	0	54.00	-6.19	Pass	
25846.092	20.35	17.06	10.39	47.80	Debug	V	200	352	54.00	-6.20	Pass	
25980.264	20.16	17.11	10.53	47.80	Debug	V	100	352	54.00	-6.20	Pass	
26475.322	19.51	17.36	10.92	47.79	Debug	V	200	352	54.00	-6.21	Pass	
26446.863	19.54	17.34	10.90	47.78	Debug	V	100	352	54.00	-6.22	Pass	
25995.478	20.12	17.11	10.55	47.78	Debug	H	100	0	54.00	-6.22	Pass	
26155.478	19.91	17.19	10.67	47.78	Debug	H	150	352	54.00	-6.22	Pass	
26455.304	19.52	17.35	10.91	47.77	Debug	H	200	0	54.00	-6.23	Pass	
26240.652	19.79	17.24	10.74	47.77	Debug	H	150	352	54.00	-6.23	Pass	
25727.229	20.46	17.02	10.27	47.75	Debug	V	200	0	54.00	-6.25	Pass	
26205.464	19.81	17.22	10.71	47.75	Debug	V	150	352	54.00	-6.25	Pass	
26239.141	19.77	17.24	10.74	47.74	Debug	H	100	352	54.00	-6.26	Pass	
25422.910	20.98	16.92	9.84	47.74	Debug	H	100	352	54.00	-6.26	Pass	
25877.643	20.24	17.07	10.42	47.74	Debug	V	100	0	54.00	-6.26	Pass	
26220.184	19.78	17.23	10.72	47.73	Debug	H	150	0	54.00	-6.27	Pass	
26492.900	19.42	17.37	10.93	47.72	Debug	H	150	352	54.00	-6.28	Pass	
26427.703	19.50	17.33	10.88	47.72	Debug	V	100	352	54.00	-6.28	Pass	
25320.116	21.23	16.90	9.58	47.72	Debug	H	200	0	54.00	-6.28	Pass	

Note: Preview data was measured using a peak detector to identify frequencies of interest for formal measurement. Formal data consist of all frequencies in the preview list within 6 dB of specification limit or the top six frequencies. Failure in preview data does not necessarily constitute failure in formal data.

T6a Radiated Emissions 26.5-37.0 GHz Tx-On

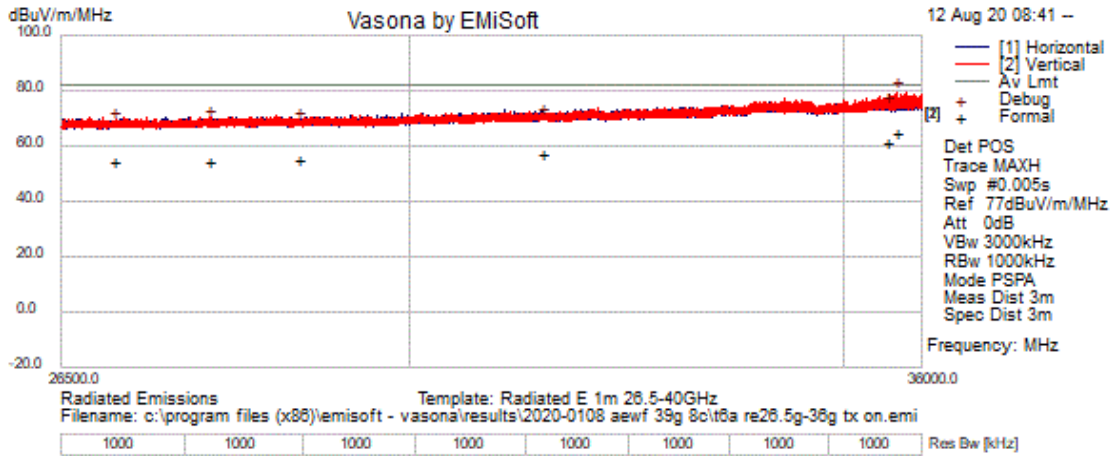

Test Information

Results Title	Radiated E 1m 26.5-40GHz
File Name	T6a RE26.5g-36g Part 30 tx on.emi
Test Laboratory	Global Product Compliance Lab
Test Engineer	MJS
Test Software	Vasona by EMISoft, version 6.061
Equipment	Nokia Wireless Group
EUT Details	AEWF, 39GHz. PN: 474870A.X21, SN: L1183608589, 8C, Modulation 16QAM, 57dBm/polarity,Tx on.
Configuration	Powered by -48VDC Tested to FCC Class B, RE 26.5G-36.5GHz, @ 3-Meters, A-INFO Horn Antenna E1373, FSWL, Notch Filters E1361 & E1362, E1501 & E1502 cables. Internal attenuation 0dB, Internal preamp on, Preview RBW 1M; Formal RBW 1M, LMI board connected.
Date	2020-08-12 08:41:53

Formal Data

Freq. (MHz)	Raw (dBuV)	Cable (dB)	Factor (dB)	Level (dBuV/m)	Emission Type	Pol (H/V)	Ht (cm)	Az (deg)	Limit (dBuV/m)	Margin (dB)	Pass/Fail	Comments
35693.625	6.98	21.14	36.93	65.06	AvgMax	V	190	17	82.23	-17.17	Pass	
35561.513	3.88	20.90	36.93	61.71	AvgMax	V	192	354	82.23	-20.52	Pass	
31450.281	2.44	19.07	36.21	57.72	AvgMax	V	124	302	82.23	-24.51	Pass	
27929.624	1.34	17.79	35.98	55.11	AvgMax	V	204	323	82.23	-27.12	Pass	
28833.873	1.41	18.11	35.93	55.44	AvgMax	H	194	316	82.23	-26.79	Pass	
26999.911	1.28	17.52	36.01	54.81	AvgMax	H	227	331	82.23	-27.42	Pass	

Preview Data

Freq. (MHz)	Raw (dBuV)	Cable (dB)	Factor (dB)	Level (dBuV/m)	Emission Type	Pol (H/V)	Ht (cm)	Az (deg)	Limit (dBuV/m)	Margin (dB)	Pass/Fail	Comments
35693.625	21.53	21.14	36.93	79.60	Debug	V	200	22	82.23	-2.63	Pass	
35561.513	16.39	20.90	36.93	74.22	Debug	V	100	352	82.23	-8.01	Pass	
31450.281	14.79	19.07	36.21	70.07	Debug	V	100	352	82.23	-12.16	Pass	
27929.624	15.41	17.79	35.98	69.18	Debug	V	100	352	82.23	-13.05	Pass	
28833.873	14.62	18.11	35.93	68.65	Debug	V	100	352	82.23	-13.58	Pass	
26999.911	14.82	17.52	36.01	68.35	Debug	V	100	352	82.23	-13.88	Pass	

Note: Preview data was measured using a peak detector to identify frequencies of interest for formal measurement. Formal data consist of all frequencies in the preview list within 6 dB of specification limit or the top six frequencies. Failure in preview data does not necessarily constitute failure in formal data.

T5b Radiated Emissions 26.5-40.0 GHz Tx-Off

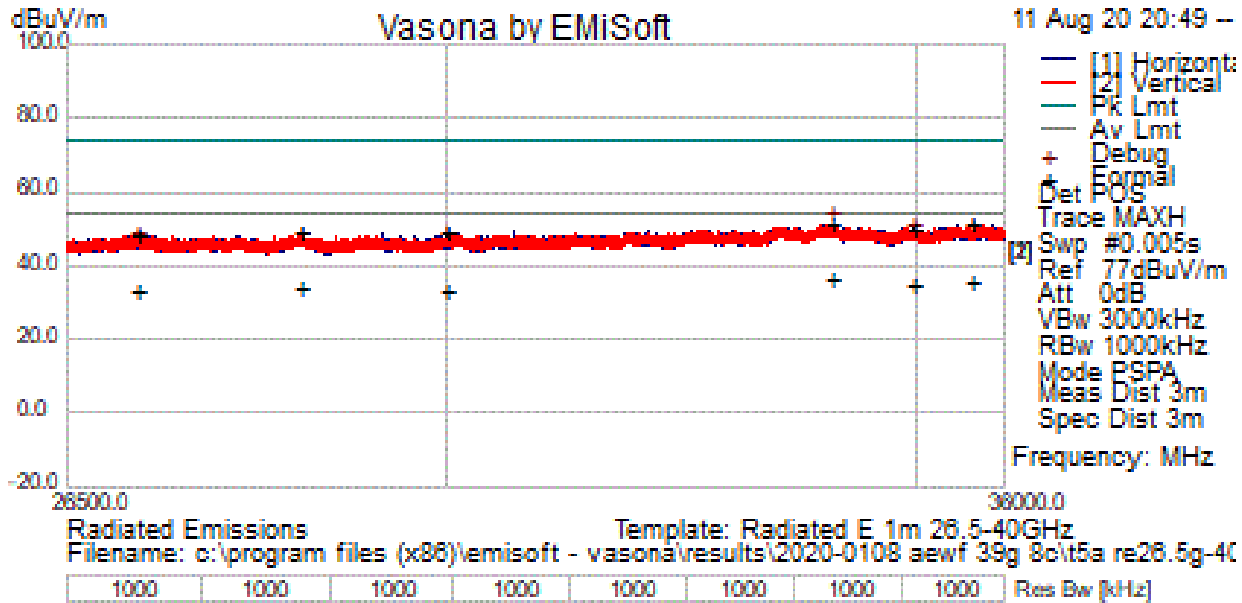

Test Information

Results Title	Radiated E 1m 26.5-40GHz
File Name	T5b RE26.5g-40G FCCB Tx-off.emi
Test Laboratory	Global Product Compliance Lab
Test Engineer	MJS
Test Software	Vasona by EMISoft, version 6.061
Equipment	Nokia Wireless Group
EUT Details	AEFW, 39GHz. PN: 474870A.X21, SN: L1183608589, 8C, Modulation 16QAM, 57dBm/polarity, Tx off.
Configuration	Powered by -48VDC, Tested to FCC Class B, RE 26.5G-36.5GHz, @ 3-Meters, A-INFO Horn Antenna E1373, AH Preamp-E1469, FSWL, Notch Filters E1361 & E1362, E1501 & E1502 cables. Internal attenuation 0dB, Internal preamp on, Preview RBW 1M; Formal RBW 1M, LMI board connected.
Date	2020-08-11 20:51:13

Formal Data

Freq. (MHz)	Raw (dBuV)	Cable (dB)	Factor (dB)	Level (dBuV/m)	Emission Type	Pol (H/V)	Ht (cm)	Az (deg)	Limit (dBuV/m)	Margin (dB)	Pass/Fail	Comments
34024.297	15.84	20.78	-0.28	36.35	AvgMax	V	131	132	54.00	-17.65	Pass	
35632.402	14.84	21.03	-0.05	35.81	AvgMax	V	191	117	54.00	-18.19	Pass	
34961.946	15.35	20.22	-0.31	35.25	AvgMax	H	134	199	54.00	-18.75	Pass	
28609.484	16.11	18.05	-0.22	33.95	AvgMax	H	174	204	54.00	-20.05	Pass	
30010.060	14.98	18.47	0.16	33.61	AvgMax	H	215	245	54.00	-20.39	Pass	
27124.277	15.21	17.55	0.40	33.16	AvgMax	V	183	291	54.00	-20.84	Pass	
34024.297	31.43	20.78	-0.28	51.94	PeakMax	V	131	132	74.00	-22.06	Pass	
35632.402	30.54	21.03	-0.05	51.52	PeakMax	V	191	117	74.00	-22.48	Pass	
34961.946	30.12	20.22	-0.31	50.03	PeakMax	H	134	199	74.00	-23.97	Pass	
30010.060	30.95	18.47	0.16	49.58	PeakMax	H	215	245	74.00	-24.42	Pass	
28609.484	31.37	18.05	-0.22	49.20	PeakMax	H	174	204	74.00	-24.80	Pass	
27124.277	30.29	17.55	0.40	48.24	PeakMax	V	183	291	74.00	-25.76	Pass	

Preview Data

Freq. (MHz)	Raw (dBuV)	Cable (dB)	Factor (dB)	Level (dBuV/m)	Emission Type	Pol (H/V)	Ht (cm)	Az (deg)	Limit (dBuV/m)	Margin (dB)	Pass/Fail	Comments
34024.297	30.56	20.78	-0.28	51.06	Debug	V	150	154	54.00	-2.94	Pass	
35632.402	27.36	21.03	-0.05	48.34	Debug	V	100	352	54.00	-5.66	Pass	
27124.277	27.91	17.55	0.40	45.86	Debug	V	100	352	54.00	-8.14	Pass	
30010.060	27.07	18.47	0.16	45.70	Debug	H	100	352	54.00	-8.30	Pass	
34961.946	27.95	20.22	-0.31	47.86	Debug	H	100	352	54.00	-6.14	Pass	
28609.484	28.30	18.05	-0.22	46.13	Debug	H	100	352	54.00	-7.87	Pass	

Note: Preview data was measured using a peak detector to identify frequencies of interest for formal measurement. Formal data consist of all frequencies in the preview list within 6 dB of specification limit or the top six frequencies. Failure in preview data does not necessarily constitute failure in formal data.

**Maximum Measured Radiated Emissions -U Band 40GHz-60GHz
 Vertical Polarization - 1 MHz RBW**

FCC B Part 30

2020-0108 AEFW 39G UNIT SNL11R3600589



23:14:01 30.07.2020

Horizontal Polarization - 1 MHz RBW

2020-0108 AEFW 39G UNIT SNL11R3600589



00:50:42 31.07.2020

**Maximum Measured Radiated Emissions -U Band 60GHz-90GHz
 Vertical Polarization - 1 MHz RBW**

FCC B Part 30

2020-0108 AEFW 39G UNIT SNL1183600589

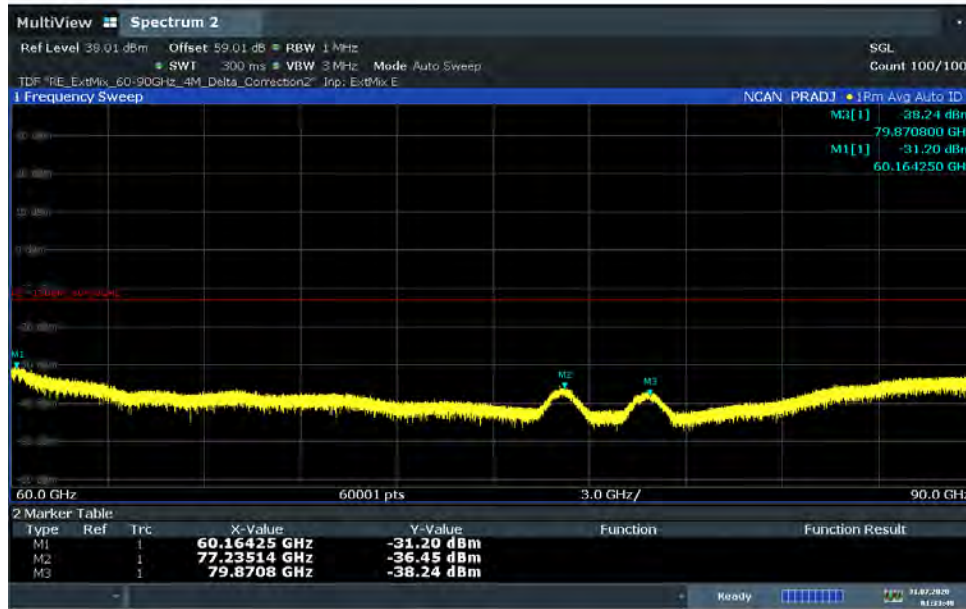

01:33:50 31.07.2020

Horizontal Polarization - 1 MHz RBW

2020-0108 AEFW 39G UNIT SNL1183600589



02:28:10 31.07.2020

Maximum Measured Radiated Emissions -U Band 90GHz-140GHz **FCC B Part 30**
Vertical Polarization - 1 MHz RBW



22:53:06 31.07.2020

Horizontal Polarization - 1 MHz RBW

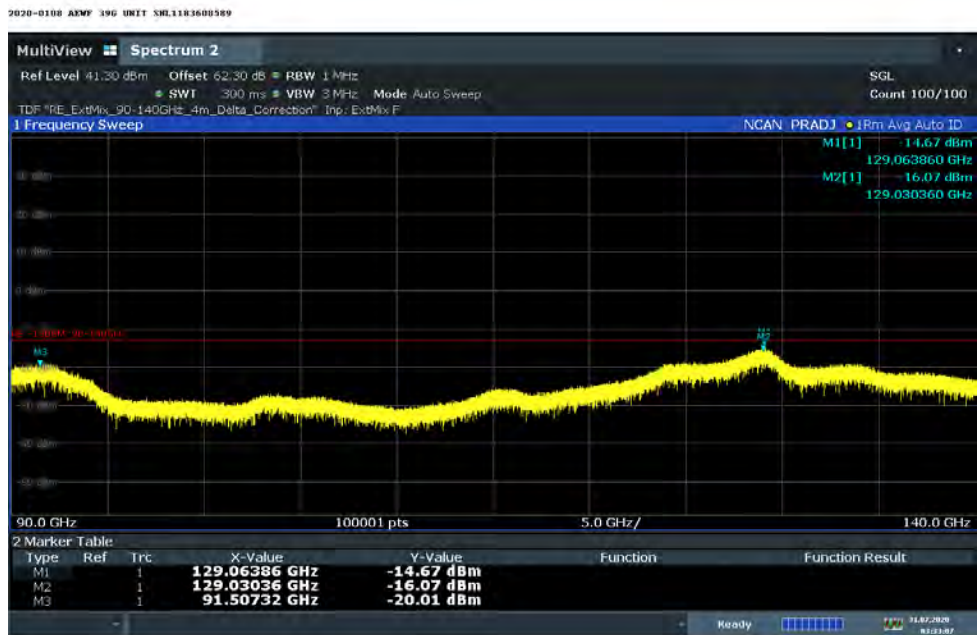

03:33:08 31.07.2020

Maximum Measured Radiated Emissions -U Band 140GHz-170GHz **FCC B Part 30**
Vertical Polarization - 1 MHz RBW

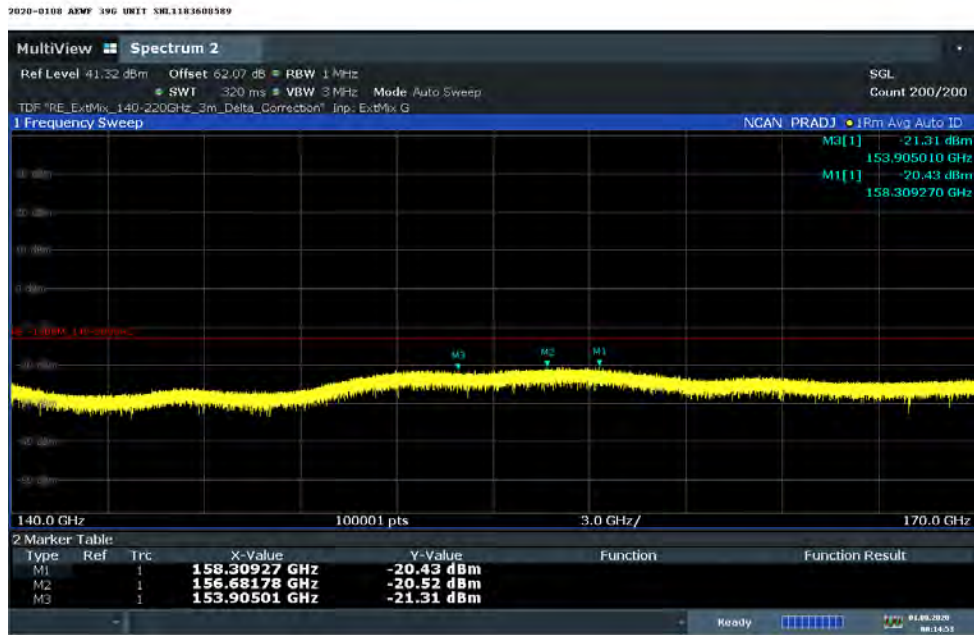

00:14:53 01.08.2020

Horizontal Polarization - 1 MHz RBW

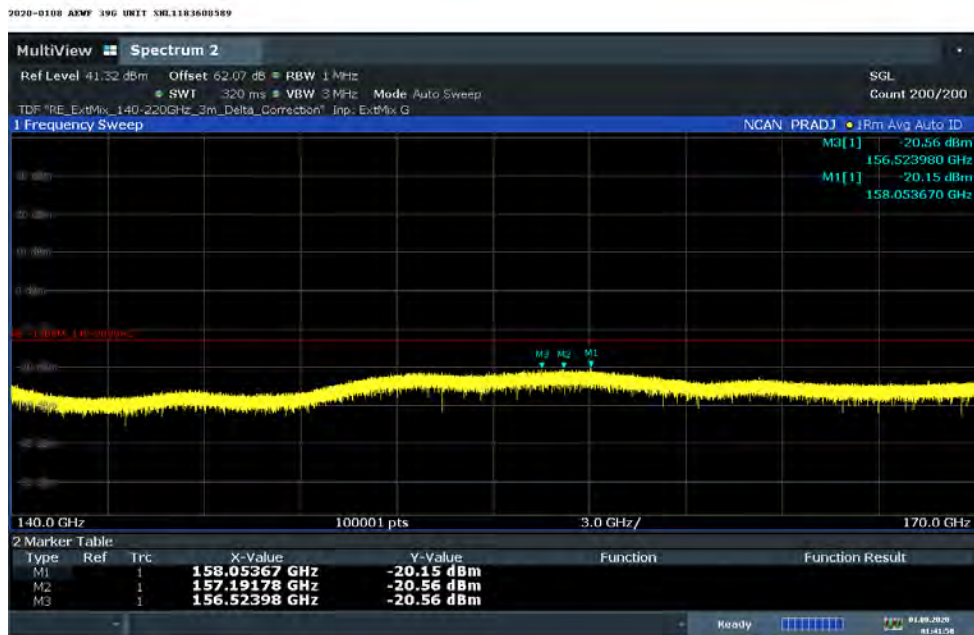

01:41:50 01.08.2020

Maximum Measured Radiated Emissions -U Band 170GHz-200GHz **FCC B Part 30**
Vertical Polarization - 1 MHz RBW

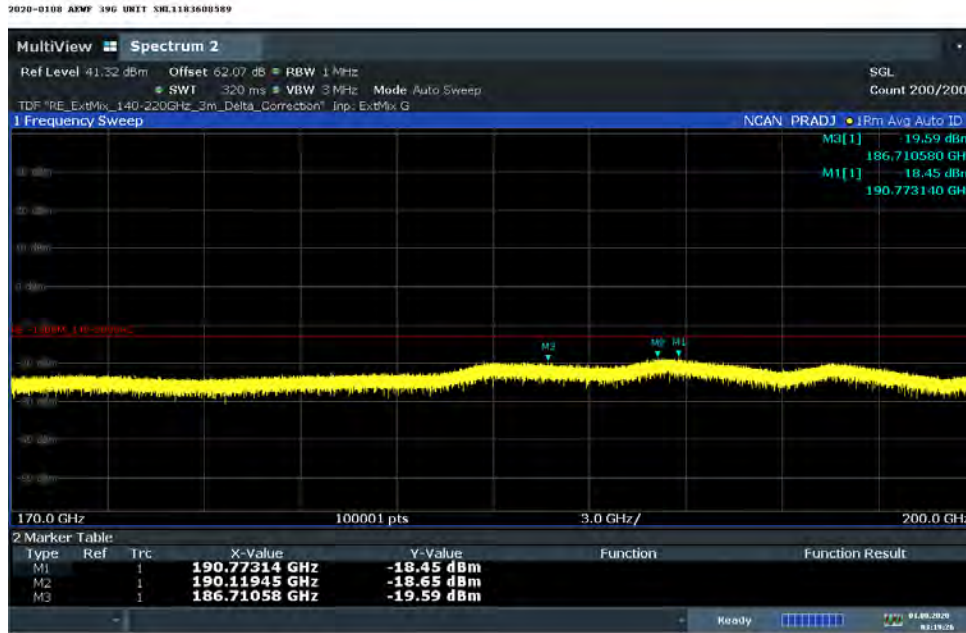

03:19:26 01.08.2020

Horizontal Polarization - 1 MHz RBW

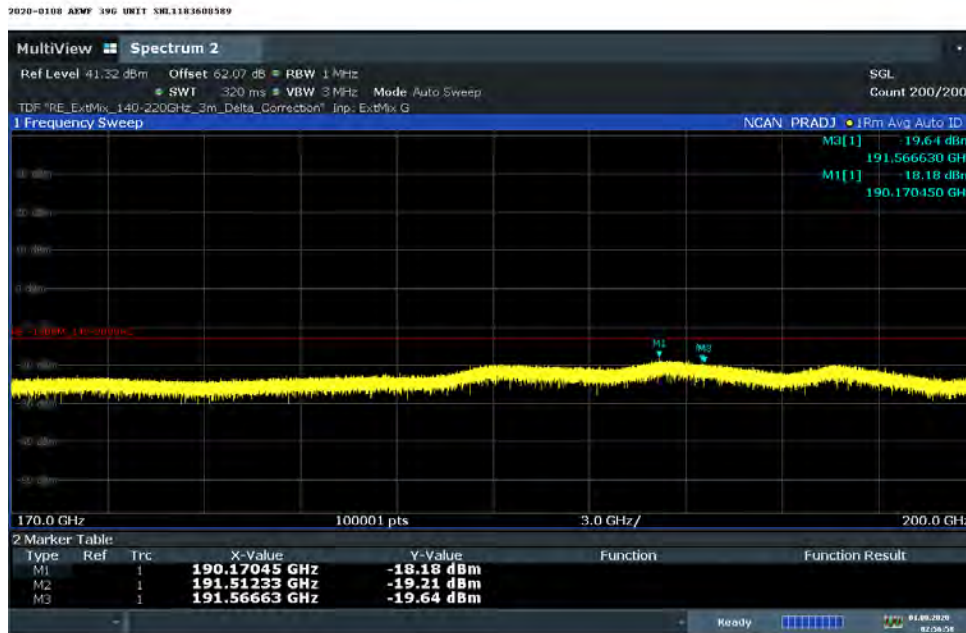

02:56:59 01.08.2020

4.6 Section 2.1055 MEASUREMENT NOT REQUIRED: FREQUENCY STABILITY

This measurement evaluates the frequency difference between the actual transmit carrier frequency and the specified transmit frequency assignment. Only the portion of the transmitter system containing the frequency determining and stabilizing circuitry need be put in an environmental chamber and subjected to the temperature variation test per FCC Section 2.1055 and RSS-133. The unit which provides baseband signals, such as BBU (baseband unit), can be located outside the chamber if it is a separated unit.

4.6.1 Frequency Stability Results:

There was no change to the Frequency Generating and stabilizing circuitry. Frequency stability testing was therefore not required.

4.6.2 Frequency Stability – Original Results:

The worst-case results of the original Frequency Stability over temperature and voltage for the DC Product was **-916.3 Hz** which is **-0.0239 ppm**.

This performance is within the +/- 0.05ppm desired performance required for LTE operation.

4.7 List of Test Equipment

4.7.1 List of Radio Measurements and Radiated Emissions Test Equipment

Table 4.7.1a Radiated Emissions and Radio Measurements

Asset ID	Manufacturer	Type	Description	Model	Serial	Cal Date	Cal Due	Cal Type
E1363	A-Info	Horn Antenna	26.5-40GHz WR28 dB	LB-28-25- C2-KF	J202062675	2018-10-16	2021-10-16	Requires Calibration
E1373	A-Info	Horn Antenna	26.5-40GHz WR28 dB	LB-28-25- C2-KF	J202062735	2018-12-05	2021-12-05	Requires Calibration
E1451	A-Info	Horn Antenna	18 to 26.5 GHz WR42 25 dB	LB-42-25- C2-KF	J202066360	2020-03-23	2020-08-23	
E1074	ETS Lindgren	Horn Antenna	Double-Ridged Waveguide Horn 1-18 GHz	3117	00135194	2019-05-01	2021-05-01	Requires Calibration
E1388	KeySight Technologies	Pre-Amplifier	0.5GHz - 0.18GHz, 15dBm	87405C	MY55380142		Note*6	Requires Calibration
E1387	Miteq	Pre-Amplifier	18 GHz-40 GHz, 45dB	TTA1840- 35-HG	2034		Note*	Requires Calibration
E1469	A.H. Systems Inc.	Pre-Amplifier	18 GHz-40 GHz, 37 dB	PAM- 1840VH	185		Note*6	Requires Calibration
E1361	Marki Microwave	Filter, Low Pass	DC - 36.6 GHz, 1W, 1.8 dB	FLP-3660	N/A			Calibration Not Required, Must Be Verified
E1362	Marki Microwave	Filter, Low Pass	DC - 36.6 GHz, 1W, 1.8 dB	FLP-3660	N/A			Calibration Not Required, Must Be Verified
E766	A.H. Systems Inc.	Biological Antenna	25 - 2000 MHz	SAS-521-2	457	2019-02-13	E766	Requires Calibration
E588	Sunol Sciences Corp	System Controller		SC99V	32802-1			Calibration Not Required
E1264	KeySight Technologies	PSG Signal Generator	Analog Sig Gen 100kHz-67 GHz	E8257D	MY53402943	2019-10-30	2021-11-30	Requires Calibration
E485	Kikusui	Power Supply	DC 55 Volts 120 Amps	PAD 55- 120L	DL000416			Verification
E1315	RS Microwave Company, Inc.	Microwave Filter		P/N 60733A	007			Verification
E1308	Rohde & Schwarz	Harmonic Mixer	Down Converter 90-140GHz	FS-Z140	101008	2017-04-06 in Service 2018-07-01		Factory
E1311	Rohde & Schwarz	Harmonic Mixer	Down Converter 40-60GHz	FS-Z60	100977	2017-12-21 in Service 2018-07-01		Factory
E1312	Rohde & Schwarz	Harmonic Mixer	Down Converter 60-90GHz	FS-Z90	101719	2017-08-09 in Service 2018-07-01		Factory
E954	Rohde & Schwarz	Test Receiver	EMI 20Hz - 40GHz -155 dBm +30 dBm	ESU40	100246	2020-08-03	2022-08-03	Requires Calibration
E1470L	Rohde & Schwarz	Spectrum Analyzer	2 Hz to 67 GHz	FSW67	101461	2020-06-04	2022-06-04	Requires Calibration

Table 4.7.1b Radiated Emissions and Radio Measurements

Asset ID	Manufacturer	Type	Description	Model	Serial	Cal Date	Cal Due	Cal Type
E1332	Sage Millimeter, Inc.	Horn Antenna	E-band pyramidal horn antenna - 60 to 90 GHz.	SAR-2309-12-S2	14853-01			Factory
E1335	Sage Millimeter, Inc.	Horn Antenna	F-band pyramidal horn antenna - 90 to 140 GHz	SAR-2309-08-S2	14853-02			Factory
E1340	Sage Millimeter, Inc.	Horn Antenna	Pyramidal horn antenna - 26.5 to 40 GHz, 25 dB gain	SAR-2507-28-S2	15309-01			Factory
E1330	Sage Millimeter, Inc.	Horn Antenna	U-band pyramidal horn antenna - 40 to 60 GHz	SAR-2309-19-S2	14853-01			Factory
E1331	Sage Millimeter, Inc.	Horn Antenna	U-band pyramidal horn antenna - 40 to 60 GHz	SAR-2309-19VF-R2	14853-01			Factory
E813	Sonoma Instrument Co.	Amplifier	9kHz-1GHz	310N	186750	2018-09-14	2020-09-14	Requires Calibration
E980	Trilithic	Low Pass Filter	PCS 0.01-2 GHz	10LC1790-3-AA	PCS-LPF-12			Verification
E1074	ETS Lindgren	Horn Antenna	Double-Ridged Waveguide Horn 1-18 GHz	3117	00135194	2019-05-01	2021-05-01	Requires Calibration
E889	Weinschel	Attenuator	6 dB DC-18GHz 5 Watt	2-6	BX3438	2018-05-23	2021-05-23	
E1150	Extech	Data Logger	Pressure Humidity Temp Data Logger	SD700	Q752767	2019-01-16	2021-01-16	Requires Calibration

CNR: Calibration Not Required

CNR-V: Calibration Not Required, Must Be Verified

Note* - This is a brand-new factory calibrated equipment. Keysight Liberty Labs who does the 17025-calibration was closed due to Covid-19. Prior to testing, a verification test of this equipment was performed in house with a17025 calibrated network analyzer and the factory calibration was verified.

4.8 PHOTOGRAPHS OF THE TEST SETUPS

Response:

The photographs of the test setups are provided in the Filing exhibits.

Radiate Product Configuration on the Turntable.



Radiated Setup for Channel Power, Occupied Bandwidth, Edge of band and Modulation.



Radiated Emissions 30MHz-1 GHz

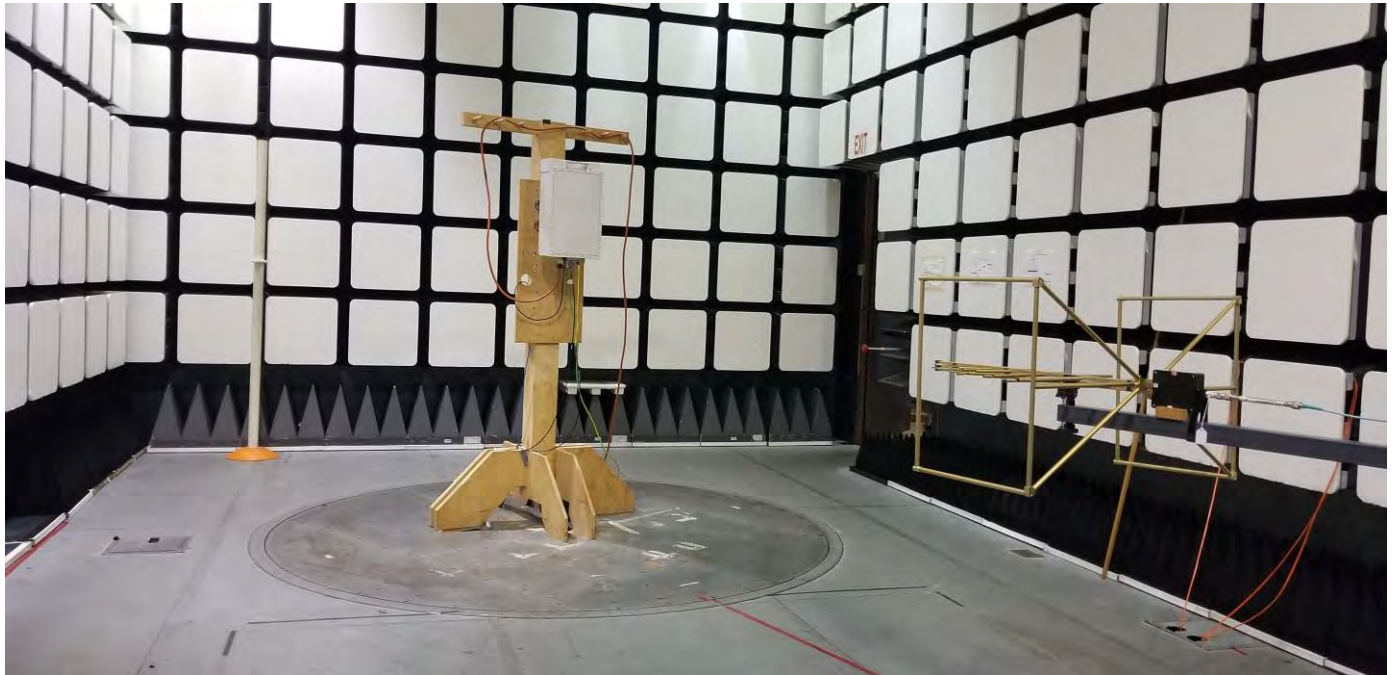

Radiated Emissions 1 GHz -18 GHz

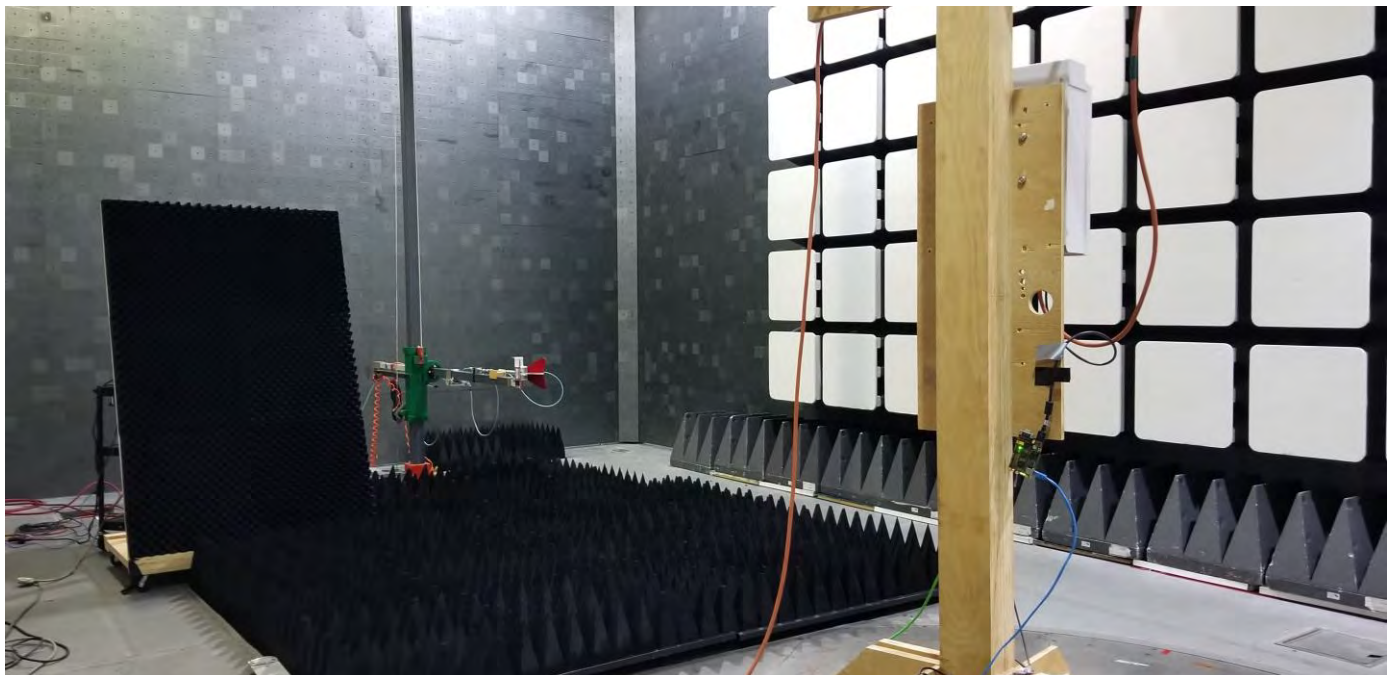

Radiated Emissions 18 GHz-26.5 GHz



Radiated Emissions 26.5 GHz-37 GHz

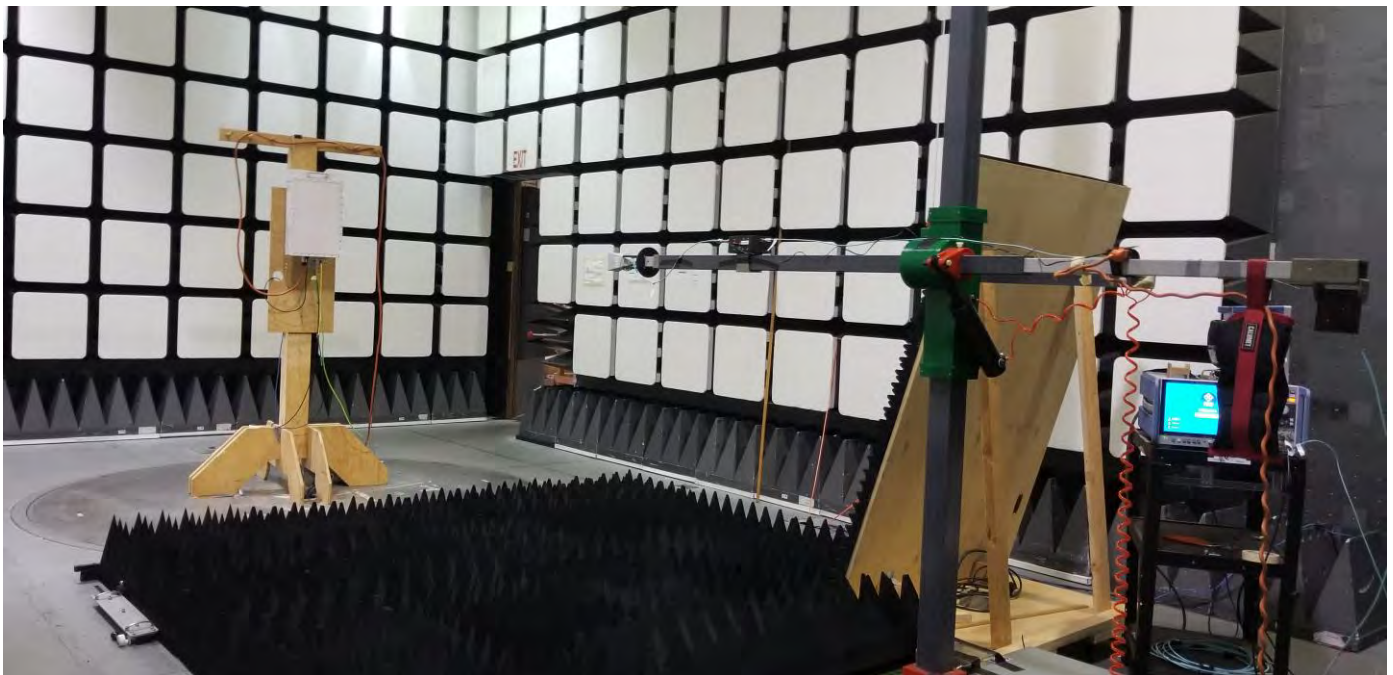

Radiated Spurious Setup for 40-60 GHz

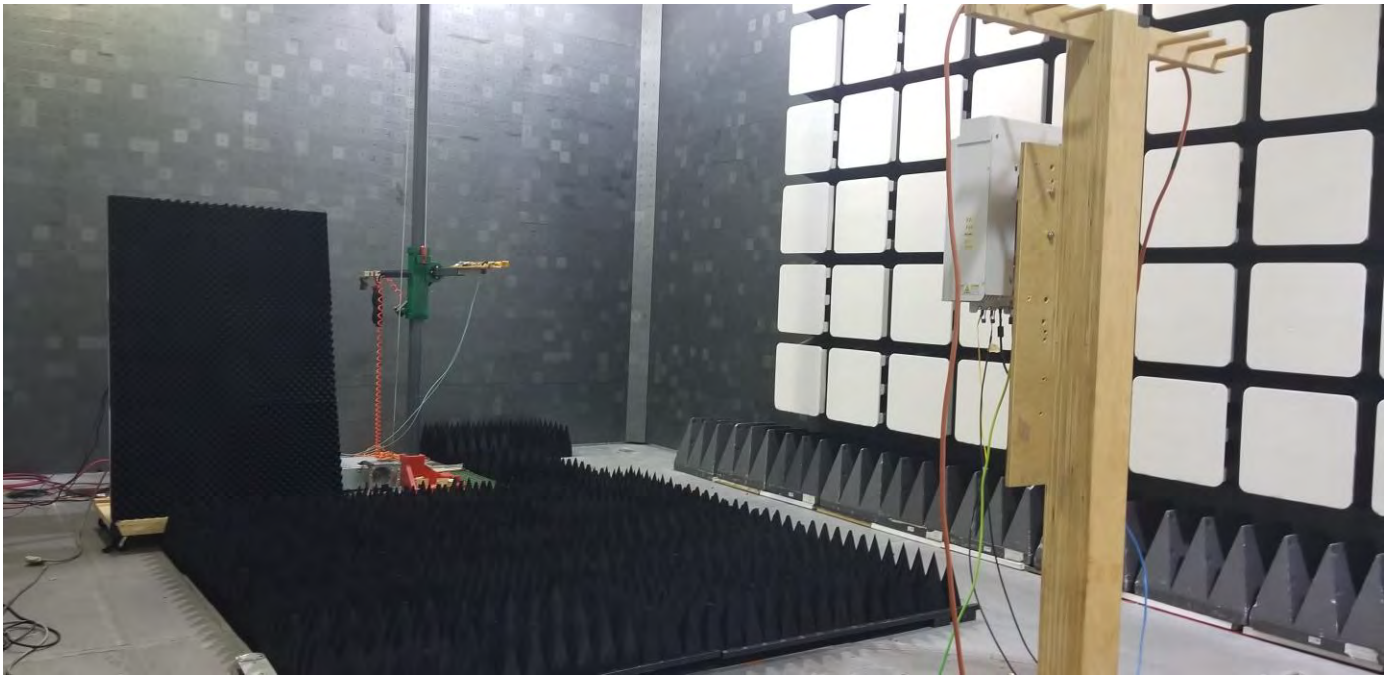

Radiated Spurious Setup for 60-90 GHz

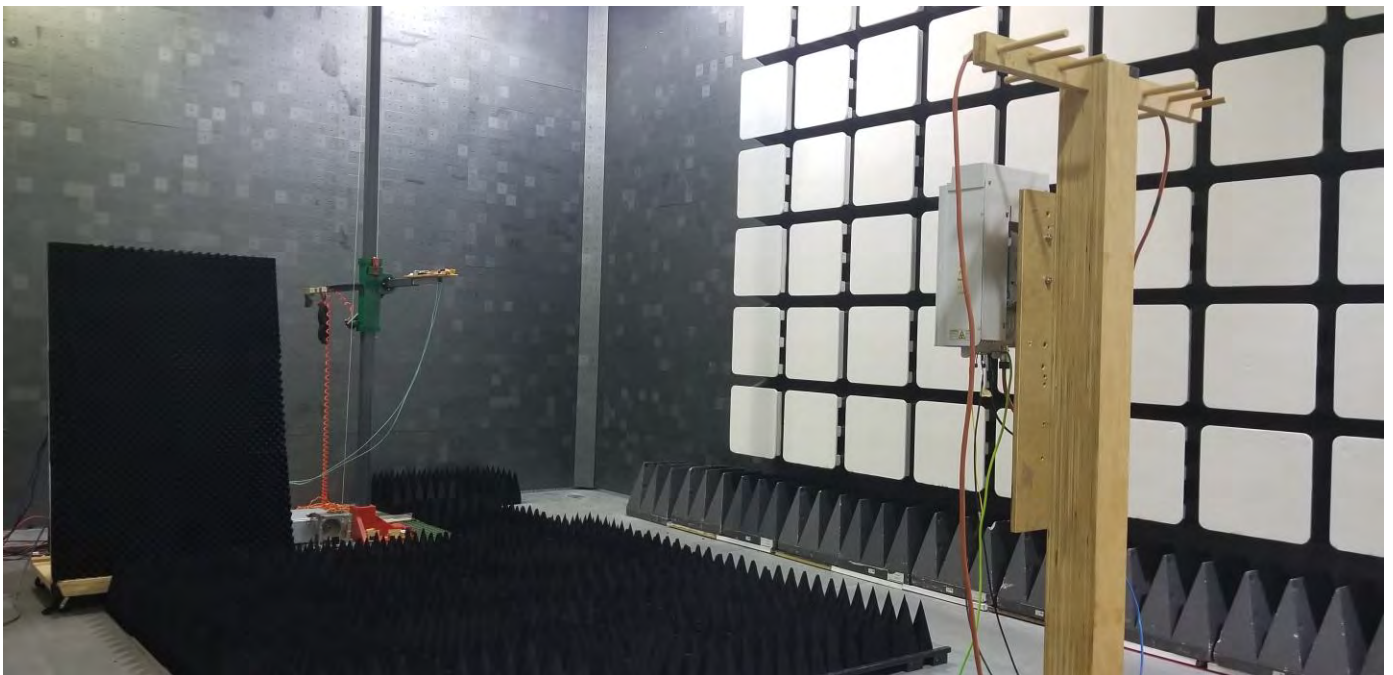

Radiated Spurious Setup for 90-140 GHz

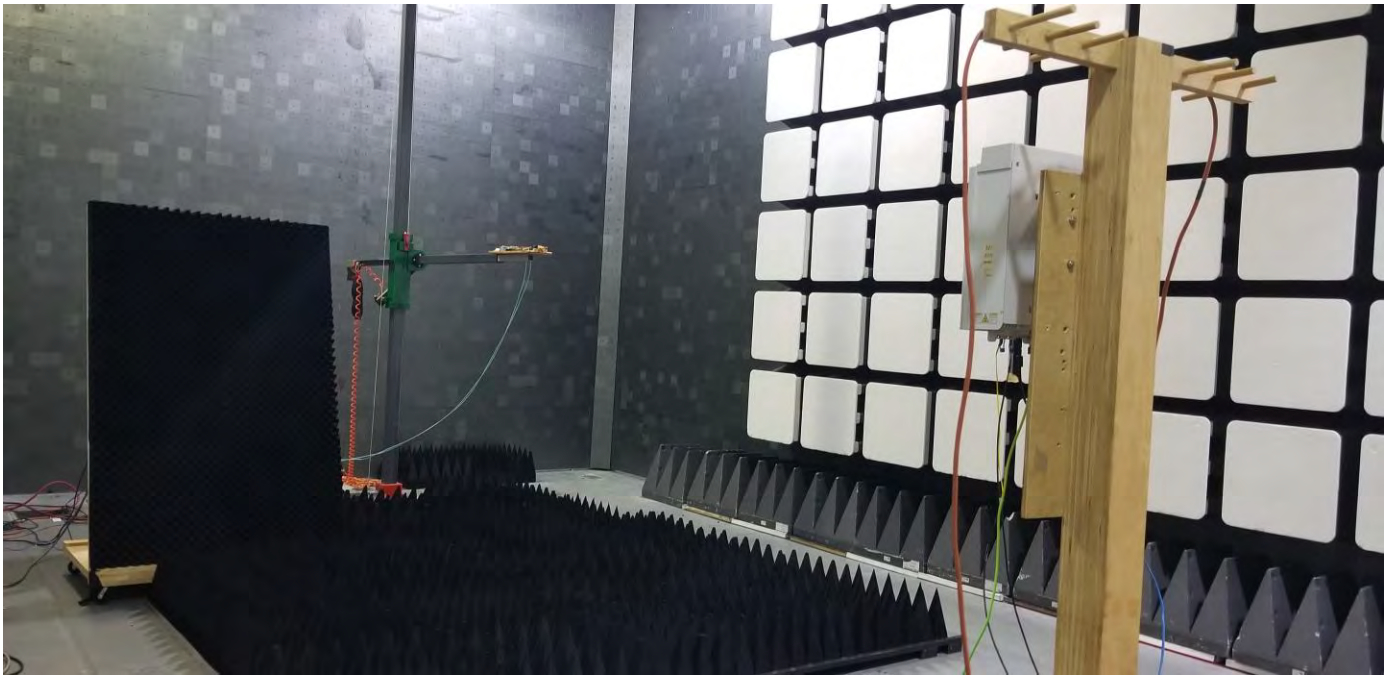

Radiated Spurious Setup for 140-200 GHz

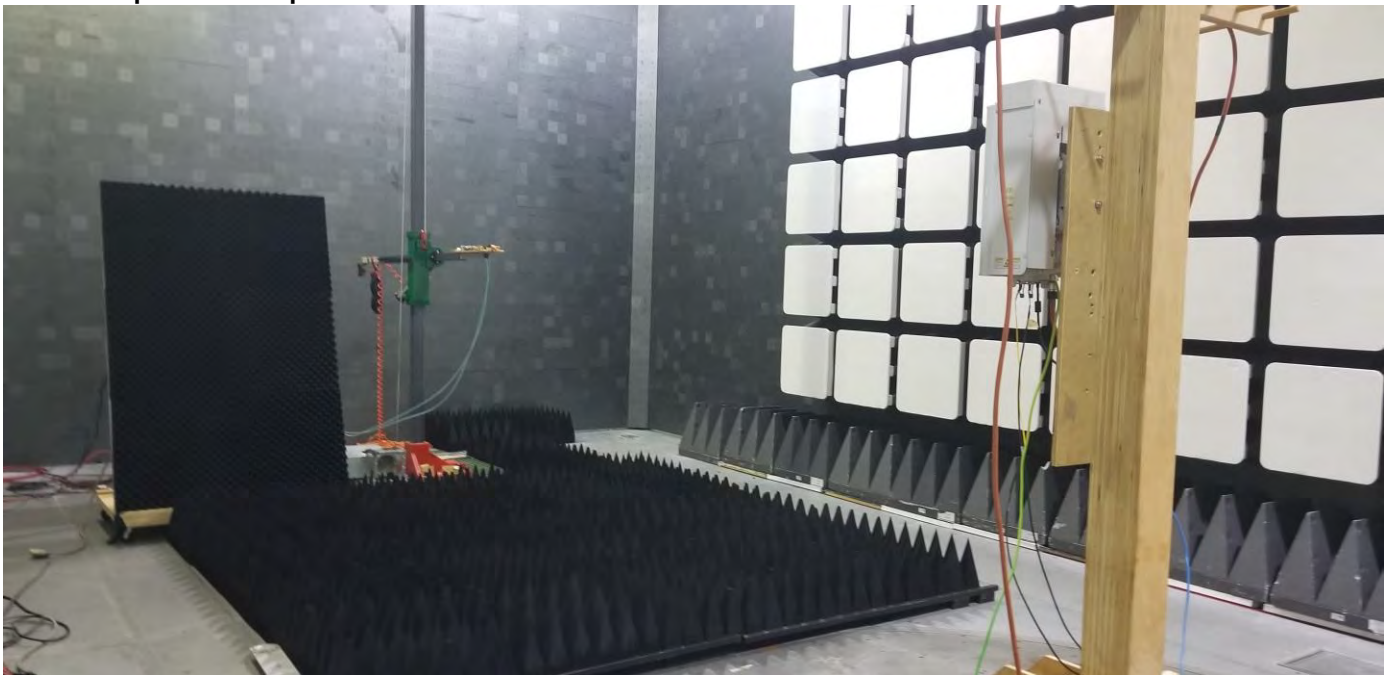

Support and Remote Test Control

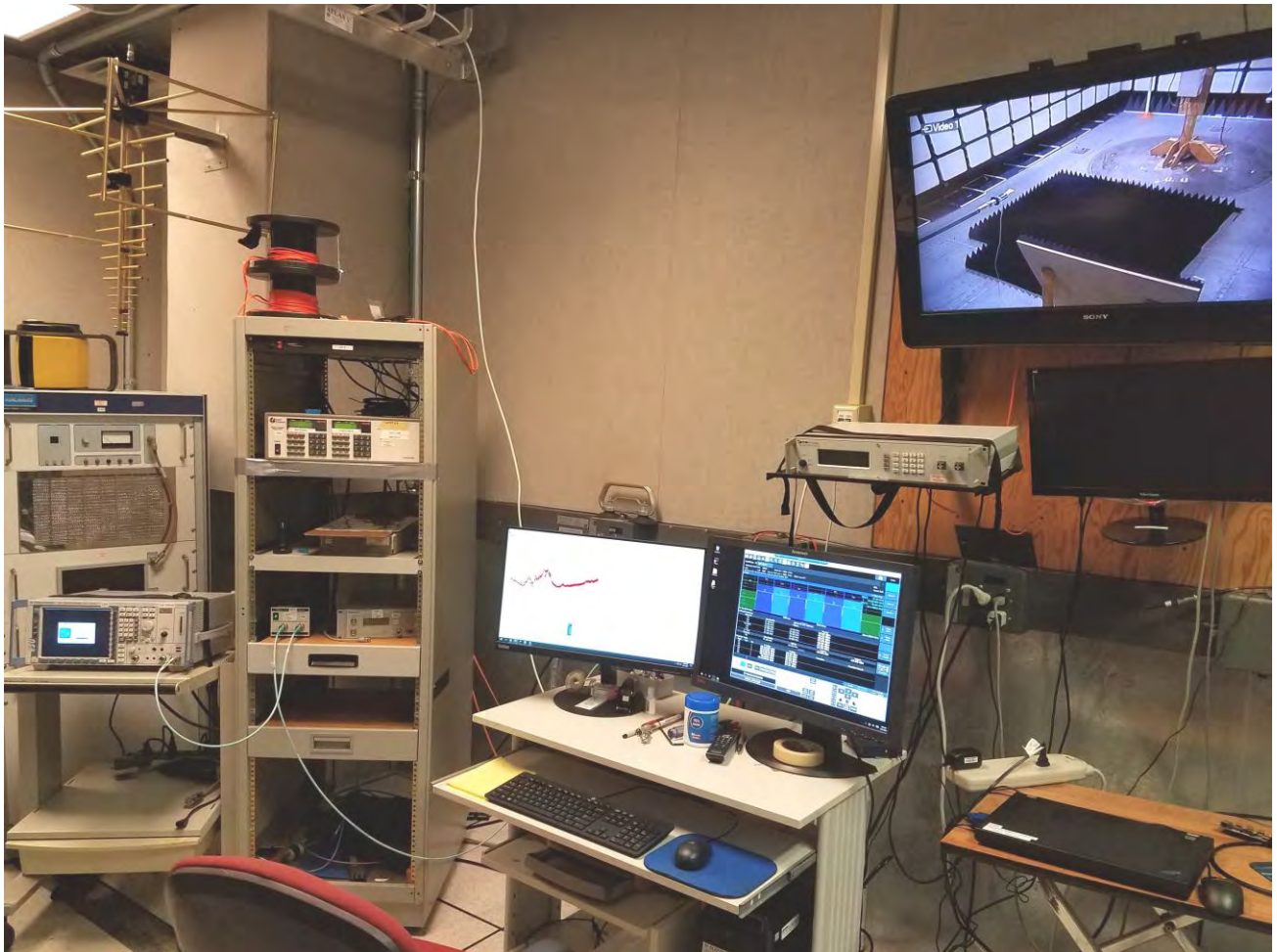

Equipment Label



4.9 FACILITIES AND ACCREDITATION

Measurement facilities at Nokia, Global Product Compliance Laboratory (GPCL) a member of the Nokia family of companies, was used to collect the measurement data in the test report. The laboratory, which is part of Nokia Bell Labs, is located at 600-700 Mountain Avenue, Murray Hill, New Jersey 07974-0636 USA.

The field strength measurements of radiated spurious emissions were made in a FCC registered five meter semi-anechoic chamber AR-5, (FCC Registration Number: 395774) **NVLAP** Lab Code: 100275-0 and IC (Filing Number: 6933F-5) which is maintained by Nokia Bell Labs in Murray Hill, New Jersey. The sites were constructed and are continuously in conformance with the requirements of ANSI C63.4 and CISPR Publication 22.

Nokia Global Product Compliance Laboratory FCC OET Accredited Test Firm Scope List is accessible at:

https://apps.fcc.gov/oetcf/eas/reports/ViewTestFirmAccredScopes.cfm?calledFromFrame=N&RequestTimeout=500®num_specified=N&test_firm_id=7007

and is as listed in the Table below.

OET Accredited Test Firm Scope List
Test Firm: Nokia, Global Product Compliance Lab

Scope	FCC Rule Parts	Maximum Assessed Frequency, MHz	Status	Expiration Date	Recognition Date
Unintentional Radiators	FCC Part15, Subpart B	40000	Approved	9/30/2020	7/6/2017
Intentional Radiators	FCC Part 15 Subpart C	40000	Approved	9/30/2020	6/5/2018
U-NII without DFS Intentional Radiators	FCC Part 15, Subpart E	40000	Approved	9/30/2020	6/5/2018
U-NII with DFS Intentional Radiators	FCC Part 15, Subpart E	40000	Approved	9/30/2020	6/5/2018
Commercial Mobile Services	Part 22 (cellular), Part 24, Part 25 (below 3 GHz), Part 27	40000	Approved	9/30/2020	6/5/2018
General Mobile Radio Services	Part 22 (non-cellular), Part 90 (below 3 GHz), Part 95 (below 3 GHz), Part 97 (below 3 GHz), Part 101 (below 3 GHz)	40000	Approved	9/30/2020	6/5/2018
Citizens Broadband Radio Services	Part 30	40000	Approved	9/30/2020	7/6/2017
Microwave and Millimeter Bands Radio Services	Part 25, Part30, Part 74, Part 90 (90M DSRC, Y, Z), Part 95 (M & L), Part 101	200000	Approved	9/30/2020	7/6/2017

Nokia Global Product Compliance Laboratory is accredited with the US Department of Commerce National Institute of Standards and Technology's National Voluntary Laboratory Accreditation Program (NVLAP) for satisfactory compliance with criteria established in Title 15, Part 7 Code of Federal Regulations for offering test services for selected test methods in Electromagnetic Compatibility; Voluntary Control Council for Interference (VCCI), Japan; Australian Communications and Media Authority (ACMA). The laboratory is ISO 9001:2008 Certified.

**United States Department of Commerce
National Institute of Standards and Technology**



Certificate of Accreditation to ISO/IEC 17025:2005

NVLAP LAB CODE: 100275-0

Nokia, Global Product Compliance Lab
Murray Hill, NJ

*Is accredited by the National Voluntary Laboratory Accreditation Program for specific services,
listed on the Scope of Accreditation, for:*

Electromagnetic Compatibility & Telecommunications

*This laboratory is accredited in accordance with the recognized International Standard ISO/IEC 17025:2005.
This accreditation demonstrates technical competence for a defined scope and the operation of a laboratory quality
management system (refer to joint ISO-ILAC-IAF Communique dated January 2009).*

2019-09-20 through 2020-09-30
Effective Dates



For the National Voluntary Laboratory Accreditation Program

5. APPENDIX A - CALIBRATION CERTIFICATES.

The attached Calibration certificates represent the Harmonic Downconverters used in this testing.



Calibration Certificate

Kalibrierschein

Certificate Number 24-0060-100977-01

Zertifikatsnummer

Unit Data

Item
Gegenstand **Harmonic Mixer, 40 GHz to 60 GHz**

Manufacturer
Hersteller **RPG**

Type
Typ **RPG FS-Z60**

Material Number
Materialnummer **1048.0171.02** Serial Number
Seriennummer **100977**

Asset Number
Inventarnummer

This calibration certificate documents, that the named item is tested and measured against defined specifications. Measurement results are located usually in the corresponding interval with a probability of approx. 95% (coverage factor $k = 2$). Calibration is performed with test equipment and standards directly or indirectly traceable by means of approved calibration techniques to the PTB/DKD or other national/international standards, which realize the physical units of measurement according to the International System of Units (SI). In all cases where no standards are available, measurements are referenced to standards of the R&S laboratories. Principles and methods of calibration correspond with EN ISO/IEC 17025. This calibration certificate may not be reproduced other than in full. Calibration certificates without signatures are not valid. The user is obliged to have the object recalibrated at appropriate intervals.

Order Data

Customer
Auftraggeber

Order Number
Bestellnummer

Date of Receipt
Eingangsdatum

Dieser Kalibrierschein dokumentiert, dass der genannte Gegenstand nach festgelegten Vorgaben geprüft und gemessen wurde. Die Messwerte lagen im Regelfall mit einer Wahrscheinlichkeit von annähernd 95% im zugeordneten Werteintervall (Erweiterte Messunsicherheit mit $k = 2$). Die Kalibrierung erfolgte mit Messmitteln und Normalen, die direkt oder indirekt durch Ableitung mittels anerkannter Kalibriertechniken rückgeführt sind auf Normale der PTB/DKD oder anderer nationaler/internationaler Standards zur Darstellung der physikalischen Einheiten in Übereinstimmung mit dem Internationalen Einheitensystem (SI). Wenn keine Normale existieren, erfolgt die Rückführung auf Bezugsnormale der R&S-Laboratorien. Grundsätze und Verfahren der Kalibrierung beziehen sich auf EN ISO/IEC 17025. Dieser Kalibrierschein darf nur vollständig und unverändert weiterverbreitet werden. Kalibrierscheine ohne Unterschriften sind ungültig. Für die Einhaltung einer angemessenen Frist zur Wiederholung der Kalibrierung ist der Benutzer verantwortlich.

Performance

Place and Date of Calibration
Ort und Datum der Kalibrierung

Meckenheim, 2017-12-21

Scope of Calibration
Umfang der Kalibrierung

Standard Calibration

Statement of Compliance
(Incoming)
Konformitätsaussage
(Anlieferung)

New device

Statement of Compliance
(Outgoing)
Konformitätsaussage
(Auslieferung)

All measured values are within the data sheet specifications.

Extend of Calibration Documents
Umfang des Kalibrierdokuments

**2 pages Calibration Certificate
5 pages Outgoing Results**

Radiometer Physics GmbH; Meckenheim

Date of Issue
Ausstellungsdatum

2017-12-21

Head of Laboratory
Laborleitung

Schulze

Person Responsible
Bearbeiter

Wildfang

Page (Seite) 1/2
Vers2010-05-05/
RPG2014-02-28

Calibration Method
Kalibrieranweisung

RPG-PAQA-TN-2014-002

Relative Humidity 20 % - 80 %
Relative Luftfeuchte

Ambient Temperature
Umgebungstemperatur

(23 ⁺⁷/₋₃) °C

Working standards used (having a significant effect on the accuracy) Verwendete Gebrauchsnormale (mit signifikantem Einfluss auf die Genauigkeit)				
Item Gegenstand	Type Typ	Serial Number Seriennummer	Calibration Certificate Number Kalibrierscheinnummer	Cal. Due Kalibr. bis
Vector Network Analyzer	R&S® ZVA67	101097	20-300432406	2020-07-21
Powersensor	R&S® NRP-Z55	140093	20-300426315	2018-05-17
Powersensor	R&S® NRP-Z57	101423	20-541799	2019-04-27

UGB1 A compliance statement may be possible where a confidence level of less than 95 % is acceptable.
Die Bestätigung der Konformität ist möglich, sofern ein Grad des Vertrauens von weniger als 95 % akzeptabel ist.

UGB2 A non-compliance statement may be possible where a confidence level of less than 95 % is acceptable.
Die Bestätigung der Nicht-Konformität ist möglich, sofern ein Grad des Vertrauens von weniger als 95 % akzeptabel ist.

Ref.: ILAC-G8:03/2009 'Guidelines on the Reporting of Compliance with Specification'.

Notes

Anmerkungen

If the new product is stored under the climate conditions as specified in the data sheet upon delivery, the product's accuracy is not significantly affected within 12 month after its calibration in our factory. In this case, the recommended calibration interval starts on the date when the product is actually put into operation.

Outgoing Results

The following abbreviations may be used in this document

{a}	No measurement uncertainty stated because the errors always add together. So it is sure that a measurement result evaluated as "PASS" is pass.
{b}	The measurement uncertainty depends on the measurement result. The stated measurement uncertainty is valid for the close area around the specification. Measurement results outside the close area have a higher measurement uncertainty but are within the specification.
{c}	Functional test, therefore no measurement uncertainty is stated.
{d}	Typical value, refer to performance test.
{e}	The measurement uncertainty is taken into account when setting the measuring system.
DL or DT	Data Limit for symmetrical tolerance limits
DLL	Datasheet Lower Limit
DUL	Datasheet Upper Limit
MU	Measurement Uncertainty
MLL or MLV	Measurement Uncertainty Lower Value
MUL or MUV	Measurement Uncertainty Upper Value
Nom.	Nominal Value
Dev.	Deviation
MErr.	Measurement Error
Act.	Actual Value
UGB	Uncertainty Guard Band: Measuring uncertainty violates the data (spec.) limit.
UGB1	Measurement results marked as UGB1 show conformity with a probability of >50 % and <95 %.
UGB2	Measurement results marked as UGB2 show non-conformity with a probability of >50 % and <95 %.
DU	Datasheet Uncertainty

Explanation of charts

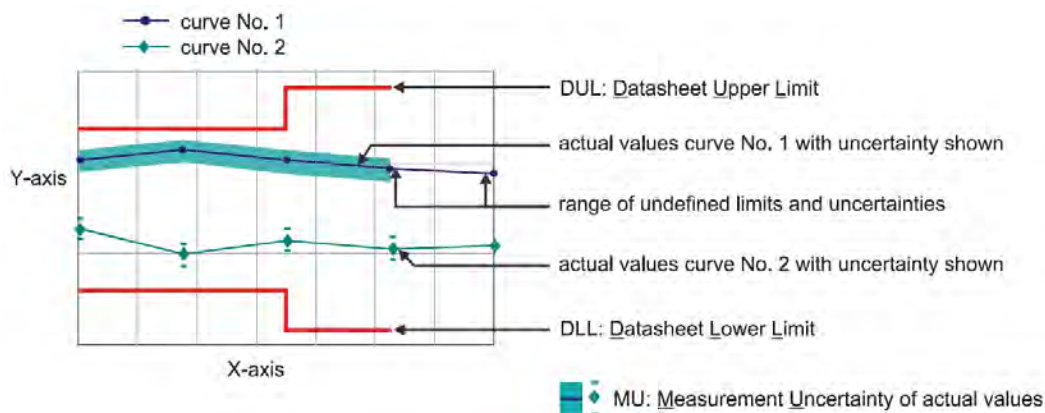

Software used for measurement**Item Type**Measurement Studio Professional Edition
MixerCertification**Version**2013
7_07**Remark**

1.1 RF Input – VSWR

Measurement uncertainty: 0.05 (VSWR)

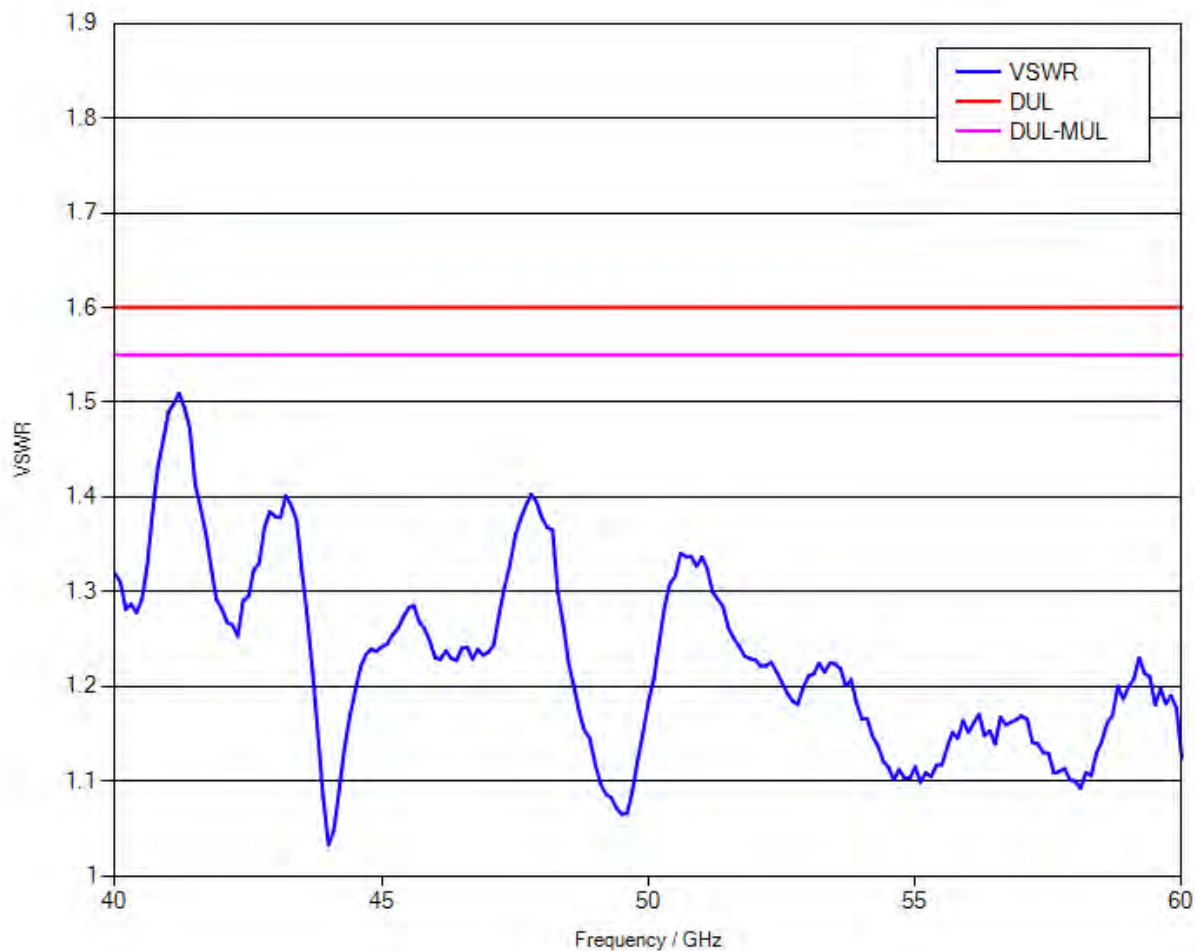

1.2 Conversion loss

LO level +13 dBm nominal
Bias 0 A

Measurement uncertainty: 1.5 dB

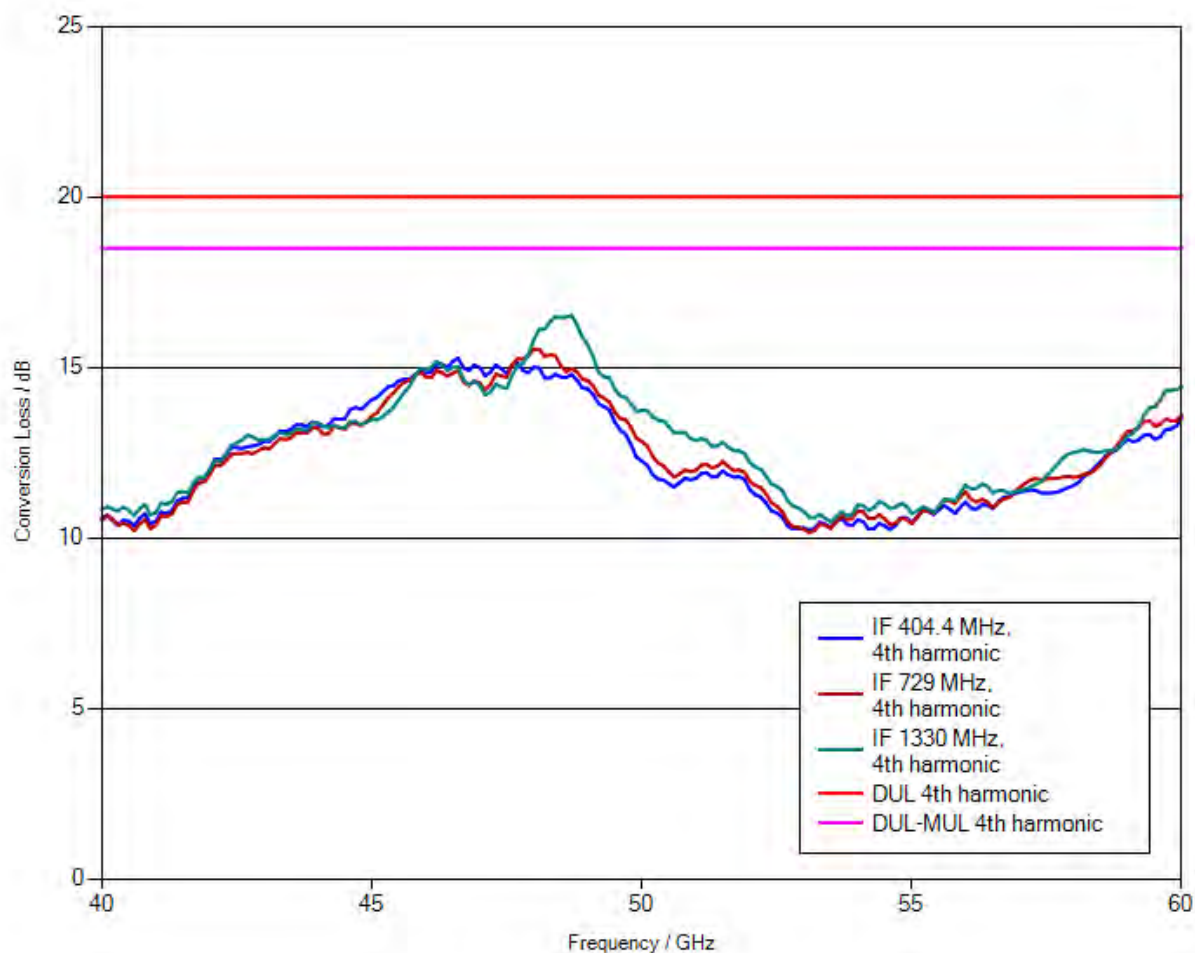

Note: Numeric calibration data can be found attached to the PDF file of the calibration certificate. Click the “paper clip” symbol to display the file.

The file has been renamed for safety reasons.

When downloading the file onto your PC, please delete the “.file” extension and unzip the data.

1.3 Frequency response within 1 GHz

	DUL	Actual (worst case)	Evaluation
IF = 404.4 MHz, 4th harmonic	4 dB	2.02 dB	PASS
IF = 729 MHz, 4th harmonic	4 dB	1.78 dB	PASS
IF = 1330 MHz, 4th harmonic	4 dB	2.35 dB	PASS

Calibration Certificate

Kalibrierschein

Certificate Number **24-0090-101719-01**

Zertifikatsnummer

Unit Data

Item Harmonic Mixer, 60 GHz to 90 GHz
Gegenstand

Manufacturer ROHDE & SCHWARZ
Hersteller

Type R&S® FS-Z90
Typ

Material Number 1048.0371.02 **Serial Number** 101719
Materialnummer Seriennummer

Asset Number
Inventarnummer

This calibration certificate documents, that the named item is tested and measured against defined specifications. Measurement results are located usually in the corresponding interval with a probability of approx. 95% (coverage factor $k = 2$). Calibration is performed with test equipment and standards directly or indirectly traceable by means of approved calibration techniques to the PTB/DKD or other national/international standards, which realize the physical units of measurement according to the International System of Units (SI). In all cases where no standards are available, measurements are referenced to standards of the R&S laboratories. Principles and methods of calibration correspond with EN ISO/IEC 17025. This calibration certificate may not be reproduced other than in full. Calibration certificates without signatures are not valid. The user is obliged to have the object recalibrated at appropriate intervals.

Order Data

Customer
Auftraggeber

Order Number
Bestellnummer

Date of Receipt
Eingangsdatum

Dieser Kalibrierschein dokumentiert, dass der genannte Gegenstand nach festgelegten Vorgaben geprüft und gemessen wurde. Die Messwerte lagen im Regelfall mit einer Wahrscheinlichkeit von annähernd 95% im zugeordneten Werteintervall (Erweiterte Messunsicherheit mit $k = 2$). Die Kalibrierung erfolgte mit Messmitteln und Normalen, die direkt oder indirekt durch Ableitung mittels anerkannter Kalibriertechniken rückgeführt sind auf Normale der PTB/DKD oder anderer nationaler/internationaler Standards zur Darstellung der physikalischen Einheiten in Übereinstimmung mit dem Internationalen Einheitensystem (SI). Wenn keine Normale existieren, erfolgt die Rückführung auf Bezugsnormale der R&S-Laboratorien. Grundsätze und Verfahren der Kalibrierung beziehen sich auf EN ISO/IEC 17025. Dieser Kalibrierschein darf nur vollständig und unverändert weiterverbreitet werden. Kalibrierscheine ohne Unterschriften sind ungültig. Für die Einhaltung einer angemessenen Frist zur Wiederholung der Kalibrierung ist der Benutzer verantwortlich.

Performance

Place and Date of Calibration
Ort und Datum der Kalibrierung

Meckenheim, 2017-08-09

Scope of Calibration
Umfang der Kalibrierung

Standard Calibration

Statement of Compliance (Incoming)
Konformitätsaussage (Anlieferung)

New device

Statement of Compliance (Outgoing)
Konformitätsaussage (Auslieferung)

All measured values are within the data sheet specifications.

Extend of Calibration Documents
Umfang des Kalibrierdokuments

**2 pages Calibration Certificate
5 pages Outgoing Results**

Radiometer Physics GmbH; Meckenheim

Date of Issue
Ausstellungsdatum

2017-08-11

Head of Laboratory
Laborleitung

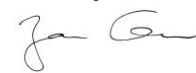

Ceru

Person Responsible
Bearbeiter



Heinze

Page (Seite) 1/2
Vers2010-05-05/
RPG2014-02-28

Calibration Method
Kalibrieranweisung

RPG-PAQA-TN-2014-002

Relative Humidity 20 % - 80 %
Relative Luftfeuchte

Ambient Temperature
Umgebungstemperatur

(23 ⁺⁷/₋₃) °C

Working standards used (having a significant effect on the accuracy) Verwendete Gebrauchsnormale (mit signifikantem Einfluss auf die Genauigkeit)				
Item Gegenstand	Type Typ	Serial Number Seriennummer	Calibration Certificate Number Kalibrierscheinnummer	Cal. Due Kalibr. bis
Vector Network Analyzer	R&S® ZVA67	101097	20-300432406	2020-07-21
Powersensor	R&S® NRP-Z55	140093	20-300426315	2018-05-17
Powersensor	R&S® NRP-Z58	101063	20-611482	2018-07-21
Calibration kit	WR12	E10001	RPG-PAQA-TN-2014-005	2019-02-01

UGB1 A compliance statement may be possible where a confidence level of less than 95 % is acceptable.
Die Bestätigung der Konformität ist möglich, sofern ein Grad des Vertrauens von weniger als 95 % akzeptabel ist.

UGB2 A non-compliance statement may be possible where a confidence level of less than 95 % is acceptable.
Die Bestätigung der Nicht-Konformität ist möglich, sofern ein Grad des Vertrauens von weniger als 95 % akzeptabel ist.

Ref.: ILAC-G8:03/2009 'Guidelines on the Reporting of Compliance with Specification'.

Notes

Anmerkungen

If the new product is stored under the climate conditions as specified in the data sheet upon delivery, the product's accuracy is not significantly affected within 12 month after its calibration in our factory. In this case, the recommended calibration interval starts on the date when the product is actually put into operation.

Outgoing Results

The following abbreviations may be used in this document

{a}	No measurement uncertainty stated because the errors always add together. So it is sure that a measurement result evaluated as "PASS" is pass.
{b}	The measurement uncertainty depends on the measurement result. The stated measurement uncertainty is valid for the close area around the specification. Measurement results outside the close area have a higher measurement uncertainty but are within the specification.
{c}	Functional test, therefore no measurement uncertainty is stated.
{d}	Typical value, refer to performance test.
{e}	The measurement uncertainty is taken into account when setting the measuring system.
DL or DT	Data Limit for symmetrical tolerance limits
DLL	Datasheet Lower Limit
DUL	Datasheet Upper Limit
MU	Measurement Uncertainty
MLL or MLV	Measurement Uncertainty Lower Value
MUL or MUV	Measurement Uncertainty Upper Value
Nom.	Nominal Value
Dev.	Deviation
MErr.	Measurement Error
Act.	Actual Value
UGB	Uncertainty Guard Band: Measuring uncertainty violates the data (spec.) limit.
UGB1	Measurement results marked as UGB1 show conformity with a probability of >50 % and <95 %.
UGB2	Measurement results marked as UGB2 show non-conformity with a probability of >50 % and <95 %.
DU	Datasheet Uncertainty

Explanation of charts

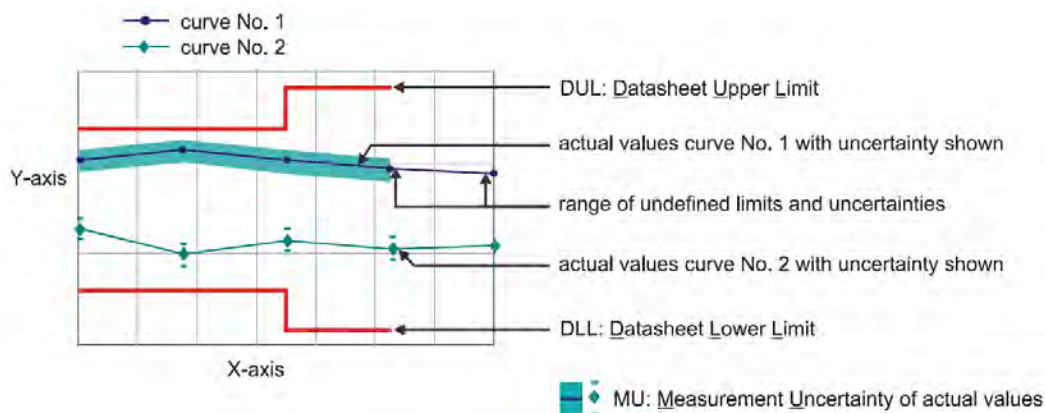

Software used for measurement

Item Type

Measurement Studio Professional Edition
MixerCertification

Version

2013
only

Remark

1.1 RF Input – VSWR

Measurement uncertainty: 0.05 (VSWR)

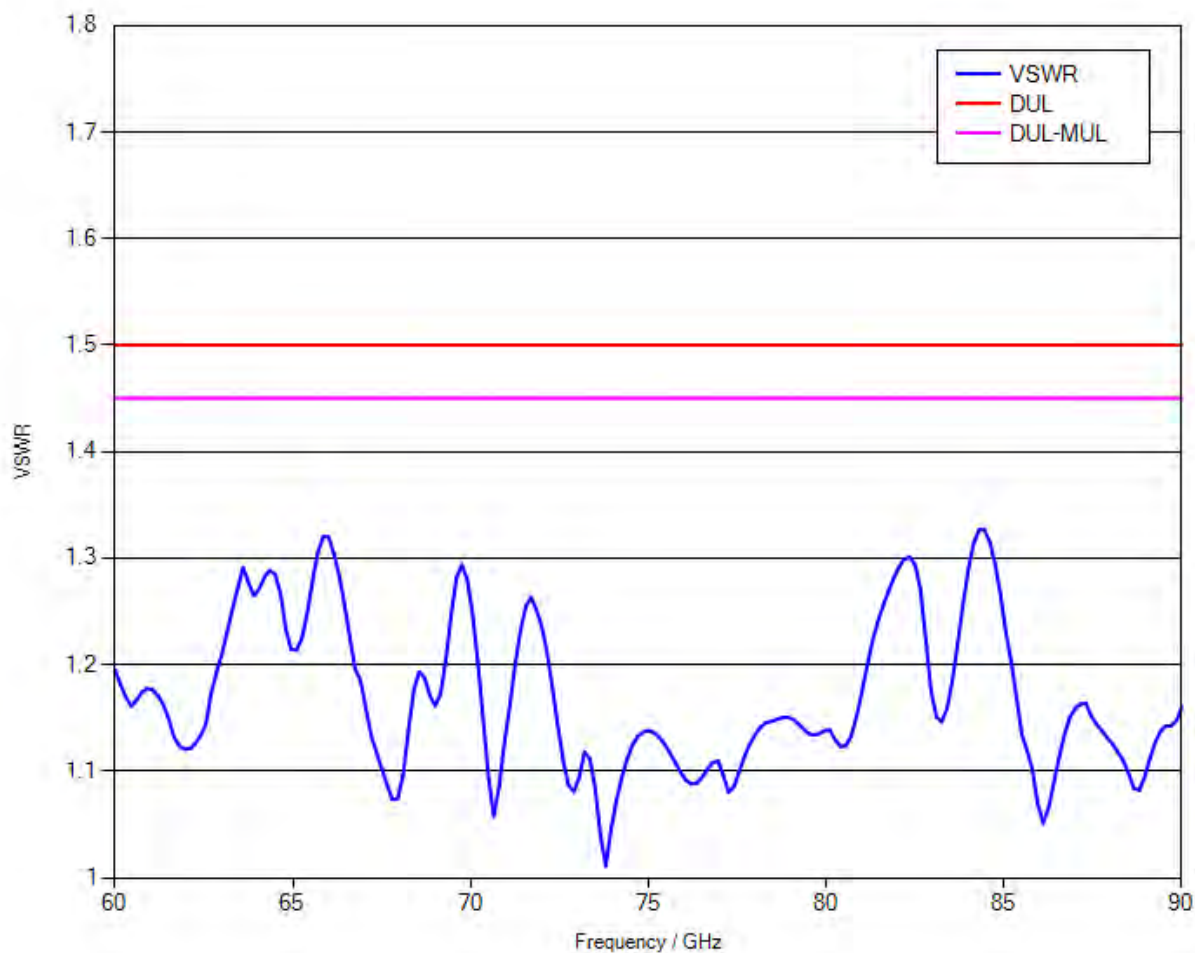

1.2 Conversion loss

LO level +14 dBm nominal
 Bias 0 A

Measurement uncertainty: 1.5 dB

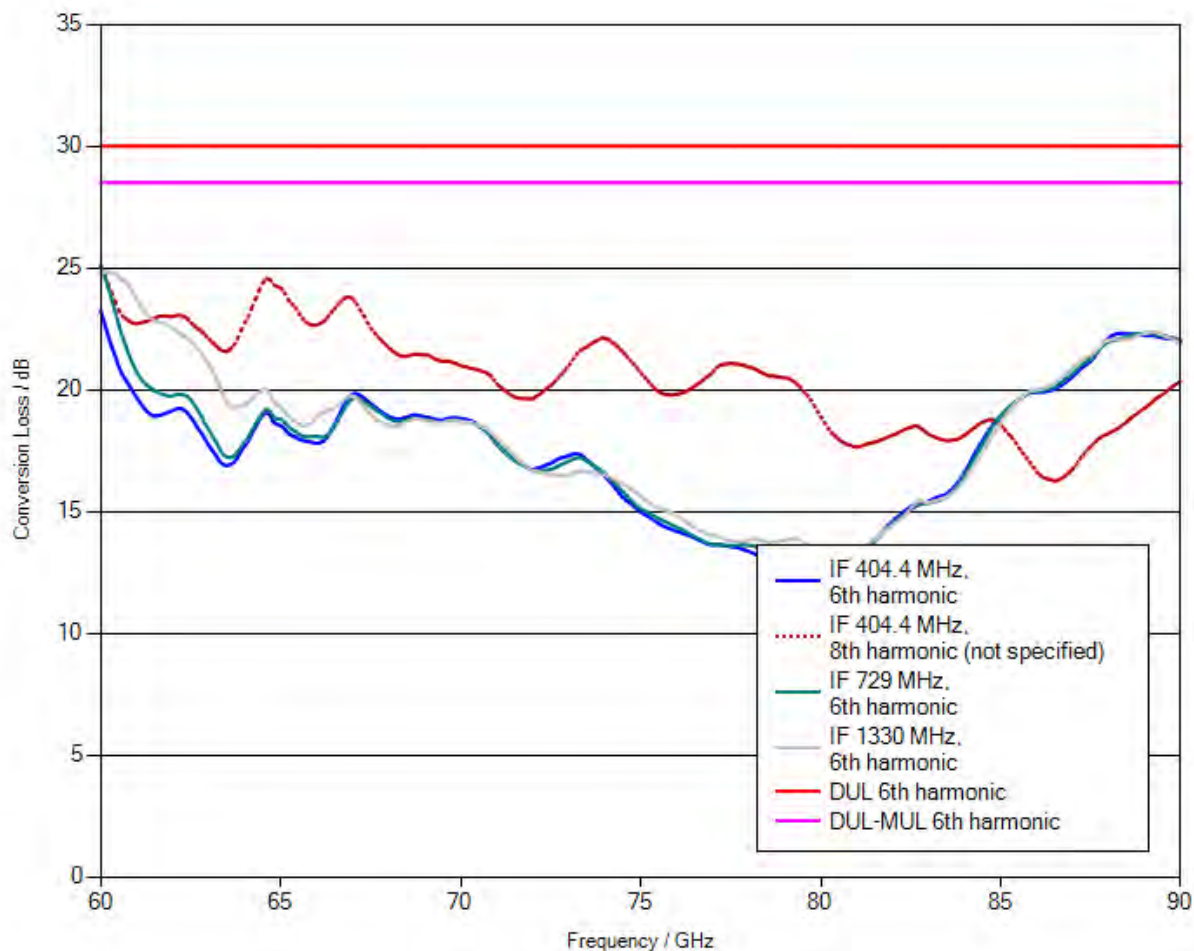

Note: Numeric calibration data can be found attached to the PDF file of the calibration certificate. Click the “paper clip” symbol to display the file.

The file has been renamed for safety reasons. When downloading the file onto your PC, please delete the “.file” extension and unzip the data.

1.3 Frequency response within 1 GHz

	DUL	Actual (worst case)	Evaluation
IF = 404.4 MHz, 6th harmonic	6 dB	3.33 dB	PASS
IF = 404.4 MHz, 8th harmonic	not specified	2.73 dB	not specified
IF = 729 MHz, 6th harmonic	6 dB	4.12 dB	PASS
IF = 1330 MHz, 6th harmonic	6 dB	2.32 dB	PASS



Calibration Certificate

Certificate Number 24-0140-101008-01

Kalibrierschein

Zertifikatsnummer

Unit Data

Item Harmonic Mixer, 90 GHz to 140 GHz
Gegenstand

Manufacturer RPG
Hersteller

Type RPG FS-Z140
Typ

Material Number 3622.0708.02 **Serial Number** 101008
Materialnummer Seriennummer

Asset Number
Inventarnummer

This calibration certificate documents, that the named item is tested and measured against defined specifications. Measurement results are located usually in the corresponding interval with a probability of approx. 95% (coverage factor $k = 2$). Calibration is performed with test equipment and standards directly or indirectly traceable by means of approved calibration techniques to the PTB/DKD or other national/international standards, which realize the physical units of measurement according to the International System of Units (SI). In all cases where no standards are available, measurements are referenced to standards of the R&S laboratories. Principles and methods of calibration correspond with EN ISO/IEC 17025. This calibration certificate may not be reproduced other than in full. Calibration certificates without signatures are not valid. The user is obliged to have the object recalibrated at appropriate intervals.

Order Data

Customer
Auftraggeber

Order Number
Bestellnummer

Date of Receipt
Eingangsdatum

Dieser Kalibrierschein dokumentiert, dass der genannte Gegenstand nach festgelegten Vorgaben geprüft und gemessen wurde. Die Messwerte lagen im Regelfall mit einer Wahrscheinlichkeit von annähernd 95% im zugeordneten Werteintervall (Erweiterte Messunsicherheit mit $k = 2$). Die Kalibrierung erfolgte mit Messmitteln und Normalen, die direkt oder indirekt durch Ableitung mittels anerkannter Kalibriertechniken rückgeführt sind auf Normale der PTB/DKD oder anderer nationaler/internationaler Standards zur Darstellung der physikalischen Einheiten in Übereinstimmung mit dem Internationalen Einheitensystem (SI). Wenn keine Normale existieren, erfolgt die Rückführung auf Bezugsnormale der R&S-Laboratorien. Grundsätze und Verfahren der Kalibrierung beziehen sich auf EN ISO/IEC 17025. Dieser Kalibrierschein darf nur vollständig und unverändert weiterverbreitet werden. Kalibrierscheine ohne Unterschriften sind ungültig. Für die Einhaltung einer angemessenen Frist zur Wiederholung der Kalibrierung ist der Benutzer verantwortlich.

Performance

Place and Date of Calibration
Ort und Datum der Kalibrierung

Meckenheim, 2017-04-06

Scope of Calibration
Umfang der Kalibrierung

Standard Calibration

Statement of Compliance (Incoming)
Konformitätsaussage (Anlieferung)

New device

Statement of Compliance (Outgoing)
Konformitätsaussage (Auslieferung)

All measured values are within the data sheet specifications.

Extend of Calibration Documents
Umfang des Kalibrierdokuments

**2 pages Calibration Certificate
5 pages Outgoing Results**

Radiometer Physics GmbH; Meckenheim

Date of Issue
Ausstellungsdatum

2017-04-07

Head of Laboratory
Laborleitung

Ceru

Person Responsible
Bearbeiter

Heinze

Page (Seite) 1/2
Vers2010-05-05/
RPG2014-02-28

Calibration Method
Kalibrieranweisung

RPG-PAQA-TN-2014-002

Relative Humidity 20 % - 80 %
Relative Luftfeuchte

Ambient Temperature
Umgebungstemperatur

(23 ⁺⁷/₋₃) °C

Working standards used (having a significant effect on the accuracy) Verwendete Gebrauchsnormale (mit signifikantem Einfluss auf die Genauigkeit)				
Item Gegenstand	Type Typ	Serial Number Seriennummer	Calibration Certificate Number Kalibrierscheinnummer	Cal. Due Kalibr. bis
Vector Network Analyzer	R&S® ZVA67	101097	10-300319061	2017-08-06
Powersensor	R&S® NRP-Z55	140093	20-541556	2017-05-12

UGB1 A compliance statement may be possible where a confidence level of less than 95 % is acceptable.
Die Bestätigung der Konformität ist möglich, sofern ein Grad des Vertrauens von weniger als 95 % akzeptabel ist.

UGB2 A non-compliance statement may be possible where a confidence level of less than 95 % is acceptable.
Die Bestätigung der Nicht-Konformität ist möglich, sofern ein Grad des Vertrauens von weniger als 95 % akzeptabel ist.

Ref.: ILAC-G8:03/2009 'Guidelines on the Reporting of Compliance with Specification'.

Notes
Anmerkungen

Outgoing Results

The following abbreviations may be used in this document

- {a} No measurement uncertainty stated because the errors always add together.
So it is sure that a measurement result evaluated as "PASS" is pass.
- {b} The measurement uncertainty depends on the measurement result. The stated measurement uncertainty is valid for the close area around the specification. Measurement results outside the close area have a higher measurement uncertainty but are within the specification.
- {c} Functional test, therefore no measurement uncertainty is stated.
- {d} Typical value, refer to performance test.
- {e} The measurement uncertainty is taken into account when setting the measuring system.
- DL or DT Data Limit for symmetrical tolerance limits
- DLL Datasheet Lower Limit
- DUL Datasheet Upper Limit
- MU Measurement Uncertainty
- MLL or MLV Measurement Uncertainty Lower Value
- MUL or MUV Measurement Uncertainty Upper Value
- Nom. Nominal Value
- Dev. Deviation
- MErr. Measurement Error
- Act. Actual Value
- UGB Uncertainty Guard Band: Measuring uncertainty violates the data (spec.) limit.
- UGB1 Measurement results marked as UGB1 show conformity with a probability of >50 % and <95 %.
- UGB2 Measurement results marked as UGB2 show non-conformity with a probability of >50 % and <95 %.
- DU Datasheet Uncertainty

Explanation of charts

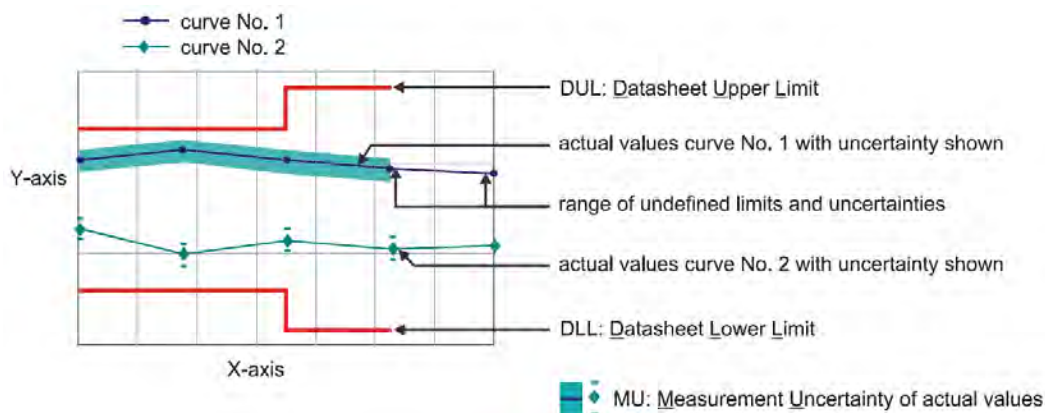

Software used for measurement

Item Type

Measurement Studio Professional Edition
MixerCertification

Version

2013
7_04

Remark

1.1 RF Input – VSWR

Measurement uncertainty: 0.05 (VSWR)

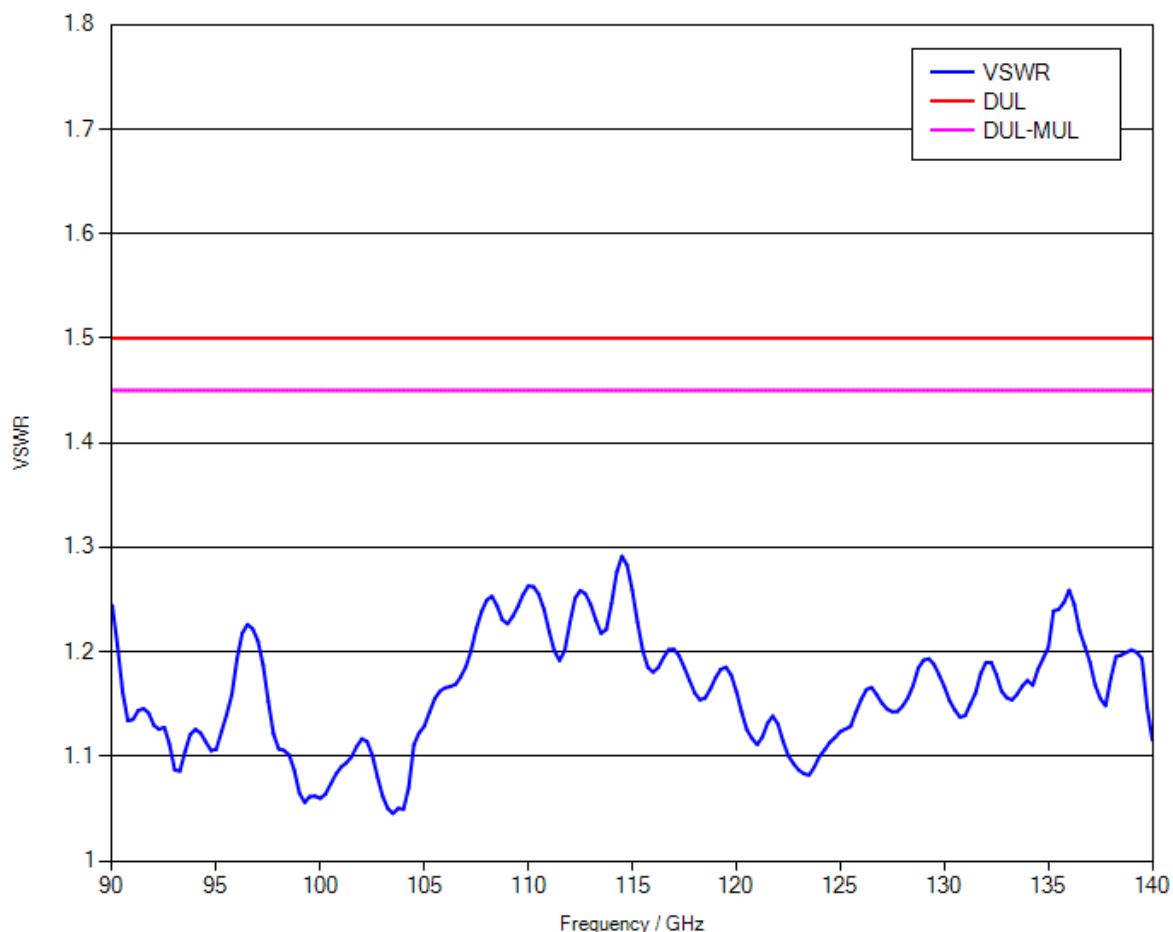

1.2 Conversion loss

LO level +14 dBm nominal
Bias 0 A

Measurement uncertainty: 3.5 dB

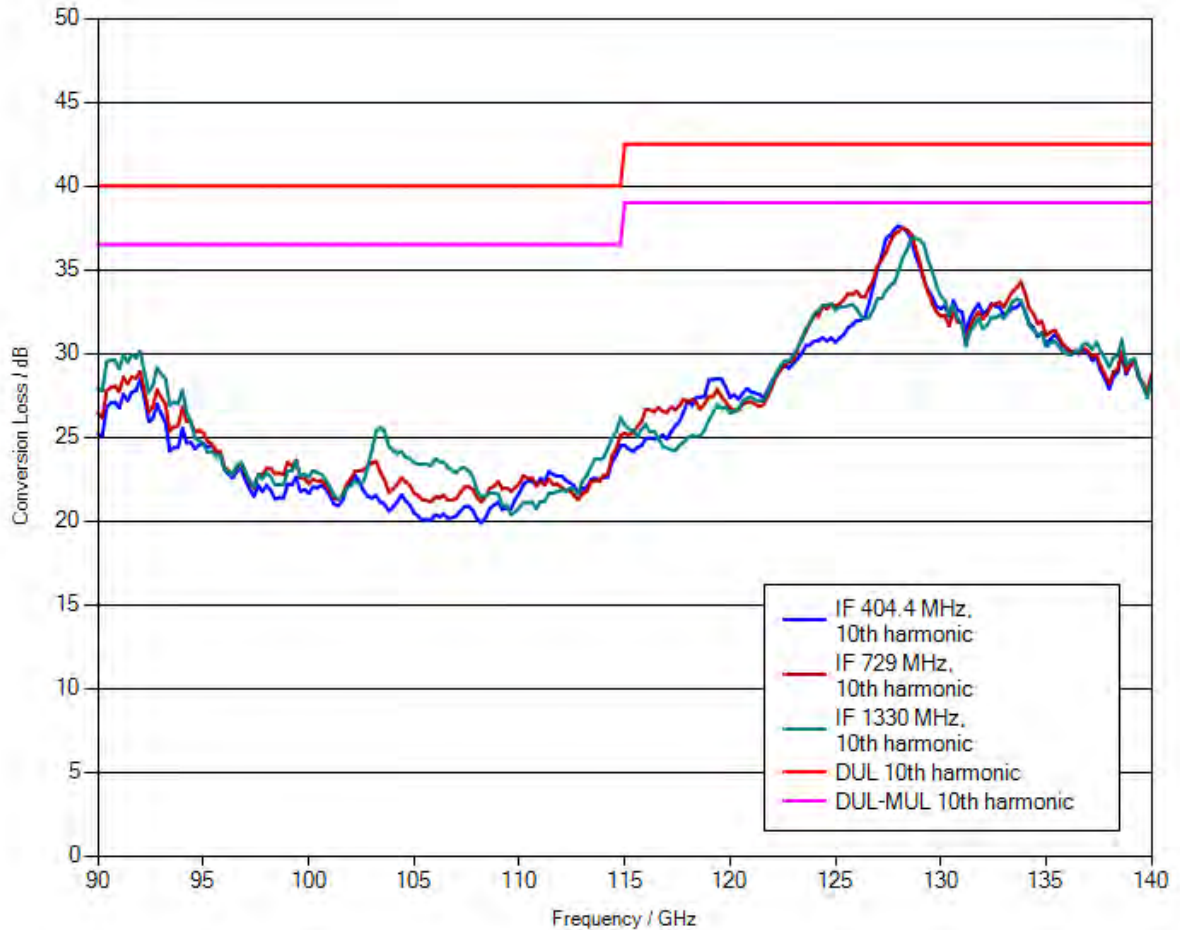

Note: Numeric calibration data can be found attached to the PDF file of the calibration certificate. Click the “paper clip” symbol to display the file.

The file has been renamed for safety reasons.

When downloading the file onto your PC, please delete the “.file” extension and unzip the data.

1.3 Frequency response within 1 GHz

	DUL	Actual (worst case)	Evaluation
IF = 404.4 MHz, 10th harmonic	6 dB	3.86 dB	PASS
IF = 729 MHz, 10th harmonic	6 dB	3.48 dB	PASS
IF = 1330 MHz, 10th harmonic	6 dB	3.19 dB	PASS

Calibration Method
Kalibrieranweisung

RPG-PAQA-TN-2014-002

Relative Humidity 20 % - 80 %
Relative Luftfeuchte

Ambient Temperature
Umgebungstemperatur

(23 ⁺⁷/₋₃) °C

Working standards used (having a significant effect on the accuracy) Verwendete Gebrauchsnormale (mit signifikantem Einfluss auf die Genauigkeit)				
Item Gegenstand	Type Typ	Serial Number Seriennummer	Calibration Certificate Number Kalibrierscheinnummer	Cal. Due Kalibr. bis
Vector Network Analyzer	R&S® ZVA67	101097	20-300432406	2020-07-21
Powersensor	R&S® NRP-Z55	140093	20-300426315	2018-05-17

UGB1 A compliance statement may be possible where a confidence level of less than 95 % is acceptable.
Die Bestätigung der Konformität ist möglich, sofern ein Grad des Vertrauens von weniger als 95 % akzeptabel ist.

UGB2 A non-compliance statement may be possible where a confidence level of less than 95 % is acceptable.
Die Bestätigung der Nicht-Konformität ist möglich, sofern ein Grad des Vertrauens von weniger als 95 % akzeptabel ist.

Ref.: ILAC-G8:03/2009 'Guidelines on the Reporting of Compliance with Specification'.

Notes

Anmerkungen

If the new product is stored under the climate conditions as specified in the data sheet upon delivery, the product's accuracy is not significantly affected within 12 month after its calibration in our factory. In this case, the recommended calibration interval starts on the date when the product is actually put into operation.

Outgoing Results

The following abbreviations may be used in this document

{a}	No measurement uncertainty stated because the errors always add together. So it is sure that a measurement result evaluated as "PASS" is pass.
{b}	The measurement uncertainty depends on the measurement result. The stated measurement uncertainty is valid for the close area around the specification. Measurement results outside the close area have a higher measurement uncertainty but are within the specification.
{c}	Functional test, therefore no measurement uncertainty is stated.
{d}	Typical value, refer to performance test.
{e}	The measurement uncertainty is taken into account when setting the measuring system.
DL or DT	Data Limit for symmetrical tolerance limits
DLL	Datasheet Lower Limit
DUL	Datasheet Upper Limit
MU	Measurement Uncertainty
MLL or MLV	Measurement Uncertainty Lower Value
MUL or MUV	Measurement Uncertainty Upper Value
Nom.	Nominal Value
Dev.	Deviation
MErr.	Measurement Error
Act.	Actual Value
UGB	Uncertainty Guard Band: Measuring uncertainty violates the data (spec.) limit.
UGB1	Measurement results marked as UGB1 show conformity with a probability of >50 % and <95 %.
UGB2	Measurement results marked as UGB2 show non-conformity with a probability of >50 % and <95 %.
DU	Datasheet Uncertainty

Explanation of charts

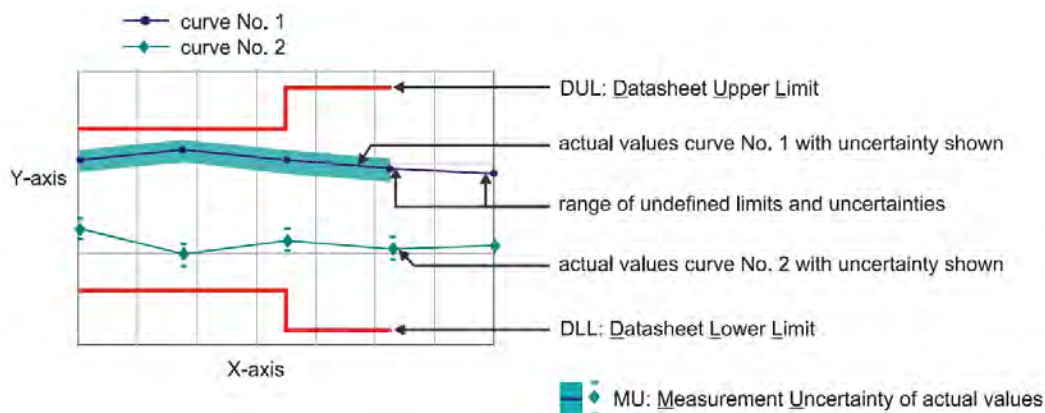

Software used for measurement

Item Type

Measurement Studio Professional Edition
MixerCertification

Version

2013
7_08

Remark

1.1 RF Input – VSWR

Measurement uncertainty: 0.05 (VSWR)

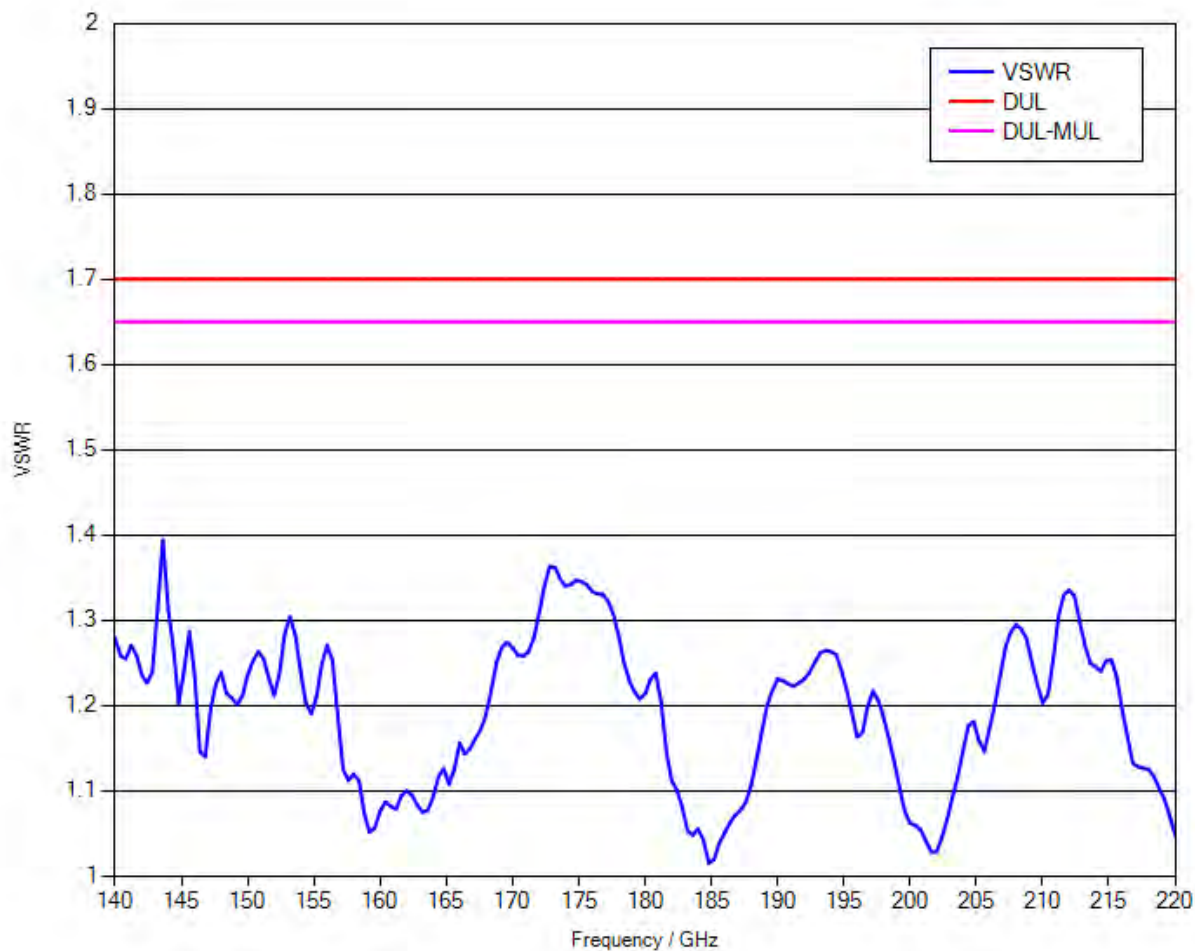

1.2 Conversion loss

LO level +13 dBm nominal
 Bias 0 A

Measurement uncertainty: 4 dB

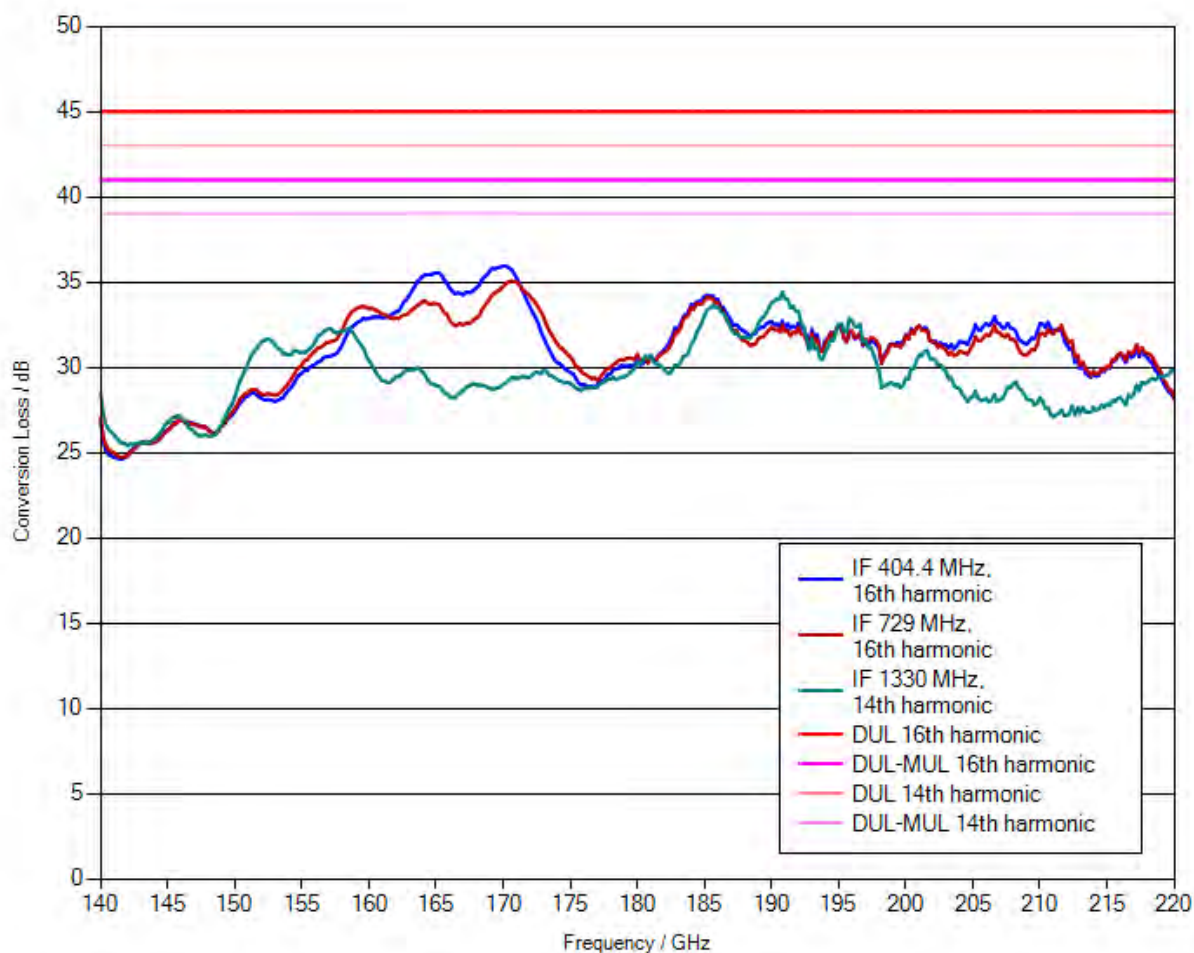

Note: Numeric calibration data can be found attached to the PDF file of the calibration certificate. Click the “paper clip” symbol to display the file.

The file has been renamed for safety reasons.
When downloading the file onto your PC, please delete the “.file” extension and unzip the data.

1.3 Frequency response within 1 GHz

	DUL	Actual (worst case)	Evaluation
IF = 404.4 MHz, 16th harmonic	6 dB	2.1 dB	PASS
IF = 729 MHz, 16th harmonic	6 dB	2.05 dB	PASS
IF = 1330 MHz, 14th harmonic	6 dB	2.48 dB	PASS